

A TEXT-BOOK OF
**PRACTICAL ORGANIC
CHEMISTRY**

INCLUDING
QUALITATIVE ORGANIC ANALYSIS

By
ARTHUR I. VOGEL, D.Sc.(Lond.),D.I.C.,F.R.I.C.

Formerly Head of Chemistry Department, Woolwich Polytechnic ;
Sometime Beit Scientific Research Fellow of the Imperial College, London

With diagrams and 8 photographs

THIRD EDITION

LONGMAN

LONGMAN GROUP LIMITED
London
*Associated companies, branches and representatives
throughout the world*

*First published 1948
New impression with minor
corrections, October 1948*

*Second Edition 1951
New impression with addition of
Chapter XII on Semimicro Technique
1954*

*Third Edition, 1956
New impression with corrections and
additions 1957
New impressions 1959, 1961, 1962, 1964,
1965, 1967, 1970, 1972, and 1974*

ISBN 0 582 44245 1

PRINTED IN GREAT BRITAIN BY
LOWE AND BRYDONE (PRINTERS) LTD
THETFORD, NORFOLK

PREFACE TO THIRD EDITION

THE favourable reception accorded to previous editions by reviewers, students and practising organic chemists has encouraged the author to undertake an exhaustive revision of the entire text in the light of the numerous developments in practical organic chemistry since the book was first written (1945-46). The net result has been an increase in the length of the volume by some 150 pages, a figure which gives some indication of the new matter incorporated in the present edition.

It is impossible within the limitations of a short preface to give a detailed list of the numerous changes and additions. Some of the more important new preparations include :

1. *Chapter III.* 1-Heptene (III,10); alkyl iodides (KI-H₃PO₄ method) (III,38); alkyl fluorides (KF-ethylene glycol method) (III,41); keten (nichrome wire method) (III,90); ion exchange resin catalyst method for esters (III,102); acetamide (urea method) (III,107); ethyl α -bromopropionate (III,126); acetoacetic ester condensation using sodium triphenylmethide (III,151).

2. *Chapter IV.* α -Chloromethylnaphthalene (IV,23); benzylamine (Gabriel synthesis) (IV,39); *NN*-dialkylanilines (from amines and trialkyl orthophosphates) (IV,42); α -naphthaldehyde (Sommelet reaction) (IV,120); α -phenylcinnamic acid (Perkin reaction using triethylamine) (IV,124); β -nitrostyrene (IV,129); β -bromonaphthalene and β -naphthoic acid (from 2-naphthylamine-1-sulphonic acid) (IV,62 and IV,164); diphenic acid (from phenanthrene) (IV,165).

3. *Chapter V.* Quinaldine (V,2); 2-methyl-, 2:5-dimethyl- and 2-acetylthiophene (V,8-V,10); 2:5-dimethyl- and 2:4-dimethyl-dicarbethoxy-pyrrole (V,12-V,13); 2-amino- and 2:4-dimethyl-thiazole (V,15-V,16); 3:5-dimethylpyrazole (V,17); 4-ethylpyridine (from pyridine) (V,19); *n*-amyl-pyridines from picolines (V,28); picolinic, nicotinic and isonicotinic acid (V,21-V,22); (ethyl nicotinate and β -cyanopyridine (V,23-V,24); uramil (V,25); 4-methyl-(coumarin (V,28); 2-hydroxylepidine (V,29).

4. *Chapter VI.* Reductions with potassium borohydride (VI,11); Oppenauer oxidation (VI,13); epoxidation and hydroxylation of ethylenic compounds (VI,15); Arndt-Eistert reaction (VI,17); Darzens glycidic ester condensation (VI,18); Erlenmeyer azlactone reaction (VI,19); Mannich reaction (VI,20); Michael reaction (VI,21); Schmidt reaction (VI,23); Stobbe condensation (VI,24); Willgerodt reaction (VI,25); unsymmetrical diaryls (VI,27); syntheses with organolithium compounds (VI,28); syntheses with organosodium compounds (VI,29); syntheses with organocadmium compounds (VI,30); some electrolytic syntheses (VI,31); chromatographic adsorption (VI,33); ring enlargement with diazomethane (VI,34).

5. *Chapters VII-IX.* Diazomethane (*p*-tolylsulphonylmethylnitrosamide method) (VII,20); Girard's reagents "T" and "P" (VII,25); pseudo-saccharin chloride (VII,26); 2:2'-dipyridyl (VIII,13); ninhydrin (VIII,14); 3-indoleacetic acid (IX,14).

A new feature is the account of the electronic mechanisms (in outline) of the numerous reactions described in the text. Although some of these mechanisms may be modified in the near future, it is hoped that the brief treatment scattered throughout the volume will stimulate the student's interest in this important branch of organic chemistry. It will be noted that many reactions are designated by name; this may be undesirable on pedagogical grounds but, in most cases, established usage and the example set by the various volumes of *Organic Reactions* (J. Wiley) may be put forward in justification.

Chapter XII is concerned with Semimicro Technique. There can be little doubt that preparations on a smaller scale than has hitherto been customary have many advantages; particular reference may be made to cost, time and bench space, all of which are important factors in teaching laboratories and also in training for research. Once the student has mastered the special technique, no difficulty should be experienced in adapting most of the preparations described in the book to the semi-micro scale. A few examples of small-scale preparations are included together with a suggested list of experiments for an elementary course.

Section A,7, "Applications of infrared and ultraviolet absorption spectra to organic chemistry," should provide a brief introduction to the subject.

It is regretted that the size of the volume has rendered the insertion of literature references impossible: the Selected Bibliography (A,5) may partly compensate for this omission. Section numbers are now included in the headings of the pages—a feature introduced in response to requests by many readers. The volume comprises virtually at least three books under one cover, *viz.*, experimental technique, preparations, and qualitative organic analysis. It should therefore continue to be of value as a one-volume reference work in the laboratory. Students at all levels will find their requirements for laboratory work (excluding quantitative organic analysis) adequately provided for and, furthermore, the writer hopes that the book will be used as a source of information to supplement their theoretical studies.

The author wishes to thank Dr. G. H. Jeffery, C. T. Cresswell, B.Sc., C. M. Ellis, M.Sc., Dr. J. Leicester and C. Kyte, B.Sc., for assistance with the proof reading and for helpful suggestions; Dr. G. H. Jeffery for invaluable assistance in numerous ways; and C. Kyte, B.Sc., and R. Grezskowiak, B.Sc., for a number of original preparations and also for checking and improving many of the new experimental procedures.

Criticisms and also suggestions for improving the book are welcomed.

ARTHUR I. VOGEL.

Woolwich Polytechnic, London, S.E. 18.

September 1955.

PREFACE TO FIRST EDITION

THE present volume is an attempt to give to students of practical organic chemistry the benefit of some twenty years' experience in research and teaching of the subject. The real foundations of the author's knowledge of the subject were laid in 1925–1929 when, as a research student at the Imperial College under the late Professor J. F. Thorpe, F.R.S., he was introduced to the methods and experimental technique employed in a large and flourishing school of research in organic chemistry. Since that period the author and his students have been engaged *inter alia* in researches on *Physical Properties and Chemical Constitution* (published in the *Journal of the Chemical Society*) and this has involved the preparation of over a thousand pure compounds of very varied type. Many of

the new procedures and much of the specialised technique developed and employed in these researches are incorporated in this book. Furthermore, new experiments for the elementary student have emanated from these researches; these have been tried out with large classes of undergraduate students over several sessions with gratifying success and have now been included in the present text-book.

In compiling this book, the author has drawn freely from all sources of information available to him—research notes, original memoirs in scientific journals, reference works on organic chemistry, the numerous text-books on practical organic chemistry, and pamphlets of manufacturers of specialised apparatus. Whilst individual acknowledgement cannot obviously be made—in many cases the original source has been lost track of—it is a duty and a pleasure to place on record the debt the writer owes to all these sources. Mention must, however, be made of *Organic Syntheses*, to which the reader is referred for further details of many of the preparations described in the text.

The book opens with a chapter on the theory underlying the technique of the chief operations of practical organic chemistry: it is considered that a proper understanding of these operations cannot be achieved without a knowledge of the appropriate theoretical principles. Chapter II is devoted to a detailed discussion of experimental technique; the inclusion of this subject in one chapter leads to economy of space, particularly in the description of advanced preparations. It is not expected that the student will employ even the major proportion of the operations described, but a knowledge of their existence is thought desirable for the advanced student so that he may apply them when occasion demands.

Chapters III and IV are confined to the preparation and properties of Aliphatic Compounds and Aromatic Compounds respectively. This division, although perhaps artificial, falls into line with the treatment in many of the existing theoretical text-books and also with the author's own lecture courses. A short theoretical introduction precedes the detailed preparations of the various classes of organic compounds: it is recommended that these be read concurrently with the student's lecture course and, it is hoped, that with such reading the subject will become alive and possess real meaning. The partition of the chapters in this manner provides the opportunity of introducing the reactions and the methods of characterisation of the various classes of organic compounds: the foundations of qualitative organic analysis are thus laid gradually, but many teachers may prefer to postpone the study of this subject until a representative number of elementary preparations has been carried out by the student. The division into sections will facilitate the introduction of any scheme of instruction which the teacher considers desirable.

Chapters V–X deal respectively with Heterocyclic and Alicyclic Compounds; Miscellaneous Reactions; Organic Reagents in Inorganic and Organic Chemistry; Dyestuffs, Indicators and Related Compounds; Some Physiologically-Active Compounds; and Synthetic Polymers. Many of these preparations are of course intended for advanced students, but a mere perusal of the experimental details of selected preparations by those whose time for experimental work is limited may assist to impress them on the memory. Attention is particularly directed to the chapter

upon Organic Reagents in Inorganic and Organic Chemistry. It is always a good plan to set advanced students or adequately-trained laboratory assistants on the preparation of those compounds which are required in the laboratory for organic and inorganic analysis; the resulting cost is comparatively low (for *o*-phenanthroline, for example, it is less than one-tenth of the commercial price) and will serve to promote the use of these, otherwise relatively expensive, organic reagents in the laboratory.

Chapter XI is devoted to Qualitative Organic Analysis. The subject is discussed in moderate detail and this, coupled with the various Sections and Tables of Physical Constants of Organic Compounds and their Derivatives in Chapters III and IV, will provide a satisfactory course of study in this important branch of chemistry. No attempt has been made to deal with Quantitative Organic Analysis in this volume.

The text-book is intended to meet the requirements of the student of chemistry throughout the whole of his training. Considerable detail is given in those sections of particular interest to the elementary student; in the author's opinion it is the duty of a writer of a practical text-book to lay a secure foundation of sound experimental technique for the beginner. The subject matter of the book is sufficiently comprehensive to permit the teacher to cover any reasonable course of instruction. It will be observed that the scale of the preparations varies considerably; the instructor can easily adapt the preparation to a smaller scale when such a step is necessary from considerations of cost and time or for other reasons. Quantities of liquid reagents are generally expressed as weights and volumes: the latter refer to a temperature of 20°. The book will be suitable for students preparing for the Pass and Honours (General and Special) B.Sc. of the Universities, the A.R.I.C. and the F.R.I.C. (Organic Chemistry). It will also provide an introduction to research methods in organic chemistry and, it is hoped, may serve as an intermediate reference book for practising organic chemists.

Attention is directed to the numerous references, particularly in Chapter II on Experimental Technique, to firms supplying specialised apparatus. The author has usually had first-hand experience with this apparatus and he feels that some readers may wish to know the present source of supply and also from whom to obtain additional information. It must be mentioned that most of the specialised apparatus has been introduced to the market for the first time by the respective firms after much development research and exhaustive tests in their laboratories. A reference to such a firm is, in the writer's opinion, equivalent to an original literature reference or to a book. During the last decade or two much development work has been carried out in the laboratories of the manufacturers of chemical apparatus (and also of industrial chemicals) and some acknowledgement of the great help rendered to practical organic chemists by these industrial organisations is long overdue; it is certainly no exaggeration to state that they have materially assisted the advancement of the science. A short list of the various firms is given on the next page.

ARTHUR I. VOGEL.

CONTENTS

CHAPTER I

THEORY OF GENERAL TECHNIQUE

THEORY OF DISTILLATION

	PAGE
I,1. Vapour pressure	1
I,2. Calculation of the boiling point at selected pressures	2
I,3. Superheating and bumping	3
I,4. Fractional distillation	5
I,5. The breaking up of azeotropic mixtures	12
I,6. Steam distillation. Distillation of a pair of immiscible liquids	12
I,7. Distillation with superheated steam	15

SOLUTIONS OF LIQUIDS IN LIQUIDS

I,8. Partially miscible liquids. Critical solution temperature	17
I,9. Influence of added substances upon the critical solution temperature	20

THEORY OF MELTING AND FREEZING

I,10. Melting point and vapour pressure	21
I,11. Effect of impurities upon the melting point	23
I,12. System in which the solid phases consist of the pure components and the components are completely miscible in the liquid phase	24
I,13. Construction of equilibrium diagrams	26
I,14. System in which the two components form a compound possessing a congruent melting point	29
I,15. System in which the two components form a compound with an incongruent melting point	31
I,16. System in which the two components form a continuous series of solid solutions	32
I,17. Mixed melting points	34
I,18. System in which the solid phases consist of the pure components and the components are only partially miscible in the liquid state	35
I,19. Theory of sublimation	37
I,20. Theory of the action of drying agents	39
I,21. Deliquescence and efflorescence	43
I,22. Extraction with solvents	44

CHAPTER II

EXPERIMENTAL TECHNIQUE

II,1. Common laboratory apparatus	46
II,2. Cleaning and drying of glassware	53
II,3. Use of cork and rubber stoppers	55
II,4. Cutting and bending of glass tubing	57
II,5. Heating baths	57
II,6. Cooling baths	60

	PAGE
II,7.	Mechanical agitation 62
II,8.	Gas absorption traps 71
II,9.	Calibration of thermometers 72
II,10.	Experimental determination of the melting point 75
II,11.	Miscellaneous forms of melting point apparatus 80
II,12.	Experimental determination of the boiling point 83
II,13.	Typical assemblies of apparatus for distillation and refluxing 86
II,14.	Fire hazards attending the distillation of inflammable solvents 90
II,15.	Fractional distillation. Distillation with a fractionating column 91
II,16.	Simple apparatus for fractionation 93
II,17.	Improved apparatus for fractional distillation 94
II,18.	Still heads for fractionating columns 102
II,19.	Distillation under diminished pressure (" vacuum " distillation) 103
II,20.	Fractional distillation under diminished pressure 108
II,21.	Water pumps 110
II,22.	Oil pumps 110
II,23.	Manometers and manostats 112
II,24.	Refinements in the technique of distillation under diminished pressure 116
II,25.	Precision fractional distillation under diminished pressure 119
II,26.	Molecular distillation 120
II,27.	Purification of solid organic compounds by crystallisation. (General considerations 122
II,28.	Experimental details for recrystallisation 125
II,29.	Preparation of a fluted filter paper 127
II,30.	Removal of traces of colouring matter and resinous products. Use of decolourising carbon 127
II,31.	Difficulties encountered in recrystallisation 129
II,32.	Filtration with suction 130
II,33.	Drying of the recrystallised material 132
II,34.	Filtration of small quantities of material with suction 133
II,35.	Miscellaneous apparatus for filtration with suction 133
II,36.	Recrystallisation in an atmosphere of inert gas 135
II,37.	Evaporation of the solvent 135
II,38.	Drying of solid organic compounds 136
II,39.	Drying of liquids or of solutions of organic compounds in organic solvents 139
II,40.	Technique of steam distillation 145
II,41.	Modifications of the steam distillation apparatus 146
II,42.	Technique of extraction with solvents 149
II,43.	Extraction by chemically active solvents 151
II,44.	Continuous extraction of liquids or solids by solvents 152
II,45.	Technique of sublimation 154
II,46.	Chromatographic adsorption 156
II,47.	Purification of the common organic solvents 163
II,48.	Inorganic reagents—gases 179
II,49.	Inorganic reagents—liquids 186
II,50.	Inorganic reagents—solids 190
II,51.	Calculation of yields 201
II,52.	General instructions for work in the laboratory 204
II,53.	Safety precautions 205

APPARATUS WITH INTERCHANGEABLE GROUND GLASS JOINTS

II,54.	Interchangeable ground glass joints 206
II,55.	Types of ground glass joints 210
II,56.	Apparatus with interchangeable ground glass joints suitable for general use in preparative organic chemistry 212
II,57.	Electric heating mantles (for use in fractional distillation, etc.) 221

	PAGE
II,58. Apparatus for the continuous extraction of solids or liquids by solvents	222
II,59. Lubrication of ground glass joints	225
II,60. Typical assemblies	226

CHAPTER III

PREPARATION AND REACTIONS OF ALIPHATIC COMPOUNDS

PRELIMINARY LABORATORY OPERATIONS

III,1. Determination of melting points	229
III,2. Mixed melting points	229
III,3. Determination of boiling points	230
III,4. Fractional distillation	231
III,5. Purification of solid organic compounds by recrystallisation	232

SATURATED ALIPHATIC HYDROCARBONS

III,6. Reactions and characterisation of saturated aliphatic hydrocarbons	234
III,7. <i>n</i> -Octane (<i>Wurtz reaction</i>)	236
III,8. <i>n</i> -Hexane (<i>hydrocarbon from Grignard reagent</i>)	237
III,9. <i>n</i> -Octane (<i>Clemmensen reduction of a ketone</i>)	238

ETHYLENIC HYDROCARBONS (ALKENES)

III,10. Amylene	239
III,11. Reactions and characterisation of ethylenic hydrocarbons	241
III,12. <i>cyclo</i> Hexene	243

ACETYLENIC HYDROCARBONS (ALKYNES)

III,13. Acetylene	245
-----------------------------	-----

ALIPHATIC ALCOHOLS 247

III,14. <i>n</i> -Amyl alcohol (<i>from ethyl n-valerate</i>)	249
III,15. Tetramethylene glycol (1 : 4-butanediol)	250
III,16. <i>n</i> -Heptyl alcohol (<i>from n-heptaldehyde</i>)	251
III,17. <i>cyclo</i> Hexylcarbinol (<i>from cyclohexyl chloride</i>)	252
III,18. <i>n</i> -Hexyl alcohol (<i>from n-butyl bromide</i>)	253
III,19. <i>n</i> -Nonyl alcohol (<i>from n-heptyl bromide</i>)	254
III,20. Methyl <i>n</i> -amyl carbinol (<i>from methyl n-amyl ketone</i>)	254
III,21. Methyl <i>n</i> -butyl carbinol (<i>from methyl n-butyl ketone</i>)	255
III,22. Methyl <i>iso</i> -propyl carbinol	255
III,23. Di- <i>n</i> -butyl carbinol (<i>from n-butyl bromide</i>)	256
III,24. Dimethyl <i>n</i> -butyl carbinol	257
III,25. Triethyl carbinol	258
III,26. Dimethyl <i>n</i> -propyl carbinol	259
III,27. Reactions and characterisation of aliphatic alcohols	260

ALKYL HALIDES 270

III,28. <i>n</i> -Butyl chloride (<i>ZnCl₂ - HCl method</i>)	272
III,29. <i>sec.</i> -Butyl chloride (<i>ZnCl₂ - HCl method</i>)	273
III,30. <i>iso</i> -Butyl chloride (<i>SOCl₂ - Pyridine method</i>)	274
III,31. <i>n</i> -Hexyl chloride (<i>SOCl₂ method</i>)	274

	PAGE
III,32. <i>cyclo</i> Hexyl chloride (<i>HCl</i> - CaCl_2 method)	275
III,33. <i>tert.</i> -Butyl chloride (<i>HCl</i> method)	276
III,34. <i>iso</i> Propyl bromide (<i>HBr</i> method)	277
III,35. <i>n</i> -Butyl bromide (<i>HBr</i> - H_2SO_4 method)	277
III,36. <i>n</i> -Butyl bromide (<i>KBr</i> - H_2SO_4 method)	280
III,37. <i>n</i> -Butyl bromide (<i>red P</i> - Br_2 method)	281
III,38. 1 : 4-Diodobutane (<i>KI</i> - H_3PO_4 method)	284
III,39. <i>iso</i> Propyl iodide (<i>HI</i> method)	285
III,40. <i>n</i> -Butyl iodide (<i>red P</i> and I_2 method)	285
III,41. <i>n</i> -Hexyl fluoride	288
III,42. Reactions and characterisation of alkyl halides	289

POLYHALOGEN COMPOUNDS

297

III,43. Chloroform	297
III,44. Bromoform	299
III,45. Iodoform	299
III,46. Methylene bromide	300
III,47. Methylene iodide	300
III,48. 1 : 2 : 3-Tribromopropane	301

ESTERS OF INORGANIC ACIDS

302

III,49. <i>n</i> -Butyl sulphite	303
III,50. <i>n</i> -Butyl phosphate	304
III,51. <i>n</i> -Butyl borate	304
III,52. <i>n</i> -Propyl thiocyanate	305
III,53. <i>n</i> -Amyl nitrite	306
III,54. 1-Nitro- <i>n</i> -butane (<i>AgNO</i> ₂ method)	307
III,55. Nitromethane	307

ALIPHATIC ETHERS

309

III,56. Diethyl ether	310
III,57. Di- <i>n</i> -butyl ether	311
III,58. Ethyl <i>n</i> -hexyl ether	313
III,59. <i>cyclo</i> Hexyl ethyl ether	314
III,60. Reactions and characterisation of aliphatic ethers	315

ALIPHATIC ALDEHYDES

318

III,61. <i>n</i> -Butyraldehyde	320
III,62. <i>n</i> -Hexaldehyde (<i>catalyst</i> method)	321
III,63. <i>n</i> -Hexaldehyde (<i>ethyl orthoformate</i> method)	323
III,64. <i>n</i> -Hexaldehyde (<i>from n</i> - <i>amyl cyanide</i>)	324
III,65. Acetaldehyde (<i>from paraldehyde</i>)	324
III,66. Formaldehyde	325
III,67. Hexamethylenetetramine (hexamine)	326
III,68. Acetal (acetaldehyde diethylacetal)	327
III,69. Reactions and characterisation of acetals	327
III,70. Reactions and characterisation of aliphatic aldehydes	330

ALIPHATIC KETONES

335

III,71. Methyl <i>n</i> -hexyl ketone	336
III,72. Diethyl ketone	338
III,73. <i>cyclo</i> Pentanone	340
III,74. Reactions and characterisation of aliphatic ketones	341
III,75. Acetone cyanohydrin	348

	PAGE
III,76. <i>n</i> -Heptaldoxime	348
III,77. Pinacol and pinacolone	349
III,78. Diacetone alcohol	351
III,79. Mesityl oxide	353

SATURATED ALIPHATIC MONOBASIC ACIDS 354

III,80. <i>iso</i> -Butyric acid	355
III,81. <i>n</i> -Heptoic acid	356
III,82. <i>n</i> -Butyl <i>n</i> -butyrate	357
III,83. <i>n</i> -Valeric acid (<i>hydrolysis of n-butyl cyanide</i>)	357
III,84. <i>dl</i> -Methylethylacetic acid (<i>carbonation of a Grignard reagent</i>)	358
III,85. Reactions and characterisation of aliphatic carboxylic acids	360

ACID CHLORIDES OF ALIPHATIC CARBOXYLIC ACIDS 367

III,86. Acetyl chloride	367
III,87. <i>n</i> -Butyryl chloride	368
III,88. Reactions and characterisation of acid chlorides of aliphatic acids	369

ACID ANHYDRIDES OF ALIPHATIC CARBOXYLIC ACIDS 371

III,89. Acetic anhydride	372
III,90. Keten	372
III,91. <i>n</i> -Caproic anhydride	374
III,92. Succinic anhydride	375
III,93. Maleic anhydride	376
III,94. Reactions and characterisation of acid anhydrides (aliphatic)	376

ALIPHATIC ESTERS 379

III,95. <i>n</i> -Butyl acetate	382
III,96. <i>tert.</i> -Butyl acetate	383
III,97. <i>n</i> -Butyl formate	384
III,98. <i>cyclo</i> Hexyl acetate	385
III,99. Diethyl adipate (<i>azeotropic mixture method</i>)	385
III,100. Diethyl adipate (<i>benzene method</i>)	386
III,101. <i>n</i> -Propyl <i>n</i> -valerate	387
III,102. <i>iso</i> -Propyl lactate (<i>ion exchange resin catalyst method</i>)	387
III,103. Diethyl maleate (<i>silver salt method</i>)	388
III,104. Ethyl <i>n</i> -valerate (<i>from n-butyl cyanide</i>)	389
III,105. Ethyl vinylacetate (<i>acid chloride method</i>)	389
III,106. Reactions and characterisation of aliphatic esters	390

ALIPHATIC AMIDES 401

III,107. Acetamide (<i>from ammonium acetate or from acetic acid</i>)	401
III,108. Acetamide (<i>from ethyl acetate</i>)	403
III,109. <i>n</i> -Caproamide	404
III,110. Reactions and characterisation of aliphatic amides	404

ALIPHATIC CYANIDES (NITRILES) 407

III,111. Acetonitrile	407
III,112. <i>n</i> -Amyl cyanide (<i>n</i> -capronitrile)	408
III,113. <i>n</i> -Butyl cyanide (<i>n</i> -valeronitrile)	408
III,114. Trimethylene dicyanide (<i>glutaronitrile</i>)	409
III,115. Reactions and characterisation of aliphatic cyanides (nitriles)	410

	PAGE
ALIPHATIC AMINES	
III,116. Methylamine hydrochloride (<i>from acetamide</i>)	414
III,117. Methylamine hydrochloride (<i>from formalin</i>)	415
III,118. Dimethylamine hydrochloride	416
III,119. Trimethylamine hydrochloride	416
III,120. <i>n</i> -Amylamine	417
III,121. <i>n</i> -Heptylamine	418
III,122. Di- <i>n</i> -butylamine	419
III,123. Reactions and characterisation of aliphatic amines	420
III,124. N-Nitrosodimethylamine (dimethylnitrosamine)	426
SUBSTITUTED ALIPHATIC MONOBASIC ACIDS	
III,125. Monochloroacetic acid	428
III,126. Monobromoacetic acid and ethyl bromoacetate	429
III,127. Dichloroacetic acid	431
III,128. Trichloroacetic acid	431
III,129. Glycine (aminoacetic acid)	432
III,130. α -Amino- <i>n</i> -caproic acid (norleucine)	432
III,131. Ethyl cyanoacetate	433
III,132. Reactions and characterisation of amino acids	435
III,133. Urea	441
III,134. Thiourea (thiocarbamide)	442
POLYHYDRIC ALCOHOLS, FATS AND SOAPS	
III,135. Saponification of a fat. Soap	445
III,136. Reactions and characterisation of polyhydric alcohols	446
CARBOHYDRATES	
III,137. α - and β -Glucose penta-acetate	451
III,138. Mucic acid	452
III,139. Reactions and characterisation of carbohydrates	453
Photographs of osazones	<i>to face</i> 455
UNSATURATED ALIPHATIC COMPOUNDS	
III,140. Allyl alcohol	459
III,141. Crotonaldehyde	460
III,142. $\beta\beta$ -Dimethylacrylic acid	460
III,143. Maleic and fumaric acids	461
III,144. Crotonic acid and vinylacetic acid	463
III,145. Sorbic acid	466
III,146. Diallyl (hexadiene-1,5)	466
III,147. 2 : 3-Dimethyl-1 : 3-butadiene	467
III,148. Dimethylethynyl carbinol	467
III,149. 10-Undecynoic acid	468
III,150. Catalytic reduction with Adams' platinum oxide catalyst	470
ETHYL ACETOACETATE	
III,151. Ethyl acetoacetate	477
III,152. Ethyl <i>n</i> -propylacetoacetate and methyl <i>n</i> -butyl ketone	481
DIETHYL MALONATE	
III,153. Diethyl malonate	484
III,154. Ethyl <i>n</i> -butylmalonate	485
III,155. <i>n</i> -Caproic acid (<i>from ethyl n-butylmalonate</i>)	486
III,156. <i>n</i> -Propylmalonic acid	488

	PAGE
SOME ALIPHATIC DICARBOXYLIC ACIDS	
III,157. Malonic acid	490
III,158. Glutaric acid (<i>from trimethylene dicyanide</i>)	491
III,159. Pimelic acid (<i>from benzoyl piperidine</i>)	492
III,160. Glutaric acid (<i>from cyclopentanone</i>)	493
III,161. Adipic acid	494
III,162. <i>as</i> -Dimethylsuccinic acid	495
ALIPHATIC SULPHUR COMPOUNDS	
III,163. <i>n</i> -Hexyl mercaptan (<i>n</i> -hexyl thiol)	497
III,164. Di- <i>n</i> -propyl sulphide	497
III,165. Diethyl disulphide	498
III,166. Potassium ethyl xanthate	499
III,167. Ethyl S-ethyl xanthate	499
III,168. Reactions and characterisation of mercaptans (thiols)	500
RESOLUTION OF A RACEMIC COMPOUND	
III,169. Determination of the rotatory power	503
III,170. Resolution of <i>sec</i> -octyl alcohol (<i>dl</i> -2-octanol) into its optically active components (<i>d</i> - and <i>l</i> -2-octanol)	505
CHAPTER IV	
PREPARATION AND REACTIONS OF AROMATIC COMPOUNDS	
AROMATIC HYDROCARBONS	
IV,1. <i>n</i> -Butylbenzene (<i>Wurtz - Fittig synthesis</i>)	511
IV,2. <i>iso</i> -Propylbenzene (cumene)	512
IV,3. <i>tert</i> -Butylbenzene	513
IV,4. Diphenylmethane	513
IV,5. Triphenylmethane	515
IV,6. Ethylbenzene	515
IV,7. <i>n</i> -Propylbenzene	516
IV,8. <i>n</i> -Amylbenzene	517
IV,9. Characterisation of aromatic hydrocarbons	518
NITRATION OF AROMATIC HYDROCARBONS	
IV,10. Nitrobenzene	525
IV,11. α -Nitronaphthalene	526
IV,12. <i>m</i> -Dinitrobenzene	526
IV,13. 2 : 4-Dinitrotoluene	527
IV,14. <i>p</i> -Bromonitrobenzene	527
IV,15. 2 : 2'-Dinitrodiphenyl	527
IV,16A. Reactions and characterisation of aromatic nitro compounds	528
IV,16B. Reactions and characterisation of aliphatic nitro compounds	531
HALOGENATION OF AROMATIC HYDROCARBONS	
IV,17. Chlorobenzene	535
IV,18. Bromobenzene	535
IV,19. <i>m</i> -Bromonitrobenzene	537

	PAGE
IV,20. α -Bromonaphthalene	537
IV,21. Iodobenzene	538
IV,22. Benzyl chloride (<i>chlorination of toluene</i>)	538
IV,23. Benzyl chloride (<i>chloromethylation of benzene</i>)	539
IV,24. Iodobenzene dichloride	541
IV,25. Iodosobenzene	541
IV,26. Iodoxybenzene	542
IV,27. Diphenyliodonium iodide	542
IV,28. Reactions and characterisation of halogenated aromatic hydrocarbons	542
SULPHONATION OF AROMATIC HYDROCARBONS	
IV,29. Sodium benzenesulphonate	549
IV,30. Sodium <i>p</i> -toluenesulphonate	550
IV,31. Sodium β -naphthalenesulphonate	551
IV,32. <i>p</i> -Toluenesulphonic acid	552
IV,33. Reactions and characterisation of aromatic sulphonic acids	552
IV,33A. Reactions and characterisation of aromatic sulphonamides	558
AROMATIC AMINES AND THEIR SIMPLE DERIVATIVES	
IV,34. Aniline	563
IV,35. β -Phenylethylamine	566
IV,36. α -Phenylethylamine	567
IV,37. α -Naphthylamine	568
IV,38. β -Naphthylamine	568
IV,39. Benzylamine (<i>Gabriel synthesis</i>)	569
IV,40. Pure methylaniline from commercial methylaniline	570
IV,41. Benzylaniline	572
IV,42. Dimethylaniline	572
IV,43. <i>p</i> -Nitrosodimethylaniline	573
IV,44. <i>m</i> -Nitroaniline	574
ACETYLTATION OF AROMATIC AMINES	
IV,45. Acetanilide	577
IV,46. Diacetyl- <i>o</i> -toluidine	578
IV,47. 2 : 4 : 6-Tribromoacetanilide	579
IV,48. <i>p</i> -Bromoacetanilide	580
IV,49. <i>p</i> -Bromoaniline	580
IV,50. <i>p</i> -Nitroacetanilide	581
IV,51. <i>p</i> -Nitroaniline	581
BENZOYLATION OF AROMATIC AMINES	
IV,52. Benzanilide (<i>Schotten - Baumann reaction</i>)	582
IV,53. Benzanilide	583
IV,54. Hippuric acid (benzoyl glycine)	584
SULPHONATION OF AROMATIC AMINES	
IV,55. Sulphanilic acid	586
IV,56. Naphthionic acid	586
IV,57. Orthanilic acid	587
IV,58. Metanilic acid	589

DIAZONIUM SALTS

590

IV,59.	Solid phenyldiazonium chloride	597
IV,60.	Iodobenzene	598
IV,61.	<i>p</i> -Chlorotoluene	600
IV,62.	<i>p</i> -Bromotoluene (<i>Sandmeyer reaction</i>)	602
IV,63.	<i>m</i> -Bromotoluene	605
IV,64.	<i>o</i> -Bromotoluene (<i>Gattermann reaction</i>)	606
IV,65.	Benzenesulphinic acid	607
IV,66.	<i>p</i> -Tolunitrile (<i>p</i> -tolyl cyanide)	607
IV,67.	Fluorobenzene	609
IV,68.	<i>o</i> -Dinitrobenzene	612
IV,69.	Phenol (<i>from aniline</i>)	613
IV,70.	<i>m</i> -Nitrophenol	614
IV,71.	Toluene (<i>from p-toluidine</i>)	615
IV,72.	<i>sym.</i> -Tribromobenzene	615
IV,73.	3 : 3'-Dimethyldiphenyl	616
IV,74.	Diphenic acid (<i>from anthranilic acid</i>)	617
IV,75.	Phenylarsonic acid	617

SOME AZO DYESTUFFS

620

IV,76.	Phenyl-azo- β -naphthol	622
IV,77.	Chrysoidine	623
IV,78.	Methyl orange	624
IV,79.	Orange II (β -naphthol orange)	625
IV,80.	Methyl red	625
IV,81.	Diazoaminobenzene	626
IV,82.	<i>p</i> -Amino-azobenzene	627

INTERMEDIATE PRODUCTS IN THE REDUCTION OF
NITRO COMPOUNDS

628

IV,83.	β -Phenylhydroxylamine	629
IV,84.	Nitrosobenzene	630
IV,85.	Azoxybenzene	631
IV,86.	Azobenzene	631
IV,87.	Hydrazobenzene (<i>sym.</i> -diphenylhydrazine)	632
IV,88.	Benzidine	633

REDUCTION OF DIAZONIUM COMPOUNDS. ARYL HYDRAZINES

635

IV,89.	Phenylhydrazine	636
IV,90.	<i>p</i> -Nitrophenylhydrazine	637
IV,91.	2 : 4-Dinitrophenylhydrazine	638

AROMATIC DIAMINES

640

IV,92.	<i>o</i> -Phenylenediamine	640
IV,93.	<i>m</i> -Phenylenediamine	641

MISCELLANEOUS COMPOUNDS DERIVED FROM
PRIMARY AMINES

IV,94.	Thiocarbanilide (<i>sym.</i> -diphenylthiourea)	642
IV,95.	Phenyl <i>iso</i> -thiocyanate (<i>from thiocarbanilide</i>)	642
IV,96.	Phenyl <i>iso</i> -thiocyanate (<i>from aniline</i>)	643
IV,97.	Phenylurea (<i>cyanate method</i>)	644
IV,98.	Phenylurea (<i>urea method</i>)	645
IV,99.	<i>p</i> -Iodoaniline	647
IV,100.	Reactions and characterisation of aromatic amines	648

PHENOLS

664

IV,101.	<i>p</i> -Cresol	667
IV,102.	β -Naphthol	668
IV,103.	Phenyl acetate.	669
IV,104.	Anisole	669
IV,105.	Phenyl <i>n</i> -butyl ether	671
IV,106.	Reactions and characterisation of aromatic ethers	671
IV,107.	<i>o</i> -Propiophenol and <i>p</i> -propiophenol	676
IV,108.	<i>o</i> - and <i>p</i> -nitrophenols	677
IV,109.	2 : 4-Dinitrophenol	678
IV,110.	Picric acid (2 : 4 : 6-trinitrophenol)	678
IV,111.	<i>p</i> -Bromophenol	679
IV,112.	<i>o</i> -Bromophenol	679
IV,113.	<i>p</i> -Iodophenol	680
IV,114.	Reactions and characterisation of phenols	681

AROMATIC ALDEHYDES

689

IV,115.	Benzaldehyde	693
IV,116.	<i>p</i> -Bromobenzaldehyde	694
IV,117.	<i>p</i> -Nitrobenzaldehyde	695
IV,118.	<i>p</i> -Tolualdehyde	697
IV,119.	β -Naphthaldehyde	698
IV,120.	α -Naphthaldehyde (<i>Sommelet reaction</i>)	700
IV,121.	Mesitaldehyde	701
IV,122.	Salicylaldehyde	703

CONDENSATION REACTIONS OF AROMATIC ALDEHYDES

706

IV,123.	Benzyl alcohol and benzoic acid (<i>Cannizzaro reaction</i>)	711
IV,124.	Cinnamic acid	712
IV,125.	Benzoin	714
IV,126.	Benzil	714
IV,127.	Benzilic acid	715
IV,128.	Benzalacetone	716
IV,129.	β -Nitrostyrene	717
IV,130.	Benzalacetophenone (chalcone)	718
IV,131.	Ethyl cinnamate	718
IV,132.	β -Piperonylacrylic acid (3 : 4-methylenedioxybenzoic acid)	719
IV,133.	α - and β -Benzaldoximes	719
IV,134.	Hydrobenzamide	720
IV,135.	Reactions and characterisation of aromatic aldehydes	720

AROMATIC KETONES

725

IV,136.	Acetophenone	729
IV,137.	Butyrophenone	732
IV,138.	<i>p</i> -Bromoacetophenone	732
IV,139.	Benzophenone	733
IV,140.	Benzylacetophenone	734
IV,141.	Methyl benzyl ketone	734
IV,142.	Phloroacetophenone	736
IV,143.	α -Tetralone	737
IV,144.	<i>o</i> -Benzoylbenzoic acid	739
IV,145.	Anthraquinone	740
IV,146.	Anthrone	740
IV,147.	Benzophenone oxime and Beckmann rearrangement	741
IV,148.	Reactions and characterisation of aromatic ketones	741

	PAGE
QUINONES	
IV,149. <i>p</i> -Benzoquinone ("quinone")	745
IV,150. 1 : 2-Naphthoquinone	746
IV,151. Quinhydrone	747
IV,152. Reactions and characterisation of quinones	747
AROMATIC CARBOXYLIC ACIDS	
IV,153. Benzoic acid	755
IV,154. <i>p</i> -Nitrobenzoic acid	757
IV,155. 2 : 4 : 6-Trinitrobenzoic acid	758
IV,156. 2 : 4-Dinitrophenylacetic acid	758
IV,157. <i>o</i> -Chlorobenzoic acid	758
IV,158. Terephthalic acid	760
IV,159. <i>o</i> -Toluic acid	760
IV,160. Phenylacetic acid (<i>from benzyl cyanide</i>)	761
IV,161. <i>p</i> -Nitrophenylacetic acid	763
IV,162. <i>p</i> -Aminophenylacetic acid	764
IV,163. α -Naphthoic acid	764
IV,164. β -Naphthoic acid	766
IV,165. Diphenic acid (<i>from phenanthrene</i>)	768
IV,166. Hydrocinnamic acid	768
IV,167. <i>m</i> -Nitrobenzoic acid	769
IV,168. 3 : 5-Dinitrobenzoic acid	770
IV,169. Homophthalic acid	771
IV,170. Anthranilic acid	773
IV,171. Diphenylacetic acid	773
IV,172. Mandelic acid	774
IV,173. Salicylic acid	774
IV,174. Phenylpropionic acid	776
IV,175. Reactions and characterisation of aromatic carboxylic acids	777
AROMATIC ESTERS	
IV,176. Methyl benzoate	781
IV,177. Methyl salicylate	782
IV,178. Benzyl acetate	783
IV,179. Ethyl phenylacetate	783
IV,180. Phenyl cinnamate	784
IV,181. Phenyl benzoate	784
IV,182. Ethyl α -naphthoate	785
IV,183. Reactions and characterisation of aromatic esters	785
AROMATIC ACID CHLORIDES	
IV,184. <i>p</i> -Nitrobenzoyl chloride	791
IV,185. Benzoyl chloride	792
AROMATIC ACID ANHYDRIDES	
IV,186. <i>p</i> -Chlorobenzoic anhydride	794
IV,187. Reactions and characterisation of acid chlorides of aromatic acids	795
AROMATIC ACID AMIDES	
IV,188. Benzamide	797
IV,189. Mercury benzamide	797
IV,190. <i>o</i> -Toluamide	798
IV,191. Reactions and characterisation of primary aromatic amides	798
IV,192. Reactions and characterisation of substituted aromatic amides (aromatic acylated bases)	801

	PAGE
AROMATIC NITRILES	
IV,193. Benzonitrile	803
IV,194. Veratronitrile	804
IV,195. Reactions and characterisation of aromatic nitriles	805
SOME AROMATIC PEROXIDES AND PER-ACIDS	
IV,196. Benzoyl peroxide	807
IV,197. <i>p</i> -Nitrobenzoyl peroxide	808
IV,198. Perbenzoic acid (benzoyl hydrogen peroxide)	808
IV,199. Monoperphthalic acid	810
AROMATIC ALCOHOLS	
IV,200. <i>p</i> -Tolyl carbinol (<i>p</i> -methyl benzyl alcohol)	812
IV,201. Benzhydrol (diphenylcarbinol)	812
IV,202. Triphenylcarbinol	813
IV,203. Triphenylchloromethane	815
IV,204. β -Phenylethyl alcohol	816
IV,205. Reactions and characterisation of aromatic alcohols	817
COMPOUNDS DERIVED FROM AROMATIC SULPHONIC ACIDS	
IV,206. Benzenesulphonyl chloride	822
IV,207. <i>p</i> -Toluenesulphonyl chloride	822
IV,208. Dichloramine-T and chloramine-T	823
IV,209. Saccharin	824
IV,210. <i>n</i> -Butyl <i>p</i> -toluenesulphonate	825
IV,211. Sodium <i>p</i> -toluenesulphinat	826
IV,212. Thiophenol	827
CHAPTER V	
SOME HETEROCYCLIC AND ALCYCLIC COMPOUNDS	
V,1. Quinoline	829
V,2. Quinaldine	831
V,3. Furfuryl alcohol and furoic acid	832
V,4. 2-Furfuralacetone	833
V,5. Furylacrylic acid	834
V,6. Furoin	835
V,7. Furil	835
V,8. 2-Methylthiophene	836
V,9. 2 : 5-Dimethylthiophene	836
V,10. 2-Acetylthiophene	837
V,11. Pyrrole	837
V,12. 2 : 5-Dimethylpyrrole	838
V,13. 2 : 4-Dimethyl-3 : 5-dicarbethoxypyrrole	839
V,14. Succinimide	840
V,15. 2-Aminothiazole	840
V,16. 2 : 4-Dimethylthiazole	841
V,17. 2 : 5-Dimethylpyrazole	842
V,18. 5 : 5-Dimethylhydantoin	843
V,19. 4-Ethylpyridine (<i>from pyridine</i>)	844

	PAGE
V,20. <i>n</i> -Amylpyridines (from picolines)	845
V,21. Picolinic acid	847
V,22. Nicotinic acid	848
V,23. Ethyl nicotinate	849
V,24. β -Cyanopyridine	850
V,25. Uramil	850
V,26. 2-Phenylindole	851
V,27. Benzimidazole	853
V,28. 4-Methylcoumarin	853
V,29. 2-Hydroxylepidine (4-methylcarbostyryl)	855
V,30. Phenylbenzoyldiazomethane	856
V,31. 2-Carbethoxycyclopentanone	856
V,32. <i>cyclo</i> Butane-1 : 1-dicarboxylic acid and <i>cyclo</i> butanecarboxylic acid	857
V,33. <i>cyclo</i> Propanecarboxylic acid	859

CHAPTER VI

MISCELLANEOUS REACTIONS

VI,1. Acetylacetone	861
VI,2. Benzoylacetone	865
VI,3. Phenylglyoxal	866
VI,4. Apparatus for reactions under pressure	866
VI,5. Raney nickel (catalyst)	870
VI,6. Copper - chromium oxide catalyst	872
VI,7. Hexamethylene glycol (1 : 6-Hexanediol)	873
VI,8. Ethyl β -phenyl- β -hydroxypropionate	874
VI,9. $\beta\beta$ -Dimethylglutaric acid	876
VI,10. Reductions with lithium aluminium hydride	877
VI,11. Reductions with potassium (or sodium) borohydride	881
VI,12. Reductions with aluminium alkoxides	882
VI,13. The Oppenauer oxidation	886
VI,14. Oxidation of unsaturated compounds with ozonized oxygen (ozonolysis)	888
VI,15. Epoxidation and hydroxylation of ethylenic compounds	893
VI,16. Reactions in liquid ammonia. Some acetylenic compounds	895
VI,17. The Arndt-Eistert reaction	902
VI,18. The Darzens glycidic ester condensation	906
VI,19. The Erlenmeyer azlactone reaction	907
VI,20. The Mannich reaction	910
VI,21. The Michael reaction	912
VI,22. Cyanoethylation	914
VI,23. The Schmidt reaction or rearrangement	917
VI,24. The Stobbe condensation	919
VI,25. The Willgerodt reaction	923
VI,26. The Wohl-Ziegler reaction. Applications of <i>N</i> -bromosuccinimide	926
VI,27. Synthesis of unsymmetrical diaryls	927
VI,28. Syntheses with organolithium compounds	928
VI,29. Syntheses with organosodium compounds	933
VI,30. Syntheses with organocadmium compounds	935
VI,31. Some electrolytic syntheses	937
VI,32. The diene synthesis (Diels-Alder reaction)	941
VI,33. Some applications of chromatographic adsorption	944
VI,34. Ring enlargement with diazomethane. <i>cyclo</i> Heptanone from <i>cyclo</i> hexanone	946
VI,35. Dehydrogenation of hydroaromatic compounds	947
VI,36. Preparation of palladium catalysts for hydrogenation	949
VI,37. Oxidation with lead tetra-acetate. <i>n</i> -Butyl glyoxylate	951

CHAPTER VII

ORGANIC REAGENTS IN INORGANIC AND ORGANIC CHEMISTRY

	PAGE
VII,1. Dimethylglyoxime	953
VII,2. Semicarbazide hydrochloride	954
VII,3. Diphenylcarbazide	954
VII,4. Diphenylcarbazone	955
VII,5. Dithizone (diphenylthiocarbazone)	955
VII,6. Cupferron	957
VII,7. Salicylaldoxime	957
VII,8. α -Benzoinoxime	958
VII,9. α -Nitroso- β -naphthol	958
VII,10. Ammonium salt of aurin tricarboxylic acid ("aluminon")	959
VII,11. <i>p</i> -Nitrobenzene-azo- α -naphthol	960
VII,12. <i>p</i> -Bromophenacyl bromide	960
VII,13. <i>p</i> -Nitrobenzyl bromide	961
VII,14. <i>p</i> -Phenylphenacyl bromide	962
VII,15. 5 : 5-Dimethyl-1 : 3- <i>cyclohexanedione</i> (dimethyldihydro-resorcinol)	963
VII,16. Xanthhydrol	964
VII,17. 1 : 3 : 5-Trinitrobenzene	965
VII,18. <i>S</i> -Benzyl- <i>iso</i> -thiuronium chloride	965
VII,19. 3-Nitrophthalic anhydride	966
VII,20. Diazomethane	967
VII,21. 3 : 4 : 5-Triiodobenzoyl chloride	973
VII,22. 3 : 5-Dinitrobenzoyl chloride	974
VII,23. 1 : 2- <i>cyclohexanedione</i> -dioxime (nioxime)	974
VII,24. Quinaldinic acid	975
VII,25. Girard's reagents "T" and "P"	976
VII,26. Pseudo-saccharin chloride	978

CHAPTER VIII

DYESTUFFS, INDICATORS AND RELATED COMPOUNDS

VIII,1. Congo red	979
VIII,2. Indigo	980
VIII,3. Alizarin	981
VIII,4. Crystal violet	982
VIII,5. Copper phthalocyanine (Monastral Blue)	983
VIII,6. Phenolphthalein	984
VIII,7. Fluorescein and eosin	985
VIII,8. <i>pp</i> -Tetramethyldiaminodiphenylmethane	987
VIII,9. <i>o</i> -Sulphobenzoic anhydride	987
VIII,10. Sulphonaphthaleins	989
VIII,11. <i>N</i> -Phenylantranilic acid	991
VIII,12. 1 : 10-Phenanthroline	991
VIII,13. 2 : 2'-Dipyridyl	992
VIII,14. Ninhydrin (indane-1 : 2 : 3-trione hydrate)	993

CHAPTER IX

SOME PHYSIOLOGICALLY ACTIVE COMPOUNDS

IX,1. Aspirin (acetylsalicylic acid)	996
IX,2. Phenacetin	996
IX,3. Antipyrine	998
IX,4. Bromural (α -bromo- <i>iso</i> -valerylurea)	999
IX,5. Benzocaine (ethyl <i>p</i> -aminobenzoate)	1000
IX,6. Barbituric acid	1001

	PAGE	
IX,7.	Diethylbarbituric acid (veronal)	1002
IX,8.	Phenylethylbarbituric acid (phenobarbitone)	1003
IX,9.	<i>p</i> -Aminobenzenesulphonamide (sulphanilamide)	1005
IX,10.	2-(<i>p</i> -Aminobenzenesulphonamido) pyridine (sulphapyridine)	1007
IX,11.	Sulphaguanidine	1009
IX,12.	2-Phenylquinoline-4-carboxylic acid (atophan)	1010
IX,13.	2 : 2- <i>bis</i> (<i>p</i> -Chlorophenyl)-1 : 1 : 1-trichloroethane (D.D.T.)	1011
IX,14.	3-Indoleacetic acid	1012

CHAPTER X

SYNTHETIC POLYMERS

X,1.	Brief introduction to subject	1014
X,2.	Phenol-formaldehyde resin	1022
X,3.	Depolymerisation of methyl methacrylate resin	1023
X,4.	Formation of a glyptal resin	1023
X,5.	Thiokol A (polyethylene polysulphide)	1024
X,6.	Phenylethylene (styrene)	1024
X,7.	Polystyrene	1025
X,8.	Ethylenediamine · adipic acid polymer	1025
X,9.	Depolymerisation of a hexamethylenediamine · adipic acid polymer (Nylon "66")	1025

CHAPTER XI

QUALITATIVE ORGANIC ANALYSIS

XI,1.	Basis of qualitative organic analysis	1026
XI,2.	Determination of physical constants	1028
XI,3.	Qualitative analysis for the elements	1038
XI,4.	The solubilities of organic compounds	1045
XI,5.	The solubility groups	1050
XI,6.	Determination of the solubilities of organic compounds (<i>for group tests</i>)	1055
XI,7.	Class reactions (reactions for functional groups)	1057
XI,8.	The preparation of derivatives	1081
XI,9.	Qualitative analysis of mixtures of organic compounds	1090

CHAPTER XII

SEMIMICRO TECHNIQUE

XII,1.	Introduction and general considerations	1101
XII,2.	Some typical operations on the semimicro scale	1102
XII,3.	Semimicro apparatus with interchangeable ground glass joints	1109
XII,4.	Small-scale preparations	1110

APPENDIX

LITERATURE OF ORGANIC CHEMISTRY

A,1.	Beilstein's "Handbuch"	1115
A,2.	Original sources of chemical information	1127
A,3.	Secondary sources of chemical information. Abstracting journals	1127
A,4.	Locating an organic compound	1128
A,5.	Selected reference works on organic chemistry	1128
A,6.	Laboratory accidents and first aid	1130
A,7.	Applications of infrared and ultraviolet spectra to organic chemistry	1134
A,8.	Densities and percentage compositions of various solutions	1151
A,9.	Density and vapour pressure of water : 0° to 35° C.	1162
A,10.	Atomic weights	1163

NAME INDEX OF ORGANIC REACTIONS†

	PAGE
Acetoacetic ester condensation	475, 476*, 477-481
Arndt-Eistert reaction	902, 903, 904* 905, 906
Bart reaction	597, 617, 618
Beckmann rearrangement	729, 741
Benzidine rearrangement	629*, 633
Benzilic acid rearrangement	709*, 715, 716
Benzoin reaction (condensation)	708*, 714
Blanc chloromethylation reaction	534, 539, 540
Bouveault-Blanc reduction	247, 249, 250, 812, 816
Bucherer hydantoin synthesis	843*, 844
Bucherer reaction	561*, 568, 569
Cannizzaro reaction	706*, 711, 712, 811, 812, 832
Claisen aldol condensation	710*, 718
Claisen condensation	477, 861*, 862*, 863-865
Claisen-Schmidt reaction	709, 710*, 716-718
Clemmensen reduction	238, 510, 515, 516, 728, 738
Darzens glycidic ester condensation	906* 907
Diazoamino-aminoazo rearrangement	622*, 626, 627
Dieckmann reaction	856, 857
Diels-Alder reaction	941, 942*, 943
Doebner reaction	463, 465, 710, 711*, 719
Erlenmeyer azlactone synthesis	907, 908*, 909, 910
Fischer indole synthesis	851*, 852
Fischer-Speier esterification	379*, 380*, 382-383, <i>et seq.</i>
Friedel-Crafts reaction	508, 509*, 512, 513, 515, 725, 726*, 728, 729-734, 811, 815
Fries reaction	664*, 665*, 676, 677, 727
Gabriel synthesis	559, 560*, 566
Gattermann aldehyde reaction	689, 690*, 701-703
Gattermann reaction	593, 609
Gattermann-Koch reaction	689*, 697, 698
Gomberg-Hey reaction	927, 928*
Grignard reaction	237, 240, 247, 248* 249*, 253, 255-259, 358-359, 394, 511, 516-517, 752, 756-757, 765, 781, 811, 813-815
Guareschi reaction	876*, 877
Haworth reaction	726, 728*, 737, 738
Hell-Volhard-Zelinsky reaction	427*, 429, 430
Hoesch reaction	727*, 736, 737
Hofmann reaction	413*, 414, 754, 773
Knoevenagel reaction	490, 710, 711*, 719
Knorr pyrrole synthesis	839*, 840
Kolbe-Schmitt reaction	754, 755*, 774-776
Leuckart reaction	561, 567
Mannich reaction	910, 911*, 912, 1012, 1013
Meerwein-Ponndorf-Verley reduction	882*, 883-836
Michael reaction	912, 913*, 914
Oppenauer oxidation	886, 887*, 888

† A number of rearrangements and also the acetoacetic ester condensation are included in the Name Index for the convenience of the reader. Other reactions (including ring enlargement with diazomethane) for which mechanisms are given will be found in the Index. The asterisk indicates the page where the mechanism (in outline) is described.

	PAGE
Pechmann reaction	853*, 854, 855
Perkin reaction	706, 707*, 708, 712-713
Pinacol-pinacolone rearrangement	349*, 350, 351
Priesschajew epoxidation reaction	893*, 894
Reformatsky reaction	874*, 875, 876
Reimer-Tiemann reaction	691, 692*, 703-705
Rosenmund reduction	691, 699
Sandmeyer reaction	591, 592*, 594, 600-603, 751
Schiemann reaction	594*, 595, 609-612, 618
Schmidt reaction or rearrangement	917, 918*, 919
Schotten-Baumann reaction	582, 584, 780, 784
Skraup reaction	828*, 829, 830, 991, 992
Sommelet reaction	692, 693*, 700, 701
Stephen reaction	318*, 324, 691, 698
Stobbe condensation	919, 920*, 922, 923
Ullmann reaction	524, 527
Willgerodt reaction	923, 924*, 925
Williamson synthesis	309, 665, 670, 671
Wohl-Ziegler reaction	926, 927
Wolff rearrangement	903, 904*, 905, 906
Wolff-Kishner reduction	510, 511*, 516
Wurtz reaction	236, 237
Wurtz-Fittig reaction	508*, 511, 512

CHAPTER I
THEORY OF GENERAL TECHNIQUE
THEORY OF DISTILLATION

.,1. **Vapour pressure.** If a liquid is admitted into a closed vacuous space, it will evaporate or give off vapour until the latter attains a definite pressure, which depends only upon the temperature. The vapour is then said to be **saturated**. Experiment shows that at a given temperature

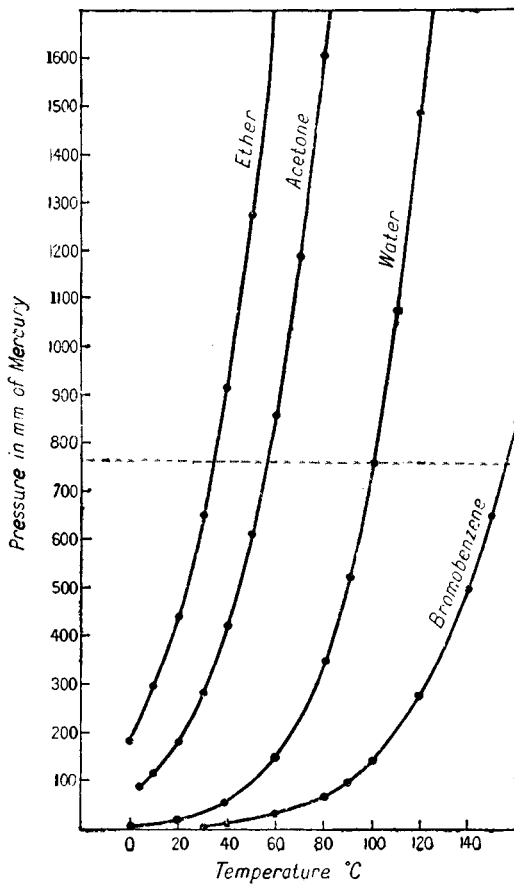

Fig. I, I, 1.

the vapour pressure of a liquid substance in contact with its own liquid is a constant quantity and is independent of the absolute amount of liquid and of vapour present in the system. The vapour pressure is usually

expressed in terms of the height of a mercury column which will produce an equivalent pressure.

The vapour pressure of a liquid increases with rising temperature. A few typical vapour pressure curves are collected in Fig. I, 1, 1. When the vapour pressure becomes equal to the *total* pressure exerted on the surface of a liquid, the liquid boils, *i.e.*, the liquid is vaporised by bubbles formed *within* the liquid. When the vapour pressure of the liquid is the same as the external pressure to which the liquid is subjected, the temperature does not, as a rule, rise further. If the supply of heat is increased, the rate at which bubbles are formed is increased and the heat of vaporisation is absorbed. The boiling point of a liquid may be defined as the temperature at which the vapour pressure of the liquid is equal to the external pressure exerted at any point upon the liquid surface. This external pressure may be exerted by atmospheric air, by other gases, by vapour and air, etc. The boiling point at a pressure of 760 mm. of mercury, or one standard atmosphere, may be termed the normal boiling point.

If the pressure on the surface is reduced, say by connecting the vessel containing the liquid with a pump, the boiling point is lowered; the exact value may be obtained by reference to a vapour pressure curve (see, for example, Fig. I, 1, 1). It is therefore necessary to specify the pressure in recording a boiling point: unless this is done, 760 mm. is understood. Advantage is taken of the lower boiling point under diminished pressure in the distillation of substances which decompose upon heating to the boiling point under atmospheric pressure; thus, ethyl acetoacetate, which boils with decomposition at 180° under 760 mm. pressure, boils without decomposition at 78° under 18 mm. pressure (usually written as 78°/18 mm.).

1.2. Calculation of the boiling point at selected pressures. One sometimes requires the boiling point of a liquid at a pressure which is not recorded in the literature. This can best be calculated from the vapour pressure-temperature curve. For most practical purposes this may be assumed to have the form:

$$\log p = A + \frac{B}{T}$$

where p is the vapour pressure, T is the temperature on the absolute scale, and A and B are constants. If $\log p$ is plotted as ordinates against $\frac{1}{T}$ as abscissae, a straight line is obtained. Two values of p with the corresponding values of T suffice. Values of p corresponding to any absolute temperature or *vice versa* can be obtained from the graph. A few typical $\log p - \frac{1}{T}$ diagrams, using the data from which Fig. I, 1, 1 was constructed, are shown in Fig. I, 2, 1; it will be seen that they approximate to straight lines.

For distillations conducted at atmospheric pressure, the barometric pressures are rarely exactly 760 mm. and deviations may be as high as 20 mm. To correct the observed boiling point to normal pressure (760 mm.), the following approximate expression may be used:

$$\Delta t = 0.0012 (760 - p) (t + 273),$$

where Δt is the correction in degrees Centigrade to be applied to the

observed boiling point t , and p is the barometric pressure. For water, alcohols, acids and other associated liquids, it is better to use the expression :

$$\Delta t = 0.0010 (760 - p) (t + 273).$$

I.3. Superheating and bumping. If a liquid is heated in a flask by means of a Bunsen burner and wire gauze placed below it, the formation of bubbles of vapour at the lower surface of the liquid in contact with the heated glass is facilitated by the presence of air dissolved in the liquid or adhering as a film to the glass and by roughness on the surface of the

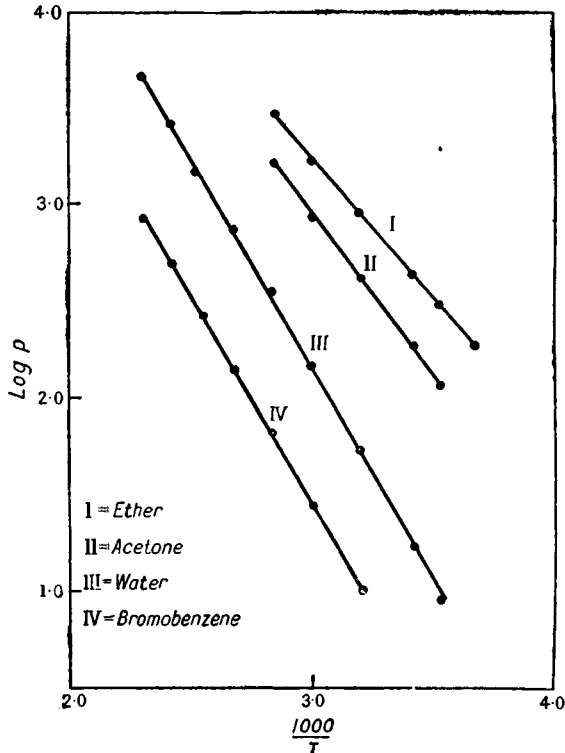

Fig. I, 2, 1.

glass. If a minute bubble of air is formed (this will be at atmospheric pressure), it will serve as a nucleus for a larger bubble of vapour. At the boiling point the liquid (at 760 mm. vapour pressure itself) will deliver vapour in relatively large quantity to the air bubble. With the heat supply at hand, the total pressure inside the bubble soon rises above that of the atmosphere and is sufficient to overcome the pressure due to the column of liquid; a vapour bubble is then expelled. Hence, if a source of minute air bubbles or other nuclei is available in the liquid, boiling will proceed quietly. If, however, the liquid is largely free from air and if the walls of the flask are clean and very smooth, bubbles are formed with greater difficulty and the temperature of the liquid may rise appreciably above the boiling point; it is then said to be superheated. When a

bubble does eventually form, the vapour pressure corresponding to the temperature of the liquid far exceeds the sum of the pressures of the atmosphere and of the column of liquid, hence vapour is evolved, the bubble increases in size rapidly and at the same time the temperature of the liquid falls slightly. These experimental conditions lead to irregular ebullition and the liquid is said to **bump**.

Various methods are available for preventing, or at least considerably reducing, bumping in a liquid. An obvious method is to surround the flask containing the liquid by a bath charged with a suitable fluid, the temperature of which is not allowed to rise more than 20° above the boiling point of the liquid. Bubbles of vapour may now rise from points around the edge of the liquid and not only from the bottom of the flask. Furthermore, the danger of superheating is considerably reduced.

The procedure most frequently employed to prevent bumping of a liquid during distillation under atmospheric pressure is to add a few fragments of unglazed porous porcelain (often termed "porous pot," "boiling stones" or "boiling chips"—the term "porous pot" will be used frequently in this book).* These emit small quantities of air and promote regular ebullition. It must be emphasised that the "porous pot" is added to the cold liquid before distillation is commenced. Under no circumstances should "porous pot" be dropped into a liquid which has already been heated to boiling: the sudden evolution of vapour may result in spray and sometimes of a large proportion of the liquid being ejected from the mouth of the flask. If the distillation has been interrupted, it is recommended that two or three small fragments of fresh "porous pot" be added before the heating is resumed; the "porous pot" initially added, from which the air has been partially removed by heating, will probably be largely ineffective owing to their absorption of the liquid on cooling.

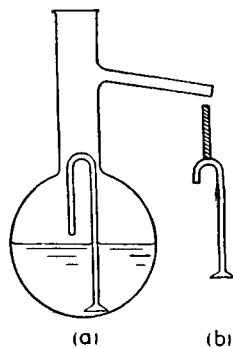

Fig. 1, 3, 1.

A useful device to prevent bumping of liquids during distillation consists of a glass tube, 2–3 mm. in diameter, bent in a U-form with one arm somewhat shorter than the other; it should be long enough to extend from the bottom of the flask for a short distance into the neck in order that it should remain in an upright position (Fig. 1, 3, 1, a). If for any reason a shorter U-tube is desired, a glass rod may be sealed on as in Fig. 1, 3, 1, b. The short arm of the U-tube should be just above the level of the liquid in the flask, whilst the long arm should rest on the bottom of the flask just above the source of heat. With a large flask it is advantageous to employ two or three U-tubes, the short arm of one

should be just above the fluid level at the start of the distillation; the short arms of the other U-tubes should be of different lengths and below the initial level of the liquid.

* The action of this and other anti-bumping devices (e.g., minute carborundum chips) is dependent upon the fact that the transformation of a superheated liquid into the vapour will take place immediately if a vapour phase (e.g., any inert gas) is introduced. The effect may be compared with that produced by the introduction of a small quantity of a solid phase into a supercooled liquid, e.g., of ice into supercooled water.

Other aids for promoting regular boiling include the addition of the following:—fragments of pumice stone or of carborundum; small strips of Teflon (a tetrafluoroethylene polymer) tape, ca. $\frac{3}{4}$ " wide, or of shredded Teflon (the strip may be washed with an organic solvent, dried and re-used); small pieces of platinum wire (use is made of the well-known property of platinum in absorbing large quantities of gases); sufficient glass wool to fill the flask and to rise 4–5 mm. above the surface of the liquid; long capillary tubes sealed at a point about 0.5 mm. from the end (the short capillary end is immersed in the liquid, thus filling the small cavity with air, which is evolved in fine bubbles when the liquid is heated).

The boiling point of a pure liquid, if properly determined, has a definite and constant value at constant pressure, say, that of the atmosphere. The boiling point of an impure liquid will depend to a large extent on the physical nature of the impurities. If all the impurities are non-volatile, the liquid will have a constant boiling point and the impurities will remain behind when the liquid has been distilled. If, however, the impurities are themselves volatile, the boiling point may rise gradually as the liquid distils or it may remain constant at a particular stage of the distillation due to the formation of a constant boiling point mixture of two or more substances. The separation of liquids by distillation forms the subject of the next Section.

I.4. Fractional distillation. The aim of distillation is the separation of a volatile liquid from a non-volatile substance or, more usually, the separation of two or more liquids of different boiling point. The latter is usually termed fractional distillation. The theoretical treatment of fractional distillation requires a knowledge of the relation between the boiling points, or vapour pressures, of mixtures of the substances and their composition; if these curves are known, it is possible to predict whether the separation is difficult or easy or, indeed, whether it will be possible.

At the outset it will be profitable to deal with an ideal solution possessing the following properties: (i) there is no heat effect when the components are mixed; (ii) there is no change in volume when the solution is formed from its components; (iii) the vapour pressure of each component is equal to the vapour pressure of the pure substances multiplied by its mol fraction * in the solution. The last-named property is merely an expression of Raoult's law, *viz.*, the vapour pressure of a substance is proportional to the number of mols of the substance present in unit volume of the solution, applied to liquid-liquid systems. Thus we may write:

$$p_A = Kx_A \quad (1),$$

where p_A is the vapour pressure of the substance and x_A is its mol fraction in the solution. If $x_A = 1$, *i.e.*, we are dealing with the pure substance A, then $p_A = K = p_A'$, the vapour pressure of the pure substance at the given temperature. Substituting this value in equation (1), we have:

$$p_A = p_A' x_A \quad (2),$$

i.e., the vapour pressure of a component of a solution at a given temperature is equal to the vapour pressure of the pure substance multiplied by its mol fraction in the solution. This is another form of Raoult's law.

* The mol fraction of any constituent in a mixture is defined as the number of mols, or gram molecules, of that constituent divided by the total number of mols, or gram molecules, in the mixture.

Let us consider a mixture forming an ideal solution, that is, an ideal liquid pair. Applying Raoult's law to the two volatile components A and B, we have :

$$p_A = p_A' x_A \quad \text{and} \quad p_B = p_B' x_B \quad (3).$$

The total pressure p will be :

$$p = p_A + p_B = p_A' x_A + p_B' x_B.$$

The vapour pressures are proportional to the mol fractions in the vapour phase, hence the composition of this phase will be given by :

$$x_A^* = \frac{p_A}{p_A + p_B} \quad \text{and} \quad x_B^* = \frac{p_B}{p_A + p_B}$$

The relative concentrations of either constituent, say B, in the vapour and liquid phases will be :

$$\begin{aligned} \frac{x_B^*}{x_B} &= \frac{p_B}{p_A + p_B} \cdot \frac{p_B'}{p_B} \\ &= \frac{1}{x_B + \frac{p_A'}{p_B} \cdot x_A} \end{aligned} \quad (4).$$

If $p_A' = p_B'$, x_B^*/x_B is unity, since in the liquid phase $x_A + x_B = 1$. If $p_B' > p_A'$, the concentration of B will be greater in the vapour phase, and if $p_B' < p_A'$, it will be less.

This may, perhaps, be made clear with the aid of an example. Let us assume that the two components A and B have vapour pressures of 60 and 100 mm. of mercury respectively, and that the mol fraction of A is 0.25 and of B is 0.75. Then for the solution :

$$p_A = 0.25 \times 60 = 15 \text{ mm. (Hg)} \quad \text{and} \quad p_B = 0.75 \times 100 = 75 \text{ mm. (Hg)}.$$

The total pressure will be :

$$p = p_A + p_B = 90 \text{ mm. (Hg)}.$$

The composition of the vapour phase will be :

$$x_A^* = 15/90 = 0.167 \quad \text{and} \quad x_B^* = 75/90 = 0.833.$$

Thus a solution containing mol fractions of 0.25 and 0.75 of A and B respectively is in equilibrium with a vapour containing 16.7 and 83.3 mol per cent. of A and B respectively. The component B with the higher vapour pressure is relatively more concentrated in the vapour phase than in the liquid phase.

If the compositions of the vapour phase for various mixtures of the same two components are calculated and plotted against the vapour pressures, a diagram having the general features shown in Fig. I, 4, 1 is obtained. The abscissae represent the composition of both the liquid and the vapour phases, and the ordinates the total vapour pressure of the liquid. The curve labelled *vapour* gives the composition of the vapour in equilibrium with the solution having the vapour pressure corresponding to the ordinate. Thus the liquid with composition l_1 and vapour pressure p represented by the point m is in equilibrium with vapour of composition l_1' . Since the mixture is an ideal solution of the two liquids, the vapour pressures are additive and the liquid vapour pressure-composition curve AmB is a straight line. The composition of the vapour in equi-

brium with the various mixtures is given by $Am'B$, falling below the liquid vapour pressure-composition line. Figure I, 4, 1 is therefore the vapour pressure diagram for an ideal liquid pair. The diagram shows clearly that the vapour in equilibrium with the ideal solution of two liquids is richer in the more volatile component than is the solution; it follows, therefore, that the two components could be separated by fractional distillation.

Only a limited number of examples are known of mixtures which obey Raoult's law over the whole range of concentration and give straight line plots of the vapour pressure (ordinates) against the composition of the liquid expressed in mol fractions (abscissae). These include:—*n*-hexane and *n*-heptane at 30°; ethyl bromide and ethyl iodide at 30°; *n*-butyl chloride and *n*-butyl bromide at 50°; and ethylene dibromide and propylene dibromide at 85°. In most cases, however, liquid pairs deviate from Raoult's law. The deviations may be either positive or negative, *i.e.*, the vapour pressure may be either greater or less than that calculated. If both components exhibit positive deviations (*e.g.*, carbon disulphide and acetone at 35°), the total vapour pressure curve will be greater than that calculated and the curve passes through a maximum. If the two components show negative deviations (*e.g.*, acetone and chloroform at 35°), the total vapour pressure curve will be less than that calculated and the curve will pass through a minimum. It can be shown that

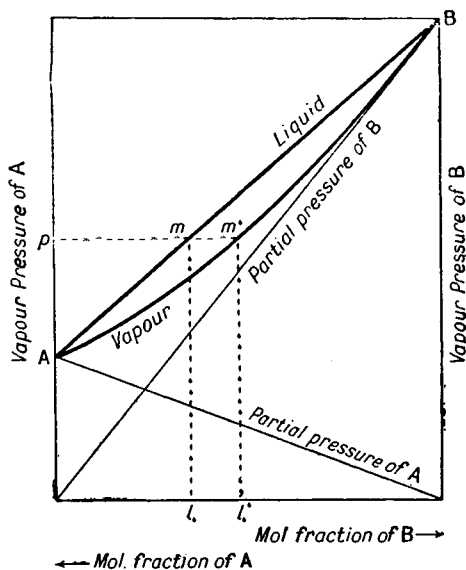

Fig. I, 4, 1.

when the vapour pressure is a maximum or a minimum, the composition of the vapour is the same as that of the liquid with which it is in equilibrium.

The normal boiling point of a liquid is the temperature at which the vapour pressure of the liquid is equal to the pressure of the atmosphere. Hence for the study of fractional distillation it is better to construct a diagram in which the boiling points are ordinates and the compositions are abscissae at constant (*i.e.*, atmospheric) pressure. In the vapour pressure-composition curves the vapour pressure is plotted against the composition at constant temperature, whereas in the boiling point-composition curves the boiling point is plotted against the composition at constant pressure. The two curves are similar in type except that they are inverted (see Figs. I, 4, 2 and I, 4, 3 below). In the boiling point-composition diagram two curves are obtained, one giving the composition of the liquid and the other that of the vapour with which it is in equilibrium at the boiling point. The vapour phase is relatively

richer in the component which results in a lowering of the boiling point when added to the mixture, or, alternatively, the liquid phase is richer in the component which raises the boiling point. Three classes of curves will be considered: those in which (1) the boiling point rises steadily with change of composition from the more volatile to the less volatile component, (2) the boiling point reaches a minimum, and (3) the boiling point reaches a maximum.

(1) **The boiling point increases regularly.** The boiling point - composition diagram for such a system is shown in Fig. I, 4, 2 (the complementary vapour pressure - composition diagram is depicted in Fig. I, 4, 3 for purposes of comparison only). Let us consider the behaviour of such a liquid pair upon distillation. If a solution of composition L_1 is heated, the vapour pressure will rise until at the point l_1 it is equal to the pressure of the atmosphere, and boiling commences at temperature t_1 . The com-

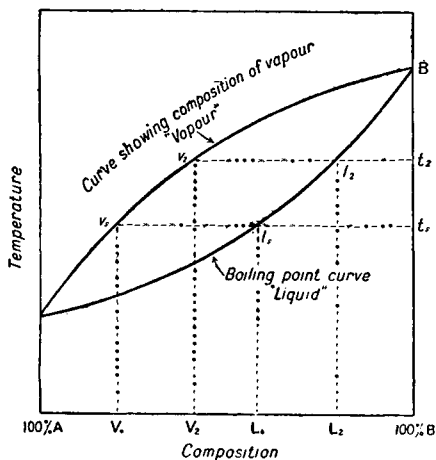

Fig. I, 4, 2.

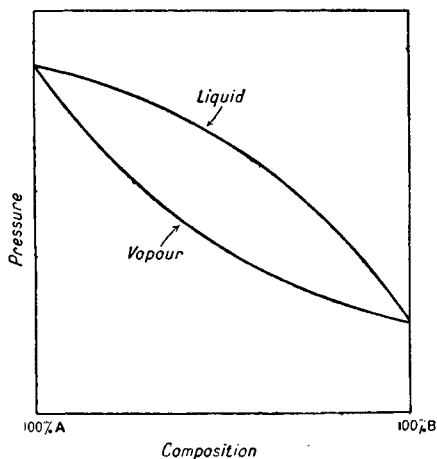

Fig. I, 4, 3.

position of the vapour first distilling is V_1 ; it is richer in A, the lower boiling point component, than was the original solution. As the boiling proceeds, the residue becomes increasingly richer in B, the higher boiling point component; consequently the boiling point will rise, say, to t_2 and the composition of the residue will gradually change to L_2 , whilst that of the distillate (vapour) will change from V_1 to V_2 . Thus from a solution of initial concentration L_1 , a distillate is obtained of composition approximating to $(V_1 + V_2)/2$ and a residue of composition L_2 . The distillation has thus effected a partial separation of A and B, and it is clear that by repeated distillation an almost complete separation of the two components can be made. For this purpose, each fraction collected between suitable temperature limits is redistilled; with each fractionation the separation of the two components is improved. It is evident that the greater the slope of the boiling point curve, the greater is the difference in composition between the liquid and the vapour; hence the greater the difference in the boiling points of the two liquids forming the mixture, the more easily can they be separated by distillation.

In practice, it is usual to employ a fractionating column to reduce the

number of distillations necessary for reasonably complete separation of the two liquids. A fractionating column is designed to provide a continuous series of partial condensations of the vapour and partial vaporisations of the condensate and its effect is, indeed, similar to a number of separate distillations. The effect of partial condensation will be evident from Fig. I, 4, 2. If the temperature of the vapour is lowered, it will partly condense giving a liquid richer in B and leaving the vapour richer in A. The vapour passing up the column will accordingly contain more of A than did the vapour which left the boiling liquid. Similarly the liquid returning to the flask will contain relatively more of the less volatile component B.

A fractionating column consists essentially of a long vertical tube through which the vapour passes upward and is partially condensed; the condensate flows down the column and is returned eventually to the flask. Inside the column the returning liquid is brought into intimate contact with the ascending vapour and a heat interchange occurs whereby the vapour is enriched with the more volatile component A at the expense of the liquid in an attempt to reach equilibrium. The conditions necessary for a good separation are:—(i) there should be a comparatively large amount of liquid continually returning through the column; (ii) thorough mixing of liquid and vapour; and (iii) a large active surface of contact between liquid and vapour. Excessive cooling should be avoided; this difficulty is particularly apparent with liquids of high boiling point and may be overcome by suitably insulating or lagging the outer surface of the column or, if possible, by surrounding it with a vacuum jacket or an electrically heated jacket. Various types of laboratory fractionating columns are described in Sections II,15–II,18.

(2) Minimum boiling point. Typical boiling point-composition curves for systems of this kind are shown in Fig. I, 4, 4. If a solution of composition L_1 is heated, the vapour pressure will rise until at the point l_1 it is equal to the pressure of the atmosphere and boiling commences at t_1 . The composition of the vapour first distilling is V_1 . As the boiling proceeds the temperature rises from t_1 to t_2 , and during this period distillates with compositions ranging from V_1 to V_2 will be obtained. If the distillate be redistilled, the vapour approaches the composition of the minimum boiling point system, as can be seen from the figure. Hence fractional distillation will result in a distillate of composition L_{MI} , although the final residue will approach A. Similarly, a solution of composition L_1' when distilled commences to boil at l_1' , i.e., at a temperature t_1' the vapour (and therefore the distillate) will have the composition V_1' . As the distillation continues the composition of the vapour changes to V_2' and the liquid to L_2' . Fractional distillation will, in this case, yield a solution of composition L_{MI} , and the residue will approach B. The liquid mixture can then be separated only into the component present in excess (either A or B) and the mixture of minimum boiling point. The liquid represented by L_{MI} will distil over completely without change of composition since at the boiling point the vapour has the same composition as the liquid. Such systems which distil unchanged are called azeotropic mixtures (Greek: *to boil unchanged*). The composition and boiling point of such constant boiling point mixtures vary with the pressure and consequently they are not chemical compounds.

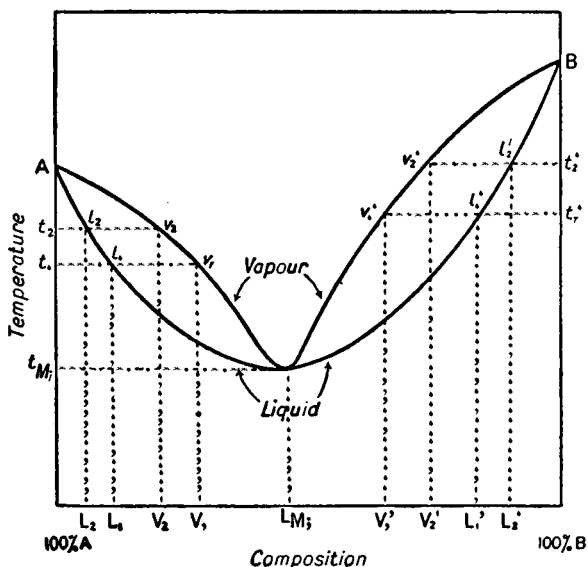

Fig. I, 4, 4.

Examples of azeotropic mixtures of minimum boiling point are collected in Table I, 4, A.

TABLE I, 4, A. AZEOTROPIC MIXTURES OF MINIMUM BOILING POINT

COMPONENT A	COMPONENT B	B.P. OF AZEOTROPIC MIXTURE	% OF A (BY WT.) IN MIXTURE
Water, 100.0°	Ethyl alcohol, 78.3°	78.15°	4.4
Water, 100.0°	isoPropyl alcohol, 82.4°	80.4°	12.1
Water, 100.0°	n-Propyl alcohol, 97.2°	87.7°	28.3
Water, 100.0°	tert.-Butyl alcohol, 82.6°	79.9°	11.8
Water, 100.0°	Pyridine, 115.5°	92.6°	43.0
Methyl alcohol, 64.7°	Methyl iodide, 44.5°	39.0°	7.2
Ethyl alcohol, 78.3°	Ethyl iodide, 72.3°	63.0°	13
Methyl alcohol, 64.7°	Methyl acetate, 57.0°	54.0°	19
Ethyl alcohol, 78.3°	Ethyl acetate, 77.2°	71.8°	31
Water, 100.0°	Butyric acid, 163.5°	99.4°	18.4
Water, 100.0°	Propionic acid, 140.7°	100.0°	17.7
Benzene, 80.2°	cycloHexane, 80.8°	77.5°	55
Ethyl alcohol, 78.3°	Benzene, 80.2°	68.2°	32.4
Ethyl alcohol, 78.3°	Toluene, 110.6°	76.7°	68
Methyl alcohol, 64.7°	Chloroform, 61.2°	53.5°	12.5
Ethyl alcohol, 78.3°	Chloroform, 61.2°	59.4°	7.0
Ethyl alcohol, 78.3°	Methyl ethyl ketone, 79.6°	74.8°	40
Methyl alcohol, 64.7°	Methylal, 42.2°	41.8°	18.2
Acetic acid, 118.5°	Toluene, 110.6°	105.4°	28

(3) Maximum boiling point. A typical boiling point-composition diagram is shown in Fig. I, 4, 5. By reasoning analogous to that given

under (2), it is evident that fractional distillation of a liquid mixture of composition L_1 will yield ultimately a specimen of almost pure A and a residue of composition L_{Ma} , which will eventually distil unchanged. Similarly, a liquid mixture of composition L_1' will give ultimately pure B and a residue L_{Ma} , which will itself distil unchanged. Thus distillation will afford ultimately the component present in excess of the constant boiling mixture and the constant boiling mixture itself.

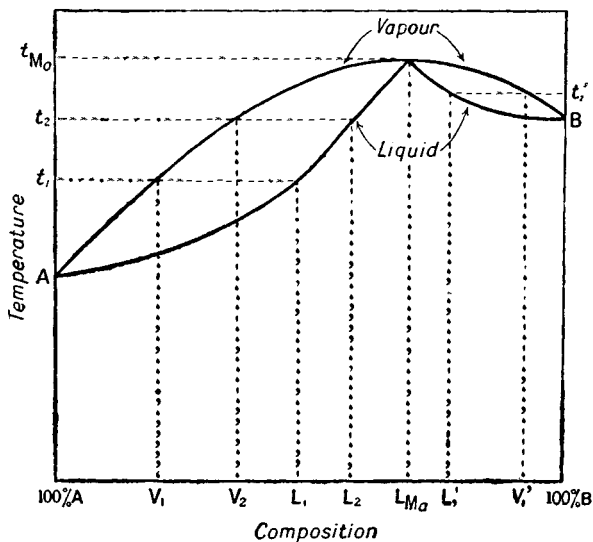

Fig. I, 4, 5.

Examples of azeotropic mixtures of maximum boiling point are tabulated below; these are not as numerous as those of minimum boiling point.

TABLE I, 4, B. AZEOTROPIC MIXTURES OF MAXIMUM BOILING POINT

COMPONENT A	COMPONENT B	B.P. OF AZEOTROPIC MIXTURE	% OF B (BY WT.) IN MIXTURE
Water, 100·0°	Formic acid, 100·8°	107·1°	77·5
Water, 100·0°	Hydrofluoric acid, 19·4°	120·0°	37
Water, 100·0°	Hydrochloric acid, - 84·0°	108·6°	20·22
Water, 100·0°	Hydrobromic acid, - 73°	126°	47·6
Water, 100·0°	Hydriodic acid, - 35°	127°	57·0
Water, 100·0°	Nitric acid, 86·0°	120·5°	68
Water, 100·0°	Sulphuric acid, m.p. 10·5°	338°	98·3
Water, 100·0°	Perchloric acid, 110·0°	203°	71·6
Acetone, 56·4°	Chloroform, 61·2°	64·7°	80
Acetic acid, 118·5°	Pyridine, 115·5°	139·7°	65
Chloroform, 61·2°	Methyl acetate, 57·0°	64·8°	23
Phenol, 181·5°	Aniline, 184·4°	186·2°	58

I,5. The breaking up of azeotropic mixtures. The behaviour of constant boiling point mixtures simulates that of a pure compound, because the composition of the liquid phase is identical with that of the vapour phase. The composition, however, depends upon the pressure at which the distillation is conducted and also rarely corresponds to stoichiometric proportions. The methods adopted in practice will of necessity depend upon the nature of the components of the binary azeotropic mixture, and include :—

(1) Distillation with a third substance which alters the vapour pressure ratios in the azeotrope. This method is of particular value in industry for the production of absolute ethyl alcohol from the azeotropic mixture containing 95·6 per cent. of alcohol or from aqueous alcohol. Upon the addition of benzene and distillation through a suitable fractionating apparatus, a ternary azeotropic mixture of water, alcohol and benzene of minimum boiling point, 64·85°, and containing 7·4 per cent. of water, 18·5 per cent. of alcohol and 74·1 per cent. of benzene passes over first, followed by a second azeotropic mixture of benzene and alcohol (b.p. 68·25°, containing 32·4 per cent. of benzene), and finally absolute ethyl alcohol. By carrying out the fractional distillation under pressure, the water content of the ternary mixture is increased.

(2) Chemical methods may be employed if the reagent attacks only one of the components. Thus quicklime may be employed for the removal of water in the preparation of absolute ethyl alcohol. Also aromatic and unsaturated hydrocarbons may be removed from mixtures with saturated hydrocarbons by sulphonation.

(3) Preferential adsorption of one of the components may be used for the same purpose. Charcoal or silica gel may be employed to adsorb one of the constituents of an azeotrope in preference to the other. If the adsorbate is readily recoverable, the process will have practical applications.

(4) Fractional extraction may sometimes find application, since the components distribute themselves in a different proportion in the solvent (compare Section II,44).

(5) Fractional crystallisation is occasionally employed. The mixture is dissolved in a suitable solvent, the whole frozen, and then allowed to melt slowly in a centrifuge in order that the successive fractions may be removed as they are formed. The various melts are then fractionally distilled. If necessary, the fractional crystallisation may be repeated.

I,6. Steam Distillation. Distillation of a Pair of Immiscible Liquids. Steam distillation is a method for the isolation and purification of substances. It is applicable to liquids which are usually regarded as completely immiscible or to liquids which are miscible to only a very limited extent. In the following discussion it will be assumed that the liquids are completely immiscible. The saturated vapours of such completely immiscible liquids follow Dalton's law of partial pressures (1801), which may be stated : when two or more gases or vapours which do not react chemically with one another are mixed at constant temperature each gas exerts the same pressure as if it alone were present and that

the sum of these pressures is equal to the total pressure exerted by the system. This may be expressed :

$$P = p_1 + p_2 + \dots + p_n$$

where P is the total pressure and p_1, p_2 , etc., are the partial pressures of the components.

If a mixture of two immiscible liquids be distilled, the boiling point will be the temperature at which the sum of the vapour pressures is equal to that of the atmosphere. This temperature will be lower than the boiling point of the more volatile component. Since one of the liquids is water, steam distillation at atmospheric pressure will result in the separation of the higher boiling component at a temperature below 100° —a considerable advantage if the compound decomposes at or near its own individual boiling point ; the process would also be useful for separation from non-volatile or from undesirable (*e.g.*, tarry) substances. When a mixture of immiscible liquids is distilled, the boiling point of the mixture remains constant until one of the components has been almost completely removed (since the total vapour pressure is independent of the relative amounts of the two liquids) : the boiling point then rises to that of the liquid remaining in the flask. The vapour passing over from such a mixture contains all the components in proportion by volume to the relative vapour pressure of each.

The composition of the vapour can easily be calculated as follows :— Assuming that the gas laws are applicable, it follows that the number of molecules of each component in the vapour will be proportional to its partial pressure, *i.e.*, to the vapour pressure of the pure liquid at that temperature. If p_A and p_B are the vapour pressures of the two liquids A and B at the boiling point of the mixture, then the total pressure P is given by :

$$P = p_A + p_B \quad (1),$$

and the composition of the vapour by :

$$n_A/n_B = p_A/p_B \quad (2),$$

where n_A and n_B are the number of mols of the two substances in a given volume of the vapour phase. But $n_A = w_A/M_A$ and $n_B = w_B/M_B$, where w is the weight of substance in a given volume of the vapour, and M is the molecular weight. Hence :

$$\frac{w_A}{w_B} = \frac{M_A n_A}{M_B n_B} = \frac{M_A p_A}{M_B p_B} \quad (3).$$

The relative weights of the two components of the vapour phase will be identical with the relative weights in the distillate, *i.e.*, the weights of the two liquids collecting in the receiver are directly proportional to their vapour pressures and their molecular weights.

Equation (3) indicates the great value of steam distillation, since the smaller the product $M_A p_A$, the larger is the value of w_B . Water has a small molecular weight and a comparatively moderate vapour pressure, so that its value of $M_A p_A$ is low. This permits substances of high molecular weight and of low vapour pressure to be separated economically on the technical scale. The following figures are given by S. Young (1922).

SUBSTANCE	MOLECULAR WT. M_B	B.P.	p_B AT 100°	PER CENT. IN DISTILLATE
Carvone .	150	230°	9 mm.	9·7
Geraniol .	154	230°	5 mm.	5·6
Anethole .	148	235°	8 mm.	7·1
Eugenol .	164	250°	2 mm.	1·7
α -Santalol .	228	301°	<1 mm.	0·5

As an example of steam distillation, let us consider bromobenzene which has a normal boiling point of 155°. The vapour pressures of water and bromobenzene at different temperatures are given in the following table.

TEMPERATURE	VAPOUR PRESSURE		
	WATER (p_A)	BROMOBENZENE (p_B)	MIXTURE ($P = p_A + p_B$)
30°	32 mm.	6 mm.	38 mm.
40°	55 mm.	10 mm.	65 mm.
50°	92 mm.	17 mm.	109 mm.
60°	149 mm.	28 mm.	177 mm.
70°	233 mm.	44 mm.	277 mm.
80°	355 mm.	66 mm.	421 mm.
90°	525 mm.	98 mm.	623 mm.
95°	634 mm.	118 mm.	752 mm.
100°	760 mm.	141 mm.	901 mm.

If we plot these as in Fig. I, 6, 1 we find that the vapour pressure of the mixture attains 760 mm. at a temperature of 95·3°; this is therefore the boiling point of the mixture. At this temperature $p_A = 641$ mm. and $p_B = 119$ mm. The molecular weights of the two liquids are 18 and 157 respectively. Substituting these values in equation (3), we have :

$$\frac{w_A}{w_B} = \frac{641 \times 18}{119 \times 157} = \frac{6\cdot2}{10\cdot0}$$

Thus for every 6·2 grams of water collected in the receiver 10·0 grams of bromobenzene are obtained (or the distillate contains 62 per cent. by weight of bromobenzene) in spite of the fact that bromobenzene has only 119/641 of the vapour pressure of water at the boiling point of the mixture.

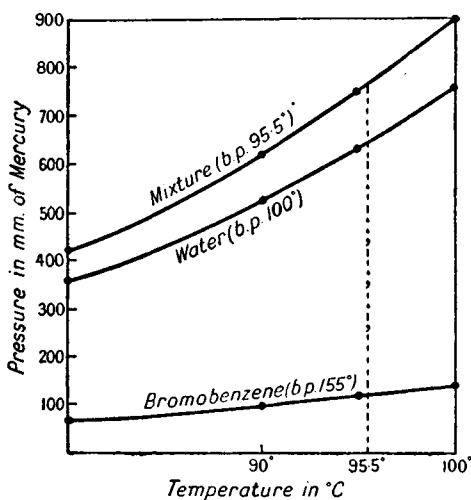

Fig. I, 6, 1.

Similarly it is found that for chlorobenzene the boiling point of the mixture (T_{Mixture}) is 90.3° , $p_A = 530$, $p_B = 230$, $M_B = 112.5$, and the distillate contains 71 per cent. of chlorobenzene by weight; for iodobenzene, the boiling point of the mixture is 98.2° , $p_A = 712$, $p_B = 48$, $M_B = 204$, giving a distillate containing 43 per cent. by weight of iodobenzene. For aniline T_{Mixture} is 98.5° , $p_A = 717$, $p_B = 43$, $M_B = 93$, and the calculated value is 23 per cent. of aniline by weight: the proportion found experimentally is somewhat lower because aniline is appreciably soluble in water and the vapour pressure is slightly reduced.

I,7. Distillation with superheated steam. Consideration of equation (3) (Section I,6) indicates that the proportion of the higher boiling point component in the steam distillate can be raised by increasing the

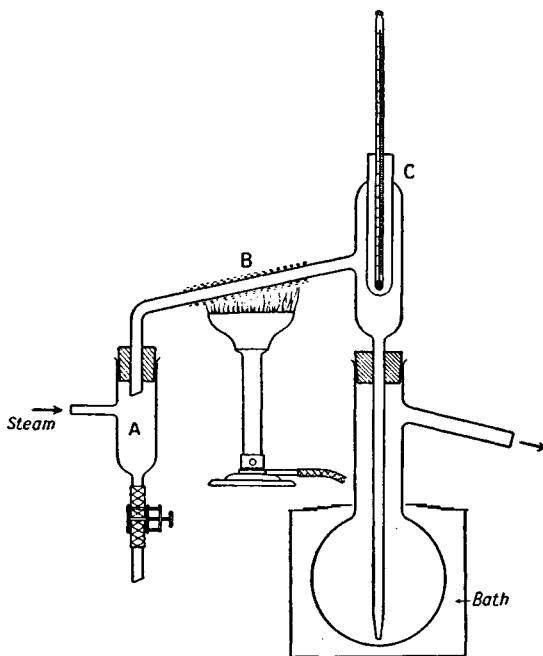

Fig. I, 7, 1.

vapour pressure of this component relative to water. This may be done with superheated (or high pressure) steam.

The effect of superheated steam may be illustrated by reference to benzaldehyde, which boils at 178° at 760 mm. It distils with steam at 97.9° ($p_A = 703.5$ mm. and $p_B = 56.5$ mm.) and the distillate contains 32.1 per cent. of benzaldehyde by weight. If one employs steam superheated to 133° , the vapour pressure of benzaldehyde (extrapolated from the boiling point-pressure curve) is 220 mm.: hence $p_A = 540$ (water), $p_B = 220$ (benzaldehyde), and

$$\frac{w_A}{w_B} = \frac{540 \times 18}{220 \times 106} = \frac{41.7}{100}$$

i.e., the distillate contains 70.6 per cent. of benzaldehyde by weight. This compares with 31.4 per cent. with steam at 100° and one atmosphere.

The use of superheated steam has the advantage that less condensation takes place thus obviating the use of supplementary heat in the vessel containing the substance; beyond this no advantage over steam used under ordinary pressure will result so long as condensed water is present. If all condensation of the steam is prevented (*e.g.*, by surrounding the flask by a bath of liquid at the same temperature as the superheated steam), the higher temperature of the superheated steam will result in an increase in the proportion of the higher boiling point component in the distillate.

In practice superheated steam is generally employed for substances with a low vapour pressure ($< 5-1$ mm.) at 100° . Thus in the recovery of the products of nitration or aromatic compounds, the *ortho* derivative (*e.g.*, *o*-nitrophenol) can be removed by ordinary steam distillation; the

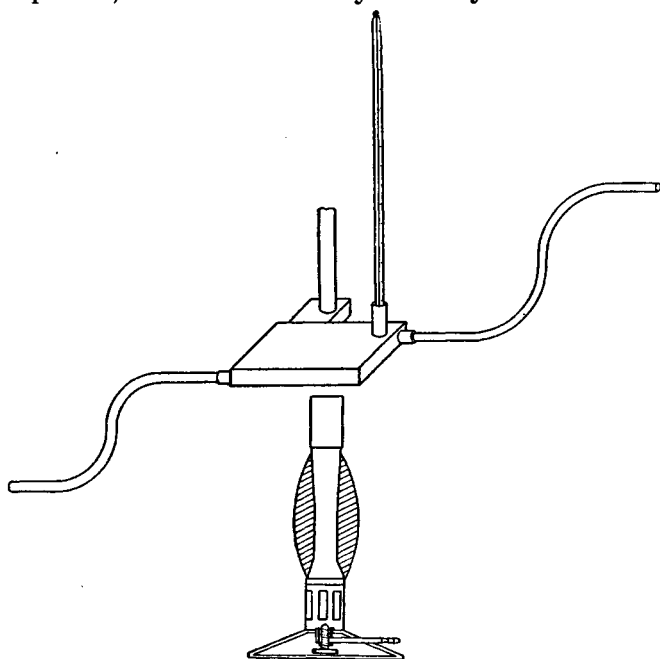

Fig. I, 7, 2.

temperature may then be raised, and the *para* compound distilled. The upper limit of temperature will of course be controlled by the stability of the compound.

A convenient apparatus for distillation in superheated steam (due to A. A. Morton) is shown in Fig. I, 7, 1. The Pyrex tube *B*, of 10 mm. diameter or larger, is wrapped with a few layers of wire gauze and heated with a wing-topped burner, the gauze being supported by a clamp to prevent sagging of the tube at the high temperature; *C* is a thermometer and *A* is a trap for condensed water. The flask is heated in an oil bath to approximately the same temperature as the superheated steam. It will be observed that the superheater is close to the steam inlet tube, thus reducing the cooling of the steam, before it enters the flask, to a minimum. A commercial apparatus, constructed of metal (the Fisher superheater), is shown in Fig. I, 7, 2.

SOLUTIONS OF LIQUIDS IN LIQUIDS

I,8. Partially miscible liquids. Critical solution temperature. Some liquids are practically immiscible (*e.g.*, water and mercury), whilst others (*e.g.*, water and ethyl alcohol or acetone) mix with one another in all proportions. Many examples are known, however, in which the liquids are partially miscible with one another. If, for example, water be added to ether or if ether be added to water and the mixture shaken, solution will take place up to a certain point; beyond this point further addition of water on the one hand, or of ether on the other, will result in the formation of two liquid layers, one consisting of a saturated solution of water in ether and the other a saturated solution of ether in water. Two such mutually saturated solutions in equilibrium at a particular temperature are called *conjugate solutions*. It must be mentioned that there is no essential theoretical difference between liquids of partial and complete miscibility for, as will be shown below, the one may pass into the other with change of experimental conditions, such as temperature and, less frequently, of pressure.

Three types of liquid/liquid systems are commonly encountered. The first type (*e.g.*, phenol and water) is characterised by increasing mutual solubility with rise of temperature. Thus when phenol is added to water at the ordinary temperature, a homogeneous liquid is produced. When the concentration of the phenol in the solution has risen to about 8 per cent., the addition of more phenol results in the formation of a second liquid phase, which may be regarded as a solution of water in phenol. If now the temperature is raised, the second liquid phase will disappear and more phenol must be added to produce a separation of the liquid into two layers. By increasing the amount of phenol in this way and observing the temperature at which the two layers disappear, the so-called solubility curve of phenol in water may be determined. In a similar manner the solubility curve of water in liquid phenol may be obtained, and it is found that the solubility also increases with rise of temperature. It is clear that since, with rise of temperature, the concentration of water in the phenol layer and also of phenol in the water layer increases, the compositions of the two conjugate solutions become more and more nearly the same, and at a certain temperature the two solutions become identical in composition. The temperature at which the two layers become identical in composition and are, in fact, one layer is known as the *critical solution temperature* (D. O. Masson, 1891) or the *consolute temperature* (W. D. Bancroft, 1894) of the system. Above this temperature the two liquids are miscible in all proportions. Some experimental results for the mutual solubility of phenol in water are plotted in Fig. I, 8, 1; these lead to a critical solution temperature of 65.9° and a critical concentration of 34.0 per cent. of phenol. Fig. I, 8, 1 enables one to predict the effect of bringing together phenol and water in any given quantities at any temperature. If the resulting mixture is represented by a point in the area enclosed by the solubility curve, separation into two layers will take place, whereas if the total composition of the mixture and the temperature is expressed by a point lying outside the solubility curve a clear homogeneous solution will result.

Other pairs of liquids which exhibit an upper consolute temperature are methyl alcohol-*cyclohexane* (C.S.T. 49.1° ; critical composition 29 per cent. by weight of methyl alcohol); *isopentane*-phenol (63.5° ; 51 per cent. of *isopentane*); and carbon disulphide-methyl alcohol (40.5° ; 80 per cent. of carbon disulphide).

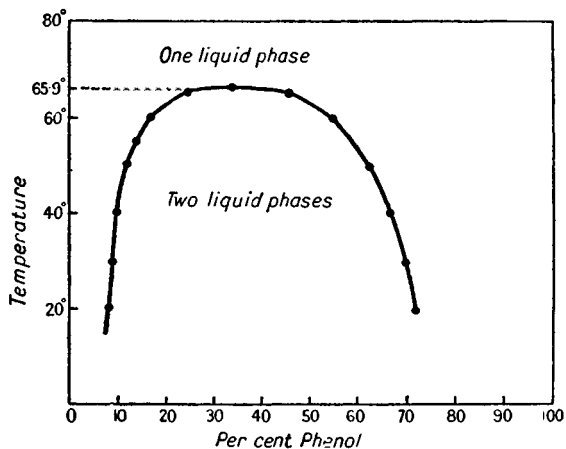

Fig. I, 8, 1.

The second type of system is characterised by decreasing mutual solubility with rise of temperature. As the temperature is lowered the mutual solubilities increase and *below* a certain critical temperature the two liquids become miscible in all proportions. A typical example is triethylamine and water. The behaviour of this system with respect to

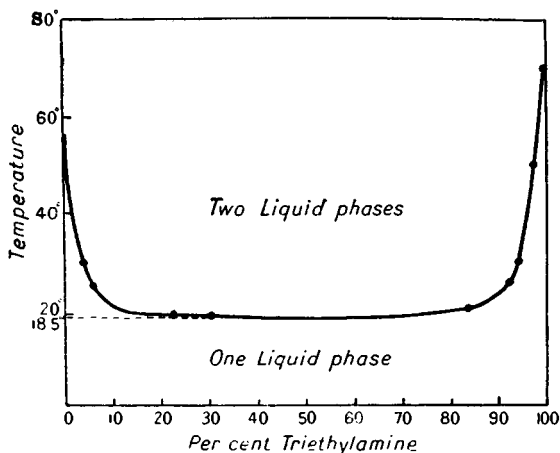

Fig. I, 8, 2.

concentration and temperature is shown in Fig. I, 8, 2; the critical solution temperature is 18.5° . Other pairs of liquids which exhibit a lower critical solution temperature are: diethylamine - water (C.S.T. 43° ; 13 per cent. by weight of diethylamine); β -collidine - water (6° ; 4 per cent.); 1-methylpiperidine - water (48° ; 5 per cent.).

The third type of system gives a closed solubility curve and therefore possesses both an upper and lower critical solution temperature. The first case of this type to be established was that of nicotine and water; the solubility curve is illustrated in Fig. I, 8, 3. The lower and upper consolute temperatures are 60.8° and 208° respectively; below the former and above the latter the two liquids are completely miscible.

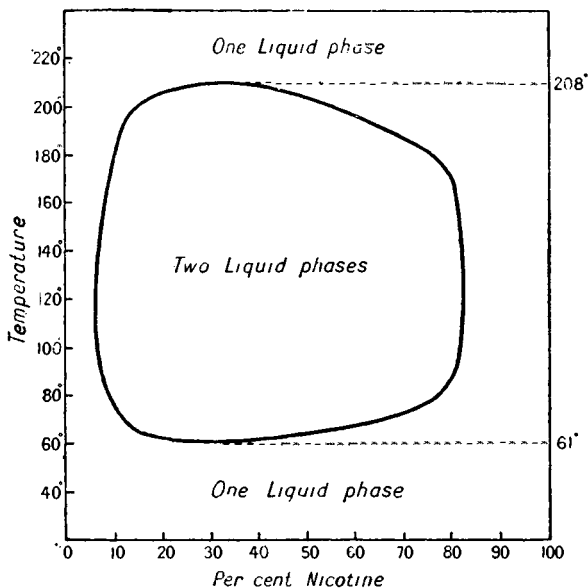

Fig. I, 8, 3.

It should be noted that the modern view is that all partially miscible liquids should have both a lower and upper critical solution temperature so that all such systems really belong to one class. A closed solubility curve is not obtained in all cases because the physical conditions under normal pressure prevent this. Thus with liquids possessing a lower C.S.T., the critical temperature (the critical point for the liquid - vapour system for each component, i.e., the maximum temperature at which liquefaction is possible) may be reached before the consolute temperature. Similarly for liquids with an upper C.S.T., one or both of the liquids may freeze before the lower C.S.T. is attained.

Many pairs of partially miscible liquids possess neither a lower nor an upper C.S.T. for reasons outlined in the previous paragraph. Thus consider the two liquid phases from the two components water and diethyl ether. Upon cooling the system at constant pressure, a point will be reached when a third phase, ice, will form, thus rendering the production of a lower C.S.T. impossible. Likewise, if the temperature of the two layers is raised, the critical point for the ether-rich layer will be reached while the two liquid phases have different compositions. Above the critical point the ether-rich layer will be converted into vapour, and hence the system will be converted into a water-rich liquid and an ether-rich vapour; the upper C.S.T. cannot therefore be attained.

A few systems with both lower and upper critical solution temperatures are tabulated below.

SYSTEM (A,B)	LOWER C.S.T.	UPPER C.S.T.
Water : 2-methylpiperidine	79°	227°
Water : 3-methylpiperidine	56°	236°
Water : 4-methylpiperidine	85°	189°
Water : β -picoline	49°	153°
Water : α -lutidine	45°	164°
Glycerol : <i>m</i> -toluidine	7°	120°

I,9. Influence of added substances upon the critical solution temperature. For a given pressure the C.S.T. is a perfectly defined point. It is, however, affected to a very marked extent by the addition of quite a small quantity of a foreign substance (impurity), which dissolves either in one or both of the partially miscible liquids. The determination of the consolute temperature may therefore be used for testing the purity of liquids. The upper consolute temperature is generally employed for this purpose.

If the third substance dissolves in only one of the liquids, it is found that their mutual solubilities are decreased and the C.S.T. is generally raised. For example, a concentration of 0.15 mol of potassium chloride per litre of water raises the C.S.T. of the water - phenol system by about 12°; a similar concentration of naphthalene in the phenol produces a rise of about 30°.

If the third substance dissolves in both liquids (and the solubility in each of the liquids is of the same order), the mutual solubility of the liquids will be increased and an upper C.S.T. will be lowered, as is the case when succinic acid or sodium oleate is added to the phenol - water system. A 0.083 molar solution of sodium oleate lowers the C.S.T. by 56.7°: this large effect has been applied industrially in the preparation of the disinfectant sold under the name of "*Lysol*." Mixtures of tar acids (phenol + cresols) do not mix completely with water at the ordinary temperature, but the addition of a small amount of soap (\equiv sodium oleate) lowers the miscibility temperature so that "*Lysol*" exists as a clear liquid at the ordinary temperature.

An important application of the critical solution temperature is to the determination of the water content in such substances as methyl and ethyl alcohols. Here the system is usually the alcohol and a hydrocarbon, such as *n*-hexane or *dicyclohexyl*; the water is, of course, insoluble in the hydrocarbon. Thus, the methyl alcohol - *cyclohexane* system has a C.S.T. of 45.5° and even 0.01 per cent. of water produces a rise of 0.15° in the C.S.T. The experimental details are given below.

For methyl alcohol, two volumes of synthetic *n*-hexane, b.p. 68.6-69.0° (uncorr.), and one volume of the alcohol to be tested are mixed and the homogeneous mixture is cooled in ice until the appearance of a cloudiness. A thermometer is placed in the solution, which is allowed to warm gradually to the temperature at which the second phase disappears. The

temperature at which the solution just becomes homogeneous is taken as the critical solution temperature. The same result is obtained by observing the temperature at which the second phase appears. The water content may then be deduced with the aid of the following table, and checked, if desired, by a determination of the density (Section XI,2).

PURITY OF CH ₃ OH (%)	C.S.T.	d_4^{20}
100·0	36·55°	0·79578
99·80	37·90	0·79634
99·65	38·95	0·79676
99·50	40·05	0·79718
99·35	41·00	0·79760
99·05	43·00	0·79845
98·60	45·00	0·79947
98·41	46·25	0·80026
98·01	48·05	0·80140
97·48	50·15	0·80292
97·13	51·10	0·80390

For ethyl alcohol, two volumes of dicyclohexyl* are mixed with one volume of the alcohol, a thermometer is introduced, and the mixture heated until it becomes clear. The solution is then slowly cooled, with constant stirring, and the temperature is determined at which the opalescent solution suddenly becomes turbid so that the immersed portion of the mercury thread of the thermometer is no longer clearly visible. This is the C.S.T. The water content may then be evaluated by reference to the following table.

PURITY OF C ₂ H ₅ OH (%)	C.S.T.	d_4^{20}
100·0	23·4°	0·78934
99·9	25·4	0·78966
99·8	27·3	0·78997
99·7	29·2	0·79028
99·6	31·0	0·79059
99·5	32·8	0·79089
99·0	41·0	0·79243
98·5	48·0	0·79346

THEORY OF MELTING AND FREEZING

I,10. Melting point and vapour pressure. The melting point of a crystalline solid is the temperature at which the solid begins to change into liquid under a pressure of one atmosphere. For pure substances, the change from the solid to the liquid state is quite sharp (within 0·5°), hence the temperature is valuable for purposes of identification. Moreover, the melting point is considerably influenced by the presence of other

* This may be prepared by the catalytic reduction of pure diphenyl (see Section III,150).

substances, and it is therefore an important criterion of purity. If the liquid is cooled, solidification will occur at the same temperature,* and for a pure substance the melting point and freezing point are identical. The freezing point is usually defined as the temperature at which both liquid and solid can exist in contact with each other under a total pressure of one atmosphere.

The reason for the constancy and sharpness of the melting point of a pure crystalline solid can be appreciated upon reference to Fig. 1, 10, 1, in which (a) is the vapour pressure curve of the solid and (b) that of the liquid form of the substance. Let us imagine a vessel, maintained at constant temperature, *completely* filled with a mixture of the above liquid and solid. The molecules of the solid can only pass into the liquid and the molecules of the liquid only into the solid. We may visualise two competitive processes taking place: (i) the solid attempting to "evaporate" but it can only pass into the liquid, and (ii) the liquid attempting to "distil" but it can only pass into the solid. If process (i) is faster, the solid will melt, whereas if process (ii) proceeds with greater speed the

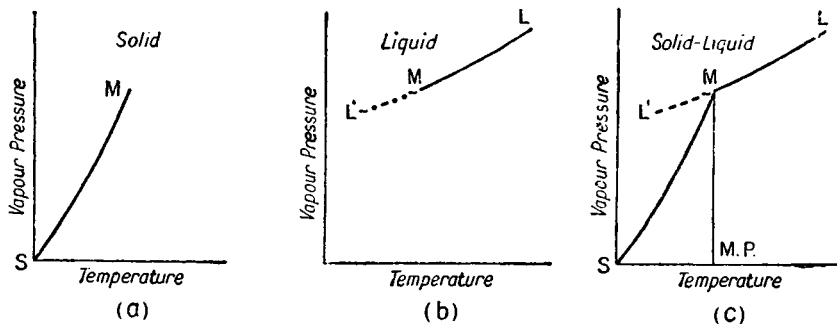

Fig. 1, 10, 1.

substance would completely solidify. To decide which process is likely to occur at a particular temperature, curve (a) must be superimposed upon curve (b) thus giving curve (c). The rate of rise of vapour pressure with temperature is greater for the solid than for the liquid, consequently the two curves will intersect. At the intersection (and only at this temperature), both solid and liquid can coexist; this is therefore the freezing point or melting point since these two constants are identical for a pure substance. Provided the pressure is atmospheric, the temperature M is an absolute constant. If the temperature is less than M , the liquid will pass more rapidly into solid than the solid into liquid and hence the substance will remain solid, whilst for temperatures greater than M the solid, having the greater vapour pressure, will pass more rapidly into the liquid phase. It is only at the temperature M , at which the vapour pressures of the liquid and the solid are equal in magnitude, that the rates of transformation are identical and both liquid and solid can coexist, provided the temperature is maintained constant. As soon as the

* A liquid can sometimes be supercooled, *i.e.*, the temperature can be reduced below the freezing point without solid separating, but as soon as solid does appear the temperature immediately rises to the true freezing point.

temperature is raised even a fraction of a degree above M , the solid will be completely converted into the liquid phase, assuming of course that sufficient time is allowed for the transformation to take place. This is why the rate of rise of temperature in the vicinity of the melting point must be small (say, $1-2^\circ$ per minute) for an accurate determination of this constant.

It is a well-known fact that substances like water and acetic acid can be cooled below the freezing point: in this condition they are said to be supercooled (compare supersaturated solution). Such supercooled substances have vapour pressures which change in a normal manner with temperature: the vapour pressure curve is represented by the dotted line ML' —a continuation of ML . The curve ML' lies above the vapour pressure curve of the solid and it is apparent that the vapour pressure of the supersaturated liquid is greater than that of the solid. The supercooled liquid is in a condition of metastability. As soon as crystallisation sets in, the temperature rises to the true freezing or melting point. It will be observed that no dotted continuation of the vapour pressure curve of the solid is shown; this would mean a suspended transformation in the change from the solid to the liquid state. Such a change has not been observed nor is it theoretically possible.

I,11. Effect of impurities upon the melting point. Let us take a specific example and examine the effect of the addition of a small quantity

of naphthalene to an equilibrium mixture of pure solid and liquid α -naphthol at the temperature of the true melting point (95.5°) at atmospheric pressure. The naphthalene will dissolve in the liquid α -naphthol and, according to Raoult's law, the vapour pressure of the latter will be reduced. Hence α -naphthol will pass preferentially into the liquid phase and, if the external temperature is maintained at 95.5° , the ultimate result will be the complete melting of the solid α -naphthol; since melting requires heat and no heat is imparted to the system, the temperature will fall.

The effect can easily be interpreted by reference to Fig. I, 11, 1. The initial state of the system is represented by M . Upon the addition of a small amount of the second substance, the vapour pressure of the liquid first falls to A . Now a solid phase with vapour pressure M cannot coexist with a liquid phase with lower vapour pressure A . The solid represented by M will therefore melt and tend to pass into the condition expressed by A . However, in melting heat is absorbed, and the temperature will consequently fall. Thus the vapour pressures of the solid M and the liquid A will fall along their respective vapour pressure curves, which will intersect at M_1 . At M_1 equilibrium results and no further change will take place; here solid α -naphthol and the solution of naphthalene in α -naphthol may coexist indefinitely—this, it will be observed, is below the melting point of the pure substance (α -naphthol). Further addition of naphthalene

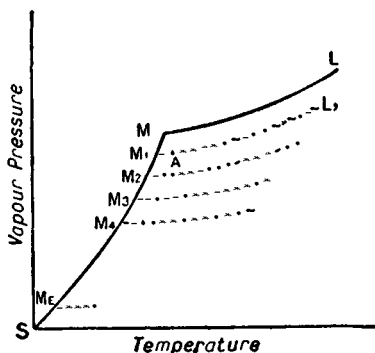

Fig. I, 11, 1.

will result in the depression of the melting point of α -naphthol to points represented by M_2 , M_3 , etc.; the curve through these points indicates the temperatures at which solid α -naphthol can coexist with solutions of increasing naphthalene content. It is natural to enquire as to how far the melting point may be depressed by additions of the second substance. The limiting temperature M_E is known as the eutectic point; it is the temperature below which not even the impure liquid can exist. Further cooling merely results in both components solidifying completely.

A somewhat different method of plotting the results will help the reader to appreciate the significance of the eutectic temperature. In Fig. I, II, 2 melting points are plotted against composition.* The curve AC portrays the decreasing melting point of α -naphthol as naphthalene is added up to a mol fraction of 0.605. The curve BC represents the

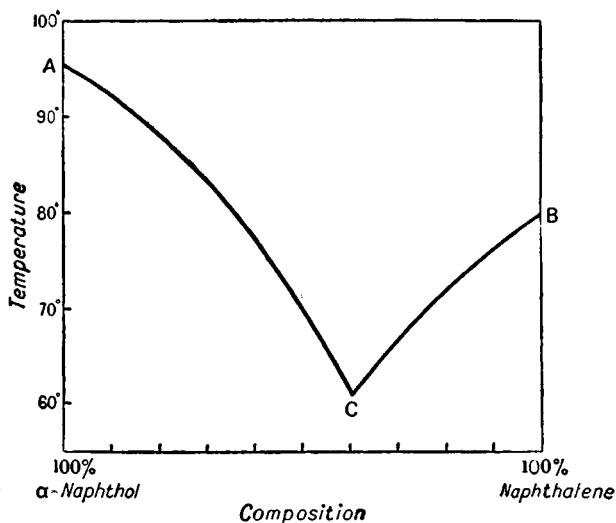

Fig. I, 11, 2.

melting points of naphthalene with α -naphthol regarded as the "foreign ingredient" up to a mol fraction of 0.395 of α -naphthol. The curves intersect at C giving a eutectic temperature of 61.0° .

I,12. System in which the solid phases consist of the pure components and the components are completely miscible in the liquid phase. We may now conveniently consider the general case of a system in which the two components A and B are completely miscible in the liquid state and the solid phases consist of the pure components. The equilibrium diagram is shown in Fig. I, 12, 1. Here the points A and B are the melting points of the pure components A and B respectively. If the freezing points of a series of liquid mixtures, varying in composition from pure A to pure B , are determined, the two curves represented by AC and BC will be obtained. The curve AC expresses the compositions of solutions which are in equilibrium, at different temperatures, with the solid component A , and, likewise, the curve BC denotes the compositions

* Frequently composition is expressed in mol fractions or in mol fractions $\times 100$, i.e., molecular composition $\times 100$ (compare footnote to Section I,IV).

of solutions in equilibrium with the solid *B*. At the point of intersection of the two curves *C*, both solid components can exist in equilibrium with a liquid solution of definite composition corresponding with the point *C*. This point is called the eutectic point (Greek: *easy melting*), and represents the temperature and composition at which the system liquid - solid *A* - solid *B* can exist in equilibrium; in short, it gives the temperature and composition of the system when both components crystallise out simultaneously. This solid mixture is known as the eutectic mixture. It has a fixed composition and melts and freezes, like a pure substance, at a definite temperature. This temperature is the eutectic temperature and is always the lowest freezing point of the whole series of mixtures of *A* and *B*. The eutectic mixture is not, however, a definite chemical compound because (i) separate crystals of the two components can be seen under the microscope and (ii) it rarely corresponds to the exact composition of a simple chemical compound; it is, in fact, an intimate mechanical mixture or conglomerate of the two solid components. If a liquid solution having a composition represented by a point lying to the left of the eutectic point *C* be cooled, the solid component *A* will crystallise out (it is assumed that supersaturation is excluded) when the temperature reaches the point on the curve *AC* corresponding with the initial composition of the solution. If the cooling be continued, more and more of the component *A* will separate and the composition of the solution will change in the direction of *C*. When the composition corresponding to the point *C* is reached, solid *B*, also, can crystallise out. If withdrawal of heat from the system be continued, both solid *A* and solid *B* will separate while the temperature remains constant. Since, according to the phase rule (compare Section I,20), the composition of the solution at the point *C* must remain constant, it follows that the components *A* and *B* must crystallise from the eutectic solution in constant proportions. In a similar manner, if a liquid having a composition represented by a point to the right of *C* be cooled, the solid *B* will separate and the composition of the solution will change in the direction of *C*. At *C*, solid *A* will also crystallise out, and the temperature and composition of the solution will remain constant whilst the solid components crystallise out as a eutectic mixture. If a liquid mixture of composition denoted by the eutectic point *C* be cooled, no solid will separate until the eutectic temperature *D* is reached and then the eutectic mixture will crystallise out.

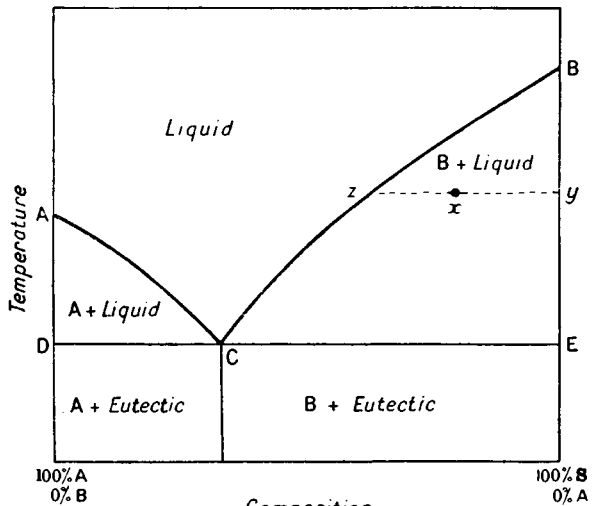

Fig. I, 12, 1.

It is convenient, when dealing with mixtures, to call the temperature at which the solid commences to crystallise from the liquid, the **freezing point of the mixture**, and to term the temperature at which the solid mixture begins to liquefy the **melting point of the mixture**. The complete equilibrium diagram usually includes two curves, which are called liquidus and solidus respectively. The **liquidus** (or liquidus curve) is the temperature-composition curve of the liquid phase and is therefore the freezing point curve; it represents "the beginning of freezing." The **solidus** (or solidus curve) is the temperature-composition curve of the solid mixture and is therefore the melting point curve; it corresponds to the "beginning of melting" on heating or to the "end of freezing" on cooling the system. In Fig. I, 12, 1 the liquidus curve is *ACB*, whilst the solidus curve is *ADCEB*. These curves divide the figure into regions which contain the phases indicated in the diagram, and the composition of the system represented by any point can be easily ascertained. Thus the point *x* (Fig. I, 12, 1) is a mixture of solid *B* ($\equiv y$) and liquid of composition *z*: the proportion of liquid to solid is given by the ratio of the distance xy/yz .

I,13. Construction of equilibrium diagrams. It is interesting to consider how a complete equilibrium diagram (including solidus and

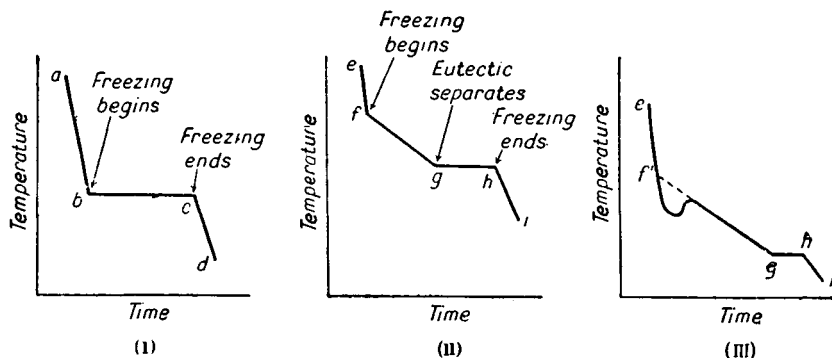

Fig. I, 13, 1.

liquidus curves) may be constructed. For simplicity, only the system considered in the previous Section will be studied. The procedure is known as the **cooling curve method**. When a pure substance is allowed to cool slowly and the temperature observed at definite intervals of time, a cooling curve may be constructed, e.g., *ab* in Fig. I, 13, 1, i. When the freezing point is reached, if supercooling is absent, solid will commence to separate out and the temperature will remain constant until all the liquid has solidified (*bc* in Fig. I, 13, 1, i). With further cooling of the solid phase, the temperature will fall steadily as indicated by *cd*. If, however, a solution is allowed to cool slowly and the cooling curve similarly determined, a continuous curve *ef* (Fig. I, 13, 1, ii) is obtained as long as the solution is entirely liquid. When a solid phase commences to form, the heat of fusion will be liberated so that at the point *f* the rate of cooling will be checked. Since the composition of the solution changes with the separation of the solid phase, the temperature will not remain constant but will gradually fall until the eutectic is reached (*fg*). At the eutectic

point both components crystallise out as a eutectic mixture and the temperature remains constant until complete solidification has occurred (line *gh*). After complete solidification of the mixture the fall in temperature of the system becomes uniform (line *hi*) until the room temperature is reached. It is clear from what has already been said that the cooling curve of the eutectic mixture will be similar to (i)—that of a pure substance. The points *b*, *f* and *g* at which a “break” occurs in the cooling curve are called “arrests” or “arrest points” of the cooling curve.

The separation of the solid phase does not occur readily with some liquid mixtures and supercooling is observed. Instead of an arrest in the cooling curve at *f'*, the cooling continues along a continuation of *ef'* and then rises suddenly to meet the line *f'g* which it subsequently follows (Fig. 1, 13, 1, iii). The correct freezing point may be obtained by extrapolation of the two parts of the curve (as shown by the dotted line). To avoid supercooling, a few small crystals of the substance which should separate may be added (the process is called “seeding”); these act as nuclei for crystallisation.

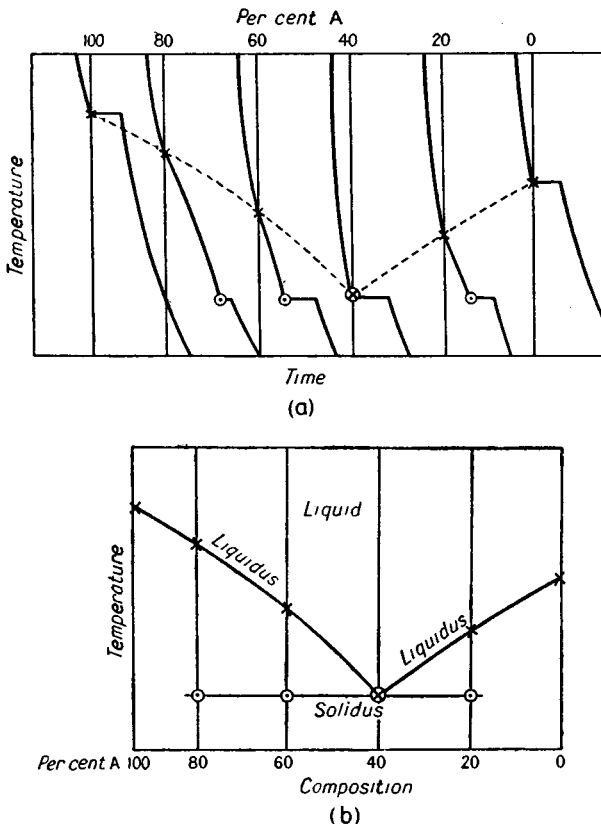

Fig. 1, 13, 2.

By constructing cooling curves for several mixtures of different composition, the total weight of the mixture being kept the same in each case, a series of cooling curves may be obtained which may be employed for the construction of the equilibrium diagram. Thus in Fig. 1, 13, 2, a,

the cooling curves obtained with various mixtures of the two components *A* and *B* are shown. The first and last curves refer to pure *A* and pure *B* respectively, whilst the other curves are for mixtures of 80 per cent. *A* and 20 per cent. *B*, 60 per cent. *A* and 40 per cent. *B*, 40 per cent. *A* and 60 per cent. *B*, and 20 per cent. *A* and 80 per cent. *B*. By joining the first arrest points (represented by crosses) the liquidus curve is obtained, whilst the solidus curve is obtained by drawing a line through the second arrest points (denoted by circles; see Fig. 1, 13, 2, *b*). In practice, it is only necessary to plot the arrest temperatures against the composition, but it is believed that Fig. 1, 13, 2 brings out clearly the connexion between cooling curves and the equilibrium diagram for the system under discussion, and is therefore of considerable interest.

Another procedure, known as the **thaw-melt method**, is available for the construction of equilibrium diagrams; it involves heating, instead of

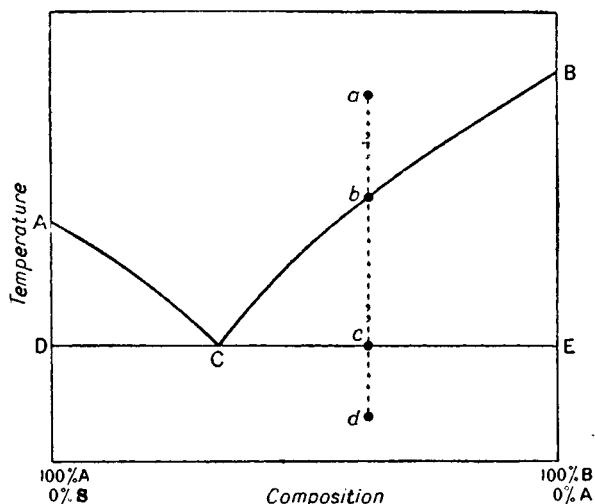

Fig. 1, 13, 3.

cooling, mixtures of known composition. This has certain advantages over the cooling curve method, particularly in those cases where super-cooling is serious and also where the quantity of material is limited. Let us consider, for example, a system of composition represented by the line *ad* (Fig. 1, 13, 3), where *d* denotes the system completely solidified and *a* the same system completely liquefied, *i.e.*, above its melting point. If the temperature of the solid expressed by *d* is slowly raised, no change will occur until the point *c*, the eutectic temperature, is reached; liquid of composition *C* will then commence to form. As the temperature is raised from *c* to *b*, the quantity of liquid increases and its composition changes from *C* to *b*; at *b* the last trace of solid is about to disappear and above *b* the system is completely liquid. This forms the basis of the thaw-melt procedure. A mixture of known composition—made by melting (to ensure thorough mixing), cooling and then powdering—is placed in a wide capillary tube (of about 2 mm. diameter) and the powder well pressed down with a thin glass rod or platinum wire so that the material

occupies 3–5 mm. at the bottom of the tube. The tube is then placed in a well-stirred bath of a suitable liquid and the temperature slowly raised. The temperature at which the first minute drops of liquid appear (*i.e.*, at *c*), the so-called **thaw point**, is the eutectic temperature for the given mixture. The mixture is heated further and the temperature at which the last trace of solid just disappears (*i.e.*, at which the fused mass becomes perfectly clear) is taken as the melting point (*b*). The thaw points and melting points of other mixtures, as well as of the pure components, are determined in the same way. Thaw points and melting points are then plotted against composition. The curve obtained by joining the thaw points is the *solidus* and that obtained by joining the melting points is the *liquidus*. Only a pure substance, or a mixture having the composition of the eutectic, melts sharply at a definite temperature. The thaw-melt procedure demonstrates very clearly why an impure substance may melt over a considerable range of temperature. The system (Section I,12), just studied in considerable detail, in which the components are completely miscible in the liquid state and the solid phases consist of the pure components, is very common with many pairs of organic and inorganic substances. Examples are given in the following table.

A	B	EUTECTIC
α -Naphthol, m.p. 95·5°	Naphthalene, m.p. 80°	M.p. 61°
Camphor, m.p. 179°	Naphthalene, m.p. 80°	M.p. 32·3°
Diphenylmethane, m.p. 27°	Naphthalene, m.p. 80°	M.p. 14°
Benzoic acid, m.p. 122°	Cinnamic acid, m.p. 133°	M.p. 82°
<i>o</i> -Nitrophenol, m.p. 44°	<i>p</i> -Toluidine, m.p. 43°	M.p. 15·5°
Antimony, m.p. 630°	Lead, m.p. 327°	M.p. 246°
Bismuth, m.p. 271°	Cadmium, m.p. 321°	M.p. 146°
Gold, m.p. 1063°	Thallium, m.p. 303°	M.p. 131°

I,14. System in which the two components form a compound possessing a congruent melting point. This system, which occurs less frequently than that of Section I,12, is of considerable interest. The equilibrium diagram depicted in Fig. I, 14, 1 (for benzophenone and diphenylamine) is an illustration of a system in which the two components form a compound possessing a congruent melting point, *i.e.*, capable of existing as a solid compound in equilibrium with a liquid of the same composition. Point *A* is the melting point of benzophenone (47·7°) and *B* that of diphenylamine (52·8°). When diphenylamine is added to benzophenone, the freezing point is lowered along the curve *AC*. At *C* (31·9°) there is the first eutectic point where benzophenone and the addition compound $\{(C_6H_5)_2CO.(C_6H_5)_2NH\} \equiv D$ separate together as a eutectic mixture. Further addition of diphenylamine raises the freezing point to a maximum at *D* (40·2°). At *D*, the composition of the liquid and solid phases are identical, and this maximum temperature is therefore the congruent melting point of the addition compound. In a similar manner the freezing point of diphenylamine (*B*) is lowered by the addition of benzophenone as indicated by the curve *BE*. The point *E* is the second eutectic point, where a eutectic mixture of diphenylamine and the addition

compound separates. Further addition of benzophenone results in the freezing point rising along ED to a maximum at D , the melting point of the addition compound.

The liquidus consists of the curves AC , CDE and EB ; the solidus comprises the horizontal lines FCG and $HJEJ$ as well as the vertical

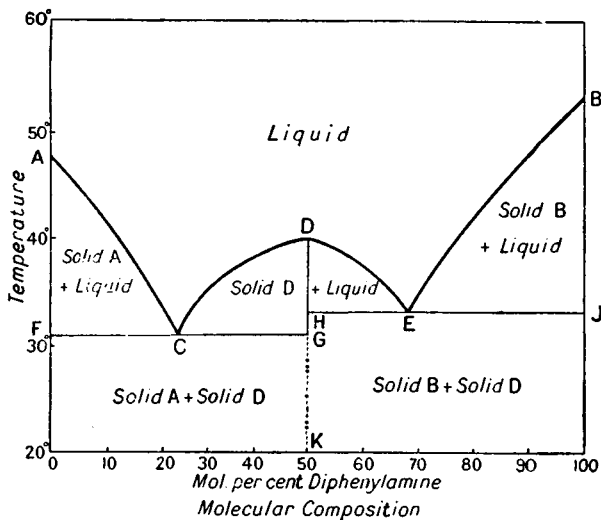

Fig. I, 14, 1.

lines FA , JB and GD . The areas have the significance indicated in the figure. The details of the phase diagram can be best understood and the behaviour of various systems on cooling or heating readily predicted by regarding it as composed of two diagrams of the simple eutectic type (Fig. I, 12, 1) placed side by side with the dividing line at DK . To the

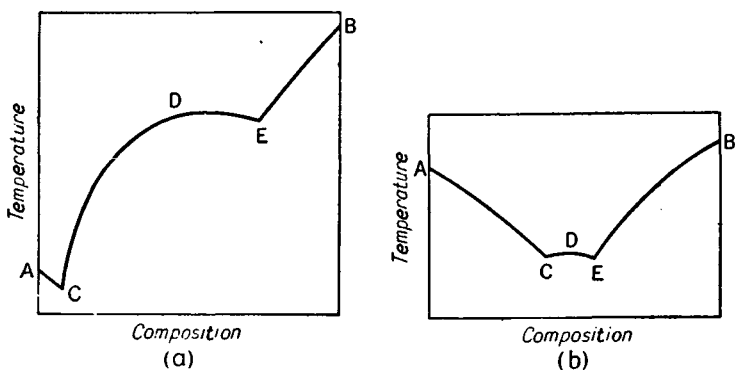

Fig. I, 14, 2.

left of the dividing line the figure gives the equilibria of the two component system A and compound D , whereas to the right of the line the components may be regarded as D and B .

It is clear from the figure that the presence of a stable compound is characterised by (i) a maximum point on the liquidus, (ii) a meeting

point of the solidus and liquidus, and (iii) the existence of a eutectic point on either side of the maximum. The melting point of the compound may be above, below or between those of the two components. If the compound is not completely stable but tends to decompose (dissociate) into its components in the liquid state, the melting point will be lowered by the products of decomposition. The shape of the middle branch of the curve will therefore give a rough indication of the stability of the compound. The greater the stability of the compound the sharper is the maximum and, usually, the larger is the central branch *CDE* of the curve as in Fig. I, 14, 2, *a* (e.g., phenol and picric acid). A flat maximum and a small *CDE* curve indicate considerable decomposition of the addition compound into its components as in Fig. I, 14, 2, *b* (e.g., naphthalene and *m*-dinitrobenzene). Other examples of this system are collected in the following table.

SUBSTANCE A	SUBSTANCE B	COMPOUND D	EUTECTICS
Phenol, m.p. 40·4*	α -Naphthylamine, m.p. 48·3°	<i>AB</i> , m.p. 28·8°	16·0° (66·5 % <i>A</i>), 24·0° (32 % <i>A</i>)
Phenol, m.p. 40·4°	<i>p</i> -Toluidine, m.p. 43°	<i>AB</i> , m.p. 28·5°	8·0° (76 % <i>A</i>), 19·9° (31 % <i>A</i>)
Phenol, m.p. 40·4°	Picric acid, m.p. 122·5°	<i>AB</i> , m.p. 83·1°	36° (94 % <i>A</i>), 80·6° (42 % <i>A</i>)
α -Naphthol, m.p. 93·9°	<i>p</i> -Toluidine, m.p. 43°	<i>AB</i> , m.p. 53·7°	50·2° (60 % <i>A</i>), 30·3° (19 % <i>A</i>)

I,15. System in which the two components form a compound with an incongruent melting point. In this system the compound formed

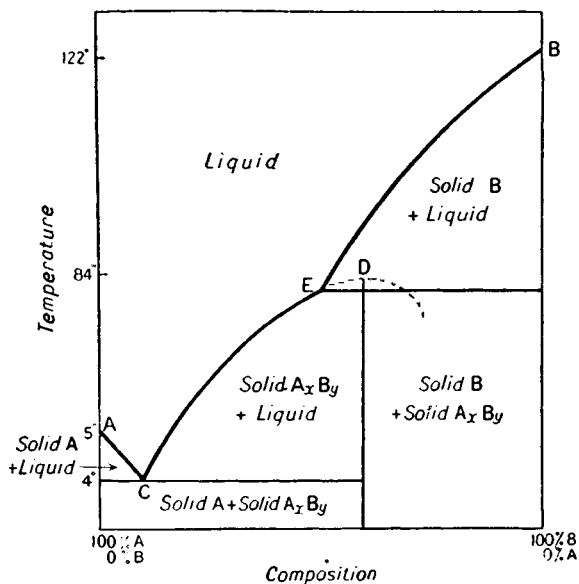

Fig. I, 15, 1.

is so unstable that it decomposes *completely* at a temperature below its melting point, so that the solid cannot be in equilibrium with a liquid of the same composition as itself—in other words, it has no true melting point. Such a system is exemplified by benzene and picric acid: the equilibrium diagram is shown in Fig. I, 15, 1 (for clarity, the illustration is not drawn to scale). The point *A* is the melting point of benzene, *B* that of picric acid, and *C* that of the eutectic composed of solid benzene and the addition compound (represented by the symbol A_xB_y). The curve *CE* is the equilibrium curve for the compound A_xB_y —in the example under consideration $x = 1$ and $y = 1$ —with the submerged maximum at *D*. The point *D* is not realised in practice because the compound decomposes completely at *E* into solid picric acid and liquid benzene. The point *E* is spoken of as the *incongruent melting point* of the compound (since the composition of the liquid is not the same as that of the original compound) or as the *transition point*. The curve *EB* represents the equilibrium between solid *B* and the liquid. This system is rarely encountered among compounds, but other examples are acetamide - salicylic acid and dimethylpyrone - acetic acid; it is, however, comparatively common in alloy systems (e.g., gold - antimony, $AuSb_2$).

I,16. System in which the two components form a continuous series of solid solutions. In all the preceding examples the individual components (*A* or *B* or A_xB_y) form separate crystals when solidifying from the melt. There are, however, a number of examples of the separation of a homogeneous solid solution of *A* and *B* (or *A* and A_xB_y , etc.).

Before studying the equilibrium diagrams of these systems, the significance of the term solid solution must be made clear. A solid may dissolve completely in another solid to form a solid solution in a manner analogous to the dissolution of one liquid in another to yield a liquid solution. The solid thus obtained is perfectly homogeneous and has been called *mixed crystals* or *isomorphous mixtures*; these two terms may suggest heterogeneity and it is therefore better to employ the expression solid solution, proposed by van't Hoff in 1890. The phenomenon is different from the process of ordinary solution in a liquid since a liquid has no space lattice of its own. The formation of a solid solution involves the structural dissolution of one solid by another crystalline solid: this process entails, particularly for inorganic compounds, the spatial marshalling of the one in the other with respect to a definite space lattice, and the resulting solid solution therefore behaves as a single entity. The physical properties of solid solutions are continuous functions of their percentage composition. The conditions which must generally be satisfied in the case of pairs of non-polar organic compounds are: (a) their chemical constitution must be analogous, (b) their molecular volumes must be approximately equal, and (c) their crystal structures must be similar.

The general case of two compounds forming a continuous series of solid solutions may now be considered. The components are completely miscible in the solid state and also in the liquid state. Three different types of curves are known. The most important is that in which the freezing points (or melting points) of all mixtures lie between the freezing points (or melting points) of the pure components. The equilibrium diagram is shown in Fig. I, 16, 1. The liquidus curve portrays the composition of the liquid phase in equilibrium with solid, the composition of

which is given by the solidus curve. The composition of the solid phase changes continuously with that of the liquid from which it separates. It is found experimentally, and can also be deduced theoretically, that at any temperature the concentration of that component by the addition

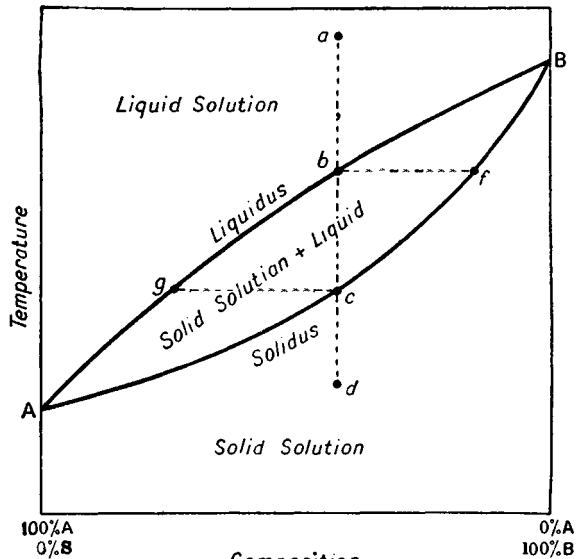

Fig. I, 16, 1.

of which the freezing point is depressed is greater in the liquid than in the solid phase. It is evident from the figure that upon cooling a fused mixture of two substances capable of forming solid solutions, the temperature of solidification (freezing point) will not remain constant during the separation of the solid, nor will the temperature of liquefaction (melting point) of the solid solution be constant. Thus, for example, if a liquid solution of composition *a* is allowed to cool very slowly (so as to ensure equilibrium conditions as far as possible), a solid of composition *f* will separate at *b*. As the temperature continues to fall, more and more solid will be deposited and, since the solid phase is relatively richer in *B*, the liquid will become richer in *A*. The composition of the liquid will therefore pass along *bg*; the composition of the solid will at the same time follow the curve *fc*. At the point *c*, the last traces of liquid of composition *g* are just disappearing and solidification is complete. The cooling curve will have the shape shown in Fig. I. 16, 2; solid commences to separate at *b* and solidification is complete at *c*. There is no complete arrest, only a change in the rate of cooling during the separation of the solid.

If a mixture of composition *d* is slowly heated (as in the thaw-melt

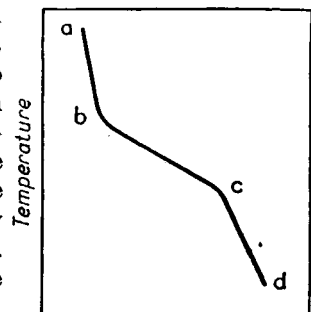

Fig. I, 16, 2.

method), it will commence to melt at the temperature c (i.e., the first drops of liquid will appear) with the production of liquid of composition g . Thereafter, as the temperature of the mass rises, more of the solid will melt and the composition of the solid and liquid will change as represented by the curves cf and gb respectively. Finally, when the temperature has reached b , complete liquefaction will have occurred. The process of melting or freezing thus extends over the temperature interval bc . Examples of this system are β -naphthol, m.p. 122° - naphthalene, m.p. 80° , and α -monochlorocinnamic aldehyde, m.p. 31.2° - α -monobromocinnamic aldehyde, m.p. 69.6° .

Two other types of equilibrium curves are occasionally encountered with the system of two components forming a continuous series of solid solutions. These are shown in Figs. I, 16, 3 and I, 16, 4. In the former the freezing or melting curve passes through a minimum (examples: p -chloriodobenzene, m.p. 57° - p -dichlorobenzene, m.p. 53° ; naphtha-

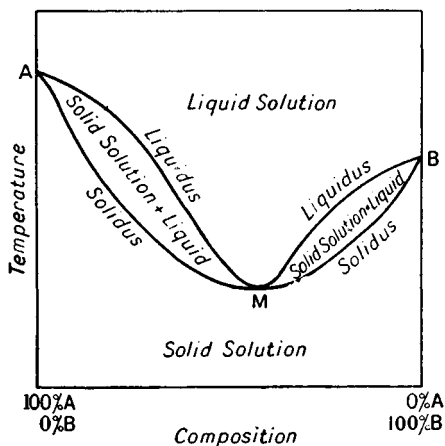

Fig. I, 16, 3.

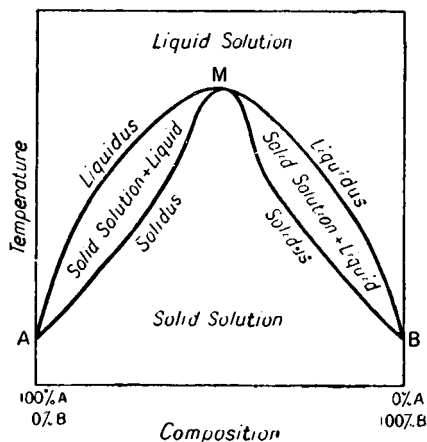

Fig. I, 16, 4.

lene, m.p. 80° - β -naphthylamine, m.p. 112°), and in the latter it passes through a maximum (example: d - and l -carvoxime, m.p. 72°).

I,17. Mixed melting points. In the majority of cases the presence of a "foreign substance" will lower the melting point of a pure organic compound. This fact is utilised in the so-called mixed melting point test for the identification of organic compounds. Let us suppose that an unknown compound X is supplied which is suspected to be o -chlorobenzoic acid since its melting point is 140° . This is tested for by intimately mixing together approximately equal weights of X and an authentic specimen of o -chlorobenzoic acid (A) and determining the melting point of the mixture. If the melting point is still 140° , then X is o -chlorobenzoic acid, but if the melting point is depressed by several degrees A and X cannot be identical. It is recommended that at least three mixtures containing, say, 10 per cent. X + 90 per cent. A , 50 per cent. X + 50 per cent. A , and 90 per cent. X + 10 per cent. A be prepared, and the melting points be determined. Alternatively, if time permits, the complete melting point curve (i.e., the temperature at which the mixture

liquefies completely) may be determined by the thaw point method (Section I, 13)—this will supply more information than mere evidence of non-identity, should this be desired.

Cases may arise in which the melting point of certain mixtures are higher than the individual components, *e.g.*, if an addition compound of higher melting point is formed (compare Fig. I, 14, 1) or if the two compounds are completely soluble in the solid state forming solid solutions (compare Figs. I, 16, 1 and I, 16, 4). Furthermore, for certain optical isomers, *e.g.*, *d*- and *l*-camphoroximes and for *d* and *l*-borneol, there is no depression in the melting point, the freezing or melting points of all mixtures being the same as the pure components. It will be seen, therefore, that the mixed melting point test, although of great practical value, is not infallible and should accordingly be used with reasonable regard to these possibilities.

I, 18. System in which the solid phases consist of the pure components and the components are only partially miscible in the liquid state. In concluding the discussion on the theory of melting and freezing, the system in which the two components are only partially miscible in the liquid state and the solid phases consist of the pure components will be considered. In all the previous cases the components were completely miscible in the liquid state, but examples are known (*e.g.*, succinonitrile and water) where, over a limited range of concentration, the liquids are partially miscible and two liquid phases are formed. The equilibrium diagram of a such a system is presented in Fig. I, 18, 1 (for the sake of clarity, this has not been drawn to scale; the salient features have been exaggerated). Point *A* is the melting point of succinonitrile and *B* that of ice. If succinonitrile (*A*) is added to ice at *B*, the freezing point will fall along *BC*, ice (solid *B*) separating; ultimately the temperature of the eutectic *C* (-1.2°) will be reached. If the temperature is now raised slightly so that the eutectic mixture just melts and the addition of *A* is continued, the concentration of *A* in the solution will increase (curve *CD*) and the solid phase in equilibrium with the solutions denoted by *CD* will be *A* (succinonitrile). At the point *D* (18.5°), solid *A* melts and two liquid phases make their appearance. This is the well-known phenomenon of melting under the solvent or the separation of an "oil" during the recrystallisation of a pure substance from a solvent. The compositions of the two liquid phases are represented by the points *D* and *E* and there will be, in addition to the vapour, three phases present, *viz.*, *A* (the solid succinonitrile), solution of liquid *A* in *B* (water) and of *B* in liquid *A*. The temperature t_0 is therefore a quadruple point (*i.e.*, four phases coexist). The addition of more *A* will result in a change of the relative amounts of the two layers—increased amount of *B* in liquid *A*, decreased amount and eventual disappearance of liquid *A* in *B*—the temperature remaining constant (*DE*). At *E* only one liquid phase is present; with further addition of *A*, the equilibrium temperature rises as expressed by *EA*.

If the system represented by the point *D* be heated, the solid *A* will disappear and two partially miscible liquids will remain. The curve *ETD* is the ordinary solubility curve for two partially miscible liquids (compare Section I, 8, Fig. I, 8, 1). As the temperature rises, the mutual

solubility of the two components increases until at the critical solution, temperature T (55.5°) they become miscible in all proportions. At all temperatures above the curve $BCDTEA$ there is only one liquid phase; at temperatures between D and T , mixtures of total composition denoted by points inside the area DTE will separate into two liquid phases.

The equilibrium diagram expresses in shorthand form the behaviour of all mixtures upon heating or cooling. Thus, let us examine the effect of cooling a homogeneous liquid mixture of composition expressed by the point a . Two layers (conjugate solutions) commence to form at b , the compositions of which are given by b and b' ; with further cooling, the compositions follow the curves bE and $b'D$ respectively. When the composition of the system as a whole is expressed by the point c , the

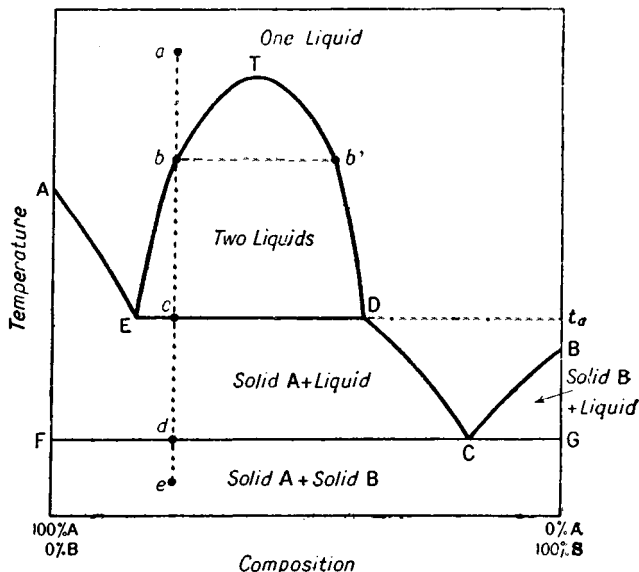

Fig. I, 18, 1.

compositions of the liquid layers are at E and D : solid A then commences to separate, the relative amount of the liquid layer richer in B (i.e., D) increases and eventually the layer E disappears. The temperature remains constant up to the point of the disappearance of the two layers. Thenceforth the temperature falls gradually from c to d , and the composition follows DC , solid A separating. At C , the eutectic point, the other solid B deposits and the temperature again remains constant until the liquid has disappeared. The solid mixture of A and B then cools slowly along de . The behaviour of any other system to the left of the curve $AETD$ will be obvious from what has already been said; systems to the right of D behave normally like those of which the components are completely miscible in the liquid state and the solid phases consist of pure components (Section I,12). For this reason the recrystallisation of a substance which tends to "melt under the solvent" should be confined to the area of composition to the right of the point D .

Examples of solid - liquid systems with two liquid layers are given below : the temperature t_q is the temperature at which the two layers separate or the quadruple point.

COMPONENT A	COMPONENT B	t_q
Water, m.p. 0°	Acetanilide, m.p. 114°	83°
Water, m.p. 0°	Succinonitrile, m.p. 54°	18.5°
Water, m.p. 0°	Benzoic acid, m.p. 121°	98°
Water, m.p. 0°	Phenol, m.p. 43°	1.7°
Benzene, m.p. 5°	Resorcinol, m.p. 110°	95.5°

I,19. THEORY OF SUBLIMATION

The processes of distillation and sublimation are closely related. There are three ways in which the vaporisation of a thermally stable substance may take place on heating :—

(i) If the substance is liquid under ordinary conditions, it may boil at a definite temperature depending upon the pressure.

(ii) If the substance is solid under ordinary conditions, it may first melt at a definite temperature and, upon rise of temperature, boil like an ordinary liquid.

(iii) If the substance is solid under ordinary conditions, it may volatilise without melting, at a definite temperature depending upon the pressure.

The condensation of the vapour of a stable substance may, likewise, take place in three ways :—

(i) There may be liquefaction only.

(ii) Liquefaction may take place first, followed by solidification.

(iii) The vapour may pass directly, without the intermediate formation of a liquid, into the solid state.

The term **distillation** is applied to vaporisation and subsequent condensation according to (i) ; it should also be applied to (ii) since it is really the liquid which is converted into vapour and is first formed by condensation. Strictly speaking, the term **sublimation** should be applied to changes according to (iii). However, in practice, a substance when heated may first melt and then boil, but on cooling it may pass directly from the vapour to the solid : the process is then also called sublimation. Indeed the mode of vaporisation, whether directly from solid to vapour or through the intermediate formation of a liquid, is of secondary importance ; it is the direct conversion of vapour to solid which is really the outstanding feature of sublimation in the laboratory.

To understand the conditions which control sublimation, it is necessary to study the solid - liquid - vapour equilibria. In Fig. I, 19, 1 (compare Fig. I, 10, 1) the curve TW is the vapour pressure curve of the liquid (*i.e.*, it represents the conditions of equilibrium, temperature and pressure, for a system of liquid and vapour), and TS is the vapour pressure curve of the solid (*i.e.*, the conditions under which the vapour and solid are in equilibrium). The two curves intersect at T : at this point, known as the triple point, solid, liquid and vapour coexist. The curve TV represents the

temperatures and pressures at which the solid and liquid can be in equilibrium, that is, it indicates the influence of pressure upon the melting point. This curve meets the other curves at the triple point T .

The normal melting point of a substance is the temperature at which solid and liquid are in equilibrium at atmospheric pressure. At the triple point, the pressure is the equilibrium vapour pressure of the system (solid - liquid - vapour) and the temperature differs from the melting point. The difference is, however, quite small—usually only a fraction of a degree—since the line TV departs only slightly from the vertical within reasonable ranges of pressure.

It is clear that if the vapour at a pressure below the triple point is reduced sufficiently in temperature, it will condense directly to the solid form, or, sublimation will ensue. In order that a solid may pass directly

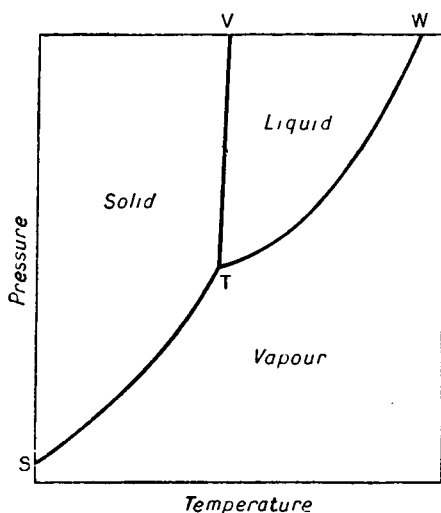

Fig. 1, 19, 1.

into vapour without the intermediate formation of a liquid phase, the pressure of the vapour must not be allowed to exceed that of the triple point. This can easily be done if the vapour pressure at the triple point is fairly high and consequently the rate of vaporisation will be considerable; the conditions are then favourable for the purification of the solid by sublimation at atmospheric pressure. Thus, if camphor (triple point, 179° ; equilibrium pressure, 370 mm.) is slowly heated below 179° , it will vaporise without melting and, if the vapour is deposited on a cooled surface, the pressure will be kept below 370 mm. so that vaporisation will continue until the solid has disappeared. Condensation takes place on the cold surface directly as the solid because the pressure is below that at the triple point.

If the triple point pressure of a solid is below one atmosphere, it will melt if the heating is conducted rapidly so that the vapour pressure can exceed that at the triple point. If camphor is heated in a closed space, the vapour pressure increases and when the value of 360 mm. is reached, the solid will melt; further heating results in an increase in the vapour pressure and the camphor will boil when the vapour pressure is 760 mm.

For substances with a moderate triple point pressure (e.g., benzoic acid, 6 mm., m.p. 122° ; naphthalene, 7 mm., m.p. 80° *), the simple process described above for camphor will not give a satisfactory yield of a sublimed product. Thus, for example, if naphthalene is heated it will melt at T (80°), and will boil when the vapour pressure is 760 mm. (218°);

* For most practical purposes the temperature and pressure at the triple point may be regarded as not differing appreciably from the melting point and the vapour pressure at the melting point respectively.

it will be necessary to maintain the compound at about this temperature if any substantial quantity is to be completely converted into vapour. Upon cooling the vapour, naphthalene will deposit as a liquid until the temperature T' (Fig. I, 19, 1) is reached (the vapour pressure is then 7 mm.) and thenceforth as a solid. To improve the yield of sublimate, the pressure in the system must be reduced; this may be done by exhausting the apparatus with a pump. In the present and similar cases, a simpler procedure is to dilute the vapour with an inert gas (carbon dioxide or nitrogen). This dilution will reduce the partial pressure of the substance and also simultaneously cool the vapour; the sublimed crystals are collected in a cooling chamber, where they deposit usually in a finely-divided form. True sublimation can occur only when the partial pressure of the vapour of the substance is lower than its triple point pressure. Substances with low vapour pressures at their melting points can only be satisfactorily sublimed under greatly diminished pressure.

Two cases of direct sublimation at atmospheric pressure are worthy of mention. Hexachloroethane has a triple point temperature of 186° and a triple point pressure of 780 mm. Complete sublimation can therefore be easily effected by merely heating to about 185° (the vapour pressure is 760 mm. at 185°). The melting point of this substance is most satisfactorily determined in a sealed capillary tube. The triple point temperature and pressure of carbon dioxide are -56.4° and 5.11 atmospheres respectively. This means that liquid carbon dioxide can only be formed if the pressure exceeds 5.11 atmospheres. If liquid carbon dioxide, from a cylinder, is allowed to escape into the air (best into a cloth bag tied to the nozzle of the cylinder), it absorbs so much heat during the rapid evaporation that part of it is frozen into a snow-like solid. Commercially, the carbon dioxide "snow" is compressed hydraulically into slabs of *Dry Ice* or *Drikold*. The solid evaporates comparatively slowly, owing to its high latent heat (87.2 cal. per gram), its high density (1.56), and the fact that it is surrounded by an insulating layer of heavy vapour. The solid will pass directly into the gas since atmospheric pressure is well below the triple point pressure. Solid carbon dioxide (*Dry Ice*; *Drikold*) has the following advantages over ice as a refrigerant:—

- (1) As already stated, it passes directly into the vapour.
- (2) It can produce a lower temperature (-78°).
- (3) It occupies less space.
- (4) It forms excellent freezing mixtures with many organic liquids, e.g., with alcohol, -72° ; with ether, -77° ; and with chloroform, -77° .
- (5) It has a higher latent heat and a greater density producing an over-all cooling effect which is about twice as efficient as ordinary ice.

120. THEORY OF THE ACTION OF DRYING AGENTS

Drying agents may be divided broadly into (a) those which combine with water reversibly and (b) those which react chemically with water by a non-reversible process giving rise to a new water-free compound. Sodium, calcium carbide and phosphorus pentoxide belong to the latter class and will be discussed in Section II,39.

To appreciate the action of a drying agent of class (a), let us imagine some anhydrous copper sulphate in an evacuated vessel provided with a pressure gauge, and water is allowed to enter slowly; the temperature is assumed constant at 25° . The results may be best expressed by means of a vapour pressure - composition diagram (Fig. I, 20, 1). The initial system is represented by the point *A*; the pressure will rise along *AB* until the monohydrate $\text{CuSO}_4 \cdot \text{H}_2\text{O}$ commences to form at *B*.

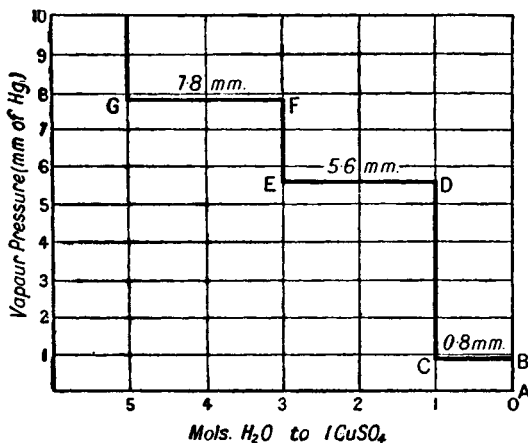
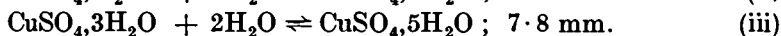
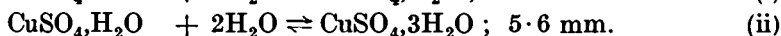
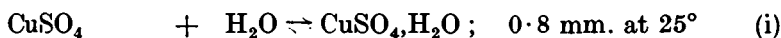

Fig. I, 20, 1.

At this point the system has three phases (CuSO_4 ; $\text{CuSO}_4 \cdot \text{H}_2\text{O}$; H_2O vapour) and the number of components is two (anhydrous salt; water). Hence by the phase rule, $P + F = C + 2$, i.e., $3 + F = 2 + 2$, or $F = 1$. The system is consequently univariant, in other words, only one variable, e.g., temperature, need be fixed to define the system completely; the pressure of water vapour in equilibrium with CuSO_4 and $\text{CuSO}_4 \cdot \text{H}_2\text{O}$ should be constant at constant temperature.

As more water vapour is absorbed by the system, the pressure remains constant along *BC* until the anhydrous salt is completely converted into the monohydrate. The conversion is complete at *C*: the pressure then rises along *CD* until the trihydrate is formed at *D*. Two solid phases ($\text{CuSO}_4 \cdot 3\text{H}_2\text{O}$; $\text{CuSO}_4 \cdot \text{H}_2\text{O}$) are now present and the pressure remains constant until all the monohydrate is transformed into the trihydrate at *E*. The pressure again rises to *F*, and when it attains the value denoted by *F*, the pentahydrate commences to form and the system has a constant pressure until all the trihydrate has passed into the pentahydrate at *G*. The same curves are obtained if copper sulphate pentahydrate is dehydrated at constant temperature (25°): here the powdered crystals of the pentahydrate are contained in a vessel and the water vapour is gradually removed by means of a pump. The pressure remains constant along *GF* whilst the pentahydrate is being converted into trihydrate; at *F* only the trihydrate is present. A sharp drop in pressure to *E* then occurs and along *ED* the trihydrate passes at constant pressure into the monohydrate. This change is complete at *D*, the pressure falls again to *C*, at which point dissociation of the monohydrate to the anhydrous salt occurs. This transformation is complete at *B*, and, with the complete removal of the water, the pressure drops to almost zero at *A*.

It is evident from these results that three equilibria are to be considered, viz. :—



Furthermore, it is the system, Hydrate I/Hydrate II (or Anhydrous Salt), that possesses a definite pressure at a particular temperature ; this is independent of the relative amounts, but is dependent upon the nature of the two components in equilibrium. It is incorrect, therefore, to speak of the "vapour pressure of a salt hydrate."

Similar results are obtained at other temperatures, e.g., at 50° , the above three systems give equilibrium vapour pressures of 4.5, 30.9 and 45.4 mm. respectively. There is some evidence for the existence of a tetrahydrate $\text{CuSO}_4 \cdot 4\text{H}_2\text{O}$, but this does not affect the general nature of the change described above. At temperatures higher than about 102° , the pentahydrate is unstable and $\text{CuSO}_4 \cdot 3\text{H}_2\text{O}$ is the first stable hydrate.

We may now understand the nature of the change which occurs when an anhydrous salt, say copper sulphate, is shaken with a wet organic solvent, such as benzene, at about 25° . The water will first combine to form the monohydrate in accordance with equation (i), and, provided sufficient anhydrous copper sulphate is employed, the effective concentration of water in the solvent is reduced to a value equivalent to about 1 mm. of ordinary water vapour. The complete removal of water is impossible ; indeed, the equilibrium vapour pressures of the least hydrated system may be taken as a rough measure of the relative efficiencies of such drying agents. If the water present is more than sufficient to convert the anhydrous copper sulphate into the monohydrate, then reaction (i) will be followed by reaction (ii), i.e., the trihydrate will be formed ; the water vapour then remaining will be equivalent to about 6 mm. of ordinary water vapour. Thus the monohydrate is far less effective than the anhydrous compound for the removal of water.

Magnesium sulphate is a useful drying agent as can be seen from the following table of equilibrium vapour pressures of the various possible systems at 25° ;

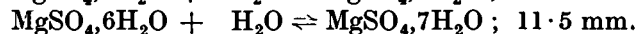
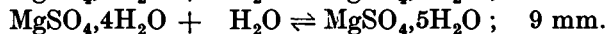
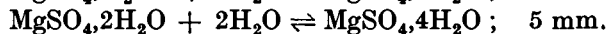
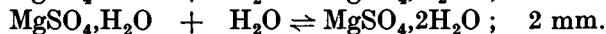
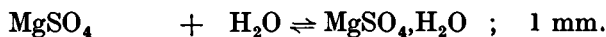

Another valuable drying agent of general application is anhydrous calcium sulphate, marketed under the name of "*Drierite*." It is rapid in its action, but has only a limited drying capacity because it forms the hydrate $2\text{CaSO}_4 \cdot \text{H}_2\text{O}$ and thus combines with only 6.6 per cent. of its weight of water. The vapour pressure of the system :

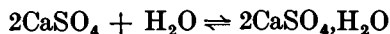

is only 0.004 mm. at about 25°. The residual water content is therefore very low, and the substance may be employed for drying alcohols, esters, ketones, acids, etc. If the water content of the organic substance is somewhat high, a preliminary drying with another desiccant such as anhydrous magnesium or sodium sulphate, which can absorb a higher proportion of water, is recommended.

A rough method for comparing the drying powers of the common desiccants consists in passing moist air over the drying agent maintained at a constant temperature and then determining the residual moisture with phosphorus pentoxide—the most efficient drying agent known. Some results, due largely to Bower (1934), are tabulated below.

RESIDUAL WATER VAPOUR PER LITRE OF AIR AT 30.5°

MATERIAL	RESIDUAL WATER (MG.)	MATERIAL	RESIDUAL WATER (MG.)
Na ₂ SO ₄ , anhydrous .	12	Mg(ClO ₄) ₂ .3H ₂ O .	0.03
CuSO ₄ , anhydrous .	2.8	Silica gel . . .	0.03
CaCl ₂ , granular * .	1.5	KOH, sticks . . .	0.01
CaCl ₂ , technical		Al ₂ O ₃	0.005
anhydrous † . . .	1.25	CaSO ₄ , anhydrous	0.003
ZnCl ₂ , sticks . . .	1.0	H ₂ SO ₄	0.003
Ba(ClO ₄) ₂ , anhydrous	0.8	CaO	0.002
NaOH, sticks . . .	0.8	Mg(ClO ₄) ₂ ,	
CaCl ₂ , anhydrous		anhydrous . . .	0.002
(fused)	0.4	BaO	0.0007
H ₂ SO ₄ , 95 % . . .	0.3		

* Approximate composition : CaCl₂.H₂O. † Approximate composition : 4CaCl₂.H₂O.

As a rough approximation it may be assumed that one mg. of water contained in one litre of gas at 25–30° exerts a 1 mm. partial vapour pressure. Obviously, the lower the residual water content or the vapour pressure, the more intense is the ultimate drying capacity of the substance.

The vapour pressures of the various hydrate systems increase with temperature (compare the figures for the three copper sulphate - water systems of equations (i), (ii) and (iii) at 25° and 50° already given). It follows, therefore, that the efficiency of desiccants decreases with rise of temperature and, indeed, at high temperatures certain desiccating agents may actually undergo dehydration. Thus the vapour pressures of some calcium chloride - water systems exceed atmospheric pressure at high temperatures, as can be seen from the following table.

VAPOUR PRESSURE OF CALCIUM CHLORIDE SYSTEMS

TEMPERATURE	PRESSURE (MM.)	SOLID PHASES
-55°	0.0	Ice - CaCl ₂ .6H ₂ O
+29.2°	5.7	CaCl ₂ .6H ₂ O - β CaCl ₂ .4H ₂ O
29.8°	6.8	CaCl ₂ .6H ₂ O - α CaCl ₂ .4H ₂ O
38.4	7.9	β CaCl ₂ .4H ₂ O - CaCl ₂ .2H ₂ O
175.5°	842.0	CaCl ₂ .2H ₂ O - CaCl ₂ .H ₂ O

It follows that liquids of high boiling point should not be distilled from drying agent systems which have appreciable vapour pressures. An extreme case of this action is the dehydration of oxalic acid dihydrate by distillation over toluene or over carbon tetrachloride.

I,21. Deliquescence and efflorescence. A substance is said to deliquesce (Latin : *to become liquid*) when it forms a solution or liquid phase upon standing in the air. The essential condition is that the vapour pressure of the saturated solution of the highest hydrate at the ordinary temperature should be less than the partial pressure of the aqueous vapour in the atmosphere. Water will be absorbed by the substance, which gradually liquefies to a saturated solution ; water vapour will continue to be absorbed by the latter until an unsaturated solution, having the same vapour pressure as the partial pressure of water vapour in the air, is formed. In order that the vapour pressure of the saturated solution may be sufficiently low, the substance must be extremely soluble in water, and it is only such substances (*e.g.*, calcium chloride, zinc chloride and potassium hydroxide) that deliquesce.

In the British Isles the atmosphere is normally about two-thirds saturated and the partial vapour pressure of a well-ventilated laboratory is 12-14 mm. at about 20°. The vapour pressure of calcium chloride ($\text{CaCl}_2 \cdot 6\text{H}_2\text{O} - \text{CaCl}_2 \cdot 4\text{H}_2\text{O}$) at room temperature is about 4 mm., that of the saturated solution about 7-8 mm., and 100 grams of water will dissolve 74.5 grams of the hydrate at 20° ; it is therefore deliquescent. Sodium and potassium hydroxides possess similar properties. Copper sulphate pentahydrate, on the other hand, is not deliquescent as the vapour of the saturated solution is about 16 mm. at 20° and that of the $\text{CuSO}_4 \cdot 5\text{H}_2\text{O} - \text{CuSO}_4 \cdot 3\text{H}_2\text{O}$ system is considerably less than this (see Fig. I, 20, 1).

A salt hydrate is said to effloresce (Latin : *to blossom*) when it loses water and falls to a powder upon exposure to the atmosphere. Efflorescence will occur when the vapour pressure of the hydrate system is greater than that of water vapour in the atmosphere ; dehydration will then occur in the effort for equilibrium to be attained between the hydrate system and the surroundings. A good example is washing soda, $\text{Na}_2\text{CO}_3 \cdot 10\text{H}_2\text{O}$, which gives off water vapour with the production of the monohydrate, $\text{Na}_2\text{CO}_3 \cdot \text{H}_2\text{O}$. Other examples are the systems containing $\text{Na}_2\text{SO}_4 \cdot 10\text{H}_2\text{O}$ and $\text{Na}_2\text{HPO}_4 \cdot 12\text{H}_2\text{O}$.

It must be emphasised that deliquescence and efflorescence are relative properties, since they depend upon the actual presence of water vapour in the atmosphere, which varies considerably with place and time.

A substance is said to be hygroscopic when it attracts moisture from the atmosphere. All deliquescent compounds are consequently hygroscopic, but there are many hygroscopic substances which absorb water vapour without deliquescing. Most dry substances, particularly if in a fine powder form, are slightly hygroscopic. Substances which are commonly regarded as hygroscopic include quicklime and cupric oxide. The term is also applied to liquids : thus concentrated sulphuric acid, absolute methyl and ethyl alcohols, and deuterium oxide ("heavy water") have hygroscopic properties.

I,22. EXTRACTION WITH SOLVENTS

The process of extraction with solvents is generally employed either for the isolation of dissolved substances from solutions or from solid mixtures or for the removal of undesired soluble impurities from mixtures. The latter process is usually termed washing.

The theory of the process can best be illustrated by considering the operation, frequently carried out in the laboratory, of extracting an organic compound from its aqueous solution with an immiscible solvent. We are concerned here with the distribution law or partition law which, states that if to a system of two liquid layers, made up of two immiscible or slightly miscible components, is added a quantity of a third substance soluble in both layers, then the substance distributes itself between the two layers so that the ratio of the concentration in one solvent to the concentration in the second solvent remains constant at constant temperature. It is assumed that the molecular state of the substance is the same in both solvents.* If c_A and c_B are the concentrations in the layers A and B , then, at constant temperature :

$$c_A/c_B = \text{constant} = K.$$

The constant K is termed the distribution or partition coefficient. As a very rough approximation the distribution coefficient may be assumed equal to the ratio of the solubilities in the two solvents. Organic compounds are usually relatively more soluble in organic solvents than in water, hence they may be extracted from aqueous solutions. If electrolytes, *e.g.*, sodium chloride, are added to the aqueous solution, the solubility of the organic substance is lowered, *i.e.*, it will be salted out: this will assist the extraction of the organic compound.

The problem that arises in extraction is the following. Given a limited quantity of the solvent, should this be used in one operation or divided into several portions for repeated extractions in order to secure the best result? A general solution may be derived as follows. Let the volume, v ml., of the aqueous solution containing w_0 grams of the dissolved substance be repeatedly extracted with fresh portions of s ml. of the organic solvent, which is immiscible with water. If w_1 grams is the weight of the solute remaining in the aqueous phase after the first extraction, then the concentrations are w_1/v g. per ml. in the aqueous phase and $(w_0 - w_1)/s$ g. per ml. in the organic solvent layer. The partition coefficient K is given by :

$$\frac{w_1/v}{(w_0 - w_1)/s} = K$$

or $w_1 = w_0 \frac{Kv}{Kv + s}$

* For a theoretical treatment involving association or dissociation in one solvent, see, for example, S. Glasstone, *Text Book of Physical Chemistry*, Second Edition 1947, p. 737 (Van Nostrand; Macmillan).

Let w_2 grams remain in the aqueous layer after the second extraction, then :

$$\frac{w_2/v}{(w_1 - w_2)/s} = K$$

or

$$w_2 = w_1 \frac{Kv}{Kv + s}$$

$$= w_0 \left(\frac{Kv}{Kv + s} \right)^2$$

Similarly if w_n grams remain in the aqueous layer after the n th extraction :

$$w_n = w_0 \left(\frac{Kv}{Kv + s} \right)^n \quad (1).$$

We desire to make w_n as small as possible for a given weight of solvent, *i.e.*, the product of n and s is constant, hence n should be large and s small; in other words, the best results are obtained by dividing the extraction solvent into several portions rather than by making a single extraction with the whole quantity. It must be emphasised that the expression deduced above applies strictly to a solvent which may be regarded as completely immiscible with water, such as benzene, chloroform or carbon tetrachloride; if the solvent is slightly miscible, *e.g.*, ether, the equation (1) is only approximate, but is nevertheless useful for indicating the qualitative nature of the results to be expected.

Let us consider a specific example, *viz.*, the extraction of a solution of 4.0 g. of *n*-butyric acid in 100 ml. of water at 15° with 100 ml. of benzene at 15°. The partition coefficient of the acid between benzene and water may be taken as 3 (or $\frac{1}{3}$ between water and benzene) at 15°. For a single extraction with benzene, we have :

$$w_n = 4 \left(\frac{\frac{1}{3} \times 100}{\frac{100}{3} + 100} \right) = 1.0 \text{ g.}$$

For three extractions with 33.3 ml. portions of fresh benzene :

$$w_n = 4 \left(\frac{\frac{1}{3} \times 100}{\frac{100}{3} + 33.3} \right)^3 = 0.5 \text{ g.}$$

Hence one extraction with 100 ml. of benzene removes 3.0 g. (or 75 per cent.) of the *n*-butyric acid, whilst three extractions remove 3.5 g. (or 87.5 per cent.) of the total acid. This clearly shows the greater efficiency of extraction obtainable with several extractions when the total volume of solvent is the same. Moreover, the smaller the distribution coefficient between the organic solvent and the water, the larger the number of extractions that will be necessary.

The above considerations apply also to the removal of a soluble impurity by extraction (or washing) with an immiscible solvent. Several washings with portions of the solvent give better results than a single washing with the total volume of the solvent.

CHAPTER II

EXPERIMENTAL TECHNIQUE

II.1. COMMON ORGANIC LABORATORY APPARATUS

It will be useful at the very outset to introduce the student to the apparatus that is commonly employed in the organic laboratory. Whether he will personally handle all the types of apparatus to be described will, of course, depend (i) upon the duration of the course in practical organic chemistry and (ii) upon the facilities provided by the laboratory. Nevertheless, it is deemed advantageous that the student should, at least, know of their existence.

Flasks. Various types of flasks are shown in Fig. II, 1, 1, *a-e*.

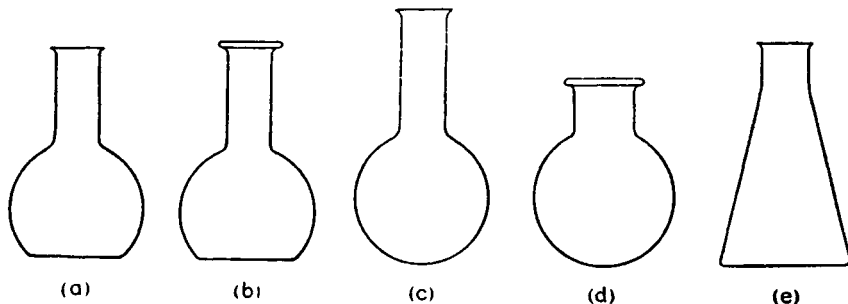

Fig. II, 1, 1.

(a) Flat-bottomed flask (the so-called Florence flask) with vial mouth. The sizes vary between 50 ml. and 40 litres.

(b) This is similar to (a) except that it is provided with a ring neck, which increases the mechanical strength, prevents breakage when a stopper is inserted, and provides a means for wiring a stopper in place. The upper rim is ground flat.

(c) Round-bottomed flask. The common sizes range between 25 ml. and 50 litres.

(d) Round-bottomed flask with short ring neck (the so-called bolt-head flask). This is widely used, particularly in advanced work, and possesses the advantages given under (b). The common sizes range between 50 ml. and 20 litres.

(e) This is the familiar Erlenmeyer or conical flask. The common sizes range between 25 ml. and 6 litres.

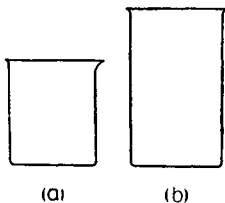

Fig. II, 1, 2.

Beakers. The usual Griffin form with spout, Fig. II, 1, 2, *a*, are widely used. Sizes between 30 ml. and 6 litres are available. The tall form without spout (Fig. II, 1, 2 *b*) occasionally finds application in organic laboratories.

Distilling flasks. Fig. II, 1, 3, *a* is the ordinary distilling flask. The sizes vary between 25 and 5,000 ml.

(*b*) is the so-called Claisen flask, a distilling flask with two necks; the thermometer is placed in the neck carrying the side arm. Sizes vary between 25 ml. and 2,000 ml. It is of particular value in distillations where foaming or bumping occurs, and is widely employed in distillations under diminished pressure.

(*c*) is identical with (*b*) except that it is provided with a second long and indented neck (which is essentially a Vigreux column—see Section II,15). It is sometimes termed a Claisen flask with fractionating side arm.

In (*d*) the side arm outlet extends a short distance into the long neck of the flask, thus preventing any vapour which has been in contact with cork or rubber stoppers from condensing and flowing down the side arm.

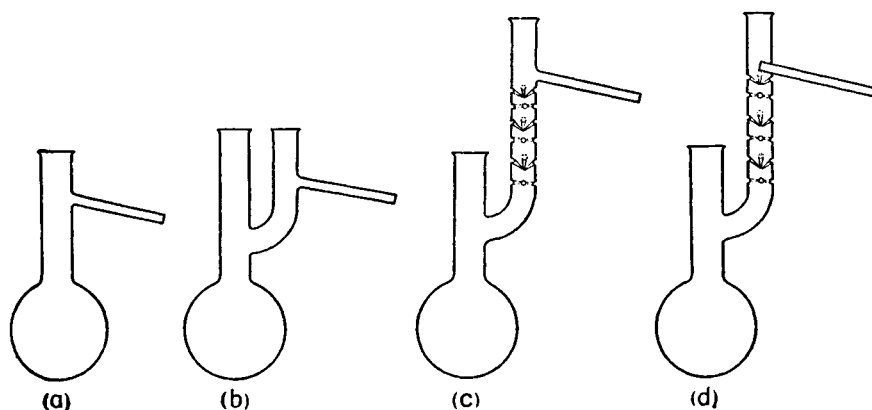

Fig. II, 1, 3.

It is usually employed for those liquids which attack cork or rubber stoppers.

Condensers. The various types in common use are shown in Fig. II, 1, 4, *a-h*.

(*a*) is a typical Liebig condenser, which consists of an inner glass tube surrounded by a glass jacket through which water is circulated. The inner jacket is fitted into the outer jacket by means of rubber stoppers; rubber tubing, formerly used, is less durable and is not recommended.

(*b*) is an all-glass Liebig condenser of similar design to (*a*); the jacket is sealed to the condenser tube. Two convenient sizes of condensers, suitable for general use, have jackets of 20 and 40 cm. length.

In the Pyrex glass West condenser greater efficiency of cooling is obtained by having a light-walled inner tube and a heavy-walled outer tube with a minimum space between them.

(*c*) is the inner tube of a Liebig condenser. It is used as an air-condenser when the boiling point of the liquid is above 140–150°.

(*d*) is an all-glass Allihn condenser. The condensing tube is made with a series of bulbs; this increases the condensing surface and lessens the resistance to the passage of vapours when the condenser is employed for

refluxing, *i.e.*, for condensing the vapours issuing from the flask so that the liquid continuously flows back again.

(e) is a typical double surface condenser (Davies type). It is far more efficient than any of the preceding types and the jacket is usually shorter.

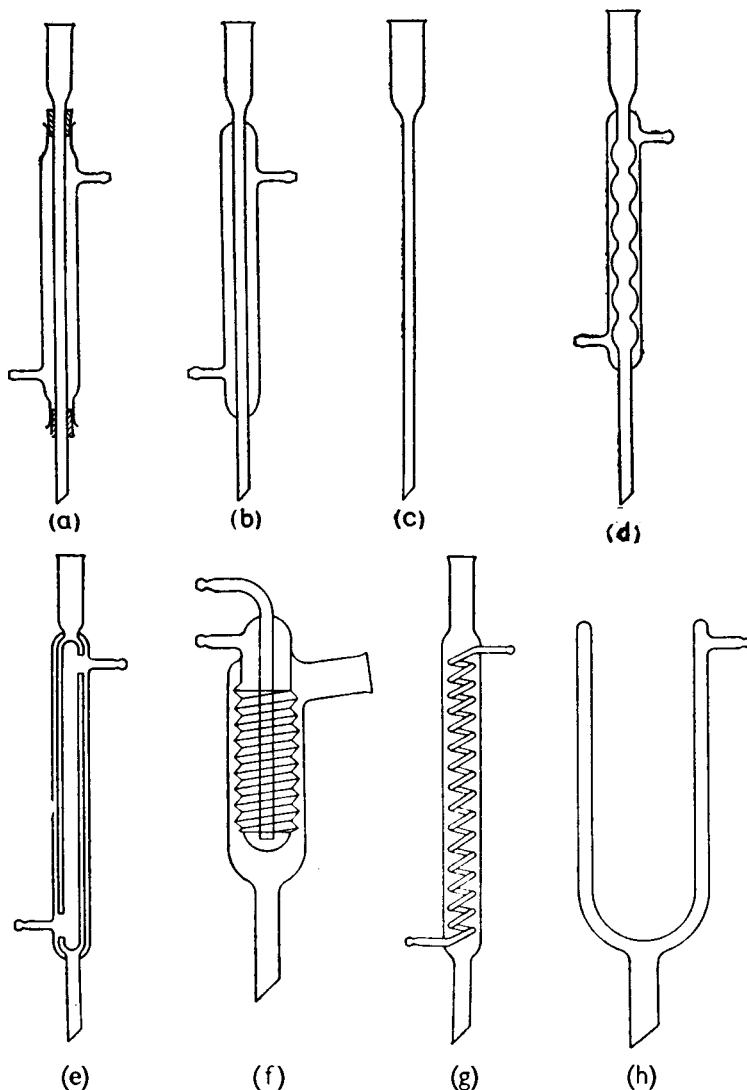

Fig. II, 1, 4.

(f) is an efficient spiral condenser of the Friedrich type. The hot vapours can be introduced either at the side or the bottom, thus permitting the use of the condenser either for condensing vapours from another reaction vessel or for ordinary reflux purposes.

(g) is a coil condenser provided with an internal glass coil or spiral. In a modification there is both an internal spiral as well as an outer cooling jacket.

(*b*) is a Dewar type of reflux condenser. It is usually charged with a freezing mixture, *e.g.*, Dry Ice mixed with alcohol or acetone.

Funnels. Various kinds of funnels are depicted in Fig. II, 1, 5, *a-f*.

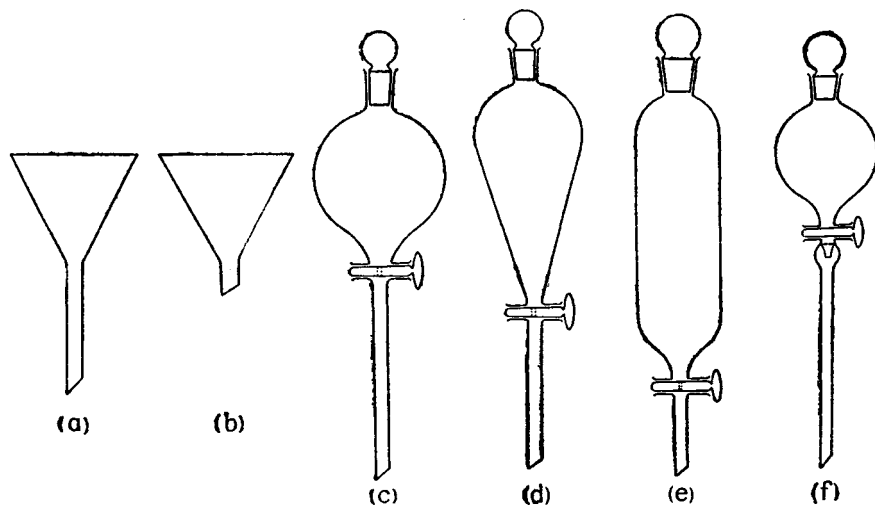

Fig. II, 1, 5.

(*a*) is the ordinary 60° filtration funnel. It is convenient in many operations to employ funnels with a short stem (0.5–1 cm. long) as in (*b*).

(*c*), (*d*) and (*e*) are examples of separatory funnels. Type (*c*) is the globular form and is the most widely used; (*d*) and (*e*) are the Squibb (pear-shaped) and cylindrical separatory funnels respectively. The funnel (*f*) is similar to (*c*) except that it is provided with a device immediately below the tap which enables the liquid to be added dropwise, the rate of addition being visible even when the stem of the funnel is immersed in a liquid: it is termed a dropping funnel.

Hot water funnels. Three varieties of hot water funnel are illustrated in Fig. II, 1, 6. Type (*a*) consists of a double-walled copper jacket to

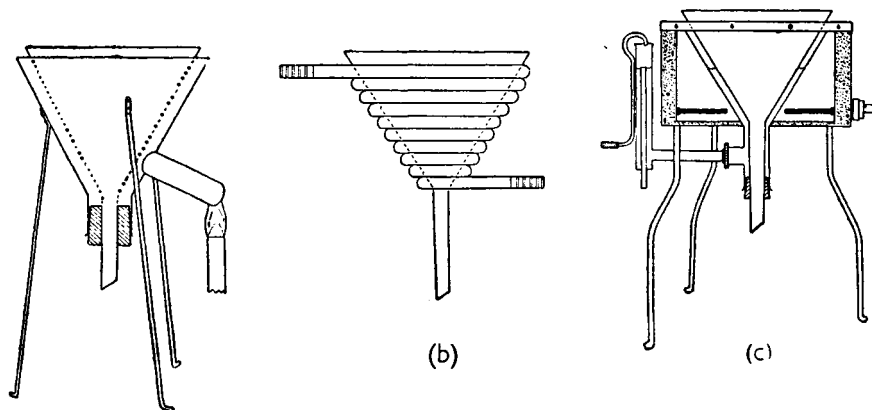

Fig. II, 1, 6.

house the funnel; it is mounted on a tripod. The space between the walls is almost completely filled with water, and the water may be heated to any desired temperature below 100° by directing the flame of a Bunsen burner on to the side tube. Type (b) consists of a coil made of copper or lead tubing of about 10 mm. diameter forming a 60° cone; this will therefore accommodate any funnel. Hot water or steam is passed through the coil, hence it is very suitable for the filtration of inflammable liquids. The funnel may also be used for "cold filtrations" by circulating cold water through the coil. Type (c) is an electrically heated funnel and is provided with a constant level device. Electric heating mantles (see Section II, 57) for both 60° glass funnels and Buchner funnels are commercial products.

Funnels for filtration by suction. These are illustrated in Fig. II, 1, 7, a-g.

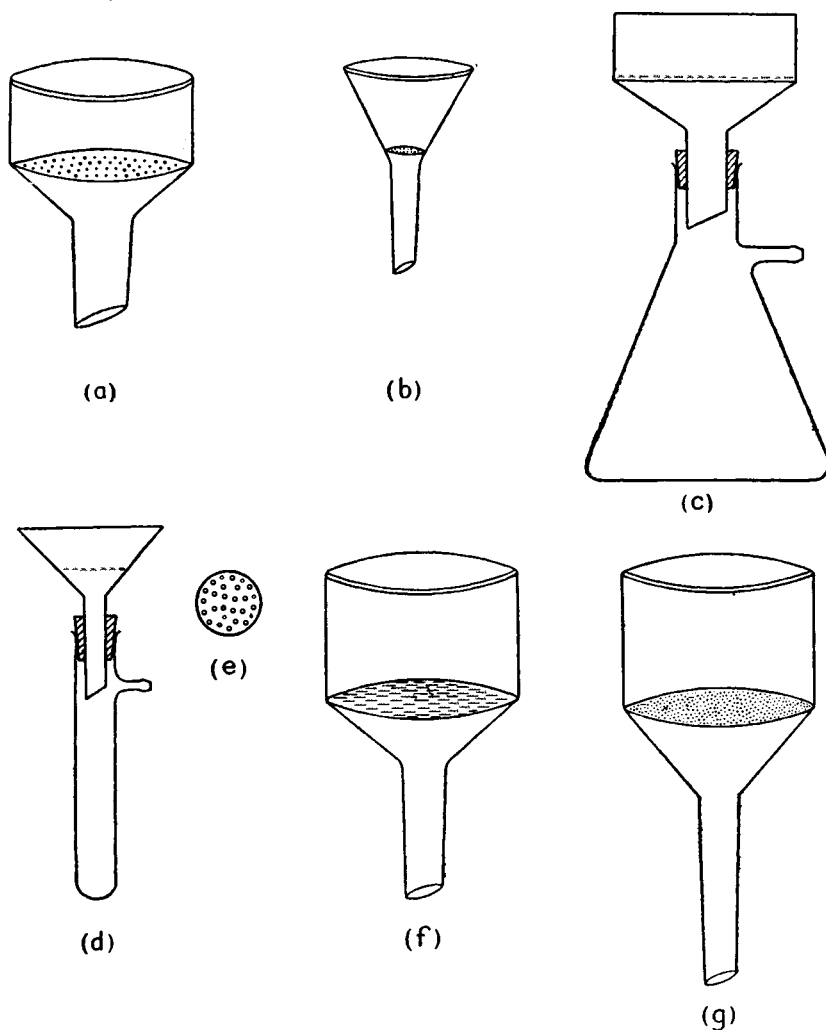

Fig. II, 1, 7.

(a) is a Buchner funnel; it is made of porcelain and has a perforated porcelain plate to support a filter paper. A Buchner funnel (and other funnels described below) is used in conjunction with a filter or suction flask, into which it is fitted by means of a rubber stopper as in (c); the flask is attached by means of thick-walled rubber tubing ("pressure tubing") to a water suction pump.

(b) is a modification known as a Hirsch funnel. This has sloping sides and is designed to deal with a smaller amount of precipitate than the Buchner funnel. The smallest size will accommodate filter papers 3-4 mm. in diameter.

(d) is a substitute for the Hirsch funnel. It consists of an ordinary glass funnel fitted with a Witt plate (e), which is a perforated porcelain plate 1-4 cm. in diameter, upon which a filter paper can rest. The great advantage of (d) is that it is possible to see whether the apparatus is clean; with porcelain funnels it is impossible to inspect the lower side of the perforated plate.

(f) is a "slit sieve" funnel. It is constructed entirely of glass (Jena or Pyrex) and therefore possesses obvious advantages over the opaque (porcelain) Buchner or Hirsch funnel.

(g) is a sintered glass funnel, and is available in a number of porosities (coarse, medium and fine).

Multi-necked flasks. Fig. II, 1, 8, a, illustrates a typical three-necked flask. This has numerous applications in organic chemistry; for many operations, the central aperture carries a mechanical stirrer, and the two side apertures a dropping funnel and a reflux condenser respectively.

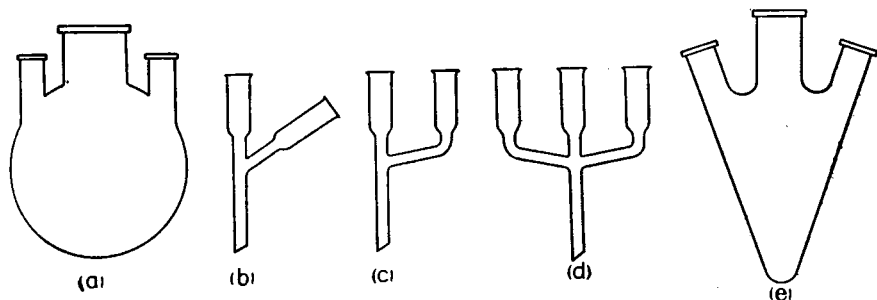

Fig. II, 1, 8.

(b) and (c) are alternative forms of two-way addition tubes. These normally have an overall length of 16-20 cm., and the openings have an internal diameter of 24-25 mm.

(d) is a three-way addition tube. The addition tubes are usually inserted into wide-necked flasks (e.g., bolt-head flasks).

(e) is a special form of three-necked flask (sometimes termed a Grignard flask), which is particularly suitable for any reaction (e.g., the Grignard reaction) where components of widely different densities are to be mixed.

Spatulas. Stainless steel, nickel and porcelain spatulas are available commercially. Some of these are shown in Fig. II, I, 9; (a) is a spatula with a flexible stainless steel blade and is provided with a wooden handle; (b) is a nickel spatula and has a turned-up end to facilitate the handling

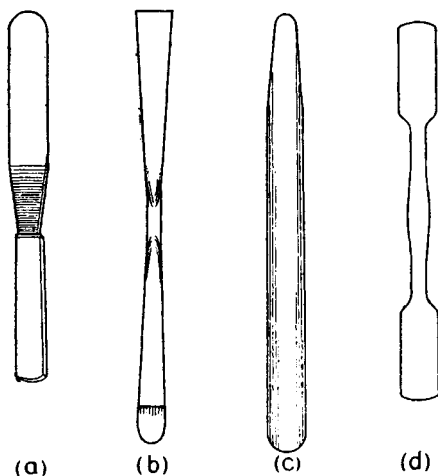

Fig. II, I, 9.

of small quantities of material; (c) is the scoop-type of nickel spatula *; and (d) is a spatula in porcelain.

Miscellaneous apparatus. Two forms of adapters (or adapter tubes) are illustrated in Fig. II, I, 10, a and b; these are generally used to facilitate the delivery of a distillate from a condenser to a receiver.

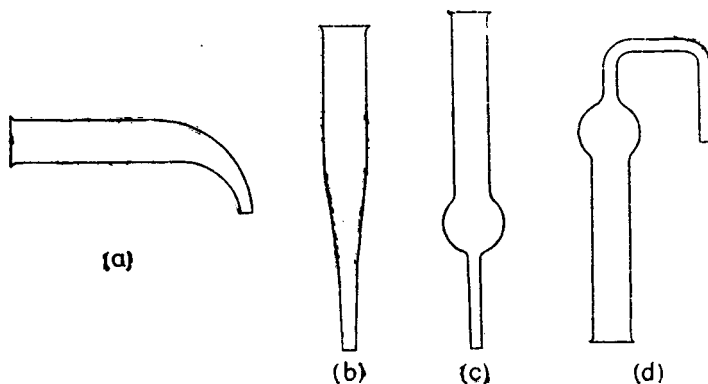

Fig. II, I, 10.

Two forms of the so-called calcium chloride tubes (also termed drying tubes, straight form) are shown in (c) and (d); these are filled with anhydrous calcium chloride or with cotton wool (previously dried at 100°), and are attached by means of a stopper to a flask or apparatus containing substances from which moisture is to be excluded.

* Supplied by the Fisher Scientific Company.

II.2. CLEANING AND DRYING OF GLASSWARE

All glassware should be scrupulously clean and, for most purposes, dry before being employed in preparative work in the laboratory. It is well to develop the habit of cleaning all glass apparatus immediately after use; the nature of the "dirt" will, in general, be known at the time, and, furthermore, the cleaning process becomes more difficult if the dirty apparatus is allowed to stand for any considerable period, particularly if volatile solvents have evaporated in the meantime.

The simplest method, when access by a test-tube brush is possible, is to employ a commercial household washing powder containing an abrasive which does not scratch glass (e.g., "Vim," "Glitto," etc.). The washing powder is either introduced directly into the apparatus and moistened with a little water or else it may be applied to the dirty surface with a wet test-tube brush which has been dipped into the powder; the glass surface is then scrubbed until the dirt has been removed. The operation should be repeated if necessary. Finally, the apparatus is thoroughly rinsed with distilled water. If scrubbing with the water-washing powder mixture is not entirely satisfactory, the powder may be moistened with an organic solvent, such as acetone.

Excellent results are obtained with warm 15 per cent. trisodium phosphate solution to which a little abrasive powder, such as pumice, has been added. This reagent is not suitable for the removal of tars.

The most widely used cleansing agent is the "chromic acid" cleaning mixture. It is essentially a mixture of chromic acid (CrO_3) and concentrated sulphuric acid, and possesses powerful oxidising and solvent properties. Two methods of preparation are available:—

(1) Five grams of sodium dichromate are dissolved in 5 ml. of water in a 250 ml. beaker; 100 ml. of concentrated sulphuric acid are then added slowly with constant stirring. The temperature will rise to 70–80°. The mixture is allowed to cool to about 40° and then transferred to a dry, glass-stoppered bottle.

(2) One hundred ml. of concentrated sulphuric acid, contained in a 250 ml. Pyrex beaker, are cautiously heated to about 100°, and 3 grams of sodium or potassium dichromate gradually added with stirring. Stirring should be continued for several minutes in order to prevent the resulting chromic acid from caking together. The mixture is allowed to cool to about 40°, and transferred to a dry, glass-stoppered bottle. The chromic acid mixture prepared by shaking excess of sodium dichromate or of finely-powdered potassium dichromate with concentrated sulphuric acid at the laboratory temperature is not as efficient as that prepared by method (1) or (2); it is, however, useful for cleaning glassware for volumetric analysis. The mixture has powerful oxidising and solvent properties; its exhaustion is readily recognised by the change in colour from reddish-brown to green.

Before using the chromic acid mixture for cleaning, the vessel should be rinsed with water to remove organic matter and particularly reducing agents as far as possible. After draining away as much of the water as practicable, a quantity of the cleaning mixture is introduced into the vessel, the soiled surface thoroughly wetted with the mixture, and the

main quantity of the cleaning mixture returned to the stock bottle. After standing for a short time with occasional rotation of the vessel to spread the liquid over the surface, the vessel is thoroughly rinsed successively with tap and distilled water. If a black solid, probably consisting largely of carbon produced by overheating the contents of the apparatus, remains after the above treatment, it is recommended that a small volume of the reagent be introduced into the flask and the latter gently and evenly heated with a free flame until the acid commences to fume. Under these conditions, most carbonaceous matter is oxidised.

The procedure whereby a *little* alcohol is *rapidly* added to the vessel, supported in the fume chamber and containing some concentrated nitric acid, although generally preceded by a short period of induction, may be extremely dangerous and should not be used. Under no circumstances should concentrated nitric acid be added to ethyl alcohol—a violent explosion may result.

Satisfactory cleaning may often be achieved by rinsing the vessel with a few ml.

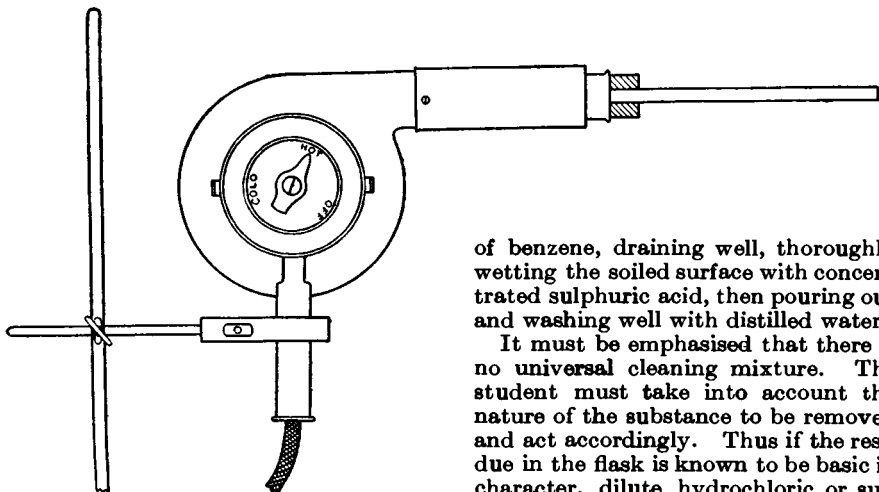

Fig. II, 2, 1.

of benzene, draining well, thoroughly wetting the soiled surface with concentrated sulphuric acid, then pouring out and washing well with distilled water.

It must be emphasised that there is no universal cleaning mixture. The student must take into account the nature of the substance to be removed and act accordingly. Thus if the residue in the flask is known to be basic in character, dilute hydrochloric or sulphuric acid may dissolve it completely; similarly, dilute sodium hydroxide

solution may be employed for acidic residues. If the residue is known to dissolve in a particular inexpensive organic solvent, this should be employed.

Small glass apparatus may be dried by leaving it in a steam oven or in an electrically-heated oven maintained at 100–120° for one to two hours. Most organic apparatus is too bulky for oven drying and, moreover, is generally required soon after washing: other methods of drying are therefore used. All these methods depend upon the use of a current of air, which should preferably be warm. If the apparatus is wet with water, the latter is drained as completely as possible, then rinsed with a little methylated spirit, followed, after draining, with a little ether; alternatively, the apparatus may be rinsed with a little acetone. It is convenient to have two bottles labelled *METHYLATED SPIRIT FOR WASHING* and *ETHER FOR WASHING* if the alcohol-ether method of drying is used for rinsing out the apparatus. If acetone rinsing is employed, the bottle should be labelled *ACETONE FOR WASHING*. After rinsing with the organic solvent, the subsequent drying is most con-

veniently done with the aid of the warm air blower shown in Fig. II, 2, 1. It consists of an inexpensive commercial hair drier * mounted on a retort stand; a cork carrying a wide glass tube (about 10 mm. in diameter) is fitted into the air orifice and securely wired into position. The air blast is controlled by a three-way combination switch: with one setting of the switch the apparatus blows air at the laboratory temperature, with another setting it blows hot air, and with a third setting the blower is switched off. The apparatus, moist with organic solvent, is held (or supported) over the glass tube and cold air is first passed through for a minute or two, and this is soon followed by hot air until the apparatus is thoroughly dry.

A less satisfactory method of drying after the washing with the organic solvent is to pass a stream of air from a blowpipe bellows (foot or electrically operated) into the vessel through a long wide glass tube. When most or all of the solvent has evaporated, a length of the glass tube may be heated in a flame, thus introducing warm air into the vessel to complete the drying.

II,3. USE OF CORK AND RUBBER STOPPERS

Two points must be borne in mind when selecting a cork stopper. In the first place, the cork should be examined for freedom from flaws; unless corks of the highest quality are employed, they are liable to have deep holes, which render them useless. In the second place, the cork should originally fit as shown in Fig. II, 3, 1, *a* and not as in *b*. It should then be softened by rolling in a cork press or by wrapping it in paper and rolling under the foot.

To bore a cork, a borer should be selected which gives a hole only very slightly smaller than that desired. The cork borer is moistened with water or alcohol or best with glycerine; it is convenient to keep a small bottle (*ca.* 25 ml. capacity) containing glycerine, Fig. II, 3, 2, for this purpose. The borer is held in the right hand and the cork in the left hand. The hole is started at the narrow end with a continuous rotary motion. Beginners should bear in mind that the borer is a cutting instrument and not a punch, and on no account should it be allowed to burst its way through the cork because the borer, upon emerging, will almost invariably tear the surface of the cork. It is a good plan to examine the borer from time to time as it advances through the cork to see that it is cutting a straight hole. Boring should be stopped when it is half through the cork † and the tool removed from the hole. The cork plug is pushed out with the aid of the solid metal rod supplied with the set of borers, and the remainder of the hole is bored from

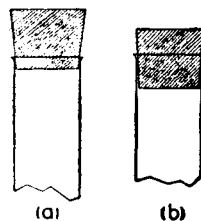

Fig. II, 3, 1.

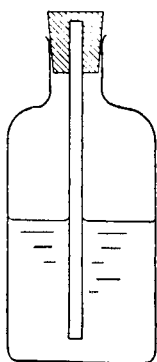

Fig. II, 3, 2.

* An excellent and inexpensive hot air drier ("A.M. Industrial Type Blower") is manufactured by Bylock Electric Ltd., Ponders End, Enfield, Middlesex.

† With a little experience this can usually be accomplished in one operation without the necessity of stopping to see whether a straight hole is being cut.

the other end. If the holes are carefully aligned, a clean cut hole is obtained. Experienced laboratory workers frequently complete the whole boring operation from one side, but beginners usually tear the edges of the cork by this method, which is therefore not recommended. A well-fitting cork should slide over the tube (side arm of distilling flask, thermometer, lower end of condenser, etc.) which is to pass through it with only very moderate pressure. The bored cork should be tested for size; if it is too small, the hole should be enlarged to the desired diameter with a small round file. When the correct size is obtained, the tube is held near the end and inserted into the cork. The tube is then grasped *near* the cork and cautiously worked in by gentle twisting. Under no circumstances should the tube be held too far from the cork nor should one attempt to

force a tube through too small an opening in a cork; neglect of these apparently obvious precautions may result in a severe cut in the hand from the breaking of the glass tube.

For consistently successful results in cork boring, a sharp cork borer must be used. The sharpening operation will be obvious from Fig. II, 3, 3. The borer is pressed gently against the metal cone, whilst slight pressure is applied with the "cutter" *A* at *B*; upon slowly rotating the borer a good cutting edge will be obtained. If too great pressure is applied either to the borer or to the "cutter," the result will be unsatisfactory and the cutting circle of the borer may be damaged. To maintain a cork borer in good condition, it should be sharpened every second or third time it is used.

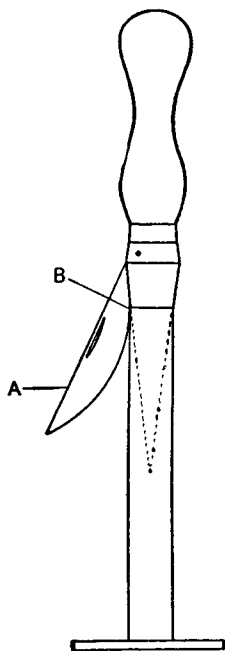

Fig. II, 3, 3.

Rubber stoppers are frequently employed in the laboratory in "vacuum distillation" assemblies (compare Section II, 19); for distillations under atmospheric pressure bark corks are generally used. Many organic liquids and vapours dissolve new rubber stoppers slightly and cause them to swell. In practice, it is found that rubber stoppers which have been previously used on one or two occasions are not appreciably attacked by most organic solvents, owing presumably to the formation of a resistant surface coating. To bore a rubber stopper, it is essential to employ a very sharp cork borer of the same size as the tube to be inserted into the hole. The borer is lubricated with a little glycerine (Fig. II, 3, 2) and steadily rotated under only very slight pressure. The operation requires a good deal of patience and time and frequent lubrication may be necessary; if too much pressure be exerted on the borer, a hole of irregular shape and diminishing size will result.

The insertion of a glass tube into a rubber stopper or into rubber tubing is greatly facilitated by moistening the rubber with a little glycerine. After some use rubber may stick to glass and great care must be taken not to break the glass tube when removing it. Frequently the exertion of gentle pressure on the rubber stopper by means of the two thumbs whilst the end of the tube (or thermometer) rests vertically on

the bench will loosen the stopper; this operation must, however, be conducted with great care. Another method is to slip the smallest possible cork borer, lubricated with a little glycerine, over the tube, and to gradually rotate the borer so that it passes between the stopper and the glass tube without starting a new cut.

II,4. CUTTING AND BENDING OF GLASS TUBING

Many students tend to forget the practical details learnt in elementary courses of chemistry; they are therefore repeated here. To cut a piece of glass tubing, a deep scratch is first made with a triangular file or "glass knife." The tubing is held in both hands with the thumbs on either side of the scratch, but on the side opposite to it. The tubing is then "pulled" gently as though one wanted to stretch the tube and also open the scratch. A break with a clean edge will result. The cut edge must then be rounded or smoothed by fire polishing. The end of the tube is heated in the Bunsen flame until the edges melt and become quite smooth; the tube is steadily rotated all the time so as to ensure even heating. Overheating should be avoided as the tube will then partially collapse.

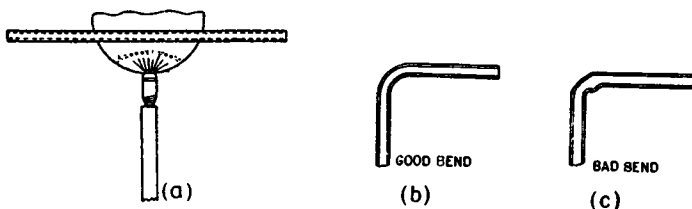

Fig. II, 4, 1.

A "batswing" or "fish-tail" burner is generally used for the bending of glass tubing. The tube is held with both hands in the length of the flame (Fig. II, 4, 1, a) so that 5–8 cm. are heated: the tube must be slowly rotated about its axis so as to heat all sides equally. As soon as the glass is felt to be soft, it is bent to the required shape. This is best done by removing it from the flame and allowing one end to fall gradually under its own weight, whilst being guided so that it is in the same plane as the rest of the tube. The glass must never be forced, otherwise a bad bend with a kink will be obtained as in Fig. II, 4, 1, c.

II,5.

HEATING BATHS

For temperatures up to 100°, a water bath or steam bath is generally employed. The simplest form is a beaker or an enamelled iron vessel mounted on a suitable stand; water is placed in the vessel, which is heated by means of a flame. This arrangement may be used for non-inflammable liquids or for refluxing liquids of low boiling point. Since numerous liquids of low boiling point are highly inflammable, the presence of a naked flame will introduce considerable risk of fire. For such liquids a steam bath or an electrically-heated water bath, provided with a constant-level device, must be used. If the laboratory is equipped with a

steam service, it is convenient to have a number of baths, fitted with a series of concentric copper or lead rings in order to accommodate various sizes of flasks, mounted on lead-covered benches; the steam supply enters near the bottom of the bath and is controlled by a cock outside it. If the laboratory has no external steam supply, the electrically-heated water bath, depicted in Fig. II, 5, 1, is equally serviceable. The bath is of copper, has a diameter of 20–25 cm., and is fitted with an all-metal constant-level device. It is heated by means of a hot plate* in which is incorporated a three-heat (“high,” “medium” and “low”) switch. Any size flask may be supported with the aid of the set of concentric copper or lead rings. The temperature of the water in *A* is controlled

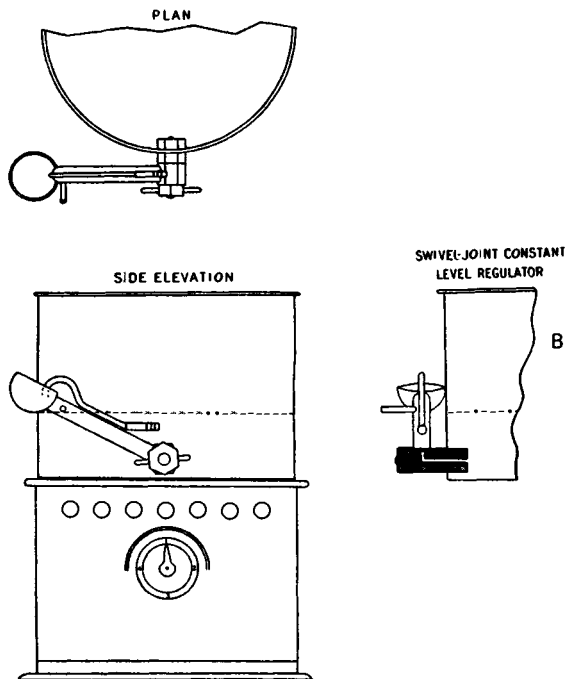

Fig. II, 5, I.

by the three-way switch on the hot plate and by the rate at which water is allowed to enter the bath *A*; it is recommended that the thick-walled rubber tubing connecting the water tap with the constant level device *B* be securely fixed at both ends with a turn or two of copper wire.

For temperatures above 100°, oil baths are generally used. Medicinal paraffin may be employed for temperatures up to about 220°. Glycerol and di-*n*-butyl phthalate are satisfactory up to 140–150°; above these temperatures fuming is usually excessive and the odour of the vapours is unpleasant. For temperatures up to about 250° “hard hydrogenated” cotton seed oil, m.p. 40–60°, is recommended: it is clear, not sticky and solidifies on cooling; its advantages are therefore obvious. Slight discoloration of the “hard” oil at high temperatures does not affect its

* A suitable enclosed-type hot plate (“boiling ring”) is supplied by Belling and Co. Ltd.

value for use as a bath liquid. The Silicone fluids, *e.g.*, MS 550 *, are probably the best liquids for oil baths, but are at present too expensive for general use. The MS 550 fluid may be heated to 250° without appreciable loss and discoloration. Oil baths should be set up in the fume cupboard wherever possible. A thermometer should always be placed in the bath to avoid excessive heating. Flasks, when removed from an oil bath, should be allowed to drain for several minutes and then wiped with a rag. Oil baths are generally heated by a gas burner. Some form of internal electrical heating may be employed by advanced students; a commercial heater embedded in ceramic material and sealed in metal may be supported near the bottom of the bath: the heat input is conveniently controlled by a variable transformer.

Higher temperatures may be obtained with the aid of baths of fusible metal alloys, *e.g.*, Woods metal—4 parts of Bi, 2 parts of Pb, 1 part of Sn, and 1 part of Cu—melts at 71°; Rose's metal—2 of Bi, 1 of Pb and 1 of Sn—has a melting point of 94°; a eutectic mixture of lead and tin, composed of 37 parts of Pb and 63 parts of Sn, melts at 183°. Metal baths should not be used at temperatures much in excess of 350° owing to the rapid oxidation of the alloy; this oxidation may be reduced by employing a small commercial glue pot (Fig. II, 5, 2), the outer pot containing the metal alloy. Before heating, the beaker should be held in a large luminous flame until it is covered with a deposit of carbon, which prevents the fused metal from adhering to the beaker; the same result is obtained by coating the beaker with graphite. The beaker and thermometer should be removed from the metal bath before the latter solidifies. Metal baths have the advantage that they do not smoke or catch fire; they are, however, solid at the ordinary temperature and are usually too expensive for general use.

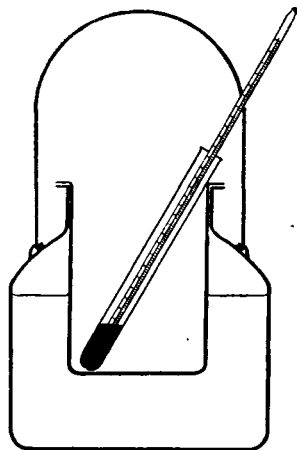

Fig. II, 5, 2.

A satisfactory bath suitable for temperatures up to about 250° may be prepared by mixing four parts by weight of 85 per cent. ortho-phosphoric acid and one part by weight of meta-phosphoric acid; the mixed components should first be heated slowly to 260° and held at this temperature until evolution of steam and vapours has ceased. This bath is liquid at room temperatures. For temperatures up to 340°, a mixture of two parts of 85 per cent. ortho-phosphoric acid and one part of meta-phosphoric acid may be used: this is solid (or very viscous) at about 20°.

A shallow metal vessel containing sand, the so-called sand bath, heated by means of a flame, was formerly employed for heating flasks and other glass apparatus. Owing to the low heat conductivity of sand, the temperature control is poor; the use of sand baths is therefore not

* Supplied by Midland Silicones Ltd., 19 Upper Brook Street, London, W. 1; also by Imperial Chemical Industries Ltd., 149 Park Lane, London, W. 1. An equivalent product is available from Dow-Corning, U.S.A.

recommended for routine work in the laboratory. It may occasionally be employed where high temperatures are required, *e.g.*, in thermal decomposition; as a rule, graphite or nickel shot is preferable for this purpose.

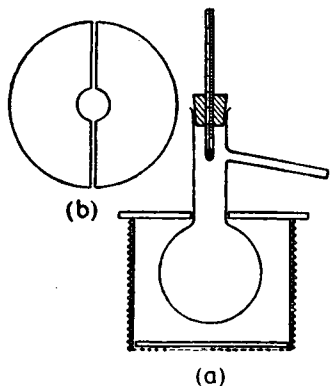

Fig. II, 5, 3.

of the can respectively. A piece of asbestos board (2–4 mm. thickness) of diameter slightly larger than the top of the can is then obtained and a hole of suitable diameter made in its centre; the asbestos is then cut diametrically. The two halves, which constitute the cover of the air bath, will have the shape shown in Fig. II, 5, 3, *b*. The diameter of the hole in the asbestos lid should be approximately equal to the diameter of the neck of the largest flask that the air bath will accommodate. The air bath, supported on a tripod, is heated by means of a Bunsen burner: the position of a distilling flask, which should be clamped, is shown in Fig. II, 5, 3, *a*. The flask should not, as a rule, rest on the bottom of the bath. The student is recommended to construct three air baths for flasks of 50, 100 and 250 ml. capacity. The advantages of the above air bath are: (1) simplicity and cheapness of construction; (2) ease of temperature control; (3) rapidity of cooling of the contents of the flask effected either by removing the asbestos covers or by completely removing the air bath; and (4) the contents of the flask may be inspected by removing the asbestos covers.

One of the disadvantages of oil and metal baths is that the reaction mixture cannot be observed easily; also for really constant temperatures, frequent adjustment of the source of heat is necessary. These difficulties are overcome, when comparatively small quantities of reactants are involved, in the apparatus shown in Fig. II, 5, 4 (not drawn to scale). A

An air bath may be readily constructed by the student from a commercial circular tin can (that from tinned fruit or food is quite suitable), and is very satisfactory for most work involving the heating of liquids of boiling point above 80° (or below this temperature if the liquid is non-inflammable). The top edge of the can is first smoothed and any ragged pieces of metal removed. A series of holes is then punched through the bottom, and a circular piece of asbestos (about 2–3 mm. thickness) of the same diameter as the can inserted over the holes. The body of the can is then wrapped with asbestos cloth which is bound securely in position by two wires near the top and bottom

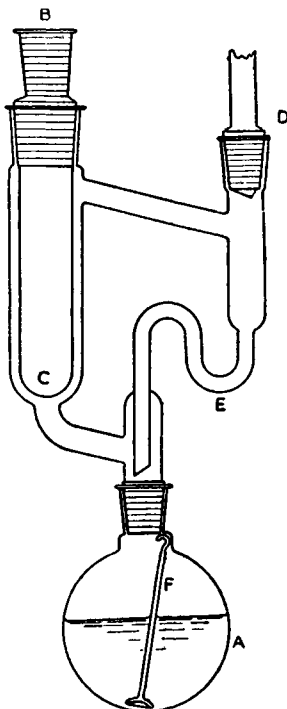

Fig. II, 5, 4.

liquid of the desired boiling point is placed in the flask *A*. The liquid in *A* is boiled gently so that its vapour jackets the reaction tube *BC*; it is condensed by the reflux condenser at *D* and returns to the flask through the siphon *E*. Regular ebullition in the flask is ensured by the bubbler *F*. The reaction mixture in *C* may be stirred mechanically. It is convenient to have a number of flasks, each charged with a different liquid; changing the temperature inside *C* is then a simple operation. A useful assembly consists of a 50 ml. flask *A* with *B19* joint, a vapour jacket about 15 cm. long, a *B34* joint at *B*, and a *B19* or *B24* joint at *D*.

The following liquids may be used (boiling points are given in parentheses):—chlorobenzene (132–3°); bromobenzene (155°); *p*-cymene (176°); *o*-dichlorobenzene (180°); aniline (184°); methyl benzoate (200°); tetralin (207°); ethyl benzoate (212°); 1 : 2 : 4-trichlorobenzene (213°); isopropyl benzoate (218°); methyl salicylate (223°); *n*-propyl benzoate (231°); diethyleneglycol (244°); *n*-butyl benzoate (250°); diphenyl (255°); diphenyl ether (259°); dimethyl phthalate (282°); diethyl phthalate (296°); diphenylamine (302°); benzophenone (305°); benzyl benzoate (316°).

Electric hot plates may also be employed for heating. These should be of substantial construction and be provided with three-way switches. The diameter of the heavy cast-iron top may vary between 5" and 10". It is usually advisable to interpose a sheet of asbestos board between the metal top and the vessel to be heated, particularly if the contents of the latter are liable to "bump."

II.6.

COOLING BATHS

It is often necessary to obtain temperatures below that of the laboratory. Finely-crushed ice is used for maintaining the temperature at 0–5°: it is usually best to use a slush of crushed ice with sufficient water to provide contact with the vessel to be cooled and to stir frequently. For temperatures below 0°, the commonest freezing mixture is an intimate mixture of common salt and crushed ice: a mixture of one part of common salt and three parts of ice will theoretically produce a temperature of about –20° but, in practice, the ice salt mixtures give temperatures of –5° to –18°. Greater cooling may be obtained by the use of crystalline calcium chloride; temperatures of –40° to –50° may be reached with five parts of $\text{CaCl}_2 \cdot 6\text{H}_2\text{O}$ and 3.5–4 parts of crushed ice.

If ice is temporarily not available, advantage may be taken of the cooling effect attending the solution of certain salts or salt mixtures in water. Thus a mixture produced by dissolving 1 part of NH_4Cl and 1 part of NaNO_3 in 1–2 parts of water causes a reduction in temperature from 10° to –15° to –20°; 3 parts of NH_4Cl in 10 parts of water from 13° to –15°; 11 parts of $\text{Na}_2\text{S}_2\text{O}_3 \cdot 5\text{H}_2\text{O}$ in 10 parts of water from 11° to –8°; and 3 parts of NH_4NO_3 in 5 parts of water from 13° to –13°.

Solid carbon dioxide (Dry Ice, Drikold) is employed when very low temperatures are required. If it is suspended in solvents, such as alcohol or a mixture of equal volumes of chloroform and carbon tetrachloride, temperatures down to –50° can be easily attained. Lower temperatures still are reached if intimate mixtures of solid carbon dioxide and organic solvents are employed: with ethyl alcohol, –72°; with

diethyl ether, -77° ; and with chloroform or acetone, -77° (compare Section I, 19).

In order to keep a freezing mixture for hours or overnight, it is transferred to a glass or copper "thermos" flask; the test-tube or small flask may then be immersed in the mixture. When it is desired to keep larger vessels at about 0° , an ice box (a metal, usually galvanised iron, container, filled with ice, well insulated by thick cork slabs and surrounded by a wooden box) is generally employed. A large commercial refrigerator, suitably adapted, serves the dual purpose of supplying ice for the requirements of the laboratory and as a cold chamber.

II, 7. MECHANICAL AGITATION

Mechanical stirring is not necessary in work with homogeneous solutions except when it is desired to add a substance portion-wise or dropwise so as to bring it as rapidly as possible into intimate contact with the main bulk of the solution. This applies particularly in those cases where a precipitate is formed and adsorption may occur, or where heat is generated locally which may decompose a sensitive preparation. In such cases the solution must be continuously agitated by manual shaking or, preferably, by mechanical stirring. When large quantities of material are to be dealt with, it is much easier and very much more efficient to employ mechanical stirring. The importance of mechanical agitation cannot be over-estimated where heterogeneous mixtures are involved. In many preparations the time required for completion of the reaction is shortened, temperatures are more readily controlled, and the yields are improved when mechanical agitation is employed. No apology is therefore needed for discussing this subject in some detail.

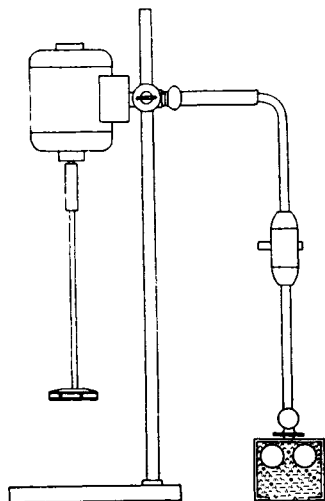

Fig. II, 7, 1.

Stirring in open vessels, such as beakers or flasks, can be effected with the aid of a stirrer attached directly to a small electric motor by means of a chuck or a short length of "pressure" tubing. Excellent stirring units are available commercially. Only two of these, which the author has found satisfactory, will be described. Fig. II, 7, 1* illustrates a general purpose stirrer, equipped with a $\frac{1}{16}$ h.p. motor, which can be fitted to any retort stand: glass stirrers may be attached with a short length of heavy-wall rubber tubing, whilst stainless steel stirrers (compare Fig. II, 7, 6) are fitted into position by means of a screw. The stirrer unit shown in Fig. II, 7, 2† is particularly useful: the motor is $\frac{1}{30}$ h.p. It is mounted on a heavy enamelled iron base (55 × 30 cm.),

* "Kestner Laboratory Stirrer" supplied by Kestner Evaporator and Engineering Co. Ltd.

† A slightly smaller unit but fitted with only one resistance control mounted on a box below the base is marketed by L. Mitchell, Ltd.

the vertical rod (2 cm. diameter and 72 cm. long) is hollow and is connected at the lower end beneath the base with a "rotating arm" resistance (housed in a water-tight box) and at the upper end with a switch and rotary control for the resistance. This serves as a coarse control for the speed of the stirrer. A finer control is given by the variable resistance (500 ohms; 0.5 amp.) fixed to the base. The special type of clamp, illustrated in Fig. II, 7, 2, which will accommodate rods up to 2 cm. in diameter and fix them in any position, is noteworthy.

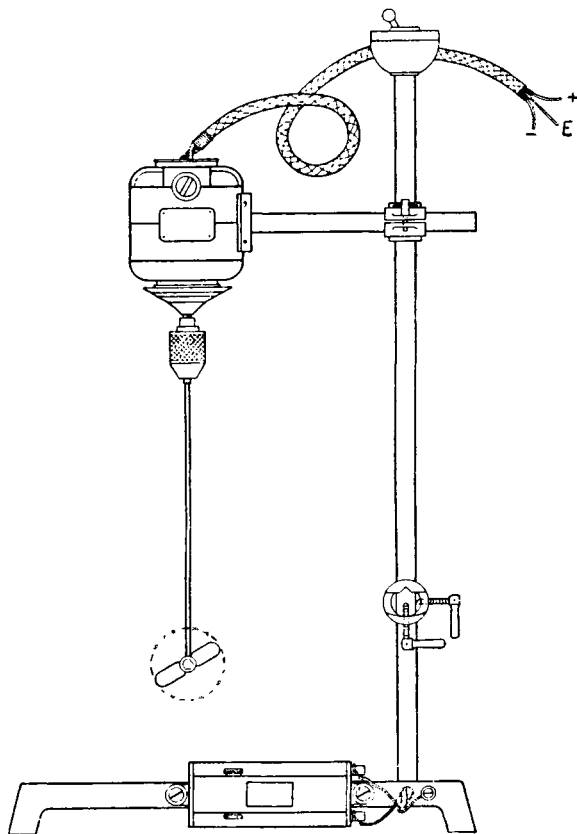

Fig. II, 7, 2.

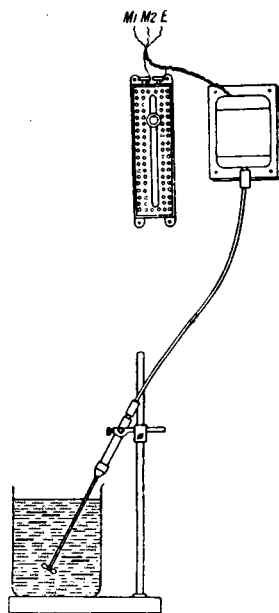

Fig. II, 7, 3.

A powerful stirrer, driven by a flexible driving shaft between the motor ($\frac{1}{8}$ h.p.) and the stirrer, is depicted in Fig. II, 7, 3.* The motor may be placed at a distance from the stirrer head and reaction vessel, thus enabling the assembly to be used for inflammable, corrosive or fuming liquids without damage to the motor. Furthermore, any laboratory retort stand and clamp may be used since the stirrer head weighs only about 250 grams. A variable speed control (500–2000 r.p.m.) is provided.

* The "Flexo-Mix Stirrer Unit" supplied by Kestner Evaporator and Engineering Co. Ltd.

Stirrers are usually made of glass, but those of monel metal, stainless steel or Teflon (a polyfluoroethylene) also find application in the laboratory. An important advantage of a stirrer with a Teflon blade is that it is

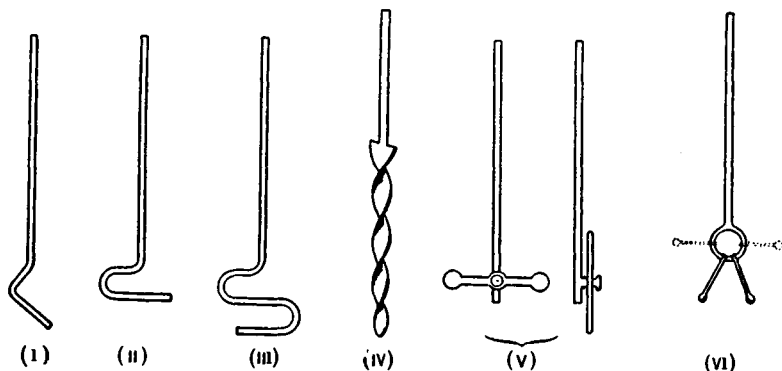

Fig. II, 7, 4.

comparatively soft and merely bends if it hits the glass even at high speed ; furthermore, it can be shaped to fit the bottom of the vessel, thus rendering the stirring of small volumes of liquid in a large flask possible. A few typical glass stirrers are collected in Fig. II, 7, 4 ; some of these can easily be constructed by the student from glass rod. Types (v) and (vi) are recommended ; they possess the advantage that they may be inserted through a narrow neck. A stirrer with a half-moon shaped Teflon blade is illustrated in Fig. II, 7, 5 ; it may be employed for stirring in a round-bottomed or flat-bottomed vessel (the latter by turning the blade over). Two typical stirrers in stainless steel (Kestner) are depicted in Fig. II, 7, 6 : (b) is a vortex stirrer and in use gives the effect shown in (c).



A useful stirrer—sometimes termed a **Hershberg stirrer**—Fig. II, 7, 5. for efficient agitation in round-bottomed vessels, even of

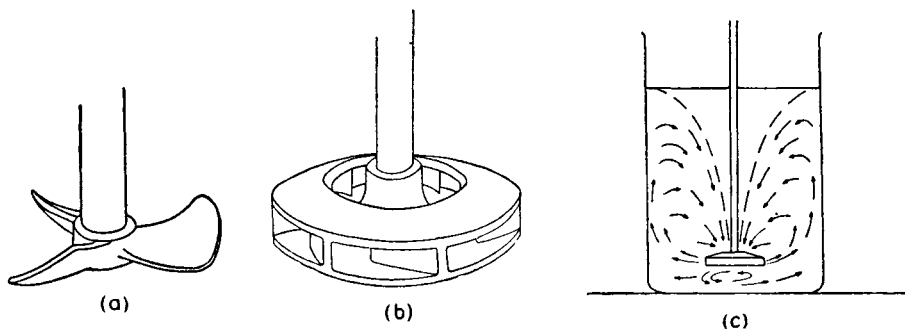

Fig. II, 7, 6.

pasty mixtures, is presented in Fig. II, 7, 7. It consists of a hollow glass tube to which a glass ring is sealed ; the glass ring is threaded with chromel or nichrome or tantalum wire (about 1 mm. diameter). By

sealing another glass ring at right angles to the first and threading this with wire, better results will be obtained; this is usually unnecessary. The stirrer is easily introduced through a narrow opening, and in operation follows the contour of the flask; it is therefore particularly valuable when it is desired to stir a solid which clings obstinately to the bottom of a round-bottomed flask.

A stirrer, known as a Vibro Mixer,* and of particular value for closed systems, is illustrated in Fig. II, 7, 8 fitted into the central neck of a three-necked flask. The enclosed motor, operating on alternating current, vibrates the stirrer shaft at the same frequency (as the a.c. mains), moving up and down in short, powerful strokes. A control knob at the top of the stirrer housing is provided for adjusting the stroke length from gentle strokes (0.2 mm.) to powerful strokes (ca. 2 mm. in thrust). As it is a non-rotating stirrer, a hermetic seal with the

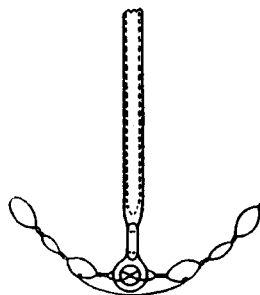

Fig. II, 7, 7.

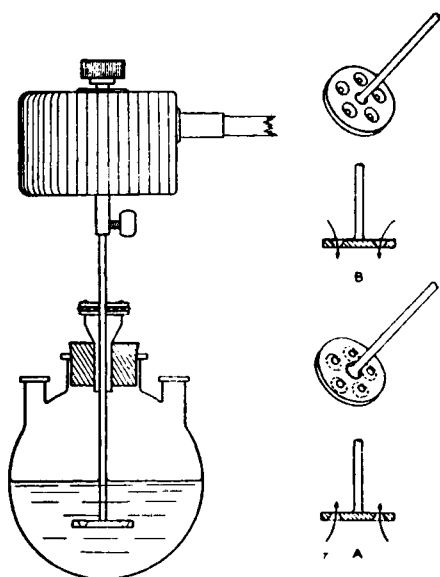

Fig. II, 7, 8.

reaction flask can be made easily. Several types of stirrer blades are available; two "plate" stirrers are shown in Fig. II, 7, 8, A and B. In A the holes taper upward; the liquid will (on the downstroke) flow up through the wide lower orifices to be violently expelled through the narrower orifices at the top. The principle involved is similar to what happens when water flowing through a pipe suddenly enters a narrower pipe; the speed of flow is greatly increased. In B the holes taper downward; excellent mixing is thus obtained for solids etc. at the bottom of the vessel. These "plate" stirrers are useful for intimately mixing liquids in a separatory funnel. For reactions in which gas is passed into the reaction mixture, a hollow shaft is supplied and the gas enters the liquid under the blade and is dispersed into extremely fine bubbles. A special "hydrogenation" stirrer is also marketed: this incorporates a gas circulating device that sucks gas from above the liquid down into the liquid. The base of the stand upon which the stirrer is mounted rests upon sponge rubber or thick felt sheets in order to reduce vibration to a minimum. No guide for the stirrer shaft is necessary; the stirring is very efficient.

* Manufactured by A.G. für Chemie-Apparatebau, Zürich 6, Ottikerstr. 24; also supplied by the Fisher Scientific Company. Model E 1 is recommended for general laboratory purposes.

Mercury-sealed stirrers are used in the following operations : (1) simultaneous stirring and refluxing of a reaction mixture ; (2) stirring the contents of a closed vessel ; (3) agitation with prevention of the escape of a gas or vapour ; and (4) stirring in an inert atmosphere, such as

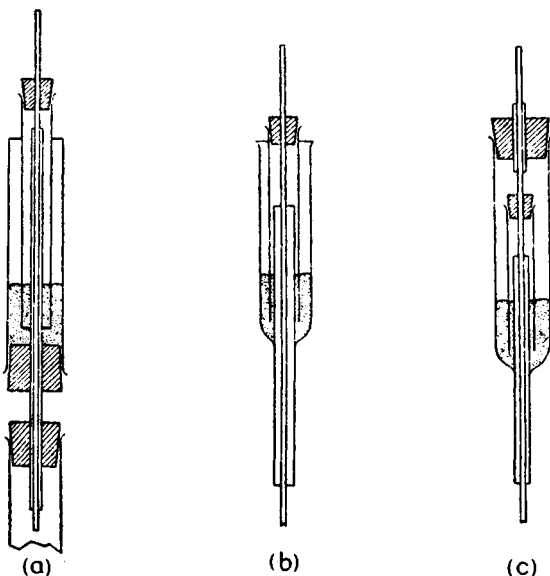

Fig. II, 7, 9.

nitrogen or hydrogen. Three forms of mercury-sealed stirrers are shown in Fig. II, 7, 9, *a-c* ; mercury is poured into the space between the outer tube and the inner bearing tube. In (*b*) the lower rubber stopper is replaced by a glass seal, and thus eliminates the danger of possible leakage of mercury through the stopper. Trap (*c*) incorporates an additional stopper and glass bearing, and is a slight improvement upon (*a*) : the spattering of mercury during the operation of the stirrer, particularly at high speeds, and the spilling of mercury when the seal is disconnected are thus prevented. The bearings may be lubricated with a little glycerine.

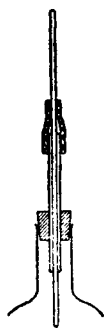

Fig. II, 7, 10.

A simple substitute for a mercury-sealed stirrer is illustrated in Fig. II, 7, 10. The upper, fire-polished end of a 8–10 cm. length of 10 mm. glass tubing, projecting through a stopper which fits into the flask, is fitted with a 2 cm. length of 6 mm. heavy-wall rubber tubing so that it projects 5–8 mm. beyond the end of the glass tube ; this projecting portion fits tightly to form a seal round an 8 mm. stirrer shaft running through the glass tubing. Glycerine (or Silicone grease) is applied to the point of contact of the glass and rubber to act as a lubricant and sealing medium. The seal, sometimes known as the Kyrides seal, can be used with reduced pressure down to 10–12 mm. of mercury.* The above dimensions are not

* This stirrer is not dependable for stirring operations lasting several hours ; the rubber tubing may stick to the shaft and may also be attacked by the organic vapours causing it to swell and allow the escape of vapours.

rigid, but are given as an indication of the relative sizes of the tubes to be employed in the construction of the stirrer, which will be termed a glycerine-sealed stirrer. It has also been named a Kyrides stirrer.

A common operation in practical organic chemistry is for stirring, refluxing, and addition of a liquid from a dropping funnel to be carried on simultaneously. The most convenient apparatus for this purpose is a three-necked flask, fitted as in Fig. II, 7, 11, *a*. If a three-necked flask is not available, the three-way adapter inserted into a bolt-head flask (Fig. II, 7, 11, *b*) may be used. A further simplification, suitable for elementary students, is to employ a two-way adapter as in Fig. II, 7, 11, *c*; the stirrer passes through a closely-fitting glass sleeve which is extended

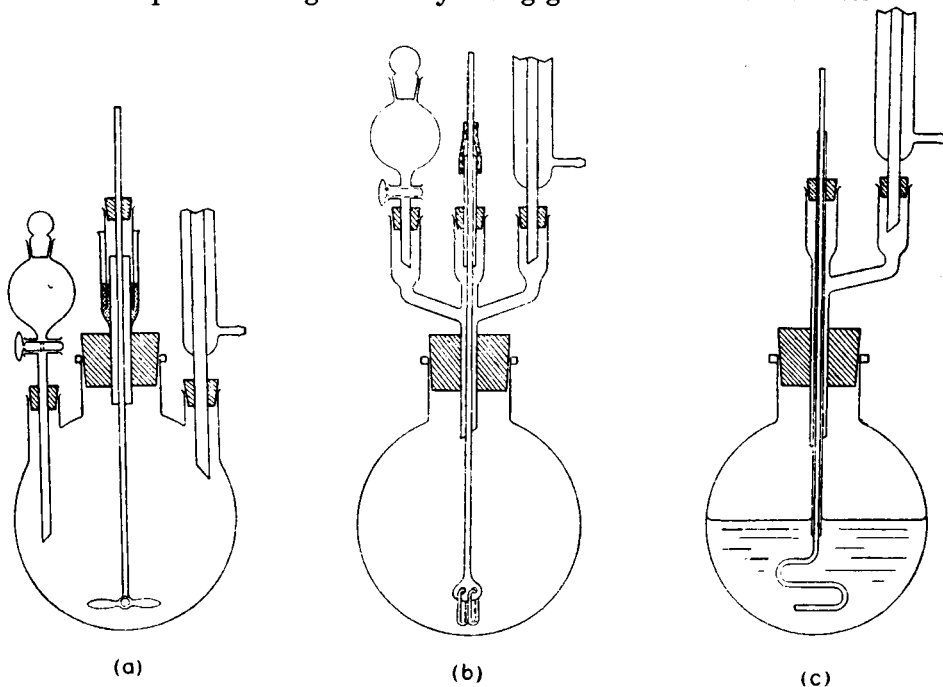

Fig. II, 7, 11.

well into the liquid so that the liquid itself serves to seal the stirrer. The dropping funnel is supported by means of a cork, into which a V-cut has been made to allow for the expansion of the air, at the top of the condenser. The mercury-sealed stirrer in (*a*) may be replaced by the glycerine-sealed stirrer illustrated in (*b*).

If it is desired to carry out the combined operations of stirring, refluxing, and addition of a liquid in a stream of gas, the apparatus of Fig. II, 7, 12, *a* may be used: the side tube for the gas is sealed on to the separatory funnel. For the passage of a gas into a stirred liquid, the aperture carrying the modified separatory funnel may be fitted with the device shown in Fig. II, 7, 12, *b*; the glass rod inside the tube is held in position by a short length of heavy-wall rubber tubing and is employed to clear the lower end of the gas delivery tube, should it become blocked with solid reaction product.

If a solid reagent, which is affected by moisture in the atmosphere (*e.g.*, anhydrous aluminium chloride), is to be added in small portions to a reaction mixture which is being refluxed and/or stirred, one aperture of the three-necked flask is fitted with a length of wide, thin-walled rubber tubing (say, a 12 cm. length of 20 mm. tubing) and a 100 or 250 ml. conical flask containing the reagent is inserted into the other end of the tubing (Fig. II, 7, 12, *c*). The solid is readily added in portions by raising the flask; the latter can be cut off from the reaction mixture by kinking the rubber tube. An alternative device for adding a solid intermittently to a stirred reaction mixture in a multi-necked flask is depicted in Fig. II, 7, 12, *d*, and is almost self-explanatory. It may be constructed, if desired,

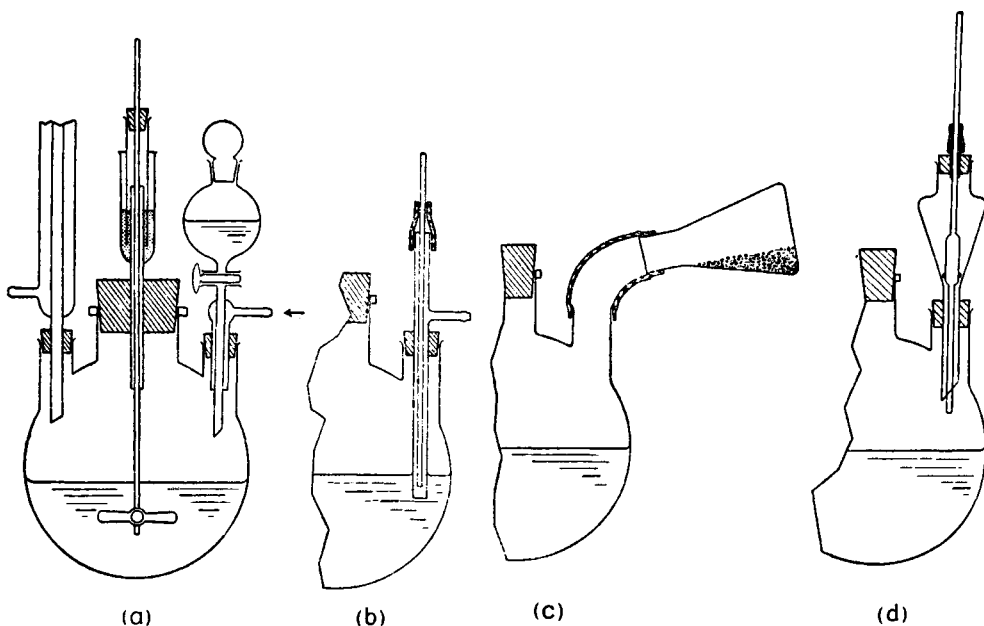

Fig. II, 7, 12.

from a small Pyrex Erlenmeyer flask and a broken pipette. The solid is charged into the conical reservoir; by raising the plunger to the appropriate height, any desired amount of the solid may be made to flow into the reaction vessel, and the flow can be completely stopped by merely twisting down the plunger until the rubber ring seals the opening. The rubber ring should be, say, 3 mm. thick and 5 mm. wide; if solvents which attack rubber are present, a neoprene gasket may be used. The rubber tubing at the top is lubricated with glycerine or castor oil (Kyrides seal) to make an air-tight joint which will allow free movement of the plunger. The hopper may be recharged during a reaction without breaking the seal by lifting the stopper while holding down the pipette.

It is sometimes necessary (*e.g.*, in reactions involving organolithium compounds or in certain Grignard preparations) to carry out a reaction

in an atmosphere of an inert gas, such as nitrogen. A suitable set-up is shown in Fig. II, 7, 13. Dry nitrogen is introduced at the top of the condenser and initially can be allowed to sweep through the apparatus and escape at the mouth of the dropping funnel: it will be noted that the latter has a pressure-equalising side tube. The mercury valve permits a slight pressure of gas. When the funnel is closed a slight positive pressure is maintained at the nitrogen cylinder, as indicated by the level of the mercury in the escape valve. This arrangement is economical in nitrogen and is to be preferred to the use of a continuous stream of inert gas since it obviates the evaporation of the solvent. The mercury-sealed stirrer is of the Hershberg type made of tantalum wire.

The mechanical shaking machine is employed for automatic mixing of heterogeneous systems and finds many applications in the organic chemistry laboratory. Numerous forms are available, but these are generally expensive.* A simple, efficient but inexpensive shaking machine, which can easily be constructed by a competent

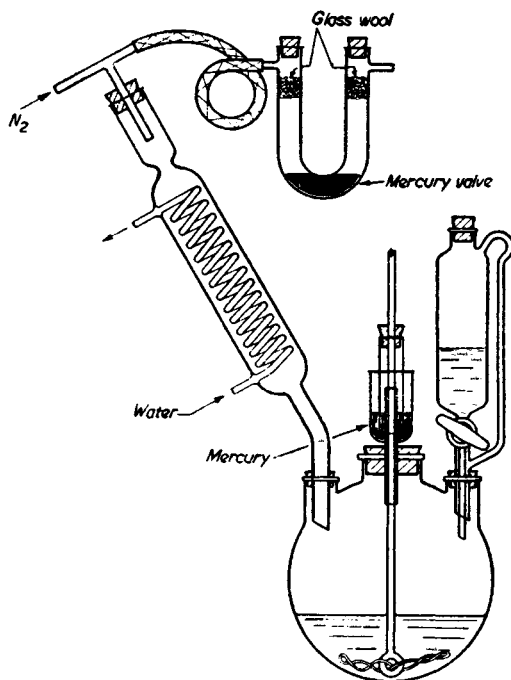

Fig. II, 7, 13

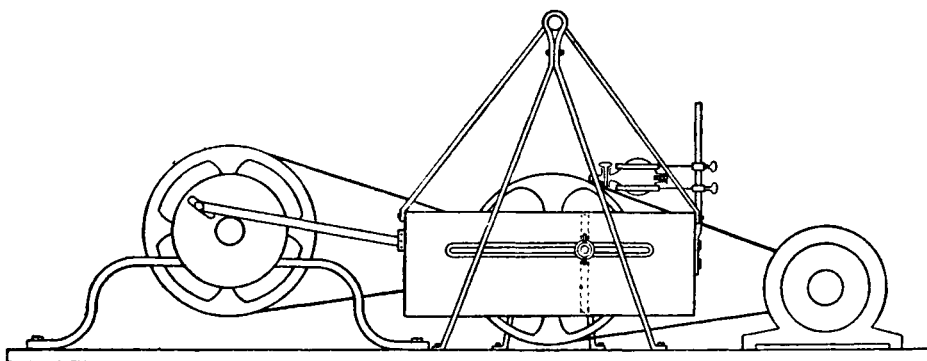

Fig. II, 7, 14.

mechanic, is illustrated in Fig. II, 7, 14. It is mounted on a heavy teak base (115 × 50 × 2.5 cm.). A 1/6 H.P. motor,† coupled with pulleys of

* The "Super Shaker," manufactured by A. Gallenkamp and Co. Ltd., is excellent.

† For example, a "capacitor motor," 1,425 r.p.m., supplied by British Thomson Houston Co. Ltd., Rugby, England.

suitable diameter and incorporating a V-belt to minimise slipping, shakes the wooden box ($40 \times 16 \times 10$ cm.), which will accommodate a "Winchester quart" bottle. The speed of shaking may be simply controlled by varying the size of pulley on the motor shaft. Any size of bottle may be securely held in the box by means of felt-covered wooden wedges, which are fixed by means of wing nuts passing through the metal slides fitted into the sides of the box. A rod is bolted to one side of the box to permit the clamping of flasks and separatory funnels; the latter are held in position by two retort rings covered with rubber (made by cutting rubber "pressure" tubing along its length).

Mention must also be made of magnetic stirring. A rotating field of magnetic force is employed to induce variable speed stirring action within either closed or open vessels. The stirring is accomplished with the aid of small permanent magnets sealed in Pyrex glass or in Polythene. The principle of magnetic stirring will be evident from Fig. II, 7, 15. A permanent bar magnet, mounted horizontally, is attached to the shaft of an electric motor: the whole is mounted in a cylindrical housing with flat metal top and heavy cast metal base. A resistance (which is frequently incorporated in the housing) is provided to control the rate of stirring. To use

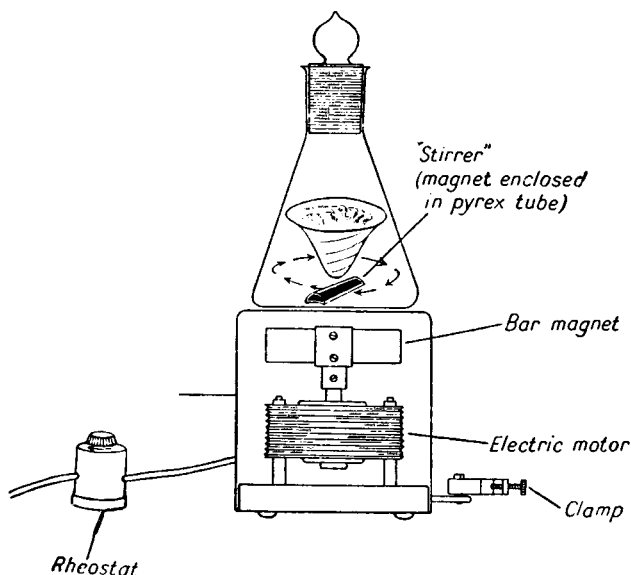

Fig. II, 7, 15.

the apparatus, the rheostat, which is initially in the off-position, is slowly rotated (this increases the motor speed) until the required rate of stirring is attained. When the experiment is complete, the rheostat is returned to the zero position, the "stirrer" allowed to come to rest and removed with the aid of a pair of forceps. Magnetic stirring has many obvious applications, but the most important are probably to stirring in closed systems, *e.g.*, (a) where gas volume changes must be observed as in catalytic hydrogenations, (b) where exclusion of air is desirable to prevent oxidation, (c) where reactions are to be carried out in an anhydrous environment, and (d) where small containers are used and the introduction of a propeller shaft is inconvenient.

Many forms and sizes of magnetic stirring apparatus are available commercially. These include those fitted with an electric hot plate attached to the flat top; the hot plate is controlled by an energy regulator or variable transformer (Variac).

II.8. GAS ABSORPTION TRAPS

The gas traps depicted in Fig. II, 8, 1, *a* and *b* are used when limited quantities of gas are to be absorbed. For larger volumes of gas, or where

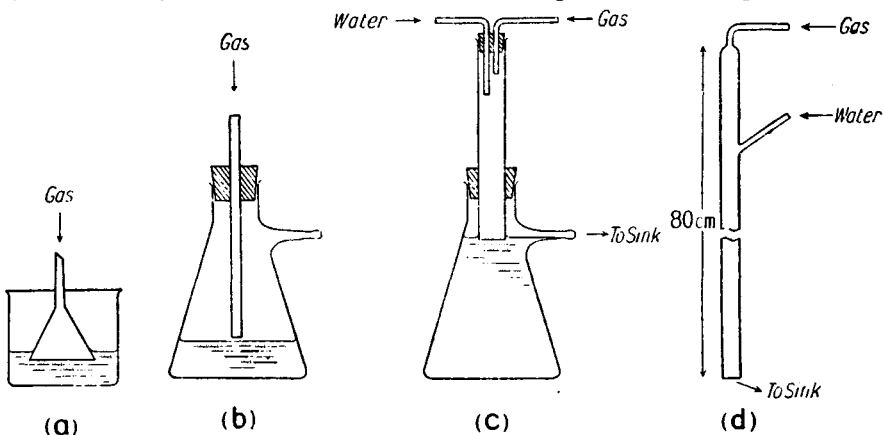

Fig. II, 8, 1.

the gas is rapidly evolved, the gas traps shown in Fig. II, 8, 1, *c* and *d* are eminently satisfactory. In (*c*) the gas is passed into a wide tube in which a stream of water (usually from a reflux condenser) flows into a large filter flask and overflows at constant level, which is above the lower end of the wide tube; a water seal is thus provided which prevents the escape of the gas into the atmosphere, and the heat of solution of the gas (*e.g.*, hydrogen chloride or hydrogen bromide) is dissipated. A convenient size for (*d*) is a tube 80–100 cm. long and about 25 mm. diameter.

A highly efficient gas-absorption apparatus* is depicted in Fig. II, 8, 2. The over-all length is about 15"; two inlets for obnoxious gases are provided, but one can be readily closed if not required. The waste water from a water condenser may be employed. The water enters in the middle of the apparatus and passes up the outer annulus, spraying out at the top of the tower on to $\frac{3}{8}$ " Raschig or similar rings. It then passes down the column and through the water trap at the bottom of the apparatus to waste through a side tube fitted with a siphon-breaking device. The contaminated gas enters at either side of the two inlet connexions and is absorbed by the water passing down the column.

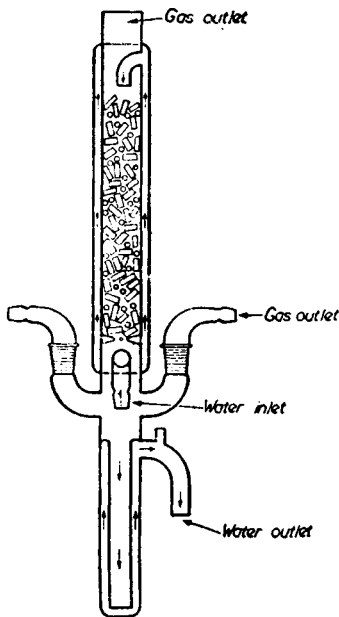

Fig. II, 8, 2

* Designed in the Research Laboratories of May and Baker Ltd., Dagenham.

II,9. CALIBRATION OF THERMOMETERS

The comparatively inexpensive long-scale thermometer, widely used by students, is usually calibrated for complete immersion of the mercury column in the vapour or liquid. As generally employed for boiling point or melting point determinations, the entire column is neither surrounded by the vapour nor completely immersed in the liquid. The part of the mercury column exposed to the cooler air of the laboratory is obviously not expanded as much as the bulk of the mercury and hence the reading will be *lower* than the true temperature. The error thus introduced is not appreciable up to about 100°, but it may amount to 3–5° at 200° and 6–10° at 250°. The error due to the column of mercury exposed above the heating bath can be corrected by adding a stem correction, calculated by the formula :

$$\text{Stem correction (in degrees)} = KN(t_1 - t_2)$$

where K = the apparent expansion coefficient of mercury in glass ;

N = the length, measured in degrees, of the part of the thermometer not heated to the temperature of the bulb, *i.e.*, the length of the exposed column ;

t_1 = the observed temperature ; and

t_2 = the mean temperature of the exposed mercury column (determined on an auxiliary thermometer placed alongside with its bulb at the middle of the exposed thread).

The value of K for normal glass is 0.000158 from 0° to 150° ; 0.000159 at 200° ; 0.000161 at 250° ; and 0.000164 at 300°. For borosilicate (Pyrex) glass the values of K are : 100°, 0.000164 ; 150°, 0.000165 ; 200°, 0.000167 ; 250°, 0.000170 ; 300°, 0.000174 ; 350°, 0.000178 ; 400°, 0.000183 ; and 450°, 0.000188. Owing to the difficulty of determining t_2 with any accuracy, the above correction cannot be applied with any degree of precision, but is sufficiently accurate for all ordinary purposes.

In addition to the error due to the exposed stem, ordinary chemical thermometers of low cost are subject to errors due to irregularities in the bore and sometimes the scale graduations may not be very accurate.* It is therefore essential to check the thermometer at several temperatures against the melting points of pure solids or the boiling points of pure liquids as described below. The application of an exposed stem correction will of course be unnecessary if the thermometer is calibrated in this way. A calibration curve may then be drawn upon "graph" paper from the data thus obtained. Temperatures at intervals of about 20° are marked as abscissae and the corrections to be added or subtracted as ordinates ; the points thus obtained are then connected by a smooth curve. The thermometer correction at any temperature may be read directly from the curve.

The stem correction may be avoided by employing a thermometer with a short scale (sometimes termed an *Anschütz thermometer*) and of such size that the entire column of mercury is immersed in the vapour or in the liquid. In practice, it is generally more convenient to use thermometers which have been graduated for *partial immersion* for a short and con-

* For advanced work, it is advisable to use a thermometer of better quality and which is provided with a small mercury bulb ; the latter rapidly attains the temperature of the bath or vapour. Satisfactory small bulb thermometers are manufactured *inter alia* by H. J. Elliott Ltd. and by Short and Mason Ltd.

venient length of the stem. A special mark is usually etched on the stem to indicate the depth of immersion and, provided that this is approximately adhered to, no serious error due to exposed stem will be present in the resulting reading of the thermometer. A thermometer which is to be used for distillation is usually graduated for 7.5 or 8 cm. immersion, whilst that for melting points may be graduated for 25 or 35 mm. immersion.

TABLE II, 9, A.—REFERENCE SUBSTANCES FOR THE CALIBRATION OF THERMOMETERS BY THE MELTING POINT METHOD

Water — ice	0.0° *
(α -Naphthylamine, A.R.	50°
Benzylidene aniline	52°
Diphenylamine, A.R.	53.5°
<i>p</i> -Dichlorobenzene	54°
(Phenyl benzoate	69°
Phenylacetic acid	76°
8-Hydroxyquinoline, A.R.	76°
Vanillin, A.R.	82°
<i>m</i> -Dinitrobenzene	89.5°
(Benzil	95°
α -Naphthol, A.R.	96°
Catechol	104°
(Resorcinol, A.R.	112°
Acetanilide	114°
Benzoic acid, A.R.	122°
(β -Naphthol, A.R.	123°
Urea	132°
(Phenylurea (mono)	148°
Benzilic acid	150°
<i>s</i> -Diphenylthiourea	154° *
(Salicylic acid, A.R.	159°
(Hydroquinone	170°
<i>p</i> -Tolylurea (mono)	181°
Succinic acid, A.R.	185°
(3 : 5-Dinitrobenzoic acid	205°
(<i>p</i> -Nitrobenzoic acid	239°
<i>p</i> -Chlorobenzoic acid	239°
(<i>s</i> -Diphenylurea	242°
(Cinchonine	264°
<i>s</i> -Di- <i>p</i> -tolylurea	268°
(<i>s</i> -Di- α -naphthylurea	298°
Diacetyl- <i>p</i> -phenylenediamine	303°
<i>NN</i> -Diacetylbenzidine	317°
(Fluorescein (for spot tests)	330°

* These compounds are unsuitable for use in the hot plate method, cf. Section II, 11, Fig. II, 11, 1.

Full experimental details for the determination of melting and boiling points are given in Sections II,10 and II,11 respectively. The Tables II, 9, A and II, 9, B list suitable substances for the calibration of thermometers by melting point or boiling point determinations respectively. Substances which are "bracketed" are alternative to each other. It need hardly be emphasised that only compounds of the highest purity should be employed.

TABLE II, 9, B.—REFERENCE SUBSTANCES FOR THE CALIBRATION OF THERMOMETERS BY THE BOILING POINT METHOD

COMPOUND	BOILING POINT (°C) AT 760 MM.	$\Delta t/10$ MM. (°C) *
Carbon disulphide	46.3°	0.42
Acetone	56.1°	0.39
Benzene	80.2°	0.43
Water	100.0	0.37
Toluene	110.8°	0.42
Ethylene dibromide.	131.7°	0.48
Chlorobenzene	132.0°	0.49
Bromobenzene	156.2°	0.53
Aniline	184.4°	0.51
Nitrobenzene	210.9°	0.48
Naphthalene	217.9°	0.58
Quinoline	237.5°	0.59
Diphenyl	255.5°	0.6
Benzophenone	305.9°	0.6

* Change in boiling point for every 10 mm. mercury pressure at 760 ± 20 mm.

The zero point is best determined with an intimate mixture of distilled water and pure ice made from distilled water. About 20 ml. of distilled water are placed in a boiling tube (150 × 25 mm.) and frozen partially by immersion in an ice-salt mixture; during the freezing the mixture is stirred with a glass rod until a thick slush is obtained. The boiling tube is then removed from the freezing mixture, the thermometer immersed in the slush so that the zero point is just visible; the mixture is stirred gently with the thermometer and the reading taken after the temperature has become constant (2-3 minutes).

The most satisfactory and the most accurate method for the calibration of a thermometer is to compare it directly with short-scale thermometers, each of limited range, which have been standardised at the National Physical Laboratory.† The comparison should be made as far as possible under the same conditions as the thermometer is to be used. For experiments demanding the highest precision (e.g., in research work), it is a good plan to have two similar sets of short-scale thermometers, one of which has been standardised at the N.P.L.; the unstandardised set is

† The Bureau of Standards in the U.S.A., etc.

directly compared with the certified set and employed for all routine operations. The standardisation should be made at least once a year.

II,10. EXPERIMENTAL DETERMINATION OF THE MELTING POINT

The theory of melting and freezing has been discussed in Sections I,10-I,18. A pure crystalline organic compound has, in general, a definite and sharp melting point, that is, the melting point range (the difference between the temperature at which the collapse of the crystals is first observed and the temperature at which the sample becomes completely liquid) does not exceed about 0.5° . The presence of small quantities of miscible, or partially miscible, impurities will usually produce a marked increase in the melting point range and cause the commencement of melting to occur at a temperature lower than the melting point of the pure substance. The melting point is therefore a valuable criterion of purity for an organic compound.

A sharp melting point is usually indicative of the high purity of a substance. There are, however, some exceptions. Thus a eutectic mixture of two or more compounds (Section I,12) may have a sharp melting point, but this melting point may be changed by fractional crystallisation from a suitable solvent or mixture of solvents. The number of exceptions encountered in practice is surprisingly small, hence it is reasonable to regard a compound as pure when it melts over a range of about 0.5° (or less) and the melting point is unaffected by repeated fractional crystallisation.

In addition to the use of a melting point determination as a criterion of purity, an equally valuable application is for the identification of organic compounds. If the melting point is known within one degree, the major proportion of possible substances is immediately eliminated from consideration. The study of the general chemical properties of the compound and a mixed melting point determination (Section I,17) will largely establish the identity of the compound.

The experimental method in most common use is to heat a small amount (about 1 mg.) of the substance in a capillary tube attached to a thermometer which is immersed in a suitable bath of liquid, and to determine the temperature at which melting occurs. The capillary melting point tubes are prepared either from soft glass test-tubes or from wide glass tubing (*ca.* 12 mm. diameter).^{*} A short length of glass tubing or glass rod is firmly fused to the closed end of the test-tube. The test-tube (or wide glass tubing) must first be thoroughly washed with distilled water to remove dust, alkali and products of devitrification which remain on the surface of the glass, and then dried. The closed end of the test-tube is first heated whilst being slowly rotated in a small blowpipe flame: the glass rod or tube is simultaneously heated in the same manner (Fig. II, 10, 1, a). When the extremities of both pieces of glass are red hot, they are firmly fused together, twisting of the joint being avoided, and then

^{*} Pyrex glass is preferable, but this requires an oxy-coal gas blowpipe for manipulation. Suitable melting point tubes may be purchased from dealers in scientific apparatus or chemicals. It is, however, excellent practice, and an essential part of his training, for the student to learn to prepare his own capillary tubes.

removed momentarily from the flame until the seal is just rigid enough that no bending occurs. The test-tube is then immediately introduced into a large "brush" flame (Fig. II, 10, 1, b) so that a length of about 5 cm. is heated, and the tube is rotated *uniformly* in the flame. When the heated portion has become soft and slightly thickened as the result of the heating, the tube is removed from the flame and, after a second or two, drawn, slowly at first and then more rapidly, as far apart as the arms will permit (or until the external diameter of the tube has been reduced to 1-2 mm.). If the operation has been successfully performed, a long capillary of regular bore throughout most of its length will be obtained. The long thin tube is then cut into lengths of about 8 cm. by touching it *lightly* with a file and then tapping gently with the flat portion of the file; after a little practice, no difficulty should be experienced in dividing the long capillary into suitable lengths without crushing the fragile tubing. It will be found that a short length of tubing ("glass spindle"), sufficiently rigid to act as a holder, will remain attached to the test-tube after the long capillary has been cut off. The operation may then be repeated. When the test-tube becomes too short to be handled at the open end, a piece of

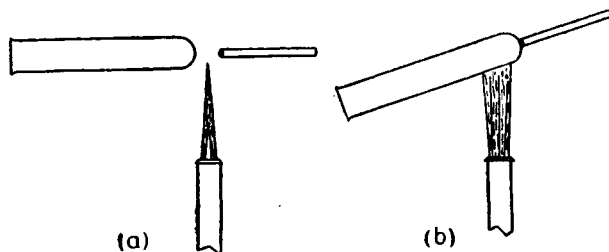

Fig. II, 10. 1.

glass tubing or rod may be fused on, in the manner previously described, to act as a convenient handle. In this way a large number of capillary tubes may be prepared from one test-tube. One end of each of the capillary tubes should be sealed by inserting it horizontally into the extreme edge of a small Bunsen flame for a few seconds, and the capillary tube rotated meanwhile; the formation of a glass bead at the end of the tube should be avoided. The prepared capillary tubes should be stored either in a large specimen tube or in a test-tube closed with a cork.

The capillary tube is then filled as follows. About 0.1 gram of the dry substance is placed on a glass slide or upon a fragment of clean porcelain plate and finely powdered with a clean metal or glass spatula, and then formed into a small mound. The open end of the capillary tube is pushed into the powder, "backing" the latter, if necessary, with a spatula. The solid is then shaken down the tube by tapping the closed end on the bench or by gently drawing the flat side of a triangular file (a pocket "nail file" is quite effective) along the upper end of the tube. The procedure is repeated until the length of lightly-packed material is 3-5 mm. Any substance adhering to the outside of the tube must be wiped off so that it will not discolour the bath.

The filled melting point tube is now attached to the lower end of a thermometer in such a way that the substance is at the level of the middle

of the mercury bulb (which has previously been wetted with the bath liquid); the moistened capillary is then slid into position. Advantage is taken of the surface tension of the bath liquid to hold the melting point tube in position by capillary attraction; the use of a thin rubber band, prepared by cutting narrow rubber tubing, to attach the capillary tube near the open end to the thermometer is not recommended. The thermometer, with the tube attached, is inserted into the centre of the bath;

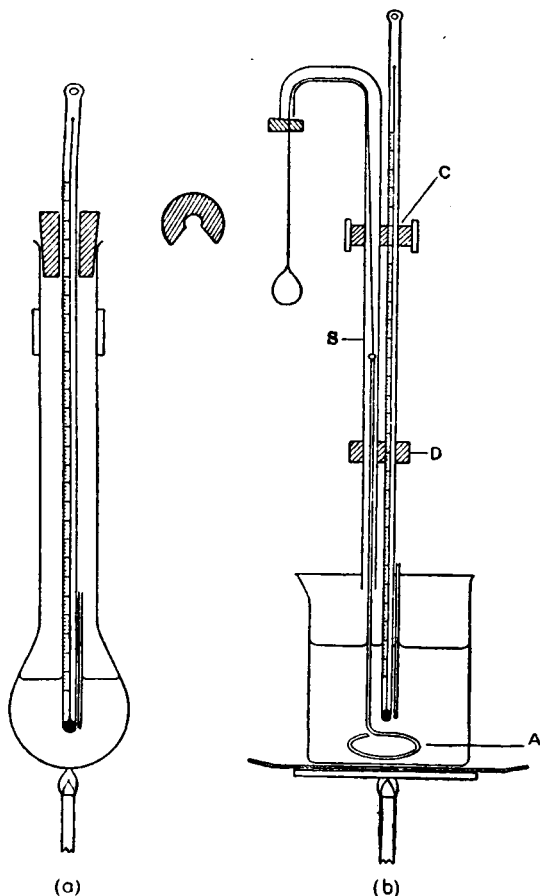

Fig. 11, 10, 2.

the melting point tube should extend about as far along above the liquid as it does in the liquid in order to ensure that the capillary force will be large enough to hold it to the thermometer.

Two convenient forms of bath are shown in Fig. 11, 10, 2, *a* and *b*. The former consists of a long-necked, round-bottomed flask (a long-necked Kjeldahl flask of 100 ml. capacity is quite satisfactory) supported by means of a clamp near the upper part of the neck. The thermometer is fitted through a cork, a section of the cork being cut away (see inset) so that the thermometer scale is visible and also to allow free expansion of the air in the apparatus. The bulb is about three-quarters filled with

concentrated sulphuric acid.* The apparatus of Fig. *II, 10, 2, b* consists of a small Pyrex beaker (e.g., of 250 ml. capacity) containing the bath liquid, which may be stirred by means of a small glass stirrer *A* so placed that its shaft is in the glass tube *B*. The thermometer and glass tube are held together by passing through holes in the corks *C* and *D*. The stirrer is connected by a length of string through the tube *B* as shown, and is prevented from falling to the bottom of the beaker by a small cork or knot at the extreme end. This melting point apparatus is supported on a gauze-covered ring attached to a retort stand, which also holds the thermometer and tube in a clamp round the cork *C*. Stirring of the bath liquid is effected by suitable manipulation of the string, and should be conducted at a regular rate throughout the heating.

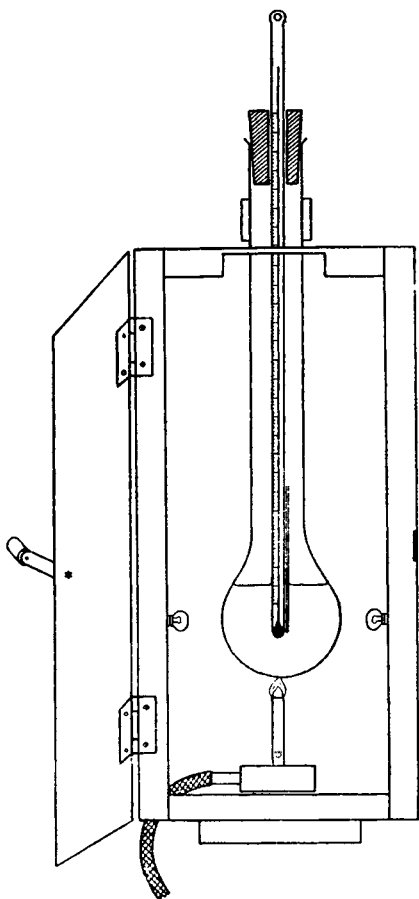

Fig. *II, 10, 3*.

Fig. *II, 10, 3*, depicts a "housing" for the apparatus of Fig. *II, 10, 2, a*; it is easily constructed from lengths of "angle iron" and asbestos board. If desired, "torch" bulbs may be fixed in the appropriate holders in the walls, and connected with a dry battery or accumulator in order to provide illumination of the melting point apparatus. The electric bulb immediately behind the apparatus should be connected to an independent micro-switch. Alternatively,

* The bath liquid generally employed is concentrated sulphuric acid: this may be heated to a temperature of 250–280° in the apparatus of Fig. *II, 10, 2, a*, but only to 200–220° in the open beaker heating bath owing to the excessive fuming above this temperature range. By boiling together in a fume cupboard either 70 parts by weight of concentrated H_2SO_4 and 30 parts by weight of K_2SO_4 or 55 parts by weight of concentrated sulphuric acid with 45 parts by weight of KHSO_4 , until the solid has dissolved (5–10 minutes), a bath liquid, possessing the consistency of glycerine and which does not fume badly, is obtained: this may be employed in an open beaker for temperatures between 220° and 320° (Mulliken). If the sulphuric acid becomes discoloured, the addition of a few crystals of sodium or potassium nitrate will restore the original colour.

Another convenient heating liquid is medicinal paraffin; it has a low specific heat, is non-inflammable and is non-corrosive, but it can only be safely heated to about 220°; above this temperature it begins to decompose slightly.

A mixture of equal parts of cottonseed oil and castor oil, containing about 1 per cent. of hydroquinone as an anti-oxidant, is a useful bath liquid which can be heated up to about 250°.

The highly stable and heat-resistant Silicone oils are very satisfactory. Midland Silicone or Dow-Corning fluid 550 or 500 (or the equivalent I.C.I. product) is recommended. Their only drawback is their high cost.

the melting point capillary may be illuminated by holding a small electric "torch" in front of the bulb of the flask. The clamp supporting the flask is outside the "housing" and is attached to a retort stand which forms the base of the apparatus. The flask is heated by means of an "arsenic" or micro burner.

The melting point apparatus is heated comparatively rapidly with a small flame until the temperature of the bath is within 15° of the melting point of the substance, and then slowly and regularly at the rate of about 2° per minute until the compound melts completely. The temperature at which the substance commences to liquefy and the temperature at which the solid has disappeared, *i.e.*, the melting point range, are observed. For a pure compound, the melting point range should not exceed $0.5-1^{\circ}$; it is usually less. Any sintering or softening below the melting point should be noted as well as any evolution of gas or any other signs of decomposition.* If the approximate melting point is not known, it is advisable to fill two capillaries with the substance. The temperature of the bath may then be raised fairly rapidly using one capillary tube in order to determine the melting point approximately; the bath is then allowed to cool about 30° , the second capillary substituted for the first and an accurate determination made.

It should be noted that a second determination of the melting point should not be made as the bath liquid cools by observing the temperature at which the molten material in the capillary tube solidifies, or by reheating the bath after the solidification has occurred. This is because, in many cases, the substance may partially decompose, and, in some instances, it may undergo a change into another crystalline form possessing a different melting point. A freshly-filled capillary tube should always be employed for each subsequent determination. Substances which sublime readily are sometimes heated in melting point capillaries sealed at both ends. For compounds which melt with decomposition, difficulties sometimes arise in the melting point determination; it is best to insert the capillary tube into the bath when the temperature is only a few degrees below the melting and decomposition point of the material. This avoids decomposition, with consequent lowering of the melting point, during the time that the temperature of the bath liquid is being raised.

After the melting point has been determined, the thermometer reading is corrected by reference to the calibration chart of the thermometer. Methods for calibrating a thermometer are described in Section II,9.

The melting point of a substance which melts either slightly above or below the laboratory temperature is conveniently determined in the apparatus illustrated in Fig. II, 10, 4. It consists of a test-tube supported in a slightly larger test-tube by means of a cork (thus forming an air jacket and preventing too rapid a change of temperature) and cooled in a suitable bath, *e.g.*, of crushed ice. The inner test-tube is provided with a thermometer and a stirrer (preferably of glass), and is supported by means of a clamp. Sufficient substance is introduced to cover the bulb of the thermometer when completely molten. The compound is

* A substance which commences to soften and pull away from the sides of the capillary tube at (say) 120° , with the first appearance of liquid at 121° and complete liquefaction at 122° with bubbling, would be recorded as m.p. $121-122^{\circ}$ (decomp.), softens at 120° .

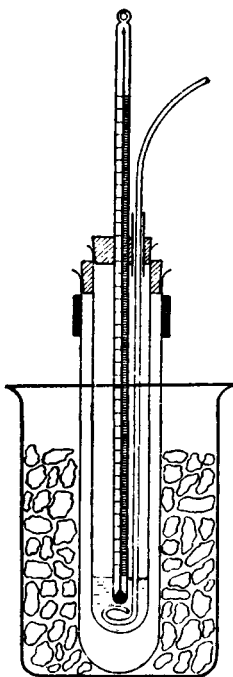

Fig. II, 10, 4.

first melted, *e.g.*, by immersing the tube in warm water, the apparatus set up as in the figure, and the appropriate cooling mixture placed in the beaker (cold water, ice or a freezing mixture), according to the melting point of the substance) so that the rate of cooling is about 0.5° per minute. Both the liquid substance and the cooling bath are kept well stirred, and temperature readings are taken at half-minute or one minute intervals; this is continued until the compound has fully solidified. Upon plotting temperatures (ordinates) against time (abscissae), a horizontal portion will be obtained in the cooling curve, if the substance is pure (compare Section I,13); this corresponds to the **freezing (or setting) point**. It is advisable to determine the melting point also. The cooling bath is removed and replaced, if the substance melts above room temperature, by a bath of warm water. Stirring is continued as before and temperatures are observed at regular intervals until the substance is completely fluid. Upon plotting the temperature-time graph (heating curve), the break in the curve (horizontal portion for a pure substance) takes place at the **melting point**. For pure compounds the melting point and freezing point are identical.

It must be emphasised that the above method applies only to substances which melt without decomposition.

II,11. MISCELLANEOUS FORMS OF MELTING POINT APPARATUS

Several forms of apparatus employing electrical heating will be described. A simple form may be readily constructed from a domestic "electric iron" of 400–500 watts rating. The handle is removed, and two holes of 8 mm. diameter are drilled through the base (*ca.* 11 mm. thick) so that they meet in the centre of the block. One hole is for a 360° thermometer (small bulb); the other hole is spare and can be used for comparison with a standard thermometer. The heater is mounted on a sheet of thick asbestos board which is fixed to an appropriate wooden base. The wires from the heating unit are connected to two insulated terminals fitted on the board (Fig. II, 11, 1). The rate of heating is controlled by either of the following methods:

(i) A rheostat (*e.g.*, a Zenith double-tubular sliding adjustable resistance type D with lead-screw motion, 230 ohms resistance to carry 2.8 amperes, is suitable).

(ii) A variable voltage transformer (*e.g.*, a Variac transformer, enclosed model, type 200-CMH, is satisfactory; a compact assembly is thus obtained).

With a little experience, the correct setting for any desired rate of heating (from rapid heating to about 1° per minute) may be obtained.

The area immediately over the bulb of the thermometer has a uniform temperature, and is employed for melting point determinations. The exact size of the uniform temperature area is determined by spreading a solution of a substance possessing a conveniently low melting point (*e.g.*, urea) over the surface of the plate, and evaporating the solution by raising the temperature of the hot plate slightly. A thin coating of the substance remains on the surface. The temperature is then raised rapidly until within $5-10^\circ$ of the melting point, after which the heating is adjusted to give a temperature rise of about 1° per minute. The area inside which the substance melts within 0.5° of the melting point (132° for urea) is noted; it is convenient to mark this first (temporarily) with chalk and later (permanently) with a diamond. The process may be repeated, if desired, with other substances of different melting points, but substantially the same result will be obtained. To determine the melting point of a substance, a small quantity of the substance is finely powdered and placed in the centre of the area of constant temperature. The temperature is raised comparatively rapidly to within 3° or 4° of the melting point and then the temperature rise is reduced to $0.5-1^\circ$ per minute. The moment an instantaneous fusion is observed, the temperature is read and is recorded as the melting point of the substance. The apparatus is allowed to cool somewhat, and the surface of the heater is wiped with glass wool or, cautiously, with a damp cloth.

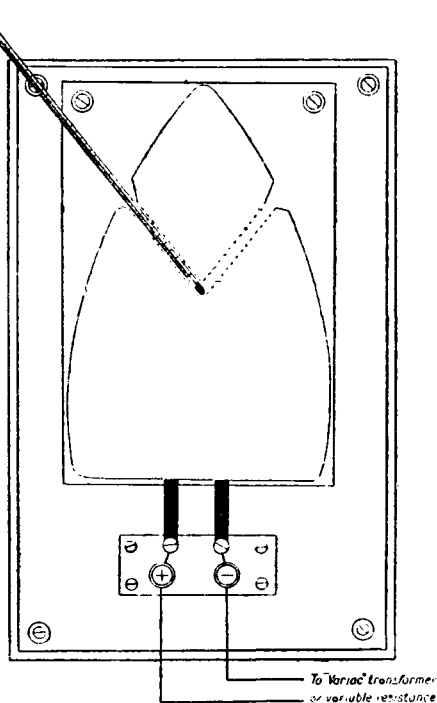

Fig. 11, 11, 1.

The advantages of the above "electric hot plate method" for the determination of melting points are obvious; these include:—

(1) The elimination of the liquid baths and, in consequence, the absence of burns due to accidental breakage of the ordinary glass apparatus.

(2) No glass melting point capillaries need be prepared.

(3) The wide temperature range covered (room temperature to 360° and even higher, if necessary).

(4) Several melting points can be simultaneously determined; the substances must of course be placed in separate minute heaps in the constant temperature area on the surface of the apparatus.

The only disadvantage is that the procedure does not give accurate results if the compound sublimes: the capillary tube method should be used in such cases, and it may be necessary to employ a sealed capillary tube. This apparatus should find a place in every laboratory. It is

strongly recommended as a desirable alternative to that involving the use of a liquid bath and a capillary tube. Possible improvements for precision

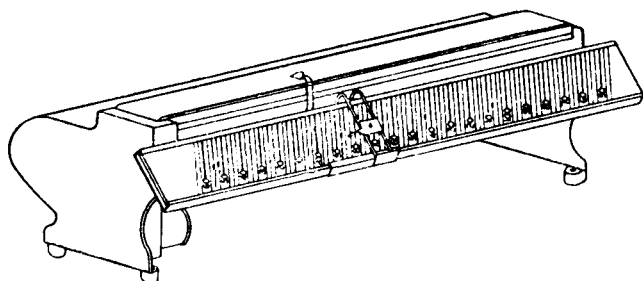

Fig. II, II, 2

work are (a) replacement of the chromium-plated surface by a plating of a noble metal or alloy in order to increase its resistance to the action of liquid organic compounds, and (b) a purpose-made internal resistance so designed as to increase the area of constant temperature.

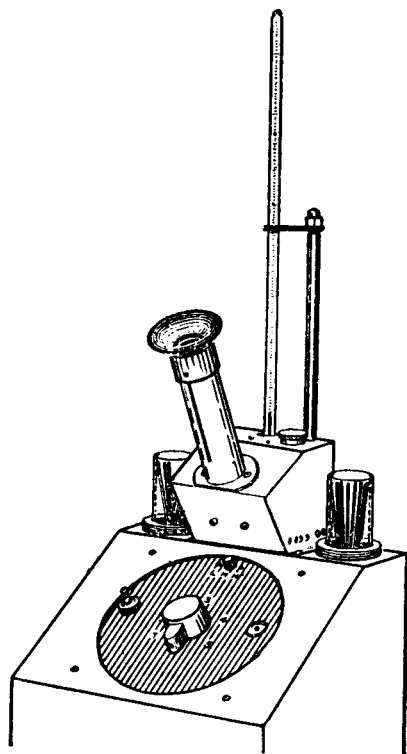

Fig. II, II, 3.

The Kofler hot bench,* illustrated in Fig. II, II, 2, consists of a metal alloy band with chromium-plated surface, 36 cm. long and 4 cm. wide, heated electrically at one end, the other end remaining unheated. It is claimed that a moderate and constant temperature gradient is thus produced. Fluctuations in the mains voltage are compensated for by a built-in stabiliser. At any point from the heated end, there is a definite and constant temperature. The graduations cover the range 50° to 260° C. in 2° . Provision is made for variations in room temperature by adjustment on the reading device moving over the scale. The current must be switched on at least one hour before the apparatus is required and the latter should be surrounded by a screen to protect it from draughts. The hot bench should be calibrated before use with the aid of several of the substances supplied by the manufacturers. The test substances include:— azobenzene, m.p. 68° ;

benzil, m.p. 95° ; acetanilide, m.p. 114° ; phenacetin, m.p. 135° ; benzanilide, m.p. 163° ; salophene (acetylaminosalol), m.p. 190° ; and saccharin, m.p. 228° . The melting point is

* Manufactured by C. Reichert Akt., Wien xvii, Austria. It is available from Shandon Scientific Company, 6 Connaught Place, London, S.W. 7.

readily determined by sprinkling a few small crystals of the substance on the hot bench; these may be moved along the bench by the brass lancet attached to the reading device. Usually a sharp division occurs between the solid and liquid, and the temperature corresponding to the line of demarcation is read off on the scale. For maximum accuracy, the apparatus should be recalibrated with two test substances with melting points close to that of the unknown. The procedure is clearly rapid and is very useful for substances which tend to decompose upon gradual heating. It is important not to allow any of the molten substance to remain on the chromium-plated surface for long periods; it should be wiped away with clean filter paper immediately after the experiment. It is an advantage to platinise the surface of the heating bar; possible attack by organic substances is thus avoided.

A commercial form of electrically-heated melting point apparatus,* designed for the simultaneous observations of two *capillary tubes*, is shown in Fig. II, 11, 3. A copper block, bored with holes for the capillaries and the thermometer, is wound with glass-covered resistance wire; special provision is made for various rates of heating by the incorporation of a specially tapped transformer. There is a central hole for viewing the capillaries, but this hole terminates near the central thermometer opening; the capillaries are illuminated by reflected light from a 6-volt lamp passing down a solid glass rod in an opening on the same level as the viewing hole but at an angle to it.

II,12. EXPERIMENTAL DETERMINATION OF THE BOILING POINT

The theory of the process is discussed in Sections I,1-I,3. The apparatus of Fig. II, 12, 1 may be used when moderate quantities of the substance are available. *A* is a 50 ml. distilling flask attached by a cork to a Liebig condenser *B*, upon the end of which an adapter *C* is fitted: *D* is a receiver for collecting the distillate. The thermometer *E* is fitted into the neck of the distilling flask by means of a well-bored cork; the bulb of the thermometer should be in the centre of the neck of the flask and slightly below (*ca.* 5 mm.) the level of the side tube. The flask may be heated on a wire gauze with asbestos centre or preferably in an air bath (Fig. II, 5, 3).

The following hints on the setting up of the apparatus will be useful for beginners.

1. All corks should fit tightly, since the apparatus may be used for inflammable liquids.
2. All clamps holding glass apparatus should be lined with cork, attached by means of glue or "seccotine", or with asbestos paper; this will reduce the danger of fracture if excessive pressure is exerted on the clamp.
3. The flask, condenser and receiver should be set up independently with such clamps as are necessary and arranged at the back of the apparatus in as nearly the correct position as possible.

* This is the "Reflected Light Melting Point Apparatus" marketed by Townson and Mercer Ltd., Croydon, England.

4. The size of the flask to be employed depends upon the quantity and nature of the liquid to be distilled; it should be one half or at most two-thirds full. If too large a flask is used, superheating and, sometimes, decomposition may occur.

5. The upper outlet for water from the condenser should be above the jacket so as to ensure that the condenser is full of water. If the rubber tube, which carries the waste water to the sink, tends to kink, a short copper spiral, made by winding a length of copper wire round a glass tube, may be slipped over the end attached to the condenser.

The liquid should be poured into the distilling flask, preferably through a funnel the stem of which extends below the side arm, and a few fragments of unglazed porous porcelain ("porous pot," see Section I,2)

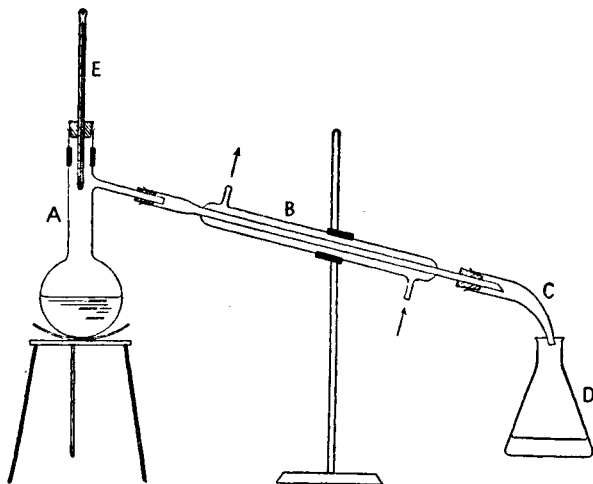

Fig. II, 12, 1.

added, and the thermometer placed in position. The "porous pot" will promote regular ebullition in the subsequent heating; they should *never* be added to the hot liquid. The flask is heated on a wire gauze or in an air bath. Heating may be rather rapid until boiling commences; the flame must then be decreased and adjusted so that the distillate is collected at the rate of one or two drops per second. It must be borne in mind that at the commencement of the distillation it takes an appreciable time for the vapour to heat the upper part of the flask and the thermometer. The distillation should not be conducted too slowly, for the thermometer may momentarily cool from lack of a constant supply of fresh vapour on the bulb, and an irregular boiling point will result; on the other hand, the flame should not be too large for it may heat directly a part of the vapour as well as the liquid, and superheating may occur.

It will be found that the temperature will first rise rapidly until it is near the boiling point of the liquid, then slowly, and finally will remain practically constant. It is a good plan to watch for the ring of condensing vapour in the neck of the flask and to attempt to hold this at

least about one cm. above the side arm of the flask by appropriately controlling the flame. The distillation should be continued until only a small volume of liquid remains in the flask; the temperature is noted at regular intervals. If the liquid is pure, most of it will pass over at constant temperature (within 0.5°); this constant temperature is the boiling point of the liquid. Towards the very end of the distillation the temperature may rise slightly owing to superheating. The necessary correction to the thermometer, as determined from the calibration chart, should be applied in order to obtain the correct boiling point.

When the boiling point of the liquid is above $140-150^\circ$, an air condenser (Fig. II, 4, 1, c) may replace the water condenser. If the liquid is inflammable, the conical flask may be replaced by a filter or suction flask (see Fig. II, 1, 7, c), and a length of rubber tubing leading to the sink is attached to the side tubulure.

When only minute quantities of liquid are available, either of two micro methods for the determination of the boiling point may be used.

Method 1 (Siwoloboff's method, 1886).—Two tubes, closed at one end, are required; one, an ordinary melting point capillary, 90–110 mm. long and 1 mm. in diameter, and the other, 80–100 mm. long and 4–5 mm. in diameter. The latter may be prepared from 4–5 mm. glass tubing and, if desired, a small thin bulb, not exceeding 6 mm. in diameter, may be blown at one end. A small quantity of the liquid, 0.25–0.5 ml. (depending upon the boiling point), is placed in the wider tube, and the capillary tube, with sealed end uppermost, is introduced into the liquid.



Fig. II, 12, 2.

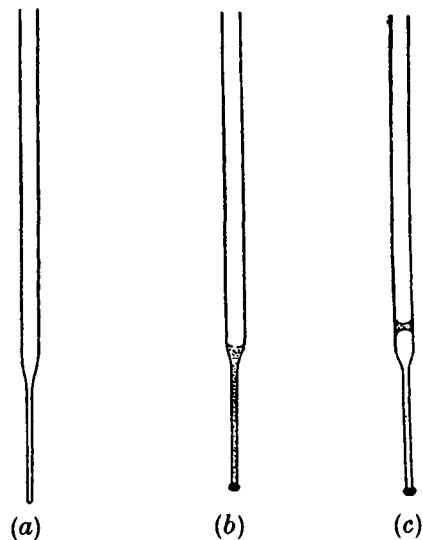

Fig. II, 12, 3.

The tube is then attached to the thermometer by a rubber band (Fig. II, 12, 2), and the thermometer is immersed in a bath of a melting point apparatus (see Fig. II, 10, 2). As the bath is gradually heated there will be a slow escape of air bubbles from the end of the capillary tube, but when the boiling point of the liquid is attained, a rapid and continuous escape of air bubbles will be observed. The reading of the thermometer when a rapid and continuous stream of air bubbles first emerges from the capillary tube is the boiling point of the liquid. Unless the temperature is raised very slowly in the vicinity of the boiling point of the liquid, the first determination may be slightly in

error. A more accurate result is obtained by removing the source of heat when the rapid stream of bubbles rises from the end of the capillary tube; the speed at which bubbles are given off will slacken and finally,

when the last bubble makes its appearance and exhibits a tendency to suck back, the thermometer is read immediately. This is the boiling point of the liquid because it is the point at which the vapour pressure of the liquid is equal to that of the atmosphere. As an additional check on the latter value, the bath is allowed to cool a few degrees and the temperature slowly raised; the thermometer is read when the first continuous series of air bubbles is observed. The two thermometer readings should not differ by more than 1°.

Method 2 (Emich's method).—A capillary tube about 10 cm. long and of about 1 mm. bore is used. One end is drawn out by means of a micro flame into a capillary with a very fine point and about 2 cm. long as in Fig. II, 12, 3, a. Such a capillary pipette may also be constructed by suitably drawing out soft glass tubing of 6–7 mm. diameter. The tube (a) is then dipped into the liquid of which the boiling point is to be determined; the liquid will rise slowly by capillary attraction, and the tube is removed when the liquid has filled the narrow conical portion. The capillary end is then sealed by merely touching with a minute flame. A small air bubble is formed in the point of the capillary; it should be examined with a lens to make sure that it is not too large. A convenient size is 1–3 mm. long (Fig. II, 12, 3, b). The prepared capillary tube is then attached to a thermometer as in a melting point determination (Section II,10) and slowly heated in an open bath, which is kept well stirred. The capillary is best observed with a lens. When the bubble enlarges (as in Fig. II, 12, 3, c) and begins to exhibit signs of upward motion, the flame is removed or considerably lowered. The temperature at which the bubble reaches the surface of the bath liquid is the boiling point of the liquid. The bath is allowed to cool about 10° below the first observed boiling point, then slowly heated again, and a second determination of the boiling point is made.

II,13. TYPICAL ASSEMBLIES OF APPARATUS FOR DISTILLATION AND REFLUXING

In order to avoid duplication of diagrams in the actual description of preparations given in Chapters III *et seq.*, the set-up of apparatus involving the processes of distillation or refluxing will be collected in this section. Heating in all cases may be on an asbestos-centred wire gauze, in a water or oil bath, or, best, by means of an air bath (Fig. II, 5, 3): the manner of heating the vessel (distilling flask, flask, etc.) will therefore not be shown in the diagrams. Adapters may be employed, as in Fig. II, 13, 3, where the receiver cannot be conveniently supported at the end of the condenser.

Fig. II, 13, 1 illustrates a distillation unit when it is desired to protect the distillate from moisture in the atmosphere. The "drying tube" may be filled with anhydrous calcium chloride held in position by loose plugs of glass wool or with a loose plug of cotton wool. Fig. II, 13, 2 depicts the use of an air condenser for liquids of boiling point above 140–150°.

In Fig. II, 13, 3 the distillation is conducted from a flask. This apparatus is used when it is desired to distil the product of a reaction

which has been conducted in a round-bottomed flask. It is not recommended when a distilling or Claisen flask can be used. The apparatus may also be employed for the distillation of inflammable or other solvents from a solution; here the receiver should be a filter flask as in Fig. 11, 13, 4.

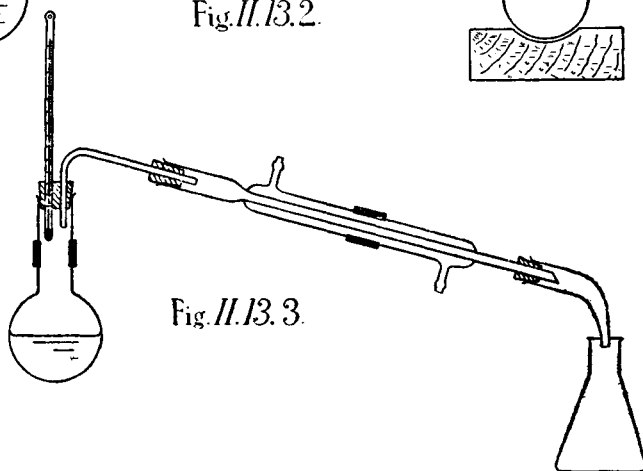
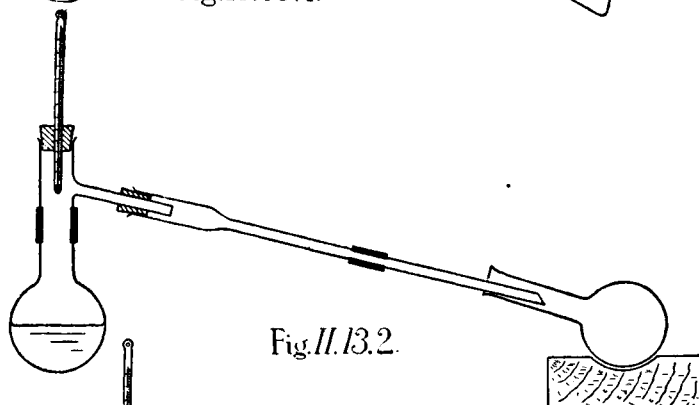
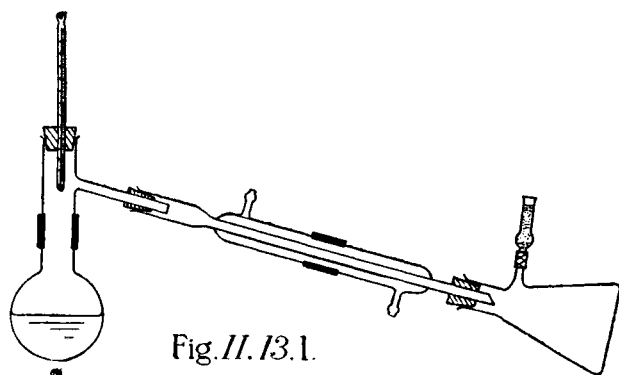

In certain circumstances it may be necessary to introduce a short fractionating column between the flask and the condenser; the thermometer is then inserted at the top of the column.

Fig. 11, 13, 4 shows an assembly which is useful *inter alia* for distilling off solvents from solutions. The solution is placed in the separatory

funnel and is allowed to drop into the flask, initially about half-full with the solution, at approximately the same rate as that at which the solvent distills into the receiver. The use of a large flask for distilling the solution is thus rendered unnecessary. The distilling flask (alternatively, a

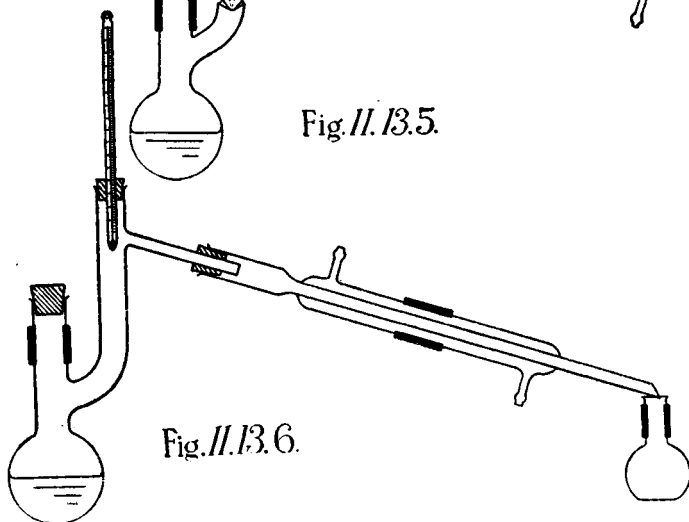
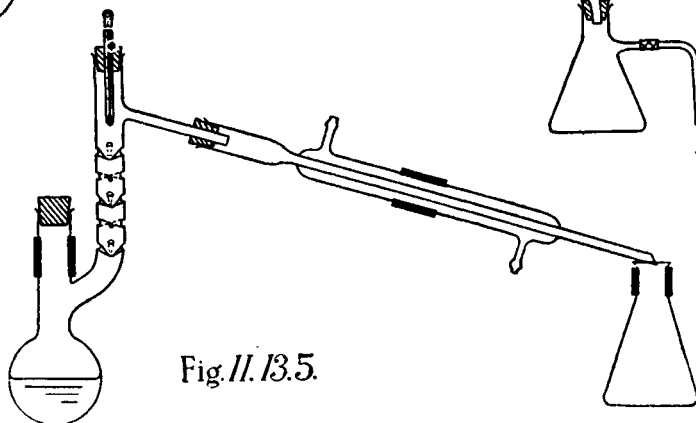
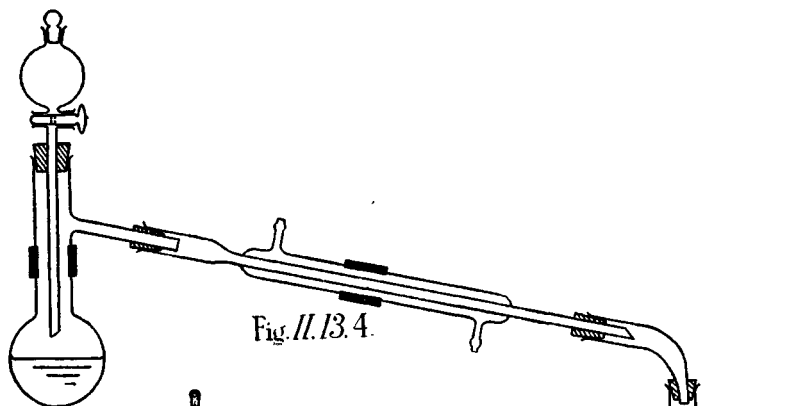

Claisen flask or Claisen flask with fractionating side arm, see Figs. II, 13, 6 and II, 13, 5, may be used, particularly if the residue is to be ultimately distilled under diminished pressure) should have a capacity of about twice the estimated volume of the residue after the removal of the solvent. The adapter may be omitted, if desired, and the end of the

condenser fitted directly into the filter flask. The removal of the solvent in this manner is sometimes termed **flash distillation**.

Figs. *II, 13, 5* and *II, 13, 6* illustrate the use of a Claisen flask with fractionating side arm and an ordinary Claisen flask respectively.

Figs. *II, 13, 7* and *II, 13, 8* depict various set-ups which involve the refluxing of a liquid; the Liebig condenser may, of course, be replaced by a double-surface condenser. In Fig. *II, 13, 7* a "calcium chloride" guard protects the contents of the flask from ingress of moisture. The

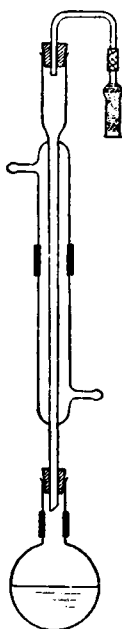

Fig. *II, 13, 7*.

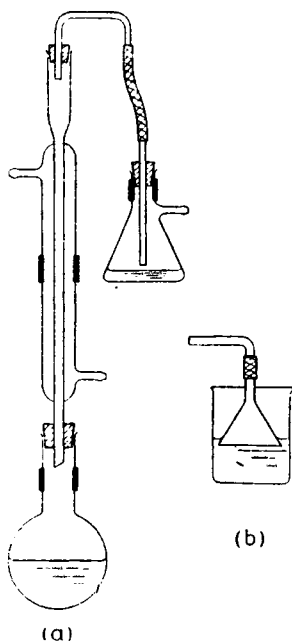

Fig. *II, 13, 8*.

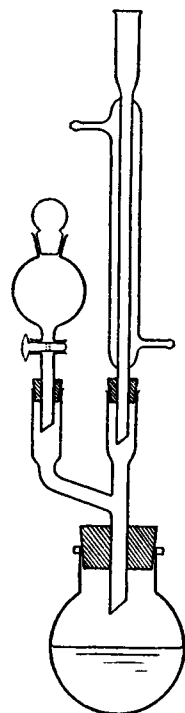

Fig. *II, 13, 9*.

device at the top of the condenser in Fig. *II, 13, 8, a* is for the absorption of a water-soluble gas (hydrogen chloride, hydrogen bromide or sulphur dioxide): it should be noted that the tube is just *above* the level of the liquid in the flask. Alternatively, an inverted funnel (Fig. *II, 13, 8, b*) may be employed for the absorption of gases.

Fig. *II, 13, 9* depicts the use of a two-way adapter arranged for simultaneous addition of a reagent from a dropping funnel and refluxing. An equivalent result may, of course, be obtained by inserting a long-necked, suitably-bent separatory funnel and a condenser through a cork into a flask. The two-way adapter is convenient when a comparatively narrow-necked flask is employed.

Apparatus permitting the use of stirring combined with refluxing and/or the addition of a reagent is described in Section *II, 7* (Figs. *II, 7, 11* and *II, 7, 12*).

II,14. FIRE HAZARDS ATTENDING THE DISTILLATION OF INFLAMMABLE SOLVENTS

The inflammable solvents most frequently used for reaction media, extraction or recrystallisation are diethyl ether, petroleum ether (b.p. 40–60° and higher ranges), carbon disulphide, acetone, methyl and ethyl alcohols, di-*iso*-propyl ether, benzene, and toluene. Special precautions must be taken in handling these (and other equivalent) solvents if the danger of fire is to be more or less completely eliminated. It is advisable to have, if possible, a special bench in the laboratory devoted entirely to the recovery or distillation of these solvents; no flames are permitted on this bench.

Ether. The most satisfactory method for the removal of (diethyl) ether is either on a steam bath fed from an external steam supply or by means of an electrically-heated, constant-level water bath (Fig. II, 5, 1). If neither of these is available, a water bath containing hot water may be used. The hot water should be brought from another part of the laboratory; under no circumstances should there be a free flame under the water-bath. It cannot be too strongly emphasised that no flame whatsoever may be present in the vicinity of the distillation apparatus: a flame 10 feet away may ignite diethyl ether if a continuous bench top lies between the flame and the still and a gentle draught happens to be blowing in the direction of the flame.

Carbon disulphide. It is best to use a water bath maintained at a temperature of 60°–80°.

Solvents with boiling points below 90–95°. A steam bath or water bath should be employed. Alternatively, the apparatus of Fig. II, 13, 3, but with a filter flask as receiver, may be used; the end of the rubber tubing attached to the tubulure is either placed in the sink or allowed to hang over the bench. If a distillation is ultimately to be conducted in the flask from which the solvent is removed, the apparatus depicted in Fig. II, 13, 4 is recommended: the distilling flask may be replaced by a Claisen flask or a Claisen flask with fractionating side arm, particularly if the subsequent distillation is to be conducted under diminished pressure.

It must be borne in mind that in spite of the fact that the solvents have normal boiling points below 90–95°, they cannot always be completely removed by heating on a steam or water bath when they form part of mixtures with less-volatile liquids. Simple distillation may lead to mixtures with higher boiling points than the individual solvents, so that separation of the latter may not be quite complete. In such cases the distillation should be completed with the aid of an air bath (Fig. II, 5, 3) or an oil bath; the fire hazard is considerably reduced since most of the solvent will have been removed.

Solvents with boiling points above 90–95°. The apparatus of Fig. II, 13, 3 (with closed filter flask and rubber lead-off tube) or of Fig. II, 13, 4 (see discussion in previous paragraph but one) should be utilised with an air bath or oil bath as the source of heat. Heating on a wire gauze is not recommended.

II,15. FRACTIONAL DISTILLATION. DISTILLATION WITH A FRACTIONATING COLUMN

An account of the elementary theory of fractional distillation is given in Section I,4. Fractionating columns suitable for both elementary and advanced work will be described in the following pages.

A fractionating column of moderate efficiency is the **Vigreux column**, shown in Fig. II 15, 1. This column is made by indenting a glass tube so that the points of a pair of indentations almost touch each other: the indentations should have a slight downward slope when the tube is vertical. It is essential to arrange the pairs of indentations so that they form a spiral of glass inside the tube; it should not be possible for the vapour to pass directly through the whole length of the tube without meeting at least one indentation.

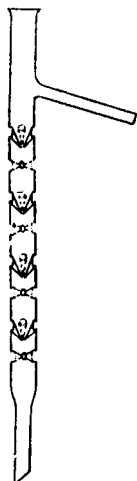

Fig. II, 15, 1.

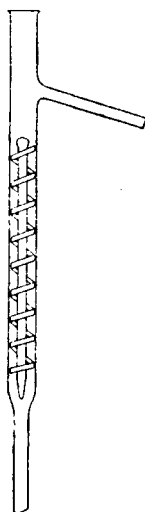

Fig. II, 15, 2.

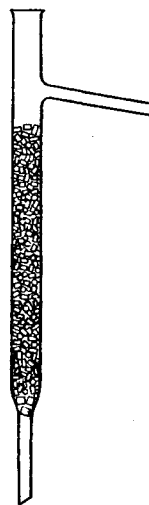

Fig. II, 15, 3.

Fractionating columns of greater efficiency than the simple Vigreux column are illustrated in Figs. II, 15, 2, II, 15, 3 and II, 15, 5. The all-glass Dufton column (Fig. II, 15, 2) is a plain tube into which a solid glass spiral, wound round a central tube or rod, is placed. The spiral must fit tightly inside the tube in order to prevent leakage of any appreciable amount of vapour between the walls of the column and the spiral; this is best ensured by grinding the edges of the spiral into the tube. Typical dimensions are: spiral, 15–30 cm. long fitted inside a tube of 20 mm. diameter; hollow tube, sealed at both ends and round which the spiral is tightly wound, 13 mm. external diameter; turns of glass spiral, 10–13 mm. apart. The Hempel column (Fig. II, 15, 3) is a simple glass tube, 30–40 cm. long and 15–25 mm. diameter, filled to within 5 cm. of the side arm with a suitable packing. For general use $\frac{1}{4} \times \frac{1}{4}$ " hollow glass rings (or a smaller size, if available) are quite satisfactory. Excellent packings for columns may be purchased* either in

* Supplied *inter alia* by the Hydronyl Syndicate Ltd. More expensive column packings, such as Fenske helices, are described in Section II,17.

the form of hollow rings (sometimes termed **Raschig rings**) (Fig. II, 15, 4, a) or as hollow rings with a central partition (**Lessing rings**) (Fig. II, 15, 4, b). The Lessing rings consist of hollow cylinders of approximately equal height and diameter with a central partition when made of porcelain; when constructed of metal, there is a gap in the circumference and a more or less diametrical partition connected on one side with the cylinder but out of touch on the opposite side (Fig. II, 15, 4, c).

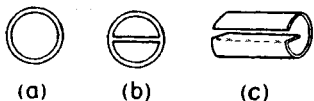

Fig. II, 15, 4.

The provision of the central partition increases the efficiency of the packing material by adding to the contact surface available and enhancing the drainage capacity. For most purposes $\frac{3}{16}$ " Lessing rings of porcelain may be used; plain porcelain rings $\frac{1}{8}$ " diameter are somewhat more efficient. If the substances being distilled do not attack aluminium, $\frac{1}{8}$ " Lessing rings of this metal afford the most efficient packing of general utility. No difficulty is experienced in filling a Hempel column (15–20 mm. diameter) with hollow cylinders of $\frac{1}{4}$ " or $\frac{3}{16}$ " size; the column is laid on its side, about one quarter filled with the packing material, and the column rapidly turned to the vertical position. It will be found that the promiscuous arrangement of the hollow cylinders will be such as to prevent them falling through the somewhat narrower lower end of the column. The column may then be filled to within 4–5 cm. of the side arm. Indentations may be made, if desired, in the lower portion of the column, but this is usually unnecessary. For packing of $\frac{1}{8}$ " size (and occasionally for the $\frac{3}{16}$ " size), two or three $\frac{1}{4}$ " cylinders of the same material as the smaller size will be found to provide a suitable support.

A modified Hempel column, which incorporates a small reflux condenser ("cold finger" or "cold spot condenser"), is shown in Fig. II, 15, 5. The partial condenser can be raised or lowered to decrease or increase the amount of refluxing liquid, and further control is provided by the rate at which cold water is passed through the "cold finger." The reflux condenser thus controls the volume of liquid returned to the column and therefore permits the effective use of the whole length of the column for the fractionation. The reflux ratio is the quotient of the amount of liquid returning through the column to the amount collected in the receiver during the same interval of time. The efficiency of separation of a mixture can be improved by increasing the reflux ratio (say, from 1 : 1 to 10 : 1 or even higher), but care must be taken to avoid flooding the column with liquid. Flooding will diminish the contact area between the vapour and the liquid, and the pressure of the rising vapour may force the liquid upwards in the column. Flooding

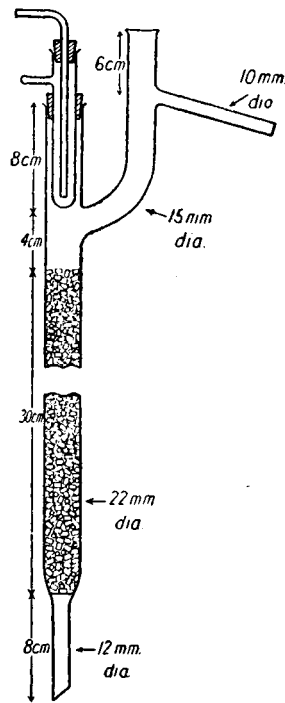

Fig. II, 15, 5.

may be avoided by suitable insulation and control of the rate of heating. The column may be charged with $\frac{1}{4}$ " \times $\frac{1}{4}$ " (or smaller) glass rings or with any of the packing materials described in the previous paragraph.

It is desirable to surround all the fractionating columns described above either by a glass jacket (held in position by split corks) or by a layer or two of asbestos cloth (held in place by turns of stout copper wire). The insulation will reduce the effect of draughts, and will improve the performance of the column. For liquids of boiling point above 100° , lagging of the column and of the side tube with at least two thicknesses of asbestos cloth is essential. In order to obtain improved results for liquids of high boiling point, the column should be heated electrically to a temperature only a few degrees below the boiling point of each component of the mixture. This is most easily done by winding electric heating tape of $\frac{1}{2}$ " diameter round the column: a thermometer, with scale exposed, is embedded in the windings. Alternatively, the heating tape may be covered with asbestos cloth and a thermometer held in position between the heating tape and the layer of asbestos cloth. The tape is connected to the mains through an adjustable resistance, energy regulator or a variable transformer (Variac).

II.16. SIMPLE APPARATUS FOR FRACTIONATION

Fig. II, 16, 1 illustrates a set-up for simple fractionation: a Hempel column is shown, but it may be substituted by a modified Hempel, a Vigreux or an all-glass Dufton column. The Hempel column may be

filled with $\frac{1}{4}$ " glass rings, $\frac{3}{16}$ " porcelain Lessing rings, or with $\frac{1}{8}$ " porcelain rings. The mixture to be fractionated is placed in a bolt-head flask of convenient size (it should be one third to one half full), a few fragments of porous porcelain added, the column fixed in position, and a water condenser attached to the side arm. The distillate is collected in small flasks or in test-tubes. The bulb of the thermometer should be just below the level of the side arm. It is advisable to lag the

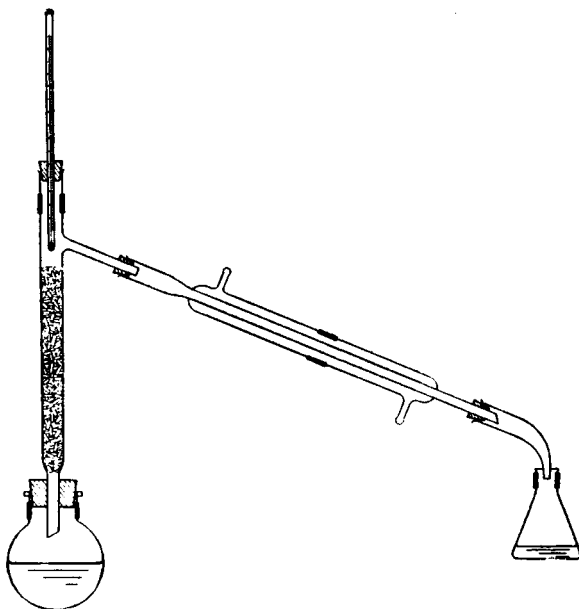

Fig. II, 16, 1.

column by wrapping asbestos cloth round it; this will minimise the effect of draughts in producing excessive cooling. Lagging of the column is essential if the boiling point of any of the components exceeds 100°

(compare previous paragraph). The flask is then heated with a small flame, protected from draughts so as to ensure a uniform heating ; an air bath (Fig. II, 5, 3) gives better results. The initial heating must not be hurried as owing to the considerable extra condensation which occurs whilst the column is warming up, the latter may easily choke with liquid. Once distillation has commenced, the size of the flame is adjusted so that the liquid passes over at the rate of one drop every two or three seconds. Under these conditions fairly efficient fractionation should be obtained. When the low boiling point fraction has passed over, distillation should cease. The heating is then slowly increased, and a sharp rise in boiling point should occur as the second fraction commences to distil ; it is assumed, of course, that the fractionating system is capable of effecting a sharp fractionation of the components of the mixture. If the set-up is inefficient, a relatively large intermediate fraction may be obtained. It is desired to emphasise the fact that the distillation must be conducted slowly ; no time is usually saved by distilling rapidly since a second fractionation will then be necessary.

II,17. IMPROVED APPARATUS FOR FRACTIONAL DISTILLATION

A detailed discussion of the theory underlying modern developments in fractional distillation is outside the scope of this volume,* but a brief description of the terms used in discussing fractionating columns and the chief *desiderata* of efficient columns will be given. The capacity of a column is a measure of the quantity of vapour and liquid which can be passed counter-current to each other in a column without causing it to choke or flood. The efficiency of a column is the separating power of a definite length of the column ; it is measured by comparing the performance of the column with that calculated for a theoretically perfect plate column under similar conditions. A theoretical plate is defined as a section of a distilling column of such length that the vapour comes to equilibrium with the liquid, *i.e.*, the vapour leaving the "plate" has the same composition as the vapour entering it and the vapour ascending from the "plate" is in equilibrium with the liquid descending from it. The number of theoretical plates cannot be determined from the dimensions of the fractionating column ; it is computed from the separation effected by distillation of a liquid mixture (*e.g.*, benzene and toluene ; benzene and carbon tetrachloride ; benzene and dichloroethane ; *n*-heptane and methylcyclohexane), the vapour and liquid compositions of which are accurately known.† An ordinary one cm. tube one metre long might be equivalent to only one theoretical plate, whilst the same tube filled with a suitable packing can give the equivalent of 20 or more theoretical plates. A column with 12 theoretical plates is satisfactory for the practical separation of a mixture of benzene and toluene. The effectiveness of a column depends upon the height as well as upon the

* See, for example, A. Weissberger (Editor), *Technique of Organic Chemistry*, Volume IV. *Distillation*, 1951 (Interscience).

† For experimental details, see, for example, Daniels, Matthews and Williams, *Experimental Physical Chemistry*, 4th Edition, 1949, p. 95 (McGraw-Hill).

packing or internal construction, hence the efficiency is frequently expressed in terms of the height equivalent per theoretical plate (H.E.T.P.). It is obtained by dividing the height by the number of theoretical plates, and is usually stated in cm. For the comparison of the relative efficiencies of fractionating columns, the operating procedure should be standardised.

The ideal fractionation yields a series of sharply defined fractions, each distilling at a definite temperature. After each fraction has distilled, the temperature rises rapidly, no liquid being distilled as an intermediate fraction. If the temperature is plotted against the volume of the distillate in such an ideal fractionation, the graph obtained is a series of alternate horizontal and vertical lines resembling a staircase. A more or less sloping break reveals the presence of an intermediate fraction and the amount of such fraction can be used as a qualitative criterion of the performance of different columns. The ultimate aim in the design of efficient fractionating columns is to reduce the proportion of the intermediate fractions to a minimum. The most important factors which influence the separation of mixtures into sharp fractions are the following :

(1) **Thermal insulation.** Even slight heat losses considerably disturb the delicate equilibrium of an efficient column, and almost perfect thermal insulation is required for the separation of components with boiling points only a few degrees apart. Theoretically, the greatest efficiency is obtained under adiabatic conditions. If the components boil below 100° , a silvered vacuum jacket is satisfactory ; the efficiency of such a jacket will depend upon the care with which it is cleaned, silvered and exhausted. In general, the most satisfactory insulation is provided by the application of heat to balance the heat loss. An electrically-heated jacket is fitted round the column ; the temperature of the jacket, which should be controlled by means of an external resistance or a variable voltage transformer (Variac), should be adjusted within 5° of the temperature of the vapour condensing at the upper end of the column.

(2) **Reflux ratio.** This is defined as the ratio between the number of moles of vapour returned as refluxed liquid to the fractionating column and the number of moles of final product (collected as distillate), both per unit time. The reflux ratio should be varied according to the difficulty of fractionation, rather than be maintained constant ; a high efficiency of separation requires a high reflux ratio.*

Otherwise expressed, the number of theoretical plates required for a given separation increases when the reflux ratio is decreased, *i.e.*, when the amount of condensed vapour returned to the column is decreased and the amount distilled off becomes greater.

(3) **Hold-up of column.** The hold-up of liquid should be reduced to a minimum compatible with scrubbing effectiveness and an adequate column capacity. The ratio of charge of the still to the hold-up of the

* The more difficult the fractionation, the greater the reflux ratio to be employed. Thus for compounds differing only slightly in boiling point, this may be as high as 50 to 1 ; for liquids of wider boiling point range, thus permitting of fairly easy separation, a reflux ratio of 5 or 10 to 1 may be used.

Beyond certain limits increase of the reflux ratio does not appreciably increase the separating power or efficiency of the column. As a rough guide, if the column has an efficiency of n plates at total reflux, the reflux ratio should be between $2n/3$ and $3n/2$.

column should be as large as possible ; in general, the still charge should be at least twenty times the hold-up.

(4) **Packing.** The column should spread the returning liquid over a considerable surface so that the exchange with the vapour is facilitated.

(5) **Time of distillation.** For any column there is always an optimum time of distillation below which accuracy is sacrificed and above which the slightly improved separation does not justify the extra time taken. For most laboratory columns this will vary between 1 hour and 8-10 hours.

An electrically-heated jacket is easily constructed from two pieces of Pyrex glass tubing of such a length as to extend from the bottom of the head to just above the lower end of the column—the latter may carry a ground joint. The inner tube may be of 35 mm. bore and the outer tube of 55 mm. bore : this allows room for the column with attached thermometer inside the inner tube (compare Fig. II, 17, 2). The narrow tube is wound with $\frac{1}{2}$ " electric heating tape ; heat input is controlled by a resistance, energy regulator or a variable transformer. The ends of the jacket are closed with asbestos or other insulating board of convenient size and shape.

The efficient fractionating columns in general use may be divided into two main groups :—

(a) Those incorporating metal spirals or coils (Dufton, Podbielniak) or glass spirals (all-glass Dufton, Widmer).

(b) Columns filled with various packings, *e.g.*, conical disc type of fine stainless steel gauze (Stedman columns), hollow rings in glass, porcelain and various metals (Raschig rings), hollow rings with partition in centre made of porcelain and various metals (Lessing rings), small gauze rings in "staybrite" steel (Dixon rings), and helices in glass (Fenske rings), stainless steel, monel metal, nichrome and nickel.

Examples from each group will now be given with especial reference to those columns which are comparatively inexpensive. A brief description will also be given of two highly efficient fractionating columns, which are available commercially ; these, as well as the Podbielniak and Stedman types, although giving excellent results, are too expensive for the average laboratory.

An all-glass Dufton column has been described in Section II, 15 (Fig. II, 15, 2). A disadvantage is that for temperatures above 100° the column may choke unless it is well lagged or surrounded by an electrically-heated jacket. For higher temperatures it is advisable to have the inner spiral at least 20 mm. in diameter ; the length may vary between 15 and 30 cm. and the "pitch" should be not less than 10-12 mm. The Widmer column, shown diagrammatically in Fig. II, 17, 1, constitutes an improvement on the all-glass Dufton column. It consists of three concentric glass tubes, *C*, *D* and *E*, so constructed that the vapours rise between *E* and *D*, descend between *D* and *C*, and then rise round the spiral in *C*. In this manner the inner spiral, around which almost, if not, all the fractionation occurs, is kept warm by the vapours which surround it ; the condensate in the column is returned to the still through a trap *F*. The glass spiral *B* is tightly fitted round a central glass tube sealed at both ends ; the outside of the helix is ground so that it fits snugly into the tube *C*. The column should be surrounded with an

air jacket, held in position by split corks, for the fractionation of liquids of boiling point below 100° in order to prevent excessive condensation. For liquids distilling above 100° , an electrically-heated jacket should enclose the column. Further details concerning the Widmer and other columns will be found in Section II,57.

A number of excellent packings for distilling columns are available commercially. The simplest, cheapest, and yet highly effective packing consists of hollow glass rings of $\frac{1}{8}$ ", $\frac{3}{16}$ " and $\frac{1}{4}$ " height and diameter; $\frac{1}{8}$ " hollow porcelain rings (Raschig rings) are almost equally effective. Lessing rings (see Section II,15) of porcelain ($\frac{3}{16}$ " size) and, where no chemical action occurs between the vapour of the liquid and the metal, of aluminium ($\frac{1}{8}$ "), of copper ($\frac{1}{8}$ ") and of nickel ($\frac{1}{8}$ ") give excellent results; aluminium rings, where applicable, constitute a particularly efficient packing medium. The merits of the above contact rings for laboratory fractionating columns appear to have been overlooked. They are comparatively inexpensive and are applicable to most problems of fractional distillation encountered in the organic chemistry laboratory. Some idea of their efficiency may be obtained from the fact that one fractionation of a mixture of 50 ml. of benzene and 50 ml. of toluene through a simple Hempel column filled with $\frac{1}{8}$ " Raschig porcelain rings or with $\frac{1}{8}$ " Lessing aluminium rings (the column packing was 35 cm. long and 18 mm. in diameter) gave 43–47 ml. of pure benzene and 44–46 ml. of pure toluene.

Glass helices (Fenske rings) are an alternative packing for fractionating columns. A convenient size for single turn helices is 4.0 mm. external diameter and 0.50 mm. rod thickness: one pound of these occupies approximately 900 ml. There can be little doubt that Fenske rings possess many desirable properties as a packing for columns but, for routine use, they are somewhat expensive. For many purposes satisfactory results can be obtained by the use of the small Raschig or Lessing rings already described. However, where small quantities of liquids are involved, a column filled with glass helices will probably give the best results and the cost will not be unduly high. Rings in stainless steel and other metals can be purchased in sizes from $\frac{1}{16}$ " to $\frac{1}{4}$ ".

An excellent but expensive packing for columns consists of Dixon gauze rings.* They are small gauze rings of Lessing shape made of "Staybrite" (stainless steel) gauze. A useful size is $\frac{1}{16}$ " \times $\frac{1}{16}$ "; one pound of these occupies about 750 ml.

Fig. II, 17, 2 illustrates a fractional distillation unit † for use with glass helices. The column is provided with an electrically-heated jacket; the resistance shown in the Figure may be replaced by a variable transformer. The still head is of the total-condensation variable take-off type; all the vapour at the top of the column is condensed, a portion of the condensate is returned to the column by means of the special stopcock (permitting of

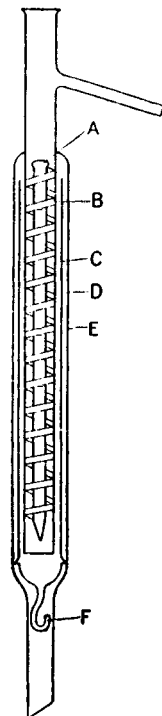

Fig. II, 17, 1.

* Supplied by Griffin and George Ltd.

† Supplied by J. W. Towers and Co. Ltd.

fine adjustment of the reflux ratio) and the remainder is collected in the receiver. The advantages of the still head are :—

(1) True equilibrium conditions can be established before any distillate is collected; this is particularly important when the jacket temperature must be controlled.

(2) Reflux is more easily controlled, since careful adjustment of the reflux condenser is unnecessary.

(3) Changing from a lower to a higher boiling point fraction is comparatively easy. The stopcock is closed and the liquid is allowed to reflux until the thermometer records the lowest temperature possible; at this point the column is effecting its maximum degree of separation and an equilibrium condition is reached. The tap is then partially opened and the distillate is collected in the receiver until the temperature begins to rise. The stopcock is then closed and equilibrium conditions again established, and a further fraction is removed. In this way sharper separations may be obtained. Further improvement results from the use of a capillary tube to drain the condensate into the receiver. The reflux ratio may be measured approximately by counting the number of drops of liquid which fall back into the column as compared with the number of drops which fall into the receiver flask (the liquid drops falling off the slanting ends of the drip tubes are readily observable).

The dotted line in Fig. II, 17, 2 refers to the modification of the apparatus for use in fractional distillation under reduced pressure: a Perkin triangle or equivalent receiver device ("vacuum distilling adapter") is generally employed for collection of the various fractions.

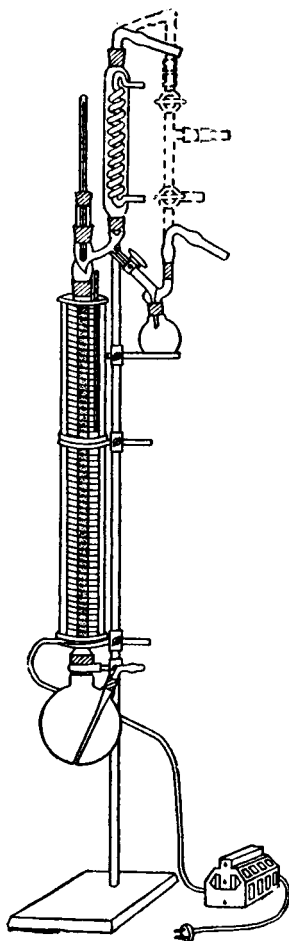

Fig. II, 17, 2.

A very efficient and versatile laboratory fractional distillation assembly* and the essential parts are shown in Fig. II, 17, 3. The main feature of the apparatus is that the fractional distillation is conducted under virtually adiabatic conditions with complete visibility to all parts of the apparatus. This is achieved by means of a "staggered dual heating unit," which enables the temperature gradient to be varied along the entire length of the column, so as to be substantially the same as the internal temperature gradient which is determined solely by the mixture being fractionated. Thermometers are fixed inside the heating jacket surrounding the column at such positions that the temperatures at the top and bottom can be determined. The "staggered heating unit" consists of two independent heating units (top and bottom) which extend over the entire length of the jacket and are overlapped or

* Supplied by the Todd Scientific Company.

staggered in the middle third of the column. The upper and lower heating units are insulated from each other and are connected to slide wire rheostats mounted on a separate control panel. By means of these rheostats the heater jacket temperature can be varied from room temperature to about 360°C . All that is necessary in practice to secure adiabatic conditions is to observe the "overhead" vapour temperature and adjust the top external heating unit to this temperature: the vapour temperature in the still pot is also noted and the lower external heating unit is adjusted approximately to this temperature. The other features of the assembly are:—

(i) Three interchangeable fractionating columns, length 90 cm. each, internal diameters 5, 12 and 25 mm. respectively, are available. The packing for the 5 mm. column consists of a Monel metal rod of 1.5 mm. diameter wound with wire of the same diameter into a spiral with 2.2 turns per cm. The packing for the other columns consists of 4 mm. glass helices.

(ii) The fractionation charges for the three columns are 2–75 ml., 75–250 ml. and 250–5,000 ml. respectively; materials boiling from room temperature to 360°C . may be distilled.

(iii) Fractional distillation may be carried out at atmospheric or under reduced pressure. The receiver has a capacity of 50 ml. and is graduated in 0.1 ml.

(iv) The still head is of compact design enabling it to be enclosed in the heating jacket. The use of an "automatic still head" and an "automatic still head timer" permit the automatic maintenance of constant reflux ratios at atmospheric or reduced pressure, regardless of the rate of distillation.

(v) The fractionation efficiency is 42 to 60 theoretical plates at total reflux. Mixtures with components whose boiling point differences are as little as 6° apart can be readily separated.

(vi) Heating of the still pot is effected with a special aluminium alloy pot heater with low temperature lag; a highly polished, parabolic aluminium reflector is incorporated which concentrates the radiant heat energy from the coil uniformly on the bottom of the still pot. The heater is controlled by a variable transformer.

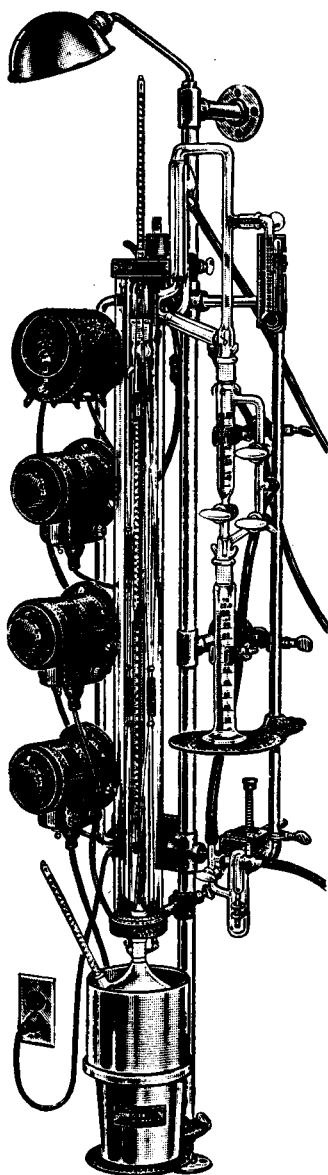

Fig. 11, 17, 3.

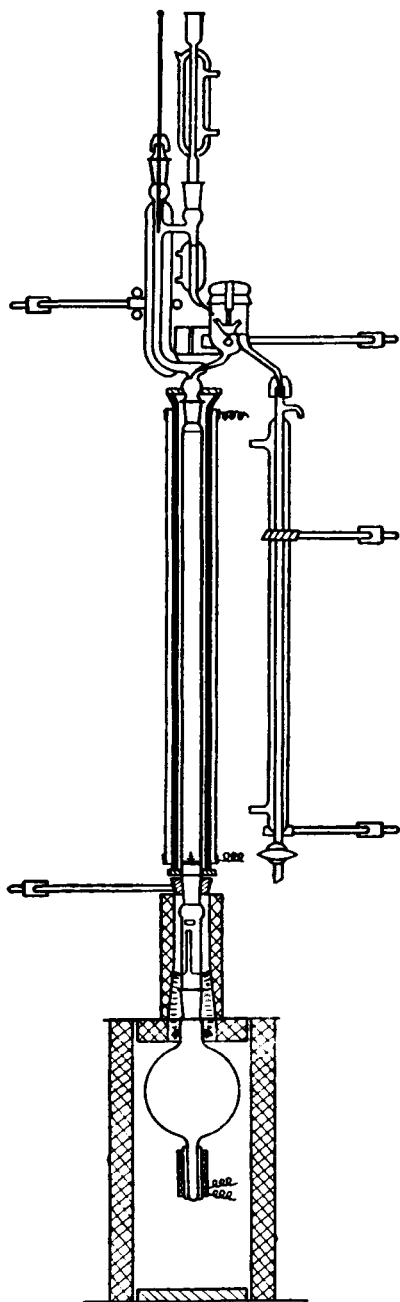

Fig. II, 17, 4.

to the column : make sure that the Perkin triangle (or "vacuum distilling adapter") and receiver are in place. See that the oil pump is functioning

Another precision fractional distillation apparatus* is depicted in Fig. II, 17, 4. The main features, worthy of special mention, are :—

(a) Two sizes of column, viz., 45 cm. \times 17 mm. and 150 cm. \times 20 mm., are available; only the former is illustrated and described.

(b) The packing consists of stainless steel Dixon gauze rings $\frac{1}{16}$ " \times $\frac{1}{16}$ ", or of 4 mm. glass helices.

(c) Two types of column head are supplied, one for manual and the other for automatic operation. Both allow constant reflux ratios to be attained. The automatic column head is of the "tipping bucket" type and is electromagnetically controlled.

(d) A reflux meter is incorporated in the base of the column for the measurement of the boil-up (or reflux) rate; it also incorporates a flooding device.

(e) The column is surrounded by a removable, silvered vacuum jacket with an electrically-heated lagging shield.

(f) The flask (150, 250 or 500 ml.) is provided with a cylindrical extension at the bottom forming a boiling tube: the latter is heated electrically and the heat input is controlled by a resistance or variable transformer.

(g) The apparatus may be operated at reduced pressure by the addition of a manometer, manostat, vacuum pump and appropriate receiver system.

Notes on the operation of a precision fractionating column. The following notes on the technique of conducting a fractionation under diminished pressure may be of value to the student: their adaptation to fractionation at atmospheric pressure should not present any difficulty.

1. Attach the flask containing the mixture, with capillary in position, the Perkin triangle (or "vacuum distilling adapter") and receiver are in place. See that the oil pump is functioning

* Designed by the staff of the Sunbury Research Station of the British Petroleum Company, and marketed by Griffin & George Ltd.

satisfactorily, adjust the pressure in the system to the desired value and control this with the aid of a manostat. Set the still head for total reflux and heat the flask until the material begins to reflux into the column. Then heat the column very slowly until the refluxing liquid reaches the top of the column and the boiling point registers on the thermometer. Adjust the temperature in (or near the top of) the jacket, as recorded on the thermometer adjacent to the column, until it is just below (*i.e.*, within 5°) the boiling point recorded in the vapour. With random packings, such as glass helices or gauze rings, the column should first be flooded in order to coat the packing completely with liquid; it is then operated under total reflux until equilibrium is attained (about 1 hour per 10 theoretical plates). A small forerun (*e.g.*, a low boiling water azeotrope resulting from traces of moisture in the liquid) can be removed before the column is brought to equilibrium.

2. When the column has reached equilibrium, adjust the head to give the desired reflux ratio, change the receiver and collect the lowest boiling point component over an appropriate distillation range, say, 1–2°. During the distillation, maintain as high a rate of reflux as possible consistent with prevention of flooding the column; under these conditions the reflux ratio is controlled by the rate of take-off. As the lowest boiling point component is removed, the proportion of it in the distillation flask gradually decreases and eventually a mixture of two components reaches the top of the column, and this will be indicated by a slight rise in boiling point. When this occurs, gradually increase the reflux ratio, *i.e.*, decrease the rate of take-off: this will make it possible to collect the lowest boiling point fraction over a narrow range; eventually a point will be reached when even with a high reflux ratio the boiling point rises. At this stage, change the receiver and commence the collection of the intermediate fraction.

3. During the distillation of the intermediate fraction, keep the rate of take-off very slow. The boiling point will rise and eventually either remain constant or increase very slowly. At this point, change the receiver, adjust the temperature of the heating jacket again, and collect the second fraction over a narrow distillation range—rapidly so long as the temperature remains essentially constant, then more slowly until finally the second intermediate fraction is reached again whilst distilling very slowly. Change the receiver, collect the intermediate fraction, and proceed as before for the third component, etc.

The following general comments upon situations which may arise during fractionation may be helpful:—

(a) The sharper the fractionation, the smaller, of course, is the intermediate fraction. If the difference in boiling points of the components being separated is considerable, the separation will be so facile that practically all the lower boiling point component will be removed whilst the boiling point remains essentially constant. Eventually the upper part of the column will begin to run dry, distillation will slow up and finally stop, whilst the reflux at the bottom of the column will be heavy. The vapour temperature may begin to fall until it is below the temperature at the top of the heating jacket. Mere increase of the bath temperature may result in the flooding of the column: the power input to the heating jacket must

be gradually increased until reflux again reaches the top of the column, the boiling point begins to rise and eventually becomes constant; the temperature in the jacket is maintained just below the boiling point of the vapour.

(b) As the rate of take-off is reduced near the end of a fraction, a slight lowering of the bath temperature may be necessary to avoid flooding of the column. Also as the boiling point rises during the collection of the intermediate fraction, the power input to the jacket must be increased in order to hold its temperature just below the boiling point.

(c) If the column is flooding near the top and there is little reflux at the bottom, the jacket temperature is too high. If there is normal heavy reflux at the bottom of the column and there is flooding at the top, the bath temperature is probably too high. If the column is flooding near the bottom and there is little reflux near the top, the jacket temperature is too low.

(d) If it is desired to collect the liquid remaining in the column at the end of the fractionation (constituting the "hold up"), the column may be stripped by the addition of a "chaser" at the beginning of the fractional distillation in a quantity somewhat greater than the estimated "hold up." The boiling point of the "chaser" should be at least 20° higher than the final boiling point of the material being fractionated. For this operation the bath temperature is kept sufficiently high to distil the end component, and the jacket temperature is carefully and slowly raised above the boiling point of the component. "Chasers" should be chemically inert, inexpensive, and should not form azeotropic mixtures; examples are:—*p*-cymene, b.p. 175°; diphenyl, b.p. 254°; acenaphthene, b.p. 277°; and phenanthrene, b.p. 340°.

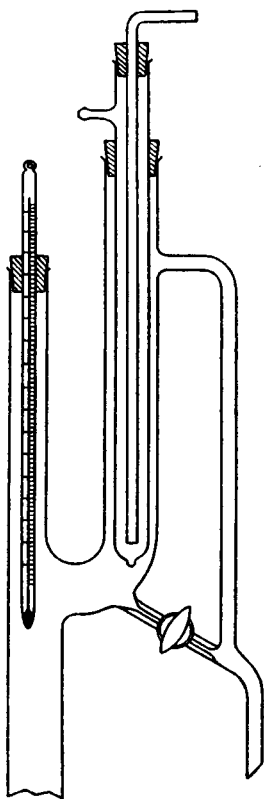

Fig. II, 18, 1.

II,18. STILL HEADS FOR FRACTIONATING COLUMNS

It is generally agreed that for efficient fractionation a large percentage of the vapours which pass through the length of the column must be condensed and returned. Two types of still head are employed for this purpose, known respectively as the **partial condensation** and the **total condensation variable take-off types**. In the former, first referred to in connexion with the modified Hempel column (Fig. II, 15, 5), a portion of the vapour is condensed by a reflux condenser ("dephlegmator") and returned to the column, whilst the remainder passes through to the receiver. The heat interchange in the dephlegmator is controlled by adjusting the water inlet with stopcocks or screw-clips, by varying the depth to which the condenser is immersed in the vapour stream or by other means. In the total-condensation variable take-off still head, all the vapour is condensed, a portion of the condensate is returned to the fractionating column,

and the remainder collected in the receiver. The advantages of this still head are pointed out in the previous Section. The main features will be evident from Fig. II, 18, 1. More complex types of total-condensation variable take-off still heads are described and illustrated in Section II, 17.

II, 19. DISTILLATION UNDER DIMINISHED PRESSURE (" VACUUM " DISTILLATION)

Many organic substances cannot be distilled satisfactorily under atmospheric pressure because they undergo partial or complete decom-

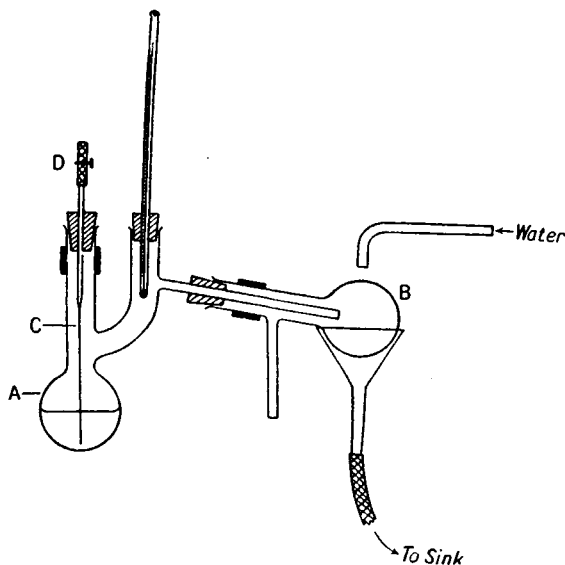

Fig. II, 19, 1.

position before the normal boiling point is reached. By reducing the external pressure to 1–30 mm. of mercury, the boiling point is considerably reduced and the distillation may usually be conducted without danger of decomposition.

A simple arrangement for distillation under diminished pressure is shown in Figs. II, 19, 1 and II, 19, 2. Well-fitting and well-bored rubber stoppers (see Fig. II, 3, 1) and heavy-walled rubber tubing (" pressure " tubing) are employed in distillations under reduced pressure. *A* is a Claisen flask (the two necks considerably reduce the danger of mechanical contamination of the distillate from violent bumping or frothing) and *B* is a distilling flask to act as a receiver. The right-hand neck of the flask is fitted with a thermometer with the bulb just (1–2 mm.) below the level of the side arm, whilst the left-hand neck carries a stout capillary tube *C*, which is closed at the upper end by a short piece of pressure tubing and a screw clip *D*.* The capillary tube *C* should always be prepared by drawing out a length of thick-walled capillary tube of 3–5 mm. external bore

* After some experience it will be found that a drawn-out capillary tube of the correct size may be prepared; the rubber tubing and the screw clip *D* are then omitted.

If pressure tubing is used, it is advisable to insert a short length of thin metal wire (e.g., copper wire, 22 gauge) to prevent the tubing being closed completely by the screw clip.

(dependent upon the size of the Claisen flask): the length of the fine drawn-out capillary is adjusted so that it reaches 1–2 mm. from the bottom of the flask. Ordinary glass “quill” tubing should not be used for the preparation of *C*, since the resulting capillary will be very fragile and may snap during the course of the distillation. The side-arm of the Claisen flask is then fitted so that it projects well into the bulb of the distilling flask *B* in order that condensation of the vapours should be as complete as possible. For liquids of boiling point below 140–150°, the bulb of the receiver *B* is cooled with a stream of cold water, the waste water being collected by a funnel below and carried to the sink by rubber tubing. For liquids of higher boiling point adequate cooling is usually obtained by surrounding the receiver with a vessel containing cold water.

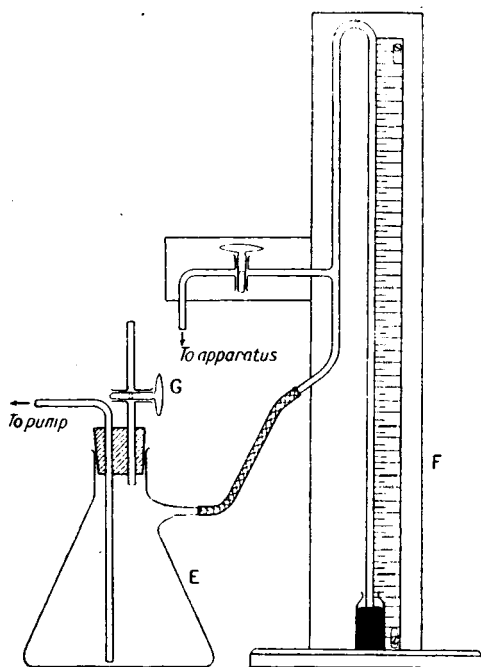

Fig. II, 19, 2.

elementary students. Two slots are provided on the meter scale (graduated in mm.) so as to enable accurate adjustment of the zero to the level of the mercury in the small reservoir; the adjustment is best made when the manometer is connected to a pump and the mercury has risen to a height of about 750 mm.

The pressure is reduced by means of a high capacity water pump, preferably constructed of metal; * the lowest pressure that can be attained is that of the vapour pressure of water at the particular temperature (for a detailed discussion, see Section II,21). In winter when the temperature of the water may be 6–8° the vapour pressure of water is 7–8 mm., but in summer when the temperature of the water may reach 22°, the corresponding vapour pressure is 20 mm. Thus the “vacuum”

* A particularly good metal pump, which operates on a comparatively small head of water is made by Edwards High Vacuum Ltd.

The distilling flask *B*, acting as a receiver, is connected by means of rubber “pressure” tubing to a filter flask *E* (which, *inter alia*, serves as a reservoir to equalise the pressure and the latter to a manometer and water pump. The glass tube connecting the suction flask *E* with the pump should extend to the bottom of the flask in order that any water which may flow back owing to unequal pressure in the water main may be sucked out as soon as the water pressure returns; if the flow back of the water is appreciable, it may be checked by opening the stop-cock *G* until the original water pressure is restored. The manometer illustrated is easily constructed and is particularly suitable for

produced by an efficient water pump normally varies between 7 and about 20 mm., depending upon the temperature of the tap water. If lower pressures are required, an oil pump should be used (see following Section).

As already pointed out, bumping is prevented (or minimised) by the passage of a *fine* stream of air bubbles through the capillary tube in the Claisen flask when the apparatus is under reduced pressure. The introduction of a vapour phase tends to prevent a delay in the appearance of that phase and thus to prevent superheating (compare Section I,3). The volume of air introduced in the form of minute bubbles is small so that the effect of the partial pressure upon the boiling point will usually be negligible. Bumping is also minimised by the use of a water, oil or air bath; heating on a wire gauze or by means of a free flame should not be employed.* Bumping is said to be entirely prevented by packing enough glass wool into the flask to rise about 5 mm. above the surface of the liquid.

To carry out a distillation, the liquid is poured into the Claisen flask so that it is about one-half full, and the apparatus is completely assembled as in Figs. II, 19, 1-2. The barometric pressure is read. The flask is heated either by means of an air bath (Fig. II, 5, 3) or by means of a water or oil bath; in the latter case the bulb of the flask is immersed at least two-thirds into the bath, which should contain a thermometer. The water pump is then turned on to its maximum capacity and the screw clip *D* almost fully closed.† The latter is then adjusted so that a fine stream of air bubbles passes through the liquid; when the mercury in the manometer ceases to rise, the reading (in mm.) is taken on *F* and this value is subtracted from the atmospheric pressure in order to obtain the pressure within the system. If the pressure thus obtained does not differ by more than 10 mm. from that expected from the temperature of the tap water, the set-up may be regarded as satisfactory. If the pressure is unsatisfactory, the apparatus must be carefully tested for leaks and these eliminated before the distillation can be commenced: special attention should be paid to ensure that all the stoppers are firmly in position and all the rubber "pressure" tubing fits tightly over the glass tubing. The cooling water for the receiver is first turned on, and, when the mercury level on the gauge is more or less steady, heating is commenced. (For high boiling point liquids, it is advantageous to wrap linen cloth or, better, asbestos cloth or string round the neck of the flask below the outlet tube.) If an air bath is employed, the temperature is slowly raised until the liquid commences to distil, and the heating is

* Experienced laboratory workers sometimes employ a large free flame for liquids which tend to froth considerably; by directing the flame for the most part at approximately the level of the surface of the liquid and heating the circumference evenly with a "rotating" flame, the frothing may be reduced and the distillation carried out with comparative safety. Boiling points which are slightly high may be obtained by the use of a free flame unless the liquid is distilled slowly.

† If the material in the flask contains traces of volatile solvents, it is advisable to allow the passage of a comparatively large volume of air through the liquid while warming the flask slightly: this drives off the last traces of volatile solvents, which are carried down the water pump. If this is not done, the pressure obtained when testing out the apparatus will be above the real capacity of the pump and the student will erroneously assume either that the pump is not functioning efficiently or that leaks are present in the apparatus. When all traces of volatile solvents have been removed, the screw clip *D* is almost completely closed or otherwise adjusted.

maintained at this intensity so that the liquid distils at the rate of 1-2 drops per second. With an oil bath, the temperature of the latter should be 20-25° above the boiling point of the liquid. The readings on the thermometer and gauge are taken frequently during the course of the distillation. For a pure compound the boiling point will not rise more than a degree or two during the whole of the distillation, even when the bath temperature must be raised considerably towards the end to drive off the last ml. or so of liquid. If the initial distillate boils at a lower temperature than that expected, the heating is continued until the thermometer records a temperature near that anticipated, and the receiver is changed in the manner described below; this procedure is also employed if it is desired to remove a fraction. The flame beneath the bath is first removed, and the Claisen flask is allowed to cool slightly either by removing the asbestos covers on the air bath or by lowering the bath (an equivalent result is obtained by raising the flask, etc.). The "vacuum" is gradually released by opening the stop-cock *G* on the filter flask *E*, and the screw clip on *D* is fully opened (this will prevent any liquid entering the capillary). The receiver is then replaced by a clean distilling flask, care being taken that all joints are tight. The system is then again evacuated, the air flow through the capillary regulated and, when the pressure is steady, the heating is recommenced.

If the pressure during the distillation is not exactly that given in the recorded boiling point, it may be estimated *very approximately* for the working pressures of a water pump (10-25 mm.) by assuming that a difference of 1 mm. in pressure corresponds to one degree difference in the boiling point. A more accurate method is described in Section I.2. Table II, 19 may be found useful as a guide to the *approximate* boiling point under diminished pressure when the boiling point under atmospheric pressure is known: it will enable the student to select and adjust the thermometer employed in the distillation.

TABLE II, 19. APPROXIMATE BOILING POINTS (°C) AT REDUCED PRESSURES

PRESSURE (MM. HG)	WATER	CHLORO- BENZENE	BENZ- ALDEHYDE	ETHYL SALI- CYLATE	GLYCEROL	ANTHRA- CENE
760	100	132	179	234	290	354
50	38	54	95	139	204	225
30	30	43	84	127	192	207
25	26	39	79	124	188	201
20	22	34.5	75	119	182	194
15	17.5	29	69	113	175	186
10	11	22	62	105	167	175
5	1	10	50	95	156	159

Distillation of solids under reduced pressure.—The apparatus shown in Fig. II, 19, 1 may be employed for the distillation under diminished pressure of solids possessing comparatively low melting points;

water cooling of the receiver is generally unnecessary. Any tendency to solidify in the side arm of the Claisen flask may be overcome by conducting the distillation fairly rapidly, and by warming the side arm of the Claisen flask and the neck of the receiver with a luminous flame from time to time.

A more satisfactory apparatus is depicted in Fig. II, 19, 3. With this all-glass apparatus, the whole side arm may be heated directly with a flame, thus enabling materials melting as high as 200° to be distilled with ease. A liquid forerun may be removed with a bulb pipette. A solid

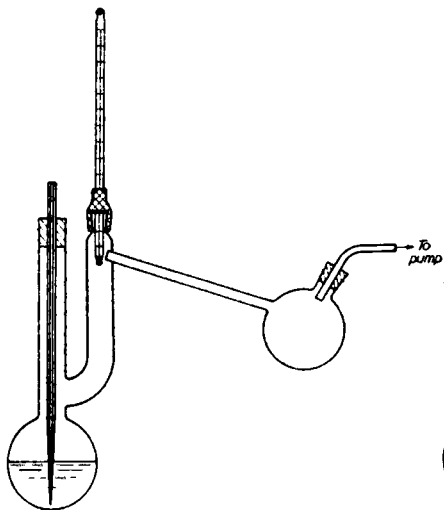

Fig. II, 19, 3.

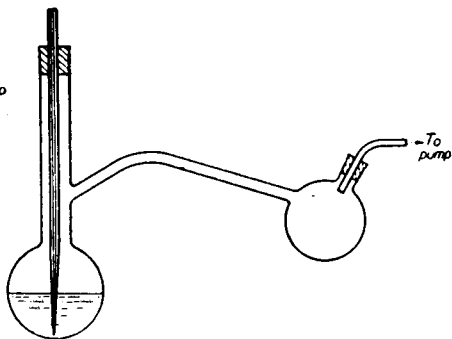

Fig. II, 19, 4.

forerun may be melted and similarly removed; the receiver may then be rinsed with a little solvent and dried. If the distillate must be left in the receiver, the side arm may be cut a few cm. from the receiving flask and a new receiver sealed to the side arm.

Frequently, the object of distillation of a solid under reduced pressure is to remove foreign colouring matter, tar and other non-volatile solids without appreciable loss of material—a process which is generally more effective and more economical than several crystallisations from a solvent; the purity of the distillate may be more easily ascertained by a melting point determination. In such circumstances, a thermometer is unnecessary and the two-bulb flask, depicted in Fig. II, 19, 4, may be employed; rubber stoppers are used, and both the solid and the apparatus must be dry. It is usually advisable to heat the flask with a rather large free flame and to maintain a rotary motion round the walls; less bumping occurs than when the flask is heated from the bottom. If there is considerable frothing at the start, the flame should be directed at the upper walls and neck of the flask. If the solid tends to solidify in the side arm, it may be melted by the application of a free flame. When the distillation is complete, air is allowed to enter the apparatus, the contents of the receiving bulb are melted and poured out into a convenient receptacle.

II,20. FRACTIONAL DISTILLATION UNDER DIMINISHED PRESSURE

The chief disadvantage of the simple "vacuum-distillation" set-up shown in Fig. II, 19, 1 is that, if more than one fraction is to be collected, the whole process must be stopped in order to change the receiver *B*. It is of value, however, for the distillation of solids of low melting point; the distillate can easily be removed from the receiver by melting and pouring out. For routine work, involving the collection of several fractions under reduced pressure, the most convenient receiver is the so-called Perkin triangle; the complete apparatus for "vacuum distillation" is depicted in Fig. II, 20, 1. The Claisen flask *A* is fitted to a short water

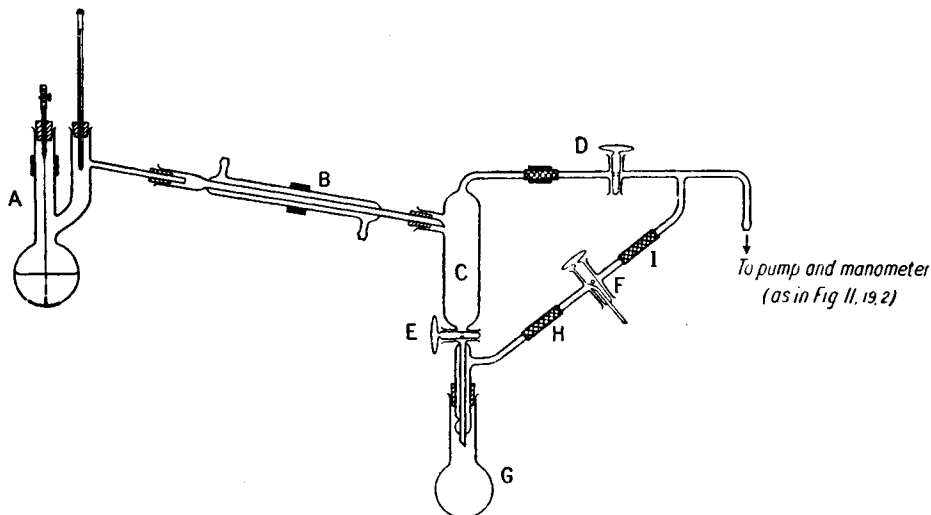

Fig. II, 20, 1.

condenser *B*, which passes through the usual rubber stopper into the main receiver *C** of the Perkin triangle. The latter has "two-way" taps at *D* and *E* and one "three-way" tap *F*, which are connected together with glass to glass joints by short lengths of rubber "pressure" tubing. All the glass parts of the triangle may be fused together thus dispensing with the rubber connexions, but in the author's experience an all-glass Perkin triangle is too fragile for students' use; rubber connexions possess the additional advantage that broken parts may be easily replaced at reasonable cost. The receiver *G* consists of a round-bottomed flask † or a test-tube and is fitted to a rubber stopper on the double-walled tube

* For general work in the laboratory, *C* should have a capacity of about 35 ml. and the opening should accommodate a 15 mm. stopper (narrow end) and be inclined at an angle of 105–110° to the body of *C*. It is an advantage to have *C* graduated by the manufacturers. Alternatively, it may be graduated at 2 or 5 ml. intervals by the student with the aid of a burette; a scale is pasted on the outside of *C* and rendered permanent by covering it with a thin layer of varnish or paraffin wax.

† Flat-bottomed vessels should not be employed in "vacuum distillation" because of the possible danger of collapse under diminished pressure.

leading from tap *E*; the inner tube provides direct access from *C* through the tap *E* to receiver *G*, whilst the outer (annular) tube connects *G* with the "three-way" tap *F* through several small holes situated at the lower end below the stopper. The "three-way" tap *F* permits, by suitable rotation, the connection of: (i) the receiver *G* with the pump system, (ii) the receiver *G* with the atmosphere (tap *E* is, of course, closed), whilst the main apparatus is under "vacuum" thus allowing an easy change of the receiver, and (iii) the gradual entrance of air into the whole apparatus in order to restore the atmospheric pressure (tap *E* is then open).

In order to carry out a distillation, the apparatus is completely assembled, the water pump turned on to its maximum capacity, and the screw clip on the capillary tube in the Claisen flask adjusted so that a gentle stream of air bubbles through the liquid (see Section II, 19 for details of the preparation of the capillary tube). The barometric pressure is read, and if the resulting "vacuum" determined from the reading on the manometer is satisfactory (as estimated from the temperature of the tap water), the flask may be heated in an air (Fig. II, 5, 3), water or oil bath. At the commencement of the distillation stop-cocks *D* and *E* are open and the "three-way" stop-cock *F* is turned so as to connect *H* and *I*. The first fraction therefore runs from *C* into *G*; the latter may then be detached in the manner previously described and a new receiver fitted. If a highly efficient pump is being used, it is sufficient to turn *F* so as to connect *H* and *I*, thus rapidly exhausting the new receiver; after a few moments to allow

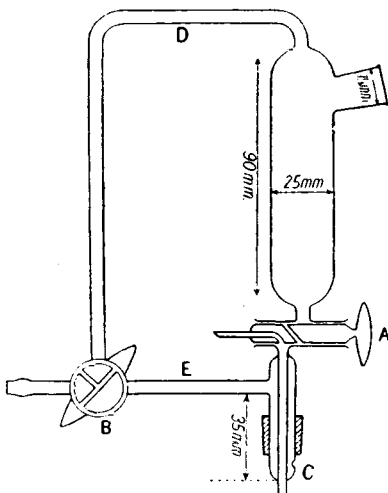

Fig. II, 20, 2.

for the equalisation of pressure, the second fraction may be run into the new receiver by opening the tap *E*. If the pump has a small capacity or is somewhat inefficient, the sudden admission of air into the apparatus may cause a slight rise in pressure and distillation may cease temporarily. It is then advisable to remove the flame from beneath the bath (with an air bath the removal of the asbestos covers will suffice) and not to recommence heating until the previous pressure has been restored. This operation of changing the receiver for the collection of different fractions may be repeated as often as is necessary.

A modification of the Perkin triangle (Kon, 1930) is shown in Fig. II, 20, 2. It has two stopcocks (both "three-way") *A* and *B* instead of the three in the conventional form. Another advantage is that when air is admitted through the tap *A* to the lower portion of the apparatus in order that the receiving flask may be changed, the last few drops of distillate remaining in the tube *C* are blown out into the receiver, thus minimising waste and also reducing contamination of the various fractions. The "three-way" tap *B* enables connexion to be made between the pump

with either or with both halves of the apparatus. It is, of course, possible to construct this vacuum receiver with two rubber "pressure" tubing glass to glass joints at *D* and *E*, but the all-glass apparatus is generally preferred. The method of use of the Kon vacuum receiver will be obvious from the description already given for the Perkin triangle.

II,21.

WATER PUMPS

The high-pressure water supply service is employed for the operation of the ordinary "filter pump," which finds so many applications in the laboratory. A typical all metal "filter pump" is illustrated in Fig. II, 21, 1.* It is an advantage to have a non-return valve fitted in the side arm to prevent "sucking back" if the water is turned off or if the water pressure is suddenly reduced. Theoretically, an efficient filter pump should reduce the pressure in a system to a value equal to the vapour pressure of the water at the temperature of the water of the supply mains. In practice this pressure is rarely attained (it is usually 4–10 mm. higher) because of the leakage of air into the apparatus and the higher temperature of the laboratory. The vapour pressures of water at 5°, 10°, 15°, 20° and 25° are respectively 6·5, 9·2, 12·8, 17·5 and 23·8 mm. respectively. It is evident that the "vacuum" obtained with a water pump will vary considerably with the temperature of the water and therefore with the season of the year; in any case a really good "vacuum" cannot be produced by a filter pump.

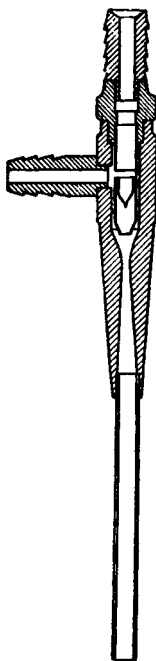

Fig. II, 21, 1.

II,22.

OIL PUMPS

Water pumps are not always satisfactory, particularly in the summer or if the pressure on the water mains is not too high; they are sometimes erratic in action and cannot be used if low pressures are required. Motor-driven oil pumps now find extensive use either as individual units or as a large capacity unit connected through lead pipes to points situated at convenient positions in the laboratory.† These pumps may evacuate to about 0·1 mm. of mercury, but a vacuum of 5–10 mm. is quite satisfactory for most purposes. Indeed, it has been pointed out by Hickman (1932–37) that however low the pressure produced by the pump, it is rarely possible to obtain a vacuum better than about 5 mm. above the surface of the boiling liquid owing to the pressure required (1–8 mm.) to drive vapours from the distilling surface through the neck and side arm (usually 4–5 mm. diameter) of the ordinary flask; to take advantage of the low pressure produced by a good oil pump, the use of a wide side arm situated just above the bulb of the flask is recommended.

* The metal pump illustrated has given excellent results in the author's laboratory, and is made by Edwards High Vacuum Ltd.

† Satisfactory vacuum installation units are supplied by Edwards High Vacuum Ltd.

In order to protect the oil in the oil pump from contamination, some form of trap must be interposed between the distillation apparatus and the pump in order to prevent vapours from the distilling flask, etc. passing

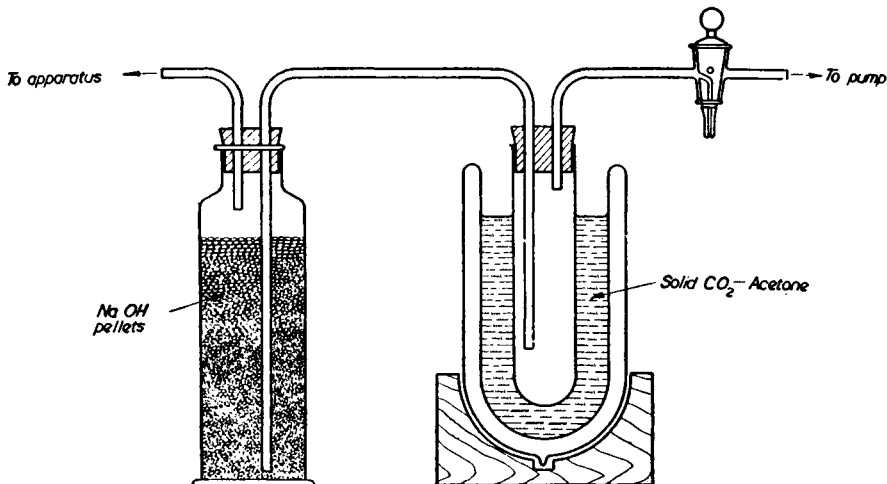

Fig. II, 22, 1.

into the pump. The trap may consist of a bottle charged with sodium hydroxide pellets, followed by a wide empty tube immersed in a Dry Ice - acetone (or Dry Ice - alcohol) mixture contained in a Dewar vessel, as in Fig. II, 22, 1; the three-way stopcock enables air to be admitted into the apparatus whilst avoiding entry of corrosive vapours into the pump. Rubber stoppers must be used throughout. Solvents of low boiling point must also be prevented from contaminating the oil in the pump: it is usually best to remove these solvents by warming gently under the vacuum of a water pump and allowing the flask to cool before connecting to the oil pump.

The so-called "hydro-vac" pump,* shown in Fig. II, 22, 2 (the upper half of the mercury reservoir and the column above it are insulated by a layer of asbestos), is an inexpensive, all-glass, mercury diffusion pump, which can be used in series *either* with an oil pump *or* with a water filter pump (compare Fig. II, 21, 1) capable of producing a "vacuum" of at least 2 mm. It is accordingly of particular value in the organic laboratory for "vacuum" distillations, fractionations, sublimations and pyrolyses as well as for "molecular" distillations (see Section II,26). The "hydro-vac" pump, unlike an oil pump, may be used in operations which evolve moisture and non-condensable or corrosive vapours. In use the pump is clamped in a vertical

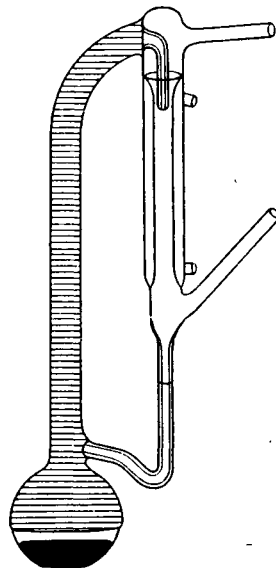

Fig. II, 22, 2.

* Supplied by the Todd Scientific Company.

position, the lower outlet tube is connected by means of rubber "pressure" tubing through a suitable safety trap to the water filter pump, whilst the upper inlet side arm is connected through another safety trap to the apparatus to be evacuated. The filter pump is turned on and when the pressure in the system is below 25 mm., the diffusion pump is started as follows. Water is passed through the condenser and the mercury reservoir is heated either with a Fisher burner or by an electric heating mantle (compare Figs. II, 57, 1-2): the burner or electric heater is adjusted so that the mercury is maintained essentially (± 5 mm.) at the calibration mark in the side arm. Under ideal conditions an ultimate vacuum of 0.00001 mm. of mercury is claimed; the pump has evidently ample capacity for most organic operations. To stop the pump, the source of heat under the mercury reservoir is removed, air is admitted to the evacuated system and the water pump is turned off. If the apparatus should become appreciably contaminated after prolonged use, the mercury is removed and is easily cleaned by washing with dilute nitric acid and then rinsed with water.

II,23. MANOMETERS AND MANOSTATS

A simple mercury manometer has already been described (see Fig. II, 19, 2). Another type that is frequently employed is the U-tube manometer illustrated in Fig. II, 23, 1. It consists of a U-tube filled with mercury and mounted on a wooden stand. The scale *B*, graduated in

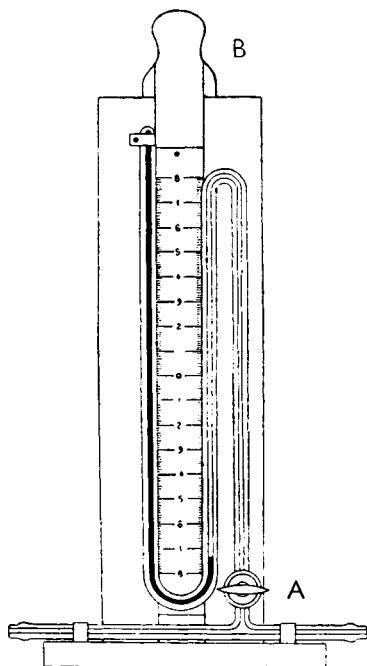

Fig. II, 23, 1.

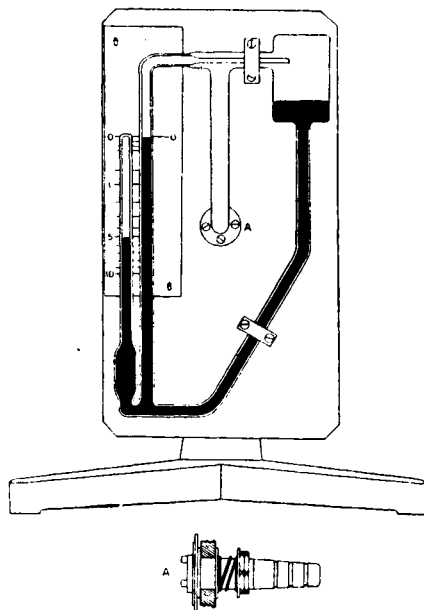

Fig. II, 23, 2.

mm.,* between the two arms of the U-tube, is movable; this enables adjustment of one of the mercury levels to a convenient point on the scale to be made, thus facilitating the reading of the difference in height of the mercury in the two arms. The pressure is obtained directly, and it is unnecessary to know the barometric pressure. A tap is usually provided so that the manometer may be isolated from the distillation apparatus when required. Great care should be exercised when using this manometer: if air is allowed to enter the exhausted apparatus rapidly and tap *A* is open, the mercury may rise to the top of the closed end with sufficient velocity to break it. It is advisable, therefore, to close stopcock *A* when the gauge is not being used, and to open it *slowly* after the pressure in the "vacuum" distillation apparatus has been restored to that of the atmosphere.

The "vacustat" † (Fig. II, 23, 2) is another useful gauge; it covers the range 10 to 0.01 mm. of mercury and is usually employed in conjunction with an oil pump. It is direct reading, compact, and is charged with only about 8 ml. of mercury. The gauge must be swivelled to the vertical position when a reading of the pressure is required; it does not automatically record a variable pressure.

The Zimmerli vacuum gauge ‡ covers a wide range of pressure (0–100 mm. Hg) and is depicted in Fig. II, 23, 3. It is an improvement of the U-tube gauge (Fig. II, 23, 1). The chief disadvantages of the latter are: (i) the necessity for boiling the mercury to remove the air from the closed reference tube when filling the gauge, (ii) the tendency for air to enter the closed limb after a period of time, and (iii) the difficulty of precision reading due to the capillary action in the narrow tube and the facile fouling of the mercury surface in the narrow tube. In the Zimmerli gauge *A* and *B* are the limbs of a U-tube each having a diameter of 16 mm. Tube *A* is the indicating limb; tube *B*, the reference limb, is not sealed at the top but is connected to a capillary tube *C*, which is in turn joined to a wide tube *D*: both *A* and *D* are connected to the vacuum line at *E*. Thus the indicating limb and the reference limb are both connected to the same vacuum line; this facilitates the filling of the gauge and its maintenance in perfect working condition. The gauge is filled with mercury as shown in the figure; the levels in *A* and *D* should be about 2 cm. above the bottom so as to form an effective seal.

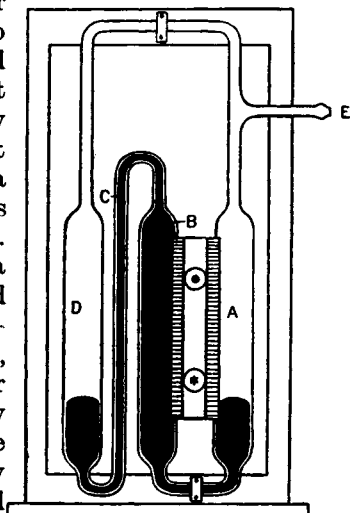

Fig. II, 23, 3.

When the manometer is connected to the apparatus in which the

* This is sometimes made of mirror glass in order to eliminate the error due to parallax.

† Manufactured by Edwards High Vacuum Ltd. This is essentially a form of McLeod gauge.

‡ Supplied by the Scientific Glass Apparatus Company; a precision model, reading to 0.1 mm., is also marketed.

pressure is to be measured, it will be found that as soon as the pressure is reduced to a value corresponding to the difference in height of the mercury levels in *A* and *B* (or *C* and *D*) the mercury will separate at the top of the bend (between *B* and *C*), and as the pressure diminishes each part will recede in *B* and *C* until the levels become constant. The difference in height of the mercury levels in *A* and *B*, read on the scale between *A* and *B*, indicates the absolute pressure.

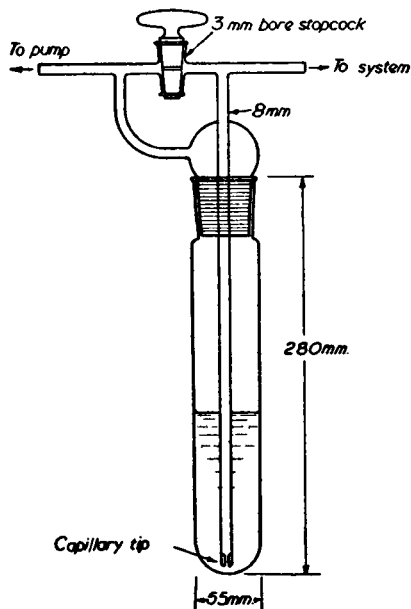

Fig. 11, 23, 4.

under diminished pressure is of great practical importance if trustworthy boiling points are desired. Devices which maintain a constant pressure in a system that is higher than the minimum pressure that the pump will give are termed manostats. A simple manostat, due to M. S. Newman, is illustrated in Fig. 11, 23, 4. The underlying principle is that the gas in the system whose pressure is to be controlled must overcome the pressure of a column of liquid before it can be pumped out. When the pump is first started the bulk of the air in the system is removed through the open stopcock. When the pressure, as measured on a mercury manometer, has almost reached the desired value, the stopcock is closed thus forcing the remaining gas to be pumped through the head of liquid in the manostat. The end of the gas inlet tube is constricted (say, to 1-1.5 mm.) so that when the system has reached equilibrium, the constant leaks therein (including the distillation capillary) cause a steady stream of bubbles instead of the more intermittent larger bubbles that result if a capillary is absent. Before admitting air when the distillation has been completed, the stopcock is opened in order to avoid violent splashing of

The reading of the pressure gauge is improved by providing blackened metal sleeves which can be moved up and down over the limbs *A* and *B*; when viewed against diffused light, the lower edges of the sleeves and the meniscus of the mercury show up against a white background as sharply defined straight and curved lines. When the sleeves are adjusted so that they seem to touch the top of the mercury columns, the absolute pressure is represented by the difference in height between the edges of the sleeves.

The maintenance of a constant pressure in a system during distillation

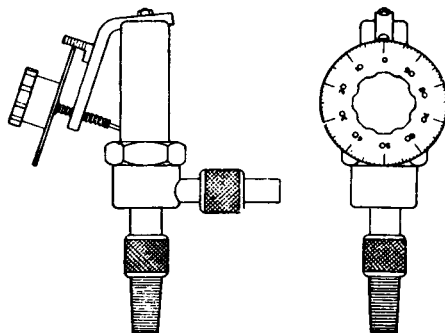

Fig. 11, 23, 5.

the liquid in the pressure regulator. The device is essentially one for maintaining a constant pressure differential between the pump system and the distillation system; the difference in pressure is equal to the head of liquid in the regulator. The liquid in the regulator may be di-*n*-butyl phthalate; this permits a pressure range of 1 mm. to 15 mm. of mercury to be covered, provided of course that the minimum pressure delivered by the pump is less than 1 mm. If higher pressures are desired, it is more convenient to use

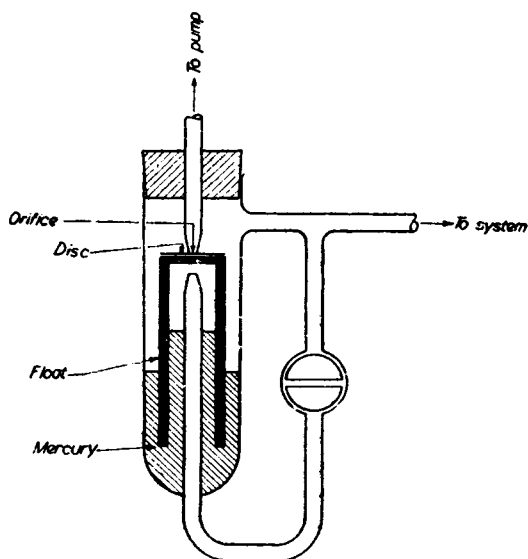

Fig. 11, 23, 6.

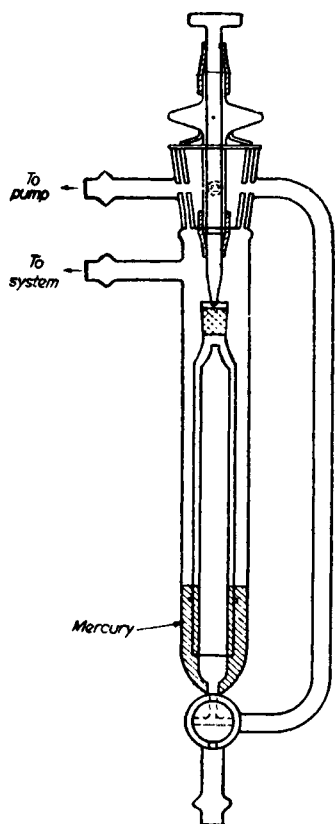

Fig. 11, 23, 7.

two or more of these regulators in series than to employ a longer one; alternatively, the manostat may be charged with a suitable volume of mercury, in which case the base should be of the Drechsel bottle type.

A mechanical device embodying a bellows-sealed needle valve with a lever reduction movement for fine control* is shown in Fig. 11, 23, 5. The needle is of stainless steel. This fine control valve assembly is useful for pressures ranging from 20 to 100 mm. of mercury when used in conjunction with a good water pump.

An excellent manostat, based on the Cartesian diver principle, is marketed under the name of Cartesian manostat.

The action of the manostat may be explained with the aid of Fig. 11, 23, 6. Mercury is introduced into the container until the disc of the float just makes contact with the orifice, when the pressure is equalised inside and outside the float. The device is connected to the pump and to the system by way of a large reservoir and a manometer. With the stopcock open, the pressure in the system is reduced by way of a by-pass between the pump and the system until the desired value as read on the manometer is reached, then both the stopcock and by-pass are

* Supplied by Edwards High Vacuum Ltd.

closed; the device will automatically maintain the desired pressure. If the system is vacuum tight, the pressure will maintain itself; a slight leak, which may be introduced intentionally, will cause the pressure to rise slightly. This will produce a displacement of the mercury level downward outside the float and a corresponding displacement upward inside the float; the buoyant force on the float is consequently diminished and when this reduction in buoyancy becomes sufficient to overcome the suction force at the orifice due to the pressure differential, the disc will break away from the orifice and permit the pump to evacuate sufficient gas from the system to restore the original pressure. When the original pressure is restored, the disc will return to its former position and seal off the orifice. The cycle is repeated indefinitely, if the size of the leak in the system does not exceed the capacity of the gas flow that is possible through the orifice and the pump is of sufficient rating to carry the load.

The commercial form of Cartesian manostat,* model 7A, is depicted in Fig. II, 23, 7; it is normally charged with mercury except for very low pressures when di-*n*-butyl phthalate is employed. The manostat is highly sensitive in its action; furthermore, once the pressure has been set in the instrument, the system may be shut down without disturbing the setting.

II.24. REFINEMENTS IN THE TECHNIQUE OF DISTILLATION UNDER DIMINISHED PRESSURE

A criticism that is sometimes levelled at distillation under diminished pressure when rubber stoppers are used is that contact of the hot vapour with the rubber frequently contaminates the distillate. In the author's

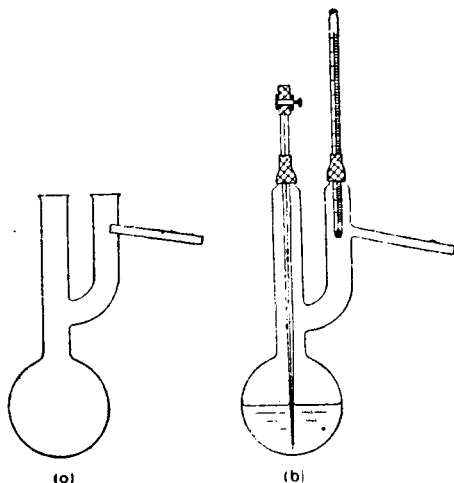

Fig. II, 24, 1.

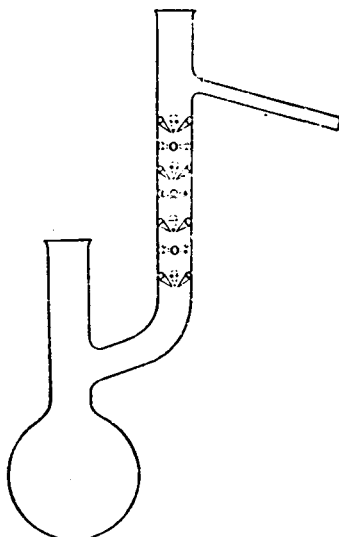

Fig. II, 24, 2.

experience, the contamination is of comparatively rare occurrence except for substances of fairly high boiling point, particularly if the stoppers have been previously used on one or two occasions. If, however, attack

* Supplied by The Emil Greiner Co. of New York and by Edwards High Vacuum Ltd.; an all-metal Cartesian manostat is also marketed.

of the rubber stoppers is suspected, two types of flask (Fig. II, 24, 1, *a* and *b*) may be utilised instead of the conventional Claisen flask. In the former (*a*) the side arm outlet is extended a short distance into the neck, thus preventing any liquid which has been in contact with the rubber stopper at the top from running down the side arm into the receiver. In the latter (*b*) the necks of the flask are constricted; here the capillary and the thermometer are held in place by short lengths of rubber "pressure" tubing slipped over the necks (this is facilitated by coating the inside of the rubber with a thin film of glycerine). If the substance is not extremely destructive to rubber, the neck carrying the capillary may be of normal diameter; filling and cleaning the flask will thus be comparatively easy. Either or both of these modifications may be introduced into the flasks

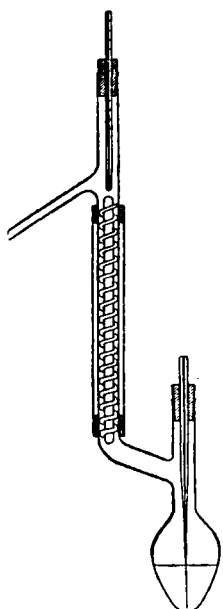

Fig. II, 24, 3.

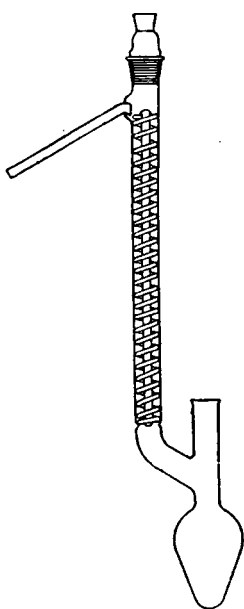

Fig. II, 24, 4.

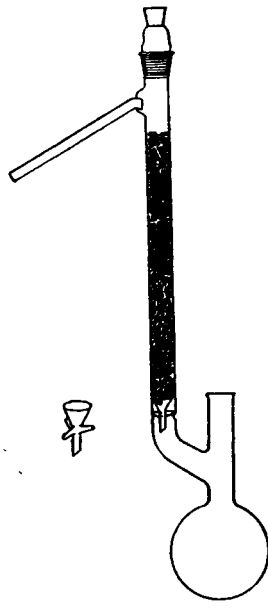

Fig. II, 24, 5.

shown in Figs. II, 24, 2-3. The difficulty mentioned above may, of course be surmounted by substituting ground glass joints (see Section II,55 *et seq.*) for rubber stoppers or tubing.

For routine fractional distillation under reduced pressure, either of the flasks shown in Figs. II, 24, 2-3 finds many applications in the laboratory. The Claisen flask with fractionating side arm (Vigreux type; Fig. II, 24, 2) has the long neck indented like a Vigreux column; great care must be taken in making these indentations (see Section II,15). In the Widmer flask (Fig. II, 24, 3) the long neck carries a closely-fitting glass spiral* wound tightly round a glass tube sealed at both ends or round a glass rod. This neck is generally surrounded by an air jacket for liquids of boiling point up to about 100°; for higher temperatures, it is recommended that the long neck be lagged with several thicknesses of asbestos cloth or better wound with electric heating tape, the heat input to which is controlled by a

* The spiral should preferably be ground into the inner walls of the long neck—compare the all-glass Dufton column, Section II,15.

variable transformer. The Widmer flask is superior to the Claisen flask with Vigreux type fractionating side arm.

The flasks depicted in Figs. II, 24, 4 and II, 24, 5* give excellent results in routine distillations at atmospheric and under diminished pressure. Pear-shaped bulbs are used for flasks of 25 and 50 ml. capacity, whilst spherical bulbs are employed for capacities of 100 and 175 ml. and larger. Each flask is provided with a B19 socket and an adapter carrying a B19 lower cone and an unground B10 or B14 socket; if required, the upper socket in the adapter may be a ground B10 or B14 and a thermometer with a ground B10 or B14 cone used in conjunction with it, but this refinement is generally unnecessary. The adapter is incorporated in the design of the flasks in order to permit the removal of the glass spiral from the necessarily wide neck and, particularly, to ensure the minimum contact

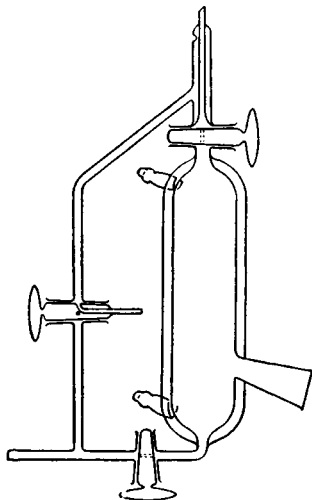

Fig. II, 24, 6.

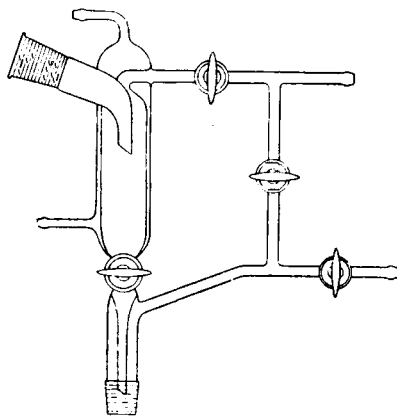

Fig. II, 24, 7.

with organic vapour of the rubber stopper holding the thermometer. The packing (Fig. II, 24, 5) may consist of either Fenske helices or Dixon gauze rings ($\frac{1}{16}$ " \times $\frac{1}{16}$ "); it will be noted that the packing is supported upon a glass funnel (the upper diameter of which is slightly less than that of the internal diameter of the long neck) which rests by means of three glass "feet" upon a slight constriction in the base of the "column." The long necks of both flasks are wound with $\frac{1}{2}$ " (or narrower) electric heating tape and the latter is covered by asbestos cloth; power input to the heating tape is controlled by a variable transformer, and a thermometer is inserted between the electric heating tape and the asbestos cloth. Attention is drawn to the fact that the long arm in Fig. II, 24, 4 is constricted slightly at the lower end; this is in order that it may be used as in Fig. II, 24, 5 by removing the glass spiral.

The following dimensions of the small flasks may be found useful. The internal seal must be inside the line of the long neck to enable the glass spiral to be inserted or removed easily. The mouth of the flask is preferably an unground B10 or B14 socket.

* Supplied by H. J. Elliott Ltd.

25 and 50 ml. flask. Side arms 10 cm. long and 4 mm. internal diameter ; shorter neck 16 mm. internal diameter ; long neck 14 mm. internal diameter to accommodate a 15 cm. spiral with 18 turns ; total length to side arm 18–20 cm. When used with Fenske helices or Dixon gauze rings, the length of the filled column will be 10–12 cm.

100 and 175 ml. flask. Side arms 10 cm. long and 5 mm. internal diameter ; shorter neck 17 mm. internal diameter ; long neck 14 mm. internal diameter to accommodate a 20 cm. spiral with 24 turns ; total length to side arm 23–25 cm. This will give a 15–17 cm. packed column.

In addition to the Perkin triangle and the Kon vacuum receiver already described (see Figs. II, 20, 1 and II, 20, 2), there are two modifications which are sometimes employed. The apparatus shown in Fig. II, 24, 6* is a standard form of all-glass Perkin triangle but with a water cooling jacket outside the receiver ; that in Fig. II, 24, 7† has a similar function and four “two-way” stopcocks are utilised in its construction. Both of the last-named receivers are designed for use with low boiling point liquids, and are also useful for the distillation of small volumes of liquids since the side arm of the Claisen flask, etc., may be fitted directly into the adapter. Another application is to the distillation of solids of low melting point ; warm water is then circulated through the glass jacket. It will be noted that a simple vacuum distillation receiver results if the apparatus of Fig. II, 24, 7 is constructed without the internal water jacket.

II,25. PRECISION FRACTIONAL DISTILLATION UNDER DIMINISHED PRESSURE

An elementary account of the subject has been given in the previous Section. For the fractional distillation under diminished pressure of liquids differing only slightly in boiling point, a fractionating column (see Sections II,15 and II,17) must be used. Provision must, of course, be made for the insertion of a capillary tube into the flask containing the mixture. This can be done by any of the following methods:—

1. If a bolt-head flask is used and a rubber stopper is permissible, there is ample room for the insertion of a capillary tube and the fractionating column in the wide neck.

2. A flask is provided with a long side neck (Fig. II, 25, 1) through which a capillary is inserted and attached externally by a short length of rubber “pressure” tubing. With this type of connexion there is essentially no contact of hot vapours with the rubber and little or no contamination results. The neck of the flask is preferably fitted with a standard ground joint if attack of the organic vapours on the rubber stopper is likely to occur.

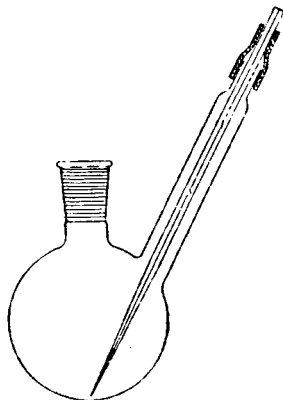

Fig. II, 25, 1.

* Marketed by Baird and Tatlock (London) Ltd.

† Marketed by the Scientific Glass Apparatus Company.

3. A two-necked flask (compare Fig. II, 56, 13), with the wide neck for the fractionating column and the small neck for the capillary tube, is widely employed.

Any of the fractionating columns previously described may be used. Precision fractionating columns, which find application under diminished pressure, are shown in Figs. II, 17, 2-4.

Claisen flasks with fractionating side arms (see Figs. II, 24, 2-5) may be employed for comparatively small volumes of liquid.

II,26. MOLECULAR DISTILLATION

In molecular distillation, the permanent gas pressure is so low (less than 0.001 mm. of mercury) that it has very little influence upon the speed of the distillation. The distillation velocity at such low pressures is determined by the speed at which the vapour from the liquid being distilled can flow through the enclosed space connecting the still and condenser under the driving force of its own saturation pressure. If the distance from the surface of the evaporating liquid to the condenser is less than (or of the order of) the mean free path of a molecule of distillate vapour in the residual gas at the same density and pressure, most of the molecules which leave the surface will not return. The mean free path of air at various pressures is as follows :—

Pressure (mm. of Hg)	1.0	0.1	0.01	0.001
Mean free path (cm.)	0.0056	0.0562	0.562	5.62

The mean free path of large organic molecules is shorter ; it is evident, therefore, that the condenser must be quite close to the evaporating surface. Strictly speaking, a molecular still may be defined as a still in which the distance between the evaporating surface and the cold condensing surface is less than the mean free path of the molecules. The escaping molecules will, for the most part, proceed in a straight path to the condenser ; by maintaining the temperature of the latter comparatively low, the amount of reflection of molecules from the condensing surface is reduced. The great advantage of distillation under a high vacuum is that the "boiling point" is considerably reduced—in some cases by as much as 200–300°—thus rendering possible the distillation of substances which decompose at higher temperatures, of substances which are very sensitive to heat, and also of compounds of very high boiling point and large molecular weight.

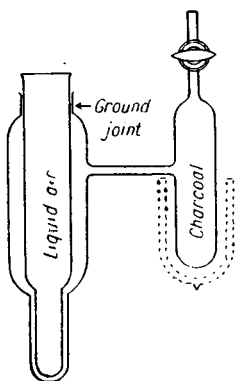

Fig. II, 26, 1.

A simple form of apparatus is that in which a cooled condensing surface is supported a few cm. above a shallow, heated pool of liquid, and the whole is enclosed in a highly evacuated chamber (compare Fig. II, 26, 1); this offers the least hindrance to the flow of vapour from the evaporating to the condensing surface. The rate of distillation is then determined by the rate at which the liquid surface is able to produce vapour. When the evaporating

liquid is a chemical individual, the rate of evaporation will be pc/s grams per square cm. per second, where p is the density of the saturated vapour at the given temperature, c is the mean molecular velocity, and s the mean free path of a distillate molecule. If the liquid is a mixture, the rate of evaporation of the r th component will be $p_r c_r / s$ grams per square cm. per second. The separation obtained in a molecular distillation thus depends upon the quantity $p_r c_r$, unlike the separation obtained in ordinary distillation, where the vapour is in equilibrium with the liquid, which depends upon p_r . Since c_r is inversely proportional to the square root of the molecular weight, and the magnitude of p_r is, in general, greatest for the components of least molecular weight, $p_r c_r$ is greatest for constituents of least molecular weight. Molecular distillation (sometimes termed *evaporative distillation*) is the only method by which substances of high molecular weight can be distilled without decomposition. According to Langmuir (1917) the theoretical rate of distillation can be written in the form :

$$w = p \sqrt{\frac{1}{2\pi MRT}}$$

where w is the weight of substance evaporating per square cm. of liquid surface per second, M is the molecular weight of the liquid, R the gas constant, and T the absolute temperature. In practice, lower values are obtained because of the reflection of molecules from the condensing surface.

Some simple apparatus, suitable for high vacuum distillation, are collected in Figs. II, 26, 1-4. Fig. II, 26, 1 represents an apparatus, which is particularly well adapted for solids ; the ground glass joint must be lubricated with a grease of negligible vapour pressure. Hickman's vacuum still * is shown in Fig. II, 26, 2 ; it is about 60 mm. in diameter,

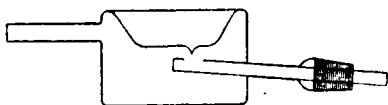

Fig. II, 26, 2.

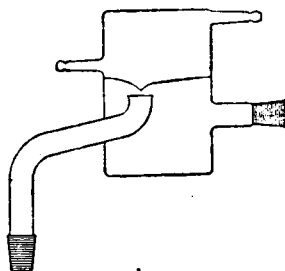

Fig. II, 26, 3.

45 mm. high and will hold about 40 ml. of liquid. The roof of the still is filled with ice water or any appropriate freezing mixture. A modification, which permits continuous flow of cooling liquid over the roof of the still, is shown in Fig. II, 26, 3. A very simple still for liquids is depicted in Fig. II, 26, 4. The horizontal flask contains the liquid to be distilled. The special receiver ("four-point-star rotating receiver") permits the collection of various fractions, but any other vacuum receiver may be employed. As a very rough approximation, the temperature of the distillation may be taken as that of the bath.

* Supplied, for example, by the Scientific Glass Apparatus Co. and by Midland Silicones Ltd.

The low pressure required for molecular distillation is usually produced by coupling a "backing" pump (e.g., a Cenco Hyvac or Edwards Speedivac pump) with *either* a multi-stage mercury diffusion pump in quartz or metal (these two are combined in certain pumps, e.g., Cenco Hypervac 4) or an oil-vapour diffusion pump* (the oils used include amyl and butyl sebacate, amyl phthalate, di-2-ethylhexyl sebacate and phthalate, Apiezon B, Dow-Corning Silicone Nos. 702 and 703). The advantages of the latter are:—(i) the highly purified oils have vapour pressures of about one

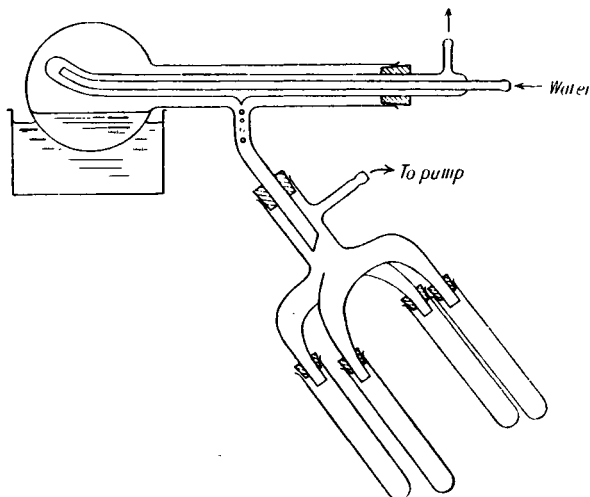

Fig. II, 26, 4.

hundredth of that of mercury and consequently produce lower pressures without the use of traps, and (ii) no contamination from mercury is possible. A McCleod gauge is generally utilised for measuring the low pressure.

The purification of solids by low pressure sublimation is described in Section II,45.

II,27. PURIFICATION OF SOLID ORGANIC COMPOUNDS BY CRYSTALLISATION

GENERAL CONSIDERATIONS

Solid organic compounds when isolated from organic reactions are seldom pure; they are usually contaminated with small amounts of other compounds ("impurities") which are produced along with the desired product. The purification of impure crystalline compounds is usually effected by crystallisation from a suitable solvent or mixture of solvents. Attention must, however, be drawn to the fact that direct crystallisation of a crude reaction product is not always advisable as certain impurities may retard the rate of crystallisation and, in some cases, may even prevent the formation of crystals entirely; furthermore, considerable loss of

* Supplied, for example, by the Scientific Glass Apparatus Co.

material may occur. It is therefore, desirable, if possible, to adopt other methods of preliminary purification {*e.g.*, steam distillation (Section II,40); distillation under diminished pressure (Section II,19); fractional distillation (Section II,15); extraction in a Soxhlet or equivalent apparatus (Section II,44) } before crystallisation.

The purification of solids by crystallisation is based upon differences in their solubility in a given solvent or mixture of solvents. In its simplest form, the crystallisation process consists of: (i) dissolving the impure substance in some suitable solvent at or near the boiling point, (ii) filtering the hot solution from particles of insoluble material and dust, (iii) allowing the hot solution to cool thus causing the dissolved substance to crystallise out, and (iv) separating the crystals from the supernatant solution (or mother liquor). The resulting solid, after drying, is tested for purity (usually by a melting point determination, Section II,10) and if found impure, it is again recrystallised from fresh solvent. The process is repeated until the pure compound is obtained; this generally means until the melting point is unchanged.

The theory underlying the removal of impurities by crystallisation may be understood from the following considerations. It is assumed that the impurities are present in comparatively small proportion—usually less than 5 per cent. of the whole. Let the pure substance be denoted by A and the impurities by B , and let the proportion of the latter be assumed to be 5 per cent. In most instances the solubilities of A (S_A) and of B (S_B) are different in a particular solvent: the influence of each compound upon the solubility of the other will be neglected. Two cases will arise for any particular solvent: (i) the impurity is more soluble than the compound which is being purified ($S_B > S_A$) and (ii) the impurity is less soluble than the compound ($S_B < S_A$). It is evident that in case (i) several recrystallisations will give a pure sample of A , and B will remain in the mother liquors. Case (ii) can be more clearly illustrated by a specific example. Let us assume that the solubility of A and B in a given solvent at the temperature of the laboratory (15°) are 10 g. and 3 g. per 100 ml. of solvent respectively. If 50 g. of the crude material (containing 47.5 g. of A and 2.5 g. of B) are dissolved in 100 ml. of the hot solvent and the solution allowed to cool to 15° , the mother liquor will contain 10 g. of A and 2.5 g. (*i.e.*, the whole) of B ; 37.5 g. of pure crystals of A will be obtained.

The most desirable characteristics of a solvent for recrystallisation are: (a) a high solvent power for the substance to be purified at elevated temperatures and a comparatively low solvent power at the laboratory temperature or below; (b) it should dissolve the impurities readily or to only a very small extent; (c) it should yield well-formed crystals of the purified compound; and (d) it must be capable of easy removal from the crystals of the purified compound, *i.e.*, possess a relatively low boiling point. It is assumed, of course, that the solvent does not react chemically with the substance to be purified. If two or more solvents appear to be equally suitable for the recrystallisation, the final selection will depend upon such factors as ease of manipulation, inflammability and cost.

The common solvents available for recrystallisation are collected in the Table II, 27.

TABLE II, 27. COMMON SOLVENTS FOR RECRYSTALLISATION

SOLVENT	B.P.	REMARKS
Water (distilled)	100°	To be used whenever suitable.
Diethyl ether	35°	Inflammable; avoid wherever possible.
Acetone	56°	Inflammable; should preferably be dried before use.
Chloroform	61°	Non-inflammable; vapour toxic.
Methyl alcohol	64·5°	Inflammable; poisonous.
Carbon tetrachloride	77°	Non-inflammable; vapour toxic
Ethyl acetate	78°	Inflammable.
Methylated (industrial) spirit	77-82°	Inflammable.
Rectified spirit (95 % C ₂ H ₅ OH)	78°	Inflammable.
Ethyl alcohol (absolute)	78°	Inflammable.
Benzene	80°	Inflammable.
Light petroleum (petroleum ether)	40-60°	Inflammable.*
Acetic acid (glacial)	118°	Not very inflammable; pungent vapours.

The use of ether as a solvent for recrystallisation should be avoided wherever possible, partly owing to its great inflammability and partly owing to its tendency to creep up the walls of the containing vessel, thus depositing solid matter by complete evaporation instead of preferential crystallisation. Carbon disulphide, b.p. 46°, should never be used if an alternative solvent can be found; it has a dangerously low flash point and forms very explosive mixtures with air.

Less commonly used solvents include methyl ethyl ketone, b.p. 80°; ethylene chloride, b.p. 84°; dioxan (diethylene dioxide), b.p. 101° (vapours are toxic); toluene, b.p. 110°; pyridine, b.p. 115·5°; chlorobenzene, b.p. 132°; cellosolve (ethylene glycol monoethyl ether), b.p. 134·5°; di-*n*-butyl ether, b.p. 141°; *s*-tetrachloroethane, b.p. 147°; nitrobenzene, b.p. 209·5°; and ethyl benzoate, b.p. 213°.



Fig. 11, 27, 1. The choice of solvent cannot usually be made on the basis of theoretical considerations alone (see below), but must be experimentally determined, if no information is already available. About 0·1 g. of the powdered substance is placed in a small test-tube (75 × 11 or 110 × 12 mm.) and the solvent is added a drop at a time (best with a calibrated dropper, Fig. 11, 27, 1) with continuous shaking of the test-tube. After about 1 ml. of the solvent has been added, the mixture is heated to boiling, due precautions being taken if the solvent is inflammable. If the sample dissolves easily in 1 ml. of cold solvent or upon gentle warming, the solvent is unsuitable. If all the solid does not dissolve, more solvent is added in 0·5 ml. portions, and again heated to boiling after each addition. If 3 ml. of solvent is added and the substance

* Other fractions available are b.p. 60-80°, 80-100°, and 100-120°: when the boiling point exceeds 120°, it is usually called "*ligroin*."

does not dissolve on heating, the substance is regarded as sparingly soluble in that solvent, and another solvent should be sought. If the compound dissolves (or almost completely dissolves *) in the hot solvent, the tube is cooled to determine whether crystallisation occurs. If crystallisation does not take place rapidly, this may be due to the absence of suitable nuclei for crystal growth. The tube should be scratched below the surface of the solution with a glass rod; the fine scratches on the walls (and the minute fragments of glass produced) may serve as excellent nuclei for crystal growth. If crystals do not separate, even after scratching for several minutes and cooling in an ice-salt mixture, the solvent is rejected. If crystals separate, the amount of these should be noted. The process may be repeated with other possible solvents, using a fresh test-tube for each experiment, until the best solvent is found; the approximate proportions of the solute and solvent giving the most satisfactory results should be recorded.

If the substance is found to be far too soluble in one solvent and much too insoluble in another solvent to allow of satisfactory recrystallisation, mixed solvents or "solvent pairs" may frequently be used with excellent results. The two solvents must, of course, be completely miscible. Recrystallisation from mixed solvents is carried out near the boiling point of the solvent. The compound is dissolved in the solvent in which it is very soluble, and the hot solvent, in which the substance is only sparingly soluble, is added cautiously until a slight turbidity is produced. The turbidity is then *just* cleared by the addition of a small quantity of the first solvent and the mixture is allowed to cool to room temperature; crystals will separate. Pairs of liquids which may be used include: alcohol and water; alcohol and benzene; benzene and petroleum ether; acetone and petroleum ether; glacial acetic acid and water.

The following rough generalisations may assist the student in the selection of a solvent for recrystallisation, but it must be clearly understood that numerous exceptions are known (for a more detailed discussion see Section XI,4):

1. A substance is likely to be most soluble in a solvent to which it is most closely related in chemical and physical characteristics.
2. In ascending a homologous series, the solubilities of the members tend to become more and more like that of the hydrocarbon from which they may be regarded as being derived.
3. A polar substance is more soluble in polar solvents and less soluble in non-polar solvents.

II,28. EXPERIMENTAL DETAILS FOR RECRYSTALLISATION

It is assumed that the best solvent and the approximate proportions of solute and solvent have been determined by preliminary tests as described in the previous Section or have been obtained from reference

* If the crude substance contains an insoluble impurity, difficulty may be experienced at a later stage in estimating how much solute has crystallised from the cold solution. The hot solution should therefore be filtered into another tube through a *very small* fluted filter paper contained in a small short-stemmed funnel. The solution must always be clear before cooling is attempted.

books containing solubility data.* The solid substance is placed either in a small bolt-head flask or conical flask and slightly less than the required quantity of solvent is added together with a few fragments of porous porcelain or, better, a boiling tube (Fig. I, 3, 1); a reflux condenser is then fitted to the flask (Fig. II, 13, 7). If the solvent is not inflammable, toxic or expensive, the reflux condenser is not essential and may be replaced by a funnel with a short stem. The mixture is boiled and more solvent is added down the condenser (or directly into the flask if a condenser is not employed) until a clear solution, apart from insoluble impurities,† is produced. If the boiling point of the solvent is below 80°, a water bath (Fig. II, 5, 1) or steam bath is satisfactory; for solvents of higher boiling point an air bath (Fig. II, 5, 3), electric hot plate, or asbestos-centred wire gauze should be used.

Filtration of the hot solution. The boiling or hot solution must be rapidly filtered before undue cooling has occurred. (If an inflammable solvent has been used, all flames in the vicinity must be extinguished.) This is usually done through a fluted filter paper (for preparation, see Section II,29) supported in a relatively large funnel with a short wide stem: separation of crystals in and clogging of the stem is thus reduced to a minimum. It is often advantageous to warm the funnel in the steam oven before filtration is started. The funnel is supported in a conical flask of sufficient size to hold all the solution; alternatively, the funnel may be clamped or supported in a stand and the filtrate collected in a beaker, but the use of a conical flask is preferable. If the operation has been successfully carried out, very little material will crystallise on the filter: any solid that does separate must be scraped back into the first flask, redissolved and refiltered. The filtered solution is covered with a watch or clock glass, and then set aside to cool undisturbed. If large crystals are desired, any solid which may have separated from the filtered solution should be redissolved by warming (a reflux condenser must be used for an inflammable solvent), the flask wrapped in a towel or cloth, and allowed to cool slowly. If small crystals are required, the hot saturated solution should be stirred vigorously and cooled rapidly in a bath of cold water or of ice.

If crystallisation commences as soon as the solvent cools or if large quantities of hot solution are to be filtered, the funnel (and fluted filter paper) should be warmed externally during the filtration (hot water funnel). Three types of hot water funnel are illustrated in Fig. II, 1, 6; no flames should be present whilst inflammable solvents are being filtered through the funnel of Fig. II, 1, 6, a. Alternatively, the funnel may be surrounded by an electric heating mantle (see Section II,57); the heat input may be controlled by a variable transformer. When dealing with considerable volumes of aqueous or other solutions which do not deposit crystals rapidly on cooling, a Buchner funnel may be used for filtration (see detailed account in Section II,1 and Fig. II 1, 7, c). The filter paper

* For example, Lange, *Handbook of Chemistry*, Ninth Edition (1956) (Handbook Publishers, Sandusky, Ohio); Seidell, *Solubilities of Inorganic and Organic Substances*, Third Edition (1941-1952) (Van Nostrand).

† The undissolved material will be readily recognised if preliminary solubility tests have been made (Section II,27).

should be of close-grained texture and should be wetted with the solvent before suction is applied ; the solution may then be poured on to the filter.

The experimental details for recrystallisation from mixed solvents (or solvent pairs) will be evident from the account already given ; the best proportions of the two solvents are determined by preliminary small-scale experiments.

II,29. PREPARATION OF A FLUTED FILTER PAPER

The filter paper is first folded in half and again in quarters, and opened up as shown in Fig. II, 29, 1, *a*. The edge 2,1 is then folded on to 2,4 and edge 2,3 on to 2,4, producing, when the paper is opened, new folds at 2,5 and 2,6. The folding is continued, 2,1 to 2,6 and 2,3 to 2,5,

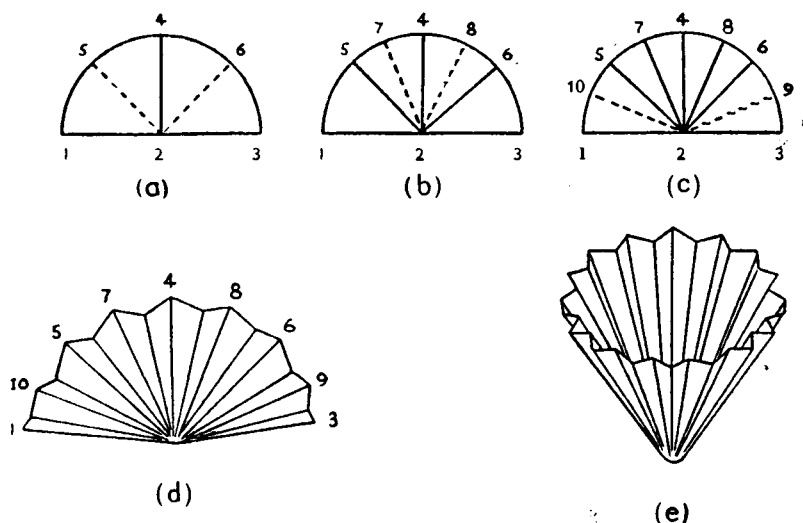

Fig. II, 29, 1.

thus producing folds at 2,7 and 2,8 respectively (Fig. II, 29, 1, *b*) ; further 2,3 to 2,6 giving 2,9, and 2,1 to 2,5 giving 2,10 (Fig. II, 29, 1, *c*). The final operation consists in making a fold in each of the eight segments—between 2,3 and 2,9, between 2,9 and 2,6, etc.—in a direction *opposite* to the first series of folds, *i.e.*, the folds are made outwards instead of inwards as at first. The result is a fan arrangement (Fig. II, 29, 1, *d*), and upon opening, the fluted filter paper (Fig. II, 29, 1, *e*) is obtained.

II,30. REMOVAL OF TRACES OF COLOURING MATTER AND RESINOUS PRODUCTS USE OF DECOLOURISING CARBON

The crude product of an organic reaction may contain a coloured impurity. Upon recrystallisation, this impurity dissolves in the boiling solvent and is partly adsorbed by the crystals as they separate upon

cooling, yielding a coloured product. Sometimes the solution is slightly turbid owing to the presence of a little resinous matter or a very fine suspension of an insoluble impurity, which cannot always be removed by simple filtration. These impurities can be removed by boiling the substance in solution with a little decolourising charcoal for 5–10 minutes, and then filtering the solution while hot as described in Section II,28. The decolourising charcoal adsorbs the coloured impurity and holds back resinous, finely-divided matter, and the filtrate is usually free from extraneous colour, and therefore deposits pure crystals. The decolourisation takes place most readily in aqueous solution, but can be performed in almost any organic solvent; the process is least effective in hydrocarbon solvents. It must be pointed out that boiling in a solvent with decolourising carbon is not always the most effective method of removing the colour: if boiling is only partially effective, it is often worth while to pass the cold solution of the substance (preferably in an organic solvent such as ether) through a small amount of decolourising carbon supported on a wad of cotton wool in the stem of a funnel—this is effectively a chromatographic procedure.

An excessive quantity of decolourising agent must be avoided, since it may also adsorb some of the compound which is being purified. The exact quantity to be added will depend upon the amount of impurities present; for most purposes 1–2 per cent. by weight of the crude solid will be found satisfactory. If this quantity is insufficient, the operation should be repeated with a further 1–2 per cent. of fresh decolourising charcoal. Sometimes a little charcoal passes through the close-grained filter paper: the addition, before filtration, of a little asbestos fibre, filter paper pulp, high grade infusorial or diatomaceous earth will give a clear filtrate. Attention is directed to the fact that the decolourising charcoal should not be added to a superheated solution as the latter may foam excessively and boil over.

The most widely known form of decolourising carbon is animal charcoal (also known as bone black or bone charcoal); it is the least expensive, but by no means the best. It has limited adsorptive power, and contains a large proportion of calcium phosphate and other calcium salts; it should not be used with acidic solutions, particularly if the desired compound is to be subsequently obtained by a process of neutralisation. This difficulty may be overcome, and all risk of the introduction of impurities into the hot solution avoided, by boiling the commercial animal charcoal with dilute hydrochloric acid (1 : 1) for 2–3 hours. The mixture is then diluted with hot distilled water, filtered through a fine-grained filter paper supported on a Buchner funnel, and washed repeatedly with boiling distilled water until the filtrate is no longer acid. It is then well drained, and dried in an evaporating basin (or casserole) over an electric hot plate or a sand bath. Acid-washed decolourising charcoal is also available commercially.

On the whole it is better to employ the activated decolourising charcoal prepared from wood. Excellent decolourising carbons are marketed under the trade names "*Norit*"* (from birch wood), "*Darco*"* and "*Nuchar*."*

* Obtainable, for example, from Eastman Kodak Company.

II,31. DIFFICULTIES ENCOUNTERED IN RECRYSTALLISATION

The separation of a second liquid phase, commonly known as an "oil," instead of the expected crystalline solid, sometimes occurs during recrystallisation. The oil often solidifies on standing, although at times a considerable period may elapse before crystallisation occurs. The resulting crystals will probably occlude some of the mother liquor, and the purity will therefore not be high. If the substance has a low melting point, it must not be assumed that this apparently abnormal behaviour is due to the presence of impurities; it is probably an example of a system in which the solid phases consist of the pure components and the components are only partially miscible in the liquid state (see Section I,18). The separation of the oil may be avoided by diluting the solution considerably, but this will lead to large losses. It is probably best to re-heat the mixture until a clear solution is obtained, and allow it to cool spontaneously; immediately the oil commences to separate, the mixture is vigorously stirred so that the oil is well dispersed in the solution. Eventually, crystals will separate and these will grow in the bulk of the solution and not in a pool of oil, so that occlusion of the mother liquor is considerably reduced. When all the oil has disappeared, stirring may be stopped and the crystals allowed to accumulate. Sometimes the addition of a minute quantity of the crude compound in order to "seed" the solution may facilitate the initial crystallisation.

Occasionally substances form supersaturated solutions from which the first crystals separate with difficulty; this is sometimes caused by the presence of a little tar or viscous substance acting as a protective colloid. The following methods should be tried in order to induce crystallisation:—

1. By scratching the inside of the vessel with a glass rod. The effect is attributed to the breaking off of small particles of glass which may act as crystal nuclei, or to the roughening of the surface, which facilitates more rapid orientation of the crystals on the surface.

2. By inoculating ("seeding") the solution with some of the solid material or with isomorphous crystals, crystallisation frequently commences and continues until equilibrium is reached. The "seed crystals" may be obtained by cooling a very thin film of liquid to a low temperature. Several drops of the solution are placed in a test-tube or beaker and spread into a thin film by rotating the container; the latter is then cooled in a mixture of ice and salt or in some other suitable freezing mixture. A better procedure, which avoids the necessity of subsequently scraping the surface to remove the "seed crystals" and the attendant melting if the compound is impure or of low melting point, is to moisten a small glass bead with the supersaturated solution, place it in a test-tube, cool the latter in a freezing mixture and thus form crystals on the surface of the bead. The glass bead can then be rolled out of the tube into the vessel containing the main bulk of the solution.

3. By cooling the solution in a freezing mixture (ice and salt, ice and calcium chloride, or solid carbon dioxide and ether). It must be borne in mind that the rate of crystal formation is inversely proportional to the temperature; cooling to very low temperatures may render the mass

very viscous and thus considerably hinder crystallisation. In the latter case, the mixture should be allowed to warm slowly so that it may be given the opportunity to form crystals if it passes through an optimum temperature region for crystal formation. Once minute crystals have been formed, it is very probable that their size will be increased by keeping the mixture at a somewhat higher temperature.

4. By adding a few lumps of solid carbon dioxide; this produces a number of cold spots here and there, and assists the formation of crystals.

5. If all the above methods fail, the solution should be left in an ice chest (or a refrigerator) for a prolonged period. The exercise of considerable patience is sometimes necessary so as to give the solution every opportunity to crystallise.

The product of a chemical reaction, isolated by solvent extraction and subsequent removal of the solvent, which should normally be crystalline, is sometimes an oil, due to the presence of impurities. It is usually advisable to attempt to induce the oil to crystallise before purifying it by recrystallisation. Methods 1 and 2 (previous paragraph) may be applied; method 2 cannot always be used because of the difficulty of securing the necessary seed crystals, but should these be available, successful results will usually be obtained. Another procedure is to add a small quantity of an organic solvent in which the compound is sparingly soluble or insoluble, and then to rub with a stirring rod or grind in a mortar until crystals appear; it may be necessary to continue the rubbing for an hour before signs of solidification are apparent. Another useful expedient is to leave the oil in a vacuum desiccator over silica gel or some other drying agent. If all the above methods fail to induce crystallisation, direct recrystallisation may be attempted: the solution should be boiled with decolourising carbon as this may remove some of the impurities responsible for the difficulty of crystal formation. Occasionally, conversion into a simple crystalline derivative is applicable; subsequent regeneration of the original compound will usually yield a pure, crystalline solid.

II,32.

FILTRATION WITH SUCTION

The technique of the filtration of hot solutions has already been described in Section II,28. The filtration of cold solutions will now be considered; this operation is usually carried out when it is desired to separate a crystalline solid from the mother liquor in which it is suspended. When substantial quantities of a solid are to be handled, a Buchner funnel of convenient size is employed. The ordinary Buchner funnel (Fig. II, 1, 7, a) consists of a cylindrical porcelain funnel carrying a fixed, flat, perforated porcelain plate. It is fitted by means of a rubber stopper or a good cork into the neck of a thick-walled filtering flask (also termed filter flask, Buchner flask or suction flask) (Fig. II, 1, 7, c), which is connected by means of thick-walled rubber tubing (rubber "pressure" tubing) to a similar flask or safety bottle, and the latter is attached by rubber "pressure" tubing to a filter pump; the safety bottle or trap is essential since a sudden fall in water pressure may result in the water "sucking back." The use of suction renders rapid filtration possible

and also results in a more complete removal of the mother liquor than filtration under atmospheric pressure. A filter paper * is selected (and trimmed, if necessary) of such size that it covers the entire perforated plate, but its diameter should be slightly less than the inside diameter of the funnel; the filter paper should never be folded up against the sides of the funnel. The filter paper is moistened with a few drops of the solvent used in the recrystallisation (or with a few drops of the clear supernatant liquid), and the suction of the pump is applied; the filter paper should adhere firmly to, and completely cover, the perforated plate of the funnel and thus prevent any solid matter from passing under the edge of the paper into the flask below. The mixture of crystals and mother liquor is then immediately filtered through the funnel under gentle suction. Gentle suction is often more effective in filtration than powerful suction, since in the latter case the finer particles of the precipitate may reduce the rate of filtration by being drawn into the pores of the filter paper. If crystals remain in the vessel when all the liquid suspension has been filtered, a little mother liquor is returned to the vessel, † well stirred to remove any crystals adhering to the sides, and again filtered. This operation may be repeated until all the solid material has been transferred to the filter. The suction is continued until most of the mother liquor has passed through: the removal of the mother liquor is facilitated by pressing the crystals down with a wide glass stopper.

If the filtrate is of value, it should be transferred to another vessel immediately the crystals have been drained. Frequently, the mother liquor may be concentrated (suitable precautions being, of course, taken if it is inflammable), and a further crop of crystals obtained. Occasionally, yet another crop may be produced. The crops thus isolated are generally less pure than the first crystals which separate, and should be recrystallised from fresh solvent; the purity is checked by a melting point determination.

When the volume of mother liquor is large and the amount of crystals small, the apparatus of Fig. II, 32, 1 ‡ may be used. The large pear-shaped receiver is supported on a metal ring attached to a stand. When the receiver is about two-thirds full, atmospheric pressure is restored by suitably rotating the "three-way" stopcock; the filtrate may then be removed by opening the tap at the lower end. The apparatus is again exhausted and the filtration continued.

After the main filtrate has been removed, the crystals should be washed in order to remove the mother liquor which, on drying, would contaminate the crystals. The wash liquid will normally be the same solvent as was used for recrystallisation, and must be used in the smallest possible

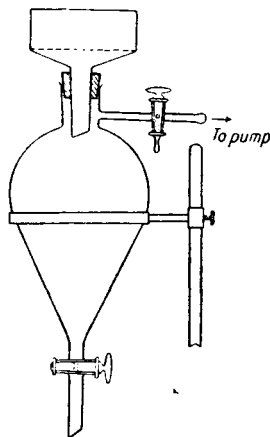

Fig. II, 32, 1.

* Two thicknesses of filter paper are desirable for aqueous solutions and, on occasion, for certain finely-divided solids.

† The filter flask must be disconnected from the pump before the latter is turned off.

‡ Supplied in capacities of 1, 2 and 4 litres by the Scientific Glass Apparatus Company.

amount in order to prevent appreciable loss of the solid. With the suction discontinued, the crystals are treated with a small volume of the solvent and cautiously stirred with a spatula or with a flattened glass rod (without loosening the filter paper) so that the solvent thoroughly wets all the crystals. The suction is then applied again, and the crystals are pressed down with a wide glass stopper as before. The washing is repeated, if necessary, after connexion to the filter pump has been broken.

If the solvent constituting the crystallisation medium has a comparatively high boiling point, it is advisable to wash the solid with a solvent of low boiling point in order that the ultimate crystalline product may be easily dried; it need hardly be added that the crystals should be insoluble or only very sparingly soluble in the volatile solvent. The new solvent must be completely miscible with the first, and should not be applied until the crystals have been washed at least once with the original solvent.

II,33. DRYING OF THE RECRYSTALLISED MATERIAL

In order to dry the crystals, the Buchner funnel is inverted over two or three thicknesses of "drying paper" (*i.e.*, coarse-grained, smooth-surfaced filter paper) resting upon a pad of newspaper, and the crystalline cake is removed with the aid of a clean spatula; several sheets of drying paper are placed on top and the crystals are pressed firmly. If the sheets become too soiled by the mother liquor absorbed, the crystals should be transferred to fresh paper. The disadvantage of this method of rapid drying is that the recrystallised product is liable to become contaminated with the filter paper fibre.

Another method, which is especially suitable for low melting point solids or solids which decompose at low temperatures, is to place the material on a porous plate or pad of "drying paper," and to cover the latter with another sheet of filter paper perforated with a number of holes or with a large clock glass or sheet of glass supported upon corks. The air drying is continued until the solvent has been completely eliminated.

For solids which melt above 100° and are stable at this temperature, drying may be carried out in a steam oven. The crystals from the Buchner funnel should then be placed on a clock glass or in an open dish. The substance may sometimes be dried in the Buchner funnel itself by utilising the device illustrated in Fig. II, 33, 1. An ordinary Pyrex funnel is inverted over the Buchner funnel and the neck of the funnel heated by means of a broad flame (alternatively, the funnel may be heated by a closely-fitting electric heating mantle); if gentle suction is applied to the filter flask, hot (or warm) air will pass over the crystalline solid.

The best method of drying, if time permits, is to place the crystals in a desiccator containing an appropriate substance (usually anhydrous calcium chloride, silica gel, or concentrated sulphuric acid) to absorb the solvent. More efficient and more rapid drying is obtained with the aid of a vacuum desiccator (see Section II,38 and Fig. II, 38, 1).

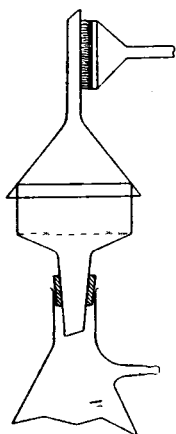

Fig. II, 33, 1.

Before attempting a melting point determination as a check on the purity, care must be taken to ensure a perfectly dry sample of the compound since traces of solvent may lower the melting point appreciably.

II,34. FILTRATION OF SMALL QUANTITIES OF MATERIAL WITH SUCTION

For the suction filtration of small quantities (less than 5 g.), a small conical Buchner funnel, known as a Hirsch funnel (Fig. II, 1, 7, b), is employed ; the filtrate is collected either in a small filter flask or in a test tube with side arm. A useful arrangement, utilising an ordinary filter funnel, is shown in Fig. II, 1, 7, d. A small Witt filter plate with bevelled edges * is inserted in the funnel and a circle of filter paper 1-2 mm. larger than the diameter of the plate is placed upon it. The filter paper is moistened with the solvent and fitted closely to the funnel by pressing and rubbing out the small folds with a glass rod. The loose perforated plate has the advantage that its cleanliness on both sides can be checked in contrast with the fixed plate in the opaque Hirsch funnel. A small sintered glass funnel or "slit-sieve" funnel (see Section II,35) may also be employed. The procedure for filtration is similar to that already given for the Buchner funnel (Section II,32).

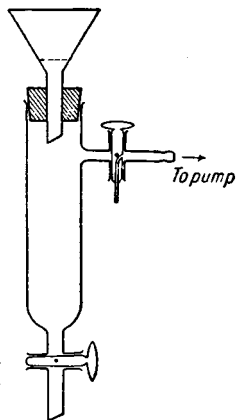

Fig. II, 34, 1.

The apparatus depicted in Fig. II, 34, 1, intended for advanced students, may be used for the filtration of a small quantity of crystals suspended in a solvent ; either a Hirsch funnel or a glass funnel with Witt filter plate is employed. The mixture of crystals and mother liquor is filtered as usual through the funnel with suction. Rotation of the "three-way" tap will allow air to enter the filter cylinder, thus permitting the mother liquor to be drawn off by opening the lower tap. The mother liquor can then be applied for rinsing out the residual crystals in the vessel, and the mixture is again filtered into the cylinder. When all the crystals have been transferred to the funnel and thoroughly drained, the mother liquor may be transferred to another vessel ; the crystals may then be washed as already described (Section II,32).

II,35. MISCELLANEOUS APPARATUS FOR FILTRATION WITH SUCTION

The chief disadvantages of a Buchner funnel for filtration are : (i) it is impossible to see whether the underside of the perforated plate is perfectly clean, and (ii) the larger sizes are "top-heavy." The first drawback is absent in the Jena "slit-sieve" funnel (Fig. II, 1, 7, f) ; this is an all-glass funnel provided with a sealed-in transparent plate, perforated by a series of angular slots, upon which the filter paper rests. The sintered glass

* A Gooch perforated porcelain plate may also be used.

funnel (Fig. II, 1, 7, *g*) is a cylindrical all-glass funnel carrying a plate of porous sintered glass; it is marketed in many sizes and in a number of porosities. A slight drawback is the difficulty of completely removing all the material from the sintered glass surface of the funnel.

Both disadvantages of the Buchner funnel are overcome in the "Minifilter" *; this constitutes an important development for the filtration of relatively large quantities of materials. The upper portion, carrying a

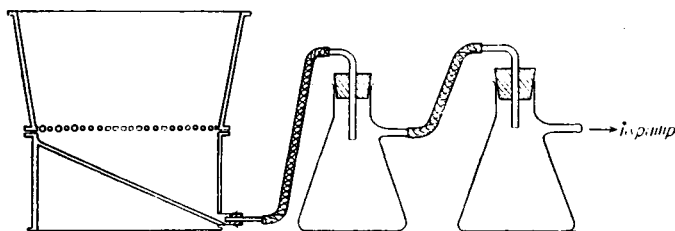

Fig. II, 35, 1.

fixed perforated filter plate, fits into the cylindrical base by a ground centre joint, and the filtrate is drawn off from the enclosed chamber below through a vacuum connexion. The "Minifilter" sits firmly on the bench and is perfectly stable; the ground centre joint enables the apparatus to be readily taken apart for cleaning. The complete assembly is illustrated in Fig. II, 35, 1; the filtrate is collected in the filter flask nearest the "Minifilter," and the second flask acts as a trap.

A similar apparatus, but without the advantage of the central ground joint is marketed under the name "Buechner stable filter" † (Fig. II, 35, 2, *a*); one method of use is shown in Fig. II, 35, 2, *b*. The "Buechner stable filter" is made of porcelain; the filtrate is drawn off through a vacuum chamber below the perforated plate, the whole apparatus is supported by a cylindrical base, and sits firmly on the bench. The sizes of perforated plate available are 56, 91, 111, 126, 186, 241 and 308 mm. diameter respectively, and it would appear that these will

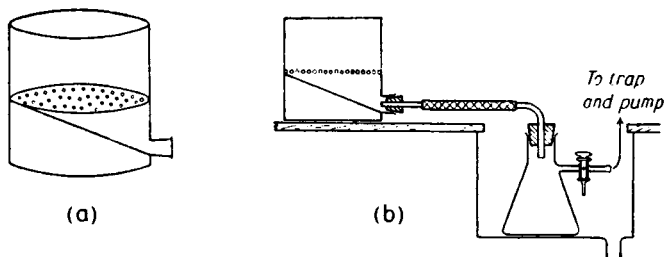

Fig. II, 35, 2.

eventually largely displace the old type of Buchner funnel for general laboratory work.

* Made by Hatherware Ltd. for filter papers of 185 and 270 mm. diameter.

† Supplied by the Fisher Scientific Company; a product of the Coors Porcelain Company.

Filtration of corrosive liquids with suction. A strongly alkaline or acid suspension is best filtered through a sintered glass funnel. Alternatively, glass wool or asbestos may be plugged into the stem of a glass funnel or supported upon a Witt plate in a glass funnel.

II,36. RECRYSTALLISATION IN AN ATMOSPHERE OF INERT GAS

Substances which decompose (or otherwise change) in contact with air must be recrystallised in an indifferent atmosphere, such as carbon dioxide, nitrogen or hydrogen. The apparatus of Fig. II, 36, 1 is almost self-explanatory; two ground glass joints are used, but these may be replaced by rubber stoppers, if desired. The crude substance is placed in the flask *A*. Stopcocks *1* and *2* are closed, and the apparatus is exhausted through tap *3*; the indifferent gas is then allowed to enter the apparatus to atmospheric pressure. The evacuation and filling with inert gas are repeated several times. The solvent is added through the tap funnel *B*. The flask *A* is heated in a suitable bath until all the solid has dissolved; a stream of inert gas may be passed through the apparatus during this operation. The flask is allowed to cool in order that the compound may crystallise out. By inclining the flask *A*, applying suction at *3* and connecting *1* to a source of inert gas, the mother liquor may be drawn into the sintered glass funnel *C* without the crystals blocking the end of the tube *D*. The crystals remaining in the flask *A* may again be recrystallised if necessary. Finally, the suspension of mother liquor and crystals is transferred to the sintered glass plate in *C* by applying suction and maintaining a stream of indifferent gas through the apparatus. In an alternative method of filtration, the sintered glass funnel is replaced by a tube carrying a sintered glass disc at the lower end inside the flask (*i.e.*, at *D*); the crystals will then remain in the flask *A*.

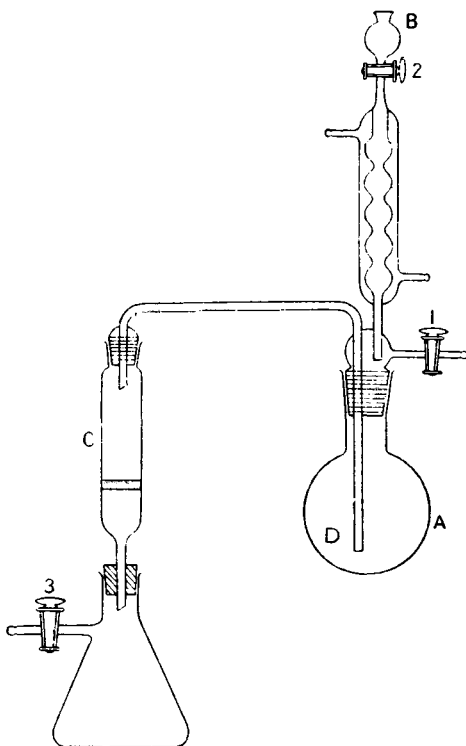

Fig. II, 36, 1.

II,37. EVAPORATION OF THE SOLVENT

It is frequently necessary to concentrate a filtrate in order to obtain a further crop of crystals, or it may be necessary to concentrate a solution to a smaller volume. If the solvent is water and the substance is not volatile in steam, simple evaporation on a large dish on a steam or water

bath is satisfactory. If more rapid evaporation is required or if organic solvents are involved, use may be made of either of the following

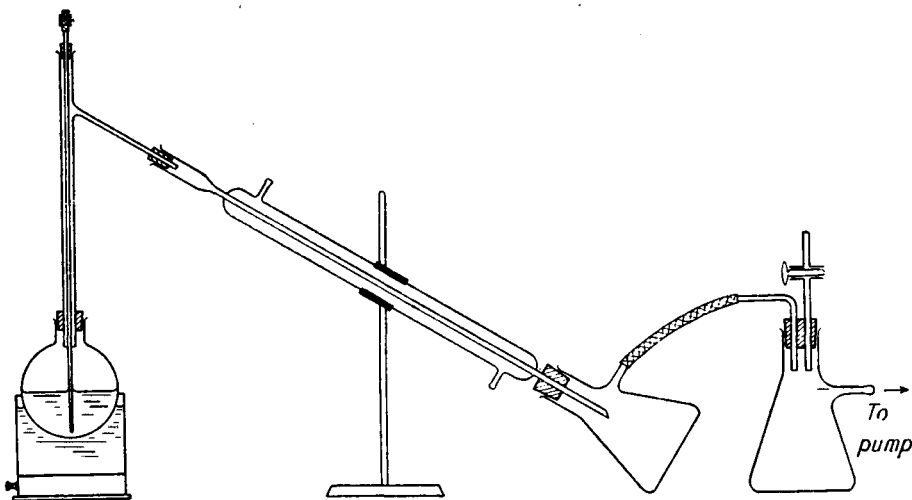

Fig. II, 37, 1.

assemblies. Fig. II, 37, 1 illustrates a convenient set-up for concentrating a large volume of solution. The solution is placed in a large bolt-head flask, the special head is introduced and connected to a condenser, a filter flask as receiver, and another filter flask acting as a trap. Rubber stoppers must be used throughout. The flask should never be more than half full, so that foaming of the contents into the condenser may be avoided. Heating is carried out in a water bath, and the pressure is reduced by means of a water pump.

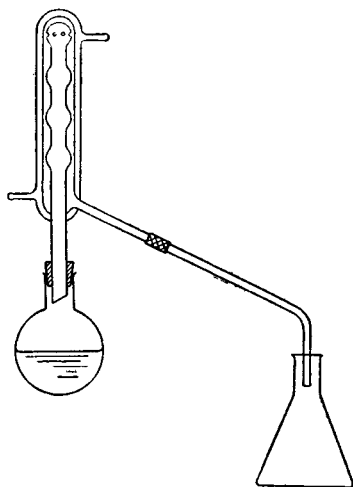

Fig. II, 37, 2.

Fig. II, 37, 2 depicts the apparatus for dealing with comparatively small volumes of liquid. The essential feature is the special condenser with a take-off tube. A few small pieces of porous porcelain are introduced and the flask is heated either on a water bath or upon an electric hot plate. The assembly is also useful in the recrystallisation of compounds which

dissolve slowly; excess of solvent may be employed, and the excess of solvent subsequently removed by distillation.

II,38. DRYING OF SOLID ORGANIC COMPOUNDS

The theory of the action of drying agents has been considered in Section I,20. We are now concerned with the practical methods for the removal of water from organic solids and liquids and from solutions of

these in organic solvents. The present Section will be devoted to the drying of solids.

A solid, moist with water or a volatile organic solvent, may be dried in the open air by spreading it in thin layers on several layers of absorbent filter paper; the whole should be covered by a sheet of glass, clock glass or absorbent paper resting upon corks in order to protect it from dust (compare Section II,33). This method is rather time-consuming if water is to be completely removed. More effective drying may be secured by placing the substance in thin layers upon clock glasses in a steam oven or in a thermostatically-controlled, electrically-heated oven; the temperature of the drying oven must be below the melting or decomposition

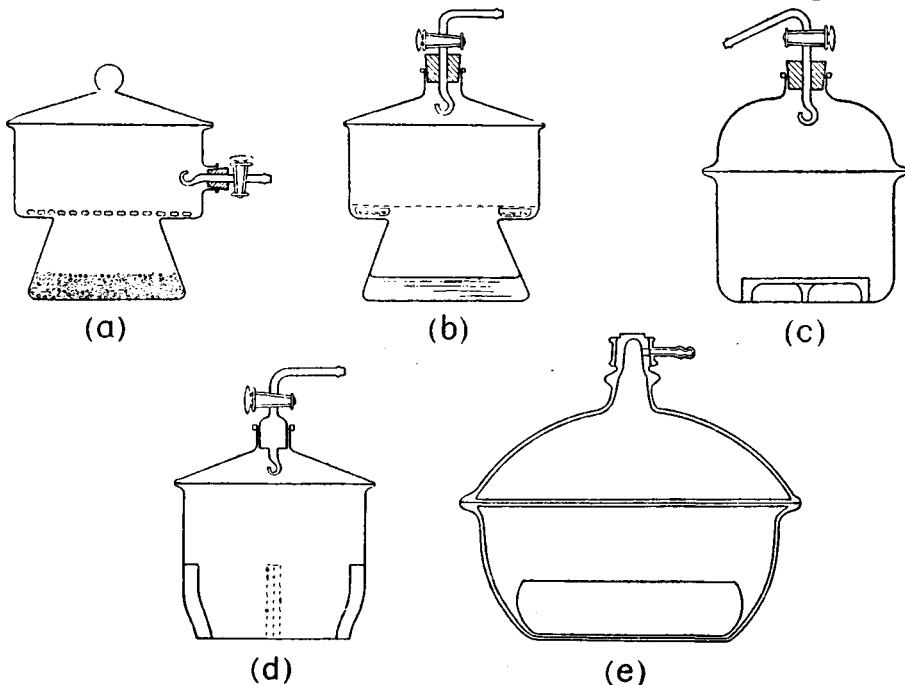

Fig. II, 38, 1.

point of the compound, and it is recommended that a preliminary test be made with a small sample.

Small quantities of solids may be spread upon unglazed porcelain plates. The chief disadvantage of this method is the comparatively high cost of the porous plates, since they cannot be conveniently cleaned nor can the same area be used for different substances. However, a plate may be broken and used for small amounts of material.

The best method for removing water (and also solvents of relatively low boiling point) adhering to solids is drying under reduced pressure.* A vacuum desiccator is used for this purpose; several forms are shown in Fig. II, 38, 1. These are fitted {with the exception of (e)} either with

* The ordinary desiccator (as in Fig. II, 38, 1, a, but without tubulure) may be used. The drying at atmospheric pressure is, however, slow. A vacuum desiccator should be employed, if available.

a ground-in stopcock or with a rubber stopper carrying the stopcock; the latter is more economical since the tap may be readily replaced if broken. Fig. II, 38, 1, *a* and *b* are the so-called Scheibler forms of desiccator with tubulure in the side and lid respectively; (*c*), the dome form, is constructed with heavy walls and has a relatively large internal volume; (*d*) is a heavy wall Pyrex desiccator; (*e*) is a Pyrex desiccator especially designed for a high vacuum.* In order to render the desiccators air-tight, the ground surfaces of the cover and body are lightly smeared with pure vaseline or with a mixture of pure vaseline and resin stearate.†

When exhausting desiccators, a filter flask trap (see Fig. II, 19, 2) should always be inserted between the desiccator and the pump. The "vacuum" should be applied gradually and should not exceed about 50 cm. of mercury for models (*a*), (*b*) and (*d*). These desiccators may withstand lower pressures, but it is generally considered unsafe to exhaust below this pressure unless the precaution be taken of surrounding the desiccator by a cage of fine-mesh steel wire; collapse of the desiccator will then do no harm.‡ Models (*c*) and (*e*) may be exhausted to about 20 mm. of mercury; a steel wire cage must be provided for this low pressure.

The charge of the desiccator will naturally depend upon the exact nature of the substance to be absorbed. An effective "universal" filling is obtained by placing concentrated sulphuric acid § in the lower half and flake sodium hydroxide || in the inverted glass collar supported on the shoulders of the desiccator, the collar being then covered with a zinc gauze or a glazed porcelain perforated plate (as shown in Fig. II, 38, 1, *b*). If ether, chloroform, carbon tetrachloride, benzene, toluene and similar vapours are to be absorbed, some freshly cut shavings of paraffin wax should be placed on the sodium hydroxide. Alternatively, granular calcium chloride may be placed in the bottom of the desiccator and silica gel in the shallow porcelain container (Fig. II, 38, 1, *c*); if acid vapours are likely to be present, the latter may be charged with flake or pellet sodium hydroxide.

* The distinguishing features are: (i) the special stopcock is constructed to turn easily under a high vacuum; (ii) a moulded arrow on the stopcock indicates the "open" position, and a quarter turn from this position closes the desiccator; and (iii) a special liquid container of the non-spill type.

† Many other lubricants are available commercially. "Cello-Seal," designed by Dr. K. Hickman and having a castor oil base, and "Cello-Grease," a similar lubricant intended for stopcocks and ground glass joints, are marketed by the Fisher Scientific Company. "Silicone" stopcock grease (Midland Silicones Ltd.; I.C.I. Silicones Ltd.; Dow-Corning) may also be used; it is said to be applicable over the range -40° to 240° .

‡ The "Desiguard," supplied by the Fisher Scientific Company, is a commercial form of perforated guard for desiccators. It is 12 inches in diameter, 11 inches high, and the upper opening is 3 inches in diameter.

§ If a solution of 18 g. of barium sulphate in one litre of concentrated sulphuric acid is employed, a precipitate of barium sulphate will form when sufficient water has been absorbed to render it unfit for drying: recharging will then, of course, be necessary.

|| This dual filling permits the absorption of both acid and basic vapours which may be evolved. Thus an amine hydrochloride, which has been recrystallised from concentrated hydrochloric acid, may be readily dried in such a desiccator. If concentrated sulphuric acid alone were used, so much hydrogen chloride would be liberated that the pressure inside the desiccator would rise considerably, and the rate of drying would be reduced. With sodium hydroxide present, however, the hydrogen chloride is removed, and the water is absorbed in the normal manner by the reagents but largely by the acid.

When using a vacuum desiccator, the vessel containing the substance (clock glass, etc.) should be covered with an inverted clock glass. This will protect the finer crystals from being swept away should the air, accidentally, be rapidly admitted to the desiccator. In actual practice the tube inside the desiccator leading from the stopcock is bent so that the open end points in the direction of the lid, hence if the tap is only slightly opened and air allowed to enter slowly, there is little danger of the solid being blown from the clock glass or other receptacle.

Frequently the water or other solvent is so firmly held that it cannot be completely removed in a vacuum desiccator at the ordinary temperature. These substances are dried in a vacuum oven at a higher temperature. A convenient laboratory form of vacuum oven is the so-called

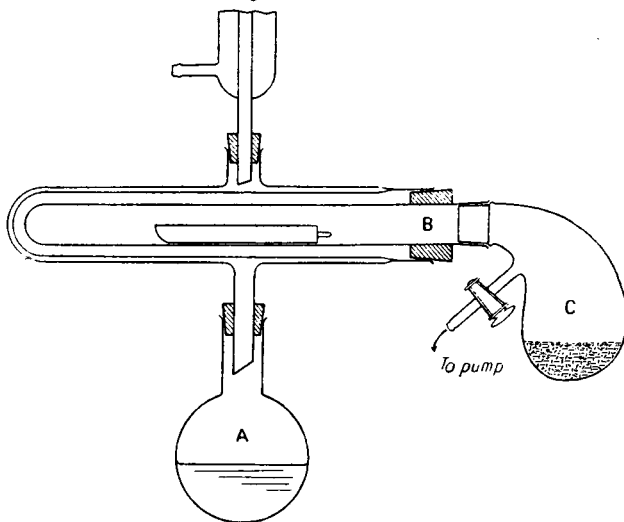

Fig. II, 38, 2.

“drying pistol” (*Abderhalden vacuum drying apparatus*) (Fig. II, 38, 2). The vapour from a boiling liquid in the flask *A* rises through the jacket surrounding the drying chamber *B* (holding the substance), and is returned by the condenser. The drying chamber *B* is connected by means of a ground glass joint to the vessel *C* containing the drying agent: *C* is attached to a suction pump. The liquid in *A* is selected according to the temperature desired, e.g., chloroform (62°), trichloroethylene (86°), water (100°), perchloroethylene (120°), *s*-tetrachloroethane (146°), etc. The charge in *C* consists of phosphorus pentoxide distributed on glass wool when water is to be removed, of potassium hydroxide flakes or pellets for removal of acid vapours, and of silica gel or thin layers of paraffin wax for removal of organic solvents, such as chloroform, carbon tetrachloride, benzene and toluene.

II.39. DRYING OF LIQUIDS OR OF SOLUTIONS OF ORGANIC COMPOUNDS IN ORGANIC SOLVENTS

Liquids or solutions of organic substances in organic solvents are usually dried by direct contact with a solid inorganic drying agent. The

selection of the desiccant will be governed by the following considerations :—(i) it must not combine chemically with the organic compound ; (ii) it should have a rapid and effective drying capacity ; (iii) it should not dissolve appreciably in the liquid ; (iv) it should be as economical as possible ; and (v) it should have no catalytic effect in promoting chemical reactions of the organic compound, such as polymerisation, condensation reactions, and auto-oxidation. The various common drying agents are discussed in detail below ; their relative efficiencies will depend upon the vapour pressure of the system, water : drying agent (see Section I,20).

It is generally best to shake the liquid with small amounts of the drying agent until no further action appears to take place : too large an excess is to be avoided in order to keep absorption losses down to a minimum. If sufficient water is present to cause the separation of a small aqueous phase (*e.g.*, with calcium chloride), this must be removed and the liquid treated with a fresh portion of the desiccant. If time permits, the liquid, when apparently dry, should be filtered and left overnight in contact with fresh drying agent. The desiccant should, in general, be separated by filtration (best through a fluted filter paper) before the distillation of the liquid. This is particularly necessary with many reagents whose drying action depends upon the formation of hydrates (*e.g.*, sodium sulphate, magnesium sulphate, and calcium chloride) : at higher temperatures the vapour pressures above the salts become appreciable and unless the salts are removed, much, if not all, of the water may be returned to the distillate. However, with some desiccating agents (sodium, quicklime, baryta, phosphorus pentoxide), the reaction products with water are quite stable and filtration is not essential.

A list of the common drying agents with their practical limitations and their important applications follows.

“ Anhydrous ” calcium chloride. This reagent is widely employed because of its high drying capacity and its cheapness. It has a large water-absorption capacity (since it forms $\text{CaCl}_2 \cdot 6\text{H}_2\text{O}$ below 30°) but is not very rapid in its action ; ample time must therefore be given for desiccation. The slowness of the action is attributed to the blanketing of the particles of calcium chloride with a thin layer of the solution formed by the extraction of the water present ; on standing, the water combines forming a solid lower hydrate, which is also a desiccating agent.

The industrial process for preparing the reagent usually permits a little hydrolysis to occur, and the product may contain a little free calcium hydroxide or basic chloride. It cannot therefore be employed for drying acids or acidic liquids. Calcium chloride combines with alcohols, phenols, amines, amino-acids, amides, ketones, and some aldehydes and esters, and thus cannot be used with these classes of compounds.

Anhydrous magnesium sulphate. This is an excellent, neutral desiccating agent and is inexpensive. It is rapid in its action, chemically inert and fairly efficient, and can be employed for most compounds including those (esters, aldehydes, ketones, nitriles, amides, etc.) to which calcium chloride is not applicable.

Granular magnesium sulphate is prepared by heating the heptahydrate gently (at $150\text{--}175^\circ$) in an oven until most of the water of hydration has been

evolved, and then heating to redness. A product of less attractive appearance is obtained more rapidly by heating the crystallised salt in a thin layer in an evaporating dish or casserole over a wire gauze; the solid will melt partially and steam will be copiously evolved. The residue (granules and powder) is powdered in a glass mortar, and preserved in a tightly-corked, wide-mouthed bottle. If the crystallised salt is stirred with a glass rod during heating, a dry powder is ultimately obtained directly.

Anhydrous sodium sulphate. This is a neutral drying agent, is inexpensive, and has a high water-absorption capacity (forming $\text{Na}_2\text{SO}_4 \cdot 10\text{H}_2\text{O}$ below $32 \cdot 4^\circ$). It can be used on almost all occasions, but the drying action is slow and not thorough. The desiccant is valuable for the preliminary removal of large quantities of water. Sodium sulphate is an inefficient drying agent for solvents, such as benzene and toluene, whose solubility in water is slight: anhydrous copper sulphate is preferable. Anhydrous sodium sulphate is useless as a desiccant above $32 \cdot 4^\circ$, the decomposition temperature of the decahydrate.

Anhydrous calcium sulphate. When the dihydrate $\text{CaSO}_4 \cdot 2\text{H}_2\text{O}$ or the hemihydrate $2\text{CaSO}_4 \cdot \text{H}_2\text{O}$ is heated in an oven at $230\text{--}240^\circ$ for about three hours, anhydrous calcium sulphate is obtained; much material may be regenerated by the same process. It is sold commercially under the name of "*Drierite*" (not to be confused with "*Dehydrite*," which is magnesium perchlorate). The reagent is extremely rapid and efficient in its action, is chemically inert, and is insoluble in organic solvents; it may therefore be used with most organic compounds. The only disadvantage is its limited capacity for absorption of water since it passes into the hemihydrate $2\text{CaSO}_4 \cdot \text{H}_2\text{O}$, and should theoretically absorb only 6.6 per cent. of its weight of water to retain its maximum efficiency: where extreme desiccation is not essential, the porous commercial product may absorb up to about 10 per cent. of its weight of water. This desiccant is more expensive than magnesium and sodium sulphates, but it can easily be regenerated as indicated above. It is recommended that the substance be subjected to a preliminary drying with magnesium or sodium sulphate, the latter filtered off, and the "*Drierite*" applied.

The great efficiency of anhydrous calcium sulphate is due to the fact (see Section I,20) that the vapour pressure of the system:

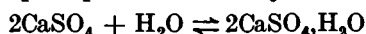

is only 0.004 mm. at about 25° , and the change with rise of temperature up to about 100° is small. Organic solvents with boiling points below 100° may

COMPOUND	d_4^{25} (found)	d_4^{25} (accepted)
Methyl alcohol . . .	0.7891 (22°)	0.7898
Ethyl alcohol . . .	0.7851	0.7851
Diethyl ether . . .	0.7138 (20°)	0.7135
Acetone . . .	0.7844	0.7844
Formic acid . . .	1.2202	1.2212
Acetic acid . . .	1.051 (20°)	1.0498

therefore be dried by direct distillation from the reagent. The efficiency of its own action will be apparent from the Table on p. 141, which the densities of a few compounds dried by distillation over anhydrous calcium sulphate are compared with the accepted values.

Anhydrous potassium carbonate. This drying agent possesses a moderate efficiency and drying capacity (the dihydrate is formed). It is applied to the drying of nitriles, ketones, esters and some alcohols, but cannot be employed for acids, phenols and other acidic substances. It also sometimes replaces sodium or potassium hydroxide for amines, when a strongly alkaline reagent is to be avoided. Potassium carbonate frequently finds application in salting-out water-soluble alcohols, amines and ketones, and as a preliminary drying agent. In many cases it may be replaced by anhydrous magnesium sulphate.

Sodium and potassium hydroxides. The use of these efficient reagents is generally confined to the drying of amines (soda lime, barium oxide and quicklime may also be employed): potassium hydroxide is somewhat superior to the sodium compound. Much of the water may be first removed by shaking with a concentrated solution of the alkali hydroxide. They react with many organic compounds (*e.g.*, acids, phenols, esters and amides) in the presence of water, and are also soluble in certain organic liquids so that their use as desiccants is very limited.

Calcium oxide. This reagent is commonly used for the drying of alcohols of low molecular weight; its action is improved by preheating to 700–900° in an electric furnace. Both calcium oxide and calcium hydroxide are insoluble in the medium, stable to heat, and practically non-volatile,* hence the reagent need not be removed before distillation. Owing to its high alkalinity, it cannot be used for acidic compounds nor for esters; the latter would undergo hydrolysis. Alcohols dried by distillation over quicklime are not completely dry; the last traces of moisture may be removed by distillation over aluminium or magnesium amalgam or by treatment with a high boiling point ester and a little sodium (see Section II, 47, 5 and 6).

Aluminium oxide. The commercial material, "activated alumina," is made from aluminium hydroxide; it will absorb 15–20 per cent. of its weight of water, can be re-activated by heating at 175° for about seven hours, and does not appreciably deteriorate with repeated use. Its main application is as a drying agent for desiccators.

Boric anhydride. This is a powerful and efficient desiccant and will absorb up to about 25 per cent. of its weight of water. It is useful for drying formic acid.

Phosphorus pentoxide. This is an extremely efficient reagent and is rapid in its reaction. Phosphoric oxide is difficult to handle, channels badly, is expensive, and tends to form a syrupy coating on its surface after a little use. A preliminary drying with anhydrous magnesium

* Some finely divided particles of solid may be carried over during the distillation from quicklime. It is recommended that the head of the distillation assembly leading to the condenser be a wide tube filled with purified glass wool in order to retain the finely-divided solid. The purified glass wool is prepared by boiling commercial glass wool with concentrated nitric acid for about 15 minutes, washing thoroughly with distilled water, and drying at 120°.

sulphate, etc., should precede its use. Phosphorus pentoxide is only employed when extreme desiccation is required. It may be used for hydrocarbons, ethers, alkyl and aryl halides, and nitriles, but not for alcohols, acids, amines and ketones.

Metallic sodium. This metal is employed for the drying of ethers and of saturated and aromatic hydrocarbons. The bulk of the water should first be removed from the liquid or solution by a preliminary drying with anhydrous calcium chloride or magnesium sulphate. Sodium is most effective in the form of fine wire, which is forced directly into the liquid by means of a sodium press (see under *Ether*, Section II,47,1): a large surface is thus presented to the liquid. It cannot be used for any compound with which it reacts or which is affected by alkalis or is easily subject to reduction (due to the hydrogen evolved during the dehydration), viz., alcohols, acids, esters, organic halides, ketones, aldehydes, and some amines.

CAUTION. Sodium must be handled with great care and under no circumstances may the metal be allowed to come into contact with water as a dangerous explosion may result. Sodium is stored under solvent naphtha or xylene; it should not be handled with the fingers but with tongs or pincers. Waste or scrap pieces of sodium should be placed in a bottle provided for the purpose and containing solvent naphtha or xylene: they should never be thrown into the sink or into the waste box. If it is desired to destroy the scrap sodium, it should be added in small portions to rather a large quantity of methylated spirit.

Concentrated sulphuric acid. The only well-known use for this reagent is for drying bromine, with which it is immiscible. The bromine is shaken in a separatory funnel with small quantities of concentrated sulphuric acid until no further action takes place. The reagent is, however, widely used for desiccators.

Absorbent cotton (cotton wool). This material is an excellent drying agent for use in the so-called "calcium chloride tubes," i.e., drying tubes, placed at the top of dropping funnels, reflux condensers, etc., to exclude moisture. It is more convenient than calcium chloride, and should preferably be dried in an oven at 100° before use.

The common drying agents that are suitable for various classes of organic compounds are listed in Table II, 39.

Drying by distillation. In most cases the distillation of organic preparations before drying is regarded as bad technique, but in a number of instances of solvents or liquids, which are practically insoluble in water, the process of distillation itself effects the drying. In short, advantage is taken of the formation of binary and ternary mixtures of minimum boiling point (compare Section I,4, and also the theory of steam distillation in Section I,6). Thus if moist benzene is distilled, the first fraction consists of a mixture of benzene and water (the constant boiling point mixture, b.p. 69.3°, contains 29.6 per cent. of water); after the water has been removed, dry benzene distils. Other solvents which may be dried in this manner include carbon tetrachloride, toluene, xylene, hexane, heptane, petroleum ether, and ethylene dichloride. The dry solvent should not be collected until after about 10 per cent. of the main bulk has passed over, since it is necessary to eliminate also

TABLE II, 39. COMMON DRYING AGENTS FOR ORGANIC COMPOUNDS

<i>Alcohols</i>	Anhydrous potassium carbonate ; anhydrous magnesium or calcium sulphate ; quicklime.
<i>Alkyl halides</i> <i>Aryl halides</i>	Anhydrous calcium chloride ; anhydrous sodium, magnesium or calcium sulphate ; phosphorus pentoxide.
<i>Saturated and aromatic hydrocarbons</i> <i>Ethers</i>	Anhydrous calcium chloride ; anhydrous calcium sulphate ; metallic sodium ; phosphorus pentoxide.
<i>Aldehydes</i>	Anhydrous sodium, magnesium or calcium sulphate.
<i>Ketones</i>	Anhydrous sodium, magnesium or calcium sulphate ; anhydrous potassium carbonate.
<i>Organic bases (amines)</i>	Solid potassium or sodium hydroxide ; quicklime ; barium oxide.
<i>Organic acids</i>	Anhydrous sodium, magnesium or calcium sulphate.

the moisture adsorbed by the walls of the flask and the condenser. If moist aniline (b.p. 184°) or moist nitrobenzene (b.p. 210°) is distilled, the moisture is rapidly removed in the first portion of the distillate and the remainder of the liquid passes over dry. Sometimes a moist liquid preparation, which is sparingly soluble in water, is dried by admixture with a solvent (usually benzene) immiscible with water, and the resulting mixture is distilled. Thus when a mixture of *n*-valeric acid, water and benzene is distilled, the mixture of benzene and water passes over first (b.p. 69·3°), this is followed by dry benzene (b.p. 80°), and finally by dry *n*-valeric acid (b.p. 186°). This method has been used for the drying of commercial preparations of *iso*-valeric, *n*-caproic, *iso*-caproic, capric acids, etc. by distillation with about 40 per cent. of the weight of benzene until the temperature of the vapours reaches 100°. The dehydration of crystallised oxalic acid by distillation with carbon tetrachloride (see also pinacol from pinacol hydrate, Section III,77) is sometimes regarded as another example of the use of a binary mixture for the removal of water.

The use of a ternary mixture in the drying of a liquid (ethyl alcohol) has been described in Section I,5 ; the following is an example of its application to the drying of a solid. Laevulose (fructose) is dissolved in warm absolute ethyl alcohol, benzene is added, and the mixture is fractionated. A ternary mixture, alcohol-benzene-water, b.p. 64°, distils first, and then the binary mixture, benzene-alcohol, b.p. 68·3°. The residual, dry alcoholic solution is partially distilled and the concentrated solution is allowed to crystallise : the anhydrous sugar separates.

Drying by hydrolysis. The production of extremely dry (99·9+ per cent.) ethyl alcohol from commercial "absolute" alcohol (99+ per cent.) is possible by taking advantage of the fact that the hydrolysis of an ester consumes water. Thus if the "absolute" alcohol is treated with a little sodium in the presence of an ester of high boiling point (*e.g.*, ethyl

phthalate or ethyl succinate) and the mixture is distilled from a water or steam bath, extremely dry alcohol will pass over :



(see Section II,47,5).

II.40. TECHNIQUE OF STEAM DISTILLATION

Steam distillation is a means of separating and purifying organic compounds. Essentially the operation consists in volatilising a substance, which is insoluble or sparingly soluble in water, by passing steam into a mixture of the compound and water. Provided the organic compound has an appreciable vapour pressure (at least 5–10 mm. at 100°), it will distil with the steam ; it can be readily separated from the distillate since it is immiscible with water. Steam distillation takes place at a temperature below the boiling point of water (for theory, see Section I,6) and hence, in numerous cases, well below the boiling point of the organic substance. This renders possible the purification of many substances of high boiling point by low temperature distillation, and is particularly valuable when the substances undergo decomposition when distilled alone at atmospheric pressure. It is also of importance in the separation of the desired organic compound :

(i) from non-volatile tarry substances which are formed as by-products in many reactions ;

(ii) from aqueous mixtures containing dissolved inorganic salts ;

(iii) in those cases where other means of separation might lead to difficulties (*e.g.*, the direct ether extraction of aniline, produced by the reduction of nitrobenzene by tin, etc., leads to troublesome emulsion formation owing to the alkali and the tin compounds present) ;

(iv) from compounds which are not appreciably volatile in steam (*e.g.*, *o*-nitrophenol from *p*-nitrophenol) ; and

(v) from certain by-products which are steam volatile (*e.g.*, diphenyl and excess of unreacted starting materials from the non-volatile triphenylcarbinol, Section IV,202).

The student should be familiar with the theory of steam distillation, given in Section I,6, before carrying out the operation in the laboratory.

A simple apparatus for steam distillation is shown in Fig. II, 40, 1, *a*. The steam is generated in the steam can *A*,* which is provided with a long glass safety tube dipping well below the surface of the water, and passes into the round-bottomed flask *B* by a tube bent as shown. The steam distillation flask is inclined at an angle so as to prevent the solution in *B* from being splashed into the entrance of the outlet tube and thus being blown over mechanically into the condenser. A tube of comparatively wide bore (5–8 mm.), with one end just below the cork in the flask, connects the flask with a Liebig condenser. The distillate is collected in the flask *D* ; *E* is a glass adapter which facilitates the collection of the distillate, but may be omitted if desired. The flask *B* is heated on an asbestos-centred wire gauze, supported on a tripod. If the laboratory

* Alternatively, a flask (capacity one litre or more), fitted with a two-holed cork carrying a long safety tube and a short right-angled bend, may be used. A large distilling flask will serve the same purpose.

possesses an external steam supply, the trap (Fig. II, 40, 1, *b* or *c*) replaces the steam can; it will remove foreign matter and also the water present in the steam; the screw clip is opened from time to time to allow the accumulated water to run to the sink.

To carry out a steam distillation, the solution (or mixture or the solid with a little water) is placed in the flask *B*, and the apparatus is completely assembled. Steam is passed into the flask *B*, which is itself heated by means of a small flame to prevent too rapid an accumulation of water, at such a rate that it is completely condensed by the condenser *C*. The passage of steam is continued until there is no appreciable amount of water-insoluble material in the distillate. If the substance crystallises

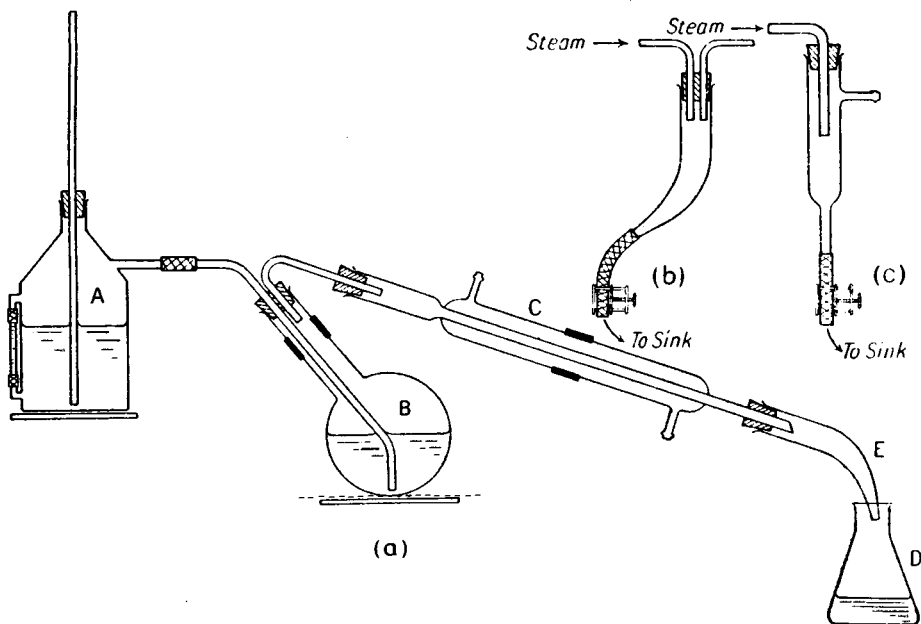

Fig. II, 40, 1.

in the condenser and tends to choke it, the water should be run out of the condenser for a few minutes until the solid material has been melted and carried by the steam into the receiver; the water should then be cautiously re-admitted to the hot condenser. To discontinue the distillation, the rubber connexion between the steam can and the flask is first removed; this will prevent any liquid from the flask *B* passing into *A*. The flames are then extinguished. The method of isolation of the pure organic compound from the distillate will depend upon its physical state and upon its solubility in water. Examples will be found in Chapters III and IV.

II,41. MODIFICATIONS OF THE STEAM DISTILLATION APPARATUS

It is frequently convenient to carry out the steam distillation from the flask in which the chemical reaction has taken place; losses due to

transfer to another vessel are thus avoided and much time may be saved. Two types of suitable apparatus are illustrated in Figs. *II, 41, 1* and *II, 41, 2*; the former is for a three-necked flask and the latter for a bolt-head (or other wide-necked) flask.

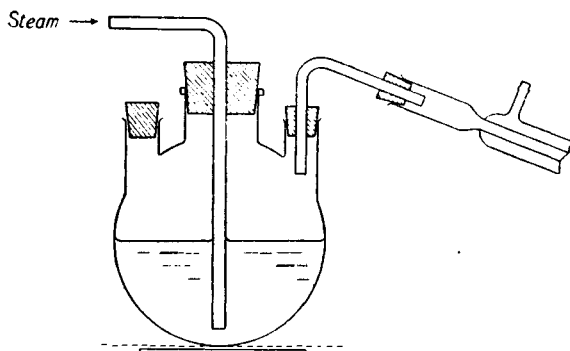

Fig. *II, 41, 1*.

The set-up of Fig. *II, 41, 3* ensures the complete condensation of the steam when a rapid flow of steam is necessary for satisfactory results, and is useful in the distillation of large volumes of liquids of low vapour pressure, such as nitrobenzene. Thus the flask *A* containing the mixture may be of 3-litre capacity and *B* may be a 1-litre flask; the latter is cooled by a stream of water, which is collected in a funnel and conducted to the sink. The receiver *C* must be of proportionate size; all stoppers

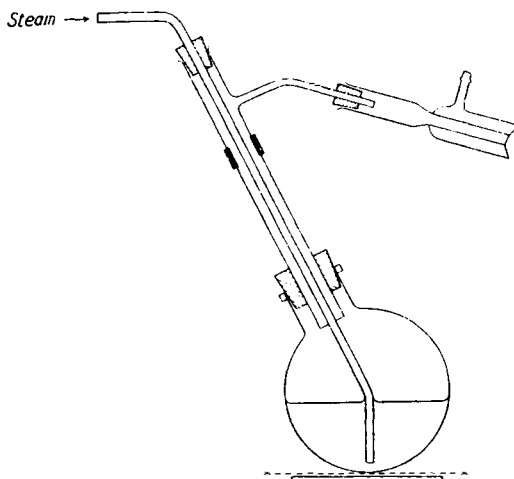

Fig. *II, 41, 2*.

should be wired into place. When a rapid current of steam is passed into the flask *A* (which should be heated on an asbestos-centred gauze by means of a small flame), some vapour is soon condensed in receiver *B* and the resulting liquid forms a liquid seal at the exit tube. Vapour cannot escape into the second condenser. The effect of uncondensed vapour in *B* is to force the liquid over into *C* as soon as sufficient pressure

develops. To determine when the distillation is complete, the supply of cooling water for flask *B* is temporarily turned off; this results in the

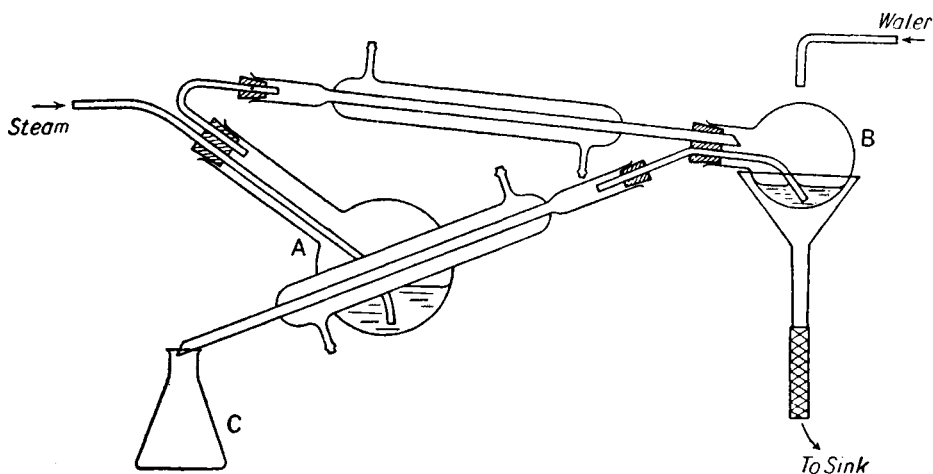

Fig. II, 41, 3.

emptying of the intermediate receiver and permits the inspection of the condensed liquid in the second condenser.

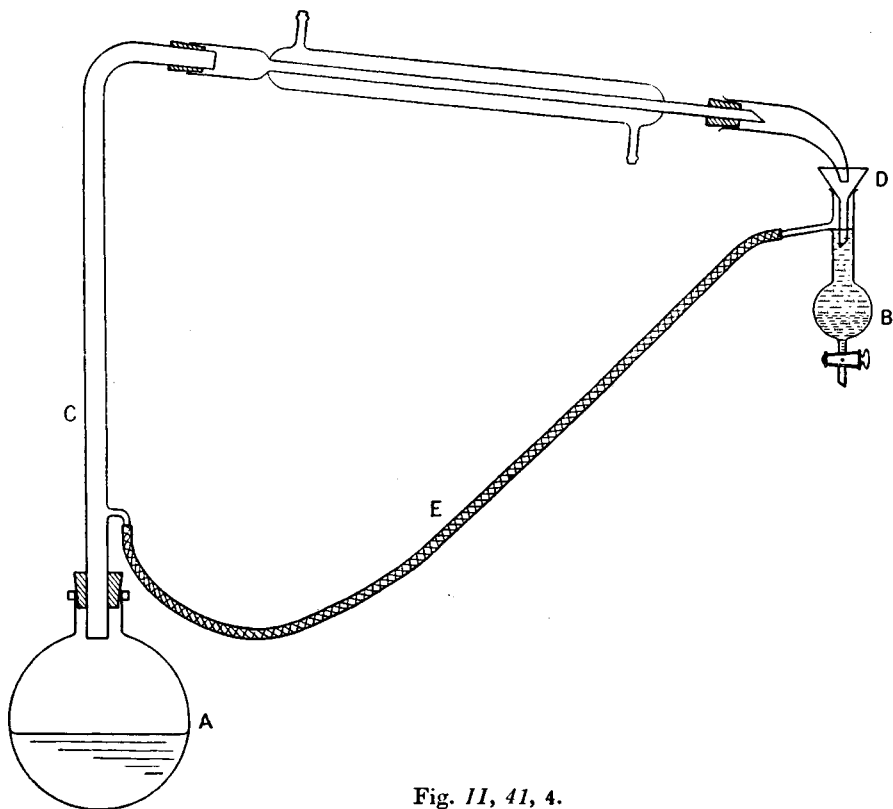

Fig. II, 41, 4.

Fig. II, 41, 4 is an apparatus for the continuous steam distillation of a liquid which is heavier than water. The aqueous mixture is placed in the flask *A* of relatively large capacity; the receiver *B* consists of a distilling flask (provided with a stopcock at the lower end), the capacity of which is less than the volume of the liquid in *A*, and is placed several inches higher than the opening in the wide vertical tube *C*. The lower end of the funnel *D* must be below the side arm of the receiver in order to prevent bubbles of the heavy liquid from collecting on the surface of the steam distillate and being carried back to the flask *A*. The rubber tube *E* for the returning aqueous liquor must at some point be lower than the entrance to the tube *C* so that a trap of liquid will be formed and prevent the vapours from *A* entering the side tube. Sometimes an air bubble enters the tube *E* and prevents the regular flow of liquid from *B*; the air bubble is easily removed by shaking the rubber tube. The flask *A* is heated (e.g., by a ring burner) so that distillation proceeds at a rapid rate; the process is a continuous one. If the liquid to be steam distilled is lighter than water, the receiver must be modified so that the aqueous liquors are drawn off from the bottom (see *Continuous Extraction of Liquids*, Section II,44).

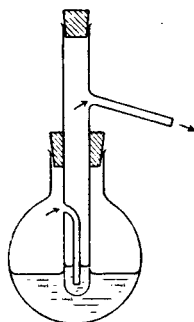

Fig. II, 41, 5.

The steam distillation of small quantities of material may be conducted in the apparatus of Fig. II, 41, 5. The substance to be distilled is placed in the small inner tube (a specially constructed test-tube) and water is boiled in the outer bolt-head flask. The volume of the liquid in the inner tube does not increase appreciably since it is immersed in the hot liquid in the flask.

The theory of, and the apparatus for, distillation with superheated steam are described in Section I,7.

II,42. TECHNIQUE OF EXTRACTION WITH SOLVENTS

A common operation in practical organic chemistry is the separation of an organic compound from a solution or suspension in a liquid by shaking with a second solvent in which the organic compound is soluble and which is immiscible (or nearly immiscible) with the liquid containing the substance. The liquid is generally water, so that the subsequent discussion will be concerned with extraction from this medium. The solvents generally employed for extraction are diethyl ether, di-*iso*-propyl ether, benzene, chloroform, carbon tetrachloride, and petroleum ether. The solvent selected will depend upon the solubility of the substance to be extracted in that solvent (compare Section I,22) and upon the ease with which the solvent can be separated from the solute. Diethyl ether, owing to its powerful solvent properties and its low boiling point (35°) thus rendering its removal extremely facile, is very widely used; its chief disadvantage lies in the great fire hazard attending its use, but this may be reduced to a minimum by adopting the precautions given in Section II,14. The fire hazard is reduced also by employing di-*iso*-propyl ether (b.p. 67·5°), but this solvent is much more expensive than diethyl ether.

The theory of extraction with solvents has been discussed in Section I,22, and it has been shown that for a given volume of solvent several extractions with aliquot parts give better results than a single extraction with the total volume of the solvent. By way of illustration, the technique of the extraction of an aqueous solution with diethyl ether * will be described. A separatory funnel (globular or pear-shaped with a short stem, see Figs. II, 1, 5, c and d) is selected of about twice the volume of the liquid to be extracted, and is mounted in a ring on a stand with a firm base. The barrel and plug of the stopcock are dried with a linen cloth, and lightly treated with a suitable lubricant (vaseline, etc.; see third footnote in Section II,38). A new well-fitting cork is selected for closing the mouth of the funnel; alternatively, the ground glass stopper, supplied with the separatory funnel, may be used. The solution and the extraction solvent (usually about one third of the volume of the solution, but see Section I,22) are introduced into the funnel, and the latter stoppered. All naked flames in the immediate vicinity should be extinguished. The funnel is then shaken *gently* (so that the excess vapour pressure † will be developed slowly), inverted, and the stopcock opened in order to relieve the excess pressure. The stopcock is again closed, the funnel again shaken, and the internal pressure released. When the atmosphere inside the funnel is saturated with ether vapour, further shaking develops little or no additional pressure. At this stage, the funnel is vigorously shaken for 2-3 minutes to ensure the maximum possible transfer of the organic substance to the ether layer, and then returned to the stand in order to allow the mixture to settle. When two sharply defined layers have formed, the lower aqueous layer is run off and separated as completely as possible. The residual ethereal layer is then poured out through the upper neck of the funnel; contamination with any drops of the aqueous solution still remaining in the stem of the funnel is thus avoided. The aqueous solution may now be returned to the funnel and the extraction repeated, using fresh ether on each occasion until the extraction is complete. Not more than three extractions are usually required, but the exact number of extractions will naturally depend upon the partition coefficient (Section I,22) of the substance between water and ether. The completeness of the extraction can always be determined by evaporating a portion of the last extract on the water bath and noting the amount of residue. The combined ethereal solutions are dried with an appropriate reagent (Section II,39), and the ether removed on a water bath (Sections II,5, II,13 and II,14). The residual organic compound is purified, depending upon its properties, by distillation or by recrystallisation.

Occasionally emulsions are formed in the extraction of a aqueous solution by organic solvents, thus rendering a clean separation impossible. Emulsion formation is particularly liable to occur when the aqueous

* Diethyl ether will be abbreviated throughout the book to *ether*. The ether should be reasonably free from "peroxides," see Section II,47,1.

† When ether is poured into a funnel containing an aqueous solution, a two liquid-phase system is formed (compare Section I,6). If the funnel is stoppered and the mixture shaken, the vapour pressure of the ether (300-500 mm., according to the temperature) is ultimately added to the pressure of the air (about 760 mm.) plus water vapour, thus producing excess of pressure inside the funnel. Hence the necessity for shaking gently and releasing the pressure from time to time until the air has been expelled.

solution is alkaline, but the emulsion may be broken by the addition of dilute sulphuric acid, if this is permissible. Various devices which are employed to break up emulsions include :—

1. Drawing a stream of air over the surface by inserting a tube, connected to a water pump, above the mixture.

2. Saturating the aqueous phase with sodium chloride.

3. Addition of a few drops of alcohol or other suitable solvent (this is generally undesirable).

In general, however, satisfactory separation will be obtained if the mixture is allowed to stand for some time.

In the isolation of organic compounds from aqueous solutions, use is frequently made of the fact that the solubility of many organic substances in water is considerably decreased by the presence of dissolved inorganic salts (sodium chloride, calcium chloride, ammonium sulphate, etc.). This is the so-called salting-out effect.* A further advantage is that the solubility of partially miscible organic solvents, such as ether, is considerably less in the salt solution, thus reducing the loss of solvent in extractions.

II,43. EXTRACTION BY CHEMICALLY ACTIVE SOLVENTS

This type of extraction depends upon the use of a reagent which reacts chemically with the compound to be extracted, and is generally employed either to remove small amounts of impurities in an organic compound or to separate the components of a mixture. Examples of such reagents include dilute (5 per cent.) aqueous sodium or potassium hydroxide solution, 5 or 10 per cent. sodium carbonate solution, saturated sodium bicarbonate solution (*ca.* 5 per cent.), dilute hydrochloric or sulphuric acid, and concentrated sulphuric acid.

Dilute sodium hydroxide solution (and also sodium carbonate solution and sodium bicarbonate solution) can be employed for the removal of an organic acid from its solution in an organic solvent, or for the removal of acidic impurities present in a water-insoluble solid or liquid. The extraction is based upon the fact that the sodium salt of the acid is soluble in water or in dilute alkali, but is insoluble in the organic solvent. Similarly, a sparingly soluble phenol, *e.g.*, β -naphthol, $C_{10}H_7.OH$, may be removed from its solution in an organic solvent by treatment with sodium hydroxide solution.

Dilute hydrochloric or sulphuric acid finds application in the extraction of basic substances from mixtures or in the removal of basic impurities. The dilute acid converts the base (*e.g.*, ammonia, amines, etc.) into a water-soluble salt (*e.g.*, ammonium chloride, amine hydrochloride). Thus traces of aniline may be separated from impure acetanilide by shaking with dilute hydrochloric acid: the aniline is converted into the soluble salt (aniline hydrochloride) whilst the acetanilide remains unaffected.

Cold concentrated sulphuric acid will remove unsaturated hydrocarbons present in saturated hydrocarbons, or alcohols and ethers present in alkyl halides. In the former case soluble sulphonated products are formed, whilst in the latter case alkyl hydrogen sulphates or addition complexes, that are soluble in the concentrated acid, are produced.

* For a detailed discussion, see, for example, Glasstone, *Text Book of Physical Chemistry*, 1947, p. 729 (Van Nostrand; Macmillan).

II,44. CONTINUOUS EXTRACTION OF LIQUIDS OR SOLIDS BY SOLVENTS

When the organic compound is more soluble in water than in the organic solvent (*i.e.*, the distribution coefficient between the organic solvent and water is small, compare Section I,22), very large quantities of organic solvent must be employed in order to obtain even a moderate extraction. This may be avoided by the use of an apparatus for continuous extraction; only relatively small volumes of solvent are required. Two types of apparatus are used for the extraction of aqueous solutions according as to whether the organic solvent is heavier or lighter than water. Figs. II, 44, 1 and 2 illustrate two forms of apparatus for the extraction of a heavier liquid by a lighter one, *e.g.*, an aqueous solution by means of ether. The assembly of Fig. II, 44, 1 is suitable for the extraction of relatively small volumes of solutions; the lower end of the funnel may carry a sealed-in sintered glass disc to improve the circulation of the lighter solvent or it may be sealed

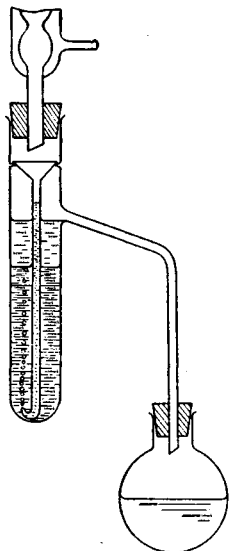

Fig. II, 44, 1.

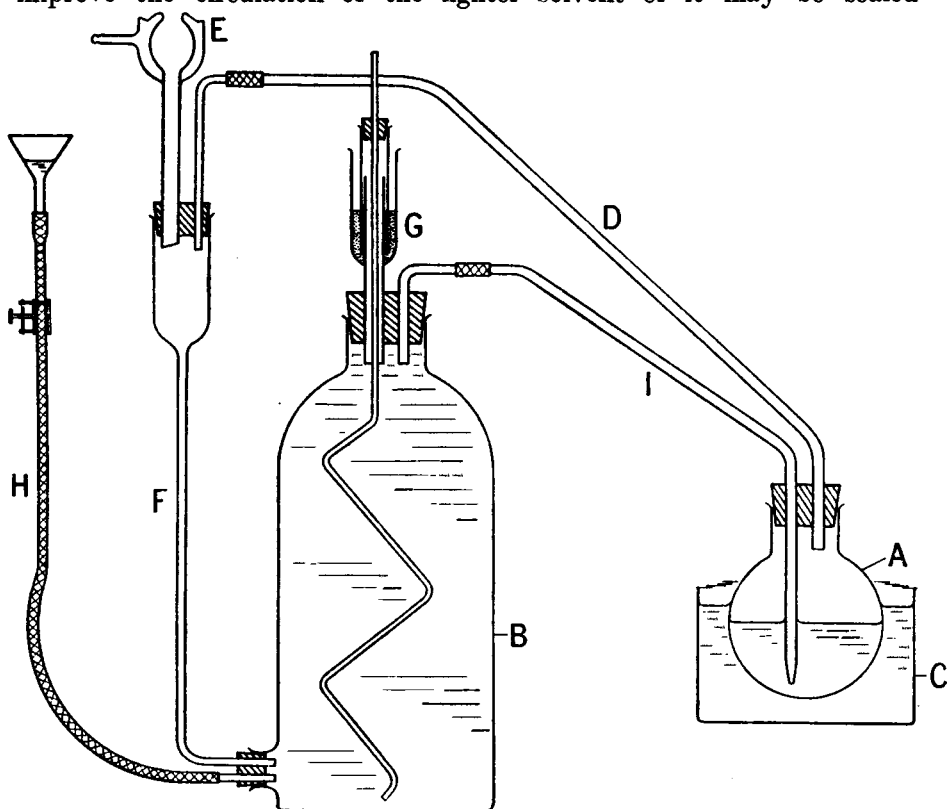

Fig. II, 44, 2.

completely in the form of a small bulb with three 1 mm. holes blown near the bottom. The set-up of Fig. II, 44, 2 is preferable where comparatively large volumes of solutions are involved. Two-thirds of the solvent to be used for the extraction are placed in the flask *A* and the remainder in the wide-mouthed bottle *B*, which should be just large enough to hold the aqueous solution and the solvent (ether). The flask is heated on a steam or water bath *C*; the ether vapour passes through the tube *D* into the condenser (preferably of the double surface type) *E*. The condensed ether flows through *F* into the bottle *B*, the contents of which are mechanically stirred by the mercury-sealed stirrer *G* in order to ensure efficient contact of the liquids. The tube *H*, carrying the screw clip, enables the bottle to be filled or emptied without disconnecting the apparatus. If the solution in *A* becomes too concentrated and consequently so hot that ether cannot flow back through the tube *I* owing to its rapid vaporisation, the contents of the flask *A* must be removed and replaced by fresh solvent.

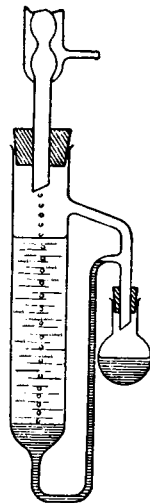

Fig. II, 44, 3.

Fig. II, 44, 3 depicts an apparatus for the continuous extraction of a liquid with a heavier liquid, for example, an aqueous solution by chloroform or carbon tetrachloride. The apparatus of Fig. II, 44, 2 can easily be adapted for the same purpose by arranging for the

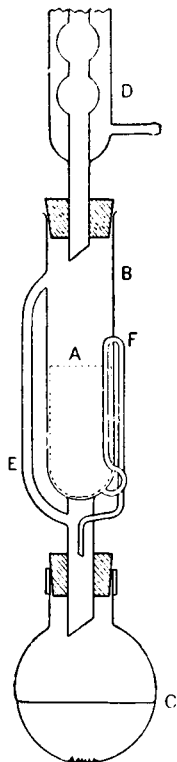

Fig. II, 44, 4.

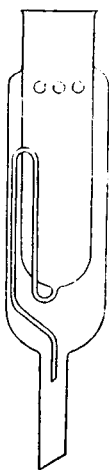

Fig. II, 44, 5.



Fig. II, 44, 6.

removal of the solvent from the *bottom* of the extraction bottle *B* and returning it to the flask *A*.

For the continuous extraction of a solid by a hot solvent, the *Soxhlet extraction apparatus*, shown in Fig. II, 44, 4, is usually employed. The

solid substance is placed in the porous thimble *A* (made of tough filter paper) and the latter is placed in the inner tube of the Soxhlet apparatus. The apparatus is then fitted to a bolt-head flask *C*, containing the solvent, and to a reflux condenser *D* (preferably of the double surface type). The solvent is boiled gently; the vapour passes up through the tube *E*, is condensed by the condenser *D*, and the condensed solvent falls into the thimble *A* and slowly fills the body of the Soxhlet.* When the solvent reaches the top of the tube *F*, it siphons over into the flask *C*, and thus removes that portion of the substance which it has extracted in *A*. The process is repeated automatically until complete extraction is effected. The extracted compound may be isolated from its solution in *C* by any of the usual methods. One minor disadvantage of this apparatus is that the temperature of the liquid in *A* differs considerably from the boiling point of the solvent; extraction is thus effected by the lukewarm liquid and is therefore relatively slow, particularly if the solubility of the substance increases markedly with temperature. This disadvantage is absent in the modifications illustrated in Figs. II, 44, 5 and 6, in which the part of the apparatus housing the extraction thimble is surrounded by the vapour of the solvent: extraction is accordingly effected by the hot solvent. In Fig. II, 44, 5 the inner wide tube carrying the siphon tube is fused to the outer jacket, and the vapour of the solvent enters through the series of small holes near the top. In Fig. II, 44, 6 the inner tube rests on small glass supports situated at the bottom of the outer jacket.

II,45. TECHNIQUE OF SUBLIMATION

The theory of sublimation, *i.e.* the direct conversion from the vapour to the solid state without the intermediate formation of the liquid state, has been discussed in Section I,19. The number of compounds which can be purified by sublimation under normal pressure is comparatively small (these include naphthalene, anthracene, benzoic acid, hexachloroethane, camphor, and the quinones). The process does, in general, yield products of high purity, but considerable loss of product may occur.

The simplest form of apparatus consists of a small porcelain evaporating dish covered with a filter paper which has been perforated with a number of small holes; a watch glass of the same size, convex side uppermost, is placed on the filter paper. The substance is placed inside the dish, and the latter heated with a minute flame on a wire gauze or sand bath. The sublimate collects in the watch glass, and the filter paper below prevents the sublimate from falling into the residue. The watch glass may be kept cool by covering it with several pieces of damp filter

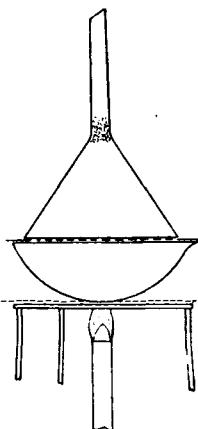

Fig. II, 45, 1.

* For solids of low density, the top of the porous thimble *A* should be above the siphon tube *F*, otherwise the solid may tend to float out of the thimble and pass down the siphon tube.

paper, and moistening these from time to time. Another form of apparatus suitable for somewhat larger quantities of material, is shown in Fig. II, 45, 1. The crude substance is placed in an evaporating dish and a

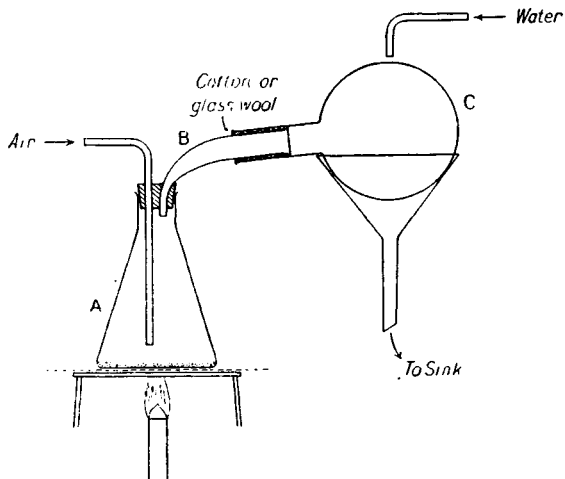

Fig. II, 45, 2.

narrow ring of Pyrex glass or asbestos board is fitted near the rim. The latter supports a filter paper or thin asbestos paper pierced with a number of small holes, and an inverted glass funnel, with a plug of glass wool in the stem, is supported upon the asbestos or glass ring. Upon heating the dish gently, the pure compound collects on the upper surface of the filter (or asbestos) paper or on the walls of the funnel; the heating is stopped when most of the material in the dish has vaporised. Care must be taken that the supply of heat is adjusted so that the funnel does not become more than lukewarm. Excellent results may be obtained by using a funnel surrounded by a water jacket or with a coil of copper tubing wound into a 60° cone and through which water is circulated (compare the hot water funnel of Fig. II, 1, 6, b). An alternative procedure, which is particularly valuable for substances which sublime at a comparatively high temperature, is to use a large crucible, preferably of silica, which is fitted into a hole in a thick asbestos board so that about half of the crucible projects beneath the board. Two nested funnels are inverted over the crucible, the larger funnel having a plug of glass wool in the neck. The crucible is then heated to the required temperature with an open flame.

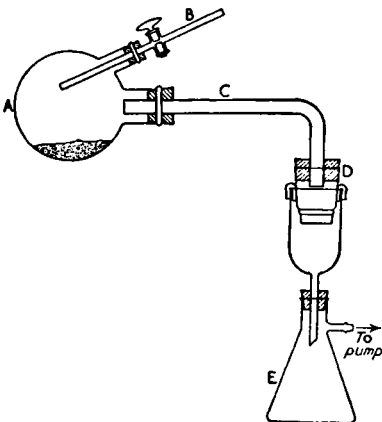

Fig. II, 45, 3.

A simple apparatus for sublimation in a stream of air or inert gas is shown in Fig. II, 45, 2. A is a wide-necked conical flask provided with

a two-holed cork carrying a delivery tube for the supply of air (or inert gas) and an adapter *B*; the latter fits loosely into a round-bottomed flask *C*, the mouth of which is plugged with glass or cotton wool. The flask *C* is cooled by a stream of cold water, which is collected in the funnel below and the waste water is run to the sink. Upon heating the crude substance in the flask *A*, the pure material collects on the walls of *C*.

A simple apparatus for sublimation in a stream of air or of inert gas is shown in Fig. II, 45, 3. *A* is a two-necked flask equipped with a narrow inlet tube *B* with stopcock and a wide tube *C* 12–15 mm. in diameter. The latter is fitted to a sintered glass crucible and the usual adapter and suction flask *E*. A well-fitting filter paper is placed on the sintered glass filter plate to collect any sublimate carried by the gas stream.

Sublimation under reduced pressure. The so-called "vacuum sublimation" may be carried out in the apparatus of Fig. II, 45, 4. The "cold finger" is fitted into the larger tube by means of a rubber stopper

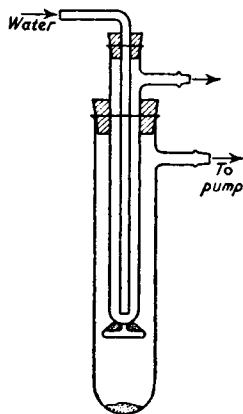

Fig. II, 45, 4.

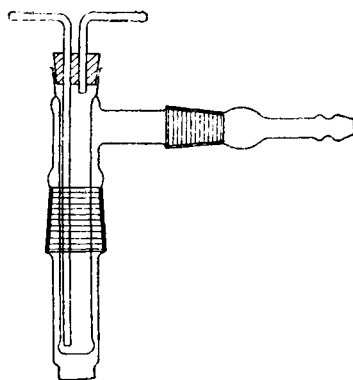

Fig. II, 45, 5.

and carries a disc slightly smaller in diameter than the outer tube; the pressure may be reduced by a water or oil pump. The impure material is placed in the wider tube, and the apparatus is exhausted. Upon heating gently (preferably by immersion in a bath of liquid), the pure substance collects on the cold surface and on the disc. The apparatus is available commercially in all-glass form, with a ground glass joint replacing the rubber stopper (Fig. II, 45, 5) *; this is intended for dealing with quantities of a few milligrams up to about 1 gram. It is recommended that the apparatus be heated in an oil bath: a direct flame may lead to decomposition, due to too high a temperature.

II,46. CHROMATOGRAPHIC ADSORPTION

Chromatography is based upon the selective adsorption from solution on the active surface of certain finely divided solids. Closely related substances exhibit different powers of adsorption, so that separations, which are extremely difficult by ordinary chemical methods, may be effected by this means. When, for example, a solution of leaf pigments

* Supplied by J. W. Towers and Co. Ltd.

in an organic solvent (*e.g.*, a mixture of light petroleum, b.p. 60–80°, and benzene), is passed slowly through a tube packed with a white adsorbent, such as alumina, the individual pigments tend to be retained in different coloured zones, the most strongly adsorbed components being retained at the top, and those with less affinity for the adsorbent at lower levels. The initial separation of the different coloured layers is usually not very distinct, but by passing a fresh portion of the original solvent or of another solvent through the tube, the zones become more sharply defined and may spread over the length of the whole column. The banded column of adsorbent is termed a **chromatogram**, and the operation is spoken of as the **development of the chromatogram**. The appearance of the chromatogram of spinach leaves is shown diagrammatically in Fig. II, 46, 1; the tube is packed with alumina (bottom), calcium carbonate and sugar. The resolution into chlorophyll-*b* (yellowish-green), chlorophyll-*a* (bluish-green), xanthophyll (yellow) and carotene (yellow) is clearly visible. Two procedures may be adopted in order to recover the constituents of the mixture. The column of adsorbent may be pushed out of the tube, the various zones cut with a knife at the boundaries, and the coloured components extracted with a suitable solvent: this recovery is called **elution**. Alternatively, the column may be washed with more solvent, now termed the **eluent** (the solvent is not necessarily identical with that used as the developer), and each component collected separately as it reaches the end of the column and is released.

Column chromatography was first developed by the American petroleum chemist D. T. Day in 1900. M. S. Tswett, the Polish botanist, in 1906 used adsorption columns in his investigations of plant pigments. It was not until about 1930 that the method was used extensively by chemists. The most startling results have been obtained in the fields of plant pigments and natural products, but chromatography has also many applications in ordinary laboratory practice. A substance need not be highly coloured to give a visible adsorption band; it must be remembered that the material retained in a zone of the column is in a concentrated form. Thus a pale yellow reaction product may be resolved by chromatography into a yellow component and a colourless one, and the latter may pass through into the filtrate. Frequently, a colour which cannot be removed by repeated recrystallisation nor by treatment with decolourising carbon in the usual way is thus readily separated by adsorption analysis. This method of purification is assisted by the general tendency of coloured substances to be adsorbed more strongly than related substances, which are less highly coloured or less unsaturated. Furthermore, certain colourless substances exhibit a bright fluorescence in ultraviolet light, and the passage of such a substance through a column of adsorbent material can be followed with the aid of

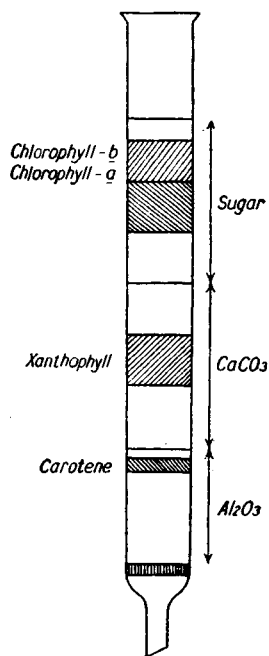

Fig. II, 46, 1.

a quartz mercury vapour lamp in a partially darkened room. Methods which have been developed for processing colourless and non-fluorescent compounds include :

1. The conversion of the compounds under investigation into coloured derivatives (*e.g.*, the separation of carbonyl compounds by conversion into their 2 : 4-dinitrophenylhydrazones, etc. ; of hydrocarbons through their picrates ; of alcohols through their 3 : 5-dinitrobenzoates ; of glucose, fructose and other simple sugars through their *p*-phenylazobenzoyl esters).

2. The use of an indicator or marking substance, which is adsorbed on the column in a position in known relation to that of the colourless substance (*e.g.*, Sudan III for isolation of Vitamin D upon alumina).

3. The brush method ; here the substances to be separated give a colour test with a reagent. The developed column is extruded from the tube and streaked lengthwise with a brush dipped in the test reagent ; the colours appearing on the surface of the column at the place touched by the reagent indicate the position of the zones : that part of the adsorbent containing the colour test can be readily shaved off so that it may be discarded.

The chief uses of chromatographic adsorption include : (i) resolution of mixtures into their components ; (ii) purification of substances (including technical products from their contaminants) ; (iii) determination of the homogeneity of chemical substances ; (iv) comparison of substances suspected of being identical ; (v) concentration of materials from dilute solutions (*e.g.*, from a natural source) ; (vi) quantitative separation of one or more constituents from a complex mixture ; and (vii) identification and control of technical products.

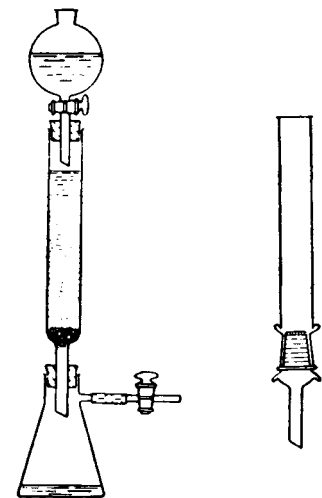

Fig. II, 46, 2. Fig. II, 46, 3.

For further details, the student is referred to specialised works on the subject.*

Apparatus. The essential part of the apparatus consists of a long narrow tube (20–30 cm. long and 1–3 cm. diameter) ; this holds 50–100 g. of adsorbent and may retain several grams of the adsorbate, although the amount is usually somewhat smaller. Fig. II, 46, 2 illustrates a simple form of apparatus ; the adsorbent is supported on a plug of cotton or glass wool ; for wide tubes a perforated disc, covered by a pad of cotton or glass wool, may be used. Fig. II, 46, 3 depicts a column fitted with a ground glass joint and a perforated glass plate or fritted glass disc is sealed into the lower part of the ground joint † ; the removal of the column

* See, for example, A. Weissberger (Editor), *Technique of Organic Chemistry*. Volume V. *Absorption and Chromatography*, Interscience (1951) ; H. H. Strain, *Chromatographic Adsorption Analysis*, Interscience (1945).

† Supplied by the Scientific Glass Apparatus Co. and, in larger sizes, by Quickfit and Quartz Ltd.

from the tube is a simple process. Fig. II, 46, 4 illustrates a simple assembly* with standard ground glass joints. On occasion substances have to be handled which are readily oxidised in air: a simple apparatus, which permits the replacement of air by an inert gas, is shown in Fig. II, 46, 5. The solution is run through the column with gentle suction (*ca.* 680 mm.), if necessary; a high vacuum results in the tight packing of the adsorbent and also in the evaporation of the solvent in the lower end of the column. Pressure filtration may also be employed; the upper end of the column is connected through a large bottle to a rubber bulb or other means of exerting a slight pressure.

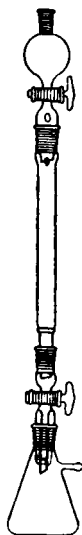

Fig. II, 46, 4.

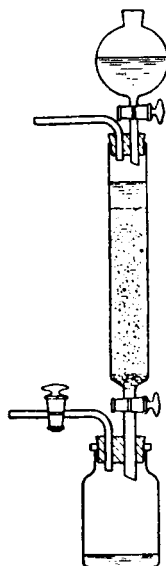

Fig. II, 46, 5.

Adsorbents. The most widely used adsorbent is activated aluminium oxide, and commercial products are available which combine high activity with regular grain size. Other adsorbents include magnesium oxide, magnesium carbonate, magnesium trisilicate, calcium carbonate, barium carbonate, calcium hydroxide, calcium sulphate, silica gel, glucose, lactose, inulin, starch, cellulose and Fuller's earth. They are all employed in the form of uniform white powders: the inorganic compounds may usually be improved by heating at 200–230°. Diatomaceous earth filter aids (sold under various trade names—Filter Cel, Super-Cel, Clara-Cel, etc.), although sometimes employed as adsorbents, find their main application for improving the solvent flow rate through columns of other adsorbents: for this purpose they are mixed with the finely-powdered adsorbent in a suitable ratio; uniform packing of the column is also facilitated by their use. Table II, 46, 1, due largely to Strain, gives a list of adsorbents in increasing order of adsorption.

* Supplied by Quickfit and Quartz Ltd.

TABLE II, 46.1. GRADED SERIES OF ADSORBENTS

- | | |
|-------------------------|-----------------------------------|
| 1. Sucrose, starch. | 8. Magnesia. |
| 2. Inulin. | 9. Lime. |
| 3. Talc. | 10. Activated silicic acid. |
| 4. Sodium carbonate. | 11. Activated magnesium silicate. |
| 5. Calcium carbonate. | 12. Activated alumina. |
| 6. Calcium phosphate. | 13. Fuller's earth. |
| 7. Magnesium carbonate. | |

Formation of an adsorption column. In order to obtain satisfactory results, the tube must be uniformly packed with the adsorbent. Uneven distribution leads to the formation of cracks and channels. If there is any doubt concerning the uniformity of the adsorbent powder, it should be sifted before use. The necessary support for the column (glass wool or cotton wool plug; perforated porcelain plate, or sintered glass plate, with filter paper circle, etc.) is placed in the tube, the latter is

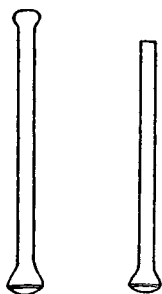

Fig. 11, 46, 6.

clamped or held vertically, and the adsorbent added portionwise. The first portion should be about twice the size of those that follow. For tubes up to one cm. diameter, the individual portions are pressed down with a flattened glass rod. For wider tubes, a cylindrical wooden pestle (walnut wood is recommended), slightly convex in the centre (Fig. II, 46, 6), is used; the area of the conical end should be two-thirds to three-quarters of that of the tube. The adsorbent is pressed down by a short vigorous tapping from a height of 3 to 6 cm. With certain adsorbents, a slight vacuum is created as the pestle is raised and a cloud of fine powder may be formed; this is avoided if a slight rotary movement is given to the pestle as it is raised, or by slightly turning the glass tube with the left hand each time the pestle is lifted. From one-fifth to one-third of the tube should be left empty. The amount of adsorbent is usually generous compared with the quantity of material to be adsorbed.

Another method of filling the column consists in placing the adsorbent and solvent in a separatory funnel, fitted with an efficient stirrer (e.g., Fig. II, 56, 31, a, a "link" type), and allowing the resulting slurry to flow through the tap into the clean, dry column. The adsorbent settles fairly rapidly under gravity, and the process may be assisted by gently tapping the tube. A packing, free from air bubbles, is thus obtained.

When the adsorbent has been introduced into the tube, the latter is fitted into a filter flask (see Fig. II, 46, 2) to which a pump is attached; the pump is run slowly and the column is again pressed down gently with the wooden pestle. The circumference of the upper surface is gently and uniformly tapped, especially where it is in contact with the glass surface, for about one minute; air bubbles and channels are thus avoided when the solution is poured in. Some workers place a loose plug of cotton wool or a circle of filter paper at the top of the column in order to protect the solid from disturbance when the liquid is introduced.

Another procedure, which is sometimes adopted, consists in adding a suspension of the adsorbent in petroleum ether (b.p. ca. 60–80°) in small

portions to the tube, fixed vertically and connected to the pump through a stopcock. After each addition, suction is applied, first gently and then somewhat more strongly; the surface of the column must at all times be covered with petroleum ether.

Selection of solvents. The choice of solvent will naturally depend in the first place upon the solubility relations of the substance. If this is already in solution, for example, as an extract, it is usually evaporated to dryness under reduced pressure and then dissolved in a suitable medium; the solution must be dilute since crystallisation in the column must be avoided. The solvents generally employed possess boiling points between 40° and 85° . The most widely used medium is light petroleum (b.p. not above 80°); others are *cyclohexane*, carbon disulphide, benzene, chloroform, carbon tetrachloride, methylene chloride, ethyl acetate, ethyl alcohol, acetone, ether and acetic acid.

It is important to appreciate clearly the function of solvents in chromatographic adsorption. Whereas in any one analysis only one adsorbent will normally be employed, several solvents may be used. Solvents have a triple role:—

(i) They serve to introduce the mixture to the column.

(ii) They effect the process of development by which the zones of the chromatogram are separated to their fullest extent. When used for this purpose, the solvents are termed **developers**.

(iii) They remove the required content of each zone from the mechanically separated parts of the column, or from the column as a whole, the passage of the zone through the column being followed by physical methods (colour, fluorescence in ultraviolet light, etc.). Solvents utilised for removing the various components of a mixture as separated on a column are called **eluent**s.

While the same solvent may serve throughout, it is often necessary to use different solvents at different stages of the chromatographic separation.

Reference has already been made to the choice of solvent for introducing the mixture to the column. Generally speaking, adsorption takes place most readily from non-polar solvents, such as petroleum ether or benzene, and least from highly polar solvents such as alcohols, esters and pyridine. Frequently the solvent for introducing the mixture to the column and the developer are so chosen that the same solvent serves the dual purpose.

The developer is generally a solvent in which the components of the mixture are not too soluble and is usually a solvent of low molecular weight. The adsorbent is selected so that the solvent is adsorbed somewhat but not too strongly; if the solvent is adsorbed to some extent, it helps to ensure that the components of the mixture to be adsorbed will not be too firmly bound. Usually an adsorbate adheres to any one adsorbent more firmly in a less polar solvent, consequently when, as frequently occurs, a single dense adsorption zone is obtained with light petroleum and develops only slowly when washed with this solvent, the development may be accelerated by passing to a more polar solvent. Numerous adsorbates are broken up by methyl alcohol, ethyl alcohol or acetone. It is not generally necessary to employ the pure alcohol; the addition from 0.5 to 2 per cent. to the solvent actually used suffices in most cases.

The choice of an eluent is governed by a few simple and obvious rules. It should be a liquid which is a good solvent for the components to be eluted. The eluent may be well adsorbed itself, so that its solvent action is assisted by its displacing action at the interface; or one may add to the eluent some strongly adsorbed substance to promote this displacement. The eluent should be easily removable from the desorbed component; low-boiling eluents may be used to elute high-boiling substances; basic or acidic solvents may be employed to elute stable neutral compounds, or neutral solvents to elute acidic or basic substances. The following Table of a graded series of eluents may be found useful.

TABLE II, 46.2.

GRADED SERIES OF ELUENTS

1. Petroleum ether, b.p. 30–50°.	8. Chloroform.
2. Petroleum ether, b.p. 50–70°.	9. Ethyl acetate.
3. Carbon tetrachloride.	10. Ethanol.
4. <i>Cyclohexane</i> .	11. Methanol.
5. Benzene.	12. Ethyl acetate.
6. Ether (absolute).	13. Pyridine.
7. Acetone (anhydrous).	14. Glacial acetic acid.

The value of a graded series of eluents is that if one member of the series succeeds in desorbing a portion of an adsorbate, then another more powerful eluent should remove a further portion of the adsorbate. By mixing the eluents in various proportions, a finer gradation may be obtained, *e.g.*, petroleum ether; benzene and petroleum ether; benzene and ether; ether and acetone, etc.

Introducing the solution. The top of the column is covered with a circle of filter paper or a loose plug of cotton wool and is washed with some of the solvent; the rate of flow is observed under slight suction (Fig. II, 46, 2) or under slight pressure. The solvent should percolate at the rate of 4–10 cm. per minute in a 2 cm. tube, and about 20–40 cm. per minute in a 5 cm. tube. The solution is added through a funnel or, better, through a tap funnel. The upper surface of the column must remain covered with liquid from the introduction of the first liquid to the end of the development; if this precaution is not observed, the column may, in some circumstances, dry so quickly as to shrink and this may sometimes lead to the oxidation of the adsorbate. When suction is applied (Fig. II, 46, 2), the stopcock of the filter flask should be closed after a suitable pressure has been established in order to avoid evaporation and to maintain a steady suction. As the last portion of the solution enters the column, the tap funnel is filled with the developing solution. After filtration is complete, the contents are dried in air or oxygen. The adsorbent may be pushed out completely with the wooden pestle or plunger (Fig. II, 44, 6) and the zones cut with a knife or scalpel, or the coloured zones may be separated as they leave the tube. The individual homogeneous portions of the column are broken up, immediately dropped into the eluent, and stirred; the suspension is filtered on a sintered glass funnel, and the filter cake is washed. Control of homogeneity is best carried out by repeating the chromatographic adsorption.

In another procedure, the column of adsorbent is not removed from the glass tube. The developed chromatogram is treated either with a

single eluent or with a succession of solvents having increasingly powerful eluent actions. The various portions of the adsorbate are thus driven through the column, and the separate fractions of the filtrate are collected in different receivers. The series of filtrates constitutes the liquid chromatogram. The process is frequently applied to complex mixtures: the filtrates thus obtained can sometimes be passed again through a column.

II,47. PURIFICATION OF THE COMMON ORGANIC SOLVENTS

Reasonably pure solvents are required for many organic reactions and for recrystallisations; methods for obtaining these from commercial products will accordingly be described. Frequently, the pure solvent (*e.g.*, the analytical reagent) can be purchased, but the cost is usually high, particularly if comparatively large volumes are required. Furthermore, it is excellent practice for the student to purify inexpensive commercial solvents.

1. **Absolute diethyl ether.** The chief impurities in commercial ether (sp. gr. 0.720) are water, ethyl alcohol, and, in samples which have been exposed to the air and light for some time, "ethyl peroxide." The presence of peroxides may be detected either by the liberation of iodine (brown colouration or blue colouration with starch solution) when a small sample is shaken with an equal volume of 2 per cent. potassium iodide solution and a few drops of dilute hydrochloric acid, or by carrying out the "perchromic acid" test of inorganic analysis with potassium dichromate solution acidified with dilute sulphuric acid. The peroxides may be removed by shaking with a concentrated solution of a ferrous salt, say, 5-10 g. of ferrous salt (\equiv 10-20 ml. of the prepared concentrated solution) to 1 litre of ether. The concentrated solution of ferrous salt is prepared either from 60 g. of crystallised ferrous sulphate, 6 ml. of concentrated sulphuric acid and 110 ml. of water or from 100 g. of crystallised ferrous chloride, 42 ml. of concentrated hydrochloric acid and 85 ml. of water.* Peroxides may also be removed by shaking with an aqueous solution of sodium sulphite (for the removal with stannous chloride, see Section VI,12).

In practice, it is best to purify a quantity, say one Winchester quart bottle, of technical 0.720 ether to cover the requirements of a group of students. The "Winchester quart" of ether is divided into two approximately equal volumes, and each is shaken vigorously in a large separatory funnel with 10-20 ml. of the above ferrous solution diluted with 100 ml. of water. The latter is removed, the ether transferred to the Winchester bottle, and 150-200 g. of anhydrous calcium chloride is added. The mixture is allowed to stand for at least 24 hours with occasional shaking. Both the water and the alcohol present are thus largely removed. The ether is then filtered through a large fluted filter paper into another clean dry Winchester bottle (*CAUTION*: all flames in the vicinity must be

* Traces of aldehyde are produced. If ether of a high degree of purity is required, it should be further shaken with 0.5 per cent. potassium permanganate solution (to convert the aldehyde into acid), then with 3 per cent. sodium hydroxide solution, and finally with water.

extinguished). Fine sodium wire (about 7 g.) is then introduced directly into the ether with the aid of a **sodium press** (Fig. II, 47, 1).* The latter consists of a rigid metal framework, which can be attached to the bench by means of a single bolt (as in the Figure). An adjustable bottle stand is provided so that bottles up to a capacity of one Winchester quart can be used and their necks brought up to the underside of the mould. The plunger is of stainless steel as is also the one piece mould and die. (A number of dies of various sizes, thus giving sodium wire of different diameters, are usually available for alternative use.) The die is nearly filled with lumps of sodium, then placed in position in the press, and the plunger slowly screwed down. As soon as the sodium wire emerges from the die, the Winchester bottle containing the ether is held immediately beneath the die, and the plunger is gradually lowered until all the sodium has been

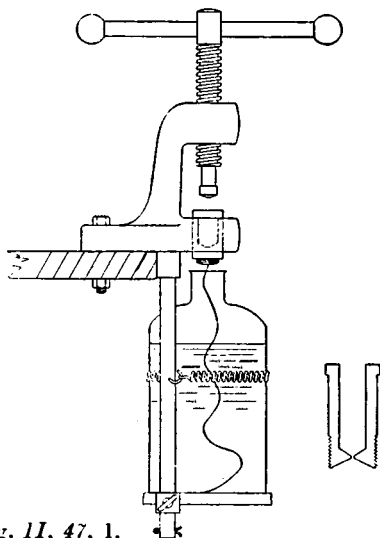

Fig. II, 47, 1.

forced as a fine wire into the ether. The Winchester bottle is then closed by a rubber stopper carrying a drying tube filled loosely with cotton wool or with calcium chloride (to exclude moisture and permit the escape of hydrogen), and the ether is allowed to stand for about 24 hours. The steel die must be removed from the press after use, any residual sodium destroyed with methylated spirit, and then thoroughly dried, preferably in the steam oven; the plunger should also be swabbed with a rag or filter paper soaked in methylated spirit. If, on the following day, no bubbles of hydrogen rise from the sodium in the ether and the latter still possesses a bright surface, the Winchester bottle is closed by its own ground glass stopper or by a rubber stopper, and preserved in the dark (to check the formation of peroxides as far as possible) in a cool place remote from flames. If, however, the surface of the sodium wire is badly attacked, due to insufficient drying with the calcium chloride, the ether must be filtered through a fluted filter paper into another clean, dry Winchester bottle and the treatment with sodium repeated. The absolute diethyl ether

* Supplied by Griffin and George Ltd., Ealing Road, Alperton, Wembley, Middlesex.

thus prepared is suitable for use in the Grignard reaction. If a fresh supply of high-grade ether, *e.g.*, ether for anaesthesia, sp. gr. 0.720, or of analytical reagent quality, is available, the treatment with ferrous salt solution may be omitted.

When ether is allowed to stand for some time in contact with air and exposed to light, slight oxidation occurs with the formation of the highly explosive diethyl peroxide, $(C_2H_5)_2O_2$. The danger from this unstable compound becomes apparent at the conclusion of the distillation of impure ether, when the comparatively non-volatile peroxide becomes concentrated in the distillation flask; a serious explosion may result if an attempt be made to evaporate the ether to dryness. In the extraction of an organic compound with ether and the subsequent removal of the solvent, the presence of the residual compound seems largely to eliminate the danger due to traces of peroxides. Nevertheless, ether, which has been standing for several months in a partially filled bottle exposed to light and air, should be tested for peroxides and, if present, should be eliminated by treatment with an acid solution of a ferrous salt or with a solution of sodium sulphite, as described in the previous paragraph. Peroxide formation takes place with all ethers, but particularly with *di-iso-propyl ether*.

Attention is directed to the fact that ether is highly inflammable and also extremely volatile (b.p. 35°), and great care should be taken that there is no naked flame in the vicinity of the liquid (see Section II, 14). Under no circumstances should ether be distilled over a bare flame, but always from a steam bath or an electrically-heated water bath (Fig. II, 5, 1), and with a highly efficient double surface condenser. In the author's laboratory a special lead-covered bench is set aside for distillations with ether and other inflammable solvents. The author's "*ether still*" consists of an electrically-heated water bath (Fig. II, 5, 1), fitted with the usual concentric copper rings; two 10-inch double surface condensers (Davies type) are suitably supported on stands with heavy iron bases, and a bent adaptor is fitted to the second condenser furthest from the water bath. The flask containing the ethereal solution is supported on the water bath, a short fractionating column or a simple bent still head is fitted into the neck of the flask, and the still head is connected to the condensers by a cork; the recovered ether is collected in a vessel of appropriate size.

2. **Di-iso-propyl ether.** The commercial product usually contains appreciable quantities of peroxides; these should be removed by treatment with an acidified solution of a ferrous salt or with a solution of sodium sulphite (see under *Diethyl ether*). The ether is then dried with anhydrous calcium chloride and distilled. Pure *di-iso-propyl ether* has b.p. $68.5^\circ/760$ mm.

3. **Di-*n*-butyl ether.** Technical *n*-butyl ether does not usually contain appreciable quantities of peroxides, unless it has been stored for a prolonged period. It should, however, be tested for peroxides, and, if the test is positive, the ether should be shaken with an acidified solution of a ferrous salt or with a solution of sodium sulphite (see under *Diethyl ether*). The ether is dried with anhydrous calcium chloride, and distilled through a fractionating column: the portion, b.p. $140-141^\circ$, is collected. If a fraction of low boiling point is obtained, the presence of *n*-butyl

alcohol is indicated and may be removed by shaking twice with an equal volume of concentrated hydrochloric acid (see, however, Section III,57), followed by washing with water and drying. Pure di-*n*-butyl ether has b.p. 141°/765 mm.

4. Absolute ethyl alcohol. Ethyl alcohol of a high degree of purity is frequently required in preparative organic chemistry. For some purposes alcohol of *ca.* 99·5 per cent. purity is satisfactory; this grade may be purchased (the "absolute alcohol" of commerce), or it may be conveniently prepared by the dehydration of rectified spirit with quicklime. Rectified spirit is the constant boiling point mixture which ethyl alcohol forms with water, and usually contains 95·6 per cent. of alcohol by weight. Wherever the term rectified spirit is used in this book, approximately 95 per cent. ethyl alcohol is to be understood.

Dehydration of rectified spirit by quicklime. It is convenient to work with one Winchester quart bottle of rectified spirit (2·2·25 litres); considerable time is saved and sufficient of the product is obtained for the requirements of a large group of students. The quicklime should be freshly prepared by strongly heating lumps of clean marble in a muffle furnace (preferably electrically-heated) for 3-6 hours; the product must be stored, directly it cools, in a well-stoppered bottle, although, wherever possible, it should be used immediately after its preparation. If commercial quicklime is employed, it should be similarly heated in a muffle furnace for 1-2 hours immediately before use. The contents of one Winchester bottle of rectified spirit (2·2·25 litres) are poured into a 3-4 litre round-bottomed Pyrex flask, about 500 g. of freshly-burnt quicklime are introduced, and the flask fitted with a double surface condenser carrying a drying tube (this may be filled with cotton wool or with anhydrous calcium chloride between plugs of glass wool placed at either end of the tube) on top (see Fig. II, 13, 7). The mixture is gently refluxed on a water bath for 6 hours, and allowed to stand overnight. In the meantime, purified glass wool is prepared by boiling a little glass wool with concentrated nitric acid for 30 minutes, washing thoroughly with distilled water in order to remove adhering acid, and drying in the steam oven. The purified glass wool is packed tightly into a wide glass tube, bent as shown in Fig. II, 47, 2, and the complete apparatus is assembled. The glass wool will completely retain any finely-divided lime which tends to pass over with the alcohol; alternatively, a splash head—as for ammonia distillation—may be used. The receiver consists of a clean, dry Winchester bottle in which the "absolute" alcohol will subsequently be stored. The special adapter shown is easily prepared by sealing a short length of glass tubing to the ordinary form of adapter and attaching a drying tube containing cotton wool or anhydrous calcium chloride. Rubber stoppers should be used throughout. The flask is heated on a water or steam bath, and the first 10-15 ml. of distillate are discarded. When most of the alcohol has passed over, the rate of distillation will slacken appreciably even on a boiling water bath; a cloth or towel should then be wrapped round the flask, when the rate of distillation will increase. The alcohol obtained in this way is very hygroscopic, and the bottle should be closed by a well-fitting, ground glass stopper or by a tightly-fitting rubber stopper. A bark cork is not recommended as this may

contain an appreciable quantity of water unless it has been previously dried at about 120°. The product is generally termed "absolute" ethyl alcohol, although it usually still contains about 0.5 per cent. of water. The exact water content may be computed from a density determination or by the critical solution temperature procedure described in Section I,9.

5. **Extremely dry (or "super-dry") ethyl alcohol.** The yields in several organic preparations (*e.g.*, malonic ester syntheses, reduction with sodium and ethyl alcohol, veronal synthesis) are considerably improved by the use of alcohol of 99.8 per cent. purity or higher. This very high grade ethyl alcohol may be prepared in several ways from commercial "absolute" alcohol or from the product of dehydration of rectified spirit with quicklime (see under 4).

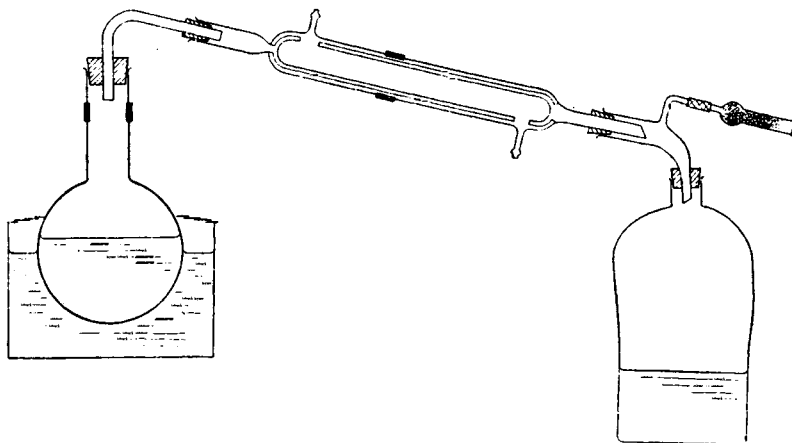
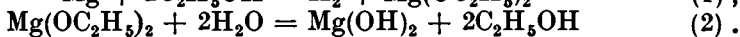
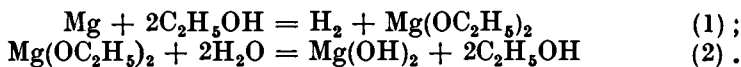

Fig. II, 47, 2.

Method 1 (Lund and Bjerrum, 1931). The procedure depends upon the reactions :



Reaction (1) usually proceeds readily provided the magnesium is activated with iodine and the water content does not exceed one per cent. Subsequent interaction between the magnesium ethoxide and water gives the highly insoluble magnesium hydroxide; only a slight excess of magnesium is therefore necessary.

A dry 1.5 or 2 litre round-bottomed Pyrex flask is fitted with a double surface condenser and a drying tube (the latter may contain either cotton wool or anhydrous calcium chloride between plugs of glass wool). Five grams of clean dry magnesium turnings and 0.5 g. of iodine are placed in the flask, followed by 50-75 ml. of the 99+ per cent. alcohol. The mixture is warmed until the iodine has disappeared: if a lively evolution of hydrogen does not set in, a further 0.5 g. of iodine is added. Heating is continued until all the magnesium is converted into the ethylate. Nine hundred ml. of the "absolute" alcohol are then added, and the mixture is refluxed for 30 minutes. The alcohol is distilled off directly

into the vessel in which it is to be stored, using an apparatus similar to that of Fig. II, 47, 2. The purity of the alcohol exceeds 99·95 per cent., provided adequate precautions are taken to protect the distillate from atmospheric moisture. The super-dry alcohol is exceedingly hygroscopic.

If the alcohol is required for conductivity or other physico-chemical work and traces of bases are objectionable, these may be removed by redistillation from a little 2 : 4 : 6-trinitrobenzoic acid. This acid is selected because it is not esterified by alcohols, consequently no water is introduced into the alcohol.

Method 2 (E. L. Smith, 1927). Sodium alone cannot be used for the complete removal of water in ethyl alcohol owing to the equilibrium between the resulting sodium hydroxide and ethyl alcohol :



If, however, the sodium hydroxide is removed by allowing it to react with excess of an ester of high boiling point, such as ethyl succinate or ethyl phthalate, super-dry ethyl alcohol may be obtained :

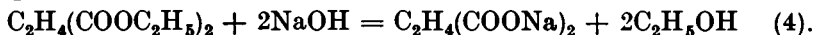

The ethyl alcohol is easily removed from the excess of ester by distillation through a short column.

The apparatus consists of a 1·5 or 2 litre round-bottomed Pyrex flask fitted with an Allihn condenser (Fig. II, 1, 4, d). The upper end of the latter carries a short still head to which is attached a Liebig condenser set for downward distillation ; the last-named is connected to a modified adapter and receiver as in Fig. II, 47, 2. The apparatus must be perfectly dry ; rubber stoppers are used throughout. One litre of "absolute" alcohol of approximately 99·5 per cent. strength, together with 7 g. of clean dry sodium, are placed in the flask. When the sodium has reacted, 25 g. of pure ethyl succinate or 27·5 g. of pure ethyl phthalate are introduced, and the mixture gently refluxed for 2 hours whilst a rapid stream of water is passed through the Allihn condenser. The water in the reflux condenser is then allowed to run out, and the mixture is distilled from a water or steam bath ; the first 25 ml. of alcohol are rejected. The water content of the resulting ethyl alcohol should not exceed 0·05 per cent. and, if moisture has been rigidly excluded, may be as low as 0·01 per cent. The super-dry alcohol must be kept in a tightly stoppered bottle owing to its extremely hygroscopic character.

If preferred, the following alternative procedure may be adopted. The "absolute" alcohol is placed in a 1·5 or 2 litre three-necked flask equipped with a double surface reflux condenser and a mercury-sealed mechanical stirrer ; the third neck is closed with a dry stopper. The sodium is introduced and, when it has reacted completely, the ester is added and the mixture is gently refluxed for 2 hours. The reflux condenser is then rapidly disconnected and arranged for downward distillation with the aid of a short still head or "knee tube." The other experimental details are as above except that the mixture is stirred during the distillation ; bumping is thus reduced to a minimum.

Method 3 (F. Adickes, 1930). The experimental procedure is similar to that described in *Method 2* except that excess of ethyl formate (b.p.

54°/760 mm.) is employed to remove all the sodium hydroxide in the equilibrium of equation (3) :



The sodium formate is sparingly soluble in ethyl alcohol and therefore separates out. The residual ethyl formate is catalytically decomposed in the presence of sodium ethoxide at the boiling point of the ethyl alcohol, *i.e.*, by refluxing the mixture :



One litre of commercial "absolute" alcohol (or any ethyl alcohol of 99 per cent. purity or better) is treated with 14 g. of clean, dry sodium ; when the sodium has completely reacted, 40 g. of pure ethyl formate are added. The mixture is refluxed for 2-3 hours, and the dry alcohol is distilled off as in *Method 2* : the first 25 ml. of distillate are discarded. The super-dry alcohol contains about 0.03 per cent. of water.

6. Absolute methyl alcohol. The synthetic methanol now available is suitable for most purposes without purification : indeed, some manufacturers claim a purity of 99.85 per cent. with not more than 0.1 per cent. by weight of water and not more than 0.02 per cent. by weight of acetone. Frequently, however, the acetone content may be as high as 0.1 per cent. and the water content 0.5-1 per cent.

Water may be removed, if necessary, by treatment with quicklime as detailed under *Ethyl alcohol* (4), but the method is wasteful and is not generally employed unless the water content is comparatively high, say above 3-4 per cent. An excellent method of particular value in recovering the alcohol, consists in fractionating through a highly efficient column (compare Sections II,15 and II,17) ; no constant boiling point mixture is formed as with ethyl alcohol. The boiling point of the pure methyl alcohol is 65°/760 mm. Methyl alcohol is highly inflammable and adequate precautions against fire must be taken (compare Section II,14).

Genuine absolute methyl alcohol may be readily prepared from the 99+ per cent. product (the usual commercial "absolute" methanol) by treatment with magnesium activated by iodine ; the dehydration is due essentially to the magnesium methylete formed (compare *Method 1* in 5). Five grams of clean, dry magnesium turnings and 0.5 g. of resublimed iodine are placed in a 2-litre round-bottomed Pyrex flask and the latter fitted with a double surface reflux condenser : 50-75 ml. of the methyl alcohol are added through the condenser and the mixture is warmed (preferably on a water bath) until the iodine disappears. Hydrogen is usually soon vigorously evolved and it may be necessary to remove the flame from beneath the flask (or to remove the flask from the water bath). If a vigorous evolution of hydrogen does not take place, a further 0.5 g. of iodine is added and the mixture is heated until all the magnesium has been converted into the methoxide. Nine hundred ml. of the methyl alcohol are then added, and the mixture boiled for 30 minutes under reflux. The product is then distilled with exclusion of moisture, using the apparatus of Fig. II, 47, 2 ; the first 25 ml. of distillate are discarded.

If the small proportion of acetone present in synthetic methyl alcohol is objectionable, it may be removed when present in quantities up to

one per cent. by the following procedure (Morton and Mark, 1934). A mixture of 500 ml. of the alcohol, 25 ml. of furfural, and 60 ml. of 10 per cent. sodium hydroxide solution is refluxed in a 2-litre round-bottomed flask, fitted with a double surface condenser, for 6–12 hours. A resin is formed, which carries down all the acetone present. The alcohol is then carefully fractionated through an efficient column (e.g., a modified Hempel column or a Widmer column, Section II, 17); the first 5 ml. contain a trace of formaldehyde and are rejected. The recovery of methyl alcohol is about 95 per cent.

7. *n*-Propyl alcohol. The purest commercial *n*-propyl alcohol is dried with anhydrous potassium carbonate or with anhydrous calcium sulphate, and distilled through an efficient fractionating column. The fraction, b.p. 96·5–97·5°/760 mm., is collected. If the alcohol is required perfectly dry, it may be treated with magnesium activated with iodine (see under 5, *Method 1*); alternatively, the ester method with *n*-propyl succinate or *n*-propyl phthalate may be used (see under 5, *Method 2*).

8. *iso*Propyl alcohol. Two technical grades are usually marketed with *isopropyl* alcohol contents of 91 per cent. and 99 per cent. respectively. The former has a b.p. of about 80·3° and is a constant boiling point mixture with water; it* may be refluxed with excess of freshly-burnt quicklime, distilled from the lime, and then refractionated. The latter* is dried with anhydrous calcium and distilled through a column. The fraction, b.p. 82–83°/760 mm., is collected.

9. Higher alcohols. These may be purified by drying with anhydrous potassium carbonate or with anhydrous calcium sulphate, and fractionated after filtration from the desiccant. Bark corks (or ground glass joints) should be used; rubber stoppers are slightly attacked. The boiling points of the fractions to be collected are as follows:—

n-Butyl alcohol, b.p. 116·5–118°/760 mm.

iso-Butyl alcohol, b.p. 106·5–107·5°/760 mm.

sec.-Butyl alcohol, b.p. 99–100°/760 mm.

tert.-Butyl alcohol, b.p. 81·5–82·5°/760 mm., m.p. 25·5°.

n-Amyl alcohol, b.p. 136–137·5°/760 mm.

iso-Amyl alcohol (of fermentation origin), “primary *iso*amyl alcohol,” b.p. 131–132°/760 mm.

iso-Amyl alcohol (synthetic), “primary *iso*amyl alcohol,” b.p. 130–131°/760 mm.

n-Hexyl alcohol, b.p. 156·5–157·5°/760 mm.

If the perfectly anhydrous alcohols are required, the redistilled alcohol may be treated with the appropriate alkyl phthalate or succinate as already detailed under *Ethyl alcohol* (5).

10. Mono-alkyl ethers of ethylene glycol, ROCH₂CH₂OH. The mono-methyl, ethyl and *n*-butyl ethers are inexpensive and are known as *methyl cellosolve*, *ethyl cellosolve*, and *butyl cellosolve* respectively. They are completely miscible with water, and are excellent solvents. The commercial products are purified by drying over anhydrous potassium carbonate or anhydrous calcium sulphate, followed by fractionation after

* It is recommended that the *isopropanol* be tested for peroxides and, if present, removed by refluxing with solid stannous chloride (for details, see concluding paragraph of Section VI,12).

the removal of the desiccant. The boiling points of the pure products are :—

ethylene glycol monomethyl ether (or β -methoxyethyl alcohol),
b.p. $124.5^{\circ}/760$ mm.

ethylene glycol monoethyl ether (or β -ethoxyethyl alcohol), b.p.
 $135^{\circ}/760$ mm.

ethylene glycol mono-*n*-butyl ether (or β -*n*-butoxyethyl alcohol),
b.p. $171^{\circ}/760$ mm.

11. Mono-alkyl ethers of diethylene glycol,

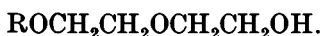

The mono-methyl, ethyl and *n*-butyl ethers are inexpensive commercial products and are known as *methyl carbitol*, *carbitol* and *butyl carbitol* respectively. They are all completely miscible with water and are purified as already described for the "cellosolves" (10). The boiling points of the pure compounds are :—

diethylene glycol monoethyl ether, b.p. $194^{\circ}/760$ mm.

diethylene glycol monoethyl ether, b.p. $198.5^{\circ}/760$ mm.

diethylene glycol mono-*n*-butyl ether, b.p. $230.5^{\circ}/760$ mm.

Note.

The solvents, enumerated under 10 and 11, may contain traces of "peroxides." These can be removed either by refluxing over anhydrous stannous chloride (see concluding paragraph of Section VI, 12) or by filtration under slight pressure through a column of activated alumina.

12. Di-alkyl ethers of ethylene glycol, $\text{ROCH}_2\text{CH}_2\text{OR}$. The dimethyl ether, b.p. $85^{\circ}/760$ mm., is miscible with water, is a good solvent for organic compounds, and is an excellent inert reaction medium. The diethyl ether (*diethyl cellosolve*), b.p. $121.5^{\circ}/760$ mm., is partially miscible with water (21 per cent. at 20°).

The diethyl ether of diethylene glycol* (*diethyl carbitol*), b.p. $186^{\circ}/760$ mm., is completely miscible with water. The above three ethers may be purified by distillation from sodium.

13. Acetone. The analytical reagent grade contains about 1 per cent. of water and meets most requirements. Synthetic acetone of a high degree of purity (water content about 1 per cent.) is also available as a technical product.

Commercial acetone may be purified in several ways :—

(a) The acetone is refluxed with successive small quantities of potassium permanganate until the violet colour persists. It is then dried with anhydrous potassium carbonate or anhydrous calcium sulphate,† filtered from the desiccant, and fractionated: precautions are taken to exclude moisture.

(b) To 700 ml. of acetone, b.p. $56-57^{\circ}$, contained in a litre bottle, a solution of 3 g. of silver nitrate in 20 ml. of water is added, followed by 20 ml. of *N*-sodium hydroxide solution, and the mixture is shaken for

* Much useful information on these and other solvents will be found in the booklet *Synthetic Organic Chemicals* issued by the Carbide and Carbon Chemicals Corporation.

† Anhydrous calcium chloride should not be used as some chemical combination occurs.

about 10 minutes. The mixture is then filtered, dried with anhydrous calcium sulphate, and distilled.

(c) When only a relatively small quantity of pure dry acetone is required, it may be purified through the bisulphite compound: the latter is decomposed with sodium carbonate solution (for details, see under *Methyl ethyl ketone*, 14), dried over anhydrous calcium sulphate, and distilled.

A more convenient procedure is to make use of the addition compound with sodium iodide ($\text{NaI} \cdot 3\text{C}_2\text{H}_5\text{O}$), which decomposes on gentle heating and is particularly well adapted for the preparation of pure acetone. One hundred grams of finely powdered sodium iodide are dissolved under reflux in 440 g. of boiling commercial acetone, and the solution is cooled in a mixture of ice and salt (-8°). The crystals are filtered off, and quickly transferred to a dry distilling flask, connected to an efficient condenser and to a receiver cooled in ice. Upon gentle warming, the acetone distils rapidly. Pure acetone has b.p. $56 \cdot 2^\circ/760$ mm., and is highly inflammable.

14. Methyl ethyl ketone. This excellent solvent has properties similar to those of acetone but it has a somewhat higher boiling point and is therefore less inflammable. A preliminary purification is effected by drying the commercial product with anhydrous potassium carbonate or anhydrous calcium sulphate, filtering from the desiccant, and fractionating through an efficient column; the fraction, b.p. $79-80^\circ$, is collected separately, and is quite satisfactory for recrystallisations. This may be further purified either through the bisulphite addition compound or through the sodium iodide addition compound. The methyl ethyl ketone b.p. $79-80^\circ$, is shaken with excess of saturated sodium bisulphite solution until reaction ceases, cooled to 0° , the bisulphite compound filtered off, washed with a little ether, and then dried in the air. The dry bisulphite compound is decomposed with a slight excess of sodium carbonate solution, and distilled in steam. The ketone is salted out from the distillate with potassium carbonate, separated, dried with anhydrous potassium carbonate (this will also remove traces of sulphur dioxide and carbon dioxide present), and, after filtration, allowed to stand for several hours over anhydrous calcium sulphate. It is then distilled. In the sodium iodide method, the ketone is saturated with sodium iodide by boiling under reflux, the solution is filtered through a hot water funnel, cooled in a freezing mixture, the white crystals (which have a m.p. of $73-74^\circ$) filtered off, and fractionally distilled through a column. Pure methyl ethyl ketone has b.p. $79 \cdot 5^\circ/760$ mm.

15. Benzene. The analytical reagent grade benzene is satisfactory for most purposes; if required dry, it is first treated with anhydrous calcium chloride, filtered, and then placed over sodium wire (for experimental details, see under *Diethyl ether*, 1).

Commercial benzene may contain thiophene $\text{C}_4\text{H}_4\text{S}$, b.p. 84° , which cannot be separated by distillation or by fractional crystallisation. The presence of thiophene may be detected by shaking 3 ml. of benzene with a solution of 10 mg. of isatin in 10 ml. of concentrated sulphuric acid and allowing the mixture to stand for a short time: a bluish-green colouration is produced if thiophene is present. The thiophene may be removed from benzene by any of the following methods:—

1. *By shaking with concentrated sulphuric acid*, advantage being taken of the fact that thiophene is more readily sulphonated than benzene. The technical benzene is shaken repeatedly with about 15 per cent. of its volume of concentrated sulphuric acid in a stoppered separatory funnel* until the acid layer is colourless or very pale yellow on standing, or until the thiophene test is negative. After each shaking lasting a few minutes, the mixture is allowed to settle and the lower layer of acid is drawn off. The benzene is then shaken twice with water in order to remove most of the acid, once with 10 per cent. sodium carbonate solution, again with water, and finally dried with anhydrous calcium chloride. After filtration, the benzene is distilled through an efficient column and the fraction, b.p. 80–81°, collected. If required perfectly dry, sodium wire must be introduced into the distilled liquid (for details, see under *Diethyl ether*, 1).

2. *By treatment with mercuric acetate*; only the thiophene reacts to form thiophene dimercuri-hydroxyacetate $\text{HOHg}\cdot\text{C}_4\text{H}_2\text{S}\cdot\text{HgOOC}\cdot\text{CH}_3$, which is filtered off. One kilogram of benzene is boiled under an efficient double surface reflux condenser for several hours with a solution of mercuric acetate, prepared by dissolving 40 g. of mercuric oxide (best, freshly precipitated) in a mixture of 40 ml. of glacial acetic acid and 300 ml. of water. If the mixture is stirred mechanically, the time of boiling can be reduced to 30 minutes. The precipitate of thiophene dimercuri-hydroxyacetate is removed by filtration, the water separated, the benzene washed twice with water, dried over anhydrous calcium chloride, and fractionated as in method 1.

Upon distilling the mercury compound with concentrated hydrochloric acid, it is readily decomposed into mercuric chloride and pure thiophene.

3. *By treatment with anhydrous aluminium chloride* (Holmes and Beeman, 1934). Ordinary commercial, water-white benzene contains about 0.05 per cent. of thiophene. It is first dried with anhydrous calcium chloride. One litre of the dry crude benzene is shaken vigorously (preferably in a mechanical shaking machine) with 12 g. of anhydrous aluminium chloride for half an hour; the temperature should preferably be 25–35°. The benzene is then decanted from the red liquid formed, washed with 10 per cent. sodium hydroxide solution (to remove soluble sulphur compounds), then with water, and finally dried over anhydrous calcium chloride. It is then distilled and the fraction, b.p. 79.5–80.5°, is collected. The latter is again vigorously shaken with 24 g. of anhydrous aluminium chloride for 30 minutes, decanted from the red liquid, washed with 10 per cent. sodium hydroxide solution, water, dried, and distilled. The resulting benzene is free from thiophene.

Pure benzene has b.p. 80°/760 mm. and m.p. 5.5°.

16. *Toluene*. Toluene, free from sulphur compounds, may be purchased. If required dry, it is treated with anhydrous calcium chloride, followed by sodium wire (see under *Benzene*, 15).

Commercial toluene contains methyl thiophenes (thiotolenes), b.p. 112–113°, which cannot be removed by distillation. It may be purified by

* Alternatively, the mixture may be stirred mechanically for 20–30 minutes. After three such treatments, the acid usually has only a pale colour.

shaking or stirring several times with about 10 per cent. of its volume of concentrated sulphuric acid as in the case of benzene (15), but, owing to the greater ease of sulphonation of toluene itself, some temperature control is necessary. The simplest procedure consists in mechanically stirring one litre of technical toluene with 100 ml. of concentrated sulphuric acid for about 30 minutes; the temperature is not allowed to rise above 30° by occasional cooling. The lower acid layer is removed, and the process is repeated twice. The subsequent working up is carried out as described under *Benzene*.

Pure toluene has b.p. 110·5°/760 mm.

17. Petroleum ether (light petroleum).* The fractions of refined petroleum which are commonly used have b.p. 40–60°, 60–80°, 80–100° and 100–120°. It is not advisable to employ a fraction with a wider b.p. range than 20°, because of possible loss of the more volatile portion during its use in recrystallisation, etc. and consequent different solubility relations of the higher boiling residue. For some purposes the presence of unsaturated (chiefly aromatic) hydrocarbons in petroleum ether is undesirable. Most of the unsaturated hydrocarbons may be removed by shaking two or three times with 10 per cent. of the volume of concentrated sulphuric acid (for details, see under *Benzene*, 15); vigorous shaking is then continued with successive portions of a concentrated solution of potassium permanganate in 10 per cent. sulphuric acid until the colour of the permanganate remains unchanged. The solvent is then thoroughly washed with water, dried over anhydrous calcium chloride, and distilled. If required perfectly dry, it should be allowed to stand over sodium wire.

Petroleum ether fractions "free from aromatic hydrocarbons" are marketed, as are also "*n*-hexane" and "*n*-heptane" from petroleum.

18. Methyl acetate. An anhydrous product of 99 per cent. purity (b.p. 56·5–57°) is available commercially; this is comparatively cheap so that purification of inferior products is not worth while. It is appreciably soluble in water (*ca.* 24 per cent. at 20°). The pure compound has b.p. 57°/760 mm.

If it is desired to purify an inferior product, 1 litre of it is refluxed for 6 hours with 85 ml. of acetic anhydride and then distilled through a fractionating column: the liquid passing over at 56–57° is collected. The distillate is shaken with 20 g. of anhydrous potassium carbonate for 10 minutes, filtered and redistilled. The resulting methyl acetate has a purity of 99·9%.

19. Ethyl acetate. Various grades of ethyl acetate are marketed. The anhydrous compound, b.p. 76–77°, is of 99 per cent. purity, is inexpensive, and is suitable for most purposes. The 95–98 per cent. grade usually contains some water, ethyl alcohol and acetic acid, and may be purified in the following manner. A mixture of 1 litre of the commercial ethyl acetate, 100 ml. of acetic anhydride and 10 drops of concentrated sulphuric acid is refluxed for 4 hours and then fractionated. The distillate is shaken with 20–30 g. of anhydrous potassium carbonate, filtered and redistilled. The final product has a purity of about 99·7% and boils at 77°/760 mm.

* Sometimes termed ligroin. The author prefers to confine the term ligroin to the fractions of b.p. above 100°.

20. Carbon disulphide. When working with this solvent, its toxicity (it is a blood and nerve poison) and particularly its high inflammability should be borne in mind. Distillation of appreciable quantities of carbon disulphide should be carried out in a water bath at 55–65°; it has been known to ignite from being overheated on a steam bath.

The analytical reagent grade is suitable for most purposes. The commercial substance may be purified by shaking for 3 hours with three portions of potassium permanganate solution (5 g. per litre), twice for 6 hours with mercury, and finally with a solution of mercuric sulphate (2.5 g. per litre). It is then dried over anhydrous calcium chloride, and fractionated from a water bath at 55–65°. The pure compound boils at 46.5°/760 mm.

21. Nitrobenzene. Nitrobenzene, of analytical reagent quality, is satisfactory for most purposes. The technical product may contain dinitrobenzene and other impurities, whilst the recovered solvent may be contaminated with aniline. Most of the impurities may be removed by steam distillation after the addition of dilute sulphuric acid; the nitrobenzene in the distillate is separated, dried with calcium chloride and distilled. The pure substance has b.p. 210°/760 mm. and m.p. 5.7°.

Nitrobenzene is an extremely versatile solvent, and may frequently be employed for the crystallisation of compounds which do not dissolve appreciably in the common organic solvents. The vapour is somewhat poisonous, so that recrystallisations must be carried out in the fume cupboard. After the crystals have been collected, they should be washed with a volatile solvent, such as benzene, alcohol or ether, to remove the excess of nitrobenzene (compare Section II, 32). The only disadvantage of nitrobenzene as a solvent is that it has a pronounced oxidising action at the boiling point.

22. Pyridine. The analytical reagent grade pyridine will satisfy most requirements. If required perfectly dry, it should be refluxed over potassium or sodium hydroxide pellets or over barium monoxide, and then distilled with careful exclusion of moisture (compare Fig. II, 47, 2). It is hygroscopic, and forms a hydrate of b.p. 94.5°. Pure pyridine has b.p. 115.5°/760 mm.

Pure pyridine may be prepared from technical coal-tar pyridine in the following manner. The technical pyridine is first dried over solid sodium hydroxide, distilled through an efficient fractionating column, and the fraction, b.p. 114–116° collected. Four hundred ml. of the redistilled pyridine are added to a reagent prepared by dissolving 340 g. of anhydrous zinc chloride in a mixture of 210 ml. of concentrated hydrochloric acid and 1 litre of absolute ethyl alcohol. A crystalline precipitate of an addition compound (probable composition $2C_5H_5N, ZnCl_2, HCl$ *) separates and some heat is evolved. When cold, this is collected by suction filtration and washed with a little absolute ethyl alcohol. The yield is about 680 g. It is recrystallised from absolute ethyl alcohol to a constant m.p. (151.8°). The base is liberated by the addition of excess of concentrated

* There appear to be at least two zinc chloride complexes of pyridine, one of m.p. 207° and composition $2C_5H_5N, ZnCl_2$, and the other of m.p. 152° and probable composition $2C_5H_5N, ZnCl_2, HCl$. The former is slightly soluble in water and in hot ethyl alcohol: the latter passes into the former in aqueous solution, is readily soluble in hot absolute ethanol and can therefore be readily recrystallised from this solvent.

sodium hydroxide solution (*ca.* 40 %) and steam distilled until the distillate is no longer alkaline to litmus (*ca.* 1000 ml.). The steam distillate is treated with 250 g. of solid sodium hydroxide, the upper layer separated, and the aqueous layer extracted with two 250 ml. portions of ether. The combined upper layer and ether extracts are dried with anhydrous potassium carbonate, the ether removed on a water bath, and the pyridine distilled through a fractionating column. The pure pyridine is collected at 115.3°/760 mm.

23. Methylene chloride. The commercial substance is purified by washing with 5 per cent. sodium carbonate solution, followed by water, dried over anhydrous calcium chloride, and then fractionated. The fraction, b.p. 40–41°, is collected.

Methylene chloride is a useful substitute for diethyl ether when it is desired to employ a solvent which is heavier than water.

24. *s*-Tetrachloroethane. The technical product is warmed on the steam bath with 8 per cent. of its volume of concentrated sulphuric acid and stirred mechanically for 30 minutes. The upper layer is decanted, and the process is repeated until the sulphuric acid layer remains colourless or almost colourless. The tetrachloroethane is then separated, distilled in steam, dried with anhydrous calcium chloride or with anhydrous potassium carbonate, and distilled. The fraction, b.p. 145–147°, is collected.

Tetrachloroethane is a good solvent for many compounds which dissolve only slightly in the common solvents; it is, however, inferior in solvent power to nitrobenzene, but, on the other hand, it does not possess oxidising properties at the boiling point.

25. Chloroform. The commercial product contains up to 1 per cent. of ethyl alcohol, which is added as a stabiliser. The alcohol may be removed by either of the following procedures:—

(a) The chloroform is shaken five or six times with about half its volume of water, then dried over anhydrous calcium chloride for at least 24 hours, and distilled.

(b) The chloroform is shaken two or three times with a small volume (*say*, 5 per cent.) of concentrated sulphuric acid, thoroughly washed with water, dried over anhydrous calcium chloride or anhydrous potassium carbonate, and distilled.

Pure chloroform has b.p. 61°/760 mm. The solvent, when free from alcohol, should be kept in the dark in order to avoid the photochemical formation of phosgene. It must not be dried with sodium as an explosion may occur.

26. Carbon tetrachloride. The analytical reagent product is sufficiently pure for most purposes; the carbon disulphide content does not exceed 0.005 per cent. The technical product may contain up to 4 per cent. of carbon disulphide; this may be removed by the following method. One litre of commercial carbon tetrachloride is treated with potassium hydroxide (1.5 times the quantity required to combine with the carbon disulphide) dissolved in an equal weight of water and 100 ml. of rectified spirit, and the mixture is vigorously shaken for 30 minutes at 50–60°. After washing with water, the process is repeated with half the quantity of potassium hydroxide. The alcohol is then removed by shaking several times with 500 ml. of water, followed by shaking with small

portions of concentrated sulphuric acid until there is no further colouration. The carbon tetrachloride is then washed with water, dried over anhydrous calcium chloride, and distilled. The pure compound boils at $76.5^{\circ}/760$ mm.

Carbon tetrachloride must not be dried with sodium as an explosion may result. Fire extinguishers containing this solvent (*e.g.*, "Pyrene") cannot therefore be applied to a fire originating from sodium.

Most solvents, which are immiscible with water, may be dried by simple distillation until the distillate is clear (compare Section II,39); the residue is anhydrous. It is usually necessary to remove about 10 per cent. by distillation before the residue is completely anhydrous.

27. **Dioxan** (1:4-dioxan; diethylene dioxide). The commercial substance usually contains small quantities of acetaldehyde, appreciable amounts of glycol acetal (ethylene acetal) CH_3CH $\begin{matrix} \diagup \text{OCH}_2 \\ | \\ \diagdown \text{OCH}_2 \end{matrix}$, together

with some water. Upon keeping, the acetal tends to undergo hydrolysis and the liberated acetaldehyde leads to some peroxide formation. Purification may be effected by refluxing over sodium (which resinifies the acetaldehyde), followed by fractional distillation through an efficient column to remove the acetal (b.p. 82.5°). The yield by this process is low (about 30 per cent.) and better yields (up to 80 per cent.) can be obtained by decomposing the acetal with dilute acid, followed by fractionation. One litre of technical dioxan, 14 ml. of concentrated hydrochloric acid and 100 ml. of water are refluxed for 6–12 hours whilst a slow stream of nitrogen is bubbled through the solution to remove the acetaldehyde formed. The cold solution is treated with potassium hydroxide pellets with shaking until some remain undissolved, and the aqueous layer is run off; most of the residual water is removed by keeping the dioxan over fresh potassium hydroxide pellets for 24 hours. This is followed by refluxing over excess of sodium for 6–12 hours, *i.e.*, until reaction ceases and the sodium remains bright. Finally, the diethylene dioxide is distilled from sodium; it should be stored out of contact with air. The pure compound has b.p. $101.5^{\circ}/760$ mm. and m.p. 12° .

Diethylene dioxide is a very useful solvent for a variety of organic compounds; its action is similar to that of ether but more pronounced. It is miscible with water in all proportions. Dioxan vapour is poisonous.

Note.

Dioxan develops appreciable quantities of peroxides upon exposure to air or upon keeping. These can be eliminated by refluxing over anhydrous stannous chloride (compare Section VI,12) or by filtration through a column of activated alumina.

28. **α -Picoline.** Commercially "pure" α -picoline may contain small amounts of pyridine, β - and γ -picolines and 2:6-lutidine (all of which can be largely separated by an initial fractionation) together with traces of aromatic hydrocarbons. 100 G. of the base is dissolved in 300 ml. of 1:1-hydrochloric acid and the solution is steam distilled until a hydrocarbon odour can no longer be detected in the distillate (*ca.* 500 ml.). The cold acid solution is treated with excess of solid sodium hydroxide (80–100 g.) portionwise with stirring and cooling. The upper layer of base is

separated, the aqueous layer is extracted with three 50 ml. portions of ether, and the extracts combined with the upper layer. After drying over anhydrous potassium carbonate and removing the ether, the residual liquid is distilled through an efficient fractionating column. A fore-run of base - water azeotrope (b.p. *ca.* 90°) is followed by pure α -picoline at 129.7-130.3°/777 mm.

29. β -Picoline. Commercially "pure" β -picoline usually contains small amounts of γ -picoline and 2 : 6-lutidine, which have boiling points very close to it and from which it cannot be separated by fractional distillation. These impurities may be removed by reaction with phthalic anhydride and acetic anhydride, use being made of the greater reactivity of the methyl groups in the 2- and 4-positions of the pyridine ring ; the condensation products are coloured. Traces of non-basic impurities (aromatic hydrocarbons, etc.) are removed by treatment of the acid solution with steam as described under *α -Picoline*. 100 G. of the dry (potassium hydroxide) base is refluxed for 10 hours with a mixture of 25 g. of phthalic anhydride and 25 g. of acetic anhydride. The dark brown reaction mixture, after cooling, is treated with a solution of 50 g. of sodium hydroxide in 150 ml. of water and steam distilled until the distillate is no longer alkaline to litmus (*ca.* 500 ml.). 50 G. of sodium hydroxide are added to the distillate in order to separate most of the base as an upper layer, the aqueous layer is extracted with three 50 ml. portions of ether, and the extracts combined with the upper layer. After drying with anhydrous potassium carbonate and removing the ether, 10 ml. of the recovered base is tested for complete removal of the impurities by refluxing with a mixture of 5 g. each of phthalic and acetic anhydrides for 10 minutes ; pure β -picoline gives a pale yellow colour and the presence of impurities is revealed by the production of an intense yellow or orange colouration. If the latter occurs, the whole of the base is refluxed with the anhydride mixture for a further 5-7 hours. This second treatment usually suffices for a starting material of 90-95 % purity. The base is isolated as before and, after drying over anhydrous potassium carbonate, is carefully fractionated. Pure β -picoline is collected at 144.5°/765 mm. The recovery is about 85 per cent.

30. γ -Picoline. Commercially "pure" γ -picoline contains β -picoline and 2 : 6-lutidine and sometimes traces of non-basic impurities (aromatic hydrocarbons) which cannot be separated by fractionation. The non-basic impurities are removed by steam distillation of the base in dilute hydrochloric or sulphuric acid solution (for details, see under *α -Picoline*). The impure γ -picoline is converted into the zinc chloride complexes of the component bases : the 2 : 6-lutidine - ZnCl₂ complex is the least stable and upon steam distillation of the mixture of addition compounds suspended in water, 2 : 6-lutidine passes over first. The complete separation of the 2 : 6-lutidine may be detected by a determination of the density and the refractive index of the dry recovered base at various stages of the steam distillation. The physical properties are :—

	d_4^{20}	n_D^{20}
γ -picoline	0.9566	1.5069
β -picoline	0.9546	1.5058
2 : 6-lutidine	0.9238	1.4977

The β -picoline in the base recovered from the residual picoline-ZnCl₂ complexes is separated from the γ -picoline by fractional freezing; pure β -picoline has m.p. -18.2° and γ -picoline has m.p. $+3.6^\circ$.

250 ml. of commercially "pure" γ -picoline are added, with stirring, to a solution of 200 g. of zinc chloride in 500 ml. of water contained in a 2-litre three-necked flask equipped with a glycerine-sealed stirrer. The flask is fitted with a steam-inlet tube and splash head; steam is then passed into the well-stirred mixture until about 1 litre of distillate is collected. (With any particular batch of γ -picoline, the base is isolated from the steam distillate at regular intervals, dried and distilled, and the density and refractive index determined; most of the 2:6-lutidine is removed when d_4^{25} is about 0.955. The total volume of steam distillate is noted: in subsequent runs with the same batch of γ -picoline, steam distillation is stopped when this volume of distillate has been collected.) The cold residual suspension of ZnCl₂-complexes is treated with 100 g. of solid sodium hydroxide and the base isolated by direct ether extraction or by steam distillation (see under *α -Picoline*). After drying with anhydrous potassium carbonate and removing the ether, the last traces of water are removed as the base-water azeotrope by careful fractionation. The dry bases are separated by fractional freezing* over a period of several hours, dry nitrogen being used for stirring. When 70-80 per cent. is frozen, the liquid is poured off, the crystals melted, and the process repeated until the freezing point rises to $+3.6^\circ$. The boiling point of such a sample is $145.4^\circ/760$ mm.

31. Formamide. Commercial formamide may contain excess of formic acid. It is purified by passing ammonia gas into the mixture until a slight alkaline reaction is obtained. The ammonium formate thus formed is precipitated by the addition of acetone; the filtrate, after drying over anhydrous magnesium sulphate, is distilled under reduced pressure. Pure formamide has b.p. $105^\circ/11$ mm.

II,48. INORGANIC REAGENTS—GASES

An account will be given in this and the two following Sections of a number of inorganic reagents which find application in organic chemistry. No attempt will be made to describe the preparation of those reagents which can be purchased at a reasonable cost. In some cases, where the purified reagents are somewhat expensive, the methods of purification from the technical products will be outlined.

1. Hydrogen chloride. *Method 1 (from concentrated sulphuric acid and fused ammonium chloride).* The most convenient procedure is to allow concentrated sulphuric acid to react with lumps of fused ammonium chloride in a Kipp's apparatus. The gas may be dried by passage through a wash bottle containing concentrated sulphuric acid; the latter should be followed by an empty wash bottle or flask as a precaution against "sucking back" of the contents of the reaction vessel.

Method 2 (from concentrated sulphuric acid and concentrated hydrochloric acid). The apparatus is shown in Fig. II, 48, 1. The upper funnel has a capacity of 100 ml. and the lower one of 500 ml. A capillary

* An air bath, surrounded by a freezing mixture of ice and salt or of Dry Ice and acetone, is satisfactory.

tube, 35–40 cm. in length, is attached to the stem of the smaller funnel by means of a short length of rubber "pressure" tubing; when this capillary tube is filled with concentrated hydrochloric acid, there is sufficient hydrostatic pressure to force the hydrochloric acid into the sulphuric acid. The wash bottle contains sulphuric acid and is provided with a thistle funnel only slightly immersed in the acid to act as a safety tube. The whole apparatus is mounted on a heavy stand.

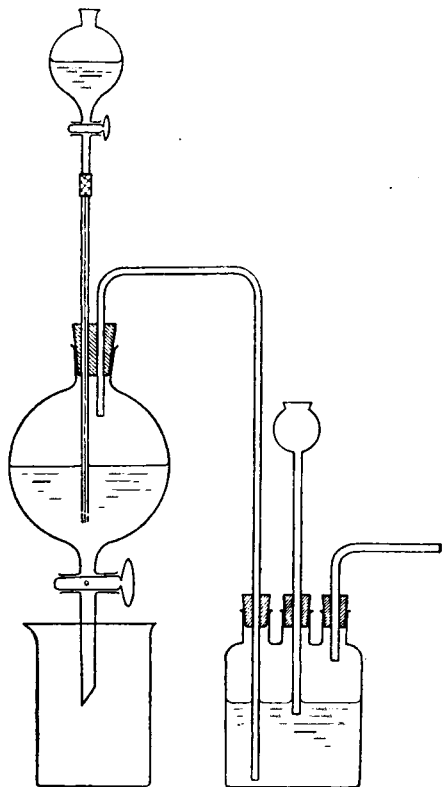

Fig. II, 48, 1.

About 150 ml. of concentrated sulphuric acid is placed in the larger funnel and 100 ml. of concentrated hydrochloric acid in the smaller separatory funnel. The latter is raised until the capillary tube is above the sulphuric acid, the capillary tube is filled with concentrated hydrochloric acid, and the stopper replaced. The rate of evolution of hydrogen chloride is controlled by regulation of the supply of hydrochloric acid: this will continue until a volume of hydrochloric acid equal to that of the concentrated sulphuric acid has been used. The diluted sulphuric acid should then be removed and the apparatus recharged. The yield is 31–33 g. of hydrogen chloride per 100 ml. of concentrated hydrochloric acid. If more than an equal volume of hydrochloric acid is employed, the yield of gas decreases and continues to be formed for a time after the stopcock has been closed.

2. Hydrogen bromide. *Method 1* (by direct combination of hydrogen and bromine). This gas may be readily prepared by passing a mixture of hydrogen and bromine vapour through a hot tube packed with porous porcelain chips; excess of bromine is removed by passage through a tube containing copper turnings. The apparatus is illustrated in Fig. II, 48, 2. *A* is a 125 ml. Pyrex distilling flask of which the side arm has been bent into a horizontal position. It is immersed into a 800 or 1000 ml. beaker, which acts as a water bath. The distilling flask is fitted with a two-holed rubber stopper carrying a 50 ml. dropping funnel * and a tube bent twice at right angles leading to a safety bottle *C*. The safety bottle is charged with water (or some other suitable liquid) and has an outlet tube for hydrogen in case an obstruction is formed in the apparatus; the outlet tube must be connected to a tube leading directly to the ventilation shaft (fume cupboard). The side arm of the distilling flask is fitted by means

* The stopcock should preferably be lubricated with "Silicone" stopcock grease, and held in position by a rubber band.

of a rubber stopper into a Pyrex combustion tube *D*, 30–40 cm. long and 20 mm. internal diameter, filled with small pieces of porous porcelain; the other end of the tube is connected by a rubber stopper and a three-way stopcock *E* to a vertical tube *F*, 60 cm. long and 20 mm. internal diameter, packed with copper turnings held in position by glass wool plugs. The tube *D* is supported in a small gas-heated furnace, or in a suitable wide-

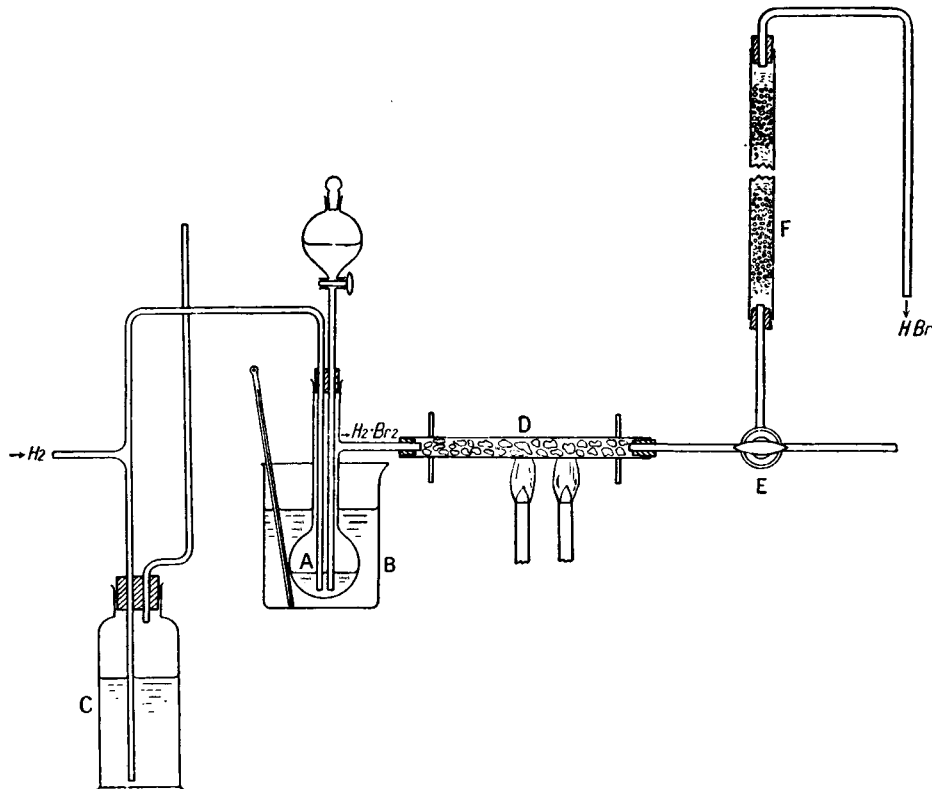

Fig. 11, 48, 2.

flamed burner, or in a small metal frame and the tube is heated with one or two Bunsen burners: shields of asbestos board are fitted at distances of about 3 cm. from both ends. To operate the apparatus, the stopcock *E* is turned so that the tube *F* is disconnected and the gases pass directly into the fume chamber. The safety bottle *C* is connected to a cylinder of hydrogen provided with a fine-control reducing valve, and the tube inside the bottle is adjusted so that it is immersed in the water to a depth of about 12 cm. Bromine (not shown in the figure) is placed in the flask *A* and the water bath *B* heated to and maintained at 38°.* A slow stream of hydrogen is passed through the apparatus, and when bromine vapour completely fills the combustion tube the latter is heated to a dull red heat. The formation of hydrogen bromide will soon commence and a

* The vapour pressure of the bromine should be maintained at about half an atmosphere (vapour pressures at 35° and 40° are 324 and 392 mm. respectively). If the water bath becomes too warm, it should be cooled immediately with ice, as otherwise more bromine will vapourise than can combine with the hydrogen present.

small yellow flame will be apparent in the hot part of the tube nearest *B*; the stopcock *E* is turned so that the combustion tube *D* is connected to the tube *F* containing copper turnings* in order that traces of bromine may be removed. The yield of hydrogen bromide is controlled by the rate of passage of hydrogen through the flask *A*. The apparatus will produce about 300 g. of hydrogen bromide per hour.

Traces of bromine, carried over with the gas, are removed by the copper turnings as black copper bromide; if the level of the blackened copper in tube *F* rises appreciably, excessive amounts of bromine are being carried over.

Method 2 {by the action of bromine upon tetrahydronaphthalene (tetralin)}. The reaction may be represented by the equation:

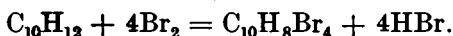

Only half of the added bromine is recovered as hydrogen bromide. It is essential that the tetralin be perfectly dry otherwise the yield is considerably reduced. The tetralin is placed in a flask fitted with a dropping funnel and a delivery tube. Dry air must be bubbled *through* the liquid for at least 30 minutes to remove water, but the time may be considerably reduced by a preliminary drying with anhydrous magnesium or calcium sulphate. The bromine is allowed to drop in at a regular rate: a steady stream of hydrogen bromide is evolved. Traces of bromine carried over with the gas may be eliminated by bubbling through dry tetralin. The yield of hydrogen bromide is 45 to 47 per cent. computed upon the weight of bromine taken.

3. Hydrogen iodide. This gas may be conveniently prepared by allowing a solution of two parts of iodine in one part of hydriodic acid, sp. gr. 1.7 (for preparation, see Section II,49,2), to drop on to excess of red phosphorus. The evolution of hydrogen iodide takes place in the cold; when the evolution of gas slackens considerably, the mixture should be *gently* warmed.

4. Hydrogen cyanide. Great care must be exercised in the preparation of this gas for it is a dangerous poison; all operations must be conducted in a fume cupboard provided with an efficient draught. The apparatus used is similar to, but generally on a smaller scale than, that described for *Hydrogen chloride, Method 2*. A saturated solution of sodium cyanide (prepared by dissolving 101.5 g. of commercial sodium cyanide, about 96 per cent., in sufficient water to make 250 ml. of solution) is added 1 cm. below the surface of sulphuric acid (50 per cent. by volume) contained in a flask. Any residual hydrogen cyanide may be expelled by warming the flask on a water bath. The gas may be used directly, or may be collected in the liquid form (b.p. 26°) by passing through a glass coil, 4–5 cm. bore and 50 cm. long, surrounded by ice: a freezing mixture must not be used as this may result in solidification of the hydrogen cyanide (m.p. –15° to –14.5°) and consequent clogging of the apparatus. If the hydrogen cyanide is required anhydrous, it should be passed through three large U-tubes filled with anhydrous calcium chloride and immersed in a water bath at 30–40°.

* An alternative method for the complete removal of bromine consists in passing the hydrogen bromide through a solution of phenol in dry carbon tetrachloride.

5. **Boron fluoride.** This gas, b.p. -101° , is available in cylinders * and can be bubbled directly into a reaction mixture.

6. **Chlorine.** Small quantities of chlorine are readily prepared by the action of concentrated hydrochloric acid upon potassium permanganate in the apparatus shown in Fig. II, 48, 3. The calculated quantity of potassium permanganate ($0.367 \text{ g. KMnO}_4 \equiv 0.412 \text{ g. Cl}_2$) is placed in the distilling flask and a slight excess of concentrated hydrochloric acid in the long-stemmed funnel (1.000 g. KMnO_4 requires 6.2 ml. of concentrated HCl). The chlorine evolved is passed through a wash bottle

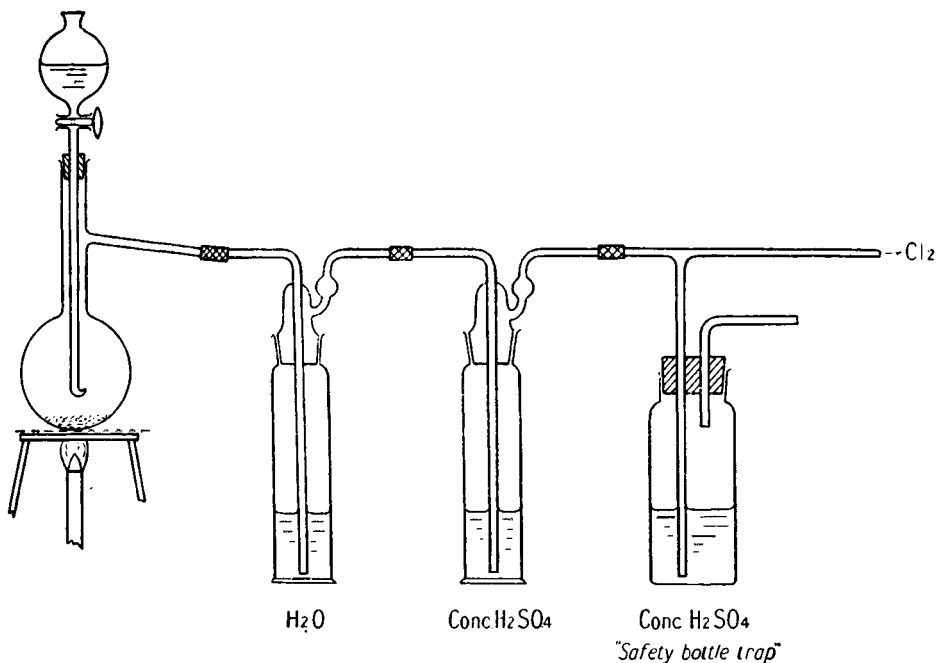

Fig. II, 48, 3.

containing water to remove hydrogen chloride and is then dried by means of another wash bottle charged with concentrated sulphuric acid; it is advisable, where excessive pressure is likely to develop, to insert a safety bottle trap containing sulphuric acid (see figure). The acid is allowed to drop slowly upon the permanganate crystals: the flask should be shaken from time to time. When about half of the acid has been added, the evolution of gas commences to slacken and the distilling flask should then be warmed slightly; after all the acid has been introduced, the mixture is boiled gently. If an absolutely quantitative yield of chlorine is required, the last traces of the gas may be expelled from the flask and wash bottles by a stream of carbon dioxide. The apparatus should be disconnected after the reaction is complete.

For comparatively large quantities of chlorine, a small cylinder of chlorine should be employed; the amount of chlorine used can be determined from the loss in weight of the cylinder.

* For example, from Imperial Smelting Corporation, 37, Dover Street, London, W.1, or from The Matheson Company, East Rutherford, N.J., U.S.A.

7. **Ammonia.** Small quantities of ammonia may be prepared with the aid of the apparatus depicted in Fig. II, 48, 4. Concentrated ammonia solution (sp. gr. 0.88) is gently heated in the flask surmounted by an efficient reflux condenser. The gas is dried by passage through the tower which is loosely packed with soda lime or quicklime,* and is then passed

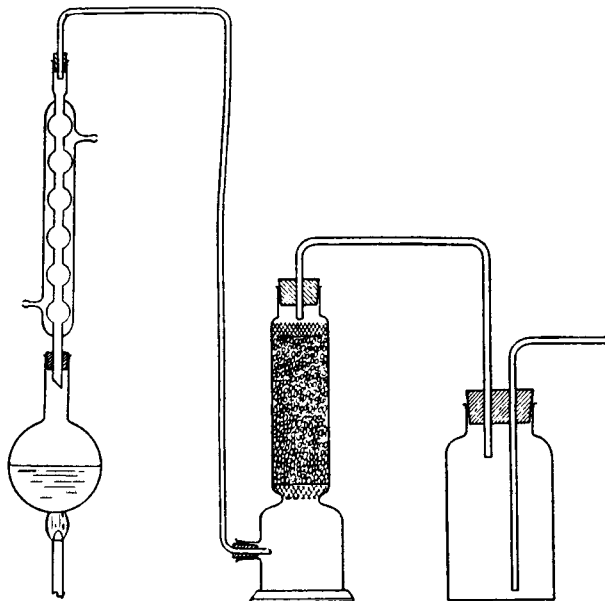

Fig. II, 48, 4.

through a safety bottle, the tubes of which are so arranged that any liquid "sucked back" from the mixture being treated with the gas will eventually be returned to the reaction vessel.

Ammonia is conveniently obtained from a cylinder of the liquefied gas; the cylinder must be equipped with a reducing valve. The rate of flow of the gas may be determined by passage through a bubble counter containing a small volume of concentrated potassium hydroxide solution (12 g. of KOH in 12 ml. of water). A safety bottle should be inserted between the cylinder and the reaction vessel.

8. **Carbon dioxide.** This gas is conveniently generated from marble and dilute hydrochloric acid (1 : 1) in a Kipp's apparatus; it should be passed through a wash bottle containing water or sodium bicarbonate solution to remove acid spray and, if required dry, through two further wash bottles charged with concentrated sulphuric acid.

Large quantities of carbon dioxide may be obtained from a cylinder of the liquid gas; the gas should be dried by passing it through two wash bottles containing concentrated sulphuric acid. A little air is present in the gas.

* The solid in the tower may be supported on a Witt filter plate, but a plug of glass wool is satisfactory: the plug of glass wool above the solid acts as a filter for fine particles of the desiccant.

For some purposes (e.g., in the Grignard reaction) solid carbon dioxide, marketed as "Dry Ice" or "Drikold," may be employed.

9. Carbon monoxide. This gas is readily prepared by the action of concentrated formic acid (sp. gr. 1.2; about 90 per cent.) upon concentrated sulphuric acid at 70–80°. The apparatus of Fig. II, 48, 5 is recommended. The distilling flask (500 ml.) is immersed in an oil bath maintained at 70–80°, and is connected to two wash bottles containing concentrated sulphuric acid. 125 grams of concentrated sulphuric acid are placed in the distilling flask and 85 g. of the strong formic acid are slowly added from the dropping funnel; a steady stream of gas is evolved. The resulting carbon monoxide may contain traces of carbon dioxide and sulphur dioxide: these impurities may be removed, if desired, by passage of the gas through a tower filled with potassium hydroxide pellets.

Carbon monoxide is very poisonous: all operations involving its preparation and use must be carried out in an efficient fume cupboard.

10. Sulphur dioxide. Sulphur dioxide is available in the liquid form in heavy glass cylinders; the gas is obtained by simply turning the metal valve.

11. Hydrogen sulphide. This poisonous gas is usually prepared from ferrous sulphide and dilute hydrochloric acid (1:3) in a Kipp's apparatus: it should be washed with water to remove acid spray. The resulting hydrogen sulphide contains hydrogen because of the presence of free iron in commercial ferrous sulphide.

Hydrogen sulphide is marketed in cylinders.*

12. Phosgene (carbonyl chloride). Phosgene may be purchased in steel cylinders or in the form of a solution (ca. 12.5 per cent. by weight) in toluene in glass ampoules. Owing to the very poisonous character of the gas (b.p. 8°), all operations with it must be conducted in a fume cupboard provided with a powerful draught, and all excess of phosgene must be absorbed in 20 per cent. sodium hydroxide solution. The preparation of the gas is rarely undertaken in the laboratory, but small quantities may be prepared by the following procedure. The apparatus (assembled in a fume chamber) consists of a flask with a short reflux condenser; a dropping funnel and delivery tube leading to an empty wash bottle are fitted into the top of the condenser. The wash bottle is connected to a Buchner flask, which acts as a receiver. One hundred per cent. sulphuric acid, to which 2 per cent. by weight of ignited kieselguhr has been added, is placed in the flask; carbon tetrachloride is introduced into the dropping funnel and dry toluene into the receiver. The sulphuric acid is heated to 120–130° in an oil bath and the carbon tetrachloride is allowed to drop in slowly; the resulting phosgene is absorbed in the toluene, whilst the hydrogen chloride passes on.

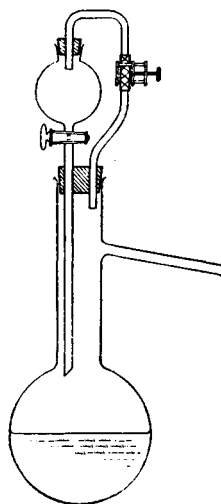
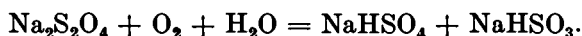

Fig. II, 48, 5.

* For example, from The Matheson Company, Inc., East Rutherford, N.J., U.S.A.

13. Nitrogen. Cylinders of compressed nitrogen may be purchased or hired. The gas may contain traces of oxygen which may be removed, if necessary, by passage either through an alkaline solution of pyrogallol (15 g. of pyrogallol dissolved in 100 ml. of 50 per cent. sodium hydroxide solution) or through Fieser's solution, which consists of an alkaline solution of sodium hyposulphite to which sodium anthraquinone β -sulphonate is added as a catalyst. Fieser's solution is prepared by dissolving 20 g. of potassium hydroxide in 100 ml. of water, and adding 2 g. of sodium anthraquinone β -sulphonate and 15 g. of commercial sodium hyposulphite (*ca.* 85 per cent.) to the warm solution and stirring until dissolved: the blood-red solution is ready for use when it has cooled to room temperature, and will absorb about 750 ml. of oxygen. The exhaustion of this solution is indicated by the change in colour to dull-red or brown, or when a precipitate appears:



Oxygen-free nitrogen in cylinders is available commercially but is, of course, more expensive than the normal commercial compressed gas.

14. Hydrogen. Cylinders of compressed hydrogen may be purchased or hired. This gas is usually of electrolytic origin and is essentially pure except for traces of oxygen. Since hydrogen is chiefly employed for catalytic reductions and oxygen has, in general, no harmful effect upon the reduction, no purification is usually necessary. If, however, oxygen-free hydrogen is required, it may be removed by either of the following methods:—

(i) By passage over heated platinised asbestos.*

(ii) By passage through Fieser's solution (see under *Nitrogen*, 13), followed by a wash bottle containing concentrated sulphuric acid to which some silver sulphate has been added; the latter will detect any hydrogen sulphide that may have formed from the decomposition of Fieser's solution.

II.49. INORGANIC REAGENTS—LIQUIDS

1. Hydrobromic acid. *Method 1 (from bromine and sulphur dioxide).* A mixture of 600 g. (or 188.5 ml.) of bromine, 250 ml. of water and 750 g. of crushed ice is placed in a 1.5 litre round-bottomed flask and a rapid stream of sulphur dioxide (from a siphon of the liquefied gas) is passed into the flask, care being taken that the outlet of the gas-delivery tube is below the surface of the bromine layer. The rate of flow of the gas is adjusted so that it is completely absorbed. It is advisable to cool the flask in ice and also to shake the contents from time to time. The reduction is complete when the mixture assumes a uniform yellowish-brown or yellow colour, which is unaffected by further introduction of sulphur dioxide; excess of the latter gas should be avoided as it will be

* It is better to employ the special palladium catalyst which is incorporated in the "Deoxo catalytic gas purifier" (obtainable from Baker Platinum Limited, 52 High Holborn, London, W.C.1). This functions at the laboratory temperature and will remove up to 1 per cent of oxygen. The water vapour formed is carried away in the gas stream and is separated by any of the common desiccants.

evolved during the subsequent distillation. The flask is then connected with a short still head and condenser, and the mixture is distilled. The main product will pass over at 125–126°/760 mm., but the temperature may rise to 130°; the distillation is then stopped. The residue is sulphuric acid. The distillate is redistilled from a little barium bromide in order to remove traces of sulphuric acid, and the fraction, b.p. 125–126°—constant boiling point hydrobromic acid containing 48 per cent. HBr—collected. The yield is about 1150 g. or 90 per cent. of the theoretical.

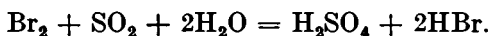

Method 2 (from potassium bromide and sulphuric acid). Potassium bromide (240 g.) is dissolved in water (400 ml.) in a litre flask, and the latter is cooled in ice or in a bath of cold water. Concentrated sulphuric acid (180 ml.) is then slowly added. Care must be taken that the temperature does not rise above 75° otherwise a little bromine may be formed. The solution is cooled to room temperature and the potassium bisulphate, which has separated, is removed by filtration through a hardened filter paper in a Buchner funnel or through a sintered glass funnel. The filtrate is distilled from a litre distilling flask, and the fraction b.p. 124–127° is collected; this contains traces of sulphate. Pure constant boiling point hydrobromic acid is obtained by redistillation from a little barium bromide. The yield is about 285 g. or 85 per cent. of the theoretical.

Method 3 (from bromine and sulphur) (1). A 1-litre three-necked flask is charged with 27 g. of flowers of sulphur and 550 ml. of water. The flask is equipped with a dropping funnel (with tip below the surface of the water), a water-sealed mechanical stirrer and an Allihn reflux condenser; ground glass joints are preferable, but used rubber stoppers are generally satisfactory. The flask is immersed in a bath of water at 60°, the mixture stirred vigorously and, when the temperature inside the flask is about 50°, 400 g. (125·5 ml.) of bromine are introduced from the dropping funnel during about 20 minutes. The temperature of the reaction mixture rises rapidly as the reaction proceeds; the flask is cooled momentarily in a bath of cold water if the condensed bromine vapour is near the top of the condenser. When all the bromine has been added, the mixture is heated on a boiling water bath for 15 minutes. The reaction product is cooled, and filtered from the residual sulphur and other solid matter through a sintered glass funnel. The filtrate is distilled and the constant b.p. hydrobromic acid collected at 125–126°/760 m. The yield is 805 g.

Note. (1) The reaction between bromine and sulphur in the presence of water may be represented by the equation:

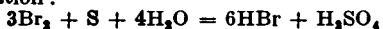

It is rather slow at moderate temperatures and the hydrobromic acid formed in the initial stages of the reaction inhibits its further progress. By carrying out the reaction at 50–70° or above in the presence of a large excess of water, the inhibition observed at lower temperatures does not occur.

Hydrobromic acid (analytical reagent grade), sp. gr. 1·46 to 1·49 (46–48 per cent. HBr) may be purchased.

2. **Hydriodic acid.** A 1·5 litre three-necked flask is charged with a mixture of 480 g. of iodine and 600 ml. of water. The central aperture is fitted with a stopper carrying an efficient mechanical stirrer leading

almost to the bottom of the flask, and the smaller apertures respectively with a lead-in tube for hydrogen sulphide extending to well below the surface of the liquid and with an exit tube attached to an inverted funnel just dipping into 5 per cent. sodium hydroxide solution. The mixture is vigorously stirred and a stream of hydrogen sulphide (either from a freshly-charged Kipp's apparatus or from a cylinder of the gas) passed in as rapidly as it can be absorbed. After several hours the liquid assumes a yellow colour (sometimes it is almost colourless) and most of the sulphur sticks together in the form of a hard lump. The sulphur is removed by filtration through a funnel plugged with glass wool (or through a sintered glass funnel), and the filtrate is boiled until the lead acetate paper test for hydrogen sulphide is negative. The solution is filtered again, if necessary. The hydriodic acid is then distilled from a 500 ml. Claisen flask, and the fraction b.p. $125.5-126.5^{\circ}/760$ mm. is collected. This is the constant boiling point hydriodic acid and contains 57 per cent. of hydrogen iodide. The yield of the constant boiling acid is 785 g. or 90 per cent. of the theoretical.

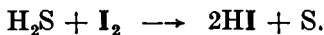

Note.

The hard lump of sulphur remaining in the flask is best removed by boiling with concentrated nitric acid in the fume cupboard.

Hydriodic acid, of analytical reagent quality, sp. gr. 1.7 (54–56 per cent. HI) and sp. gr. 1.94 (64–68 per cent. HI) may be purchased.

3. Sulphuric acid. Ordinary concentrated acid, sp. gr. 1.84, is a constant boiling point mixture, b.p. $338^{\circ}/760$ mm., and contains 98 per cent. H_2SO_4 . The 100 per cent. acid may be prepared by the addition of the calculated quantity of oleum *; it is also available commercially.

Oleum is marketed in all strengths up to ca. 70 per cent. SO_3 . From 0 to 40 per cent. free SO_3 , it is a liquid; from 40 to 60 per cent. free SO_3 , it is a solid; from 60 to 70 per cent. free SO_3 , it is liquid; above 70 per cent. free SO_3 , it is a solid. The acid must be kept in ground glass stoppered, thick-walled bottles. If it is required to melt the acid, the stopper is removed, a watch glass placed on the mouth of the bottle, and the bottle placed in a layer of sand in an air bath which is warmed with a small flame. The bottle is fitted with a wash bottle attachment, and any desired quantity of acid is forced out by gentle air pressure from a hand or foot bellows (the mouth must not be used); this procedure is far more satisfactory than that of pouring the liquid acid from the bottle.

4. Nitric acid. The commercial concentrated acid, sp. gr. 1.42, is a constant boiling point mixture of maximum boiling point ($120.5^{\circ}/760$ mm.) containing about 68 per cent. HNO_3 . Colourless concentrated acid may be obtained from the coloured product (due to oxides of nitrogen or to nitrous acid) by warming to about 60° and passing in a stream of dust-free nitrogen or air; the addition of a little urea considerably accelerates the process.

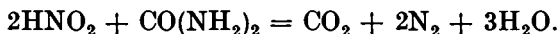

* A method for determining the SO_3 content of oleum is described in the author's *Text Book of Quantitative Inorganic Analysis: Theory and Practice*, Second Edition, 1951, p. 263 (Longmans, Green and Co. Ltd.).

The so-called **fuming nitric acid**, sp. gr. 1.5 and containing about 95 per cent. HNO_3 , may be purchased ; it has a yellow colour, due to the presence of oxides of nitrogen. This acid may be prepared by distilling a mixture of equal volumes of concentrated nitric acid, sp. gr. 1.42, and concentrated sulphuric acid in an all-glass apparatus, and collecting a volume of distillate slightly less than one-half of the volume of concentrated nitric acid originally used. The distillation may also be conducted in a retort, the side arm of which has been bent in the centre to act as a trap for the condensation of acid spray ; a plug of glass wool should be placed in the neck of the receiver. A colourless highly concentrated nitric acid may be obtained by the removal of the oxides of nitrogen as detailed above.

5. Phosphoric acid. The commercial syrupy orthophosphoric acid has a sp. gr. of 1.75 and contains about 88 per cent. of H_3PO_4 . An approximately 100 per cent. acid is also marketed.

6. Thionyl chloride. The technical product frequently contains traces of acids and other impurities ; it is advisable to remove these before using the reagent for the preparation of acid chlorides, *etc.* "Thionyl chloride, redistilled" is satisfactory in many cases. A colourless product of high purity may be obtained by the following simple process. Commercial thionyl chloride is first fractionated, preferably in an all-glass apparatus, from quinoline in order to remove acid impurities (50 g. of thionyl chloride from 10 ml. of quinoline) ; the receiver is protected from the entrance of moisture by a drying tube, filled with cotton wool or anhydrous calcium chloride. The distillate is then refractionated as before from boiled linseed oil (50 g. of thionyl chloride from 20 ml. of linseed oil), the fraction b.p. $76-78^\circ$ being collected. Pure thionyl chloride has b.p. $77^\circ/760$ mm., and must be stored in a well-fitting, glass-stoppered bottle.

7. Sulphuryl chloride. The technical product should be fractionated, preferably in an all-glass apparatus ; the fraction b.p. $69-70^\circ$ is collected. The pure substance has b.p. $69^\circ/760$ mm.

8. Bromine. The commercial product may be dried (and partially purified) by shaking with an equal volume of concentrated sulphuric acid, and then separating the acid. Chlorine, if present, may be removed by fractionation in an all-glass apparatus from pure potassium bromide : the b.p. is $59^\circ/760$ mm. The analytical reagent grade is satisfactory for most purposes where pure bromine is required.

9. Phosphorus tribromide. Into a 500 ml. three-necked flask, provided with a mechanical stirrer (sealed with dry carbon tetrachloride), a dropping funnel and a reflux condenser, are placed 28 g. of purified red phosphorus (Section II,50,5), and 200 ml. of carbon tetrachloride (dried over anhydrous calcium chloride). Dry bromine (198 g. ; 63.5 ml.) is placed in the dropping funnel and added to the vigorously stirred contents of the flask at the rate of about 3 drops per second. A little hydrogen bromide is evolved so that the preparation should be carried out in a fume cupboard. After all the bromine has been added, the mixture is refluxed for 15 minutes by immersing the flask in a water bath at $80-90^\circ$. The clear solution is then decanted through a fluted filter paper, and the carbon tetrachloride is distilled off through a short column (*e.g.*, the

all-glass Dufton column, Section II,15) in an all-glass apparatus; the residue, upon distillation through the well-lagged column, boils at 166–169° (mainly at 168°). Upon redistillation, using an ordinary distilling flask in an all-glass apparatus, the phosphorus tribromide boils at 170–171°. The yield is 190 g.

10. Hydrazine hydrate. In a 750 ml. copper flask (1), fitted with a cork covered with tin foil and holding a reflux condenser, are placed 200 g. of hydrazine sulphate and 160 g. of sodium hydroxide. Seventy-five ml. of water (2) are added gradually during about 5 minutes through the condenser; the reaction becomes fairly vigorous and care should be taken that none of the vapours escape from the condenser. The mixture is refluxed for 1.5 hours. The reflux condenser is removed and arranged for downward distillation. The product is distilled by heating the flask with a free flame; strong heating is required towards the end in order to drive over the last traces of hydrazine hydrate. The distillate is a clear liquid weighing 175 g. (3), and contains 40–45 per cent. of hydrazine hydrate (4) as shown by titration with standard acid.

The 40–45 per cent. hydrazine solution may be concentrated as follows. A mixture of 150 g. (144 ml.) of the solution and 230 ml. of xylene is distilled from a 500 ml. round-bottomed flask through a well-lagged Hempel (or other efficient fractionating) column fitted into a cork covered with tin foil. All the xylene passes over with about 85 ml. of water. Upon distillation of the residue, about 50 g. of 90–95 per cent. hydrazine hydrate (5) are obtained.

Notes.

(1) Glass flasks cannot be used because of the high temperature required in the distillation.

(2) This amount of water is satisfactory; if less water is used, the yield is lowered, while more water dilutes the product without increasing the yield.

(3) The product is sometimes contaminated with silicic acid from the glass of the condenser: this may be removed by filtration. All corks should be covered with tin foil to avoid attack by the hydrazine hydrate.

(4) Hydrazine hydrate may be titrated with standard acid using methyl orange as indicator or, alternatively, against standard iodine solution with starch as indicator. In the latter case about 0.1 g., accurately weighed, of the hydrazine hydrate solution is diluted with about 100 ml. of water, 2–3 drops of starch indicator added, and immediately before titration 5 g. of sodium bicarbonate are introduced. Rapid titration with iodine gives a satisfactory end point.

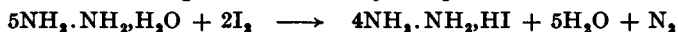

(5) Hydrazine hydrate of 60 per cent. and 100 per cent. are available commercially. The preparation from hydrazine sulphate is hardly worth while.

II,50. INORGANIC REAGENTS—SOLIDS

1. Cuprous chloride. Hydrated copper sulphate (125 g.) and sodium chloride (32.5 g.) are dissolved in water (400 ml.); boiling may be necessary. An alkaline solution of sodium sulphite (from 26.5 g. of sodium bisulphite and 17.5 g. of sodium hydroxide in 200 ml. of water) or the solution of the sodium bisulphite alone is added to the resulting hot solution during about 5 minutes with constant shaking. The solution will be decolourised or nearly so. It is then cooled to room temperature (or in an ice bath), and the supernatant liquid is decanted

from the colourless cuprous chloride. The precipitate is washed twice by decantation with water containing a little dissolved sulphurous acid, the latter to prevent oxidation. For most purposes a solution of cuprous chloride is required: the moist cuprous chloride is dissolved in 200 ml. of concentrated hydrochloric acid. The solution should be used within 24 hours of its preparation as it tends to oxidise (and therefore darken) on keeping; if it is not to be used immediately, the solution is kept in a tightly stoppered bottle. If the dry solid cuprous chloride is required, the moist solid should be washed several times by decantation with dilute sulphurous acid, collected in a Buchner funnel, washed several times with small portions of glacial acetic acid, and dried in an evaporating dish (or in an air oven at 100–120°) until the odour of acetic acid has disappeared. The cuprous chloride thus obtained has a pure white colour and should be kept in a tightly stoppered bottle. The yield is almost quantitative.

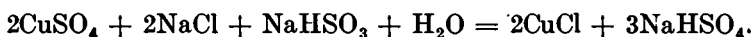

2. Cuprous bromide. The solid salt may be prepared by dissolving 150 g. of copper sulphate crystals and 87.5 g. of sodium bromide dihydrate in 500 ml. of warm water, and then adding 38 g. of powdered sodium sulphite over a period of 5–10 minutes to the stirred solution. If the blue colour is not completely discharged, a little more sodium sulphite should be added. The mixture is then cooled, the precipitate is collected in a Buchner funnel, washed twice with water containing a little dissolved sulphurous acid, pressed with a glass stopper to remove most of the liquid, and then dried in an evaporating dish or in an air oven at 100–120°. The yield is about 80 g.

A solution of cuprous bromide may be prepared either by dissolving the solid in hot constant boiling point hydrobromic acid or by refluxing a mixture of 63 g. of crystallised copper sulphate, 20 g. of copper turnings, 154 g. of sodium bromide dihydrate, 30 g. (16.3 ml.) of concentrated sulphuric acid and 1 litre of water for 3–4 hours. If the colour of the solution has not become yellowish after this period of heating, a few grams of sodium sulphite should be added to complete the reduction.

3. Cuprous cyanide. *Method 1* (Barber, 1943). This is based essentially upon the reaction:

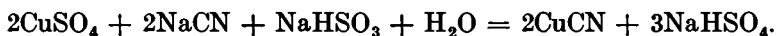

500 g. of powdered crystallised copper sulphate are placed in a 3-litre beaker or round-bottomed flask and dissolved in 1600 ml. of water at 40–50°. Solutions of 140 g. of commercial sodium bisulphite powder in 400 ml. of water (*A*) and of 140 g. of commercial potassium cyanide (96–99 per cent. KCN) in 400 ml. of water (*B*) are prepared, and filtered, if necessary, from small amounts of insoluble matter. Solutions *A* and *B* are separately warmed to 60°. The copper sulphate solution should be acidified faintly to Congo red. Solution *A* is then added with mechanical stirring during 1–2 minutes, followed immediately by solution *B*. There is a slight frothing, a little sulphur dioxide is evolved, but no appreciable amount of cyanogen or hydrogen cyanide. After about 10 minutes, the hot solution is filtered, the product washed thoroughly with boiling water,

and finally with alcohol. It is dried at 100–110° to a fine soft powder (24–36 hours). The yield is 167 g. To prepare a cuprocyanide solution of known and definite concentration, a weighed amount of the dry cuprous cyanide is dissolved in the necessary quantity (about 2 mols) of a solution of an alkali cyanide; an almost colourless solution results.

Method 2. This utilises the reaction :



The disadvantages of the method are the evolution of cyanogen, thus necessitating the use of a fume cupboard, and the consequent wastage of sodium cyanide; the results, however, are quite satisfactory. A 3-litre three-necked flask is fitted with a mechanical stirrer, a separatory funnel and a gas exit tube passing to the flue of an efficient fume cupboard. A solution of 325 g. of powdered copper sulphate pentahydrate is placed in the flask and the latter surrounded by a bath heated to about 80°. A solution of 178 g. of technical sodium cyanide (96–98 per cent.) in 325 ml. of water is added from the separatory funnel during about 30 minutes to the stirred copper sulphate solution. The mixture is then boiled for 5–10 minutes in order to expel all the cyanogen gas. The cuprous cyanide, which commences to separate as a light tan powder as soon as the cyanide solution is added, is allowed to settle and the solution is decanted. The precipitate is filtered off on a Buchner or sintered glass funnel, washed with hot water (500–750 ml.), followed by alcohol (250 ml.) and ether (150 ml.). The product is dried at 105–110° for about 36 hours; if the temperature of the drying is allowed to rise appreciably, the cuprous cyanide will be gradually decomposed. The yield is 100–105 g.

Cuprous cyanide solution. The most satisfactory method is to dissolve the cuprous cyanide (1 mol) in a solution of technical sodium cyanide (2·5–2·6 mols in 600 ml. of water). If it is desired to avoid the preparation of solid cuprous cyanide, the following procedure may be adopted. Cuprous chloride, prepared from 125 g. of copper sulphate crystals as described under 1 above, is suspended in 200 ml. of water contained in a 1-litre round-bottomed flask, which is fitted with a mechanical stirrer. A solution of 65 g. of technical sodium cyanide (96–98 per cent.) in 100 ml. of water is added and the mixture is stirred. The cuprous chloride passes into solution with considerable evolution of heat. As the cuprous cyanide is usually employed in some modification of the diazo reaction, it is usual to cool the resulting solution in ice.

4. Copper.—Copper powder. One hundred grams of recrystallised copper sulphate are dissolved in 350 ml. of hot water in a 1-litre beaker; a mechanical stirrer is provided. After cooling to the laboratory temperature, the stirrer is set in motion and 35 g. (or more, if necessary) of high grade zinc powder are gradually added until the solution is decolourised. The precipitated copper is washed by decantation with water. Dilute hydrochloric acid (5 per cent.) is added to the precipitate in order to remove the excess of zinc, and stirring is continued until the evolution of hydrogen ceases. The copper powder is filtered, washed with water, and kept in a moist condition (as a paste) in a stoppered bottle.

Activated copper bronze. Commercial copper bronze does not always give satisfactory yields in the Ullmann reaction, but uniform results can

be obtained by the following "activation process." One hundred grams of copper bronze are treated with 1 litre of a 2 per cent. solution of iodine in acetone for 5-10 minutes. This results in the production of a rather grayish colour due to the formation of copper iodide. The product is filtered off on a Buchner funnel, removed, and washed by stirring with 500 ml. of 1 : 1 solution of concentrated hydrochloric acid in acetone. The copper iodide dissolves, and the residual copper bronze is filtered and washed with acetone. It is then dried in a vacuum desiccator. The "activated" copper bronze should be used immediately after preparation.

5. Red phosphorus. Commercial red phosphorus is usually contaminated with small quantities of acidic products. It should be boiled for 15 minutes with distilled water, allowed to settle, decanted through a Buchner funnel, and then washed two or three times with boiling water by decantation. Finally, the phosphorus is completely transferred to the Buchner funnel and washed with hot water until the washings are neutral. It is dried at 100°, and kept in a desiccator or in a tightly stoppered bottle.

6. Sodium. The preparation of sodium wire is described in Section II,47,1. **Granulated sodium** (also termed molecular sodium and powdered sodium) may be prepared by either of the following methods :

Method 1. Twenty-three grams of clean sodium (most conveniently weighed under sodium-dried ether after the surface coating has been cut away with a knife) are introduced into a 750 or 1000 ml. round-bottomed Pyrex flask containing about 200 ml. of sodium-dried xylene or at least sufficient xylene to cover the sodium completely. The flask is placed on a sand bath supported on a ring burner. Two or three thicknesses of dry cloth (or a thick towel), sufficient to envelop the whole flask, are placed in a convenient position on the bench. The sand bath is heated cautiously and the "ring" of condensed vapour of the xylene is carefully watched. When the "ring" of condensed vapour has risen to within one inch from the neck of the flask,* the flame beneath the burner is extinguished, a well-fitting rubber stopper or good quality bark cork is rapidly introduced, the flask is completely wrapped in the previously prepared cloth and shaken vigorously for 30-60 seconds or until the molten sodium is converted into a fine powder. The flask is then placed on a "suberite" ring and the stopper is removed. The sodium is thus obtained in the form of small spheres, the size of which is controlled by the time and rapidity of the shaking. Any particles of sodium adhering to the sides of the flask are washed under the xylene. When the contents of the flask have cooled to room temperature, the xylene may be decanted and the sodium washed twice with 100 ml. of sodium-dried ether to remove traces of xylene; finally the finely-divided sodium is covered with absolute ether. A bucket, half-full of dry sand, should be kept at hand in case of breakage of the flask. Not more than 25-30 g. of sodium should be powdered at one time by this procedure.

Method 2. It is convenient to prepare the powdered sodium in the flask in which the subsequent reaction is to be carried out; this is usually a three-necked flask. Into a 1-litre three-necked flask fitted with a

* Beginners may prefer to fit the flask with a reflux condenser and thus considerably reduce the danger of fire.

reflux condenser (protected by a drying tube containing soda lime), a sealed stirrer (see Kyrides stirrer, Fig. II, 7, 10) and a dropping funnel, are placed 23 g. of clean sodium and 150–200 ml. of sodium-dried xylene. The flask is surrounded by an oil bath, which is heated until the sodium has melted. The stirrer is started and, after the sodium is suitably granulated, the oil bath is removed. When the contents of the flask have cooled to the laboratory temperature, the stirrer is stopped. The xylene may then be decanted, and the sodium washed with two 100 ml. portions of sodium-dried ether to remove traces of xylene as in *Method 1*. Large quantities of "molecular" sodium may be prepared by this method.

7. Sodium amalgam. The amalgam which is generally employed for reductions contains from 1 to 3 per cent. of sodium. Amalgams with a greater sodium content than 1.2 per cent. are solid at the ordinary temperature and can be powdered in a mortar; the 1.2 per cent. amalgam is semi-solid at room temperature but is completely fluid at 50°. Two methods of preparation are available.

Method 1. Nine grams of clean sodium are placed in a 500 ml. conical flask and covered with 20 ml. of dry toluene. The sodium is cautiously melted over a free flame, and the flame is extinguished. 750 g. of mercury are added from a separatory funnel in drops with occasional shaking. During the addition of the first 2–3 ml. of mercury the reaction is extremely vigorous, but subsequently the rate of addition of the mercury may be increased so that the toluene boils continuously. At the end of the reaction, the toluene is allowed to evaporate completely; if any toluene remains, the excess should be decanted. The toluene vapour remaining above the amalgam tends to protect it from the action of the air. The resulting amalgam contains about 1.2 per cent. of sodium. An amalgam of 2 per cent. strength can be prepared by this method (15.2 g. of sodium in 750 g. of mercury); if all the toluene has not evaporated completely before the end of the reaction, it should be decanted before the amalgam solidifies. If necessary, the amalgam is melted on a hot plate and then poured on to a uralite or poilite board, and then pulverised in a mortar* and transferred to a tightly stoppered bottle. The preparation must be carried out in the fume cupboard since mercury vapour is poisonous.

Method 2. The clean sodium (22.8 g.) is placed in a 500 ml. round-bottomed three-necked flask, provided with a dropping funnel (containing 750 g. of mercury) in the central aperture and inlet and outlet tubes for dry nitrogen in the two side apertures. The air is displaced by nitrogen. About 10 ml. of mercury are added and the flask is warmed gently with a free flame until the reaction commences. The flame is then removed and the reaction is maintained by the slow addition of the mercury. When about half the mercury has been introduced, the amalgam will commence to solidify; it should be kept molten by heating with occasional shaking. After the addition of all the mercury, the hot molten amalgam is poured on to a uralite or poilite board, powdered in a mortar and stored as in *Method 1*. Amalgams of 1 and 2 per cent. strength may be prepared similarly.

* The mortar should be provided with a tightly fitting rubber cover to protect the powdered material from oxidation in air.

8. **Sodamide.** This substance is prepared by the reaction between gaseous ammonia and molten sodium :

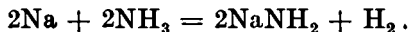

The apparatus consists essentially of a cast iron crucible and cover * or fusion pot in which is placed a nickel crucible or dish. The complete apparatus is illustrated in Fig. II, 50, 1. The fusion pot *A* carries a combined thermometer well *T* and an inlet tube *BCD*, and a wide outlet tube *E*. The thermometer well *T* is closed at the bottom (welded) and projects 6–7 mm. below the wider inlet tube to which it is welded near the top. There is a gland or asbestos-cord packed joint at *F*, held in position by a hexagonal nut ; the nut, fixed firmly in place by means of a wrench so as to make the gas-tight joint, enables the tube *BCD* to be raised or

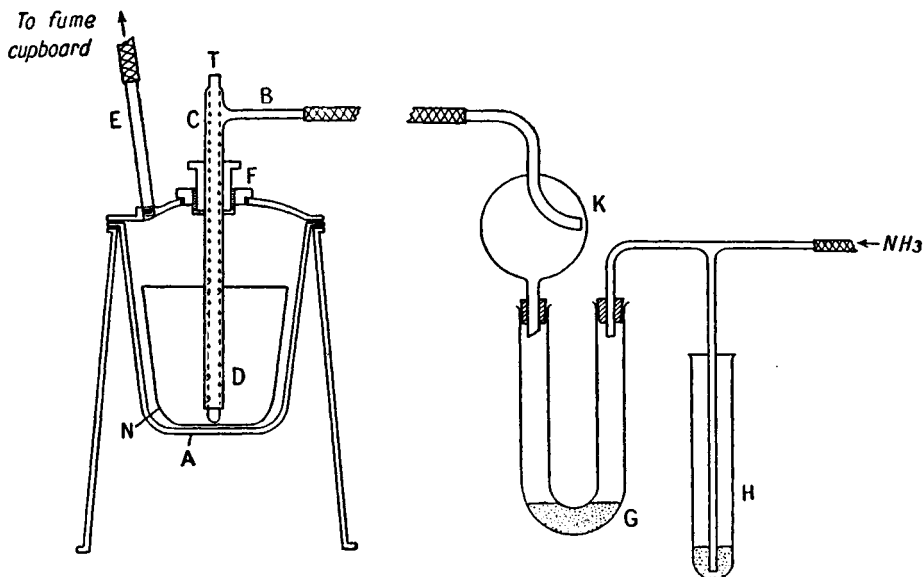

Fig. II, 50, 1.

lowered at will. The tube *B* is connected by rubber tubing (ca. 7 cm.) to a Kjeldahl trap *K* (to prevent mercury passing into *A*) fitted into a U-tube *G* containing just enough mercury to seal the bend (it will serve to indicate the rate of flow of the ammonia), and then to an ammonia cylinder ; *H* is a mercury safety trap to provide for the possibility of the apparatus becoming blocked by solidification of the amide due to an accidental drop of temperature. The apparatus is first completely assembled with the thermometer well in the position shown in the figure : the fusion pot is heated by means of a Fisher or equivalent burner to about 120° for 10 minutes in a slow stream of ammonia ; this will remove traces of moisture from the system. The fusion pot is then allowed to cool to 70–80°, the cover is removed and a 250 ml. nickel crucible *N* is inserted ; the tube *BCD* is raised just above the top of the nickel crucible. The crucible is charged with about 175 g. of clean sodium from which the oxide

* A suitable cast iron crucible and cover, 1 quart capacity, is supplied by the Denver Fire Clay Company, Denver, U.S.A. It can also be made from sheet iron.

coating has been removed, the air is completely displaced by passing ammonia for 10 minutes, and the pot is heated strongly so as to melt the sodium rapidly (5-10 minutes). The inlet tube *BCD* is then pushed through the gland until it rests on the bottom of the crucible and the nut at *F* is tightened so as to make a gas-tight joint. When the temperature is about 320°, the burner is adjusted so as to maintain a temperature of 350-360°. The passage of ammonia is then adjusted so that the flow of bubbles in *G* is just too rapid to count; if the current of gas is too fast, there will be some splashing and much molten sodamide will collect in the iron pot. After 3.5-4 hours, the temperature is reduced to 320° and the cover is lifted to see whether any unreacted sodium remains; inspection is facilitated by a flash lamp, the unreacted metal being visible as a globule floating on the surface of the darker liquid.* If no unreacted sodium remains, the iron crucible is allowed to cool to 230-240° and is maintained at this temperature for 30 minutes to ensure the removal of most of any sodium hydride simultaneously formed in the reaction. The burner is now extinguished, the ammonia stream is shut off and disconnected at *B*. The nickel crucible is immediately removed from the pot with crucible tongs, and the completely molten sodamide is poured into a clean iron tray (*ca.* 14 cm. diameter and 2 cm. high). The iron tray should have been polished with emery cloth or with clean sand, and previously heated to redness to remove moisture. As soon as the sodamide has solidified sufficiently, the iron tray is transferred to a large desiccator to cool.† When cool enough to handle, the tray is inverted over a sheet of heavy clean paper, and the sodamide is removed by tapping the bottom of the pan or, if necessary, broken away from the pan. The sodamide is immediately transferred to wide-mouthed bottles and covered with dry benzene or with dry commercial heptane from petroleum, b.p. 90-100°. The product should be white or nearly white, and the yield is 275 g. It may also be preserved in an atmosphere of nitrogen or dry ammonia in a tightly sealed container.

Sodamide should never be stored in a stoppered bottle from which samples are to be removed intermittently, since dangerous mixtures may result when the substance is exposed for 2-3 days to even limited amounts of air at the ordinary temperature. As a safe practice, sodamide should be used immediately after preparation, and should not be kept longer than 12-24 hours unless it be under an inert solvent. Even small amounts of unused sodamide should be removed from the apparatus in which it was made by washing with methyl or ethyl alcohol. In all cases where a yellowish or brownish colour develops, due to the formation of oxidation

* An alternative method for ascertaining the end of the reaction, which does not involve the removal of the cover, is to conduct the exit gas through an empty wash bottle (to act as a trap in case of "sucking back") and then collect a sample in a test-tube over water. If an inflammable gas (hydrogen) is absent, the reaction may be considered complete. Under no circumstances should the reaction be stopped until all the sodium has completely reacted; too early arrest of the reaction may result in the product containing sodium hydride, which appears to be partially responsible for the explosive properties of the impure substance:

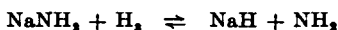

† Another procedure is to allow the sodamide to cool completely in the nickel crucible in a slow stream of ammonia, the tube *BCD* being, of course, raised well above the melt before cooling.

products, the resulting mixture may become highly explosive ; it should be destroyed by covering with benzene or toluene and slowly adding dilute ethyl alcohol with stirring.

Sodamide may be readily pulverised by grinding in a glass mortar under an inert hydrocarbon solvent (benzene, toluene, xylene, etc.).

Sodamide of high purity is available commercially.*

Small quantities of highly reactive sodamide may be prepared from liquid ammonia and sodium as required as follows. In a 500 ml. three-necked flask, having ground joints and equipped with a removable glass stopper, a mercury-sealed stirrer and a reflux condenser with soda-lime guard tube, place 300 ml. of anhydrous liquid ammonia (see Section VI,16). Add just sufficient sodium to the stirred liquid to produce a permanent blue colour, then 0.5 g. of powdered ferric nitrate (to catalyse the conversion of sodium into sodamide), followed by 13.8 g. of clean sodium metal (cut into small pieces) over a period of 30 minutes. When the sodium has been converted into sodamide (as indicated by the change from a blue solution to a grey suspension), evaporate the ammonia by means of a water bath, and add sufficient anhydrous ether through a dropping funnel so that the volume of the liquid remains at about 300 ml. After practically all the ammonia has evaporated, as indicated by the refluxing of the ether, stir the suspension of sodamide and heat under reflux for 5 minutes, and then cool to room temperature. A suspension of 23.4 g. of sodamide in dry ether is thus obtained. The preparation can be completed in 60-75 minutes.

9. Anhydrous sodium acetate. Crystallised sodium acetate, $\text{CH}_3\text{COONa} \cdot 3\text{H}_2\text{O}$, is heated in a casserole or in a shallow iron or nickel dish over a small free flame. The salt first liquefies, steam is evolved and the mass solidifies as soon as most of the water of crystallisation has been driven off. To remove the residual water, the solid is carefully heated with a larger flame, the burner being constantly moved until the solid just melts. Care must be taken that the solid is not overheated ; too strong heating will be recognised by the evolution of combustible gases and charring of the substance. The fused salt is allowed to solidify, and is removed from the vessel whilst still warm with a knife or other convenient object. It is immediately powdered and stored in a tightly stoppered bottle.

If the commercial fused sodium acetate is available, it should be melted and maintained in the fused state for several minutes in order to remove the water absorbed during storage.

10. Anhydrous sodium sulphide. The hydrated salt, $\text{Na}_2\text{S} \cdot 9\text{H}_2\text{O}$, is heated in a Pyrex distilling flask or retort in a stream of hydrogen or of nitrogen until water ceases to be evolved. The solid cake of anhydrous sodium sulphide is removed from the vessel with the aid of a copper wire hook or by other suitable means. No attempt should be made to fuse the sodium sulphide since at high temperatures sodium sulphide is readily oxidised to sodium sulphate.

11. Anhydrous stannous chloride. Crystalline stannous chloride, $\text{SnCl}_2 \cdot 2\text{H}_2\text{O}$, is heated for one hour in an oil bath at 195-200°, the cooled melt is powdered, and kept in a desiccator or in a tightly stoppered bottle.

* For example, from May and Baker Ltd., Dagenham.

The resulting product, although satisfactory in many instances, is not entirely dependable. The following procedure (Stephen, 1930) invariably gives an excellent product. In a 400 ml. beaker are placed 102 g. (89.5 ml.) (1 mole) of redistilled acetic anhydride, and 123 g. of analytical reagent grade stannous chloride dihydrate (0.5 mol) are added whilst the liquid is stirred either manually or mechanically; dehydration is almost instantaneous. The operation should be conducted in the fume cupboard as much heat is evolved and the acetic anhydride may boil. After about one hour, the anhydrous stannous chloride is filtered off on a Buchner or sintered glass funnel, washed free from acetic acid with two 30 ml. portions of anhydrous ether, and dried overnight in a vacuum desiccator. Anhydrous stannous chloride may be kept for an indefinite period in a desiccator; it may also be stored in a tightly stoppered bottle.

The anhydrous compound is not appreciably hygroscopic, is readily soluble in acetone and amyl alcohol, and insoluble in benzene, toluene, xylene and chloroform; it is also readily soluble in absolute methyl or ethyl alcohol, but a trace of water causes immediate hydrolysis with the formation of an opalescent precipitate.

12. Aluminium amalgam. One hundred grams of thin aluminium foil (0.05 mm. thickness) in strips about 15 cm. long and 2.5 cm. wide, loosely folded, are placed in a 3-litre flask and covered with a 10 per cent. solution of sodium hydroxide; the flask is warmed on a water bath until a vigorous evolution of hydrogen has taken place for several minutes (*CAUTION!*). The foil is then thoroughly washed with water and with rectified spirit, the latter operation producing an exceptionally clean surface for amalgamation. Sufficient of a 2 per cent. solution of mercuric chloride is added to cover the aluminium completely and is allowed to act for about 2 minutes; it is then poured off, and the amalgam is washed with water, with rectified spirit, and finally with moist ether. The amalgam is covered with about 1.5 litres of moist ether and is ready for immediate use. If another solvent, *e.g.*, methyl or ethyl acetate, is to be employed in the reduction with moist aluminium amalgam, the ether is, of course, replaced by this solvent.

13. Amalgamated zinc (for Clemmensen reduction). *Method 1.* Two hundred grams of zinc wool are placed in a 2-litre three-necked flask and covered with a 10–15 per cent. solution of sodium hydroxide. The flask is gently warmed on a water bath until hydrogen is vigorously evolved (*CAUTION!*); the sodium hydroxide solution is then immediately poured off (it may be necessary to dilute with water first in order to moderate the vigour of the reaction), and the zinc is washed repeatedly with distilled water until most, if not all, of the sodium hydroxide has been removed. The zinc is then covered with a 1 per cent. solution of mercuric chloride and allowed to stand for 30–60 minutes with occasional shaking. The mercuric chloride solution is then poured off, and the amalgamated zinc is washed twice with distilled water. The amalgamated zinc is then covered with 500 ml. of concentrated hydrochloric acid and 100 ml. of water. The compound to be reduced, about 0.3–0.4 mole, is then added, and the reaction is allowed to proceed whilst a current of hydrogen chloride gas is passed through the liquid.

Method 2 (Martin, 1942). A mixture of 200 g. of zinc wool, 15 g. of mercuric chloride, 10 ml. of concentrated hydrochloric acid and 250 ml. of water is stirred or shaken for 5 minutes. The aqueous solution is decanted, and the amalgamated zinc is covered with 150 ml. of water and 200 ml. of concentrated hydrochloric acid. The material to be reduced, usually about 0.3–0.4 mole, is then added immediately, and the reaction is commenced.

14. Lead dioxide. A convenient method of preparation is to oxidise a plumbous salt in an alkaline medium with a hypochlorite solution :

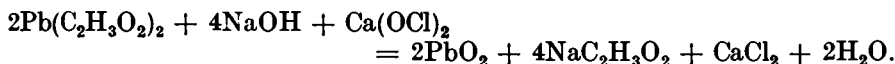

A solution of 20 g. of sodium hydroxide in 180 ml. of water is added slowly and with constant stirring to a solution of 40 g. of lead acetate in 100 ml. of water. 28 G. of bleaching powder are shaken up with 400 ml. of water, and the filtered solution is added with constant stirring to the alkaline solution of lead acetate. The mixture is heated slowly to the boiling point and then boiled for a few minutes. A small portion is filtered off and tested for completeness of the oxidation by adding a few drops of hypochlorite solution ; if oxidation is incomplete, a further 20 ml. of filtered bleaching powder solution is added and the solution boiled again. The process is repeated until all the plumbous salt is oxidised. The precipitate is allowed to settle and washed five times by decantation. It is then vigorously stirred with 100 ml. of 6*N* nitric acid to remove any calcium plumbate or plumbous hydroxide, and again washed with water by decantation. Finally it is filtered off on a Buchner funnel and dried. The yield is nearly quantitative.

15. Lead tetracetate. Red lead is warmed with acetic acid in the presence of sufficient acetic anhydride to combine with the water formed :



The filtrate, which contains lead acetate, may be treated with chlorine :

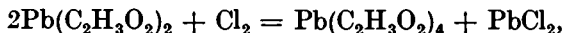

and the resulting lead tetracetate separated from the accompanying lead chloride by recrystallisation from glacial acetic acid.

A mixture of 550 g. of glacial acetic acid and 185 g. of acetic anhydride is placed in a 1-litre three-necked flask provided with a thermometer and a mercury-sealed stirrer. The liquid is vigorously stirred, heated to 55–60°, and 300 g. of dry red lead powder are added in portions of 15–20 g. A fresh addition is made only after the colour due to the preceding portion has largely disappeared. The temperature should not be allowed to rise above 65°. Towards the end it may be necessary to warm the flask cautiously to about 80° in order to complete the reaction. At the end of the reaction, the thick and somewhat dark solution is cooled, and the precipitated lead tetracetate is filtered off (the mother liquor, *M*, is put aside) and washed with glacial acetic acid. The crude product, without being dried, is dissolved in hot glacial acetic acid containing a little acetic anhydride, the solution treated with a little decolourising carbon, filtered through a hot water funnel, and cooled. The colourless crystalline

product is filtered off and dried in a vacuum desiccator over potassium hydroxide pellets. The yield is about 150 g.

A further 100 g. of lead tetracetate may be obtained from the mother liquor (*M*) by returning it to the original flask, heating to about 75° with stirring, and passing a stream of dry chlorine into it. When the reaction is complete, a few grams of decolourising carbon are added, the mixture is maintained at 75° for a few minutes, and the hot suspension is filtered with suction through a preheated Buchner funnel. The residue, consisting largely of lead chloride, is washed with hot glacial acetic acid. The filtrate, on cooling, deposits lead tetracetate in colourless needles; it is collected and dried as described above. Although contaminated with a little (< 5 per cent.) lead chloride, the resulting lead tetracetate is satisfactory for most purposes; if required perfectly pure, it should be recrystallised.

16. Selenium dioxide. The compound is conveniently prepared by the oxidation of selenium with nitric acid, followed by dehydration of the selenious acid thus formed by cautious heating :

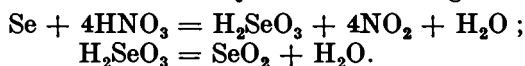

The preparation must be conducted in a fume cupboard provided with a good draught, since selenium compounds are poisonous. One hundred grams (70·5 ml.) of concentrated nitric acid are heated in a 1-litre Pyrex beaker on a hot plate, and 50 g. of powdered selenium are cautiously added in portions of about 5 g. The frothing should be allowed to subside after each addition before more selenium is introduced into the acid. The dissolution of the selenium can be accelerated by mechanical stirring with a glass stirrer; this will break the foam produced. When all the selenium has dissolved (if this is not the case, a little more nitric acid should be added), the solution is transferred to a large evaporating dish or casserole and heated on a hot plate at a temperature not exceeding 200° until the selenious acid is completely dehydrated and the residue appears dry. The resulting crude selenium dioxide must be purified.* Either of the following procedures may be used.

(i) The crude selenium dioxide is treated with sufficient water to dissolve it, and, after filtering from any insoluble matter, 10 ml. of concentrated hydrochloric acid are added. A slow stream of sulphur dioxide is passed into the solution until heat is no longer evolved (2–5 hours); the reaction is complete when the red precipitate settles to the bottom in a coherent mass. Upon standing for a few hours or, better, on boiling for a short time, the red selenium passes into a pasty grey form, which eventually becomes brittle. The precipitated selenium is filtered off, ground in a mortar, washed free from acid, dried, and finally heated over a Bunsen burner. The cold mass is then dissolved in nitric acid and evaporated as before. To make certain that all the nitric acid has been completely removed, the residue is dissolved in 70–80 ml. of water and evaporated again. White selenium dioxide is obtained in about 90 per cent. yield.

* In view of the small difference in cost between selenium and selenium dioxide, the preparation of any quantity of the latter from selenium is hardly worth while. It is better to purify commercial selenium dioxide.

(ii) The crude selenium dioxide is placed in a large porcelain or silica crucible, which is supported in a hole made in a stout asbestos board. Two nested funnels are inverted over the crucible, the larger funnel having a plug of glass wool in the neck. The crucible is heated with a small flame until sublimation is complete (about 25 minutes). When the crucible has cooled, the resublimed selenium dioxide (in long needle-like crystals) is removed and stored in a tightly stoppered bottle. The yield is about 63 g.

Note.

Extreme care should be taken when working with selenium dioxide because of its poisonous properties.

17. Silver nitrite. Warm concentrated solutions of silver nitrate (containing 48 g. of AgNO_3) and potassium nitrite (containing 30 g. of KNO_2) are mixed, and the mixture is allowed to cool. The silver nitrite which separates is filtered off and washed with water. It may be recrystallised from water at 70° , and is dried either in a vacuum desiccator or in an air oven at about 40° ; the yield is about 90 per cent. Silver nitrite should be stored in an tightly-stoppered amber bottle.

18. Zinc cyanide. Solutions of the reactants are prepared by dissolving 100 g. of technical sodium cyanide (97–98 per cent. NaCN) in 125 ml. of water and 150 g. of anhydrous zinc chloride in the minimum volume of 50 per cent. alcohol (1). The sodium cyanide solution is added rapidly, with agitation, to the zinc chloride solution. The precipitated zinc cyanide is filtered off at the pump, drained well, washed with alcohol and then with ether. It is dried in a desiccator or in an air bath at 50° , and preserved in a tightly stoppered bottle. The yield is almost quantitative and the zinc cyanide has a purity of 95–98 per cent. (2). It has been stated that highly purified zinc cyanide does not react in the Adams' modification of the Gattermann reaction (compare Section IV, 121). The product, prepared by the above method is, however, highly satisfactory. Commercial zinc cyanide may also be used.

Notes.

(1) The only important precaution in this preparation is to ensure an excess of zinc chloride over sodium cyanide. If the latter is in excess, the zinc cyanide generally precipitates as a sticky mass, which is difficult to filter and unsatisfactory for the preparation of hydroxy-aldehydes.

(2) The cyanide content may be determined by titration with standard silver nitrate solution.*

II,51.

CALCULATION OF YIELDS

The theoretical yield in an organic reaction is the amount which would be obtained under ideal conditions if the reaction had proceeded to completion, *i.e.*, if the starting materials were entirely converted into the desired product and there was no loss in isolation and purification. The yield (sometimes called the actual yield) is the amount of pure product which is actually isolated in the experiment. The percentage yield is

* For a convenient method, see Vogel, *Text Book of Quantitative Inorganic Analysis: Theory and Practice*, Second Edition, 1951, p. 263 (Longmans, Green and Co. Ltd.).

computed from the ratio between the weight of the pure product obtained and the weight calculated, *i.e.*,

$$\text{Percentage yield} = \frac{\text{Actual yield}}{\text{Theoretical yield}} \times 100$$

In the calculation of yields, the term mol is usually employed. A mol (or mole or gram molecule) is equal to the molecular weight in grams. Hence the number of mols is equal to the weight of the substance in grams divided by the molecular weight.

Let us suppose it is desired to calculate the theoretical yield of ethyl maleate when 33 g. of silver maleate, suspended in dry ether, are treated with the calculated quantity of ethyl iodide (31.2 g.).

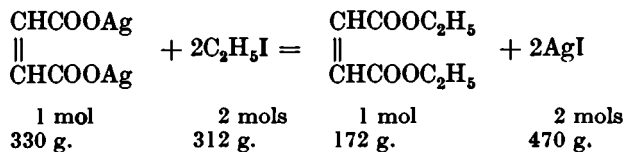

From the equation representing the chemical reaction involved, it is evident that 330 g. of silver maleate will theoretically react with 312 g. of ethyl iodide in ethereal solution to produce 172 g. of ethyl maleate. It follows, therefore, that 33 g. (0.1 mol) of silver maleate will react with 31.2 g. (0.2 mol) of ethyl iodide to give a theoretical yield of 17.2 g. (0.1 mol) of ethyl maleate. In practice, the actual yield found for these quantities is of the order of 16.0 g.; the percentage yield is therefore $(16.0/17.2) \times 100 = 93$ per cent.

After a little experience in the organic chemistry laboratory, the student will soon find that the yields frequently do not approach the theoretical values. This may be due to one or more of the following causes:—

(i) The reaction may not proceed to completion because the reverse reaction may occur under the given conditions and a state of equilibrium is established.

(ii) A portion of some of the reactants may be consumed in some alternative reaction ("side reaction"), which leads to products other than those desired; or, one or some of the components may be lost, *e.g.*, by volatilisation (because of its low boiling point or it may be carried away by gases evolved in the reaction) in spite of most careful manipulation.

(iii) Some of the desired product may be lost by further chemical change before it can be isolated.

(iv) Mechanical losses incident upon separating and purifying the product.

(v) The purity of some of the reagents may be uncertain, *e.g.*, they may contain varying amounts of water in their commercial forms.

In order to obtain an improved yield of the desired product, an excess over the proportion required by the chemical equation of one (or more) of the reactants is often used. In a given preparation, the selection of the reagent to be employed in excess will depend upon a number of factors; these include its relative cost and ease of removal after the reaction, and

its influence upon reducing the extent of "side reactions." Some examples follow, and these will incidentally illustrate the method of calculation of the percentage yield in such cases.

Two reactants. In the preparation of *n*-hexane, 61.5 g. of *n*-propyl bromide were treated with 23 g. of sodium and 18.0 g. of *n*-hexane were ultimately isolated.

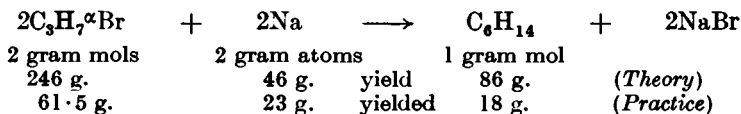

It is evident from the equation that the sodium is used in excess. Actually 61.5 g. of *n*-propyl bromide is 0.5 gram mol; this will react with 0.5 gram atom or 11.5 g. of sodium, so that 100 per cent. excess was actually employed. The theoretical yield of *n*-hexane will be 0.25 gram mol or 21.5 g., since 2 mols of *n*-propyl bromide give 1 mol of *n*-hexane. The actual yield was 18 g., hence the percentage yield is $(18/21.5) \times 100 = 84$ per cent.

n-Butyl acetate was prepared by refluxing a mixture of 37 g. of *n*-butyl alcohol, 90 g. of glacial acetic acid and 2 g. of concentrated sulphuric acid, pouring into excess of water, washing the upper layer with saturated sodium bicarbonate solution, drying and distilling; the yield of ester was 54 g. Here the sulphuric acid acts as a catalyst and therefore does not appear in the equation.

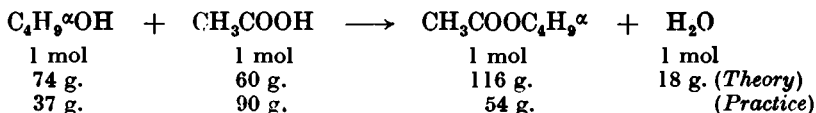

The reactants are in the proportion of $37/74 = 0.5$ mol to $90/60 = 1.5$ mol, and it is therefore clear that the acetic acid is present in 200 per cent. excess. The theoretical yield must therefore be computed on the basis of the weight of *n*-butyl alcohol employed, and will be 0.5 mol or 58 g. The percentage yield is accordingly $(54/58) \times 100 = 93$ per cent.

Three reactants. Ethyl iodide may be prepared by the interaction between iodine, ethyl alcohol and red phosphorus. The quantities employed and the yield obtained in a particular experiment are given below the equation.

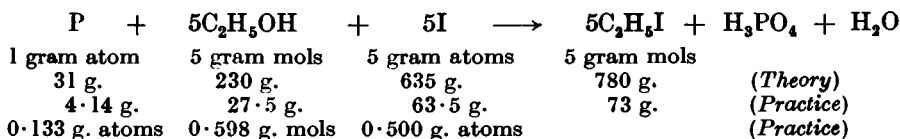

To decide which component should be employed for the calculation of the yield of ethyl iodide, the weights of the reactants are first divided by the appropriate atomic or molecular weight in order to obtain the number of gram atoms or gram mols actually used. The equation shows that the alcohol and iodine react in the ratio of 5 : 5 or 1 : 1. Inspection of the results clearly shows that the alcohol is present in about 20 per

cent. excess, and on this basis 33 per cent. excess of phosphorus is employed. The yield is accordingly calculated from the weight of iodine (which, incidentally, is the most expensive component). The theoretical yield from 0.500 gram atom of iodine is 0.500 gram mol of ethyl iodide (since 5 gram atoms of iodine give 5 gram mols of ethyl iodide) or 78 g. The percentage yield is $(73/78) \times 100 = 94$ per cent.

II.52. GENERAL INSTRUCTIONS FOR WORK IN THE LABORATORY

Before commencing any preparation in the laboratory, the student must carefully study the complete details of the experiment as well as the underlying theory. Not only should he have a clear idea of what is to be done and how he proposes to do it, but at all times he should be ready to give an intelligent reply to questions as to what he is doing and why he is doing it. The exercise may then be said to be truly scientific and not of the cookery book-recipe type. The student will soon realise that quite a number of experiments require somewhat prolonged periods of heating, refluxing or standing during which the whole of his attention is not required. A keen worker will make use of this time, *e.g.*, in writing up reports, planning other experiments, and cleaning and drying apparatus.

The results of all experiments must be recorded in a stiff-covered note-book (a loose-leaf note-book is not admissible) at the time the observations are made. If the experiment calls for records of weights, volumes, or other numerical results, these must be entered directly into the note-book and not on scraps of paper; the latter are liable to be lost and their use tends to develop untidy and slack habits on the part of the student. When the experiment is complete, the student should calculate the yield and then submit the laboratory note-book and the product, suitably labelled (including the melting or boiling point range and the weight), to the demonstrator or instructor. It is a good plan to submit at the same time a short summary of the results (name of preparation, yield, m.p. or b.p. range, etc.) on a sheet of paper to the demonstrator; the sheet will be retained for record purposes. If the work is approved, the student is permitted to proceed with the next experiment in the course.

Students are generally permitted to retain small specimens of their preparations: the main bulk, unless it is required for a succeeding preparation, must be returned to the chemical store. Solids may be kept in small specimen tubes and appropriately labelled (name of compound, m.p., details concerning method of purification, and date); if the compound exhibits signs of being deliquescent or hygroscopic, or otherwise affected by contact with air, the cork should be "waxed over" by painting it completely with molten paraffin wax. Liquids may be sealed off in specially prepared tubes. A short length of moderately thick-walled glass tubing is cleaned by immersion in a narrow cylinder containing "chromic acid cleaning mixture" (compare Section II,2), thoroughly washed with distilled water, followed by a little acetone, and is then dried by passing a current of warm air through it. One end is then sealed off in the blowpipe flame as in Fig. II, 52, 1, a; students

may find it easier to blow a small bulb at the end *A*, thus ensuring uniform thickness of the glass wall. A constriction *B*, about 15–20 mm. long, is then made by carefully rotating the tube in a small blowpipe flame; it is important that the wall of the tubing remains uniformly thick at this point. Some liquid is introduced into the portion *BC* (by means of a clean drawn-out tube or a dropper, if necessary), the end *C* attached to a water pump through a calcium chloride or cotton wool guard tube, and the inclined tube is partially exhausted. Upon removing the pump connexion at *C*, the liquid will flow into the lower part of the tube. This process is repeated until a sufficient quantity of the liquid has entered *AB*. The tube is then quickly sealed off at *B* with a minute flame. Large quantities of low boiling point liquids or liquids which are affected by the air may be stored in special glass ampoules (Fig. II, 52, 1, *b*), which can be purchased; such ampoules may be conveniently filled by introducing a drawn-out test-tube into the neck. When filled with liquid, they are sealed off in the manner described above.

A good indication of the student's technique will be apparent from the appearance of the working bench. The top of the bench should always be kept clean and dry; this can easily be done if a wet and a dry rag are kept at hand. Apparatus not immediately required should be kept as far as possible in a cupboard beneath the bench; if it must be placed on the bench, it should be arranged in a neat and orderly manner. All apparatus should be washed immediately after use and placed in a position to drain: at the first opportunity, the apparatus should be dried. It must be emphasised that as a general rule a deposit of dirt or tar is more easily removed when it is freshly formed; a suitable cleaning agent can usually be found while one still remembers the nature of the material or the circumstances attending its formation. It is hardly necessary to add that solid waste and filter papers must not be thrown into the sink, and that all operations requiring the handling of unpleasant and noxious materials should be carried out in the fume cupboard ("hood").

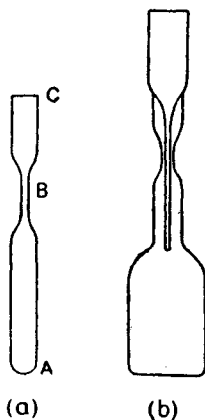

Fig. II, 52, 1.

II,53.

SAFETY PRECAUTIONS

The operations of practical organic chemistry are attended by certain dangers, the chief of which is that from fire since many of the liquid chemicals and the solvents are highly inflammable substances. Highly volatile liquids, such as diethyl ether, carbon disulphide, acetone and benzene, should never be handled in the vicinity of a free flame (compare full discussion in Section II,14); the vapours can "flow" along the top of a bench (particularly if assisted by a draught of air), become ignited by a flame at some distance and strike back to ignite the parent liquid. A common mistake by beginners is to heat an inflammable liquid in an open vessel over a free flame. The correct, and the only permissible, procedure is to heat the liquid in a vessel provided with a reflux condenser on a water or steam bath or upon an approved electric hot plate or by

immersion in a bath of hot water with the burner extinguished. Volatile solvents must be removed by distillation and not by evaporation. Recovered solvents should be poured into the special bottles provided for them in the laboratory; they should not be poured down the sink nor into the waste boxes.

If a fire should occur, all flames in the vicinity should be extinguished and all inflammable materials removed. A small fire may be smothered with a wet towel or by throwing sand upon it. For a large fire, the laboratory fire extinguisher (CO₂, etc.) should be used. The well-known "Pyrene" fire extinguisher, containing carbon tetrachloride, should not be employed in the confined space of the laboratory since the highly poisonous phosgene may be formed; furthermore, an explosion may occur if it comes into contact with sodium. If the clothing of a fellow student should catch fire, he (she) should be wrapped in the special fire-proof blanket or, if this is not available, in a heavy coat; he (she) should not be allowed to run about and fan the flames.

Other sources of hazard arise from the handling of such chemicals as concentrated acids, alkalis, metallic sodium and bromine, and in working with such extremely poisonous substances as sodium and potassium cyanides. The special precautions to be observed will be indicated, where necessary, in the experiments in which the substances are employed, and will also be supplied by the demonstrator. The exercise of obvious precautions and cautious handling will in most cases reduce the danger to almost negligible proportions. Thus, if concentrated sulphuric acid should be accidentally spilled, it should be immediately washed with a liberal quantity of water or of a solution of a *mild* alkali.

Finally, the student should familiarise himself with the contents of the Section in the Appendix upon *Laboratory Accidents*, with the position of the fire extinguisher, buckets of sand, first aid cabinet, and the fireproof blanket.

APPARATUS WITH INTERCHANGEABLE GROUND GLASS JOINTS

II,54. INTERCHANGEABLE GROUND GLASS JOINTS

The commercial development of glass manipulation, coupled with the use of glasses of low expansion coefficient, has made available truly interchangeable ground glass joints at moderate cost. These, fitted to apparatus of standard and special types marketed by various firms,* have made possible a new outlook on the assembly of apparatus required for practical organic chemistry and, indeed, of many other branches of practical chemistry. It is believed that if the merits of ground glass joint apparatus, as well as the actual apparatus available, were more widely known, glassware with interchangeable ground joints would find

* For example from: Quickfit and Quartz Ltd.; Loughborough Glass Co. Ltd.; A. Gallenkamp and Co. Ltd.; Jencons (Scientific) Ltd.; James J. Jobling and Co. Ltd.; Scientific Glass Apparatus Co. Inc.; Corning Glass Works. For precise details concerning joint size and specialised apparatus, the reader should consult the latest catalogues of the various manufacturers: the most comprehensive catalogues are those of Quickfit and Quartz and of Scientific Glass Apparatus Co.

a place in every laboratory, even for the most simple operations, such as distillation and refluxing. The advantages include :—

1. No corks or rubber stoppers are, in general, required. Contamination or discolouration due to these is therefore avoided. Occasionally, a small rubber stopper may be employed, *e.g.*, for the insertion of a thermometer, but, should the very small surface of rubber thus exposed to the action of the organic vapours be undesirable, a thermometer with a ground glass cone can be used.

2. The selection, boring, and fitting of corks is largely eliminated, thus resulting in a considerable saving of time.

3. Corrosive liquids and solids (acids, acid chlorides, *etc.*) are easily manipulated, and no impurities are introduced into the product from the apparatus.

4. Apparatus may be rapidly assembled. As all joints of the same size are interchangeable, a broken part can be rapidly replaced with every confidence that it will fit well.

5. By employing a number of comparatively simple units, most of the common operations of organic chemistry may be carried out.

6. Wider passages are provided for vapours and the comparatively narrow tubes, which are usually fitted through holes bored in cork or rubber stoppers, are absent; this considerably diminishes danger in violent reactions and also tends to give better results in distillation under reduced pressure as well as diminishing the hazard of "choking."

The interchangeability of joints is ensured by the use of a standard taper of 1 in 10 on the diameter (*i.e.*, a cone of semi-angle $2^{\circ} 51' 45''$) and limited tolerances on the cone semi-angles and the dimensions of the joints. The specifications for joints in Great Britain and the U.S.A. differ. It will accordingly be necessary to treat each separately.

The interchangeable conical ground joints in Great Britain conform to the specification of the British Standards Institution, B.S.S. No. 572 of 1950.* It should be noted that the term "cone" is used for the part which is inserted and the term "socket" for the part into which the "cone" is inserted. The Series A (full length) has been discarded in the 1950 specification since it is considered that Series B is generally more useful in the construction of common laboratory apparatus. Nevertheless, details of the Series A (conforming to the now obsolete B.S.S. No. 572 of 1934) are included in Table II, 54.1, largely for comparison with the U.S. specification. The joints of all the Series have the same diameter at the larger end, but have different lengths of engagement. There are some small variations in length from the 1934 specification but the diameter at the larger end is unchanged for all joints; hence cones or sockets complying with the B.S.S. 1950 specifications may be used interchangeably with those of the B.S.S. 1934 specification having the same letter and number.

An alternative method for naming the size of the joint, which is sometimes used by manufacturers, consists in assigning a number to the joint diameter at the wide end, thus :—

<i>Joint size</i>	.	.	7	10	12	14	16	19	24	29	34	40	45	50	55
<i>Joint number</i>	.	.	00	0	12	1	16	2	3	4	5	6	7	8	9

* Obtainable from the British Standards Institution, British Standards House, 2 Park St., London, W. 1.

TABLE II, 54.1. DIMENSIONS OF BRITISH STANDARD INTERCHANGEABLE GROUND GLASS JOINTS

SIZE NUMBER OF JOINT	EXTERNAL DIAMETER OF SMALLER END OF CONE (MM.)	INTERNAL DIAMETER OF SOCKET (MM.)	LENGTH OF GROUND ZONE (MM.)	SIZE NUMBER OF JOINT	EXTERNAL DIAMETER OF SMALLER END OF CONE (MM.)	INTERNAL DIAMETER OF LARGER END OF SOCKET (MM.)	LENGTH OF GROUND ZONE (MM.)
<i>Series A</i>				<i>Series B</i>			
A.5	3.0	5.0	20	B.5	3.5	5.0	15
A.7	5.0	7.5	25	B.7	5.7	7.5	18
A.10	7.0	10.0	30	B.10	7.8	10.0	22
A.12	9.25	12.5	32.5	B.12	10.1	12.5	24
A.14	11.0	14.5	35	B.14	12.0	14.5	25
A.16	12.5	16.0	35	B.16	13.4	16.0	26
A.19	15.0	18.8	38	B.19	16.0	18.8	28
A.24	20.0	24.0	40	B.24	21.0	24.0	30
A.29	25.0	29.2	42	B.29	26.0	29.2	32
A.34	30.0	34.5	45	B.34	31.1	34.5	34
A.40	35.0	40.0	50	B.40	36.4	40.0	36
A.45	40.0	45.0	50	B.45	41.2	45.0	38
A.50	45.0	50.0	50	B.50	46.0	50.0	40
A.55	50.0	55.0	50	B.55	50.8	55.0	42
A.60	55.0	60.0	50	B.60	55.6	60.0	44
<i>Series C</i>				<i>Series D</i>			
C.5	4.2	5.0	8	D.19	18.0	18.8	8
C.7	6.4	7.5	11	D.24	23.1	24.0	9
C.10	8.7	10.0	13	D.29	28.2	29.2	10
C.12	10.9	12.5	16	D.34	33.4	34.5	11
C.14	12.8	14.5	17	D.40	38.9	40.0	11
C.16	14.3	16.0	17	D.45	43.8	45.0	12
C.19	16.9	18.8	19	D.50	48.8	50.0	12
C.21	19.5	21.5	20				
C.24	22.0	24.0	20				
C.26	24.4	26.5	21				
C.29	27.0	29.2	22				
C.32	29.7	32.0	23				
C.34	32.1	34.5	24				

TABLE II, 54.2. DIMENSIONS OF U.S.A. STANDARD INTERCHANGEABLE GROUND GLASS JOINTS

STANDARD JOINT SIZE NUMBER	APPROXIMATE DIAMETER AT SMALL END (MM.)	COMPUTED DIAMETER AT LARGE END OF GROUND ZONE (MM.)	APPROXIMATE LENGTH OF GROUND ZONE (MM.)
<i>Full length Joints</i>			
5/20	3	5.0	20
7/25	5	7.5	25
10/30	7	10.0	30
12/30	9	12.0	30
14/35	11	14.5	35
19/38	15	18.8	38
24/40	20	24.0	40
29/42	25	29.2	42
34/45	30	34.5	45
40/50	35	40.0	50
45/50	40	45.0	50
50/50	45	50.0	50
55/50	50	55.0	50
60/50	55	60.0	50
71/60	65	70.0	60
<i>Medium length Joints</i>			
5/12	3.8	5.0	12
7/15	6.0	7.5	15
10/18	8.2	10.0	18
12/18	10.2	12.0	18
14/20	12.5	14.5	20
19/22	16.6	18.8	22
24/25	21.5	24.0	25
29/26	26.6	29.2	26
34/28	31.7	34.5	28
40/35	36.5	40.0	35
<i>Short length Joints</i>			
10/10	9.0	10.0	10
12/10	11.0	12.0	10
14/10	13.5	14.5	10
19/10	17.8	18.8	10
24/12	22.8	24.0	12
29/12	28.0	29.2	12
34/12	33.3	34.5	12
40/12	38.8	40.0	12
45/12	43.8	45.0	12
50/12	48.8	50.0	12
55/12	53.8	55.0	12
60/12	58.8	60.0	12
71/15	69.5	71.0	15

The series letter should also be specified: thus *B2* refers to *B19*. This system must now be regarded as obsolete.

In the U.S.A., interchangeable ground glass joints conform to the specifications of the Bureau of Standards ("Interchangeable Ground Glass Joints, Stopcocks and Stoppers," Commercial Standard CS21-39).^{*} The taper is 1 in 10, *i.e.*, 1 ± 0.06 mm. per cm. length on the diameter and is represented by the symbol $\$$. There are three sizes of joints, *viz.*, full length, medium length, and short length. The size of joint is designated by two figures, the first indicating the *approximate* diameter (in mm.) of the larger end (*i.e.*, to the nearest whole number) and the second giving the length of the ground surface. Thus $\$ 19/38$ refers to a ground surface 18.8 mm. in diameter and 38 mm. in length. The various sizes of joints are collected in Table II, 54.2.

II,55. TYPES OF GROUND GLASS JOINTS

All ground glass joints should be constructed of a high resistance glass, such as Pyrex. The most common form is shown in Fig. II, 55, 1, and this is the type largely encountered in practice. Fig. II, 55, 2 is

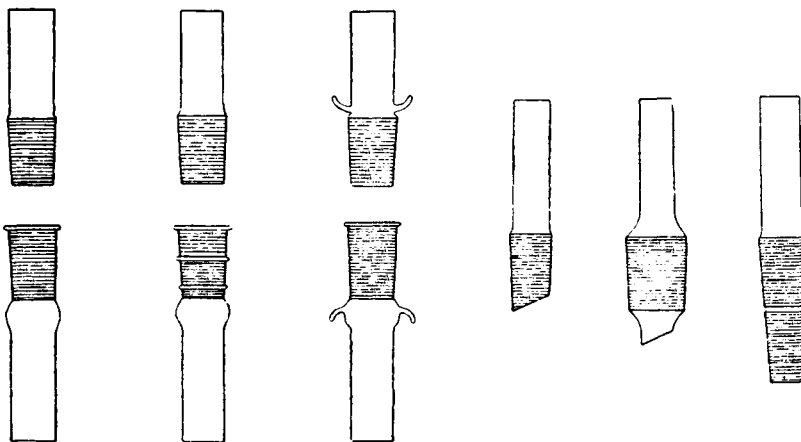

Fig.
II, 55, 1.

Fig.
II, 55, 2.

Fig.
II, 55, 3.

Fig.
II, 55, 4.

Fig.
II, 55, 5.

Fig.
II, 55, 6.

similar but has reinforcing glass bands about the female joint; it is claimed that these add greatly to the mechanical strength of the walls.

Fig. II, 55, 3 depicts a ground joint with glass hooks, to which light springs may be attached. Figs. II, 55, 4 and II, 55, 5 are drip cones for condensers and the like; the latter is generally employed for joints larger than 29 mm. in diameter, the orifice being reduced to about 18 mm. Fig. II, 55, 6 is a double-cone joint in which two cones, *e.g.*, *B19* and *B24*, are made like a single joint; this is valuable as it saves the use of an adaptor.

^{*} Obtainable from Superintendent of Documents, Washington, D.C.

The spherical joint or semi-ball joint or ball and socket joint is illustrated in Fig. II, 55, 7, which includes one type of special clamp for holding the two halves of the joint together. This connexion cannot freeze

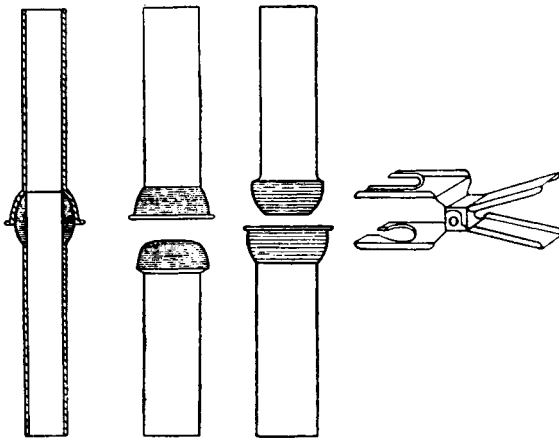

Fig. II, 55, 7.

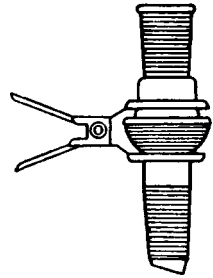

Fig. II, 55, 8.

or stick (as conical ground joints sometimes do) and it introduces a degree of flexibility into the apparatus in which it is used. The area of contact between the ground surfaces is relatively small so that the joints are not intended to provide for considerable angular deflection. The main application is in conjunction with conical joints rather than as a substitute for them. The conical-spherical adapters shown in Fig. II, 55, 8 provide a means of inserting a spherical joint whilst retaining the standard conical joint principle. Some sizes of spherical joints (semi-ball connections) are collected in Tables II, 55.1 and II, 55.2.

TABLE II, 55.1. DIMENSIONS OF SPHERICAL JOINTS *

SIZE DESIGNATION	NOMINAL DIAMETER OF GROUND HEMISPHERE	NOMINAL DIAMETER AT UPPER END OF GROUND ZONE	NOMINAL BORE
2/12	1/2"	12 mm.	2 mm.
5/12	1/2"	12 mm.	5 mm.
9/18	3/4"	18 mm.	9 mm.
15/28	1 1/8"	28 mm.	15 mm.
20/35	1 3/8"	35 mm.	20 mm.
25/40	1 1/2"	40 mm.	25 mm.
35/40	2"	50 mm.	35 mm.

* These dimensions were supplied by Quickfit and Quartz Ltd.

TABLE II, 55.2. DIMENSIONS OF SEMI-BALL CONNECTIONS *

SEMI-BALL SIZE	BALL DIAMETER mm.	TUBE, BORE mm.	SEMI-BALL SIZE	BALL DIAMETER mm.	TUBE, BORE mm.
12/2	12	2	28/12	28	12
12/3	12	3	28/15	28	15
12/5	12	5	35/20	35	20
18/7	18	7	35/25	35	25
18/9	18	9	40/25	40	25
28/11	28	11	50/30	50	30

For most operations of practical organic chemistry, the joint illustrated in Fig. II, 55, 1 is quite satisfactory, but the simple modifications already described are used where necessary. Experiments in Great Britain have shown that the *B* Series of connections, which have the same top diameter as the obsolete *A* Series (B.S.S. No. 572 of 1934 : see Table II, 54.1) or the current U.S. "full-length joints" but a shorter length of engagement, are the most convenient for general use. The *B* Series will accordingly be used in the description of most of the apparatus in the succeeding Sections. There is no practical difficulty in interchanging *A* and *B* joints ; the lengths of engagement may differ, but this will affect only the appearance of the apparatus and not its utility.

II,56. APPARATUS WITH INTERCHANGEABLE GROUND GLASS JOINTS SUITABLE FOR GENERAL USE IN PREPARATIVE ORGANIC CHEMISTRY

Flasks. Round-bottomed, flat-bottomed, conical (Erlenmeyer) and bolt-head flasks up to a capacity of 2-3 litres are generally fitted with a *B24* socket ; † those from 5 to 100 ml. are available with a *B14* or *B19* (from 25 ml.) socket. Round- and flat-bottomed flasks exceeding 1 litre in capacity are supplied with *B34* necks. Whilst all sizes of sockets can be obtained from the manufacturers, it is usually convenient to limit the socket sizes to a small number (say, *B14*, *B19*, *B24* and *B34*), thus permitting interchangeability with the minimum number of adapters.

Stoppers. Those fitted with *B14*, *B19*, and *B24* cones are useful sizes. Stoppers with flat heads are to be preferred, since they may be stood on end when not in use, thus avoiding contamination of the ground surface. An additional refinement is the provision of a finger grip as in Fig. II, 56, 1.

Reduction adapters. These may be employed to connect condensers, still-heads, etc. to flasks, extraction apparatus and the like. Numerous combinations (Fig. II, 56, 2) are, of course, possible, but the commonest sizes are : socket *B14* to cone *B19* or *B24* ; socket *B19* to cone *B24*, *B29*

* These dimensions were taken from U.S.A. sources ; cf. Scientific Glass Apparatus Catalogue, J—52 of 1952.

† Reference will be made to current practice in Great Britain ; the corresponding sizes of joints and sockets available in the U.S.A. will be found in, for example, the catalogues of the Scientific Glass Apparatus Co. Inc. and of the Corning Glass Works.

or *B34* ; socket *B24* to cone *B29* or *B34* ; socket *B29* to cone *B34*. Fig. *II, 56, 3* represents the Bushing type of adapter, which is much shorter than the above and permits of more compact assemblies. It must be emphasised, however, that in a well-designed assembly of apparatus, the number of adapters should be reduced a minimum and, best of all, completely eliminated.

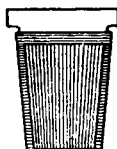
Fig. *II, 56, 1*.Fig. *II, 56, 2*.Fig. *II, 56, 3*.Fig. *II, 56, 4*.

Expansion adapters (Fig. *II, 56, 4*). Common sizes are socket *B19*, cone *B14* ; socket *B24*, cone *B19* ; socket *B29*, cone *B19* or *B24* ; socket *B34*, cone *B19*, *B24* or *B29*.

Distillation heads (or still heads). Fig. *II, 56, 5* is a *bend* ("knee tube"), which is frequently employed for distillation. Convenient sizes are : bottom cone *B19*, *B24*, *B29* or *B34* ; side cone *B19* or *B24*.

Fig. *II, 56, 5*.Fig. *II, 56, 6*.Fig. *II, 56, 7*.

Fig. *II, 56, 6* is a *simple distillation head* ; when this is fitted into a flask with a ground glass socket, the assembly is virtually a distillation flask. The bottom cone is usually *B19*, *B24* or *B29* ; the side cone is generally *B19* but may be *B24* ; the thermometer socket is *B14*. For many purposes, a thermometer is fitted into a one-hole rubber stopper of correct taper and then inserted into the *B14* socket ; the area of rubber which is exposed to the action of the organic vapour is relatively so small that the amount of contamination thus introduced is negligible. If, however, all rubber stoppers must be absent because of the highly corrosive character of the vapour, a thermometer with a *B14* cone is employed. It is important to have the thermometer of the same glass as the distillation head, otherwise difficulties may arise owing to the different expansion coefficients of the two kinds of glass.

Fig. *II, 56, 7* is a *Claisen distillation head*. The lower cone is usually *B19* or *B24* and the side cone is generally *B19* (sometimes *B24*) ; the sockets

are *B14*. A modification is illustrated in Fig. II, 56, 8; here the left-hand socket is replaced by a narrow opening for the insertion of a capillary for use in reduced pressure distillation, etc.

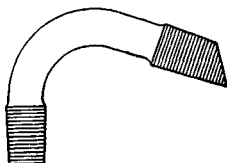
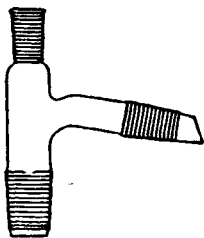
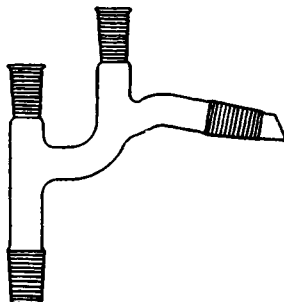
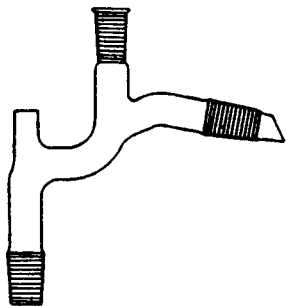

Fig. II, 56, 8.

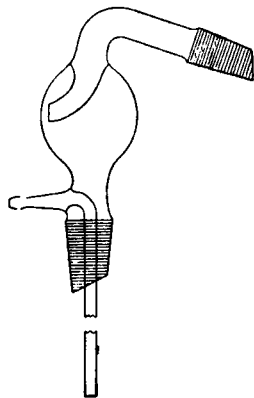

Fig. II, 56, 9.

Fig. II, 56, 9 depicts a *splash head* with a pear-shaped bulb and vertical delivery tube; this is useful for steam distillation. The bottom cone is *B24*, *B29* or *B34* and the side cone is *B19* or *B24*.

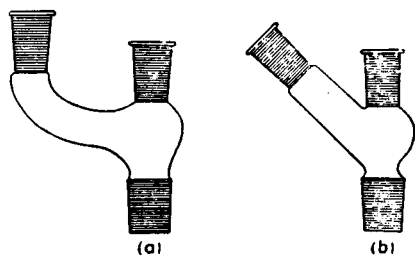

Fig. II, 56, 10.

Multiple adapters The *double neck adapter* (Fig. II, 56, 10) provides as its name implies, two entries into a flask. The sizes of cones which are generally used are *B19*, *B24*, *B29* and *B34*; the sockets are *B19* or *B24*.

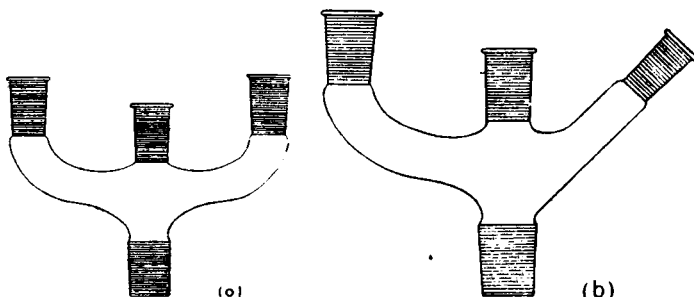

Fig. II, 56, 11.

Two forms of *triple neck adapters* are shown in Fig. II, 56, 11. The sizes of cones and sockets are similar to those for the double neck adapter. These adapters convert an ordinary flask into what is virtually a three-necked flask.

The "swan neck adapter" of Fig. II, 56, 12 is useful for "vacuum" distillations as it permits the use of a capillary tube (held in position by a short length of heavy-walled rubber tubing) not sealed to a ground joint. It may also be used for insertion of a thermometer or a gas-inlet tube in the narrow neck and a reflux condenser into the ground joint: this device virtually converts a three-necked into a four-necked flask. Common sizes are cone B19, B24, B29, or B34; socket B19, B24 or B29.

Multi-necked flasks. Various types of multi-necked flasks are illustrated in Figs. II, 56, 13-15. The centre socket is usually the largest (B24 or B34) and the side sockets are generally smaller. The side tube in Fig. II, 56, 15, *a* may be employed for a capillary tube in "vacuum" distillation; *b*, *c* and *d* are different types of thermometer "wells".

Condensers. Several types of condensers are widely used. Fig. II, 56, 16 is an improved form of Liebig's con-

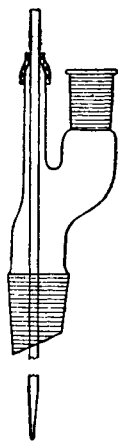
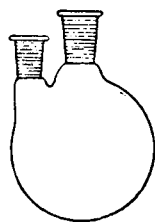
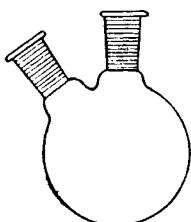

Fig. II, 56, 12.



(a)



(b)

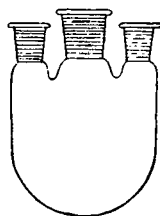

(a)

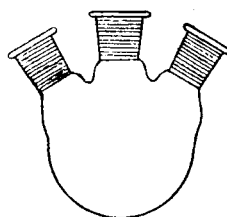

(b)

Fig. II, 56, 13.

Fig. II, 56, 14.

denser, sometimes termed a *West* condenser: it has an inner tube with very thin walls and the space between it and the heavy-walled outer tube

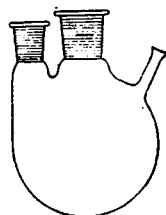

(a)

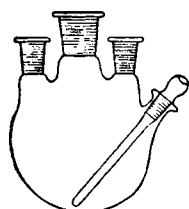

(b)



(c)



(d)

Fig. II, 56, 15.

is small, consequently there is a rapid heat transfer to the fast-flowing cooling water leading to greater efficiency. The length of the jacket is usually 15-35 cm. and it is fitted with a B14, B19 or B24 cone and socket.

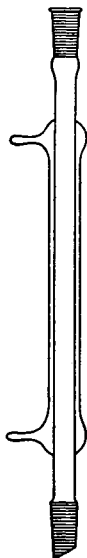

Fig. II, 56, 16.

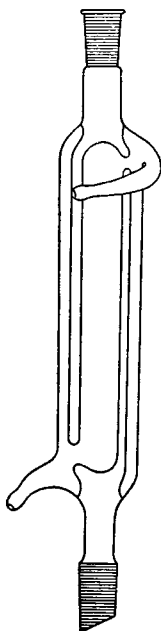

Fig. II, 56, 17.

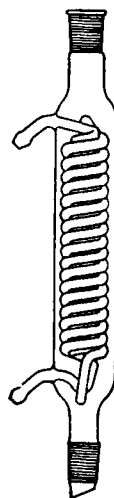

Fig. II, 56, 18.

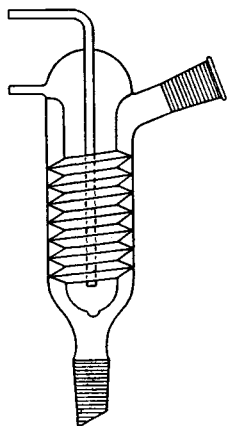

Fig. II, 56, 19.

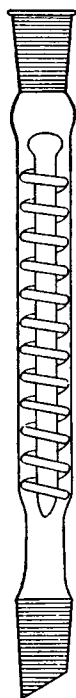

Fig. II, 56, 20.



Fig. II, 56, 21.

Fig. II, 56, 17 (Davies types) and Fig. II, 56, 18 (double coil type) are examples of efficient double surface condensers. Fig. II, 56, 19 depicts a "screw" type of condenser (Friedrich pattern); the jacket is usually 10, 15 or 25 cm. long and the cone and sockets are B19 or B24: this highly efficient condenser is employed for both reflux and for downward distillation.

Fractionating columns. The *Duflon all-glass column* (Fig. II, 56, 20) is a satisfactory fractionating column for general use. The glass spiral

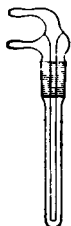

Fig. II, 56, 22.

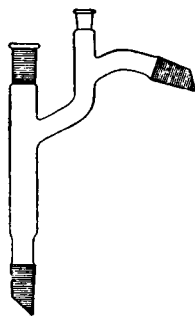

Fig. II, 56, 23.



Fig. II, 56, 24.



Fig. II, 56, 25.

must be carefully ground to fit the outer tube in order to prevent appreciable leakage of vapour past the spiral. The length of the spiral is usually 15, 20 or 30 cm., the internal diameter of the tube is 15–20 mm., and the distance between the turns of the spiral is 9–13 mm.; the cone and socket are B19 or B24.

The *Vigreux column* (Fig. II, 56, 21) is of simple construction but is only moderately efficient. The length is 20–60 cm., the internal diameter of the tube is about 20 mm., and the cone and socket are B24 (or B19 or B29).

A plain tube, similar to Fig. II, 56, 21 but without the indentations, 15–25 mm. internal diameter and 25–75 cm. long, charged with a suitable packing, is essentially a *Hempel column*. The packing may be $\frac{1}{8}$ " or $\frac{1}{4}$ " hollow glass rings, $\frac{1}{8}$ " Raschig rings or $\frac{3}{16}$ " porcelain rings; the packing is supported upon a cone-shaped tantalum wire spiral (wound so as to fit

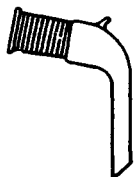

Fig. II, 56, 26.

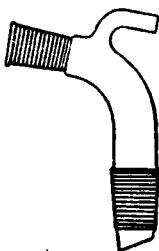

Fig. II, 56, 27.

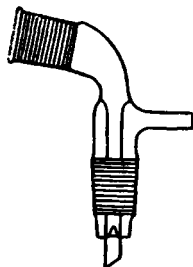

Fig. II, 56, 28.

easily into the column), or on a small glass funnel (of diameter slightly less than that of the column) provided with three glass "feet" which rest upon a slight constriction at the base of the tube (compare Fig. II, 24, 5), or on a perforated glass disc inside the tube, or (most simply) on a few large rings introduced at the lower end.

The efficiency of all the above columns (and also those described below) is increased by lagging with asbestos cloth. The best results are obtained by surrounding each column with two glass jackets and heating the inner jacket electrically to a temperature within 5–10° of the fraction

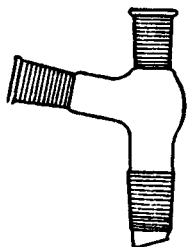

Fig. II, 56, 29.

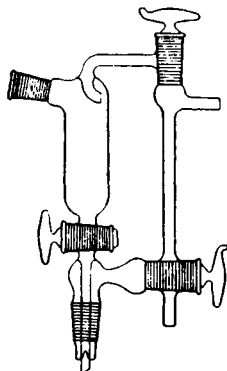

Fig. II, 56, 30.

being collected. The heating of the inner jacket can be effected *either* by first attaching thin asbestos strips along its length and then winding nichrome tape of suitable size and current-carrying capacity around the asbestos strips *or* by winding $\frac{1}{2}$ " insulated heating tape directly round the tube (compare Fig. II, 17, 2); the heat input may be controlled by a variable transformer.

Improved results are also secured by the use of a short reflux condenser ("cold finger"), Fig. II, 56, 22, inserted into the top of the column head; the simplest type is shown in Fig. II, 56, 23. The condenser permits control of the reflux ratio by adjusting the rate of flow of water through it.

The *Widmer column* (Fig. II, 56, 24) is a comparatively inexpensive fractionating column of high efficiency. It embodies a closely-fitting glass spiral (compare Fig. II, 56, 20) but the vapour traverses the length of the column three times; a hot vapour jacket thus surrounds the spiral. The example illustrated in the Figure is of the detachable type, all glass parts being removable, thus facilitating cleaning. The cone and socket are B24 (or B19 or B29).

The *Stedman-type column** is shown in Fig. II, 56, 25. The characteristic features are: (i) the use of a fine stainless steel wire cloth formed into conical discs, and (ii) an accurately fitting Pyrex glass jacket, produced by shrinking Pyrex glass on mandrels to the required inside dimensions. Modifications incorporating a silvered vacuum jacket and an electrically-heated jacket are marketed. This column is said to possess high efficiency but is expensive. It is generally employed in conjunction with a total-condensation variable take-off still head.

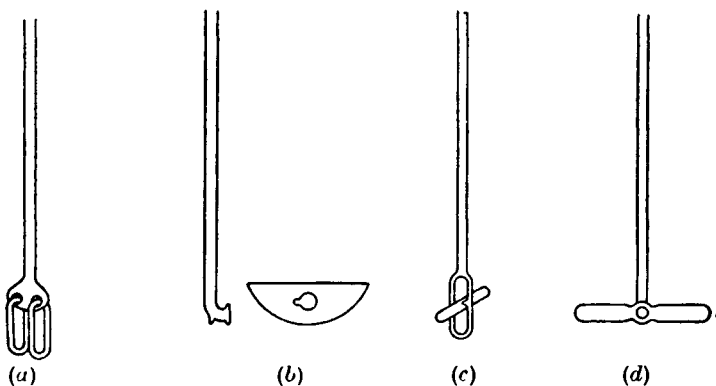

Fig. II, 56, 31.

Receiver adapters or connectors. Various forms of receiver adapters are shown in Figs. II, 56, 26–29. The simplest form, Fig. II, 56, 26, carries a glass hook for securing it to the condenser by means of a rubber band from the side tube to the hook; an improved form, incorporating two ground glass joints is shown in Fig. II, 56, 27. A useful adapter is illustrated in Fig. II, 56, 28; when employed at atmospheric pressure, a drying tube may be attached to the side tube, if desired; in a distillation under reduced pressure, the side tube is connected to the pump. Fig. II, 56, 29 depicts a receiver adapter with an additional socket connection.

Vacuum receivers. The conventional type of receiver, such as the Perkin triangle (Fig. II, 20, 1) or the Kon receiver (Fig. II, 20, 2), is available with B14, B19 or B24 sockets and B14, B19 or B24 cones. A modified Perkin triangle of increased strength and compactness is illustrated in Fig. II, 56, 30.

Glass stirrers. Numerous varieties of stirrers are marketed. The four types depicted in Fig. II, 56, 31 are reasonably efficient and possess the advantage of passing through narrow-necked flasks or sockets (B14 or

* Supplied by the Scientific Glass Apparatus Co.

larger). They may be fitted into a vessel by either of the devices shown in Fig. II, 56, 32 and Fig. II, 56, 33. The former is provided with a B14 or B19 socket and a B19 cone; the side tube serves for the admission of inert or other gases during the stirring operation. A subsidiary glass sleeve (smaller diagram, enlarged) must be used if a gas-tight seal is required. A short length (say, 1 cm.) of rubber tubing is slipped over the centre of the glass tube and this is fitted into the B14 or B19 socket; another short length of rubber tubing is inserted over the end of the glass bearing (as in the Figure) and the stirrer shaft is passed through the rubber tube. A little glycerine is employed as the lubricant at the rubber to glass contact surfaces. The extended stem on the cone is not a bearing.

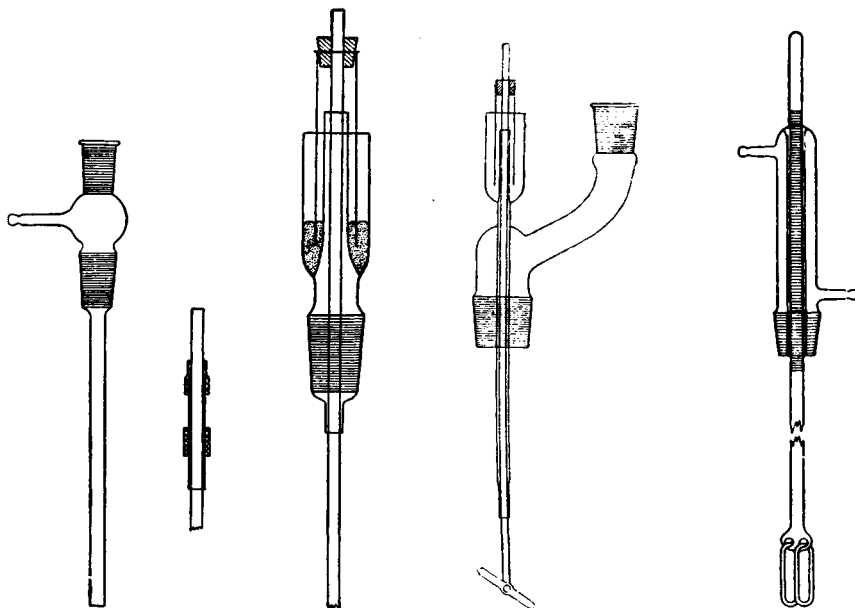

Fig. II, 56, 32.

Fig. II, 56, 33.

Fig. II, 56, 34.

Fig. II, 56, 35.

but merely serves to prevent shaft "whip" at high speeds, particularly in large flasks. Fig. II, 56, 33 is a standard form of mercury-sealed stirrer and carries a B14, B19, B24 or B29 cone; a modification, with a side tube for a reflux condenser, etc., is shown in Fig. II, 56, 34. A precision-ground stirrer, which eliminates the necessity of a mercury or rubber seal, is illustrated in Fig. II, 56, 35; the long length of ground bearing reduces "whipping" and vibration to a minimum. The water cooling jacket, which surrounds the precision-ground tubes, helps to retain the lubricant at a constant temperature; it also acts as a "cold finger" to condense vapours back into the flask and prevent them from attacking the seal. This stirrer may be fitted with a Teflon blade (see Fig. II, 17, 5).

Motor stirring units are described in Section II,7.

Separatory funnels. For many operations the globular form (compare Fig. II, 1, 5, c) with B14, B19 or B24 cone on the stem and B14 or B19 socket for the stopper, is convenient. For some purposes, e.g., when used on a three-necked flask or with a multiple adapter, the cylindrical

form (compare Fig. II, 1, 5, e) is to be preferred ; this is similarly provided with a cone on the stem and a ground socket. The insertion of a dripping tip (compare Fig. II, 1, 5, f) immediately below the stopcock is a valuable refinement. Fig. II, 56, 36 represents a cylindrical funnel with pressure

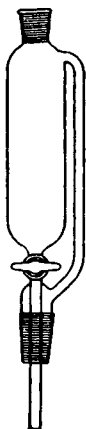

Fig. II, 56, 36.

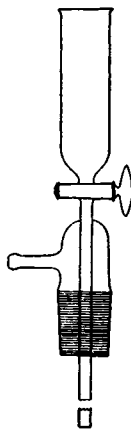

Fig. II, 56, 37.

equalising tube ; this is useful for reactions which are conducted in an atmosphere of inert gas (see Fig. II, 7, 13). An open dropping funnel with side tube is shown in Fig. II, 56, 37.

II,57. ELECTRIC HEATING MANTLES

For successful fractional distillation, slow and even heating of the bath surrounding the flask is essential. This may be achieved by suitably designed electrically-heated air baths or by the use of oil baths provided

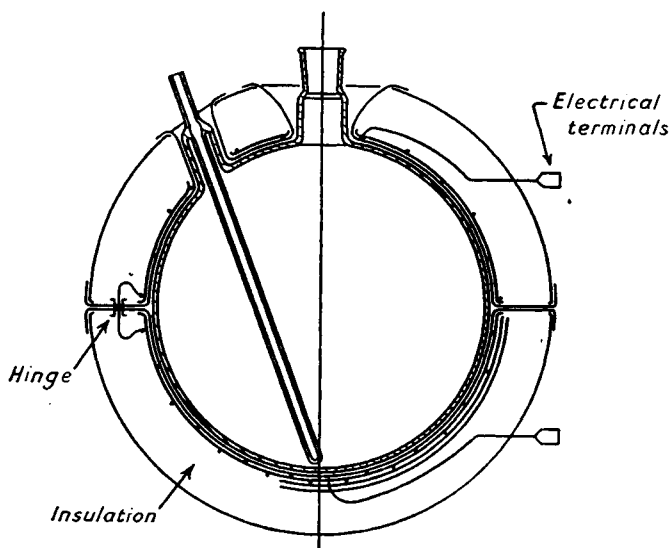

Fig. II, 57, 1.

with internal electric heating ; the power input is controlled by a resistance or variable transformer.

An electric heating mantle may also be used : temperatures up to about 400° C. are readily attained, it can be employed with highly inflammable liquids and bumping is largely eliminated. The construction of a typical electric heating mantle* will be apparent from Fig. II, 57, 1, in which it surrounds a single neck flask with a thermometer or sight well. The heating element (nichrome or equivalent resistance wire) is embedded in layers of glass fabric near the exposed surface and is further covered by layers of glass wool insulation. The two hemispherical halves are held together by a " Zip " fastener or by glass fibre cords. The temperature lag is small since the heating elements are very close to the flask wall. A built-in thermo-couple is available in certain types so that the internal temperature can be read with a suitable pyrometer ; a small thermostat may also be embedded in the heating elements to prevent overheating. Special supports (cradles) for the heating mantles are marketed.

In a modification, illustrated in Fig. II, 57, 2, the heating mantle is contained in a hemispherical or cylindrical aluminium housing, thus providing additional rigidity. The electric heating mantle is used in conjunction with a variable transformer (*e.g.*, Variac or Powerstat). " Heating tops " or " upper covers ", with openings for one, two or three-necked flasks, for these half mantles are marketed ; they are provided with an independent heating control. " Multi-size " heating

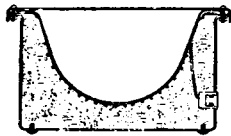

Fig. II, 57 2.

mantles are available commercially ; these enable one heating mantle to be used for a variety of sizes of round-bottomed flasks.

Electric heating mantles are also marketed for :—

- (i) Griffin-form beakers.
- (ii) Conical flasks.
- (iii) Glass funnels (60° type).
- (iv) Buchner funnels.
- (v) Fractionating columns ; these may be provided with thermo-couples near each end.

II,58. APPARATUS FOR THE CONTINUOUS EXTRACTION OF SOLIDS OR LIQUIDS BY SOLVENTS

Solids by solvents. The various forms of Soxhlet apparatus illustrated in Section II,44 can be purchased with ground glass joints. A simplified form, in which the fragile side tubes are absent, is shown in Fig. II, 58, 1. The material to be extracted, if of granular form, may rest upon a sintered glass disc or upon a removable " septum " (Fig. II, 58, 1, a) or if this is impracticable because of the disintegration of the material by the solvent or because of its physical characteristics, the substance to be extracted may be placed in a paper or alundum thimble or in a sintered glass crucible or thimble. The action is continuous ; extraction is effected by the boiling or nearly boiling solvent



Fig. II, 58, 1, a.

* Manufactured by (i) Glas-Col Apparatus Company. (ii) Electrothermal Engineering Ltd., and (iii) by Isopad Ltd.

and is thus more rapid than with the common form of Soxhlet apparatus (Fig. II, 44, 4), which is intermittent in its action. Another simple form of extractor, incorporating, a sintered plate sealed into the body, is illustrated in Fig. II, 58, 2.

Liquids by liquids. The apparatus represented by Fig. II, 58, 3 is employed for the extraction of aqueous solutions by solvents lighter than water, such as ether or benzene. The solvent distilled from the flask (attached to the lower end) and condensed by the reflux condenser (fitted to the upper end) passes through the funnel down a narrow tube, partially open at the lower end, into the aqueous solution, then rises to the surface and returns to the flask, having during its passage extracted some portion of the dissolved material from it. To improve the efficiency of the process,

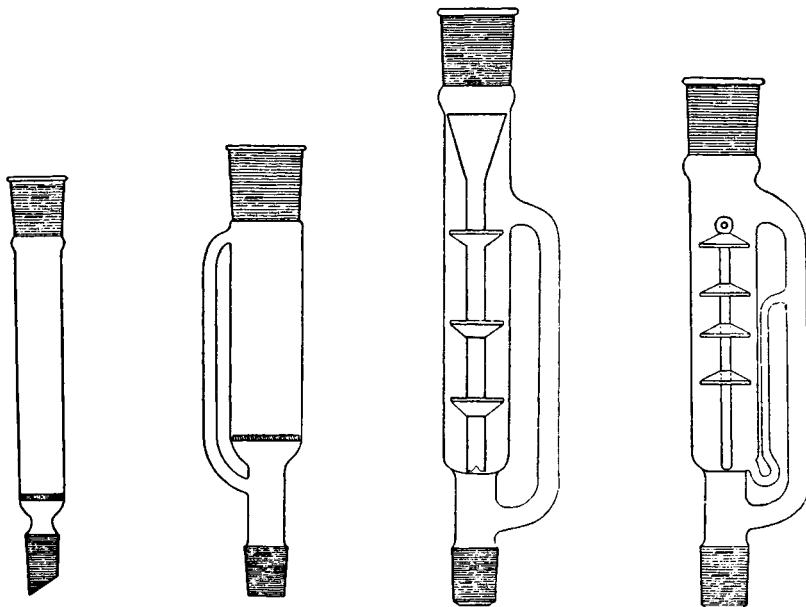

Fig. II, 58, 1.

Fig. II, 58, 2.

Fig. II, 58, 3.

Fig. II, 58, 4.

devices are introduced which have as their object the more intimate contact of the solvent with the solution chiefly by reducing the size of the drops issuing from the bottom of the tube through which the extraction solvent passes into the liquid to be extracted. These include:—

(a) Perforation of the tube with a number of fine holes.

(b) The tube is left open, but is “gashed” slightly so that it rests on the bottom of the vessel; the solvent passes through the small apertures formed by the “gashes.”

(c) The “solvent tube” is provided with a number of “fins” which reach nearly to the walls of the containing vessel (as in Fig. II, 58, 3); sometimes a glass “spiral” surrounds the tube.

(d) A sintered glass distributor is fitted to the end of the “solvent tube.”

The apparatus for the extraction of aqueous solutions by solvents heavier than water (e.g., chloroform or carbon tetrachloride) is shown

in Fig. II, 58, 4. The solvent falling from the reflux condenser descends through the aqueous solution into a solvent layer below; a series of baffles breaks the solvent into drops. In another form of the apparatus, the solvent falling from the reflux condenser is collected in a short funnel at the lower end of which a sintered glass plate is sealed; this results in fine drops falling through the aqueous solution. A constant level of solvent is maintained by an overflow into the vapour tube.

Modifications of the liquid-liquid extraction apparatus (compare Figs. II, 44, 1 and II, 44, 3), which are available in capacities up to 2-5 litres, are shown in Figs. II, 58, 5 and II, 58, 6; the former is for extrac-

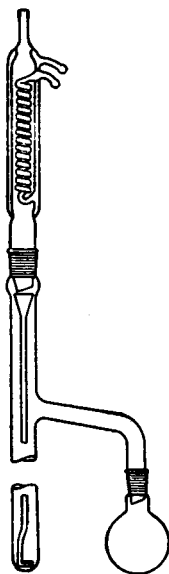

Fig. II, 58, 5.

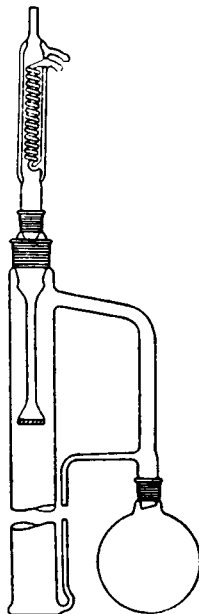

Fig. II, 58, 6.

tion with solvents of the ether type (lighter than water) and the latter for solvents such as carbon tetrachloride (heavier than water).

Attention is directed to the great advantage of continuous extraction over manual shaking in a separatory funnel for liquids or for solutions which tend to froth or which lead to emulsification; comparatively little difficulty is experienced in the continuous extraction process.

Extraction of steam distillates by solvents. The apparatus, depicted in Fig. II, 58, 7, may be employed for the continuous extraction of substances *which are volatile in steam* from their aqueous solutions or suspensions. Solvents of the ether type (*i.e.*, lighter than water) or of the carbon tetrachloride type (*i.e.*, heavier than water) may be used. A reflux condenser is inserted in the B19 socket, whilst flasks of suitable capacity are fitted into the lower B24 cone and the upper B19 cone respectively. For extraction with ether, the flask attached to the upper B19 cone contains the ether whilst the aqueous solution is placed in the flask fitted to the lower B24 cone: the positions of the flasks are reversed

for extractions with carbon tetrachloride. The contents of both flasks are boiled, and a rapid stream of water is passed through the reflux condenser which is inserted in the ground socket. The two liquids pass down

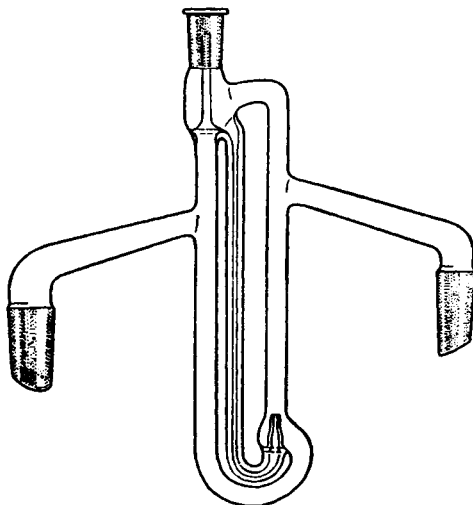

Fig. II, 58, 7.

the central capillary portion in small pellets or "sausages," and finally separate and return automatically to their respective flasks. The conditions of the cycle of operations in the apparatus are such as to promote very intimate contact between the two liquids.

II,59. LUBRICATION OF GROUND GLASS JOINTS

Great care must be taken to keep all ground surfaces free from grit and dust. For work at atmospheric pressure, no lubricant should be required; it is advisable, however, in order to reduce the danger of "sticking" to apply a slight smear around the upper part of each ground joint of vaseline (if permissible), a rubber grease, Apiezon grease *L* or *M*, or Silicone stopcock grease.

When salt solutions or alkaline substances may come into contact with ground glass surfaces, light lubrication of the surfaces is essential. When greasing stopcocks, only the outer parts of the plug should be lightly smeared with lubricant; in those cases where the lubricant is not harmful, the whole of the plug may be given a very thin smear of the grease but particular care must be taken to avoid the entrance of the lubricant into the bore of the plug.

Lubrication of all ground glass surfaces is essential for distillations under reduced pressure. Suitable lubricants are Apiezon grease *L*, *M* or *N* and Silicone stopcock grease; also Alkathene (a polyethylene plastic), which is especially suitable for high temperatures.

"Sticking" of ground glass joints. Provided adequate care is

exercised to use only joints which fit well and the ground surfaces are suitably lubricated, "sticking" will rarely occur. If, however, a ground joint should "seize up" or "freeze," the following suggestions may be found useful:

(i) Set the joint in a vertical position and apply a layer of glycerine to the upper surface. The glycerine will slowly penetrate into the joint, thus permitting the separation of the ground surfaces.

(ii) If procedure (i) is unsuccessful, direct a stream of hot water on the outer surface of the joint for a few seconds and gently draw the members apart; gentle tapping on the edge of a wooden bench is sometimes helpful.

(iii) Introduce the joint into a small luminous Bunsen flame for a few seconds, and then gently draw the ground surfaces apart. If the glass is of Pyrex (or of any other heat-resisting variety), there is very little danger of a crack resulting from this process. The object of the heating is to cause the glass of the socket to expand before any appreciable change has occurred in the inner cone.

II,60. TYPICAL ASSEMBLIES

It is hoped that the account of the interchangeable ground glass joint apparatus already given will serve as an introduction to the subject. For the numerous applications of such apparatus, the reader is referred to the catalogues of the manufacturers listed in Section II,54. Most of the simple operations in practical organic chemistry may be carried out with a set of apparatus which can be purchased for a comparatively small sum (£5-£10); this should dispel the erroneous impression, which appears to be prevalent in several quarters, that the cost of apparatus with interchangeable ground glass joints is prohibitive for general work in preparative organic chemistry.

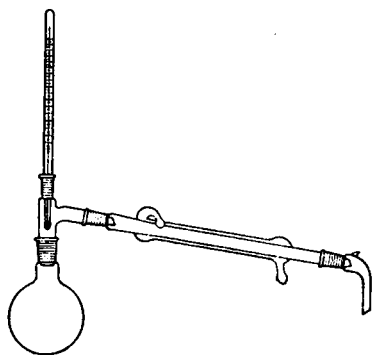

Fig. II, 60, 1,

Some typical assemblies are collected in the following diagrams. In all cases where thermometers with ground glass joints are shown, they may be replaced by rubber stoppers, as fully detailed in the description of Fig. II, 56, 6.

Simple distillation. The assembly shown in Fig. II, 60, 1 is of general utility; for very volatile liquids the Liebig's condenser may be replaced by a double surface condenser.

Fractional distillation. Fig. II, 60, 2 illustrates a set-up for fractional distillation with a Hempel-type column and "cold finger," the latter to give manual control of the reflux ratio. Any other fractionating column, e.g., an all-glass Dufton or a Widmer column may, of course, be used.

A set-up for distillation under reduced pressure is shown in Fig. *II, 60, 3*; it is generally more convenient to use a Kon receiver or a Perkin triangle (Fig. *II, 56, 31*). The vessel at the side, connected to the assembly by rubber "pressure" tubing, may be immersed in a Dry Ice-acetone bath and serves as a trap for volatile materials.

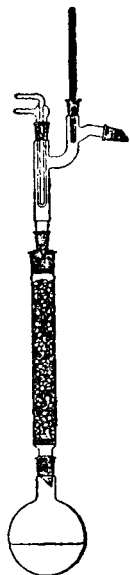
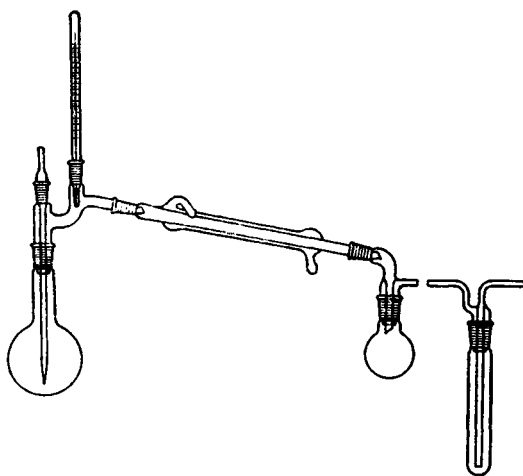
Fig. *II, 60, 2*.Fig. *II, 60, 3*

Removal of an inflammable solvent. This operation ("flash distillation") is conveniently conducted in the apparatus of Fig. *II, 60, 4*; the receiver may be attached as in Fig. *II, 60, 3*.

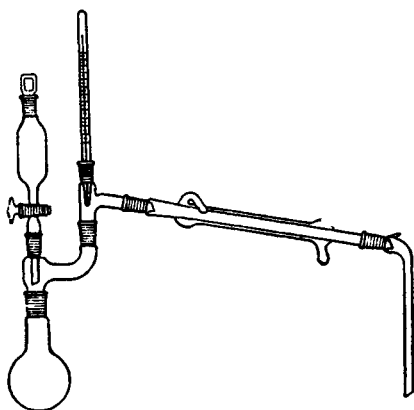
Fig. *II, 60, 4*.

Refluxing of a mixture. The assembly is shown in Fig. *II, 60, 5*; the Liebig's condenser may be replaced by a double surface condenser.

Reactions under reflux with stirring. One assembly is depicted in Fig. II, 60, 6 ; a three-necked flask may be substituted for the flask and adapter.



Fig. II, 60, 5.

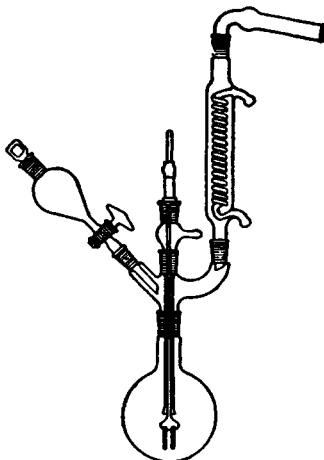

Fig. II, 60, 6.

Steam distillation. A convenient set-up is shown in Fig. II, 60, 7. An equivalent result may be obtained by the use of a two- or three-necked flask.

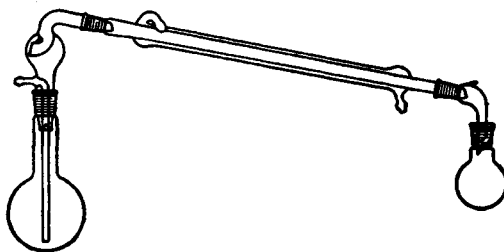

Fig. II, 60, 7.

CHAPTER III

PREPARATION AND REACTIONS OF ALIPHATIC COMPOUNDS

PRELIMINARY LABORATORY OPERATIONS

III,1. DETERMINATION OF MELTING POINTS

THE student should read Sections I,10 to I,16 carefully before commencing any experimental work. A supply of melting point capillaries is prepared as described in Section II,10 (compare Fig. II, 10, 1). The apparatus illustrated in Fig. II, 10, 2, a is assembled with concentrated sulphuric acid as the bath liquid; the thermometer selected should have a small bulb. The melting points of pure samples of the following compounds are determined in the manner detailed in Section II,10:—

- (a) α -Naphthylamine, A.R. (50°) or diphenylamine, A.R. (53.5°).
- (b) α -Naphthol, A.R. (96°) or catechol (104°) or benzil (95°).
- (c) Benzoic acid, A.R. (122°) or β -naphthol, A.R. (123°) or urea (133°).
- (d) Salicylic acid, A.R. (159°) or phenylurea (mono) (148°).
- (e) Succinic acid, A.R. (185°) or *p*-tolylurea (mono) (180°).
- (f) *p*-Nitrobenzoic acid (239°) or *s*-diphenylurea (242°).

By working in the above order, it will not be necessary to wait for the apparatus to cool between consecutive determinations. The correct melting points of the pure substances are given in parentheses; these should be compared with the values observed with the thermometer. By plotting the *differences* between the observed and the correct values for the various compounds as ordinates against temperatures as abscissae, the calibration curve for the particular thermometer used is obtained. This calibration curve should be carefully preserved so as to enable the correction to be applied for any subsequent melting point determination. It must be emphasised that the calibration curve refers only to the thermometer originally employed for the determination of the melting points of the standard substances listed above (or in Section II,9).

III,2. MIXED MELTING POINTS

The application of mixed melting point determinations to the identification of organic compounds has been described in Section I,17. In order to gain experience the student should carry out the following simple experiment.

Determine the melting point of pure cinnamic acid (133°) and pure urea (133°). Intimately mix approximately equal weights (*ca.* 0.1 g.) of the two finely-powdered compounds and determine the melting point; a considerable depression of melting point will be observed. Obtain an unknown substance from the demonstrator and, by means of a mixed melting point determination, discover whether it is identical with urea or cinnamic acid.

If time permits, carry out similar experiments with benzoic acid (122°) and β -naphthol (123°).

It is instructive for the student to construct a rough melting point diagram (compare Section I,13 and Fig. I, 12, 1) for mixtures of cinnamic acid and urea. Weigh out 1.00 g. each of the two finely powdered components, and divide each into ten approximately equal portions on a sheet of clean, smooth paper. Mix 4 portions of cinnamic acid (*A*) with 1 portion of urea (*B*) intimately with the aid of a spatula on a glass slide, and determine the melting point (the temperature at which the mixture just becomes completely fluid is noted). Repeat the procedure for 3 parts of *A* and 2 parts of *B*; 2 parts of *A* and 3 parts of *B*; and 1 part of *A* and 4 parts of *B*. Tabulate your results as follows:—

CINNAMIC ACID	UREA	M.P.
100 %	0 %	133°
80 %	20 %	—
60 %	40 %	—
50 %	50 %	—
40 %	60 %	—
20 %	80 %	—
0 %	100 %	133°

Plot temperatures as ordinates, and, as abscissae, the percentage of urea from left to right (0–100 per cent.) and of cinnamic acid from right to left (0–100 per cent.).

Alternatively, the experiment may be conducted with acetanilide (113°) and antipyrin (113°).

III.3. DETERMINATION OF BOILING POINTS

The student should first read Sections I,1–I,3 which deal with the theory of the subject, and Section II,12 in which the experimental details are given.

Fit up the apparatus illustrated in Fig. II, 12, 1. The distilling flask should be of 50 ml. capacity and about half to three-fifths full of liquid: the thermometer should be so arranged that the top of the small bulb is just level with the side arm of the distilling flask. The flask may be heated on a wire gauze (preferably with an asbestos centre), but the most satisfactory method is to employ the air bath depicted in Fig. II, 5, 3. Determine first the boiling point of distilled water (100°); immediately after the liquid is poured into the flask and before inserting the thermometer, add two or three small fragments of unglazed porcelain ("porous pot" or "boiling chips") in order to promote regular ebullition. Read the barometric pressure and if this differs appreciably from 760 mm., correct the boiling point with the aid of Table II, 9, B. After the boiling point of water has been determined, rinse the inside of the apparatus with a little acetone (2–3 ml.) and discard the wet solvent; rinse again with a somewhat larger volume (about 5 ml.) of acetone, and pour this back into the "ACETONE FOR WASHING" bottle, and drain thoroughly. Pass a stream of dry air through the apparatus (it is best to use warm air from the "drier" shown in Fig. II, 2, 1) until it is dry.

Repeat the boiling point determination with the following pure liquids : (a) carbon tetrachloride, A.R. (77°) ; (b) ethylene dibromide (132°) or chlorobenzene (132°) ; (c) aniline, A.R. (184.5°) ; and (d) nitrobenzene, A.R. (211°). An air condenser should be used for (c) and (d). Correct the observed boiling points for any appreciable deviation from the normal pressure of 760 mm. Compare the observed boiling points with the values given in parentheses and construct a calibration curve for the thermometer. Compare the latter with the curve obtained from melting point determinations (Section III,1).

In addition to the orthodox method, just described, for the determination of the boiling points of liquids, the student should determine the boiling points of small volumes (*ca.* 0.5 ml.) by Siwoloboff's method. Full details are given in Section II,12. Determine the boiling points of the pure liquids listed in the previous paragraph.* Observe the atmospheric pressure and if this differs by more than 5 mm. from 760 mm., correct the boiling point with the aid of Table II,9,B. Compare the observed boiling points with the accepted values, and draw a calibration curve for the thermometer.

III.4. FRACTIONAL DISTILLATION

The student should first study the elementary theory of fractional distillation given in Sections I,4–I,5. The experimental technique for simple fractional distillation is described in Section II,15.

To gain experience, the student should separate a mixture of pure benzene (b.p. 80°) and pure toluene (b.p. 110.5°). Prepare a mixture of 50 ml. of pure (*e.g.*, A.R.) benzene and 50 ml. of pure toluene, place it in a 200 ml. round-bottomed flask, and add 2–3 small chips of porous porcelain. Fit up the assembly shown in Fig. II, 15, 4 ; the apparatus must be dry. The Hempel column should be filled with hollow glass rings ($\frac{1}{4} \times \frac{1}{4}$ ") or with porcelain plain rings ($\frac{1}{8} \times \frac{1}{8}$ " or $\frac{3}{16} \times \frac{3}{16}$ ") ; in the latter case, a few large ($\frac{1}{4} \times \frac{1}{4}$ ") glass or porcelain rings should first be placed at the lower end in order to prevent the smaller rings from falling through. The column (20–22 mm. diameter) should be filled to within 5 cm. of the side arm and the length of the packing should be about 30 cm. It is an advantage to wrap the fractionating column with asbestos paper or cloth or with linen cloth. Heat the flask in an air bath (Fig. II, 5, 3) and shield the apparatus carefully from draughts : make sure that a rapid stream of water is passing through the condenser (the components of the mixture are volatile and inflammable) and that no flame approaches the receiver. Distil the mixture very slowly (1–2 drops per second) at first, and collect the fractions with the following boiling points: (i) $80\text{--}83^{\circ}$ † ; (ii) $83\text{--}107^{\circ}$; and (iii) $108\text{--}111^{\circ}$. When fraction (iii) is reached, the rate of distillation may be increased. A good separation is easily obtained ; the fractions should have volumes of 47, 6 and 47 ml. respectively (the last figure includes the "hold-up" of the column ‡).

* If time is limited, the boiling point determinations by the "distilling flask method" for these liquids may be omitted.

† The first few drops of this fraction are usually cloudy because of the thin film of water adsorbed on the surface of the column and packing.

‡ The packing may be conveniently dried by washing it with a little acetone and blowing warm air through the column.

Other mixtures which may be employed are : carbon tetrachloride (b.p. 77°) and toluene (b.p. 110–111°); chloroform (b.p. 61°) and toluene; methyl alcohol (b.p. 65°) and water (b.p. 100°). The last example is of interest because almost pure methyl alcohol may be isolated; no constant boiling point mixture (or azeotropic mixture) is formed (compare ethyl alcohol and water, Sections I,4 and I,5). Attention is directed to the poisonous character of methyl alcohol; the vapour should therefore not be inhaled.

Alternatively, a modified Hempel column (Fig. II, 15, 5) or an all-glass Dufton column with 30 cm. spiral (Fig. II, 15, 2) may be used for the fractionation. The latter has the advantage that it is more easily cleaned.

III.5. PURIFICATION OF SOLID ORGANIC COMPOUNDS BY RECRYSTALLISATION

The student should read Sections II,27–II,31 where the technique of the recrystallisation of solids and cognate processes is described. To gain experience, he should carry out the following experiments.

Choice of solvent for recrystallisation. Obtain small samples (about 0.5 g.) of the following compounds from the storeroom : (i) salicylic acid, (ii) acetanilide, (iii) *m*-dinitrobenzene, (iv) naphthalene, and (v) *p*-toluene-sulphonamide. Use the following solvents : distilled water, methylated spirit, rectified spirit, acetone, benzene and glacial acetic acid.

Place 0.1 g. of the substance in a semimicro test-tube (75 × 10 mm. or 100 × 12 mm.) and proceed systematically with the various solvents as detailed in Section II,27. Finally, summarise your results, and indicate the most suitable solvent or solvents for the recrystallisation of each of the above compounds.

Typical Recrystallisations

I. Acetanilide from water. Weigh out 4.0 g. of commercial acetanilide into a 250 ml. beaker. Add 80 ml. of water and heat nearly to the boiling point. The acetanilide will appear to melt and form an "oil" in the solution (for theory, see Section I,18). Add small portions of hot water, whilst stirring the mixture and boiling gently, until all the solid has dissolved (or almost completely dissolved). [If the solution is not colourless, allow to cool slightly, add about 0.5 g. of decolourising carbon, and continue the boiling for a few minutes in order to remove the coloured impurities.] Filter the boiling solution through a fluted filter paper (for preparation, see Section II,29) supported in a short-necked funnel; if the solution cannot be filtered in a single operation, keep the unfiltered portion hot by heating with a small flame over a wire gauze. Alternatively, the solution may be filtered through a hot water funnel (Fig. II, I, 6, a). Collect the filtrate in a 250 ml. beaker. When all the solution has been filtered, cover the beaker containing the hot filtrate with a clock glass and cool rapidly with stirring. Allow to stand for about 30 minutes to complete the separation of the solid. Filter with suction through a small Buchner funnel (see Figs. II, I, 7, a and c), wash the crystals twice with 5 ml. portions of cold water (to remove the adhering mother liquor), and press them in the funnel with the back of a large, flat glass stopper. Remove the funnel from the filter flask, invert it on two thicknesses of filter or absorbent paper resting upon a pad of newspaper, and allow the crystals to dry in the air. It is advisable in air drying to

cover the crystals with a large clock glass resting upon corks, or the crystals may be covered with a large filter paper perforated with a number of holes in order to allow the solvent to evaporate. For more rapid drying, the crystals may be placed on a clock glass or in an evaporating basin in the steam oven (this process can only be used for substances which melt above 100°). Weigh the yield of recrystallised material and determine the melting point. If the recrystallised product is not sufficiently pure (melting point low or melting over a range of several degrees), repeat the recrystallisation. Pure acetanilide has m.p. 114°.

If a m.p. determination is required soon after recrystallisation, a small quantity may be rapidly dried by pressing it several times upon a pad of several thicknesses of filter or absorbent paper and placing it upon a watch glass in a warm place. A piece of unglazed porous plate may also be used.

Optional or alternative experiments are the recrystallisation of 3.0 g. of crude benzoic or salicylic acid from water.

2. Naphthalene from alcohol (crystallisation from an inflammable solvent). Weigh out 5.0 g. of commercial naphthalene into a 150 ml. conical or bolt-head flask. Add 25 ml. of rectified spirit (or of methylated spirit),* 2-3 fragments of porous porcelain, and fit a reflux condenser into the mouth of the flask by means of a sound cork (compare Fig. II, 13, 7; the guard tube is not required here). Heat the mixture on a water or steam bath or in an air bath until the solvent boils. Add successive small volumes (each of 2-3 ml.) of the solvent, and boil gently after each addition, until the naphthalene has dissolved (apart from insoluble impurities). [If the solution is coloured, remove it from the bath, and when it has cooled somewhat, add 0.2-0.3 g. of decolourising charcoal and shake thoroughly. Boil the mixture for several minutes.] Filter the hot solution through a fluted filter paper or through a hot water funnel (*CAUTION!* all flames in the vicinity must be extinguished), and collect the filtrate in a conical flask or in a lipped beaker. Cover the receiver with a watch or clock glass, and cool it in cold water. Stir or shake the solution as cooling proceeds. After 30 minutes, filter off the crystals through a small Buchner funnel at the pump; wash all the crystals into the funnel by rinsing the flask or beaker with some of the filtrate. Discontinue the suction and wash the crystals with two 5 ml. portions of rectified or methylated spirit. Continue the suction and press the crystals down firmly with a flat glass stopper. Dry the crystals on filter paper as in 1. When dry, determine the weight and also the m.p. of the purified naphthalene. Pure naphthalene has m.p. 80°.

Alternative experiments: (a) Recrystallisation of crude benzoic acid (5.0 g.) from methyl alcohol (30 ml.); the wash liquid should be 50 per cent. methyl alcohol. (b) Recrystallisation of acetanilide (5 g.) from toluene (100 ml.); filter through a preheated funnel.

3. Sulphanilic acid from water. Use 5.0 g. of crude (grey) sulphanilic acid and proceed as in 1. Add 1 g. of decolourising carbon to the solution at 70-80°, and continue the boiling for several minutes. If the filtered solution is not colourless, it must be boiled with a further 1 g. of decolourising carbon. Filter the cold solution at the pump, wash with a little cold water, dry and weigh the yield of recrystallised product.

* Benzene is an alternative solvent.

SATURATED ALIPHATIC HYDROCARBONS

III,6. REACTIONS AND CHARACTERISATION
OF SATURATED ALIPHATIC HYDROCARBONS

Use a sample of "purified *n*-heptane fraction from petroleum" (1), b.p. 90–100°; this consists of a mixture of hydrocarbons in which the heptanes predominate. Carry out the following tests.

(i) **Action of bromine water.** Place 1 ml. of heptane in each of two test-tubes, and add 3–4 ml. of bromine water. Shake the tubes well, and keep one of them in your locker and out of the light. Expose the other tube to bright sunlight {or hold it close to a bright (150–200 watts) electric bulb}. Compare the tubes after about 15 minutes.

(ii) **Action of bromine dissolved in a non-aqueous solvent.** Repeat experiment (i), but add 0.5 ml. of a solution of bromine in carbon tetrachloride (2) to each of the tubes. After 10–15 minutes (or as soon as a change has occurred), examine each of the tubes. Breathe across the mouth of the tube in which a change has taken place and test the vapour with blue litmus paper.

(iii) **Action of potassium permanganate solution.** Treat 1 ml. of the hydrocarbon with 2 ml. of 0.5 per cent. potassium permanganate solution and 1 ml. of dilute sulphuric acid. Shake gently for a short time, and observe if the permanganate solution is decolourised.

(iv) **Action of concentrated sulphuric acid.** Add 1 ml. of the hydrocarbon to 2 ml. of concentrated sulphuric acid and shake gently. Observe whether the acid layer is affected in any way.

(v) **Action of concentrated nitric acid.** Add 1 ml. of heptane cautiously to 2 ml. of concentrated nitric acid. Note whether any reaction occurs.

Notes.

(1) The commercial "*n*-heptane from petroleum" should be shaken with one quarter of its volume of concentrated sulphuric acid for several minutes, and the process repeated until the lower acid layer remains colourless or only very slightly coloured. If fuming sulphuric acid (containing 10–20 per cent. SO₃) is employed, only 10 per cent. of the volume of the hydrocarbon need be used in each washing: great care must, of course, be taken in the disposal of the coloured acid layer by pouring it very slowly into a large excess of water. The hydrocarbon is then washed twice with water, dried over anhydrous calcium or magnesium sulphate, and distilled. "*n*-Hexane from petroleum," b.p. 67–69°, or "petroleum ether, free from aromatic hydrocarbons," b.p. 60–80°, are also suitable for the above tests. They must, however, be first purified as described under "*n*-heptane."

(2) A solution prepared by dissolving 2 g. of bromine in 100 g. of carbon tetrachloride is satisfactory. Carbon tetrachloride is employed because it is an excellent solvent for bromine as well as for hydrocarbons; it possesses the additional advantage of low solubility for hydrogen bromide, the evolution of which renders possible the distinction between decolourisation of bromine due to substitution or due to addition.

CHARACTERISATION OF SATURATED ALIPHATIC HYDROCARBONS

Because of the chemical inertness of the paraffin hydrocarbons and of the closely related *cycloparaffins*, no satisfactory crystalline derivatives can be prepared. Reliance is therefore placed upon the physical properties (boiling point, density, and refractive index) of the redistilled samples. These are collected together in Table III,6.

TABLE III,6. SATURATED ALIPHATIC HYDROCARBONS
PARAFFINS AND CYCLOPARAFFINS

Hydrocarbon	B.P.	d_{4}^{20}	n_{D}^{20}
2-Methylbutane (<i>iso</i> -pentane)	28°	0·620	1·354
<i>n</i> -Pentane	36	0·627	1·358
<i>n</i> -Hexane	68·5	0·659	1·374
<i>n</i> -Heptane	98	0·683	1·388
<i>n</i> -Octane	125	0·703	1·397
<i>n</i> -Nonane	150·5	0·717	1·405
<i>n</i> -Decane	173	0·730	1·412
<i>n</i> -Undecane	196 (87°/20)	0·740	1·417
<i>n</i> -Dodecane	216 (94°/14)	0·750	1·422
<i>n</i> -Tridecane	242 (101°/12)	0·756	1·425
<i>n</i> -Tetradecane	252 (123°/12)	0·762	1·429
<i>n</i> -Pentadecane	270 (120°/4·5)	0·769	1·432
<i>n</i> -Hexadecane	143·5°/9 (m.p. 18°)	0·774	1·435
<i>n</i> -Octadecane	308 (m.p. 28°)	—	—
2-Methylpentane	60	0·653	1·372
2 : 2 : 4-Trimethylpentane	99	0·688	1·389
2 : 7-Dimethyl- <i>n</i> -octane (<i>Di-iso</i> -amyl)	160	0·725	1·409
<i>cyclo</i> Pentane	49	0·745	1·406
<i>cyclo</i> Hexane	81	0·779	1·426
<i>cyclo</i> Heptane	118	0·811	1·445
Methylcyclohexane	101	0·769	1·423
Ethylcyclohexane	130	0·784	1·432
<i>n</i> -Propylcyclohexane	155	0·790	1·436
<i>iso</i> -Propylcyclohexane	154·5	0·802	1·441
<i>n</i> -Butylcyclohexane	177	0·800	1·440
<i>n</i> -Amylcyclohexane	200	0·804	1·444
<i>iso</i> -Amylcyclohexane	193	0·802	1·442
Dicyclohexyl	237 (m.p. 3°)	0·889	1·480
<i>trans</i> -Decahydronaphthalene (Decalin)	185	0·870	1·470
<i>cis</i> -Decahydronaphthalene (Decalin)	194	0·895	1·481
1 : 2 : 3 : 4-Tetrahydro- naphthalene (Tetralin)	207	0·971	1·543
<i>trans-p</i> -Menthane	161	0·792	1·439
<i>cis-p</i> -Menthane	169	0·816	1·451

III,7. *n*-OCTANE (*Wurtz Reaction*)

When an alkyl halide is treated with sodium, the main product is the paraffin hydrocarbon. The final result may be represented by the equation :



Weigh out 23 g. of clean sodium under sodium-dried ether (1), cut it up rapidly into small pieces, and introduce the sodium quickly into a dry 750 or 1000 ml. round-bottomed flask. Fit a dry 30 cm. double surface condenser (*e.g.*, of the Davies type) into the flask by means of a sound cork. Clamp the apparatus so that the flask can be heated on a wire gauze. Weigh out 67.5 g. (53 ml.) of *n*-butyl bromide (Sections III,35 and III,37), previously dried over anhydrous sodium or magnesium sulphate. Introduce about 5 ml. of the bromide through the condenser into the flask. If no reaction sets in, warm the flask gently with a small luminous flame; remove the flame immediately reaction commences (the sodium will acquire a blue colour). When the reaction subsides, shake the contents of the flask well; this will generally produce further reaction and some of the sodium may melt. Add a further 5 ml. of *n*-butyl bromide, and shake the flask. When the reaction has slowed down, repeat the above process until all the alkyl bromide has been transferred to the flask (about 1.5 hours). Allow the mixture to stand for 1-2 hours. Then add, by means of a tap funnel fitted with a grooved cork into the top of the condenser, 50 ml. of rectified spirit dropwise over 1.5 hours, followed by 50 ml. of 50 per cent. alcohol during 30 minutes, and 50 ml. of distilled water over 15 minutes; shake the flask from time to time. Add 2-3 small pieces of porous porcelain and reflux the mixture for 3 hours; any unchanged *n*-butyl bromide will be hydrolysed. Add a large excess (500-750 ml.) of water, and separate the upper layer of crude *n*-octane (17-18 g.). Wash it once with an equal volume of water, and dry it with anhydrous magnesium sulphate. Distil from a Claisen flask with fractionating side arm or from a Widmer flask (Figs. II, 24, 2-3) and collect the fraction, b.p. 123-126° (15 g.) (2).

Notes.

(1) Remove about 30 g. of sodium from the stock-bottle, in which it is preserved under solvent naphtha or toluene or xylene. Wipe the surface free from solvent with filter paper. By means of a large knife with a heavy wooden handle (frequently termed a "sodium knife") cut off a thin surface layer, thus exposing a clean silver-coloured surface. Place the sodium cuttings from the large pieces of sodium into the "Scrap Sodium" bottle. Weigh out rapidly the necessary quantity of clean sodium on filter paper; cut it up into small pieces, place the sodium in a beaker containing sodium-dried ether, and cover the beaker with a clock-glass. It need hardly be emphasised that all flames in the vicinity must be extinguished. The sodium may be transferred to the flask when required. The ether is returned to the "Sodium Dried Ether" bottle.

(2) All hydrocarbons prepared by the Wurtz reaction contain small quantities of unsaturated hydrocarbons. These may be removed by shaking repeatedly with 10 per cent. of the volume of concentrated sulphuric acid until the acid is no longer coloured (or is at most extremely pale yellow); each shaking should be of about 5 minutes duration. The hydrocarbon is washed with water, 10 per cent sodium carbonate solution, water (twice), and dried with anhydrous magnesium or calcium sulphate. It is then distilled from sodium; two distillations are usually necessary

to obtain a perfectly pure product. The residual sodium is destroyed by treatment with methylated spirit.

COGNATE PREPARATIONS

***n*-Hexane.** Use 23 g. of sodium and 61.5 g. (45.5 ml.) of *n*-propyl bromide (Section III,34). It is advisable to employ two efficient double surface condensers in series. Collect the fraction, b.p. 68–70° (10 g.).

***n*-Decane.** Use 23 g. of sodium and 75.5 g. (62 ml.) of *n*-amyl bromide (Section III,35) or 99 g. (65.5 ml.) of *n*-amyl iodide (Section III,40). Collect the fraction, b.p. 171–174° (28 g.).

***n*-Dodecane.** Use 23 g. of sodium and 82.5 g. (70.5 ml.) of *n*-hexyl bromide (Section III,37). Collect the fraction, b.p. 94°/13 mm. (37 g.).

III.8. *n*-HEXANE (*Hydrocarbon from Grignard Reagent*)

This preparation illustrates the preparation of a liquid hydrocarbon from a Grignard reagent. The Grignard reagent from *n*-hexyl bromide may be decomposed either with dilute sulphuric acid or with solid ammonium chloride; the latter gives a somewhat better yield.

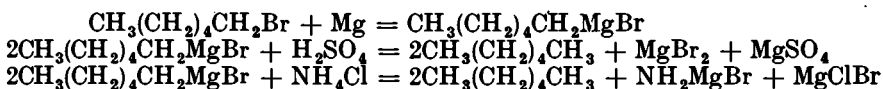

Fit a 500 or 750 ml. three-necked flask with a mercury-sealed stirrer, a 100 ml. dropping funnel and an efficient double surface condenser (Fig. II, 7, 11, *a*); place calcium chloride or cotton wool guard tubes on the funnel and condenser respectively. Arrange the flask so that it can be heated in a bath of hot water. Place 12.0 g. of magnesium turnings (1), 100 ml. of sodium-dried ether and a crystal of iodine in the flask. Weigh out 82.5 g. (70.5 ml.) of dry *n*-hexyl bromide (Section III,37) and introduce it into the separatory funnel. Run in about 10 g. of the *n*-hexyl bromide into the magnesium and ether. Set the stirrer in action. Warm the flask by surrounding it with hot water; remove the hot water immediately reaction sets in. Add the remainder of the bromide slowly and at such a rate that the reaction is under control. Continue the stirring until most of the magnesium has passed into solution (about 4 hours). Add 27 g. of A.R. ammonium chloride, and leave the reaction mixture overnight. Cool the flask in ice and add slowly a large excess of dilute hydrochloric acid; the precipitate will dissolve completely. Separate the upper ethereal layer, and wash it successively with dilute hydrochloric acid and water; dry with anhydrous magnesium or calcium sulphate. Distil the ethereal solution through an efficient fractionating column (*e.g.*, a Hempel column filled with $\frac{1}{4}$ " glass rings or $\frac{1}{8}$ " porcelain rings; a modified Hempel column; a 30 cm. all-glass Dufton column; or a Widmer column—see Sections II,15 and II,17). After the ether has passed over, *n*-hexane will distil at 67–70° (13–14 g.).

Note.

(1) Commercial magnesium turnings for the Grignard reaction should be washed with sodium-dried ether to remove any surface grease which may be present, dried at 100°, and allowed to cool in a desiccator.

III.9. *n*-OCTANE (*Clemmensen Reduction of a Ketone*)

Aliphatic hydrocarbons can be prepared by the reduction of the readily accessible ketones with amalgamated zinc and concentrated hydrochloric acid (*Clemmensen method of reduction*). This procedure is particularly valuable for the preparation of hydrocarbons with an odd number of carbon atoms where the Wurtz reaction cannot be applied; with the higher hydrocarbons some secondary alcohol is produced, which must be removed by repeated distillation from sodium.

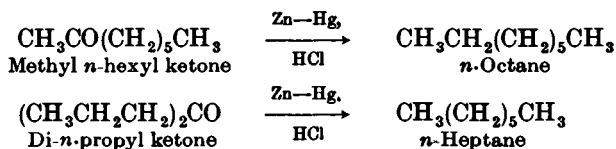

Place 125 g. of zinc wool in a 1-litre three-necked flask and amalgamate it in accordance with *Method 1* in Section II,50,13. Fit the flask with a mercury-sealed stirrer, an efficient double surface condenser, and a lead-in tube dipping almost to the bottom of the flask for the introduction of hydrogen chloride gas (compare Figs. II, 7, 11 and 12); insert an empty wash bottle between the hydrogen chloride generator and the flask. Introduce through the condenser 300 ml. of concentrated hydrochloric acid and 60 ml. of water, set the stirrer in motion, and then add 60 g. of methyl *n*-hexyl ketone (Section III,71). Pass a slow current of hydrogen chloride through the mixture; if the reaction becomes too vigorous, the passage of hydrogen chloride is temporarily stopped. After 2–3 hours most of the amalgamated zinc will have reacted. Leave the reaction mixture overnight, but disconnect the hydrogen chloride gas supply first. Remove the stirrer and the condenser from the flask. Arrange for direct steam distillation from the flask by fitting a cork into one neck, a bent tube connected to a downward condenser in the central aperture, and connect the lead-in tube to a source of steam. Stop the steam distillation when the distillate passes over as a clear liquid. Separate the upper layer, wash it twice with distilled water, dry with anhydrous magnesium or calcium sulphate, and distil from a Claisen flask with fractionating side arm. Collect the fraction, b.p. 124–126° (1). The yield of *n*-octane is 31 g.

Note.

(1) All the products of Clemmensen reductions contain small amounts of unsaturated hydrocarbons. These can be removed by repeated shaking with 10 per cent. of the volume of concentrated sulphuric acid until the acid is colourless or nearly so; each shaking should be of about 5 minutes duration. The hydrocarbon is washed with water, 10 per cent. sodium carbonate solution, water (twice), dried with anhydrous magnesium or calcium sulphate, and finally distilled twice from a Claisen flask with fractionating side arm (or a Widmer flask) over sodium.

COGNATE PREPARATION

n-Heptane, C₇H₁₆. Use 40 g. of di-*n*-propyl ketone* (Section III,72) and 100 g. of amalgamated zinc. Collect the fraction, b.p. 97–99° (26 g.).

* Satisfactory results may also be obtained with redistilled methyl *n*-amyl ketone—an inexpensive commercial product.

ETHYLENIC HYDROCARBONS (ALKENES)

III,10.

AMYLENE

Amylene is a general name for the ethylenic hydrocarbons of the molecular formula C_5H_{10} . Two of these hydrocarbons are the main products of the dehydration of the appropriate amyl alcohols:

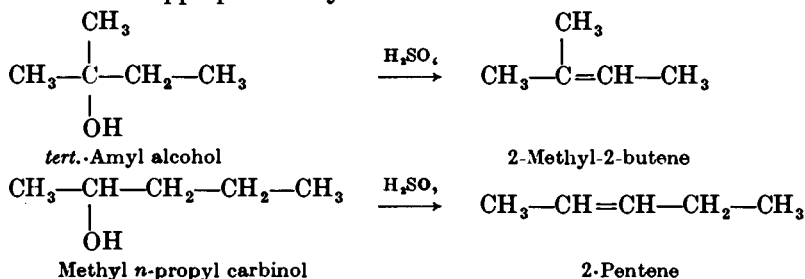

Tertiary alcohols are more readily dehydrated than secondary alcohols, whilst primary alcohols are dehydrated with comparative difficulty. Thus the reaction proceeds easily with 33 per cent. sulphuric acid (1 acid : 2 water, by volume) for *tert.*-amyl alcohol, but 50 per cent. (by volume) is required for *sec.*-amyl alcohol. Higher concentrations of acid tend to lead to increasing polymerisation of the olefine and are therefore usually avoided.

A. 2-Methyl-2-butene. Assemble an apparatus consisting of a 500 ml. round-bottomed flask, a Hempel fractionating column (filled, say, with $\frac{1}{4}$ " glass rings or with $\frac{3}{16}$ " or $\frac{1}{4}$ " porcelain rings) (1), a Liebig condenser, and a bent adapter fitted by means of a cork into a filter flask as receiver (compare Fig. II, 16, 1). Fit a thermometer (preferably 0–110° range) to the top of the column. The amylenes are highly volatile and inflammable liquids, and the necessary precautions against fire must be taken (*e.g.*, absence of flames in the vicinity, lead-off tube from the filter flask, *etc.*). Disconnect the flask. Cautiously add 25 ml. of concentrated sulphuric acid slowly and with constant stirring to 50 ml. of water contained in a small beaker (2). Cool the dilute acid, transfer it to the flask, add 40 ml. of tertiary amyl alcohol and a few fragments of porous porcelain. Reassemble the apparatus completely, making sure that all the corks are secure, and arrange for the flask to be heated on a water bath or steam bath. Heat gently and when distillation commences, regulate the temperature of the bath so that the temperature on the thermometer does not exceed 40–41° (1–2 drops per second). Stop the distillation when the temperature can no longer be maintained below 41°. The product is practically pure, but contains a little water (3). Transfer the distillate to a small conical flask and dry it over 1.5–2 g. of anhydrous magnesium sulphate or calcium chloride. The flask must be well stoppered owing to the volatility of the hydrocarbon. The yield is 15–16 g. Pure 2-methyl-2-butene boils at 38.5°.

B. 2-Pentene. Proceed as in A, but use the following quantities: 50 ml. of water and 50 ml. of concentrated sulphuric acid; 40 g. of methyl *n*-propyl carbinol (4). Collect the distillate passing over below 40°. Pure 2-pentene boils at 36.5°.

Notes.

(1) Any other efficient fractionating column may be used, *e.g.*, an all-glass Dufton column—see Sections II,15 and II,17.

(3) A slight excess of Grignard reagent should be present at this stage. The test for the presence of a Grignard reagent is as follows. Remove 0.5 ml. of the clear liquid with a dropper pipette and add 0.5 ml. of a 1 per cent. solution of Michler's ketone (4 : 4'-tetramethyldiaminobenzophenone) in benzene, followed by 1 ml. of water and 3-4 drops of 0.01M iodine in glacial acetic acid; shake. A greenish-blue colour results if a Grignard reagent is present. In the absence of iodine, the colour fades.

A dye of the diphenylmethane type is produced :

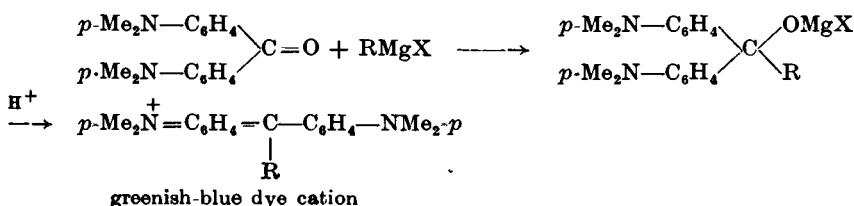

III,11. REACTIONS AND CHARACTERISATION OF ETHYLENIC HYDROCARBONS

Carry out the following tests with the sample of amylene prepared in Section III,10 (compare Section III,6).

(i) Action of bromine water. Shake 1 ml. of amylene with 2 ml. of bromine water, and note the result.

(ii) Action of bromine in carbon tetrachloride solution. To 1 ml. of amylene add 1-2 ml. of the reagent. Observe that no hydrogen bromide is evolved.

(iii) Action of potassium permanganate solution. Add 1 ml. of amylene to 2 ml. of 0.5 per cent. potassium permanganate solution and 1 ml. of dilute sulphuric acid, and shake. If the reagent is decolourised, add further small quantities.

(iv) Action of concentrated sulphuric acid. Add cautiously 1 ml. of amylene to 2 ml. of concentrated sulphuric acid. Shake very gently. Note whether any change in colour and in temperature takes place.

Cool 1 ml. of amylene in ice and add 1 ml. of cold, dilute sulphuric acid (2 acid : 1 water), and shake gently until the mixture is homogeneous. Dilute with 2 ml. of water; if an upper layer of the alcohol does not separate immediately, introduce a little sodium chloride into the mixture in order to decrease the solubility of the alcohol. Observe the odour. The unsaturated hydrocarbon is thus largely reconverted into the alcohol from which it may be prepared.

Finally, try to formulate the chemical reactions which occur in the above experiments and submit them to the instructor for comment.

CHARACTERISATION OF UNSATURATED ALIPHATIC HYDROCARBONS

Unlike the saturated hydrocarbons, unsaturated aliphatic hydrocarbons are soluble in concentrated sulphuric acid and exhibit characteristic reactions with dilute potassium permanganate solution and with bromine. Nevertheless, no satisfactory derivatives have yet been developed for these hydrocarbons, and their characterisation must therefore be based upon a determination of their physical properties (boiling point, density and refractive index). The physical properties of a number of selected unsaturated hydrocarbons are collected in Table III,11.

TABLE III,11. UNSATURATED ALIPHATIC HYDROCARBONS

Hydrocarbon	B.P.	d_{4}^{20}	n_D^{20}
1-Pentene	30°	0·641	1·371
2-Pentene	36	0·651	1·380
2-Methyl-1-butene	31	0·650	1·378
Trimethylethylene	38	0·662	1·388
1-Hexene	64	0·674	1·388
1-Heptene	93	0·697	1·400
1-Octene	121	0·716	1·409
1-Decene	169	0·742	1·422
1-Dodecene	80°/5	0·760	1·430
1-Tetradecene	125°/15	0·773	1·437
1-Hexadecene	153°/14 (m.p. 15°)	0·782	1·441
1-Octadecene	180°/18 (m.p. 18°)	0·789	1·445
Isoprene (2-methyl-1:3-butadiene)	34	0·681	1·419
Piperylene (1:3-pentadiene)	42	0·680	1·431
2 : 3-Dimethylbutadiene	69	0·726	1·439
1 : 5-Hexadiene (diallyl)	59	0·690	1·402
<i>cyclo</i> Pentene	45	0·772	1·420
<i>cyclo</i> Hexene	83	0·810	1·445
1 : 3- <i>cyclo</i> Pentadiene	42	0·803	1·443
Dicyclopentadiene	170 (m.p. 32°)	—	—
1 : 3- <i>cyclo</i> Hexadiene	81	0·841	1·474
α -Pinene	156	0·860	1·456
Dipentene (<i>dl</i> -limonene)	178	0·840	1·473
Sylvestrene	176	0·847	1·475
Camphene	160 (m.p. 51°)	—	—
1-Pentyne (<i>n</i> -Propylacetylene)	39	0·695	1·385
2-Pentyne (Ethylmethylacetylene)	56	0·712	1·404
1-Hexyne (<i>n</i> -Butylacetylene)	71	0·717	1·399
1-Heptyne (<i>n</i> -Amylacetylene)	98	0·734	1·409
1-Octyne (<i>n</i> -Hexylacetylene)	126	0·748 (25°)	1·423 (25°)
1-Nonyne (<i>n</i> -Heptylacetylene)	151	0·760	1·423
Phenylacetylene	142	0·925	1·552
Furan	31	0·937	1·422
2 : 5-Dimethylfuran	94	0·888	1·436

III,12.

cycloHEXENE

The alicyclic secondary alcohol, *cyclohexanol*, may be dehydrated by concentrated sulphuric acid or by 85 per cent. phosphoric acid to *cyclohexene*. It has a higher boiling point (82–83°) than amylene and therefore possesses some advantage over the latter in the study of the reactions of unsaturated hydrocarbons.

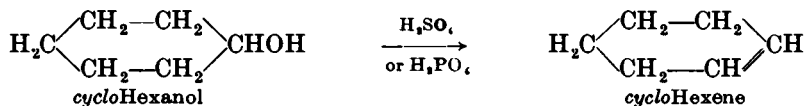

Sulphuric acid method. Place 20 g. of commercial *cyclohexanol* and 0.6 ml. of concentrated sulphuric acid in a 150 or 200 ml. round-bottomed or bolt-head flask, add 2–3 chips of porous porcelain, and mix well. Fit the flask with a fractionating column, a Liebig condenser, adapter and filter flask receiver as in Section III,10 (1). Heat the flask in an air bath (Fig. II, 5, 3) at such a rate that the temperature at the top of the column does not rise above 90°; alternatively, an oil bath, heated to a temperature of 130–140°, may be used. Stop the distillation when only a small residue remains and the odour of sulphur dioxide is apparent. Transfer the distillate to a small separatory funnel.

Saturate the distillate with sodium chloride, add 2 ml. of 5 per cent. sodium carbonate solution (to neutralise traces of free acid), and shake gently. Allow the two layers to separate, and run off the lower aqueous layer. Pour the crude *cyclohexene* through the mouth of the funnel into a small dry conical flask, add 3–4 g. of anhydrous calcium chloride or anhydrous magnesium sulphate, shake for 2–3 minutes, and allow to stand for 15 minutes with occasional shaking. Decant the dried product through a small funnel supporting a small fluted filter paper into a 25 or 50 ml. distilling flask (2), add 2–3 fragments of porous porcelain, and distil. Collect the fraction, b.p. 81–83°, in a weighed flask. If appreciable high and low boiling point fractions are obtained, combine these, dry, and redistil. The yield is 12–13 g.

Phosphoric acid method. The advantages of phosphoric acid as a dehydrating agent in this preparation are the absence of carbonisation and the freedom of the product from sulphur dioxide.

Fit a 500 ml. three-necked flask with a fractionating column (e.g., a Hempel column filled with $\frac{1}{4}$ " glass rings or $\frac{3}{16}$ " porcelain rings) carrying a thermometer at its upper end, and a separatory funnel; close the third neck with a good cork. Attach an efficient double surface condenser to the column: use a filter flask, cooled in ice, as receiver. Place 50 g. of 85 per cent. orthophosphoric acid in the flask and heat it in an oil bath at 160–170°. Add, through the funnel, 250 g. of *cyclohexanol* over a period of 1.5–2 hours. When all the *cyclohexanol* has been introduced, raise the temperature of the bath to about 200° and maintain it at this temperature for 20–30 minutes. The temperature at the top of the column should not rise above 90°. Saturate the distillate with salt (3), separate the upper layer, and dry it with anhydrous magnesium sulphate. Distil the crude *cyclohexene* through an efficient column and collect the fraction

boiling at 81–83°; the residue is largely *cyclohexanol*. The yield of *cyclohexene* is 165 g.

Notes.

(1) Alternatively, a 150 ml. Claisen flask with fractionating side arm (see Fig. II, 24, 2–5) may replace the flask and fractionating column.

(2) It is preferable to use a 25 ml. Claisen flask with fractionating side arm.

(3) The phosphoric acid may be recovered by diluting the residue in the three-necked flask with water, filtering, and then evaporating with a little nitric acid to a concentration of about 85 per cent.

The student is recommended to carry out the reactions of ethylenic hydrocarbons (Section III,11) with part of the sample of *cyclohexene*.

ACETYLENIC HYDROCARBONS (ALKYNES)

III,13.

ACETYLENE

There are no liquid alkynes which can be conveniently prepared by the elementary student. Some of the properties of acetylenic hydrocarbons may be studied with the gas, acetylene. Although the latter may be prepared in moderate yield by the addition of ethylene dibromide to a boiling alcoholic solution of potassium hydroxide or of sodium ethoxide,

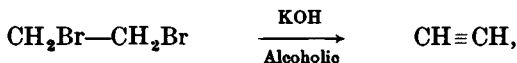

it is most conveniently prepared in the laboratory by the action of water upon calcium carbide :



The only reaction which calls for comment here is the formation of red cuprous acetylide with an ammoniacal solution of cuprous chloride :

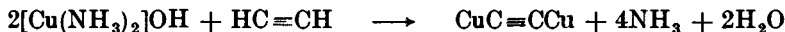

Fit a cork carrying a small dropping funnel into a dry 100 ml. distilling flask and clamp this gas generator at a convenient height in a retort stand ; make sure that the stopcock is properly lubricated. Connect the side arm of the distilling flask to an empty wash bottle or boiling tube (to act as a safety vessel) and attach a gas delivery tube to the latter. Place about 4 g. of calcium carbide lumps into the flask ; allow water to fall dropwise from the funnel upon the carbide, thus generating acetylene which will issue from the delivery tube (after displacement of the air) (1). Pass the gas through test-tubes containing 3-4 ml. of the following reagents :

(i) Bromine water. Observe any colour change and the odour of the product.

(ii) Potassium permanganate solution (2). Observe the colour change.

(iii) Ammoniacal silver nitrate solution (3). Note the formation of a white precipitate of silver acetylide, Ag_2C_2 . *This is dangerously explosive when dry*, and must be destroyed in the following manner immediately after its formation. Allow the precipitate to settle, wash it once with water by decantation, add 5 ml. of dilute nitric acid (1 vol. of conc. acid : 1 vol. of water), and warm gently until the solid is *completely* decomposed.

(iv) Ammoniacal cuprous chloride solution (4). Observe the formation of red cuprous acetylide. *Cuprous acetylide is extremely explosive when dry*, and must be destroyed immediately after its formation with dilute nitric acid in the manner detailed under (iii).

Optional experiment. When all the air has been displaced, collect a test-tube of the gas over water (by appropriate inclination of the end of the delivery tube beneath the mouth of a test-tube filled with water and supported in a beaker of water). Observe the colour and odour of the gas. Ignite the test-tube of gas, and note the luminosity of the flame and the amount of carbon deposited. Pure acetylene is almost odourless ; the characteristic odour observed is due to traces of hydrides of phosphorus, arsenic and sulphur.

Formulate the chemical reactions which occur in the above experiments and show these to the instructor for comment.

Notes.

(1) Certain mixtures of acetylene and air are explosive. All free flames in the vicinity must therefore be extinguished.

(2) Use a mixture of 4–5 drops of 0.5 per cent. potassium permanganate solution and 4 ml. of dilute sulphuric acid.

(3) Add dilute ammonia solution dropwise to 1 ml. of 0.1N silver nitrate solution until the precipitate which forms *just* redissolves, and then dilute with 3 ml. of water.

(4) Dissolve 3 g. of copper sulphate pentahydrate and 1 g. of sodium chloride in 12 ml. of hot water, and add a solution of 1 g. of sodium bisulphite in 10 ml. of 5 per cent. sodium hydroxide solution. Shake, cool under the tap, and wash the precipitated white cuprous chloride with water by decantation. Dissolve the cuprous chloride in a few ml. of concentrated ammonia solution and dilute with water to 10 ml.

ALIPHATIC ALCOHOLS

Primary alcohols, $R.CH_2OH$, may be synthesised by :—

1. Reduction of esters of monobasic acids with sodium and absolute ethyl alcohol (method of Bouveault and Blanc), for example :

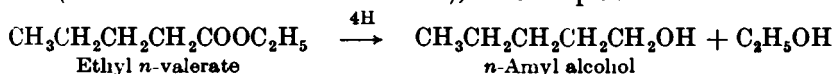

For reduction with lithium aluminium hydride, see Section VI,10.

2. Reduction of aldehydes with iron and glacial acetic acid, for example :

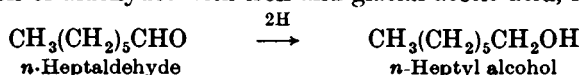

3. Action of the Grignard reagent upon formaldehyde, for example :

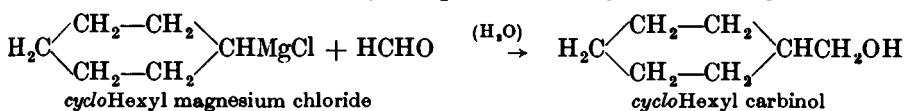

It will be observed that the length of the carbon chain is increased by one carbon atom.

4. Action of the Grignard reagent upon ethylene oxide, for example :

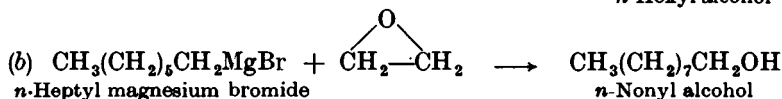
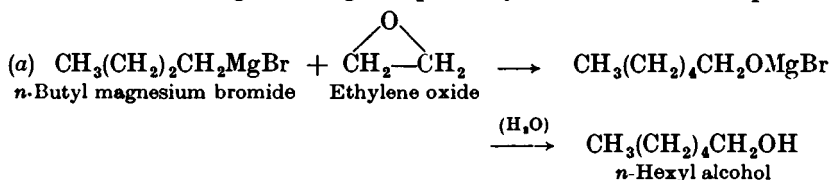

The length of the carbon chain is increased by two carbon atoms.

Secondary alcohols, $R_1R_2.CHOH$, may be synthesised by :—

1. Reduction of ketones either with sodium and absolute alcohol,* for example :

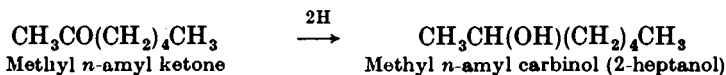

or with sodium and moist ether, for example :

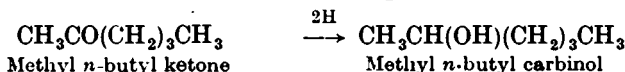

2. Action of the Grignard reagent upon an aldehyde, for example :

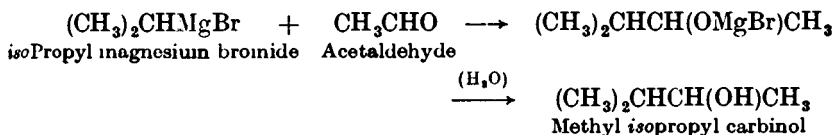

* Absolute alcohol is not essential for this reduction: 70–75 per cent. alcohol gives satisfactory results.

3. Action of the Grignard reagent upon ethyl formate, for example :

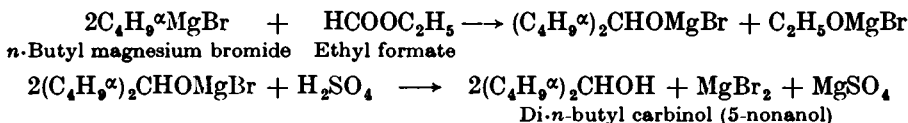

Tertiary alcohols, $\text{R}_1\text{R}_2\text{R}_3\cdot\text{COH}$, may be synthesised by :—

1. Action of the Grignard reagent upon a ketone, for example :

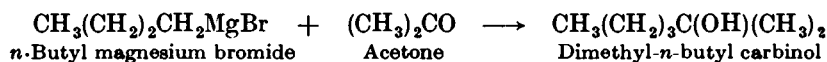

2. Action of the Grignard reagent upon diethyl carbonate, for example :

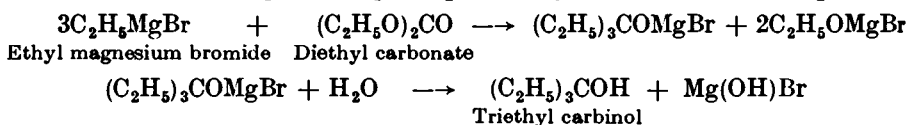

3. Action of the Grignard reagent upon esters, for example :

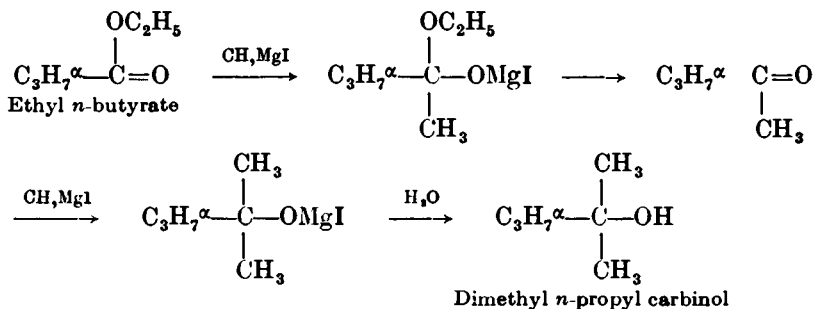

Note on the mechanism of some syntheses with the Grignard reagent

A careful study of the nature of the Grignard reagent RMgX ($\text{X} = \text{halogen}$) has revealed the fact that under suitable experimental conditions the following equilibria may be present in solution :

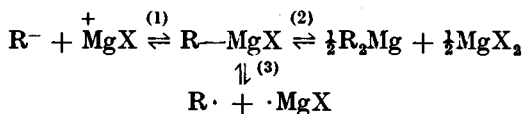

i.e., carbanions R^- , dialkyl magnesium compounds R_2Mg and free radicals $\cdot\text{MgX}$ may be present in solution. Under the usual reaction conditions, equilibria (1) and (2) are the most important ; upon addition of dioxan to an ethereal solution of a Grignard reagent the halogen-containing species $\text{R}-\text{MgX}$ and MgX_2 are precipitated and only R_2Mg remains in solution. Since $\text{R}-\text{MgX}$ and R_2Mg are similar in chemical behaviour, it is convenient to write the Grignard reagent as RMgX and remembering that any R_2Mg present in the system would exhibit similar reactivity.

The Grignard reagent RMgX is nucleophilic by virtue of the potential carbanion (alkyl anion) R^- . It will react with the electrophilic carbonyl group as follows :

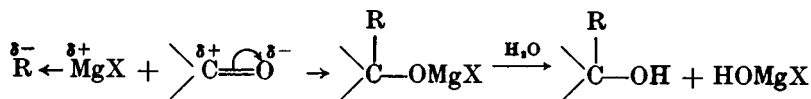

Some of the applications of the Grignard reagent described above may be expressed in general terms thus :

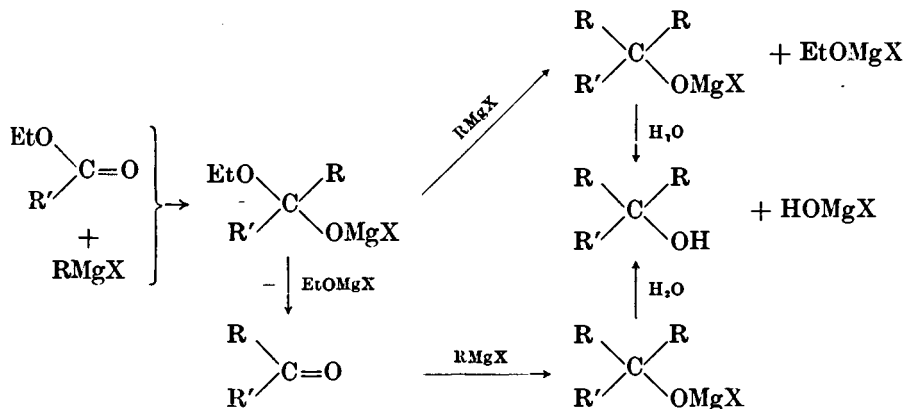
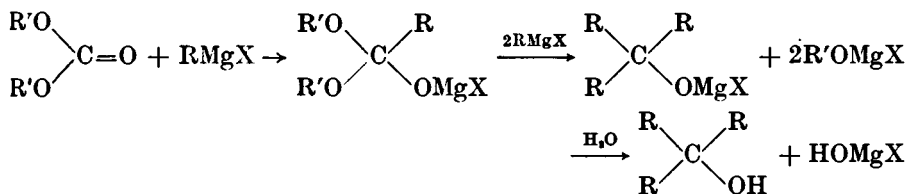
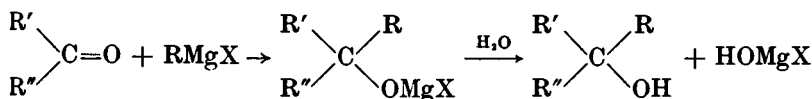
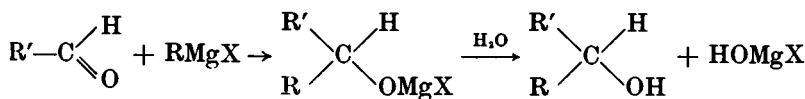
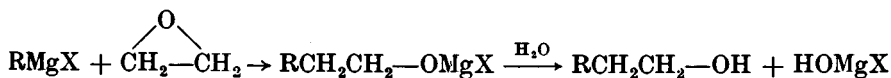

III,14. *n*-AMYL ALCOHOL (from Ethyl *n*-valerate)

Fit the central neck of a 1-litre three-necked flask with an efficient double surface condenser and close the two side necks with corks (1). Place 52 g. (59.5 ml.) of ethyl *n*-valerate (Section III,104) and 800 ml. of "super-dry" ethyl alcohol (Section II,47, 5) (2) in the flask. Add 95 g. of clean sodium in small pieces through one of the apertures at such

a rate that the vigorous refluxing is continuous (20–30 minutes). Reflux the mixture in an oil bath for 1 hour in order to be certain that all the sodium has dissolved. Replace the reflux condenser by an efficient fractionating column (*e.g.*, Hempel or modified Widmer column, all-glass Dufton column, etc.) and set the condenser for downward distillation. Fractionate the mixture from an oil bath; about 250 ml. of absolute alcohol are thus recovered. Treat the residue, consisting of *n*-amyl alcohol and sodium ethoxide, with 330 ml. of water and continue the distillation (oil bath at 110–120°) until the temperature at the top of the column reaches 83°, indicating that practically all the alcohol has been removed; about 600 ml. of approximately 90 per cent. alcohol are recovered. Remove the fractionating column and steam distil the mixture (Fig. II, 41, 1); about 200 ml. must be collected before all the alcohol is removed. Separate the crude amyl alcohol, dry it over anhydrous potassium carbonate or anhydrous calcium sulphate, and distil through a short column. Collect the fraction boiling at 137–139°. The yield of *n*-amyl alcohol is 35 g.

Notes.

(1) Alternatively, a round-bottomed flask and a Y-tube (compare Fig. II, 13, 9) may be used. The apparatus must be perfectly dry.

(2) The alcohol used must be absolute; a lower grade gives a poor yield.

III.15. TETRAMETHYLENE GLYCOL (1 : 4-BUTANEDIOL)

This is an example of the reduction of an ester of a dibasic acid to the corresponding glycol (Bouveault-Blanc reduction):

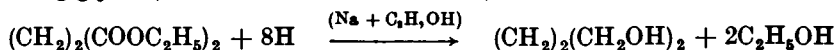

Introduce a two-way adapter (Fig. II, 13, 9) into the neck of a 3-litre round-bottomed flask; fit a separatory funnel into one neck and two efficient double surface condensers in series into the other. Place 60 g. of clean dry sodium (the surface layer must be completely removed—see Note 1 to Section III,7) in the flask, and add from the separatory funnel (protected by a drying tube) a solution of 35 g. of diethyl succinate (1) in 700 ml. of “super-dry” ethyl alcohol (Section II,47,5) as rapidly as possible consistent with the reaction being under control; it may be necessary to immerse the flask momentarily in a freezing mixture. When the vigorous action has subsided, warm the mixture on a water bath or in an oil bath at 130° until all the sodium has reacted (30–60 minutes). Allow to cool and cautiously add 25 ml. of water (2); reflux for a further 30 minutes to bring all the solid into solution and to hydrolyse any remaining ester. Add 270 ml. of concentrated hydrochloric acid to the cold reaction mixture, cool in ice, filter off the precipitated sodium chloride and treat the filtrate with 300 g. of anhydrous potassium carbonate to free it from water and acid. Filter the alcoholic solution through a large sintered glass funnel, and extract the solid twice with boiling alcohol. Distil off the alcohol from the combined solutions; towards the end of the distillation solid salts will separate. Add dry acetone, filter, and distil off the acetone. Distil the residue under diminished pressure, and collect the tetramethylene glycol at 133–135°/18 mm. The yield is 13 g.

Notes.

(1) The preparation may be adapted from the experimental details given for *Diethyl Adipate* (Section III,99). Another method is described in Section III,100.

(2) Alternatively, the following procedure for isolating the glycol may be used. Dilute the partly cooled mixture with 250 ml. of water, transfer to a distilling flask, and distil from an oil bath until the temperature reaches 95°. Transfer the hot residue to an apparatus for continuous extraction with ether (*e.g.*, Fig. II, 44, 2). The extraction is a slow process (36–48 hours) as the glycol is not very soluble in ether. (Benzene may also be employed as the extraction solvent.) Distil off the ether and, after removal of the water and alcohol, distil the glycol under reduced pressure from a Claisen flask.

COGNATE PREPARATION

Hexamethylene glycol, $\text{HO}(\text{CH}_2)_6\text{OH}$. Use 60 g. of sodium, 81 g. of diethyl adipate (Sections III,99 and III,100) and 600 ml. of "super-dry" ethyl alcohol. All other experimental details, including amounts of water, hydrochloric acid and potassium carbonate, are identical with those for *Tetramethylene Glycol*. The yield of hexamethylene glycol, b.p. 146–149°/17 mm., is 30 g. The glycol may also be isolated by continuous extraction with ether or benzene.

Note. Both tetramethylene glycol (1:4-butanediol) and hexamethylene glycol (1:6-hexanediol) may be prepared more conveniently by copper-chromium oxide reduction (Section VI,6) or, for small quantities, by reduction with lithium aluminium hydride (see Section VI,10).

III,16. *n*-HEPTYL ALCOHOL (from *n*-Heptaldehyde)

Place into a 3-litre round-bottomed flask, fitted with a mechanical stirrer (1) and a short reflux condenser, 450 g. of grease-free iron filings, 750 ml. of glacial acetic acid, 750 ml. of water, and 112.5 g. (137.5 ml.) of freshly distilled *n*-heptaldehyde, b.p. 154–156°. Heat the mixture on a water bath, with stirring (1), for 2–4 hours; if the frothing is considerable, remove the mixture momentarily from the water bath. Steam distil the reaction product directly from the flask until no more oily drops pass over (*ca.* 2 litres of distillate). Separate the oil; a further small quantity may be obtained by saturating the aqueous layer with salt. Heat the crude *n*-heptyl alcohol with 250 ml. of 20 per cent. sodium hydroxide solution with stirring or vigorous hand shaking on the water bath for 2 hours; this will hydrolyse the small proportion of *n*-heptyl acetate which is present. Allow to cool and separate the oil (2). Dry it with a little anhydrous potassium carbonate or anhydrous calcium sulphate, and distil. Collect the fraction, b.p. 173–176°, as pure *n*-heptyl alcohol. The yield is 90 g.

Notes.

(1) Stirring is not essential, but is advantageous since it reduces considerably the danger of frothing or foaming over. If mechanical stirring is not employed, the mixture must be shaken by hand from time to time, and the period of heating on the water bath increased to 6–8 hours.

(2) A further small quantity of *n*-heptyl alcohol may be obtained from the alkaline solution by mixing it with 50 ml. of water and distilling: the distillate is saturated with salt, the oil separated, dried and distilled from a small flask.

III,17. cycloHEXYLCARBINOL (*from cycloHexyl Chloride*)

Set up a 1-litre three-necked flask with a mercury-sealed stirrer, a 500 ml. separatory funnel, and a double surface condenser to the upper end of which a drying tube (containing cotton wool or anhydrous calcium chloride) is attached (compare Fig. II, 7, 11). All parts of the apparatus must be dry. Partially immerse the flask in a bath of water. Place 26.7 g. of magnesium turnings "for Grignard reaction" and a crystal of iodine in the flask. (The turnings should have been washed with a little sodium-dried ether to remove surface grease, dried at 100–120°, and allowed to cool in a desiccator.) Measure out in separate dry vessels 121 ml. (118.5 g.) of *cyclohexyl chloride* (Section III,32) and 450 ml. of sodium-dried ether. Introduce about 100 ml. of the ether and 15 ml. of the chloride into the flask. Heat the water bath so that the ether refluxes gently in order to start the reaction. When the reaction has commenced remove the water bath (cool, if necessary), set the stirrer in motion and add sufficient ether to cover the magnesium; then introduce the remainder of the *cyclohexyl chloride* dissolved in the residual ether during 30–45 minutes. If the reaction becomes too vigorous, cool the flask in ice-water. Continue the refluxing and stirring for 15–20 minutes to complete the formation of the Grignard reagent.

Replace the separatory funnel by a wide rubber tube fitted over the neck of the flask, and attach to this a small conical flask (Fig. II, 7, 12, c) charged with 50 g. of paraformaldehyde, which has been previously dried in a vacuum desiccator over phosphorus pentoxide (1). Stir the mixture vigorously and gradually add the paraformaldehyde by suitably inclining the conical flask. After 2 hours transfer the reaction mixture to a 2-litre bolt-head flask; provide for mechanical stirring of its contents. Add 300 g. of finely crushed ice all at once and vigorously agitate the mixture until the decomposition is complete. Add twice the theoretical quantity of 30 per cent. sulphuric acid to dissolve the magnesium hydroxide, and then steam distil the mixture until no more oil passes over (2000–2500 ml.). Saturate the distillate with sodium chloride and separate the upper ether-alcohol layer. Dry with anhydrous potassium carbonate and distil off the ether on a water bath. Add 5 g. of freshly dehydrated lime and heat on a water bath for 30 minutes; this will remove the last traces of water and give a halogen-free product. Filter into a Claisen flask with fractionating side arm, wash with a little anhydrous ether, remove the ether, and distil the residual alcohol under diminished pressure. Collect the fraction of b.p. 88–93°/18 mm.: most distils at 91°/18 mm. The yield is 50 g. The boiling point of *cyclohexylcarbinol* at atmospheric pressure is 182°.

Notes.

(1) An improved yield (*ca.* 75 g.) may be obtained by substituting gaseous formaldehyde for paraformaldehyde. The former is obtained by placing 50 g. of paraformaldehyde, previously dried for 2 days over phosphorus pentoxide, in a 500 ml. round-bottomed flask provided with an inlet tube for admitting dry nitrogen. The flask is heated in an oil bath at 180–200°, and the formaldehyde vapour (produced by depolymerisation) is carried into the Grignard reagent by a slow stream of nitrogen through a wide glass tube (12 mm. in diameter) fitted into the neck of the flask. The entry tube should terminate about 1 cm. above the surface of the solution; clogging, due to repolymerised formaldehyde, is thus largely avoided.

By using di-*n*-butyl ether (see Section III,19) as solvent, paraformaldehyde may be employed instead of gaseous formaldehyde without appreciable influence upon the yield. The high boiling point (141°) of *n*-butyl ether obviates the necessity of depolymerising the paraformaldehyde as a separate operation. The Grignard reagent is prepared (Section III,19, Note 1) with *n*-butyl ether as solvent using the proportions of reagents given above. The solution is heated to 100–110° in an oil bath, and 100 g. of dry paraformaldehyde is added in small portions (compare Fig. 11, 7, 12, *c* or *d*) to the well-stirred solution over 2 hours. The product is isolated as above; 70 g. of cyclohexylcarbinol, b.p. 88–93°/18 mm., are obtained.

III,18. *n*-HEXYL ALCOHOL (from *n*-Butyl Bromide)

The apparatus required is identical with that described in Section III,17. Place 37.5 g. of magnesium turnings and a small crystal of iodine in the flask. Prepare a solution of 205.5 g. (161 ml.) of *n*-butyl bromide (Sections III,35–III,37) in 500 ml. of sodium-dried ether. Introduce about 50 ml. of the solution into the flask; if the reaction does not commence immediately, heat the flask on a water bath so that the ether just refluxes. As soon as the reaction commences, cover the magnesium with 100 ml. of anhydrous ether; set the stirrer in motion and run in the remainder of the *n*-butyl bromide solution at such a rate that the mixture boils steadily (about 30 minutes). Cool the flask in a freezing mixture of ice and salt. Remove the separatory funnel and replace it by a tube, 4 mm. in diameter, the end of which is about 2 cm. above the surface of the liquid. Attach this delivery tube to a flask fitted with "wash bottle" tubes, the long tube being nearer the three-necked flask and the other end being connected to a supply of dry nitrogen. Cool this flask in a mixture of ice and salt and introduce rapidly 90 g. of ethylene oxide from a 100 g. sealed bulb of the reagent; the latter must, of course, be cooled in an ice and salt mixture before opening (1). Gradually introduce the ethylene oxide into the reaction flask over a period of 1.5–2 hours; the temperature should not rise above 10°. When all has been added, remove the freezing mixture surrounding the three-necked flask. The temperature of the mixture will gradually rise and the reaction mixture will boil gently. When boiling ceases, reflux on a water bath for 30 minutes. Allow to cool, insert a thermometer into a neck of the flask, arrange the condenser for downward distillation and collect 250 ml. of ether in a measuring cylinder; do not collect a larger volume of ether as a violent reaction may set in, apparently due to a rearrangement of the initial reaction product, and considerable loss may ensue. Change the receiver, and introduce 250 ml. of sodium-dried benzene into the reaction mixture. Continue the distillation with stirring until the temperature of the distilling vapour reaches 65°. Then boil the mixture under reflux for 30 minutes; generally by this time the mixture has become so viscous that stirring is no longer very effective. Allow to cool. Decompose the reaction mixture with 500 ml. of an ice-water mixture, and dissolve the precipitated magnesium hydroxide with 30 per cent. sulphuric acid; add sufficient finely-crushed ice to keep the mixture cold. Steam distil and collect about 2 litres of distillate. Separate the oily layer (*A*), and distil the aqueous layer until free of *n*-hexyl alcohol; add the oil so obtained to (*A*). Stir the crude *n*-hexyl alcohol on a water bath with 250 ml. of 20 per cent. sodium hydroxide

solution, and steam distil again as before. Dry the oil with a little anhydrous calcium sulphate, distil through an efficient fractionating column, and collect the fraction, b.p. 154–157°. The yield of *n*-hexyl alcohol is 90 g.

Note.

(1) Instead of adding the liquid ethylene oxide (b.p. 10–5°), the latter may be dissolved in 100 ml. of ice-cold anhydrous ether; this solution is added during 15–30 minutes. The yield, however, is somewhat lower.

III,19. *n*-NONYL ALCOHOL (from *n*-Heptyl Bromide)

This preparation is an example of the use of di-*n*-butyl ether as a solvent in the Grignard reaction. The advantages are: it is comparatively inexpensive, it can be handled without excessive loss due to evaporation, simple distillation gives an ether free from moisture and alcohol, and the vapour does not form explosive mixtures with air. *n*-Butyl ether cannot, of course, be employed when the boiling point of the neutral reaction product is close to 140°.

Prepare a Grignard reagent from 24·5 g. of magnesium turnings, 179 g. (157 ml.) of *n*-heptyl bromide (Section III,37), and 300 ml. of di-*n*-butyl ether (1). Cool the solution to 0° and, with vigorous stirring, add an excess of ethylene oxide. Maintain the temperature at 0° for 1 hour after the ethylene oxide has been introduced, then allow the temperature to rise to 40° and maintain the mixture at this temperature for 1 hour. Finally heat the mixture on a water bath for 2 hours. Decompose the addition product and isolate the alcohol according to the procedure for *n*-hexyl alcohol (Section III,18); the addition of benzene is unnecessary. Collect the *n*-nonyl alcohol at 95–100°/12 mm. The yield is 95 g.

Note.

(1) Commercial *n*-butyl ether is purified by washing with sodium hydroxide solution, water, drying with anhydrous calcium chloride, and then fractionating. The fraction, b.p. 140–142°, is collected.

The general procedure for the preparation of Grignard reagents in *n*-butyl ether solution may be adapted from the following description of a small scale experiment. A 200 ml. three-necked flask is fitted with a mechanical stirrer, separatory funnel, reflux condenser and thermometer. A mixture of 40 ml. of *n*-butyl ether, 1·5 g. of magnesium turnings and a small crystal of iodine is placed in the flask. The theoretical amount of the halogen compound, dissolved in sufficient *n*-butyl ether to make a total volume of 30 ml., is placed in the funnel. A small amount of the solution of the halogen compound is added and the flask is heated until the reaction commences—the exact temperature varies according to the nature of the halogen compound. Once the reaction has started, stirring is begun, and the remainder of the solution is added at a rate which permits the reaction to proceed smoothly. After the addition of the halogen compound, stirring is continued until the mixture cools to the temperature of the laboratory.

III,20. METHYL *n*-AMYL CARBINOL

(from Methyl *n*-Amyl Ketone)

Place a mixture of 114 g. (140 ml.) of methyl *n*-amyl ketone (2-heptanone) (1), 300 ml. of rectified spirit (95 per cent. ethyl alcohol) and 100 ml. of water (2) in a 1500 ml. three-necked flask or in a 1500 ml. round-bottomed flask provided with a two-way addition tube (Fig. II, 13, 9). Attach an efficient double surface condenser to the flask and close the

other opening with a cork ; with a three-necked flask, the third neck should carry a thermometer dipping into the liquid. Add 65 g. of clean sodium, preferably in the form of wire (Section II,47,1) although small pieces may be used with somewhat inferior results, gradually and at such a rate that the reaction is under control ; cool the flask in running water or in ice during the addition. The temperature should not rise above 30°. When the sodium has *completely* reacted, add 1 litre of water and cool the mixture to about 15°. Separate the upper layer, wash it with 25 ml. of dilute hydrochloric acid (1 : 1), then with 25 ml. of water, and dry with anhydrous potassium carbonate or anhydrous calcium sulphate. Distil through an efficient fractionating column and collect the methyl *n*-amyl carbinol (2-heptanol) at 156–158°. The yield is 75 g.

Notes.

(1) The ketone may be synthesised as in Section III,152 ; it is also available commercially. The latter should first be dried, redistilled, and the fraction, b.p. 150–152°, collected.

(2) Absolute alcohol may be used, but this is not essential.

III,21. METHYL *n*-BUTYL CARBINOL

(from Methyl *n*-Butyl Ketone)

Use the apparatus detailed in Section III,20. Dissolve 100 g. (123 ml.) of methyl *n*-butyl ketone (2-hexanone) (Section III,152) in 750 ml. of ether and add 150 ml. of water. Introduce 69 g. of clean sodium in the form of wire (or small pieces) as rapidly as possible ; the reaction must be kept under control and, if necessary, the flask must be cooled in ice or in running water. When all the sodium has reacted, separate the ethereal layer, wash it with 25 ml. of dilute hydrochloric acid (1 : 1), then with water, dry with anhydrous potassium carbonate or with anhydrous calcium sulphate, and distil through a fractionating column. Collect the fraction of b.p. 136–138°. The yield of methyl *n*-butyl carbinol (2-hexanol) is 97 g.

COGNATE PREPARATION

*cyclo*Pentanol, $\begin{array}{l} \text{CH}_2-\text{CH}_2 \\ | \\ \text{CH}_2-\text{CH}_2 \end{array} \text{CHOH}$. Use *cyclopentanone* (Section III,

73) ; collect the fraction, b.p. 139–142°.

III,22. METHYL *iso*-PROPYL CARBINOL

The broad experimental details, including the apparatus, are similar to those given in Section III,17. The apparatus and reagents must be perfectly dry. Place 49 g. of dry magnesium turnings and 90 ml. of sodium-dried ether in the flask. Prepare a solution of 200 g. (154 ml.) of *iso*-propyl bromide (Section III,34) in 100 ml. of anhydrous ether and place it in the dropping funnel ; insert a cotton wool or calcium chloride guard tube in the mouth of the latter. Run in about 15 ml. of the bromide solution into the flask. The reaction should start almost immediately ; if it does not, warm gently on a water bath. Once the reaction has commenced, add the bromide solution at such a rate that the reaction mixture refluxes gently (60–90 minutes). If the refluxing becomes too

vigorous, cool the flask with running water. Finally reflux the reaction mixture on a water bath for 30 minutes. Cool the flask to -10° to -5° in a freezing mixture of crushed ice and salt or of crushed ice and anhydrous calcium chloride, and add a solution of 67 g. (83.5 ml.) of acetaldehyde (1) in 90 ml. of anhydrous ether over a period of 30 minutes. Do not allow the temperature to rise above -5° . When all the acetaldehyde has been added, pour the reaction product upon 700 g. of crushed ice; the excess of magnesium should remain in the flask. Dissolve the basic magnesium bromide by the addition of 350 ml. of 15 per cent. sulphuric acid. Separate the ethereal solution and extract the aqueous layer with four 50 ml. portions of ether. Dry the combined ethereal solutions over 8 g. of anhydrous potassium carbonate (or the equivalent quantity of anhydrous calcium sulphate), and fractionally distil through an all-glass Dufton (or other efficient fractionating) column. Collect the methyl *iso*-propyl carbinol at 110–111.5°. The yield is 70 g.

Note.

(1) The acetaldehyde should be freshly distilled (b.p. $20.5-21^{\circ}$). It can be conveniently prepared by depolymerising pure dry paraldehyde (see Section III,65).

III,23. DI-*n*-BUTYL CARBINOL (from *n*-Butyl Bromide)

The broad experimental details, including the apparatus, are similar to those given in Section III,17. All the reagents and the apparatus must be perfectly dry. Place 12.2 g. of dry magnesium turnings, a small crystal of iodine, and 170 ml. of sodium-dried ether in the flask. Prepare a solution of 69 g. (54 ml.) of *n*-butyl bromide (Sections III,35 and III,37) in 90 ml. of anhydrous ether, place it in the separatory funnel and protect it by a calcium chloride (or cotton wool) guard tube. Set the stirrer in motion and run 10–15 ml. of the bromide solution into the flask. The reaction soon commences and, within a few minutes, the refluxing is vigorous. When this occurs, surround the flask by an ice-water mixture, and add the bromide solution at such a rate that moderate refluxing occurs. Remove the cooling bath after the solution has been added (15–20 minutes) and continue the stirring for a further 15 minutes; only a small residue of magnesium should remain. Cool the flask in ice. Place a solution of 18.5 g. (20 ml.) of pure ethyl formate (1) in 40 ml. of anhydrous ether in the separatory funnel. Stir the solution of the Grignard reagent and run in the ethyl formate solution at such a rate that the ether refluxes gently (10–15 minutes). Remove the ice bath and continue the stirring for 10 minutes.

Place 35 ml. of water in the separatory funnel and run it into the *vigorously stirred* reaction mixture at such a rate that rapid refluxing occurs. Follow this by a cold solution of 15.5 ml. of concentrated sulphuric acid in 135 ml. of water. Two practically clear layers will now be present in the flask. Decant as much as possible of the ethereal layer (A) into a 500 ml. round-bottomed flask. Transfer the remainder, including the aqueous layer, into a separatory funnel: wash the residual solid with two 10 ml. portions of ether and combine these washings with the liquid in the separatory funnel. Separate the ethereal portion and combine it with (A). Distil off the ether through an efficient fraction-

ating column until the temperature of the vapour rises to about 50°. The residual crude di-*n*-butyl carbinol contains a little of the formic ester of the carbinol. Remove the latter by refluxing for 3 hours with 25 ml. of 15 per cent. aqueous potassium hydroxide, and then isolate the purified carbinol by steam distillation (volume of distillate about 500 ml.). Separate the upper layer of the secondary alcohol, dry it over anhydrous potassium carbonate or anhydrous calcium sulphate, and distil from a Claisen flask under reduced pressure. Collect the pure di-*n*-butyl carbinol at 97–98°/20 mm.; the yield is 30 g. The boiling point under atmospheric pressure is 195°.

Note.

(1) Freshly distilled ethyl formate must be used. Commercial ethyl formate may be purified as follows. Allow the ethyl formate to stand for 1 hour with 15 per cent. of its weight of anhydrous potassium carbonate with occasional shaking. Decant the ester into a dry flask containing a little fresh anhydrous potassium carbonate and allow to stand for a further hour. Filter into a dry flask and distil through an efficient fractionating column, and collect the fraction, b.p. 53–54°; protect the receiver from atmospheric moisture.

III,24. DIMETHYL *n*-BUTYL CARBINOL

Experimental details devised for elementary students (*Method A*) and for advanced students (*Method B*) will be given for this preparation.

Method A. All the apparatus and reagents must be thoroughly dry. The *n*-butyl bromide should be dried over anhydrous sodium, magnesium or calcium sulphate and the A.R. acetone over a similar desiccant or over anhydrous potassium carbonate. Fit a 500 ml. round-bottomed flask with a two-way adapter or addition tube (Fig. II, 1, 8); into the two necks of the latter insert respectively a dropping funnel and a double surface condenser, each carrying a calcium chloride or cotton wool guard tube (compare Fig. II, 13, 9). Place 6.1 g. of magnesium turnings (previously washed with anhydrous ether and dried at 100–120°), a small crystal of iodine and 30 ml. of sodium-dried ether (Section II,47,1) in the flask, and a solution of 34 g. (27 ml.) of *n*-butyl bromide (Sections III,35–III,37) in 25 ml. of sodium-dried ether in the dropping funnel. Add 3–4 ml. of the bromide solution to the magnesium: a vigorous reaction should occur within a few minutes. When the reaction is well under way introduce 50 ml. of anhydrous ether through the condenser. Continue the addition of the solution of *n*-butyl bromide in ether at such a rate that the ether refluxes gently; if the reaction becomes too vigorous at any time, it may be moderated by immersing the flask in cold water. Shake the reaction flask frequently. After all, or practically all, of the magnesium has disappeared, add slowly, with frequent shaking and cooling of the flask by immersion in cold water, a solution of 15 g. (19 ml.) of A.R. acetone in 15 ml. of anhydrous ether. Each drop of acetone reacts with a hissing noise and eventually the addition product separates from the ethereal solution as a grey viscous solid.

Decompose the addition product by the careful addition of a solution of 32 g. (17.5 ml.) of concentrated sulphuric acid in 175 ml. of water during about 30 minutes. Cool the flask in ice and shake frequently during the addition of the cold, dilute acid; the precipitate will decompose

completely. Transfer the mixture to a separatory funnel, separate the two layers; keep both layers. Extract the lower aqueous layer with two 40 ml. portions of ether. Combine the ether extracts with the ether layer from the first separation and dry with anhydrous potassium carbonate. Filter the solution, remove the ether using the apparatus of Fig. II, 13, 4, and fractionally distil the residue. Collect the dimethyl *n*-butyl carbinol at 137–141°. The yield is 27 g.

Method B. The apparatus and experimental details are similar to those given in Sections III,17 and III,22. Prepare a Grignard reagent from 24.5 g. of magnesium turnings, a crystal of iodine, 137 g. (107 ml.) of *n*-butyl bromide and 450 ml. of sodium-dried ether. Add slowly with rapid stirring, and cooling with ice if necessary, a solution of 58 g. (73.5 ml.) of dry A.R. acetone in 75 ml. of anhydrous ether. Allow the reaction mixture to stand overnight. Decompose the product by pouring it on to 500 g. of crushed ice; dissolve the precipitated magnesium compounds by the addition of 10 per cent. hydrochloric acid or of 15 per cent. sulphuric acid. Transfer to a separatory funnel, remove the ether layer, and extract the aqueous solution with three 50 ml. portions of ether. Dry the combined ethereal solutions over anhydrous potassium carbonate or anhydrous calcium sulphate, filter, distil off the ether, and fractionate. Collect the dimethyl *n*-butyl carbinol at 137–141°. The yield is 105 g.

COGNATE PREPARATION

Dimethyl *n*-propyl carbinol, $\text{CH}_3(\text{CH}_2)_2\text{COH}(\text{CH}_3)_2$. From *n*-propyl magnesium bromide and acetone. Collect the tertiary alcohol at 121–124°.

III,25.

TRIETHYL CARBINOL

The apparatus required and the general experimental details are similar to those given in Section III,17. The apparatus and reagents must be perfectly dry. Place 36 g. of dry magnesium turnings and 275 ml. of sodium-dried ether in a 1-litre three-necked flask. Commence the reaction by adding 2 ml. (3 g.) of dry ethyl bromide (Section III,35) through the separatory funnel without stirring. Set the stirrer in motion and introduce a solution of 160 g. (109.5 ml.) of ethyl bromide in 350 ml. of anhydrous ether at such a rate that the mixture refluxes gently; the addition occupies about 45 minutes. Cool the flask externally during the addition; it is a good plan to fold a towel in a narrow strip, wrap it about the flask above the ether level and then to place crushed ice on top of the flask. After the bromide solution has been added, continue the stirring for a further 15 minutes.

Now run in a solution of 52 g. (53.5 ml.) of pure diethyl carbonate (1) in 70 ml. of anhydrous ether, with rapid stirring, over a period of about one hour. A vigorous reaction sets in and the ether refluxes continually. When the diethyl carbonate has been added, heat the flask on a water bath with stirring for another hour. Pour the reaction mixture, with frequent shaking, into a 2-litre round-bottomed flask containing 500 g. of crushed ice and a solution of 100 g. of ammonium chloride in 200 ml. of water. Transfer to a separatory funnel, remove the ether layer, and extract the aqueous solution with two 175 ml. portions of ether. Dry

the combined ethereal extracts with anhydrous potassium carbonate or with anhydrous calcium sulphate, and remove the ether on a water bath. Distil the alcohol, preferably from a Claisen flask with a fractionating side arm or through a short column. Collect the fraction boiling at 139–142° as pure triethyl carbinol (3-ethyl-3-pentanol). A further small quantity may be obtained by drying the low-boiling fraction with 2 g. of anhydrous potassium carbonate or anhydrous calcium sulphate, filtering and redistilling. The total yield is 44 g.

Note.

(1) Commercial diethyl carbonate may be purified by the following process. Wash 100 ml. of diethyl carbonate successively with 20 ml. of 10 per cent. sodium carbonate solution, 20 ml. of saturated calcium chloride solution, and 25 ml. of water. Allow to stand for one hour over anhydrous calcium chloride with occasional shaking, filter into a dry flask containing 5 g. of the same desiccant, and allow to stand for a further hour. Distil and collect the fraction boiling at 125–126°. Diethyl carbonate combines with anhydrous calcium chloride slowly and prolonged contact should therefore be avoided. Anhydrous calcium sulphate may also be used.

COGNATE PREPARATIONS

The following tertiary alcohols may be prepared from the appropriate Grignard reagent and diethyl carbonate in yields of 75–80 per cent.

Tri-*n*-propyl carbinol. B.p. 89–92°/20 mm.

Tri-*n*-butyl carbinol. B.p. 129–131°/20 mm.

Tri-*n*-amyl carbinol. B.p. 160–163°/19 mm.

III,26. DIMETHYL *n*-PROPYL CARBINOL

The broad experimental details will be evident from those described in the previous experiments, particularly Sections III,17 and III,22. Place 49 g. of dry magnesium turnings and 100 ml. of sodium-dried ether in a 1-litre three-necked flask and a solution of 284 g. (124.5 ml.) of dry methyl iodide (Section III,40) in 300 ml. of anhydrous ether in the separatory funnel protected by a cotton wool or calcium chloride guard tube. Run in about 15 ml. of the iodide solution. The reaction should start within a few minutes: if it does not, warm gently on a water bath and add a crystal of iodine, if necessary. Once the reaction has commenced, remove the water bath, add the iodide solution, with stirring, at such a rate that the mixture refluxes gently; if the reaction becomes too vigorous, cool the flask in ice water. Finally reflux the reaction mixture until all, or most, of the magnesium has reacted. Allow to cool, and slowly add a solution of 116 g. (132 ml.) of ethyl *n*-butyrate (1) in 100 ml. of anhydrous ether into the vigorously stirred solution of the Grignard reagent. Reflux the mixture on a water bath for one hour to complete the reaction. Pour the ethereal solution into a mixture of 200 ml. of approximately 4*N*-sulphuric acid and 750 g. of crushed ice. Separate the upper ethereal layer and extract the aqueous solution with two 150 ml. portions of ether. Wash the combined ethereal extracts with dilute sodium bicarbonate solution, followed by a little water, then dry with anhydrous potassium carbonate or anhydrous calcium sulphate, distil off the ether on a water bath, and distil the residue from a Claisen flask with fractionating side arm or through a short column. Collect

the dimethyl-*n*-propyl carbinol (2-methyl-2-pentanol) at 117–120°. A further small quantity of the tertiary alcohol may be obtained by redrying the low-boiling distillate, filtering and redistilling. The yield is 90 g.

Note.

(1) Ethyl *n*-butyrate may be prepared as described in Section III,95.

COGNATE PREPARATION

Dimethyl ethyl carbinol (2-methyl-2-butanol or *tert.*-amyl alcohol), $\text{CH}_3\text{CH}_2\text{COH}(\text{CH}_3)_2$. From ethyl propionate and methyl magnesium iodide. Collect the tertiary alcohol at 100–102°.

III,27. REACTIONS AND CHARACTERISATION OF ALIPHATIC ALCOHOLS

Carry out the following simple experiments ; these have been selected to illustrate some of the general properties of alcohols.

(i) **Miscibility with water.** Measure out 3.1 ml. (2.5 g.) of *n*-butyl alcohol into a dry 100 ml. conical or flat-bottomed flask provided with a well-fitting stopper. From a burette add distilled water to the alcohol, a few drops at a time and shake vigorously after each addition, until a slight but permanent turbidity is produced. Note the volume of water added and calculate the solubility of water in *n*-butyl alcohol at the temperature of the laboratory. Continue the addition of water, 2–3 ml. at a time and with vigorous shaking, until the contents of the flask are just homogeneous : near the point of homogeneity the additions should be reduced to portions of 1 ml. Note the *total* volume of water which has been added from the burette, and calculate the solubility of *n*-butanol in water at the temperature of the laboratory.

The student will doubtless be aware of the fact that methyl, ethyl, *n*-propyl and *iso*-propyl alcohols are completely miscible with water. The solubilities of the higher alcohols decrease progressively as the carbon content increases. The solubilities of all types of alcohols with five carbon atoms or more are quite small. For the isomeric butyl alcohols the solubilities (g. per 100 g. of water at 20°) are: *n*-butyl, 8; *iso*-butyl, 23; *sec.*-butyl, 13; *tert.*-butyl, completely miscible.

Divide the saturated solution of *n*-butyl alcohol in water into three approximately equal parts. Treat these respectively with about 2.5 g. of sodium chloride, potassium carbonate and sodium hydroxide, and shake each until the solids have dissolved. Observe the effect of these compounds upon the solubility of *n*-butanol in water. These results illustrate the phenomenon of **salting out** of organic compounds, *i.e.*, the decrease of solubility of organic compounds in water when the solution is saturated with an inorganic compound. The alcohol layer which separates is actually a saturated solution of water in *n*-butyl alcohol.

(ii) **Miscibility with hydrocarbons.** Mix 2 ml. of liquid paraffin or paraffin oil with 2 ml. of absolute ethyl alcohol (or absolute methylated spirit) in a dry test-tube and determine whether they are completely miscible. Add a drop of water, shake and observe the result (compare Section I,8).

Shake 2 ml. of paraffin oil or liquid paraffin with an equal volume of rectified spirit (95 per cent. ethyl alcohol). Explain the result.

Shake 1 ml. of anhydrous methyl alcohol with 1 ml. of paraffin oil. Repeat the experiment with 1 ml. of *n*-butyl alcohol. From your results state which is the better solvent for paraffin oil (a mixture of higher hydrocarbons) and thus explain why *n*-butanol and higher alcohols are incorporated in pyroxylin lacquers in preference to methyl and ethyl alcohols.

(iii) **Drying of alcohols.** Place 2 ml. of methyl alcohol, *n*-butyl alcohol and *cyclohexanol* in three separate test-tubes, and add about 0.5 g. of anhydrous calcium chloride to each. Shake and observe the result (evolution of heat and chemical reaction). Stopper the tubes and leave overnight. Do your results explain why anhydrous calcium chloride cannot be employed for drying alcohols ?

(iv) **Reaction with sodium.** Treat 2 ml. of absolute methyl alcohol with a small thin slice of dry, freshly-cut sodium (handle with tongs or a penknife). Observe the result. Cool the solution when *all* the sodium has reacted. Add a little water and test the solution with litmus paper.

Obtain five small dry test-tubes (75 × 10 mm.) and introduce 1 ml. of the following alcohols into each : ethyl alcohol, *n*-butyl alcohol, *sec*-butyl alcohol, *cyclohexanol* and *tert*-butyl alcohol. Add a minute fragment of sodium to each and observe the rate of reaction. Arrange the alcohols in the order of decreasing reactivity towards sodium.

The reaction with sodium is by no means an infallible practical test for alcohols since, strictly speaking, it is applicable only to pure anhydrous liquids. Traces of water, present as impurities, would give an initial evolution of hydrogen, but reaction would stop after a time if an alcohol is absent : furthermore, certain esters and ketones also evolve hydrogen when treated with sodium (compare Section XI,7,6). It may, however, be assumed that if no hydrogen is evolved in the test, the substance is not an alcohol.

(v) **Reaction with acetyl chloride.** Treat 1 ml. of the alcohols enumerated in (iv) cautiously with 0.5–0.7 ml. of acetyl chloride. Observe the reaction which occurs. After 2–3 minutes, pour the contents of the various test-tubes into 3 ml. portions of water, neutralise the aqueous layer with solid sodium bicarbonate, and examine the residual liquids for odour and density (relative to water).

(vi) **Differentiation between primary, secondary and tertiary alcohols (Lucas' test).** The test depends upon the different rates of formation of the alkyl chlorides upon treatment with a hydrochloric acid - zinc chloride reagent * (containing 1 mole of acid to 1 mole of anhydrous zinc chloride) and with hydrochloric acid. It applies only to aliphatic and *cycloaliphatic* alcohols.

To 1 ml. of the alcohol in a small test-tube, add quickly 6 ml. of Lucas' reagent at 26–27°, close the tube with a cork, shake, and allow to stand. Observe the mixture during 5 minutes. The following results may be obtained :—

* Lucas' reagent is prepared by dissolving 68 g. (0.5 mole) of anhydrous zinc chloride (fused sticks, powder, etc.) in 52.5 g. (0.5 mole) of concentrated hydrochloric acid with cooling to avoid loss of hydrogen chloride.

(a) Primary alcohols, lower than hexyl, dissolve; there may be some darkening, but the solution remains clear.

(b) Primary alcohols, hexyl and higher, do not dissolve appreciably; the aqueous phase remains clear.

(c) Secondary alcohols: the clear solution becomes cloudy owing to the separation of finely-divided drops of the chloride (see Section III,29).^{*} A distinct upper layer is visible *after one hour* except for *iso*-propyl alcohol (probably because of the volatility of the chloride).

(d) Tertiary alcohols: two phases separate *almost immediately* owing to the formation of the tertiary chloride (see Section III,33).

If a turbid solution is obtained, suggesting the presence of a secondary alcohol but not excluding a tertiary alcohol, a further test with concentrated hydrochloric acid must be made. Mix 1 ml. of the alcohol with 6 ml. of concentrated hydrochloric acid, and observe the result:—

(e) Tertiary alcohols: immediate reaction to form the insoluble chloride which rises to the surface in a few minutes.

(f) Secondary alcohols: the solution remains clear.

Carry out the Lucas test with *iso*-propyl alcohol, *n*-butyl alcohol, *sec.*-butyl alcohol, *cyclohexanol* and *tert.*-butyl alcohol. Obtain an "unknown" alcohol from the instructor for test.

CRYSTALLINE DERIVATIVES OF ALIPHATIC ALCOHOLS

1. 3 : 5-Dinitrobenzoates. 3 : 5-Dinitrobenzoyl chloride reacts with alcohols to form solid esters which possess sharp melting points and are therefore admirably suited for purposes of characterisation :

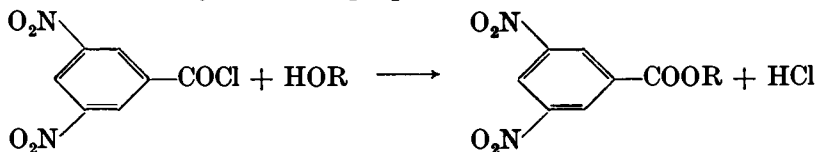

The acid chloride is available commercially, but it is more economical to prepare it from the acid as and when required. Furthermore, 3 : 5-dinitrobenzoyl chloride tends to undergo hydrolysis if kept for long periods, particularly if the stock bottle is frequently opened. The substance may, however, be stored under light petroleum.

Method 1. Mix 1.0 g. of 3 : 5-dinitrobenzoic acid (Section IV,168) with 4 ml. of thionyl chloride in a dry 50 ml. conical flask; fit a reflux condenser, carrying a plug of cotton wool at the upper end, into the flask and heat on a water bath for 15–30 minutes. Remove the condenser and heat the flask in a boiling water bath (*FUME CUPBOARD!*) until the excess of thionyl chloride has evaporated. Use the resulting 3 : 5-dinitrobenzoyl chloride (about 1.0 g.) immediately.

Add 0.5–1 ml. of the alcohol, cork the flask loosely, and heat on a water bath for 10 minutes: secondary and tertiary alcohols require longer heating (up to 30 minutes). Cool the mixture, add 10 ml. of 5 per cent. (or saturated) sodium bicarbonate solution, break up the resulting solid ester with a stirring rod (alternatively, stir until crystalline), and filter at the pump; wash with a little sodium bicarbonate solution, followed by water, and then suck as dry as possible. Dissolve the crude

^{*} Allyl alcohol behaves like a secondary alcohol and reacts within 7 minutes.

ester in the minimum volume of hot rectified (or methylated) spirit. Add hot water, drop by drop, with agitation, until the solution *just* develops a slight turbidity that does not disappear on shaking; immerse the mixture in a hot water bath during the recrystallisation. Allow to cool slowly (in order to avoid the formation of oily drops for esters of low melting point). Filter the crystals, and dry them upon a few thicknesses of filter paper or upon a piece of porous plate. Determine the melting point of the crystals when thoroughly dry. Acetone and petroleum ether may also be employed for recrystallisation.

The above procedure may also be carried out in the presence of 1 ml. of dry pyridine; with some alcohols improved yields may be obtained by this modification.

Method 2. Mix 1.0 g. of 3 : 5-dinitrobenzoic acid with 1.5 g. of phosphorus pentachloride in a small, dry test-tube. Warm the mixture gently over a small smoky flame to start the reaction; when the reaction has subsided (but not before), boil for 1-2 minutes or until the solid matter has dissolved. Pour the mixture while still liquid on a dry watch glass (*CAUTION*: the fumes are irritating to the eyes). When the product has solidified, remove the liquid by-product (phosphorus oxychloride) by transferring the pasty mixture to a pad of several thicknesses of filter paper or to a small piece of porous tile. Spread the material until the liquid has been absorbed and the residual solid is dry. Transfer the 3 : 5-dinitrobenzoyl chloride to a test-tube, add 0.5-1 ml. of the alcohol, and continue as in *Method 1*.

2. ***p*-Nitrobenzoates.** Alcohols react readily with *p*-nitrobenzoyl chloride to yield *p*-nitrobenzoates:

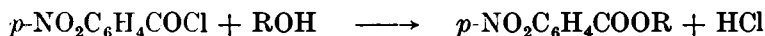

The melting points of these esters are usually much lower than those of the corresponding 3 : 5-dinitrobenzoates: their preparation, therefore, offers no advantages over the latter except for alcohols of high molecular weight and for polyhydroxy compounds. The reagent is, however, cheaper than 3 : 5-dinitrobenzoyl chloride; it hydrolyses in the air so that it should either be stored under light petroleum or be prepared from the acid, when required, by the thionyl chloride or phosphorus pentachloride method.

The experimental technique is similar to that given under *1* above.

3. **Benzoates.** Alcohols react with benzoyl chloride in the presence of pyridine or of sodium hydroxide solution to produce esters of benzoic acid:

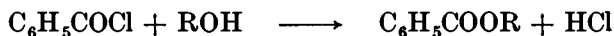

These derivatives are generally liquids and hence are of little value for characterisation; the polyhydric alcohols, on the other hand, afford solid benzoates. Thus the benzoates of ethylene glycol, trimethylene glycol and glycerol melt at 73°, 58°, and 76° respectively (see Section III, 136).

The experimental technique is similar to that given under *Aromatic Amines*, Section IV, 100, 2. The following alternative method may also be used. Mix together 0.5-0.8 ml. of the polyhydroxy compound, 5 ml. of pyridine and 2.5 ml. of redistilled benzoyl chloride in a 50 ml. flask,

and heat under reflux for 30–60 minutes. Add 25 ml. of 5 per cent. sodium bicarbonate solution to the cold reaction mixture and cool in ice until the precipitate solidifies. Filter and wash with a little water. Recrystallise from dilute alcohol as detailed under 1 above.

4. **Phenyl- and α -naphthyl-urethanes (Phenyl- and α -naphthyl-carbamates).** Both phenyl *isocyanate* and α -naphthyl *isocyanate* react with alcohols to yield phenyl-urethanes and α -naphthyl-urethanes respectively :

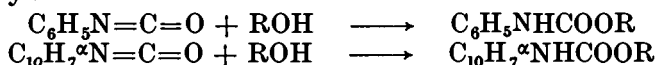

If the alcohol is not anhydrous, reaction also occurs between the water and the reagent to produce diphenylurea (m.p. 242°) and di- α -naphthyl-urea (m.p. 284°) respectively, for example :

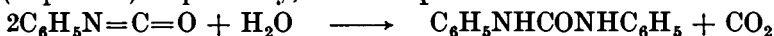

The ureas are less soluble than the corresponding urethanes, but their separation is not always easy. For this reason the urethanes are generally prepared from alcohols which are insoluble in water and can therefore be easily obtained in the anhydrous condition.

α -Naphthyl *isocyanate* is usually preferred to phenyl *isocyanate* for the following reasons :—(a) it is much less lachrymatory ; (b) it is not so readily decomposed by cold water and thus possesses better keeping qualities ; and (c) the melting points of the α -naphthyl-urethanes are generally higher than those of the corresponding phenyl-urethanes. Furthermore, with primary alcohols, which react readily in the cold, only small amounts of the urea are produced and these may be removed by taking advantage of the extreme insolubility of di- α -naphthylurea in hot ligroin.

Place 1 g. of the anhydrous alcohol in a dry test-tube and add 0.5 ml. of α -naphthyl *isocyanate* * (if the molecular weight is known, use a 10 per cent. excess of the reagent) ; insert a loose plug of cotton wool in the mouth of the tube. If no solid separates after shaking and standing for 5 minutes, warm on a water bath for 5–10 minutes, and then cool in ice. If no solid is now obtained, “scratch” the sides of the tube with a glass rod to induce crystallisation. Extract the solid with 5–10 ml. of boiling ligroin (light petroleum, b.p. 100–120°) ; this rapidly dissolves the α -naphthylurethane but not the di- α -naphthylurea. Remove the urea (if any) by filtration and allow the hot ligroin solution to cool. If the urethane does not crystallise out, evaporate the solution to half its original volume, and allow to cool. Collect the crystals on a filter, dry, and determine the melting point. If the latter is not sharp, recrystallise from light petroleum (b.p. 100–120°), alcohol, chloroform or carbon tetrachloride.

5. **Hydrogen 3-nitrophthalates.** 3-Nitrophthalic anhydride, a yellow crystalline powder of m.p. 163–164°, reacts with alcohols to yield esters of 3-nitrophthalic acid :

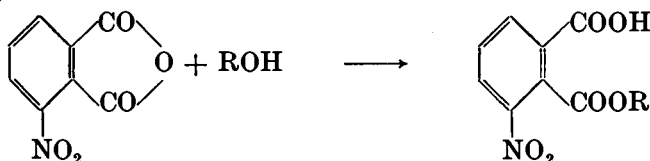

* The procedure for phenyl *isocyanate* is similar, but great care must be taken to protect both the reagent and the reaction mixture from moisture.

Although two isomeric esters are theoretically possible, the main product is the 2-ester (formulated above); traces of the isomeric 1-ester are eliminated during purification. These derivatives possess a free carboxyl group; their equivalent weights may therefore be determined by titration with standard alkali and thus serve as an additional check upon the identity of the compound.

The reagent must be carefully protected from moisture as it is comparatively easily hydrated to the acid, m.p. 216–218° (sealed capillary tube). Dilute aqueous solutions of an alcohol should be treated with solid potassium carbonate and the alcohol layer used for the test.

Phthalic anhydride reacts similarly, but the acid phthalates are somewhat more difficult to isolate and the melting points are considerably lower.

For alcohols of b.p. below 150°, mix 0.5 g. of 3-nitrophthalic anhydride (Section VII,19) and 0.5 ml. (0.4 g.) of the dry alcohol in a test-tube fitted with a short condenser, and heat under reflux for 10 minutes after the mixture liquefies. For alcohols boiling above 150°, use the same quantities of reactants, add 5 ml. of dry toluene, heat under reflux until all the anhydride has dissolved and then for 20 minutes more: remove the toluene under reduced pressure (suction with water pump). The reaction product usually solidifies upon cooling, particularly upon rubbing with a glass rod and standing. If it does not crystallise, extract it with dilute sodium bicarbonate solution, wash the extract with ether, and acidify. Recrystallise from hot water, or from 30 to 40 per cent. ethanol or from toluene. It may be noted that the m.p. of 3-nitrophthalic acid is 218°.

6. 3 : 4 : 5-Triiodobenzoates. The derivatives enumerated above are unsatisfactory for alcohol-ethers, *e.g.*, the mono-ethers of ethylene-glycol ("cellosolves") and the mono-ethers of diethyleneglycol ("carbitols") (see Table III,27). Crystalline derivatives of alcohol-ethers are readily obtained with 3 : 4 : 5-triiodobenzoyl chloride (for preparation, see Section VII,21), for example :

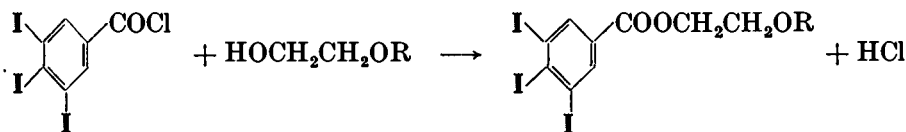

Place 0.5 g. of 3 : 4 : 5-triiodobenzoyl chloride in a small test-tube, add 0.25 ml. of the alcohol-ether and heat the mixture gently over a micro burner until the evolution of hydrogen chloride ceases (3–5 minutes). Pour the molten mass into 10 ml. of 20 per cent. alcohol to which crushed ice has been added. Some derivatives solidify instantly; those which separate as oils change to solids in a few minutes without further manipulation. Recrystallise from rectified spirit (use 50 per cent. alcohol for esters of methyl and butyl "carbitol").

The following melting points have been recorded:—methyl cellosolve, 152°; cellosolve, 128°; *iso*-propyl cellosolve, 80°; butyl cellosolve, 85°; phenyl cellosolve, 145°; benzyl cellosolve, 104°; methyl carbitol, 82°; ethyl carbitol, 76°; butyl carbitol, 54°.

7. **Pseudo-saccharin ethers.** Pseudo-saccharin chloride (Section VII,26) reacts with alcohols to give ethers (*O*-alkyl derivatives of saccharin) :

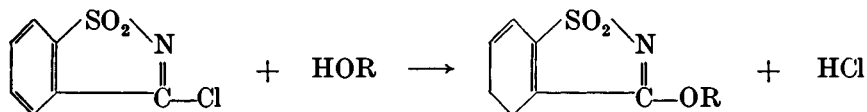

Heat a little pseudo-saccharin chloride with excess of the anhydrous alcohol in a test-tube until hydrogen chloride is no longer evolved. Recrystallise from alcohol or other organic solvent.

With the lower primary alcohols, heating at 100° for 10 minutes suffices: for higher alcohols, a temperature of 125° is preferable. Secondary alcohols require longer heating at 125°. A large excess of alcohol should be used when identifying the lower alcohols and the excess removed by evaporation; for the higher alcohols, it is better to employ an excess of pseudo-saccharin chloride and the product washed free from the reagent with dilute aqueous alkali.

The melting points of derivatives of selected alcohols are collected in Table III,27.

TABLE III,27.

ALIPHATIC ALCOHOLS

Alcohol	B.P.	M.P.	3 : 5-Dinitro- benzoate	p-Nitro- benzoate	Phenyl urethane	α -Naphthyl- urethane	Hydrogen 3-nitro- phthalate	O-Alkyl saccharin	Other Derivatives
Methyl	64.5°	—	109°	96°	47°	124°	153°	182°	—
Ethyl	78	—	94	57	52	79	157	219	—
n-Propyl	97	—	75	35	57	80	145	125	—
iso-Propyl	82	—	122	110	86	106	153	137	—
n-Butyl	118	—	64	36	61	72	147	96	—
iso-Butyl	108	—	88	68	86	104	179	100	—
sec.-Butyl	99.5	—	76	26	64	98	131	66	—
tert.-Butyl	82.5	25	142	116	136	101	—	—	—
n-Amyl	138	—	46	11	46	68	136	62	—
iso-Amyl	131.5	—	62	21	57	68	166	64	—
2-Pentanol (1)	119	—	62	17	—	76	103	—	—
3-Pentanol (2)	116	—	100	17	49	95	121	—	—
Active Amyl (3)	129	—	70	—	—	82	158	—	—
tert.-Amyl	102	—	118	85	42	72	—	—	—
n-Hexyl	156	—	61	5	42	59	124	60	—
n-Heptyl	176	—	48	10	65	62	127	55	—
n-Octyl	194	—	62	12	74	66	128	46	—
n-Nonyl	214	—	52	10	69	65	125	49	—
n-Decyl	231	6	57	30	60	71	123	48	—
n-Undecyl	243	16	55	29	62	73	123	59	—
n-Dodecyl (4)	259	24	60	45	74	80	124	54	—
n-Tetradecyl (5)	160°/10	39	67	51	74	82	123	62	—
n-Hexadecyl (6)	190°/15	50	66	52	73	82	120	70	—
n-Octadecyl (7)	—	59	66	64	80	89	119	75	—
Neo-pentyl (8)	113	52	—	—	144	100	—	—	—
2-Ethyl-n-butyl	149	—	52	—	—	—	—	—	—
2-Heptanol	159	—	49	—	—	54	—	—	—
2-Octanol	179	—	32	28	114	64	—	—	—
cycloPentanol	141	—	115	62	132	118	—	—	—
cycloHexanol	161	25	113	50	82	129	160	—	—
Furfuryl	170	—	81	76	45	129	—	—	—
Tetrahydrofurfuryl	177	—	84	47	61	90	—	—	—
Allyl	97	—	50	29	70	109	124	—	—

Diphenylcarbamate, 81

TABLE III,27.

ALIPHATIC ALCOHOLS (*continued*)

Alcohol	B.P.	M.P.	3 : 5-Dinitro- benzoate	p-Nitro- benzoate	Phenyl- urethane	α -Naphthyl- urethane	Hydrogen- 3-nitro- phthalate	Other Derivatives
Diacetone alcohol	166°	—	55°	48°	—	—	—	2 : 4-Dinitrophenylhydrazone, 203°
<i>l</i> -Menthol	216	43	153	62	112	126	—	Benzoate, 54
α -Terpineol	219	35	79	97	113	152	—	—
Geraniol	230	—	63	35	—	48	117	Diphenylcarbamate, 82
<i>d</i> -Borneol	212	205	154	153	138	127	—	—
Ethylene bromohydrin	149	—	86	—	86	—	172	$d_{4^{\circ}}^{20^{\circ}}$ 1·763, $n_D^{20^{\circ}}$ 1·492
Ethylene chlorohydrin	128·5	—	92	—	51	101	98	$d_{4^{\circ}}^{20^{\circ}}$ 1·202, $n_D^{20^{\circ}}$ 1·442
Trimethylene chlorohydrin	161	—	77	—	—	76	—	$d_{4^{\circ}}^{20^{\circ}}$ 1·131, $n_D^{20^{\circ}}$ 1·447
Glycerol α -monochlorohydrin	213	—	—	108	—	—	—	—
Glycerol $\alpha\gamma$ -dichlorohydrin	176	—	—	—	73	115	—	$d_{4^{\circ}}^{20^{\circ}}$ 1·353, $n_D^{20^{\circ}}$ 1·480
Glycerol $\beta\gamma$ -dichlorohydrin	182	—	—	38	73	—	—	—
Glycerol $\alpha\gamma$ -dibromohydrin	219 (d)	—	—	78	81	—	—	$d_{4^{\circ}}^{25^{\circ}}$ 2·120, $n_D^{25^{\circ}}$ 1·550
Ethylene glycol	197	—	169	141	157	176	—	Dibenzoate, 73
Propylene glycol	187	—	—	127	153	—	—	—
Trimethylene glycol	215	—	178	119	137	164	—	Dibenzoate, 59
Tetramethylene glycol	230	19	—	175	183	198	—	Dibenzoate, 82
Pentamethylene glycol	239	—	—	105	176	147	—	—
Hexamethylene glycol	250	42	—	—	—	—	—	—
Glycerol	290 (d)	—	—	188	180	192	—	—
Diethylene glycol (9)	244	—	149	—	—	—	—	—
Ethyleneglycol monomethyl ether (10)	124	—	—	50	—	113	129	$d_{4^{\circ}}^{20^{\circ}}$ 1·116, $n_D^{20^{\circ}}$ 1·448 $d_{4^{\circ}}^{20^{\circ}}$ 0·966, $n_D^{20^{\circ}}$ 1·402 ; 3 : 4 : 5-triiodobenzoate, 152
Ethyleneglycol monethyl ether (11)	135	—	75	—	—	67	118	$d_{4^{\circ}}^{20^{\circ}}$ 0·930, $n_D^{20^{\circ}}$ 1·408 ; 3 : 4 : 5-triiodobenzoate, 128

TABLE III,27.

ALIPHATIC ALCOHOLS (continued)

Alcohol	B.P.	M.P.	3 : 5-Dinitrobenzoate	p-Nitrobenzoate	Phenylurethane	α-Naphthylurethane	Hydrogen 3-nitrophthalate	Other Derivatives
Ethyleneglycol mono- <i>n</i> -propyl ether	151°	—	—	—	—	—	—	d_{4}^{20} 0.911, n_D^{20} 1.413
Ethyleneglycol mono- <i>iso</i> -propyl ether	142	—	—	—	—	—	—	d_{4}^{20} 0.903, n_D^{20} 1.410 ; 3 : 4 : 5-triiodobenzoate, 80
Ethyleneglycol mono- <i>n</i> -butyl ether (12)	168	—	—	120	—	—	—	d_{4}^{20} 0.902, n_D^{20} 1.420 ; 3 : 4 : 5-triiodobenzoate, 85
Ethyleneglycol monophenyl ether (13)	245	—	—	113	—	—	—	d_{4}^{20} 1.104, n_D^{20} 1.534 ; 3 : 4 : 5-triiodobenzoate, 145 ; <i>p</i> -toluenesulphonate, 80
Ethyleneglycol monobenzyl ether	265	—	—	—	—	—	—	d_{4}^{20} 1.070, n_D^{20} 1.523 ; 3 : 4 : 5-triiodobenzoate, 104
Diethyleneglycol monomethyl ether (14)	194	—	—	—	—	—	89	d_{4}^{20} 1.036, n_D^{20} 1.424 ; 3 : 4 : 5-triiodobenzoate, 82
Diethyleneglycol monoethyl ether (15)	202	—	—	—	—	—	—	d_{4}^{20} 1.024, n_D^{20} 1.430 ; 3 : 4 : 5-triiodobenzoate, 76
Diethyleneglycol mono- <i>n</i> -butyl ether (16)	232	—	—	—	—	—	—	d_{4}^{20} 0.958, n_D^{20} 1.434 ; 3 : 4 : 5-triiodobenzoate, 54
Monoethanolamine (17)	171	—	—	—	—	—	—	d_{4}^{20} 1.022, n_D^{20} 1.454 ; Picrate, 160
Diethanolamine (18)	270	28	—	—	—	—	—	d_{4}^{20} 1.097, n_D^{20} 1.478 ; Picrate, 110
Triethanolamine (19)	360	—	—	—	—	—	—	d_{4}^{20} 1.124, n_D^{20} 1.485 ; Hydrochloride, 177

- (1) Methyl *n*-propyl carbinol
 (2) Diethyl carbinol
 (3) *sec.*-Butyl carbinol
 (4) Lauryl alcohol
 (5) Myristyl alcohol

- (6) Cetyl alcohol
 (7) Stearyl alcohol
 (8) *tert.*-Butyl carbinol
 (9) 2 : 2'-Dihydroxydiethyl ether
 (10) "Methyl cellosolve"

- (11) "Ethyl cellosolve"
 (12) "Butyl cellosolve"
 (13) "Phenyl cellosolve"
 (14) "Methyl carbitol"
 (15) "Carbitol"

- (16) "Butyl carbitol"
 (17) 2-Aminoethyl alcohol
 (18) 2 : 2'-Dihydroxydiethylamine
 (19) 2 : 2' : 2'-Trihydroxy-triethylamine

ALKYL HALIDES

CHLORIDES

The chlorides of primary aliphatic alcohols are prepared :

1. By refluxing the alcohol with a mixture of concentrated hydrochloric acid and anhydrous zinc chloride, for example :

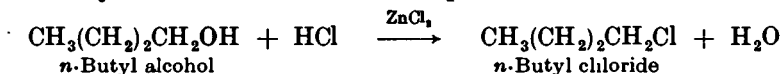

2. By the action of thionyl chloride upon the alcohol alone or mixed with pyridine (to absorb the hydrogen chloride formed in the reaction), for example :

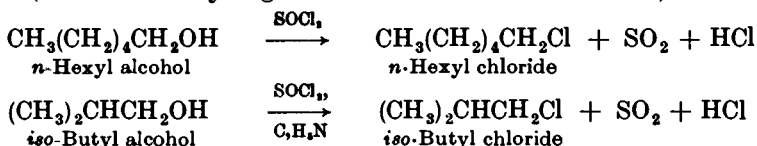

The dichlorides of aliphatic glycols are obtained by reaction with thionyl chloride in the presence of a small quantity of pyridine, for example :

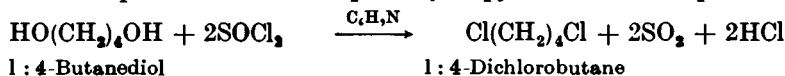

The chlorides of secondary aliphatic alcohols are prepared by method 1, for example :—

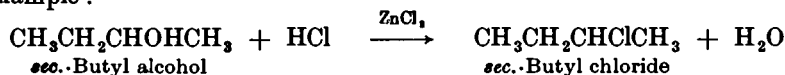

The chlorides of **cycloaliphatic** alcohols may be prepared by heating the alcohol with concentrated hydrochloric acid and anhydrous calcium chloride, for example :—

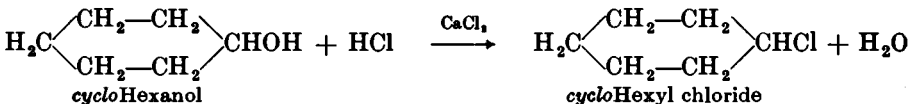

The chlorides of tertiary aliphatic alcohols are readily prepared by the action of concentrated hydrochloric acid upon the alcohol at the laboratory temperature, for example :

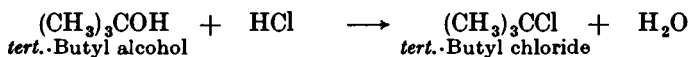

BROMIDES

Alkyl bromides may be prepared :—

1. By slow distillation of the alcohol with constant boiling point (48 per cent.) hydrobromic acid, for example :

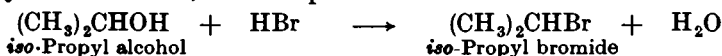

2. By treatment of the alcohol with a mixture of constant boiling point hydrobromic acid and concentrated sulphuric acid ; the presence of sulphuric acid results, as a rule, in more rapid reaction and improved yields. A typical example is :

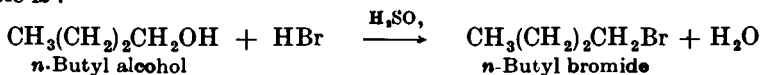

The hydrobromic acid - sulphuric acid solution may be prepared by the reduction of bromine with sulphurous acid (Section II, 49, 1); distillation of the reaction product is unnecessary :



Alternatively, the acid mixture may be obtained from the reaction between potassium bromide solution and concentrated sulphuric acid below 75°; the potassium hydrogen sulphate crystallises out and is removed by filtration :

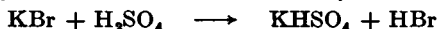

The dibromides of aliphatic glycols are best prepared by mixing the glycol with a cold hydrobromic acid - sulphuric acid mixture, allowing to stand for 24 hours, and heating on a steam bath for three hours :

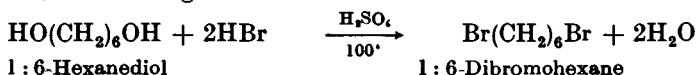

1 : 4-Dibromobutane and 1 : 5-dibromopentane are conveniently prepared from the readily available tetrahydrofuran (I) and tetrahydropyran (II) respectively :

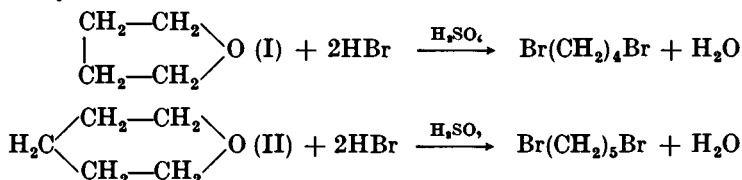

3. By the addition of liquid bromine to a warm mixture of the alcohol and purified red phosphorus :



The reaction is of general application: with primary alcohols (*n*-propyl to *n*-hexadecyl) the yields are over 90 per cent. of the theoretical, but with secondary alcohols the yields are 50-80 per cent.; in the latter case a small quantity of high boiling point by-product is also formed which can, however, be readily removed by fractional distillation. The reaction is conveniently carried out in a special all-glass apparatus.

4. By the action of phosphorus tribromide upon the alcohol :

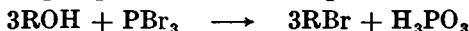

This mode of preparation must be regarded as superseded by 3, which is far more economical.

IODIDES

Three general methods are available for the preparation of iodides from alcohols :—

1. By the slow distillation of the alcohol with constant boiling point (57 per cent.) hydriodic acid, for example :

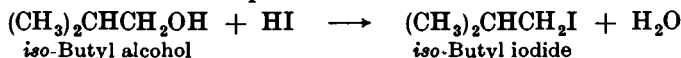

2. By the addition of a hot solution of iodine in the alcohol to a boiling (or hot) suspension of purified red phosphorus in the alcohol :



The reaction is of general application; the yields of primary alcohols approach the theoretical values, and for secondary alcohols are 85-95 per cent. The process is best carried out with the aid of a special apparatus.

3. By the interaction of alcohols or glycols with potassium iodide and 95 per cent. orthophosphoric acid (the last named is prepared from the commercial 85 per cent. acid and phosphoric oxide), for example :

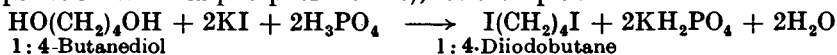

1:4-Diiodobutane and 1:5-diiodopentane are conveniently obtained from tetrahydrofuran and tetrahydropyran respectively (compare corresponding bromides above).

FLUORIDES

Alkyl fluorides may be prepared in moderate yield by interaction of an alkyl bromide with anhydrous potassium fluoride in the presence of dry ethylene glycol as a solvent for the inorganic fluoride, for example :

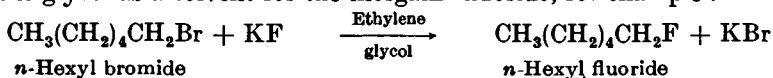

A little olefine accompanies the alkyl fluoride produced and is readily removed by treatment with $\text{KBr}-\text{Br}_2$ solution.

III,28. *n*-BUTYL CHLORIDE (*ZnCl₂-HCl* Method)

Place 40 ml. (47.5 g.) of concentrated hydrochloric acid in a 200 ml. distilling flask and add 68 g. of anhydrous zinc chloride (*e.g.*, sticks). Fit

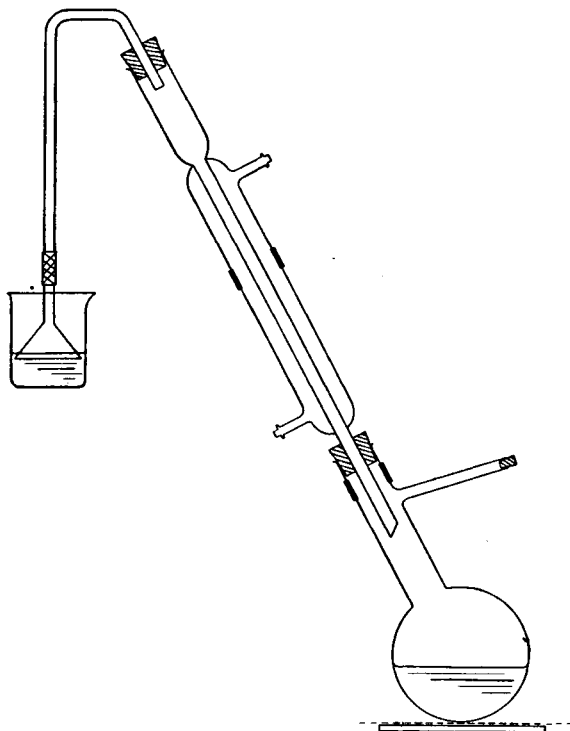

Fig. III, 28, 1.

a reflux condenser into the mouth of the distilling flask, and attach to the top of the condenser a tube connected to an inverted funnel dipping just

below the surface of about 250 ml. of water in a beaker (Fig. III, 28, 1).^{*} Close the side arm of the distilling flask with a small cork or by means of a short length of rubber tubing and glass rod plug. Introduce 18.5 g. (23 ml.) of *n*-butyl alcohol into the distilling flask and reflux the contents gently on a wire gauze or in an air bath for 2 hours; the flask must be inclined during the refluxing period as shown in the figure. After cooling, arrange the flask for distillation, and collect the liquid boiling below 115° (1). Separate the upper layer of the distillate, mix it with an equal volume of concentrated sulphuric acid (2), transfer the mixture to a 200 ml. distilling flask, close the side arm and connect the neck with a reflux condenser as before. Reflux gently for 15–30 minutes, and then distil the chloride from the acid; it will pass over at 76–79°. Wash the distillate successively with 25 ml. of water, 10 ml. of 5 per cent. sodium hydroxide solution and 25 ml. of water; dry over 1–2 g. of anhydrous calcium chloride, filter, and distil from a small distilling flask. Collect the *n*-butyl chloride at 75–78°. The yield is 15–16 g.

Notes.

(1) After the butyl chloride fraction has been collected, change the receiver and continue the distillation until the zinc chloride commences to crystallise. Allow to cool and stopper the flask. The anhydrous zinc chloride thus obtained may be used in another preparation and recovered repeatedly. This results in considerable economy when the preparation is conducted by a large number of students.

(2) The sulphuric acid treatment removes high-boiling impurities which are not easily separated by distillation.

COGNATE PREPARATION

***n*-Amyl Chloride.** Use 40 ml. of concentrated hydrochloric acid, 68 g. of anhydrous zinc chloride and 21.5 g. (26.5 ml.) of *n*-amyl alcohol. Distil until the temperature rises to 130°, etc. Collect the fraction, b.p. 104–107°. The yield is 19 g.

III, 29. **sec.-BUTYL CHLORIDE** (*ZnCl₂-HCl Method*)

Reflux a mixture of 68 g. of anhydrous zinc chloride (*e.g.*, sticks), 40 ml. (47.5 g.) of concentrated hydrochloric acid and 18.5 g. (23 ml.) of *sec.*-butyl alcohol (b.p. 99–100°) in the apparatus of Fig. III, 28, 1 for 2 hours. Distil off the crude chloride until the temperature rises to 100°. Separate the upper layer of the distillate, wash it successively with water, 5 per cent. sodium hydroxide solution and water; dry with anhydrous calcium chloride. Distil through a short column or from a Claisen flask with fractionating side arm, and collect the fraction of b.p. 67–70°; some high boiling point material remains in the flask. Redistil and collect the pure *sec.*-butyl chloride at 67–69°. The yield is 15 g.

COGNATE PREPARATIONS †

***iso*-Amyl Chloride.** Use 68 g. of anhydrous zinc chloride, 40 ml. of concentrated hydrochloric acid and 22 g. (27 ml.) of *iso*-amyl alcohol (b.p. 131°). Collect the *iso*-amyl chloride at 98–100°.

^{*} Alternatively, the tube from the top of the condenser may be supported just above the surface of water in a filter flask (as in Fig. II, 13, 8).

† The yields are about 80 per cent. of the theoretical values.

2-Chloropentane. Use the quantities given in the previous preparation, but substitute 22 g. (27 ml.) of methyl *n*-propyl carbinol (b.p. 118·5°) for *iso*-amyl alcohol. Collect the 2-chloropentane at 96–98°.

3-Chloropentane. Use the quantities as for *iso*-amyl chloride, but with 22 g. (27 ml.) of diethyl carbinol (b.p. 115·5–116°). Collect the 3-chloropentane at 95–97°.

III,30. *iso*-BUTYL CHLORIDE ($SOCl_2$ -Pyridine Method)

Fit a 500 ml. round-bottomed flask with a dropping funnel and a double surface condenser; alternatively, the flask may be provided with a two-way addition tube (Fig. II, 13, 9) and the dropping funnel and condenser inserted into the latter. Place 37 g. (46 ml.) of *iso*-butyl alcohol (b.p. 106–108°) and 40 g. (41 ml.) of pure pyridine in the flask and 119 g. (73 ml.) of redistilled thionyl chloride in the dropping funnel. Insert a cotton wool or calcium chloride guard tube into the mouth of the funnel. Introduce the thionyl chloride during 3–4 hours; a white solid separates, which partially dissolves as the reaction proceeds. Reflux for 45 minutes: the solid will dissolve completely. Allow to cool and remove the upper layer (1). Wash the latter cautiously with water, 5 per cent. sodium hydroxide solution, and twice with water; dry with anhydrous calcium chloride. Distil from a Claisen flask with a fractionating side arm. Collect the *iso*-butyl chloride at 68–69°. The yield is 26 g.

Note.

(1) The lower pyridine layer contains most of the excess of thionyl chloride; it may be recovered by distillation through an efficient fractionating column.

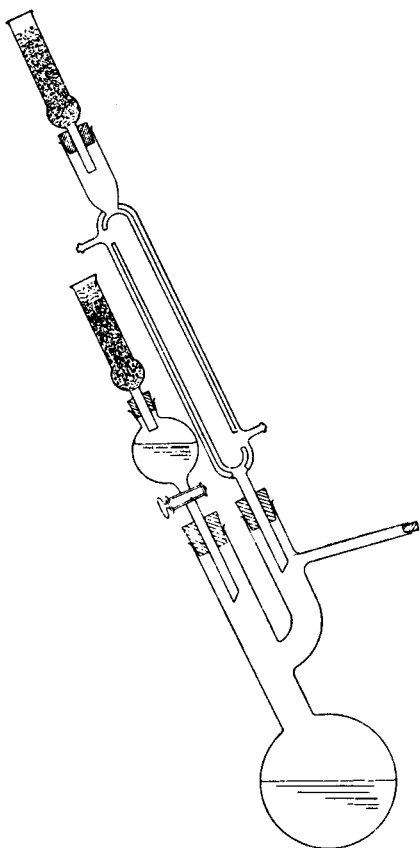

Fig. III, 31, 1.

III,31. *n*-HEXYL CHLORIDE ($SOCl_2$ Method)

Use the apparatus shown in Fig. III, 31, 1. Place 179 g. (109·5 ml.) of redistilled thionyl chloride in the 250 ml. Claisen flask and 51 g. (62·5 ml.) of *n*-hexyl alcohol, b.p. 156–158°, in the separatory funnel. Add the *n*-hexyl alcohol during 2 hours; there is a slight evolution of heat, sulphur dioxide is evolved (hence carry out the preparation in the fume cupboard), and the liquid darkens considerably. When

all the alcohol has been added, reflux the mixture for 2 hours. Rearrange the apparatus for distillation, and distil slowly; the excess of thionyl

chloride passes over below 80°, followed by a small fraction up to 120°, and finally the crude *n*-hexyl chloride at 132–134°. Wash the last-named successively with water, 10 per cent. sodium carbonate solution, and twice with water. Dry with anhydrous calcium chloride and distil from a 50 ml. Claisen flask with fractionating side arm. Pure *n*-hexyl chloride passes over at 133–134°. The yield is 36 g.

COGNATE PREPARATIONS

***n*-Heptyl Chloride.** From 58 g. (70.5 ml.) of *n*-heptyl alcohol (b.p. 175–177°) (Section III,16) and 179 g. (109.5 ml.) of redistilled thionyl chloride; refluxing period, 4 hours. The yield of *n*-heptyl chloride, b.p. 159–160°, is 52 g.

***n*-Dodecyl Chloride.** From 46.5 g. of *n*-dodecyl alcohol (lauryl alcohol), m.p. 24°, and 119 g. (73 ml.) of redistilled thionyl chloride; refluxing period, 6 hours. The crude chloride passes over at 252–257°, mainly at 255–257°. Upon purification as above, 35 g. of *n*-dodecyl chloride, b.p. 116.5°/5 mm., are obtained.

1 : 4-Dichlorobutane. Place 22.5 g. of redistilled 1 : 4-butanediol and 3 ml. of dry pyridine in a 500 ml. three-necked flask fitted with a reflux condenser, mechanical stirrer and thermometer. Immerse the flask in an ice bath. Add 116 g. (71 ml.) of redistilled thionyl chloride dropwise from a dropping funnel (inserted into the top of the condenser) to the vigorously stirred mixture at such a rate that the temperature remains at 5–10°. When the addition is complete, remove the ice bath, keep the mixture overnight, and then reflux for 3 hours. Cool, add ice water cautiously and extract with ether. Wash the ethereal extract successively with 10 per cent sodium bicarbonate solution and water, dry with anhydrous magnesium sulphate and distil. Collect the 1 : 4-dichlorobutane at 55.5–56.5°/14 mm.; the yield is 35 g. The b.p. under atmospheric pressure is 154–155°.

III,32. *cyclo*HEXYL CHLORIDE (*HCl-CaCl₂ Method*)

In a 1500 ml. round-bottomed flask, carrying a reflux condenser, place 100 g. of pure *cyclohexanol*, 250 ml. of concentrated hydrochloric acid and 80 g. of anhydrous calcium chloride: heat the mixture on a boiling water bath for 10 hours with occasional shaking (1). Some hydrogen chloride is evolved, consequently the preparation should be conducted in the fume cupboard. Separate the upper layer from the cold reaction product, wash it successively with saturated salt solution, saturated sodium bicarbonate solution, saturated salt solution, and dry the crude *cyclohexyl chloride* with excess of anhydrous calcium chloride for at least 24 hours. Distil from a 150 ml. Claisen flask with fractionating side arm, and collect the pure product at 141.5–142.5°. The yield is 90 g.

Note.

(1) The refluxing period may be reduced to 6 hours and the yield improved slightly by mechanical stirring; a three-necked flask should be used.

An alternative method of conducting the preparation consists in treating 100 g. of *cyclohexanol* with 250 ml. of concentrated hydrochloric acid, refluxing slowly whilst a stream of hydrogen chloride gas is passed into the mechanically stirred

mixture for 3 hours. (The apparatus required is similar to that described for a Clemmensen reduction in Section III, 9). The cyclohexyl chloride, b.p. 141–143°, is isolated as above; the yield is 80 g.

COGNATE PREPARATION

cyclopentyl Chloride. Use 43 g. of cyclopentanol (Section III,21), 125 ml. of concentrated hydrochloric acid and 50 g. of anhydrous calcium chloride. Thirty grams of cyclopentyl chloride, b.p. 113–115°, are obtained.

III,33. *tert.*-BUTYL CHLORIDE (*HCl* Method)

In a 250 ml. separatory funnel place 25 g. of anhydrous *tert.*-butyl alcohol (b.p. 82–83°, m.p. 25°) (1) and 85 ml. of concentrated hydrochloric acid (2) and shake the mixture from time to time during 20 minutes. After each shaking, loosen the stopper to relieve any internal pressure. Allow the mixture to stand for a few minutes until the layers have separated sharply; draw off and discard the lower acid layer. Wash the halide with 20 ml. of 5 per cent. sodium bicarbonate solution and then with 20 ml. of water. Dry the preparation with 5 g. of anhydrous calcium chloride or anhydrous calcium sulphate. Decant the dried liquid through a funnel supporting a fluted filter paper or a small plug of cotton wool into a 100 ml. distilling flask, add 2–3 chips of porous porcelain, and distil. Collect the fraction boiling at 49–51°. The yield of *tert.*-butyl chloride is 28 g.

Notes.

(1) The commercial constant boiling point alcohol, b.p. 80°/760 mm., containing 88 per cent. of *tert.*-butyl alcohol, may be used; 28.5 g. are required.

(2) The addition of 10 g. of anhydrous calcium chloride tends to concentrate the acid and assists the separation of the chloride; the yield is slightly improved.

COGNATE PREPARATIONS

***tert.*-Amyl Chloride.** Use 22 g. (27 ml.) of *tert.*-amyl alcohol (dimethyl-ethyl carbinol), b.p. 101–101.5°, and 65 ml. of concentrated hydrochloric acid. Distil the chloride twice from a Claisen flask with fractionating side arm or through a short column. Collect the *tert.*-amyl chloride at 83–85°; the yield is 18 g.

Allyl Chloride. Comparatively poor yields are obtained by the zinc chloride-hydrochloric acid method, but the following procedure, which employs cuprous chloride as a catalyst, gives a yield of over 90 per cent. Place 100 ml. of allyl alcohol (Section III,140), 150 ml. of concentrated hydrochloric acid and 2 g. of freshly prepared cuprous chloride (Section II,50,1; one tenth scale) in a 750 ml. round-bottomed flask equipped with a reflux condenser. Cool the flask in ice and add 50 ml. of concentrated sulphuric acid dropwise through the condenser with frequent shaking of the flask. A little hydrogen chloride may be evolved towards the end of the reaction. Allow the turbid liquid to stand for 30 minutes in order to complete the separation of the allyl chloride. Remove the upper layer, wash it with twice its volume of water, and dry over anhydrous calcium chloride. Distil; the allyl chloride passes over at 46–47°.

III,34. *iso*PROPYL BROMIDE (*HBr Method*)

Mix 40 g. (51 ml.) of *isopropyl* alcohol with 460 g. (310 ml.) of constant boiling point hydrobromic acid in a 500 ml. distilling flask, attach a double surface (or long Liebig) condenser and distil slowly (1–2 drops per second) until about half of the liquid has passed over. Separate the lower alkyl bromide layer (70 g.), and redistil the aqueous layer when a further 7 g. of the crude bromide will be obtained (1). Shake the crude bromide in a separatory funnel successively with an equal volume of concentrated hydrochloric acid (2), water, 5 per cent. sodium bicarbonate solution, and water, and dry with anhydrous calcium chloride. Distil from a 100 ml. flask; the *isopropyl* bromide passes over constantly at 59°. The yield is 66 g.

Notes.

(1) The residue in the flask may be mixed with the aqueous layer of the first distillate, 40 g. of *isopropyl* alcohol added, and the slow distillation repeated. The yield of crude *isopropyl* bromide in the second distillation is only slightly less than that obtained in the original preparation. Subsequently most of the residual hydrobromic acid may be recovered by distillation as the constant boiling point acid (126°).

(2) The hydrochloric acid washing removes any unclanged alcohol which may be present.

COGNATE PREPARATIONS

***n*-Propyl Bromide.** The quantities and experimental details are similar to those given above. B.p. 71°.

***cyclo*Hexyl Bromide.** Use 50 g. of *cyclohexanol* and 260 g. (176 ml.) of 48 per cent. hydrobromic acid in a 500 ml. distilling flask, and distil *all* the mixture slowly (6 hours). Add a little water to the distillate, separate the lower layer of crude bromide, and purify as for *isopropyl* bromide. Collect the *cyclohexyl* bromide at 163–165° (60 g.).

***cyclo*Pentyl Bromide.** Use 43 g. of *cyclopentanol* (Section III,21) and 260 g. (176 ml.) of 48 per cent. hydrobromic acid. Collect the *cyclopentyl* bromide at 135–137° (55 g.).

III,35. *n*-BUTYL BROMIDE (*HBr-H₂SO₄ Method*)

To 250 g. of 48 per cent. hydrobromic acid contained in a 500 ml. round-bottomed flask add 75 g. (41 ml.) of concentrated sulphuric acid in portions with shaking (1); some hydrogen bromide may be evolved. Add 88 g. (110 ml.) of *n*-butyl alcohol, followed by 60 g. (32.5 ml.) of concentrated sulphuric acid in several portions with shaking, and finally a few chips of broken glass. Attach a reflux condenser to the flask and reflux the mixture gently on a wire gauze for 2–3 hours; during this period the formation of *n*-butyl bromide is almost complete and a layer separates above the acid. If the preparation is carried out in the open laboratory, fit an absorption device (compare Fig. II, 13, 8 and Fig. III, 28, 1) to the top of the condenser in order to absorb any hydrogen bromide and sulphur dioxide which may be evolved. Allow the contents of the flask to cool, remove the condenser and set it for downward distillation; connect the condenser to the flask by means of a wide (7–8 mm. diameter bent glass tube. Distil the mixture until no more oily drops of *n*-butyl

bromide pass over (30–40 minutes). Transfer the distillate to a separatory funnel and remove the halide which forms the lower layer. Wash it successively with water, an equal volume of concentrated hydrochloric acid (2), water, 5 per cent. sodium bicarbonate or sodium carbonate solution, and water. Separate the water as completely as possible and dry with 2–3 g. of anhydrous calcium chloride or anhydrous magnesium sulphate; the desiccant should be left in contact with the bromide for at least 30 minutes and shaken occasionally. Filter the dried product through a small funnel supporting a fluted filter paper or small cotton wool plug into a 200 ml. distilling flask, add a few chips of porous porcelain and distil either from an air bath (Fig. II, 5, 3) or on an asbestos-centred wire gauze. Collect the portion boiling at 100–103°. The yield is 155 g.

Notes.

(1) This acid mixture may be prepared (compare Section II, 49, 1) by placing 120 g. (37.5 ml.) of bromine and 130 g. of crushed ice in a 500 ml. flask, cooling the latter in ice, and passing sulphur dioxide (from a siphon of the liquefied gas) into the bromine layer at such a rate that the gas is completely absorbed. The flask is shaken occasionally, and the flow of gas is stopped immediately the red colour due to free bromine has disappeared; the mixture will then have a yellow colour. The resulting acid mixture is equivalent to 250 g. of 48 per cent. hydrobromic acid to which 75 g. of concentrated sulphuric acid have been added; it need not be distilled for the preparation of *n*-butyl bromide.

Owing to the comparatively negligible difference in the cost of bromine and the equivalent quantity of constant boiling point hydrobromic acid, there is little to be gained—apart from the instructional value—in preparing the hydrobromic acid from bromine in the preparation of alkyl bromides.

CAUTION. Bromine must be handled with great care and in the fume cupboard. The liquid produces painful burns and the vapour is unpleasant. Bromine burns should be treated immediately with a liberal quantity of glycerine. If the vapour is inhaled, relief may be obtained by soaking a handkerchief in alcohol and holding it near the nose.

(2) The crude bromide contains a little unchanged alcohol and is said to contain some *n*-butyl ether (b.p. 141°). The former is removed by washing with concentrated hydrochloric acid and this purification process is satisfactory for most purposes. Both the alcohol and the ether are removed by washing with 11–12 ml. of concentrated sulphuric acid; the butyl bromide is not affected by this reagent.

COGNATE PREPARATIONS

sec.-Butyl Bromide. The quantities required are as for *n*-butyl bromide but with *sec.*-butyl alcohol (b.p. 99–100°) replacing the *n*-butyl alcohol. Two to three washings with concentrated hydrochloric acid are necessary, *i.e.*, until the volume of the acid layer remains unchanged on shaking with the halide. The yield of *sec.*-butyl bromide, b.p. 90.5–92.5°, is 150 g.

Ethyl Bromide. Fit a 1-litre round-bottomed flask with a two-holed cork carrying a separatory funnel and a wide (6–8 mm.) bent tube connected to a long efficient condenser set for downward distillation (Fig. III, 35, 1); alternatively, a two-way addition tube (Fig. II, 1, 8)

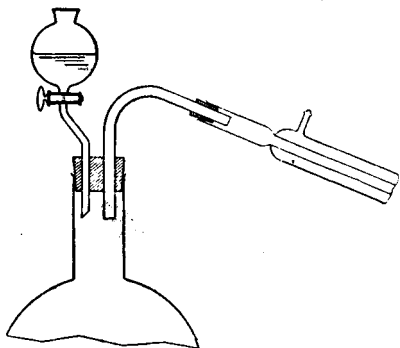

Fig. III, 35, 1.

may be used and the necessary modifications made. Place 415 g. (281 ml.) of 48 per cent. hydrobromic acid in the flask and add 120 g. (65 ml.) of concentrated sulphuric acid in portions, with shaking. When cold, add 100 g. (145 ml.) of rectified spirit (95 per cent. ethyl alcohol) and assemble the apparatus completely. Connect the end of the condenser to an adapter dipping into water contained in a 500 ml. flask; the latter is surrounded by ice. Introduce 200 g. (109 ml.) of concentrated sulphuric acid slowly from the tap funnel and distil the mixture slowly. Wash the crude ethyl bromide with an equal volume of concentrated hydrochloric acid, then with water, a little 5 per cent. sodium bicarbonate solution, and finally with water. Dry with anhydrous calcium chloride. Distil the dry bromide, to which a few chips of porous porcelain have been added, from a water bath and collect the ethyl bromide, b.p. 38–39°, in a receiver cooled in ice. The yield is 205 g.

***n*-Propyl Bromide.** Use the procedure described for *Ethyl Bromide* substituting the following quantities of reagents: 500 g. (338 ml.) of 48 per cent. hydrobromic acid and 150 g. (82 ml.) of concentrated sulphuric acid; 144 g. (179 ml.) of *n*-propyl alcohol (b.p. 96.5–97.5°). Introduce 120 g. (65 ml.) of concentrated sulphuric acid gradually through the separatory funnel and distil slowly over a wire gauze until no more oily drops pass over. The yield of *n*-propyl bromide, b.p. 70–72°, is 255 g.

***n*-Amyl Bromide.** Use 210 g. (142 ml.) of 48 per cent. hydrobromic acid, 60 g. (33 ml.) of concentrated sulphuric acid, followed by 88 g. (108 ml.) of *n*-amyl alcohol (b.p. 135–136°) and 10 g. (5.5 ml.) of concentrated sulphuric acid. Distil the product through a short fractionating column, and collect the *n*-amyl bromide at 127–130° (135 g.).

***iso*-Amyl Bromide.** Proceed as for *n*-Amyl Bromide, but use 88 g. (109 ml.) of synthetic (Sharples) *iso*amyl alcohol, b.p. 129.5–131°. Distil the purified product through a fractionating column and collect the *iso*amyl bromide at 117–120° (125 g.).

2-Bromopentane. Proceed as for *n*-Amyl Bromide, but use 88 g. (108 ml.) of methyl *n*-propyl carbinol (2-pentanol), b.p. 118.5°. During the washing with concentrated hydrochloric acid, difficulty may be experienced in separating the acid layer; this is overcome by adding a little water to decrease the density of the acid. Distil the purified product through a fractionating column; some amylene passes over first, followed by the 2-bromopentane at 115–118° (120 g.).

3-Bromopentane. Proceed as for *n*-Amyl Bromide, but use 88 g. (108 ml.) of diethyl carbinol (3-pentanol), b.p. 115.5–116°. The experimental observations are similar to those given for 2-Bromopentane. Collect the 3-bromopentane at 116–119° (120 g.).

Trimethylene Dibromide. In a 1-litre round-bottomed flask place 500 g. (338 ml.) of 48 per cent. hydrobromic acid and add 150 g. (82 ml.) of concentrated sulphuric acid in portions, with shaking. Then add 91 g. of trimethylene glycol (b.p. 210–215°), followed by 240 g. (130.5 ml.) of concentrated sulphuric acid slowly and with shaking. Attach a reflux condenser to the flask and reflux the mixture for 3–4 hours. Arrange for downward distillation and distil, using a wire gauze, until no more oily drops pass over (30–40 minutes). Purify the trimethylene dibromide

as detailed for *n-Butyl Bromide* above. About 220 g. of the pure dibromide b.p. 162–165°, are obtained.

Allyl Bromide. Introduce into a 1-litre three-necked flask 250 g. (169 ml.) of 48 per cent. hydrobromic acid and then 75 g. (40.5 ml.) of concentrated sulphuric acid in portions, with shaking; finally add 58 g. (68 ml.) of pure allyl alcohol (Section III,140). Fit the flask with a separatory funnel, a mechanical stirrer and an efficient condenser (preferably of the double surface type) set for downward distillation; connect the flask to the condenser by a wide (6–8 mm.) bent tube. Place 75 g. (40.5 ml.) of concentrated sulphuric acid in the separatory funnel, set the stirrer in motion, and allow the acid to flow slowly into the warm solution. The allyl bromide will distil over (< 30 minutes). Wash the distillate with 5 per cent. sodium carbonate solution, followed by water, dry over anhydrous calcium chloride, and distil from a Claisen flask with a fractionating side arm or through a short column. The yield of allyl bromide, b.p. 69–72°, is 112 g. There is a small high-boiling fraction containing propylene dibromide.

1 : 4-Dibromobutane (from 1 : 4-butanediol). In a 500 ml. three-necked flask fitted with a stirrer, reflux condenser and dropping funnel, place 154 g. (105 ml.) of 48 per cent. hydrobromic acid. Cool the flask in an ice bath. Add slowly, with stirring, 130 g. (71 ml.) of concentrated sulphuric acid. To the resulting ice-cold solution add 30 g. of redistilled 1 : 4-butanediol dropwise. Leave the reaction mixture to stand for 24 hours; heat for 3 hours on a steam bath. The reaction mixture separates into two layers. Separate the lower layer, wash it successively with water, 10 per cent. sodium carbonate solution and water, and then dry with anhydrous magnesium sulphate. Distil and collect the 1 : 4-dibromobutane at 83–84°/12 mm. The yield is 55 g.

1 : 4-Dibromobutane (from tetrahydrofuran). Place a mixture of 250 g. (170 ml.) of 48 per cent. hydrobromic acid and 75 g. (41 ml.) of concentrated sulphuric acid, prepared as in *Note 1*, in a 500 ml. round-bottomed flask, add 18.1 g. (20.5 ml.) of redistilled tetrahydrofuran (b.p. 65–66°), attach a reflux condenser and reflux gently for 3 hours. Separate the lower layer of dibromide and purify as in the previous preparation. The yield of 1 : 4-dibromobutane, b.p. 83–84°/12 mm., is 40 g.

1 : 5-Dibromopentane (from 1 : 5-pentanediol). Proceed as for 1 : 4-dibromobutane but use 35 g. of redistilled commercial 1 : 5-pentanediol. The yield of 1 : 5-dibromopentane, b.p. 99°/13 mm., is 39 g.

1 : 5-Dibromopentane (from tetrahydropyran). Proceed as for 1 : 4-dibromobutane (from tetrahydrofuran) but use 21.5 g. (24.4 ml.) of redistilled tetrahydropyran (b.p. 86.5–87.5°). The yield of 1 : 5-dibromopentane, b.p. 99°/13 mm. is 46 g.

III,36. *n*-BUTYL BROMIDE (*KBr-H₂SO₄ Method*)

Dissolve 30 g. of potassium bromide in 50 ml. of water in a 350 ml. conical flask; *gentle* warming may be necessary. Cool the flask with running water from the tap so that the contents attain room temperature. Add 25 ml. of concentrated sulphuric acid slowly and with constant rotation of the flask to ensure thorough mixing; cool under the tap from

time to time and do not allow the temperature to rise above 40 during the addition of the acid. Cool to about 15° (under a running water tap), and filter off the precipitated potassium bisulphate using a Buchner funnel and a dry filter flask. Press the precipitate on the filter firmly with the aid of the wide end of a large glass stopper; it is unnecessary to wash the solid with water. Transfer the filtrate to a 250 ml. round-bottomed flask and add 11 g. (14 ml.) of *n*-butyl alcohol. Introduce 28 g. (15 ml.) of concentrated sulphuric acid slowly and with constant rotation of the contents of the flask; if this operation is carried out carefully, very little hydrogen bromide will be evolved. Add a few small chips of porous porcelain, attach a reflux condenser to the flask, and reflux for 3–4 hours. Remove the reflux condenser, attach a bent tube to the mouth of the flask and set the condenser for downward distillation (Fig. II, 13, 3, but without the thermometer). Distil slowly on a wire gauze until no more oily drops are visible in the condenser. Transfer the distillate to a separatory funnel, remove the lower layer of crude butyl bromide, and discard the upper aqueous layer. Wash the crude halide in the separatory funnel successively with 10–15 ml. of concentrated hydrochloric acid (this will remove any unchanged *n*-butyl alcohol), 25 ml. of water, 20 ml. of *ca.* 10 per cent. sodium carbonate solution and finally with 25 ml. of water: the bromide layer is the lower layer in all cases. Dry the product with 2–3 g. of anhydrous calcium chloride; it is best to leave the halide in contact with the desiccant for about 30 minutes and shake occasionally after an initial shaking of 2–3 minutes. Filter the dried product through a fluted filter paper or a small cotton wool plug supported in a funnel into a dry 50 ml. distilling flask, and distil on a wire gauze or from an air bath (Fig. II, 5, 3). Collect the fraction, b.p. 100–103°. The yield of *n*-butyl bromide is 18–19 g.

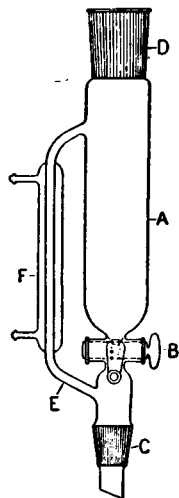

Fig. III, 37, 1.

III,37. *n*-BUTYL BROMIDE (*Red P - Br₂ Method*)

Owing to the corrosive action of bromine upon corks and rubber stoppers, ground glass joints are recommended in this preparation. The apparatus, depicted in Fig. III, 37, 1,* is particularly convenient for the preparation of bromides from alcohols. A double surface condenser is fitted into *D* and a round-bottomed flask is fitted on to the ground glass joint at *C*; *B* is a "three-way" stopcock † which permits the removal of the contents of *A* without disconnecting the apparatus. For preparations of moderate size, *A* has a capacity of 60 or 100 ml. and a 250 or 500 ml. flask is attached at *C*.

Place 92.5 g. (114.5 ml.) of *n*-butyl alcohol and 8.55 g. of purified red phosphorus (Section II,50,5) in a 500 ml. round-bottomed flask (attached at *C*) and 100 g. (32 ml.) of bromine in *A*. Pass a stream of cold water through the condenser *F* and through the double surface condenser fitted at *D*; the condenser *F* prevents the volatilisation of the alcohol from the

* Obtainable from A. Gallenkamp and Co. Ltd.

† For a side view of the "three-way" stopcock *B*, see Fig. III, 40, 2, *b*.

flask into the bromine in *A* (for precautions in the use of bromine, see Section III,35, *Note 1*), and also serves to condense unreacted bromine from the flask. Heat the flask gently and introduce the liquid bromine, by suitably turning the stopcock *B*, into the phosphorus - alcohol mixture at such a rate that it appears to react almost completely so that there is little bromine vapour above the surface of the reaction mixture and the reaction is under control. When all the bromine has been added, reflux the mixture gently for 15-30 minutes; during this process the water should be emptied from *F* and tap *B* turned so that it connects the flask and the reservoir *A*. Close the tap *B* and collect most (about 90 per cent. of the butyl bromide in *A* (1); remove the crude bromide into a 350 ml. flask by suitably rotating the stopcock *B*. Now add 50 ml. of water through the condenser and reservoir *A* into the flask and continue the distillation; the residual bromide in the flask, together with water, will collect in *A* and is transferred, as before, to the flask containing the main yield of halide. When the apparatus is cold, separate the flask and the condenser at the ground joints; "sticking" is thus avoided. Pour the crude bromide into a separatory funnel, discard the upper aqueous layer, and wash successively with water, an approximately equal volume of concentrated hydrochloric acid, water, 10 per cent. sodium carbonate solution, water, and then dry it with anhydrous calcium chloride. Distil from a flask of appropriate size. The *n*-butyl bromide (154 g.) passes over at 100-103°.

Note.

(1) It is not advisable to distil the mixture almost to dryness, since, towards the end of the distillation, the inflammable butylene is formed. Butylene formation is avoided by conducting the distillation in two stages as described.

COGNATE PREPARATIONS *

***n*-Propyl Bromide.** Use 90 g. (112 ml.) of *n*-propyl alcohol, 12.40 g. of purified red phosphorus and 121 g. (39 ml.) of bromine. B.p. 71-72.5°.

***iso*-Butyl Bromide.** Use 92.5 g. (115.5 ml.) of *iso*-butyl alcohol, 8.55 g. of purified red phosphorus and 105 g. (34 ml.) of bromine. B.p. 91-94°.

***n*-Hexyl Bromide.** Use 152.5 g. (186.5 ml.) of *n*-hexyl alcohol, 8.55 g. of purified red phosphorus and 110 g. (35.5 ml.) of bromine.† B.p. 154-156°.

***n*-Octyl Bromide.** Use 81 g. (98.5 ml.) of *n*-octyl alcohol (b.p. 193-194°), 5.18 g. of purified red phosphorus and 55 g. (18 ml.) of bromine. B.p. 198-201°.

***n*-Dodecyl Bromide.** Use 116 g. of *n*-dodecyl alcohol (lauryl alcohol), m.p. 24°, 5.18 g. of purified red phosphorus and 55 g. (18 ml.) of bromine. Allow the mixture to cool after all the bromine has been introduced. Dilute with water, add ether, filter off the excess of phosphorus, separate the ethereal solution of the bromide, wash it with water and dry over anhydrous potassium carbonate. Remove the ether on a water bath, and distil the residue under reduced pressure. B.p. 149-151°/18 mm.

* Unless otherwise stated, the yields exceed 90 per cent. of the theoretical.

† The slight excess of bromine over that theoretically equivalent to the alcohol in the preparation of high boiling point bromides ensures the absence of unchanged alcohol in the product; any excess of bromine may be removed by the addition of a little sodium bisulphite.

***n*-Tetradecyl Bromide.** Use 107 g. of *n*-tetradecyl alcohol (m.p. 38°), 3.41 g. of purified red phosphorus and 44 g. (14.5 ml.) of bromine. Heat the alcohol-phosphorus mixture to about 250° and add the bromine slowly. Treat the cold reaction mixture with ether, filter off the excess of red phosphorus, and proceed as under *n*-Dodecyl Bromide. B.p. 178.5–179.5°/20 mm., m.p. 5°.

Alternatively, place the mixture of alcohol and red phosphorus in a 500 ml. three-necked flask fitted with a mechanical stirrer, dropping funnel and double surface condenser. Heat the phosphorus-alcohol mixture to about 250°, and add the bromine whilst stirring vigorously. Work up the reaction product as above.

***n*-Hexadecyl Bromide.** Use 121 g. of *n*-hexadecyl alcohol (cetyl alcohol), m.p. 48°, 3.41 g. of purified red phosphorus and 44 g. (14.5 ml.) of bromine. Heat the alcohol-phosphorus mixture to about 250° and add the bromine slowly. Either the apparatus of Fig. III, 37, 1 or a 500 ml. three-necked flask may be used. Isolate the cetyl bromide as described for *n*-Tetradecyl Bromide; filter off the excess of phosphorus at 16–20°. B.p. 202–203°/21 mm.; m.p. 14°.

β -Phenylethyl Bromide. Use 152.5 g. (148 ml.) of β -phenylethyl alcohol (Section IV, 204), b.p. 216.5–217°, 10.35 g. of purified red phosphorus and 110 g. (35.5 ml.) of bromine. Isolate the β -phenylethyl bromide as detailed for *n*-Dodecyl Bromide. B.p. 98°/12 mm.

1 : 4-Dibromobutane (from 1 : 4-butanediol). Use 45 g. of redistilled 1 : 4-butanediol, 6.84 g. of purified red phosphorus and 80 g. (26 ml.) of bromine. Heat the glycol-phosphorus mixture to 100–150° and add the bromine slowly: use the apparatus of Fig. III, 37, 1. Continue heating at 100–150° for 1 hour after all the bromine has been introduced. Allow to cool, dilute with water, add 100 ml. of ether, and remove the excess of red phosphorus by filtration. Separate the ethereal solution of the dibromide, wash it successively with 10 per cent. sodium thio-sulphate solution and water, then dry over anhydrous potassium carbonate. Remove the ether on a water bath and distil the residue under diminished pressure. Collect the 1 : 4-dibromobutane at 83–84°/12 mm.; the yield is 73 g.

1 : 6-Dibromohexane. Proceed as for 1 : 4-dibromobutane but use 58 g. of 1 : 6-hexanediol. The yield of 1 : 6-dibromohexane, b.p. 114–115°/12 mm. is 85 g.

1 : 4-Dibromobutane (from tetrahydrofuran). Place 18.1 g. (20.5 ml.) of redistilled tetrahydrofuran (b.p. 65–66°), 3.42 g. of purified red phosphorus and 4.5 g. of water in the flask attached to the apparatus of Fig. III, 37, 1. Heat the mixture gently and add 40 g. (13 ml.) of bromine at such a rate that there is little bromine vapour above the surface of the reaction mixture. Heat at 100–150° for 45–60 minutes after all the bromine has been introduced. Work up as for the 1 : 4-butanediol preparation. The yield of 1 : 4-dibromobutane, b.p. 83–84°/12 mm. is 42 g.

1 : 5-Dibromopentane (from tetrahydropyran). Proceed as in the previous preparation but replace the tetrahydrofuran by 21.5 g. (24.4 ml.) of redistilled tetrahydropyran (b.p. 86.5–87.5°). The yield of 1 : 5-dibromopentane, b.p. 99°/13 mm., is 43 g.

III,38. 1 : 4-DIIODOBUTANE (*KI* - H_3PO_4 Method)

In a 500 ml. three-necked flask, equipped with a thermometer, a sealed Hershberg stirrer and a reflux condenser, place 32.5 g. of phosphoric oxide and add 115.5 g. (67.5 ml.) of 85 per cent. orthophosphoric acid (1). When the stirred mixture has cooled to room temperature, introduce 166 g. of potassium iodide and 22.5 g. of redistilled 1 : 4-butanediol (b.p. 228–230° or 133–135°/18 mm.). Heat the mixture with stirring at 100–120° for 4 hours. Cool the stirred mixture to room temperature and add 75 ml. of water and 125 ml. of ether. Separate the ethereal layer, decolourise it by shaking with 25 ml. of 10 per cent. sodium thiosulphate solution, wash with 100 ml. of cold, saturated sodium chloride solution, and dry with anhydrous magnesium sulphate. Remove the ether by “flash distillation” (Section II,13; compare Fig. II, 13, 4) on a steam bath and distil the residue from a Claisen flask with fractionating side arm under diminished pressure. Collect the 1 : 4-diiodobutane at 110°/6 mm.; the yield is 65 g.

Alternatively, add 18.2 g. (20.5 ml.) of redistilled tetrahydrofuran (b.p. 65–66°) to a mixture of 32.5 g. of phosphoric oxide, 115.5 g. (67.5 ml.) of 85 per cent. orthophosphoric acid and 166 g. of potassium iodide, reflux for 3–4 hours, cool and isolate the 1 : 4-diiodobutane as above. The yield of product, b.p. 110°/6 mm., is 70 g.

Note.

(1) The orthophosphoric acid must be adjusted to a concentration of 95 per cent. H_3PO_4 . Alternatively, the commercial 100 per cent. orthophosphoric acid may be diluted with water to this concentration. The 95 per cent. acid is claimed to be the most efficient for the preparation of iodides from alcohols and glycols, and for effecting cleavage of tetrahydrofuran and tetrahydropyran. Anhydrous orthophosphoric acid does not give such good results because of the limited solubility of hydrogen iodide in the reagent.

COGNATE PREPARATIONS

1 : 5-Diiodopentane (from 1 : 5-pentanediol). Proceed as for 1 : 4-diiodobutane but use 26 g. (26.5 ml.) of redistilled 1 : 5-pentanediol (b.p. 238–239°) in place of the 1 : 4-butanediol. The yield of 1 : 5-diiodopentane, b.p. 142–143°/16 mm., is 65 g.

1 : 5-Diiodopentane (from tetrahydropyran). Use 21.5 g. (24.4 ml.) of redistilled tetrahydropyran (b.p. 86.5–87.5°) in place of the tetrahydrofuran, otherwise proceed as for 1 : 4-diiodobutane. The yield of 1 : 6-diiodopentane, b.p. 142–143°/16 mm., is 71 g.

1 : 6-Diiodohexane. Proceed exactly as detailed for 1 : 4-diiodobutane but replace the 1 : 4-butanediol by 29.5 g. of 1 : 6-hexanediol, m.p. 41–42°. The yield of 1 : 6-diiodohexane, b.p. 150°/10 mm., m.p. 10°, is 70 g.

***n*-Butyl Iodide.** Use 16.3 g. of phosphoric oxide, 58 g. (34 ml.) of 85 per cent. orthophosphoric acid, 83 g. of potassium iodide and 18.5 g. (23 ml.) of redistilled *n*-butyl alcohol in a 250 ml. three-necked flask. Follow the experimental details given for 1 : 4-diiodobutane but stir for 2–3 hours. The yield of *n*-butyl iodide, b.p. 129–131° (largely 130°), is 32 g.

cycloHexyl Iodide. Proceed exactly as described for *n*-butyl iodide, but replace the *n*-butyl alcohol by 25 g. of redistilled cyclohexanol (b.p. 160–161°). The yield of cyclohexyl iodide, b.p. 67–69°/9 mm., is 45 g.

III,39. *iso*PROPYL IODIDE (*HI Method*)

Mix 30 g. (38 ml.) of *iso*propyl alcohol with 450 g. (265 ml.) of constant boiling point hydriodic acid (57 per cent.) (Section II,49,2) in a 500 ml. distilling flask, attach a condenser for downward distillation, and distil slowly (1-2 drops per second) from an air bath (compare Fig. II, 5, 3). When about half the liquid has passed over, stop the distillation. Separate the lower layer of crude iodide (80 g.). Redistil the aqueous layer and thus recover a further 5 g. of iodide from the first quarter of the distillate (1). Wash the combined iodides with an equal volume of concentrated hydrochloric acid, then, successively, with water, 5 per cent. sodium carbonate solution, and water. Dry with anhydrous calcium chloride and distil. The *iso*propyl iodide distils constantly at 89°.

Note.

(1) A further quantity of *iso*propyl iodide, only slightly less than that obtained in the first distillation, may be prepared by combining the residues in the distilling flask, adding 30 g. (38 ml.) of *iso*propyl alcohol, and repeating the distillation. Finally, the residues should be distilled and the 57 per cent. constant boiling point acid recovered.

COGNATE PREPARATIONS

***iso*-Butyl Iodide.** Use 30 g. (37.5 ml.) of *iso*-butyl alcohol and 273 g. (161 ml.) of 57 per cent. hydriodic acid; 65 g. of the crude iodide are obtained. If the crude iodide is dark in colour, add a little sodium bisulphite. B.p. 119-120°.

***sec*-Butyl Iodide.** Use 30 g. (37.5 ml.) of *sec*-butyl alcohol and 273 g. (161 ml.) of 57 per cent. hydriodic acid; 73 g. of crude iodide are obtained. B.p. 117.5-119°.

***cyclo*Pentyl Iodide.** Use 43 g. (45.5 ml.) of *cyclopentanol* and 340 g. (200 ml.) of 57 per cent. hydriodic acid; 89 g. of crude iodide are obtained. B.p. 58°/22 mm.

Allyl Iodide. Use 29 g. (34 ml.) of allyl alcohol and 340 g. (200 ml.) of 57 per cent. hydriodic acid; 84 g. of crude iodide are obtained. Upon adding 29 g. (34 ml.) of allyl alcohol to the combined residue in the flask and the aqueous layer and distilling as before, a further 72 g. of crude allyl iodide may be isolated. B.p. 99-101° (mainly 100°). The compound is very sensitive to light; the distillation should therefore be conducted in a darkened room and preferably in the presence of a little silver powder.

III,40. *n*-BUTYL IODIDE (*Red P and I₂ Method*)

A special apparatus * (Fig. III, 40, 1) renders the preparation of iodides from alcohols a very simple operation. The special features of the apparatus are:—(i) a wide bored (3-4 mm.) stopcock *A* which considerably reduces the danger of crystallisation in the bore of the tap of the iodine from the hot alcoholic solution; (ii) a reservoir *B* for the solid iodine and possessing a capacity sufficiently large to hold all the alkyl iodide produced; (iii) a wide tube *C* which permits the alcohol vapour from the flask *D* to pass rapidly into the reservoir *B*, thus ensuring that the iodine is dissolved by alcohol which is almost at the boiling point. An improved apparatus is shown in Fig. III, 40, 2, *a* and *b*; here a

* Supplied by A. Gallenkamp and Co. Ltd. in various capacities.

“three-way” stopcock is provided in order to remove the liquid contents of the reservoir without disconnecting the special apparatus from the flask.

Fit up the assembly depicted in Fig. III, 40, 1; insert a plug of glass wool at the bottom of *B* (just above the wide bore tap *A*). *D* is a 100 ml. bolt-head flask, *B* has a capacity of about 30 ml. (1) and *E* is a Liebig (but may be a double surface) condenser. Place 15 g. (19 ml.) of *n*-butyl alcohol and 2.75 g. of purified red phosphorus (Section II,50,5) in the flask and 25 g. of iodine in the special apparatus. Make sure that all the corks fit tightly and do not leak. Heat the flask gently on a wire

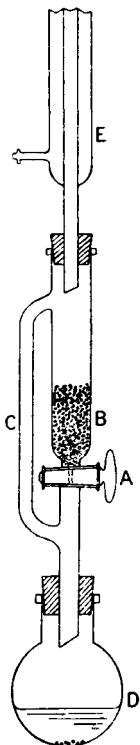

Fig. III, 40, 1.

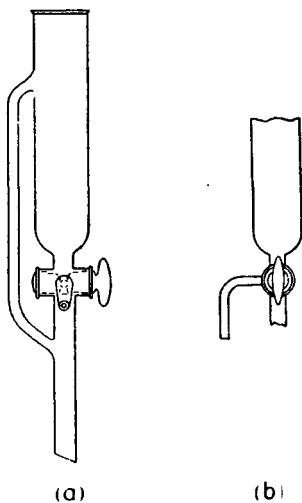

Fig. III, 40, 2.

gauze. The *n*-butyl alcohol vapour will gradually pass into *B* through the wide-bore side tube *C* and eventually the hot alcohol will dissolve a considerable quantity of the iodine. As soon as the liquid (a solution of iodine in *n*-butyl alcohol) has reached the tap, open the latter slightly and allow the solution to flow slowly into the flask. There is usually a fairly vigorous reaction, and it may be necessary to remove the flame from beneath the flask. Arrange the rate of addition so that the mixture in the flask boils gently and the reaction is under control. When all the iodine has been transferred to the flask in this manner, the formation of *n*-butyl iodide is practically complete and little iodine vapour is visible. To ensure absolute completeness of the reaction, distil most (80–90 per cent.) of the iodide into *B* by gently heating the flask. *Stop the heating*

when about 5 ml. of liquid remains in the flask ; if the heating is continued beyond this point, butylene may be formed and a fire may result. Disconnect the special apparatus (2) from the bolt-head flask and run off the crude iodide into a flask. Add 25 ml. of water to the residue in the bolt-head flask *D*, assemble the complete apparatus again, and heat *D* gently. The remaining *n*-butyl iodide (and some water) will collect in *B*. Stop the "steam distillation" when no more oily drops pass into *B*. Run the contents of *B* into the flask containing the main bulk of the crude iodide, transfer the mixture to a 50 ml. or 100 ml. separatory funnel, and run off the lower layer of iodide : discard the aqueous layer. Wash the *n*-butyl iodide successively with approximately equal volumes of water, concentrated hydrochloric acid (3), water, 10 per cent. sodium carbonate solution and water. Dry the iodide with about 2·5 g. of anhydrous calcium chloride ; it is best to leave the liquid in contact with the desiccant for 15–30 minutes and to shake occasionally. Filter the dried product through a fluted filter paper or a small plug of cotton wool supported in a small funnel into a dry 50 ml. distilling flask, add 2–3 fragments of porous porcelain, and distil on a wire gauze or from an air bath (Fig. *II*, 5, 3). Collect the fraction boiling at 129–131°. The yield of *n*-butyl iodide is 32–34 g.

Notes.

(1) The small capacity apparatus is especially recommended for the use of students ; the consumption of iodine by a large class of students is not unreasonably high. Larger apparatus, *e.g.*, 60 ml. and 100 ml. capacity holding 100 g. and 200 g. respectively of iodine, are generally preferred for routine preparations of alkyl iodides ; the bolt-head flask should then be of 250 or 500 ml. capacity. Thus for *n*-butyl iodide a typical preparation would employ 120 g. (148·5 ml.) of *n*-butyl alcohol, 21·75 g. of red phosphorus, and 200 g. of iodine.

(2) If the apparatus of Fig. *III*, 40, 2 is employed, the iodide is removed by suitably turning the "three-way" stopcock. It is then, of course, unnecessary to disconnect the special apparatus from the flask.

(3) The washing with concentrated hydrochloric acid removes unchanged alcohol, if present.

COGNATE PREPARATIONS *

Methyl Iodide. Use 38 g. (48 ml.) of methyl alcohol, 8·27 g. of purified red phosphorus and 127 g. of iodine. Cover the iodine completely with the hot methyl alcohol before running the alcoholic solution into the boiling alcohol-phosphorus mixture. B.p. 42–42·5°.

Ethyl Iodide. Use 55 g. (70 ml.) of absolute ethyl alcohol, 8·27 g. of purified red phosphorus and 127 g. of iodine. B.p. 72–73°.

***n*-Propyl Iodide.** Use 98 g. (122 ml.) of *n*-propyl alcohol, 21·00 g. of purified red phosphorus and 200 g. of iodine. B.p. 102–103°.

isoPropyl Iodide. Use 98 g. (125 ml.) of *isopropyl* alcohol, 21·00 g. of purified red phosphorus and 200 g. of iodine. A little hydrogen iodide is evolved. B.p. 89–90°.

* The yields, unless otherwise stated, exceed 90 per cent. of the theoretical. The appropriate size of apparatus (generally of 60 ml. or 100 ml. capacity) should be used ; the corresponding bolt-head flask should have a capacity of 250 or 500 ml.

If the iodide is deeply coloured, it may be decolourised with a little sodium bisulphite. A perfectly colourless product can be obtained by distilling in the dark or in diffused light from a little silver powder. The iodide should be preserved in a bottle containing a short coil of copper wire made by wrapping copper wire round a glass rod or tube.

sec.-Butyl Iodide. Use 119 g. (147.5 ml.) of *sec.*-butyl alcohol, 20.40 g. of purified red phosphorus and 200 g. of iodine. Some hydrogen iodide is evolved. The yield of *sec.*-butyl iodide, b.p. 118–120°, is 228 g.

***n*-Amyl Iodide.** Use 139 g. (171 ml.) of *n*-amyl alcohol, 21.75 g. of purified red phosphorus and 200 g. of iodine. B.p. 153–156°.

2-Iodopentane. Use 88 g. (109 ml.) of methyl *n*-propyl carbinol, 11.30 g. of purified red phosphorus and 256 g. of iodine. B.p. 142–144°.

***n*-Hexyl Iodide.** Use 161 g. (197 ml.) of *n*-hexyl alcohol, 21.75 g. of purified red phosphorus and 200 g. of iodine. B.p. 175–180° (mainly 178–180°).

***n*-Heptyl Iodide.** Use 91.5 g. (111.5 ml.) of *n*-heptyl alcohol (b.p. 175–177°), 10.88 g. of purified red phosphorus and 100 g. of iodine. B.p. 198–201° and 62.5°/3.5 mm.

***n*-Octyl Iodide.** Use 111 g. (134.5 ml.) of *n*-octyl alcohol (b.p. 193–194.5°), 10.20 g. of purified red phosphorus and 100 g. of iodine. The arm *C* in Fig. III, 40, 1 should be lagged with asbestos cloth in order to facilitate the distillation of the alcohol into the iodine. B.p. 219–222° and 86.5°/5 mm.

cycloHexyl Iodide. Use 158 g. of cyclohexanol, 20.40 g. of purified red phosphorus and 200 g. of iodine. It is best to add ether after all the iodine has been introduced into the flask, filter from the solid, remove the ether on a water bath, and distil under diminished pressure. B.p. 81–83°/20 mm. Yield : 290 g.

Trimethylene Di-iodide. Use 76 g. of trimethylene glycol, 27.52 g. of purified red phosphorus and 254 g. of iodine. Lag the arm *C* (Fig. III, 40, 1) with asbestos cloth. Stop the heating immediately all the iodine has been transferred to the flask. Add water to the reaction mixture, decolourise with a little sodium bisulphite, filter, separate the crude iodide, wash it twice with water, dry with anhydrous potassium carbonate and distil under reduced pressure. B.p. 88–89°/6 mm. Yield : 218 g. (a colourless liquid).

β-Phenylethyl Iodide. Use 146 g. (142 ml.) of β-phenylethyl alcohol (b.p. 216.5–217°), 16.54 g. of purified red phosphorus and 154 g. of iodine. Lag the arm *C* (Fig. III, 40, 1) with asbestos cloth. Heat the alcohol-phosphorus mixture to boiling until sufficient alcohol (usually one-third to one-half of the total volume) passes into the reservoir *B* to dissolve all the iodine. Remove the flame and add the iodine solution at such a rate that the mixture boils gently. A little hydrogen iodide is evolved towards the end of the reaction. Allow the mixture to cool, add water and filter off the excess of phosphorus. Decolourise the filtrate with a little sodium bisulphite and add ether to assist in the separation of the water layer. Wash the ethereal solution with water, dry with anhydrous potassium carbonate, and distil under diminished pressure. B.p. 114–116°/12 mm. Yield : 215 g.

III,41.

n-HEXYL FLUORIDE

CAUTION: *Alkyl fluorides are said to be highly toxic. Great care should be taken not to inhale the vapours.*

In a dry 500 ml. three-necked flask, equipped with a mercury-sealed stirrer, a 100 ml. dropping funnel and a short fractionating column (1), place a mixture of 116 g. of anhydrous, finely-powered potassium fluoride (2) and 200 g. of dry ethylene glycol (3). Connect the fractionating

column (which carries a thermometer) to a downward double-surface condenser and a filter flask as receiver. Heat the flask in an oil bath at 160–170° and introduce 165 g. (141 ml.) of *n*-hexyl bromide (Section III, 37) dropwise, with stirring, during 5 hours. A liquid passes over intermittently at 60–90°. When the addition is complete, allow the bath temperature to fall to 110–120°; replace the dropping funnel by a tube of narrow bore dipping just below the surface of the liquid, attach the side arm of the filter flask to a water pump, and draw a slow stream of air through the apparatus whilst maintaining the stirring. It is advisable to interpose a U-tube cooled in ice between the water pump and receiver in order to recover any uncondensed liquid. Distil the combined distillates through an efficient fractionating column (4) or from a Claisen flask with fractionating side arm (Figs. II, 24, 4–5): after a small forerun (0.5 g.) of 1-hexene, collect the crude *n*-hexyl fluoride at 92–97°. Purify the crude product by cooling in ice and adding 1 ml. portions of a solution containing 9.0 g. of bromine and 6.0 g. of potassium bromide in 50 ml. of water until the organic layer acquires an orange colour: shake the mixture vigorously for a minute or so after each addition. The volume of Br₂—KBr solution required is usually less than 5 ml. Separate the aqueous layer, wash the organic layer with saturated aqueous potassium bromide solution until colourless, and finally with water. Dry the liquid with anhydrous magnesium sulphate and distil from a Claisen flask with fractionating side arm (Figs. II, 24, 4–5). Collect the *n*-hexyl fluoride at 92–94°: the yield is 44 g. The colourless liquid keeps unchanged for long periods.

Notes.

(1) Any fractionating column of moderate efficiency is satisfactory, e.g., a Dufton column (20 cm. long containing a spiral 10 cm. in length, 2 cm. in diameter with 8 turns of the helix) or a Vigreux column (20–25 cm. long).

(2) Grind finely pure laboratory grade, anhydrous potassium fluoride, and heat it in an electrically heated oven at 180–210°; store in a desiccator. Before use, dry the powdered salt at 180° for 3 hours and grind again in a warm (ca. 50°) glass mortar.

(3) Redistil laboratory grade ethylene glycol under reduced pressure and collect the fraction of b.p. 85–90°/7 mm. for use as a solvent for the potassium fluoride.

(4) A Widmer column (spiral 18 cm. in length, 1.5 cm. in diameter with 20 turns of the helix) is satisfactory.

COGNATE PREPARATION

***n*-Amyl Fluoride.** Use 116 g. of dry potassium fluoride in 200 g. of dry ethylene glycol: heat in an oil bath at 140–150° and add 302 g. (248 ml.) of *n*-amyl bromide during 5 hours with stirring. The reaction product distils intermittently at 50–85°. The yield of *n*-amyl fluoride, b.p. 63.5–65°, is 50 g.

III, 42. REACTIONS AND CHARACTERISATION OF ALKYL HALIDES

The following are some of the most important reactions of alkyl halides which will assist in their identification.

(i) **Beilstein's test.** This test serves to detect the presence of halogens in many organic compounds. It consists in heating the substance in contact with pure copper oxide in the Bunsen flame: the corresponding

copper halide is formed, which, being volatile, imparts an intense green or bluish-green colour to the mantle of the flame.

Push one end of a length of 20 cm. of stout copper wire into a cork (this will serve as a holder); at the other end make two or three turns about a thin glass rod. Heat the coil in the outer mantle of a Bunsen flame until it ceases to impart any colour to the flame. Allow the wire to cool somewhat and, while still warm, dip the coil into a small portion of the substance to be tested and heat again in the non-luminous flame. If the compound contains a halogen element, a green or bluish-green flame will be observed (usually after the initial smoky flame has disappeared). Before using the wire for another compound, heat it until the material from the previous test has been destroyed and the flame is not coloured.

It has been stated that many halogen-free compounds, *e.g.*, certain derivatives of pyridine and quinoline, purines, acid amides and cyano compounds, when ignited on copper oxide impart a green colour to the flame, presumably owing to the formation of volatile cuprous cyanide. The test is therefore not always trustworthy. The test is not given by fluorides.

(ii) **Alcoholic silver nitrate solution.** Shake 0.1 g. of the substance with 2 ml. of alcoholic silver nitrate solution. Alkyl iodides usually yield silver iodide instantly; alkyl bromides react rapidly, but may require warming; alkyl chlorides give very little precipitate in the cold, but a copious precipitate is obtained by warming on a water bath. The order of reactivity is $I > Br > Cl$ and tertiary $>$ secondary $>$ primary.

The alcoholic silver nitrate solution consists of a saturated solution of silver nitrate in absolute alcohol (about 1-2 per cent.).

(iii) **Alcoholic potassium hydroxide solution.** Boil 0.5 ml. of the compound with 4 ml. of 0.5*N* alcoholic potassium hydroxide under reflux for 15 minutes. Most alkyl halides give a crystalline precipitate of the potassium halide. Dilute with 5 ml. of water, acidify with dilute nitric acid, and test with silver nitrate solution.

The 0.5*N* alcoholic potassium hydroxide solution is prepared by dissolving 16 g. of potassium hydroxide pellets in 500 ml. of alcohol (or industrial spirit) contained in a bottle closed by a cork. After standing for 24 hours, the clear solution is decanted or filtered from the residue of potassium carbonate. It is said that a solution in methyl alcohol has better keeping qualities than that in ethyl alcohol.

CRYSTALLINE DERIVATIVES OF ALKYL HALIDES

1. Anilides and α -Naphthalides. The Grignard reagents prepared from alkyl halides react with phenyl isocyanate ($C_6H_5N=C=O$) or with α -naphthyl isocyanate ($C_{10}H_7\alpha N=C=O$) to yield addition products that are converted by hydrolysis into anilides and α -naphthalides respectively:

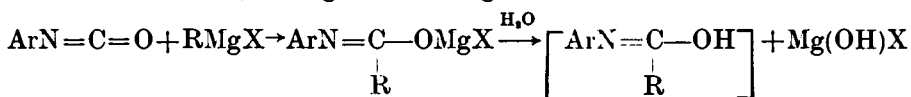
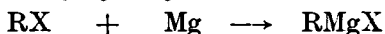

Phenyl isocyanate is a colourless liquid, b.p. 164° or $55^\circ/13$ mm.; its vapour is lachrymatory. The liquid reacts readily with water, yielding diphenyl urea, m.p. 241° , and hence must be protected from atmospheric moisture:

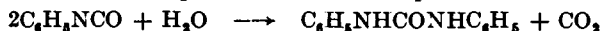

α -Naphthyl isocyanate, b.p. 269–270° or 153°/18 mm., is not quite so irritant and is somewhat more stable towards water (di- α -naphthyl urea has m.p. 297°). It is therefore to be preferred as a reagent; furthermore the α -naphthalides are less soluble than the corresponding anilides.

In a small dry flask, fitted with a short reflux condenser and a calcium chloride or cotton wool guard tube, place 0.4 g. of dry magnesium turnings, a minute crystal of iodine and a solution of 1 ml. (or 0.01 mol) of the alkyl halide in 10–15 ml. of anhydrous ether. If the reaction does not start immediately (as indicated by the disappearance of the iodine colour), warm for a short period in a beaker of warm water; allow the reaction to proceed spontaneously, moderating it if necessary by immersing the flask in cold water. When the reaction has ceased, decant the nearly clear liquid from any solid material into another flask, and fit the reflux condenser into it. Add, portion-wise, through the condenser a solution of 0.5 ml. of phenyl- or α -naphthyl-isocyanate in 15 ml. of anhydrous ether, shaking the flask after each addition. Allow the mixture to stand for 10 minutes and then add 30 ml. of *N* hydrochloric acid dropwise and with vigorous shaking and cooling in ice. (Alternatively, pour the reaction mixture cautiously into 20 ml. of ice water containing 1 ml. of concentrated hydrochloric acid, and shake the mixture well.) Transfer to a separatory funnel, shake well, then discard the lower aqueous layer. Dry the ethereal solution with a little anhydrous magnesium sulphate and distil off the ether. Recrystallise the residue: methyl alcohol, ethyl alcohol, petroleum ether, ether or hot water are suitable recrystallisation solvents.

If dry apparatus and dry reagents have not been used, diphenyl urea (m.p. 241°) or di- α -naphthyl urea (m.p. 297°) are obtained.

2. **Alkyl mercuric halides.** Grignard reagents, prepared from alkyl halides, react with a mercuric halide that contains the *same halogen* as the reagent to form alkyl mercuric halides:

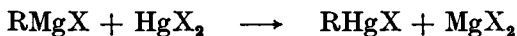

The reaction is applicable to primary and secondary halides only; tertiary halides do not react.

Filter the Grignard solution, prepared as in 1, rapidly through a little glass wool into a test-tube containing 4–5 g. of mercuric chloride, bromide or iodide, depending upon the halogen in the original alkyl halide. Shake the reaction mixture vigorously for a few minutes and then evaporate the ether. Boil the residue with 20 ml. of rectified spirit, filter the solution, dilute it with 10 ml. of distilled water, reheat to dissolve any precipitated solid, and allow to cool. Recrystallise the alkyl mercuric halide from dilute alcohol.

3. **S-Alkyl-*iso*-thiuronium picrates.** Alkyl bromides or iodides react with thiourea in alcoholic solution to produce S-alkyl-*iso*-thiuronium salts, which yield picrates of sharp melting point:

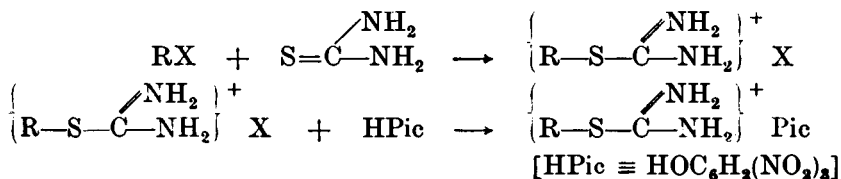

Alkyl chlorides react slowly and the yield of the derivative is poor. Tertiary halides give anomalous results.

Place a mixture of 0.5 g. of finely powdered thiourea, 0.5 g. of the alkyl halide and 5 ml. of alcohol in a test-tube or small flask equipped with a reflux condenser. Reflux the mixture for a period depending upon the nature of the halide: primary alkyl bromides and iodides, 10–20 minutes (according to the molecular weight); secondary alkyl bromides or iodides, 2–3 hours; alkyl chlorides, 3–5 hours; polymethylene dibromides or di-iodides, 20–50 minutes. Then add 0.5 g. of picric acid, boil until a clear solution is obtained, and cool. If no precipitate is obtained, add a few drops of water. Recrystallise the resulting S-alkyl-*iso*-thiuronium picrate from alcohol.

The derivatives of ethylene dibromide, propylene dibromide, trimethylene dibromide and *iso*-butylene dibromide melt at 260°, 232°, 229° and 223° respectively.

4. Picrates of β -naphthyl alkyl ethers. Alkyl halides react with the sodium or potassium derivative of β -naphthol in alcoholic solution to yield the corresponding alkyl β -naphthyl ethers (which are usually low m.p. solids) and the latter are converted by alcoholic picric acid into the crystalline picrates:

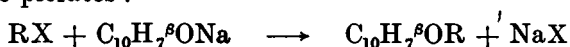

Mix together 1.0 g. of pure β -naphthol and the theoretical quantity of 50 per cent. potassium hydroxide solution, add 0.5 g. of the halide, followed by sufficient rectified spirit to produce a clear solution. For alkyl chlorides, the addition of a little potassium iodide is recommended. Heat the mixture under reflux for 15 minutes, and dissolve any potassium halide by the addition of a few drops of water. The β -naphthyl ether usually crystallises out on cooling; if it does not, dilute the solution with 10 per cent. sodium hydroxide solution until precipitation occurs. Dissolve the β -naphthyl ether in the minimum volume of hot alcohol and add the calculated quantity of picric acid dissolved in hot alcohol. The picrate separates out on cooling. Recrystallise it from rectified spirit.

The β -naphthyl ethers of methylene halides have m.p. 133°, of ethylene halides 217°, and trimethylene halides 148°.

Di- and poly-halogenated aliphatic hydrocarbons. No general procedure can be given for the preparation of derivatives of these compounds. Reliance must be placed upon their physical properties (b.p., density and refractive index) and upon any chemical reactions which they undergo.

Table III,42 deals with a number of aliphatic halogen compounds together with their crystalline derivatives. Some aromatic compounds, which simulate the properties of aliphatic halides in some respects, are included.

TABLE III,42.

ALIPHATIC HALOGEN COMPOUNDS

Halide	B.P.	M.P.	$d_{4}^{20^{\circ}}$	$n_{D}^{20^{\circ}}$	Anilide	α -Naphthalide	Alkyl Mercuric Halide	S-Alkyl- <i>iso</i> -thiuronium Picrate	Picrate of β -naphthyl ether
CHLORIDES									
Ethyl	12°	—	—	—	104°	126°	193°	—	102°
<i>n</i> -Propyl	46	—	0.889	1.388	92	121	140	177°	81
<i>iso</i> -Propyl	35	—	0.863	1.378	104	—	—	—	95
<i>n</i> -Butyl	77	—	0.886	1.402	63	112	128	177	67
<i>iso</i> -Butyl	69	—	0.881	1.398	110	126	—	—	84
<i>sec.</i> -Butyl	68	—	0.874	1.397	108	129	—	—	85
<i>tert.</i> -Butyl	50	—	0.846	1.386	128	147	—	—	—
<i>n</i> -Amyl	105	—	0.882	1.412	96	112	110	154	67
<i>iso</i> -Amyl	99	—	0.872	1.409	110	111	86	173	94
Neopentyl	85	—	0.879	—	126	—	—	—	—
β -Chloropentane	97	—	0.873	1.408	—	—	—	—	—
γ -Chloropentane	96	—	0.872	1.408	—	—	—	—	—
<i>tert.</i> -Amyl	85	—	0.865	1.405	92	138	—	—	—
<i>n</i> -Hexyl	134	—	0.878	1.420	69	106	125	—	—
<i>n</i> -Heptyl	159	—	0.877	1.426	57	95	119	—	—
<i>n</i> -Octyl	182	—	0.875	1.431	57	91	151	—	—
<i>n</i> -Nonyl	202	—	0.870	1.434	—	—	—	—	—
<i>n</i> -Decyl	223	—	0.868	1.437	—	—	—	—	—
<i>n</i> -Undecyl	241	—	0.868	1.440	—	—	—	—	—
<i>n</i> -Dodecyl	130°/15	—	0.867	1.443	—	—	—	—	—
<i>cyclo</i> Pentyl	114	—	1.005	1.451	—	—	—	—	—
<i>cyclo</i> Hexyl	142	—	0.989	1.462	146	188	—	—	—
Benzyl	179	—	1.100	1.539	117	166	—	188	123
Benzal	207	—	—	—	166	—	—	—	—
Benzo tri-	218	—	—	—	—	—	—	—	—
β -Phenylethyl	198	—	—	—	97	—	—	—	84
Allyl	45	—	0.940	1.416	114	—	—	154	99

TABLE III,42.

ALIPHATIC HALOGEN COMPOUNDS (*continued*)

294

Halide	B.P.	M.P.	d_{4}^{20}	n_{D}^{20}	Anilide	α -Naphthalide	Alkyl Mercuric Halide	S-Alkyl- <i>iso</i> -thiuronium Picrate	Picrate of β -naphthyl ether
BROMIDES									
Ethyl	38°	—	1.460	1.425	104°	126°	194°	188°	102°
<i>n</i> -Propyl	71	—	1.435	1.355	92	121	138	177	81
<i>iso</i> -Propyl	59	—	1.425	1.314	104	—	94	196	95
<i>n</i> -Butyl	101	—	1.274	1.440	63	112	129	177	67
<i>iso</i> -Butyl	91	—	1.253	1.435	110	126	56	167	84
<i>sec.</i> -Butyl	91	—	1.256	1.437	108	129	39	166	85
<i>n</i> -Amyl	129	—	1.219	1.445	96	112	122	154	67
<i>iso</i> -Amyl	119	—	1.213	1.442	110	111	80	173	94
<i>Neo</i> Pentyl	109	—	1.225	—	126	—	—	—	—
β -Bromopentane	117	—	1.212	1.442	93	—	—	—	—
γ -Bromopentane	118	—	1.211	1.443	124	—	—	—	—
<i>n</i> -Hexyl	154	—	1.175	1.448	69	106	119	157	—
<i>n</i> -Heptyl	178	—	1.140	1.451	57	95	115	142	—
<i>n</i> -Octyl	200	—	1.112	1.453	57	91	109	134	—
<i>n</i> -Nonyl	220	—	1.090	1.454	—	—	109	—	—
<i>n</i> -Decyl	103°/6	—	1.066	1.455	—	—	—	—	—
<i>n</i> -Undecyl	114°/5	—	1.054	1.457	—	—	—	—	—
<i>n</i> -Dodecyl	130°/6	—	1.038	1.458	—	—	108	—	—
<i>n</i> -Tetradecyl	179°/20	5°	1.017	1.460	—	—	—	—	—
<i>n</i> -Hexadecyl	201°/19	14	1.001	1.462	—	—	—	137	—
<i>cyclo</i> Pentyl	137	—	1.387	1.489	—	—	—	—	—
<i>cyclo</i> Hexyl	164	—	1.336	1.495	146	188	153	—	—
Benzyl	198	—	1.438	—	117	166	119	188	123
β -Phenylethyl	218	—	1.359	1.556	97	—	169	—	84
Allyl	70	—	1.432	1.470	114	—	—	—	99

TABLE III,42.

ALIPHATIC HALOGEN COMPOUNDS (*continued*)

Halide	B.P.	M.P.	$d_{4}^{20^{\circ}}$	$n_{D}^{20^{\circ}}$	Anilide	α -Naphthalide	Alkyl Mercuric Halide	S-Alkyl- <i>iso</i> -thiuronium Picrate	Picrate of β -naphthyl ether
IODIDES									
Methyl	42°	—	2.282	1.532	114°	160°	145°	224°	117°
Ethyl	73	—	1.940	1.514	104	126	182	188	102
<i>n</i> -Propyl	102	—	1.743	1.505	92	121	113	177	81
<i>iso</i> -Propyl	89	—	1.703	1.499	104	—	—	196	95
<i>n</i> -Butyl	129	—	1.616	1.499	63	112	117	177	67
<i>iso</i> -Butyl	119	—	1.602	1.496	110	126	72	167	84
<i>sec.</i> -Butyl	118	—	1.592	1.499	108	129	—	166	85
<i>n</i> -Amyl	155	—	1.512	1.496	96	112	110	154	—
<i>iso</i> -Amyl	147	—	1.503	1.493	110	111	122	173	94
β -Iodopentane	142	—	1.510	1.496	—	—	—	—	—
γ -Iodopentane	142	—	1.511	1.497	—	—	—	—	—
<i>tert.</i> -Amyl	128	—	1.479	—	92	138	—	—	—
<i>n</i> -Hexyl	180	—	1.437	1.493	69	106	110	157	—
<i>n</i> -Heptyl	201	—	1.373	1.490	57	95	103	—	—
<i>n</i> -Octyl	221	—	1.330	1.489	—	—	—	—	—
<i>cyclo</i> Pentyl	58°/22	—	1.709	1.547	—	—	—	—	—
<i>cyclo</i> Hexyl	82°/20	—	1.624	1.547	—	—	—	—	—
Benzyl	93°/10	24°	—	—	116	—	—	—	123
β -Phenylethyl	116°/12	—	1.632	1.602	—	—	—	—	84
Allyl	100	—	1.777	1.578	114	121	112	154	99
IODO COMPOUNDS									
Methylene iodide	80°/25	—	3.324	1.741	—	—	—	—	—
Ethylene iodide	—	81°	—	—	—	—	—	—	—
Trimethylene iodide	90°/9	—	2.576	1.642	—	—	—	—	—
Iodoform	—	119	—	—	—	—	—	—	—

TABLE III,42.

ALIPHATIC HALOGEN COMPOUNDS (continued)

Halide	B.P.	M.P.	$d_{4}^{20^{\circ}}$	$n_{D}^{20^{\circ}}$
CHLORO COMPOUNDS				
Methylene chloride	42°	—	1.336	1.425
Dichloroethylene (<i>trans</i>)	48	—	1.257	1.444
Ethylidene chloride	57	—	1.176	1.416
Dichloroethylene (<i>cis</i>)	60	—	1.282	1.446
Chloroform	61	—	1.489	1.446
2 : 2-Dichloropropane	70	—	1.092	1.412
Methyl chloroform	75	—	1.349	1.438
Carbon tetrachloride	77	—	1.594	1.461
Ethylene chloride	84	—	1.256	1.445
Trichloroethylene	87	—	1.465	1.478
Propylene chloride	96	—	1.155	1.439
Ethylene chlorobromide	107	—	1.689	1.491
1 : 1 : 2-Trichloroethane	114	—	1.443	1.471
Trimethylene chloride	120	—	1.183	1.449
Tetrachloroethylene	121	—	1.623	1.506
Trimethylene chlorobromide	143	—	1.593	1.471
<i>sym.</i> -Tetrachloroethane	147	—	1.597	1.496
1 : 4-Dichlorobutane	153	—	1.139	1.455
1 : 2 : 3-Trichloropropane	157	—	1.394	1.486
Pentachloroethane	162	—	1.680	1.503
1 : 5-Dichloropentane	178d	—	1.100	1.457
1 : 6-Dichlorohexane	204d	—	1.069	1.457
Hexachloroethane	—	187° (sub.)	—	—
BROMO COMPOUNDS				
Methylene bromide	97	—	2.496	1.541
Ethylidene bromide	113	—	2.055	1.513
Ethylene bromide	131	—	2.183	1.539
Propylene bromide	141	—	1.932	1.520
Bromoform	150	—	2.887	1.598
<i>iso.</i> -Butylene bromide	150	—	1.783	1.512
2 : 3-Dibromobutane	157	—	1.792	1.515
1 : 3-Dibromopropane	165	—	1.982	1.523
1 : 2-Dibromobutane	166	—	1.820	—
1 : 4-Dibromobutane	198	—	1.826	1.519
1 : 2 : 3-Tribromopropane	220	—	2.402	1.582
1 : 5-Dibromopentane	221	—	1.702	1.513
1 : 6-Dibromohexane	240	—	1.603	1.506
<i>sym.</i> -Tetrabromoethane	124°/19	—	2.967	1.628
Carbon tetrabromide	—	92°	—	—

POLYHALOGEN COMPOUNDS

Acetone ($R = CH_3$) when treated with sodium hypochlorite or bleaching powder solution yields chloroform, probably in accordance with the following mechanism :

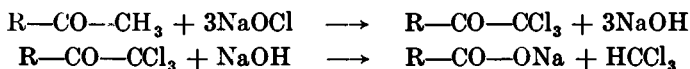

Ethyl alcohol, which is first oxidised to acetaldehyde ($R = H$), behaves similarly :

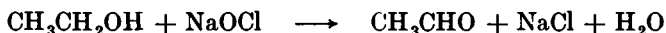

Sodium hypobromite and sodium hypoiodite solutions react in an analogous manner and yield bromoform ($CHBr_3$) and iodoform (CHI_3) respectively. The smooth production of the trihalomethanes by the use of the appropriate hypohalides is termed the **haloform reaction**. It is applicable to all compounds containing the $-COCH_3$ group or which yield a substance containing this group by oxidation (*e.g.*, acetaldehyde from ethyl alcohol). Iodoform is a stable, crystalline, yellow solid, m.p. 119° , with a characteristic odour; it is only sparingly soluble in water and hence will separate, even in very minute quantity, from an aqueous solution and can easily be identified by m.p. and mixed m.p. determinations.

III,43.

CHLOROFORM

Much of the chloroform of commerce is obtained by the action of moist iron upon carbon tetrachloride: the following preparation is, however, instructive.

Fit a 2-litre round-bottomed flask with a two-holed cork carrying a dropping funnel and a glass tube bent at an angle of about 60° to act as a still head (compare Fig. *II, 13, 3*). Attach the latter to a condenser (set for downward distillation) and insert the end of the condenser through a cork into a filter flask to act as a receiver. Attach a length of 5 mm. glass tubing to the stem of the funnel by means of a short length of rubber "pressure" tubing; the end of the glass tube should dip just below the surface of the liquid in the flask.

Place 200 g. of bleaching powder in a mortar and add 500 ml. of water in small quantities at a time; between each addition grind the mixture of bleaching powder and water well together, and decant the suspension into the flask. Only a small quantity of a gritty residue should remain in the mortar when all the water has been introduced. It may be more convenient to prepare the suspension in two operations, each with 100 g. of bleaching powder and 250 ml. of water. Arrange the apparatus for heating on a wire gauze, and place 20 ml. of water in the receiver. Introduce 25 g. (32 ml.) of acetone diluted with an equal volume of water into the separatory funnel. Allow about 5 ml. of the dilute acetone to enter the flask and heat gently. After a short period the contents of the flask commence to froth and chloroform distils into the receiver. At this point great care must be exercised to prevent "frothing over" into the receiver. Shake the flask from time to time and break down the froth; if the

foaming at any stage appears to be out of control, remove the small flame from beneath the flask and, if necessary, cool the flask by means of a large wet cloth. [A wet cloth should be at hand for this purpose.] As soon as the chloroform passes over into the receiver, continue the addition of the dilute acetone in small portions. When all the acetone has been run into the flask, add 10–15 ml. of water through the separatory funnel and continue heating the flask until the condensate is clear. Separate the lower layer of chloroform from the water, wash it once with an equal volume of 2 per cent. sodium hydroxide solution, and then with an equal volume of water. Carefully run off the lower layer of chloroform into a small conical flask, dry it over 2–3 g. of anhydrous calcium chloride for 15–20 minutes, filter it into a small distilling flask, and distil. Collect the fraction of b.p. 60–63°. The yield is 30 g.

Chloroform undergoes oxidation to the very poisonous phosgene upon exposure to light and air. Commercial specimens are therefore stored in brown bottles and contain 1–2 per cent. of alcohol; the latter converts the toxic phosgene into the harmless substance diethyl carbonate :

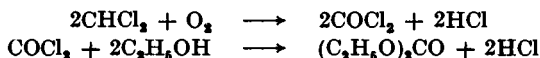

CHLORAL HYDRATE, $\text{CCl}_3\text{CH}(\text{OH})_2$

The student is recommended to carry out the following reactions with chloral hydrate in order to familiarise himself with its general properties.

(i) This substance, m.p. 52°, b.p. 97·5°, is of interest since it yields chloroform upon warming with dilute sodium hydroxide solution :

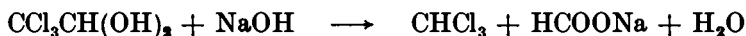

Confirm this by treating 0·5 g. of chloral hydrate with 3 ml. of dilute sodium hydroxide solution and warming gently.

(ii) Treat 0·5 g. dissolved in 1 ml. of water with a little Schiff's reagent (Section III,70,(iii)) : the colour is not restored.

(iii) Dissolve 0·5 g. in 1 ml. of water, add a little ammoniacal silver nitrate solution and warm. Metallic silver is deposited (compare Section III,70,(i)).

(iv) Repeat experiment (iii) with Fehling's solution as the reagent ; the latter is reduced and some chloroform is produced, due to the action of the alkali present in the Fehling's solution.

(v) Place 5 g. of chloral hydrate and 5 ml. of concentrated sulphuric acid in a small dry distilling flask, and distil slowly. Collect the first 2–3 drops of the distillate in 2 ml. of Schiff's reagent : observe that the colour is immediately restored (this is because chloral, CCl_3CHO , the free aldehyde, is liberated by the acid). Continue the distillation and collect about 3 ml. of the liquid chloral in a dry test-tube ; this gives all the reactions of aldehydes (see Section III,70). Treat a small portion with a few drops of water ; the chloral hydrate is reformed.

III,44.

BROMOFORM

Fit a 1000 ml. three-necked flask with a mechanical stirrer (*not* mercury sealed), a dropping funnel (Fig. II, 1, 5, f) with stem reaching to almost the bottom of the flask, and another separatory funnel but with a short stem. Clamp the flask in a large beaker containing water maintained at 50°. Introduce into the flask 30 ml. (24 g.) of acetone and 150 ml. of 20 per cent. sodium carbonate solution. Place 75 ml. (234 g.) of bromine in the long-stemmed funnel and 10 per cent. sodium hydroxide solution in the other funnel (about 800 ml. are required). Set the stirrer in motion and allow the bromine to drop slowly into the well-stirred alkaline mixture. Bromoform soon separates out. As soon as the bromine is no longer decolourised, introduce the sodium hydroxide solution from the second separatory funnel slowly and at such a rate that the mixture in the flask does not become strongly alkaline. The correct rate of addition of the sodium hydroxide solution is attained when, on stopping the addition, the liquid immediately assumes the red colour of bromine. The bath should be maintained at 50° throughout the experiment. When all the bromine has been introduced, stop the addition of the alkali, remove the heavy layer of bromoform, wash it with water, and dry with anhydrous calcium chloride. (If desired, the dry bromoform may be shaken with concentrated sulphuric acid to remove impurities, but this is not always necessary.) Distil the crude bromoform, preferably in a current of carbon dioxide, and collect the fraction boiling at 148–149.5°; this has a m.p. of 7–8°. The yield is 68 g.

Pure bromoform is somewhat unstable and darkens on keeping; it may be stabilised by the addition of 4 per cent. of its weight of ethyl alcohol or of a small quantity of diphenylamine.

III,45.

IODOFORM

Place a solution of 6 g. of potassium iodide in 100 ml. of water in a 500 ml. flask and add 2 ml. of acetone. Slowly add, with frequent shaking, a 5 per cent. solution of sodium hypochlorite (1) as long as any precipitate of iodoform is formed; about 65 ml. are required. Allow the mixture to stand for about 10 minutes, then filter at the pump, wash the crystals two or three times with water, and drain the crystals thoroughly. Recrystallise the crude iodoform from methylated spirit (or rectified spirit) in the following manner. Place the crude material in a 100 or 150 ml. round-bottomed flask fitted with a reflux water condenser; add a small volume of methylated spirit and heat to boiling on a water bath. Continue the addition of the methylated spirit, in small quantities down the condenser, until all the iodoform has dissolved; about 50 ml. are used. Filter the hot solution through a fluted filter paper into a conical flask or small beaker, and cool thoroughly. The iodoform crystallises rapidly. Filter at the pump, drain thoroughly, and allow the crystals to dry. Pure iodoform melts at 119°. The yield is 3.5 g.

Note.

(1) The commercial 10–14 per cent. sodium hypochlorite solution should be diluted with an equal volume of water.

III,46. METHYLENE BROMIDE

Methylene bromide (CH_2Br_2) and methylene iodide (CH_2I_2) are easily prepared by the reduction of bromoform or iodoform respectively with sodium arsenite in alkaline solution :

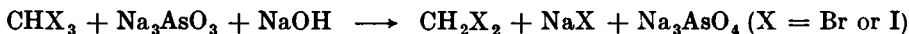

Methylene chloride CH_2Cl_2 , b.p. 41° , is obtained as a by-product in the commercial preparation of chloroform by the reduction of carbon tetrachloride with moist iron and also as one of the products in the chlorination of methane; it is a useful extraction solvent completely immiscible with water.

In a 1-litre three-necked flask, mounted on a steam bath and provided respectively with a separatory funnel, mechanical stirrer and double surface condenser, place 165 g. of bromoform (96 per cent.). Add 10 ml. of a solution of sodium arsenite made by dissolving 77 g. of A.R. arsenious oxide and 148 g. of A.R. sodium hydroxide in 475 ml. of water. Warm the mixture gently to start the reaction, and introduce the remainder of the sodium arsenite solution during 30–45 minutes at such a rate that the mixture refluxes gently. Subsequently heat the flask on the steam bath for 3–4 hours. Steam distil the reaction mixture (Fig. II, 41, 1) and separate the lower layer of methylene bromide (79 g.). Extract the aqueous layer with about 100 ml. of ether; a further 3 g. of methylene bromide is obtained. Dry with 3–4 g. of anhydrous calcium chloride, and distil from a Claisen flask with fractionating side arm. The methylene bromide boils constantly at $96\text{--}97^\circ$ and is almost colourless.

III,47. METHYLENE IODIDE

In a 1-litre three-necked flask, fitted with a mechanical stirrer, reflux condenser and a thermometer, place 200 g. of iodoform and half of a sodium arsenite solution, prepared from 54.5 g. of A.R. arsenious oxide, 107 g. of A.R. sodium hydroxide and 520 ml. of water. Start the stirrer and heat the flask until the thermometer reads $60\text{--}65^\circ$; maintain the mixture at this temperature during the whole reaction (1). Run in the remainder of the sodium arsenite solution during the course of 15 minutes, and keep the reaction mixture at $60\text{--}65^\circ$ for 1 hour in order to complete the reaction. Allow to cool to about $40\text{--}45^\circ$ (2) and filter with suction from the small amount of solid impurities. Separate the lower layer from the filtrate, dry it with anhydrous calcium chloride, and distil the crude methylene iodide (131 g.; this crude product is satisfactory for most purposes) under diminished pressure. Practically all passes over as a light straw-coloured (sometimes brown) liquid at $80^\circ/25\text{ mm.}$; it melts at 6° . Some of the colour may be removed by shaking with silver powder. The small dark residue in the flask solidifies on cooling.

Notes.

(1) If the temperature is allowed to rise, the yield is slightly diminished owing to the formation of a little methyl iodide.

(2) If the temperature falls below 40° , a precipitate of sodium arsenate will gradually separate and this will tend to produce an emulsion of the methylene iodide, thus rendering filtration and separation difficult.

III.48. 1 : 2 : 3-TRIBROMOPROPANE

Provide a 1-litre three-necked flask with a dropping funnel carrying a cotton wool (or calcium chloride) guard tube, a mechanical stirrer, and a thermometer reaching almost to the bottom of the flask, and cool the flask in a mixture of ice and salt. Place in the flask 182 g. (132 ml.) of allyl bromide (1) and 250 ml. of dry carbon tetrachloride (2), and introduce 255 g. (80 ml.) of dry A.R. bromine (3) into the dropping funnel. Set the stirrer in motion and when the temperature has fallen to -5° , drop the bromine in slowly at such a rate that the temperature does not rise above 0° (about 90 minutes). Allow the orange-coloured solution (the colour is due to a slight excess of bromine) to warm to room temperature with constant stirring (about 30 minutes) and then transfer it to a large separatory funnel. Arrange a 500 ml. Claisen flask, heated in an oilbath at 120° , for distilling the solvent (as in Fig. *II, 13, 4*), and drop in the solution from the funnel at such a rate that the flask is never more than two-thirds full. When all the solution has been transferred to the flask, raise the temperature of the bath to 150° in order to remove as much solvent as possible. Distil the residue under reduced pressure (Fig. *II, 20, 1*); the residual carbon tetrachloride passes over first, followed by 1 : 2 : 3-tribromopropane at $92-93^{\circ}/10$ mm. (or $100-103^{\circ}/18$ mm.) as an almost colourless liquid. The yield is 400 g.

**Notes.**

(1) The allyl bromide (Section *III,35*) should be dried over anhydrous calcium chloride and redistilled; the fraction b.p. $69-72^{\circ}$ is collected for use in this preparation.

(2) Commercial carbon tetrachloride is dried by distilling and rejecting the first 10 per cent. of the distillate.

(3) Bromine is dried by shaking once with an equal volume of concentrated sulphuric acid.

ESTERS OF INORGANIC ACIDS

Strictly speaking the alkyl halides are esters of the halogen acids, but since they enter into many reactions (*e.g.*, formation of Grignard reagents, reaction with potassium cyanide to yield nitriles, etc.) which cannot be brought about by the other esters, the alkyl halides are usually distinguished from the esters of the other inorganic acids. The preparation of a number of these is described below.

Alkyl sulphites. From the alcohol and thionyl chloride, for example :

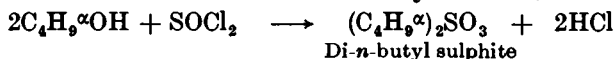

Alkyl phosphates. From phosphorus oxychloride and the alcohol in the presence of pyridine, for example :

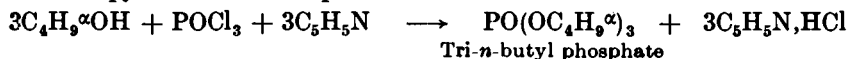

Alkyl borates. By heating boric acid with excess of the alcohol ; the water formed in the reaction is removed by fractional distillation as an azeotropic mixture with the alcohol, for example :

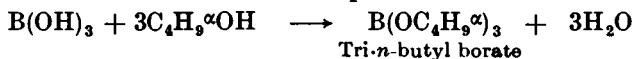

Alkyl thiocyanates. From potassium or sodium thiocyanate and the alkyl halide in alcoholic solution, for example :

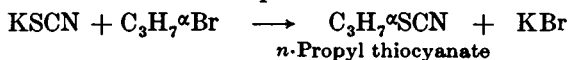

Alkyl nitrites. By the interaction at 0° of the alcohol with sodium nitrite in the presence of excess of concentrated sulphuric acid, for example :

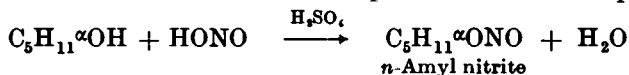

Aliphatic nitro compounds. These are isomeric with the alkyl nitrites and may be prepared from the alkyl halide and silver nitrite, for example :

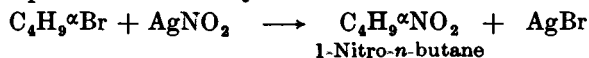

Nitromethane is more easily prepared by heating together equimolecular amounts of sodium monochloroacetate and sodium nitrite in aqueous solution ; sodium nitroacetate is intermediately formed and is decomposed to nitromethane and sodium bicarbonate. The latter yields sodium carbonate and carbon dioxide at the temperature of the reaction.

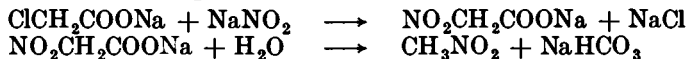

Nitroethane may be similarly obtained from sodium α -chloropropionate. This is a general reaction for α -chloro-carboxylic acids, but in practice only monochloroacetic acid and α -chloropropionic acid are readily available.

The nitroparaffins in which the nitro group is attached to a primary or secondary carbon atom exist in tautomeric forms, for example :

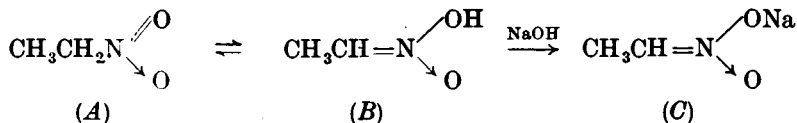

The normal form *A* can pass by tautomeric change under the influence of alkali into the acidic hydroxy form *B*, which in turn can yield the sodium salt *C*. Nitroparaffins are therefore pseudo-acids, and are soluble in alkaline solution.

The simpler nitroparaffins (nitromethane, nitroethane, 1- and 2-nitropropane) are now cheap commercial products. They are obtained by the vapour phase nitration of the hydrocarbons: a gaseous mixture of two mols of hydrocarbon and 1 mol of nitric acid vapour is passed through a narrow reaction tube at 420–475°. Thus with methane at 475° a 13 per cent. conversion into nitromethane is obtained; ethane at 420° gives a 9:1 mixture of nitroethane (b.p. 114°) and nitromethane (b.p. 102°); propane at 420° affords a 21 per cent. yield of a complex mixture of 1- (b.p. 130·5°) and 2-nitropropane (b.p. 120°), nitroethane and nitromethane, which are separated by fractional distillation.

Alkyl sulphates. The dimethyl and diethyl esters may be prepared *inter alia* by the interaction of chlorosulphonic acid with the anhydrous alcohol, followed by distillation of the resulting alkyl sulphuric acid under diminished pressure, for example:

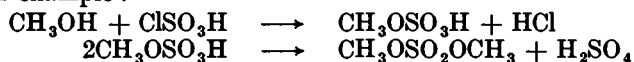

The preparation of these compounds in the laboratory is not recommended and is rarely worth while because of the cheapness of the commercial products. Dimethyl sulphate is a heavy liquid, boiling at 188·5°, and is practically without odour. *The vapour is highly poisonous and the substance should only be used in a fume cupboard with a good draught. The liquid itself is readily absorbed through the skin, with toxic results.*

Dimethyl sulphate is of particular value for the methylation of phenols and sugars. The phenol is dissolved in a slight excess of sodium hydroxide solution, the theoretical quantity of dimethyl sulphate is added, and the mixture is heated on a water bath and shaken or stirred mechanically (compare Section IV, 104). Under these conditions only one of the methyl groups is utilised; the methyl hydrogen sulphate formed in the reaction reacts with the alkali present:

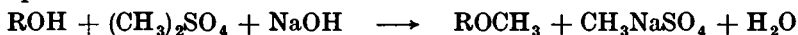

Diethyl sulphate, b.p. 210° (decomp.), does not ordinarily react so vigorously as dimethyl sulphate, but is nevertheless of great value for ethylations. It is somewhat less poisonous than the methyl analogue, but the same precautions should be taken. Both sulphates should be stored in glass-stoppered bottles sealed with paraffin wax, for they attack cork.

III, 49.

n-BUTYL SULPHITE

Fit up the apparatus shown in Fig. III, 31, 1; the capacity of the Claisen flask should be 100 ml. Place 40 g. (24·5 ml.) of redistilled thionyl chloride in the flask and 50 g. (62 ml.) of dry *n*-butyl alcohol (b.p. 116–117°) in the dropping funnel. Cool the flask in ice and add the *n*-butyl alcohol, with frequent shaking, over 1 hour (1). Reflux the mixture gently for 1 hour to complete the reaction and to remove the residual hydrogen chloride. Arrange the apparatus for distillation, and distil under normal pressure until the temperature rises to 120°; then distil under diminished pressure (Fig. II, 20, 1) and collect the di-*n*-butyl sulphite at 116–118°/20 mm. The yield is 55 g.

Note.

(1) For preparations on a larger scale, a three-necked flask should be used and mechanical stirring substituted for hand shaking.

COGNATE PREPARATIONS

Methyl sulphite. From 22 g. (28 ml.) of anhydrous methyl alcohol and 40 g. (24.5 ml.) of thionyl chloride. B.p. 126°. Yield : 31 g.

Ethyl sulphite. From 40 g. (51 ml.) of absolute ethyl alcohol and 52 g. (32 ml.) of thionyl chloride. B.p. 156–157°. Yield : 40 g.

***n*-Amyl sulphite.** From 55 g. (67.5 ml.) of *n*-amyl alcohol and 40 g. (24.5 ml.) of thionyl chloride. B.p. 111.5°/5 mm. Yield : 53 g.

III,50.

***n*-BUTYL PHOSPHATE**

The apparatus required is a 1-litre three-necked flask, the three necks of which carry respectively a double surface condenser, a mercury-sealed stirrer, and a short-stemmed dropping funnel and a thermometer (passing through a two-holed cork). Calcium chloride (or cotton wool) guard tubes should be provided for the dropping funnel and the reflux condenser. Place 111 g. (137 ml.) of dry *n*-butyl alcohol, 130 g. (132.5 ml.) of dry pyridine and 140 ml. of dry benzene in the flask, set the stirrer in motion and cool the flask in an ice-salt mixture until the temperature falls to -5° . Introduce 76.5 g. (40.5 ml.) of redistilled phosphorus oxychloride (b.p. 106–107°) dropwise from the funnel at such a rate that the temperature does not rise above 10° . Reflux gently for 2 hours, and then allow to cool to room temperature. Add 250 ml. of water to dissolve the pyridine hydrochloride, separate the benzene layer, wash it several times with water until the washings are neutral, and dry over 10 g. of anhydrous sodium or magnesium sulphate. Remove most of the benzene under normal pressure (Fig. II, 13, 4 but with a Claisen flask replacing the distilling flask), and finally distil under diminished pressure. Collect the *n*-butyl phosphate at 160–162°/15 mm. (or 138–140°/6 mm.). The yield is 95 g.

The above is a general procedure for preparing trialkyl orthophosphates. Similar yields are obtained for trimethyl phosphate, b.p. 62°/5 mm.; triethyl phosphate, b.p. 75.5°/5 mm.; tri-*n*-propyl phosphate, b.p. 107.5°/5 mm.; tri-*iso*-propyl phosphate, b.p. 83.5°/5 mm.; tri-*iso*-butyl phosphate, b.p. 117°/5.5 mm.; and tri-*n*-amyl phosphate, b.p. 167.5°/5 mm. The alkyl phosphates are excellent alkylating agents for primary aromatic amines (see Section IV, 41); they can also be used for alkylating phenols (compare Sections IV, 104–105). Trimethyl phosphate also finds application as a methylating agent for aliphatic alcohols (compare Section III, 58).

III,51.

***n*-BUTYL BORATE**

The apparatus required consists of a 1-litre bolt-head flask carrying a dropping funnel and a 30 cm. Hempel column filled with $\frac{1}{4}$ " glass rings or with $\frac{1}{8}$ " porcelain rings (Fig. II, 15, 3; compare Fig. III, 61, 1) or a 30 cm. all-glass Dufton column (Fig. II, 15, 2) connected to an efficient double surface condenser or to a long (40–50 cm.) Liebig condenser. The fractionating column is fitted with a thermometer. Place 62 g. of A.R. boric acid, 333 g. (412 ml.) of *n*-butyl alcohol and a few chips of porous porcelain in the flask. Heat the reaction mixture (*e.g.*, in an air bath, Fig. II, 5, 3) so that it boils gently, and adjust the rate of heating so

that 45–50 ml. of distillate are collected in 30 minutes. The temperature of the vapour at the top of the column remains at 91° over a period of about 2 hours whilst an azeotropic mixture of water and *n*-butyl alcohol distils; the latter separates into two layers and contains about 72 per cent. of wet alcohol. After 1 hour separate the upper layer of *n*-butyl alcohol in the distillate, dry it with anhydrous potassium carbonate or anhydrous magnesium sulphate, and return it to the flask through the dropping funnel; repeat this process after 90 minutes of heating. Subsequently the temperature at the top of the column rises slowly as most of the water is removed, and when the temperature has risen to 110–112° (after 2 hours or so) stop the heating. Transfer the reaction mixture as rapidly as possible (to minimise the hydrolysis of the *n*-butyl borate by moisture in the atmosphere) to a 1-litre Widmer flask (Fig. II, 24, 3: this should have a 25–30 cm. fractionating side arm and be well lagged) and distil under reduced pressure (Fig. II, 20, 1). The unreacted *n*-butyl alcohol passes over first, and the temperature then rises sharply. The receiver is changed, and the *n*-butyl borate is collected at 114–115°/15 mm. (or 103–105°/8 mm.). The yield is 210 g.

COGNATE PREPARATION

***n*-Amyl Borate.** Use 62 g. of A.R. boric acid and 396 g. (490 ml.) of *n*-amyl alcohol. During the first hour the azeotropic mixture, containing approximately 44 per cent. of *n*-amyl alcohol and 56 per cent. of water, passes over at 95°: subsequently the temperature rises slowly to 136–137°. It is unnecessary to return the recovered *n*-amyl alcohol to the reaction mixture. The yield of *n*-amyl borate, b.p. 146–148°/16 mm., is 260 g.

III,52.

n-PROPYL THIOCYANATE

Fit a 1-litre three-necked flask with a mercury-sealed stirrer, a reflux condenser and a 250 ml. separatory funnel. Place 133 g. of A.R. potassium thiocyanate and 310 ml. of rectified spirit in the flask, stir the mixture vigorously and heat to boiling. Run in from the separatory funnel 154 g. (113·5 ml.) of *n*-propyl bromide (Section III,35) during the course of 15–20 minutes; potassium bromide separates. Reflux the mixture, with vigorous stirring, for 5 hours; the stirring must be vigorous otherwise bumping occurs. Filter off the precipitated potassium bromide from the cold reaction mixture (1) and wash it with 75 ml. of rectified spirit. Distil off as much of the alcohol as possible on a water bath through a short column. Treat the residue in the flask with 125 ml. of water, and separate the upper layer of *n*-propyl thiocyanate. Extract the aqueous layer with two 50 ml. portions of ether. Combine the ether extracts with the crude thiocyanate, dry with anhydrous sodium or magnesium sulphate, and remove most of the ether on a water bath. Distil the residue through an efficient fractionating column (e.g., a long all-glass Dufton column, Fig. II, 15, 2; a Hempel column filled with $\frac{1}{8}$ " porcelain rings or with $\frac{1}{4}$ " glass rings, Fig. II, 15, 3; a modified Hempel column, Fig. II, 15, 5); all these columns must be well lagged with asbestos cloth and preferably heated electrically. A little ether, ethyl alcohol and water pass over first (to 110°); the temperature then rises rapidly to

164–165° and the remainder distils constantly at 165°. The yield of *n*-propyl thiocyanate is 93 g.

Note.

(1) The evil-smelling residue in the reaction flask is best removed by the cautious addition of concentrated nitric acid.

COGNATE PREPARATION

***n*-Butyl thiocyanate.** Use 133 g. of A.R. potassium thiocyanate, 310 ml. of rectified spirit and 172 g. (135 ml.) of *n*-butyl bromide. The yield of *n*-butyl thiocyanate, b.p. 183–184°, is 126 g.

III.53.

***n*-AMYL NITRITE**

Equip a 1-litre three-necked flask with a powerful mechanical stirrer, a separatory funnel with stem extending to the bottom of the flask, and a thermometer. Cool the flask in a mixture of ice and salt. Place a solution of 95 g. of A.R. sodium nitrite in 375 ml. of water in the flask and stir. When the temperature has fallen to 0° (or slightly below) introduce slowly from the separatory funnel a mixture of 25 ml. of water, 62.5 g. (34 ml.) of concentrated sulphuric acid and 110 g. (135 ml.) of *n*-amyl alcohol, which has previously been cooled to 0°. The rate of addition must be controlled so that the temperature is maintained at $\pm 1^\circ$; the addition takes 45–60 minutes. Allow the mixture to stand for 1.5 hours and then filter from the precipitated sodium sulphate (1). Separate the upper yellow *n*-amyl nitrite layer, wash it with a solution containing 1 g. of sodium bicarbonate and 12.5 g. of sodium chloride in 50 ml. of water, and dry it with 5–7 g. of anhydrous magnesium sulphate. The resulting crude *n*-amyl nitrite (107 g.) is satisfactory for many purposes (2). Upon distillation, it passes over largely at 104° with negligible decomposition. The b.p. under reduced pressure is 29°/40 mm.

Notes.

(1) Care must be exercised in handling *n*-amyl and the other alkyl nitrites; inhalation of the vapour may cause severe headache and heart excitation. The preparation must therefore be conducted in an efficient fume cupboard.

(2) *n*-Amyl and other alkyl nitrites decompose slowly upon standing and should be kept in a cool place. They must be used within a few days or, at most within two weeks of their preparation. The decomposition products include water, oxides of nitrogen, the alcohol and polymerisation products of the aldehyde.

COGNATE PREPARATION

***n*-Hexyl nitrite.** Use 95 g. of A.R. sodium nitrite in 375 ml. of water; a mixture of 25 ml. of water, 62.5 g. (34 ml.) of concentrated sulphuric acid and 127.5 g. (156 ml.) of *n*-hexyl alcohol. The yield of crude product is 124 g. B.p. 129–130.5° or 52°/44 mm.

***n*-Butyl nitrite.** Use quantities as for *n*-Hexyl nitrite, but with 114.5 g. (141.5 ml.) of *n*-butyl alcohol replacing the *n*-hexyl alcohol. The yield of crude product is 110 g. *n*-Butyl nitrite boils at 76.5–77.5° at atmospheric pressure with slight decomposition, but distils unchanged at 27°/88 mm.

III,54. 1-NITRO-*n*-BUTANE (*AgNO₂* Method)

In a 200 ml. distilling flask place 64 g. (50 ml.) of dry *n*-butyl bromide and 80 g. of dry silver nitrite (1). Insert a reflux condenser, carrying a cotton wool (or calcium chloride) guard tube, into the mouth of the flask and close the side arm with a small stopper. Allow the mixture to stand for 2 hours; heat on a steam bath for 4 hours (some brown fumes are evolved), followed by 8 hours in an oil bath at 110°. Distil the mixture and collect the fraction of b.p. 149–151° as pure 1-nitro-*n*-butane (18 g.). A further small quantity may be obtained by distilling the fractions of low boiling point from a Widmer flask.

Note.

(1) The silver nitrite may be prepared as described in Section II,50, 17. The product supplied by Johnson, Matthey and Co. Ltd., of Hatton Garden, London, E.C. 1, is satisfactory; it should be washed with absolute methyl or ethyl alcohol, followed by sodium-dried ether, and dried in an electrically-heated oven at 100° for 30 minutes (longer heating results in darkening on the surface): the substance should be kept in a vacuum desiccator until required.

COGNATE PREPARATION

1-Nitro-*n*-hexane. Use 41 g. of dry silver nitrite, 51 g. of *n*-hexyl iodide (35.5 ml.) and 100 ml. of sodium dried ether. Reflux on a water bath for 8 hours; decant the ethereal solution and wash the solid well with sodium-dried ether. Distil the residue, after the removal of the ether from the combined extracts, from 5 g. of dry silver nitrite, and collect the fraction of b.p. 190–192° (13 g.) as 1-nitro-*n*-hexane. The pure compound is obtained by distilling under diminished pressure: b.p. 81.5°/15 mm.

III,55.**NITROMETHANE**

To a mixture of 125 g. of chloroacetic acid (Section III,125) and 125 g. of crushed ice contained in a 1-litre distilling flask, add, with stirring or shaking, sufficient 40 per cent. sodium hydroxide solution * to render the solution faintly alkaline to phenolphthalein. About 90 ml. are required; the temperature should not be allowed to rise above 20°, or else sodium glycolate will form. Introduce a solution of 73 g. of pure sodium nitrite in 100 ml. of water into the flask; insert a thermometer dipping well into the liquid. Connect the distilling flask to an efficient (*e.g.*, double surface) condenser set for downward distillation; the receiver should preferably be cooled in ice water. Heat the mixture slowly until the first appearance of bubbles of carbon dioxide; this occurs when the temperature has reached 80–85°. Immediately remove the flame. The reaction (decomposition of the sodium nitroacetate) sets in with liberation of heat and the temperature rises to almost 100° without further application of external heat. If heat is applied after the temperature of the reaction mixture reaches 85°, much frothing will occur and serious loss of nitromethane will result. If the reaction becomes too vigorous, it may be checked somewhat by applying a wet cloth to the flask. During

* Alternatively, effect the neutralisation with about 75 g. of finely-powdered, anhydrous sodium carbonate added in small portions with frequent shaking.

the exothermic reaction about 30 ml. of nitromethane, accompanied by about 40 ml. of water, distil over. When the exothermic reaction apparently ceases (temperature below 90°), heat the mixture gently until the temperature rises to 110°. Transfer the distillate to a separatory funnel, allow to stand for at least 30 minutes to complete the separation of the two layers, and remove the lower layer of nitromethane. Dry it with anhydrous calcium chloride or anhydrous calcium sulphate and distil: 30 g. of nitromethane, b.p. 100–102°, are obtained. A further small quantity (3–4 g.) may be isolated by mixing the aqueous layer with one quarter of its weight of sodium chloride, distilling, and separating the nitromethane from the distillate.

(For a discussion of the *Reactions and Characterisation of Aliphatic Nitro Compounds*, see Section IV,16B.)

ALIPHATIC ETHERS

Diethyl ether may be prepared from ethyl alcohol by the "sulphuric acid process." A mixture of alcohol and sulphuric acid in equimolecular proportions is heated to about 140° and alcohol is run in at the rate at which the ether produced distils from the reaction mixture. Ethyl hydrogen sulphate (or ethyl sulphuric acid) is first formed and this yields ether either by reacting directly with a molecule of alcohol or by the formation and alcoholysis of diethyl sulphate (I) :

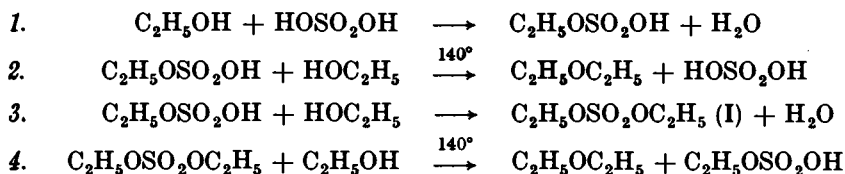

If the temperature is allowed to rise to 170°, much of the ethyl hydrogen sulphate decomposes into ethylene :



The sulphuric acid and ethyl hydrogen sulphate required in reactions 1 and 3 respectively are regenerated in reactions 2 and 4, but the water formed is retained in the acid mixture and ultimately results in such a dilution that the conversion into ether is no longer efficient. Furthermore, some ethylene is always formed ; this partly polymerises to give materials capable of reacting with sulphuric acid and reducing it to sulphur dioxide. In industrial practice, one part of sulphuric acid is sufficient for the production of about 200 parts of ether.

The above simple process cannot be applied to the preparation of the homologues ; a higher temperature is required (di-*n*-amyl ether, for example, boils at 169°) and, under these conditions, alkene formation predominates, leading ultimately to carbonisation and the production of sulphur dioxide. If, however, the water is largely removed by means of a special device (see Fig. III, 57, 1) as soon as it is formed, good yields of ethers may be obtained from primary alcohols, for example :

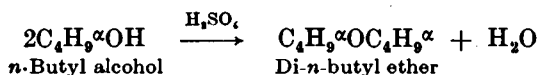

Mixed ethers may be prepared by the interaction of an alkyl halide and a sodium alkoxide (Williamson's synthesis), for example :

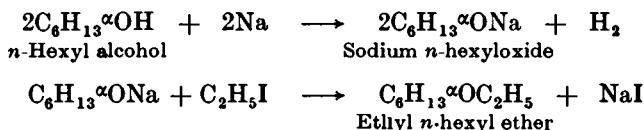

Higher alcohols (> C₃) react comparatively slowly with sodium because of the slight solubility of the sodium alkoxide in the alcohol ; a large excess (say, 8 mols) is therefore employed. The mixed ether is distilled off, and the process (formation of alkoxide and its reaction with the alkyl halide) may be repeated several times. The excess of alcohol can be recovered.

*cyclo*Aliphatic alcohols form sodio compounds with difficulty if small pieces

of sodium are employed ; the best results are given by " molecular " (granulated) sodium (Section II,50,6), for example :

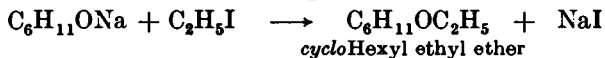

The preparation of anhydrous diethyl ether (suitable for Grignard reactions, etc.) is described in Section II,47,1. The precautions required in handling ether are given in Section II,14.

III,56.

DIETHYL ETHER *

Assemble the apparatus shown in Fig. III, 56, 1. Fit the 500 ml. distilling flask with a two-holed cork carrying a thermometer reaching to

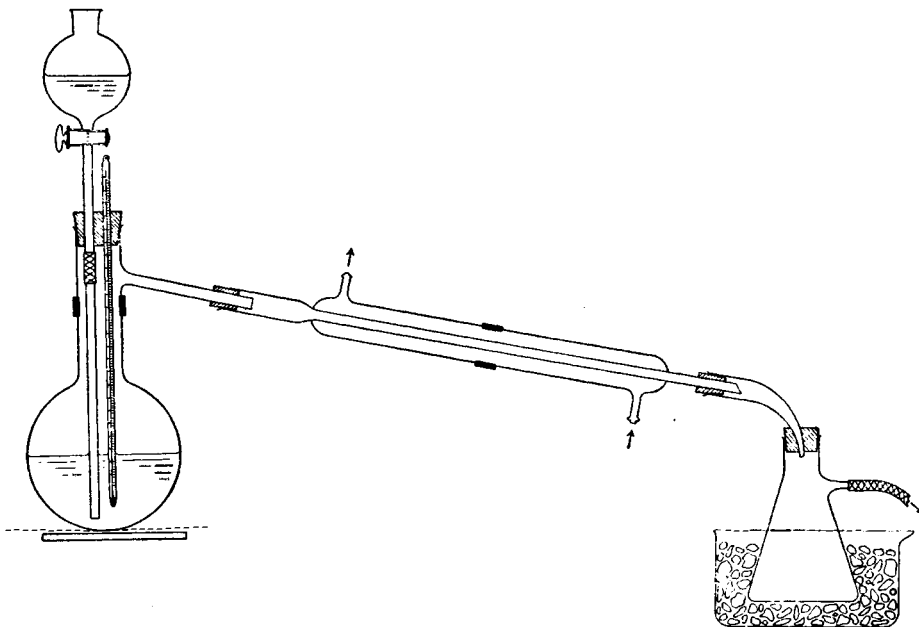

Fig. III, 56, 1.

within 1 cm. of the bottom of the flask and a dropping funnel. Extend the stem of the dropping funnel by means of glass tubing of the same size as the stem of the funnel ; make the connection (" glass to glass ") with rubber " pressure " tubing *above* the side arm of the flask. Pass the side arm of the distilling flask through a cork in the upper end of a long Liebig or preferably a double surface condenser ; the lower end of the latter passes through an adapter into a filter flask cooled in crushed ice or ice water. Attach to the filter flask a length of rubber tubing leading below the level of the bench, so that any ether escaping condensation cannot return to the vicinity of the flame. Make sure that the stopcock of the separatory funnel is well greased and that all joints fit well.

* The preparation of diethyl ether is described here for the sake of completeness. It is an unsuitable exercise for beginners. Di-*n*-butyl ether (Section III,57) offers an excellent alternative.

Pour 75 ml. of rectified spirit into the flask and add cautiously, with frequent shaking to ensure thorough mixing, 75 ml. of concentrated sulphuric acid. Reassemble the apparatus and see that the extension of the dropping funnel and the thermometer are below the surface of the liquid. Place 150 ml. of rectified spirit in the dropping funnel. Heat the flask on a wire gauze until the thermometer records a temperature of 140°, and run in the alcohol at approximately the same rate as the liquid distils. The temperature must be kept constant between 140° and 150° throughout the addition of alcohol. When all the alcohol has been introduced into the flask (about 90 minutes), continue the heating and maintain the temperature at 140–145° for a few minutes, and then extinguish the flame beneath the flask. Transfer the distillate, composed of ether mixed with a little alcohol, water and sulphurous acid, to a separatory funnel; shake it with 30 ml. of 5 per cent. sodium hydroxide solution, allow the mixture to settle and draw off the alkali solution (lower layer). Repeat the process of shaking and drawing off the lower layer first with 25 ml. of water, and then with 30 ml. of 50 per cent. calcium chloride solution (to remove most of the alcohol). Pour the ether from the mouth of the funnel to a dry conical flask containing 10–15 g. of anhydrous calcium chloride (this will remove both the water and the residual alcohol) allow the ether to stand, with occasional shaking, in the stoppered flask for at least 30 minutes but preferably for several hours. Filter the ether through a fluted filter paper (Section II,29) directly into a 150 ml. distilling flask containing a few fragments of porous porcelain, and arrange the remainder of the apparatus exactly as in Fig. III, 56, 1 except that the dropping funnel is omitted and the thermometer bulb is just below the level of the side arm. Heat the flask in a large beaker of water; the water should have previously been heated to 50–60° at some distance from the apparatus. Arrange the depth of the flask in the water bath so that the ether distils slowly. Collect the fraction boiling between 33° and 38°. The yield is 60–65 g. Pure ether boils at 34°.

Note.

The student should read Section II,14 on the precautions attending the use of inflammable solvents before commencing the above preparation.

III,57.

DI-*n*-BUTYL ETHER

The success of this preparation depends upon the use of the apparatus (1) depicted in Fig. III, 57, 1, which permits of the automatic separation of the water produced in the reaction; this will be termed a water-separator tube. Convenient dimensions for students' preparations are indicated in the diagram. Determine the volume v of the tube up to the neck, *i.e.*, between *A* and *B*, by adding water from a burette. The quantity of water which should be eliminated, assuming a quantitative conversion of the alcohol into the ether, may be computed from the equation:

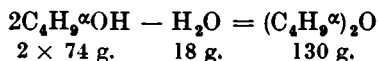

Thus 50 g. of *n*-butyl alcohol should yield $50 \times 18/148 = 6.1$ g. of water.

Assemble the apparatus illustrated in Fig. III, 57, 2. *D* is a 200 ml. Pyrex bolt-head flask carrying the water-separator tube *C* and a thermometer, the bulb of which is about 1 cm. from the bottom of the flask: *E* is a small Liebig condenser. Place ($v = 6.1$ ml.) of water in the tube *AB* and 50 g. (62 ml.) of *n*-butyl alcohol together with 16 g. (9 ml.) of concentrated sulphuric acid in the flask *D*. Heat the flask gently on a wire gauze so that the liquid refluxes and is condensed by the condenser *E*. Water and *n*-butyl alcohol will first collect in *C*, and when the combined volumes exceed v ml., automatic separation of the two liquids will commence; the water will fall to the bottom of the tube *AB* and the lighter *n*-butyl alcohol will pass back into the flask. Continue the heating until the temperature inside the flask rises to 134–135° (after 30–40 minutes) and there is a smell of an unsaturated hydrocarbon (butylene) at the top of the condenser. At this stage 5–6 ml. of water will have collected in *AB* and the reaction

may be regarded as complete. Further heating will merely result in considerable darkening of the mixture in the flask and the formation of the highly inflammable butylene. Allow the reaction mixture to cool or cool the flask under running water from the tap (2). Pour the contents of the flask and water-separator tube into a separatory funnel containing 100 ml. of water, shake well, and remove the upper layer containing the crude ether mixed with a little unchanged *n*-butyl alcohol. Shake the crude ether with 25 ml. of cold 50 per cent. sulphuric acid by weight (from 20 ml. of concentrated acid and 35 ml. of water) (3) for 2–3 minutes, separate the upper layer and repeat the extraction with another 25 ml. of the acid. Finally, wash twice with 25 ml. portions of water, dry with 2 g. of anhydrous calcium chloride. Filter through a fluted filter paper or a small cotton wool plug (supported in a small funnel) into a 50 ml. distilling flask, and distil. Collect the *n*-butyl ether at 139–142°. The yield is 15 g.

Notes.

(1) This is essentially a "Dean and Stark" tube (employed for determinations of moisture) but uncalibrated; the capacity of this receiver is 7.5–10 ml. A tube calibrated in 0.1 ml. may, of course, be employed, but for large classes the cheaper uncalibrated tube possesses obvious advantages.

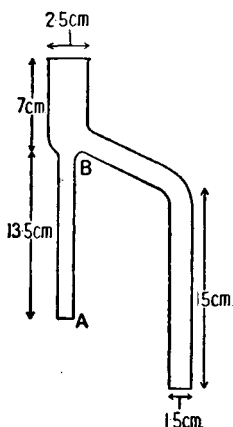

Fig. III, 57, 1.

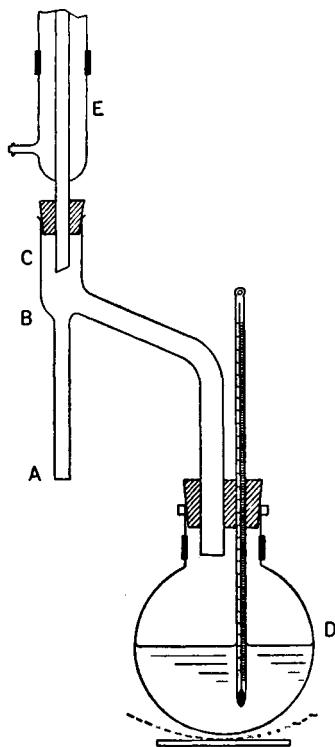

Fig. III, 57, 2.

(2) An alternative method for isolating the *n*-butyl ether utilises the fact that *n*-butyl alcohol is soluble in saturated calcium chloride solution whilst *n*-butyl ether is slightly soluble. Cool the reaction mixture in ice and transfer to a separatory funnel. Wash cautiously with 100 ml. of 2.5–3*N* sodium hydroxide solution; the washings should be alkaline to litmus. Then wash with 30 ml. of water, followed by 30 ml. of saturated calcium chloride solution. Dry with 2–3 g. of anhydrous calcium chloride, filter and distil. Collect the di-*n*-butyl ether at 139–142°. The yield is 20 g.

(3) This separation utilises the fact that *n*-butyl alcohol is soluble in 50 per cent. sulphuric acid by weight, whilst *n*-butyl ether is only slightly soluble.

COGNATE PREPARATIONS

Di-*n*-amyl ether. Use 50 g. (61.5 ml.) of *n*-amyl alcohol (b.p. 136–137°) and 7 g. (4 ml.) of concentrated sulphuric acid. The calculated volume of water (5 ml.) is collected when the temperature inside the flask rises to 157° (after 90 minutes). Steam distil the reaction mixture, separate the upper layer of the distillate and dry it with anhydrous potassium carbonate. Distil from a 50 ml. Claisen flask and collect the fractions of boiling point (i) 145–175° (13 g.), (ii) 175–185° (8 g.) and (iii) 185–190° (largely 185–185.5°) (13 g.). Combine fractions (i) and (ii), reflux for 1 hour in a small flask with 3 g. of sodium, and distil from the sodium amyloxide and excess of sodium; this yields 9.5 g. of fairly pure *n*-amyl ether (iv). The total yield is therefore 22.5 g. A perfectly pure product, b.p. 184–185°, is obtained by further distillation from a little sodium.

Di-*iso*-amyl ether. Use 50 g. (62 ml.) of *iso*-amyl alcohol ("fermentation" alcohol, b.p. 131°). The calculated volume of water (5 ml.) is collected when the temperature inside the flask rises to 148–150° (after 90 minutes). Proceed as for *n*-Amyl ether and collect the fractions of b.p. 135–150° (14 g.), 150–168° (10 g.) and 168–174° (10 g.). After distillation over sodium the yield of *iso*-amyl ether, b.p. 170–171.5°, is 24 g.

Di-*n*-hexyl ether. Use 50 g. (61 ml.) of *n*-hexyl alcohol (b.p. 156–157°) and 6 g. (3.5 ml.) of concentrated sulphuric acid, and heat until the temperature rises to 180°. Pour the reaction mixture into water, separate the upper layer, wash it twice with 5 per cent. sodium hydroxide solution, then with water, and dry over anhydrous potassium carbonate. Distil from a 50 ml. Claisen flask, and collect the fractions of b.p. (i) 160–221° (17 g.), and (ii) 221–223° (17 g.). Reflux fraction (i) with 4 g. of sodium and distil from the excess of sodium: 9.5 g. of fairly pure *n*-hexyl ether, fraction (iii), are thus obtained. Combine fractions (ii) and (iii) and distil from a little sodium; collect the pure *n*-hexyl ether (19 g.) at 221.5–223°.

III, 58.

ETHYL *n*-HEXYL ETHER

Place 204 g. (249.5 ml.) (2 gram mols) of dry *n*-hexyl alcohol in a 350 ml. Claisen flask with fractionating side arm. Introduce 5.75 g. (0.25 gram atoms) of clean sodium in small pieces and warm under reflux (as in Fig. III, 58, 1 but with dropping funnel omitted*) until all the sodium has reacted (*ca.* 2 hours). Introduce 39 g. (20 ml.) (0.25 gram

* Close the side arm of the flask with a small cork during the refluxing period.

mols) of ethyl iodide from the dropping funnel and reflux gently for 2 hours; sodium iodide gradually separates. Rearrange the apparatus for distillation and collect the crude ether at 143–148° (27 g.). When cold, fit up the apparatus as in Fig. III, 58, 1, add a further 5.75 g. (0.25 gram atoms) of clean sodium and warm until all has reacted: alternatively, allow the reaction to proceed overnight, by which time all the sodium will have reacted. Introduce a further 39 g. (0.25 gram atoms) of ethyl iodide and reflux for 2 hours; distil off the crude ether and collect the fraction passing over at 143–148°. Combine the two distillates. Remove most of the *n*-hexyl alcohol still present in the crude ether by heating under reflux for 2 hours with a large excess of sodium: fit a bent tube (to act as a still head) to the flask and distil until no more liquid passes over. Distil the resulting liquid from a few grams of sodium contained in a Claisen flask with fractionating side arm and collect the ethyl *n*-hexyl ether at 140–143°. The yield is 30 g. If the sodium is appreciably attacked, indicating that all the alcohol has not been completely removed, repeat the distillation from a little fresh sodium.

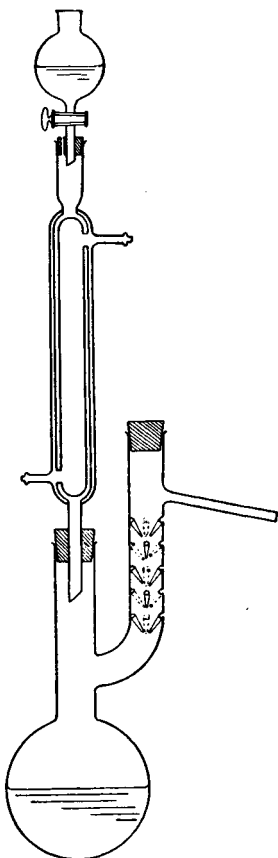

Fig. III, 58, 1.

COGNATE PREPARATIONS

Methyl *n*-hexyl ether. Use 204 g. (249.5 ml.) of *n*-hexyl alcohol, 2 × 5.75 g. of clean sodium, and 2 × 35.5 g. (2 × 15.5 ml.) of methyl iodide. The yield of methyl *n*-hexyl ether, b.p. 125–126° is 42 g.

Methyl *n*-butyl ether. Use 148 g. (183 ml.) of *n*-butyl alcohol, 2 × 5.75 g. of clean sodium, and 2 × 35.5 g. (2 × 15.5 ml.) of methyl iodide. The yield of methyl *n*-butyl ether, b.p. 70–71°, is 31 g.

III,59. **cyclo**HEXYL ETHYL ETHER

Prepare 15.5 g. of “molecular” sodium (granulated sodium) under xylene (Section II,50,6) and replace the xylene completely by 100 ml. of sodium-dried ether. Attach a double surface condenser to the flask and introduce slowly, with frequent shaking, a solution of 66 g. of pure *cyclohexanol* in 50 ml. of anhydrous ether. Allow the reaction mixture to stand overnight to complete the formation of the sodio compound. Add 108 g. (56 ml.) of ethyl iodide: shake the mixture when the ether will boil gently. Allow the reaction to proceed for 12–18 hours: a blue solid separates. Fit a bent tube (to act as a still head) and a condenser to the flask, and distil off the diethyl ether on a water bath; then replace the water bath by an air bath (Fig. II, 5, 3) and distil as long as liquid passes over. Reflux the distillate (containing some unchanged *cyclohexanol*) with a large excess of sodium and distil again.

Finally distil from a well-lagged Widmer flask (compare Figs. II, 24, 2-5) over a little sodium. Collect the *cyclo*-hexyl ethyl ether at 148-150°. The yield is 21 g. If the sodium is appreciably attacked, repeat the distillation from a fresh quantity of sodium.

III,60. REACTIONS AND CHARACTERISATION OF ALIPHATIC ETHERS

Chemically, the ethers are inert compounds. The important reactions are :—

(i) After being dried with anhydrous calcium chloride, they do not react with sodium (compare alcohols and esters).

(ii) They are not attacked by dilute acid or by alkali (compare esters).

(iii) They generally dissolve in concentrated sulphuric acid to give clear solutions, and are precipitated upon dilution with water. This test is carried out by adding 1 ml. of concentrated sulphuric acid to 1 ml. of the ether cooled in ice : observe whether the solution is clear and if a discolouration occurs. Add the solution to ice water ; the original ether should be precipitated and no sulphur dioxide should be apparent.

CAUTION. Ethers that have been stored for long periods, particularly in partly-filled bottles, frequently contain small quantities of highly explosive peroxides. The presence of peroxides may be detected either by the "perchromic acid" test of qualitative inorganic analysis (addition of an acidified solution of potassium dichromate) or by the liberation of iodine from acidified potassium iodide solution (compare Section II,47,1). The peroxides are non-volatile and may accumulate in the flask during the distillation of the ether ; the residue is explosive and may detonate, when distilled, with sufficient violence to shatter the apparatus and cause serious personal injury. If peroxides are found, they must first be removed by treatment with acidified ferrous sulphate solution (Section II,47,1) or with sodium sulphite solution or with stannous chloride solution (Section VI,12). The common extraction solvents diethyl ether and di-*iso*-propyl ether are particularly prone to the formation of peroxides.

CHARACTERISATION OF ALIPHATIC ETHERS

The low reactivity of aliphatic ethers renders the problem of the preparation of suitable crystalline derivatives a somewhat difficult one. Increased importance is therefore attached to the physical properties (boiling point, density and refractive index) as a means for providing preliminary information. There are, however, two reactions based upon the cleavage of the ethers which are useful for characterisation.

1. **Reaction with 3 : 5-dinitrobenzoyl chloride.** Ethers undergo cleavage with 3 : 5-dinitrobenzoyl chloride in the presence of zinc chloride :

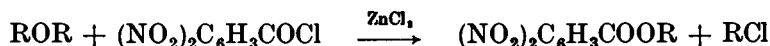

The resulting alkyl 3 : 5-dinitrobenzoate may be employed for the characterisation of the ether. The method is only applicable to symmetrical or simple ethers ; a mixed aliphatic ether ROR' would yield a mixture of inseparable solid esters.

Add 1 ml. of the alcohol-free ether to 0.1–0.15 g. of finely-powdered anhydrous zinc chloride and 0.5 g. of pure 3 : 5-dinitrobenzoyl chloride (Section III,27,1) contained in a test-tube ; attach a small water condenser and reflux gently for 1 hour. Treat the reaction product with 10 ml. of 1.5*N* sodium carbonate solution, heat and stir the mixture for 1 minute upon a boiling water bath, allow to cool, and filter at the pump. Wash the precipitate with 5 ml. of 1.5*N* sodium carbonate solution and twice with 5 ml. of ether. Dry on a porous tile or upon a pad of filter paper. Transfer the crude ester to a test-tube and boil it with 10 ml. of chloroform or carbon tetrachloride ; filter the hot solution, if necessary. If the ester does not separate on cooling, evaporate to dryness on a water bath, and recrystallise the residue from 2–3 ml. of either of the above solvents. Determine the melting point of the resulting 3 : 5-dinitrobenzoate (Section III,27).

2. **Cleavage of ethers with hydriodic acid.** Aliphatic ethers suffer fission when boiled with constant boiling point hydriodic acid :

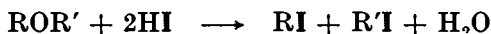

If the ether is a simple one ($\text{R} = \text{R}'$), the identification of the resulting alkyl iodide presents no difficulties. If, however, it is a mixed aliphatic ether, the separation of the two alkyl iodides by fractional distillation is generally difficult unless R and R' differ considerably in molecular weight and sufficient material is available.

Reflux 1 ml. of the ether with 5 ml. of freshly distilled, constant boiling point hydriodic acid (Section II,49,2), b.p. 126–128°, for 2–3 hours. Add 10 ml. of water, distil and collect about 7 ml. of liquid. Decolourise the distillate by the addition of a little sodium bisulphite, and separate the two layers by means of a dropper pipette (Fig. II,27,1). Determine the b.p. of the resulting iodide by the Siwoloboff method (Section II,12) and prepare a crystalline derivative (Section III,42).

The physical properties of a number of aliphatic ethers are collected in Table III,60. Some related heterocyclic compounds are included in the Table.

TABLE III,60.

ALIPHATIC ETHERS

Ether	B.P.	d_{4}^{20}	n_D^{20}
Chloromethyl methyl	59°	1.070	1.397
Diethyl	34	0.714	1.353
Chloromethyl ethyl	83 (d)	1.026	1.404
α -Chloroethyl methyl	73	0.991	1.400
β -Chloroethyl methyl	91	1.035	1.411
$\alpha\alpha'$ -Dichlorodiethyl	114	1.111	1.423
$\beta\beta'$ -Dichlorodiethyl	178	1.210	1.457
Di- <i>n</i> -propyl	90	0.749	1.381
Di- <i>iso</i> -propyl	68	0.726	1.368
Di- <i>n</i> -butyl	141	0.770	1.399
Di- <i>n</i> -amyl	185	0.785	1.412
Di- <i>iso</i> -amyl	171	0.778	1.409
Di- <i>n</i> -hexyl	223	0.793	1.420
Di- <i>n</i> -heptyl	259	0.801	1.427
Di- <i>n</i> -octyl	288	0.806	1.433
Di- <i>n</i> -decyl	185°/5 mm.	0.815	1.441
Methyl <i>n</i> -butyl	70	0.774	1.374
Ethyl <i>n</i> -butyl	92	0.749	1.382
Methyl <i>n</i> -amyl	99	0.761	1.387
Ethyl <i>n</i> -amyl	118	0.762	1.393
Methyl <i>n</i> -hexyl	126	0.772	1.397
Ethyl <i>n</i> -hexyl	142	0.772	1.401
<i>cyclo</i> Pentyl methyl	105	0.862	1.420
<i>cyclo</i> Pentyl ethyl	122	0.853	1.423
<i>cyclo</i> Hexyl methyl	134	0.875	1.435
<i>cyclo</i> Hexyl ethyl	149	0.864	1.435
Epichlorohydrin	117	1.181	1.438
Cineole	176	0.923	1.458
Ethyleneglycol dimethyl	83	0.866	1.379
Ethyleneglycol diethyl	123	0.848	—
Diethyleneglycol diethyl	187	0.906	1.411
Tetraethyleneglycol dimethyl	266	1.009	1.432
Benzyl methyl	171	0.965	1.501
Benzyl ethyl	186	0.948	1.496
Dibenzyl	299 (d)	1.042	—
Furan	32	0.937	1.422
Tetrahydrofuran	65	0.889	1.407
Sylvan (2-methylfuran)	64	0.913	1.434
Tetrahydro-sylvan	79	0.855	1.407
Dihydropyran	86	0.923	1.440
Tetrahydropyran	88	0.881	1.421
Dioxan	102	1.034	1.417

ALIPHATIC ALDEHYDES

Aliphatic aldehydes may be prepared:—

1. By the controlled oxidation of primary alcohols with a solution of potassium or sodium dichromate in dilute sulphuric acid. To avoid the further oxidation to the corresponding acid, the aldehyde is removed as rapidly as possible by distillation through a fractionating column, for example :

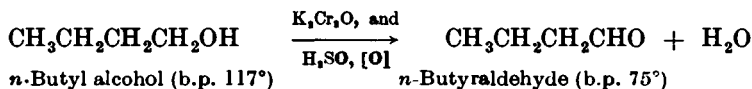

With higher alcohols appreciable quantities of esters (compare Section III,82) may be formed.

2. By passing the alcohol vapour over a "copper - chromium oxide" catalyst deposited on pumice and heated to 330° , for example :

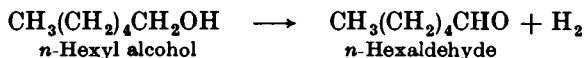

Small quantities of esters (in the above example *n*-hexyl *n*-caproate $\text{CH}_3(\text{CH}_2)_4\text{COO}(\text{CH}_2)_5\text{CH}_3$) are simultaneously formed. This is an excellent method for the preparation of aldehydes.

It is interesting to note that under the influence of aluminium alkoxides (in alcohol or, better, in benzene solution) aldehydes produce the ester (Tischenko reaction) :

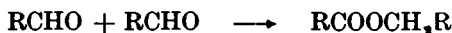

3. From ethyl orthoformate and the Grignard reagent, for example :

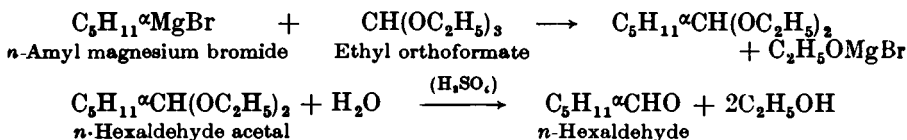

4. From nitriles by treatment with anhydrous stannous chloride dissolved in ether saturated with hydrogen chloride; the resulting crystalline aldimine stannichloride, $[(\text{RCH}=\text{NH}_2)_2]\text{SnCl}_4$ or $(\text{RCH}=\text{NH},\text{HCl})_2\text{SnCl}_4$, is hydrolysed by warm water, and the aldehyde is isolated by distillation with steam or by extraction with a solvent (Stephen reaction), for example, for $\text{R} = \text{CH}_3(\text{CH}_2)_4$, *i.e.*, *n*-amyl :

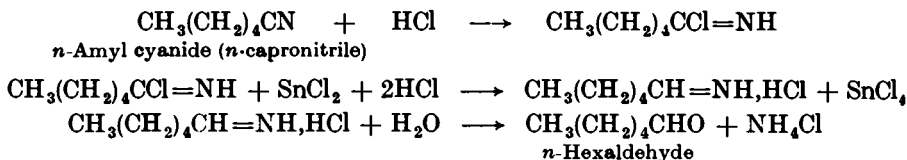

Formaldehyde is a gas, b.p. -21° , and is usually prepared by the dehydrogenation of methyl alcohol in the presence of heated copper or silver. By admitting air with the methyl alcohol vapour, part of the hydrogen is oxidised to give the heat necessary for the reaction :

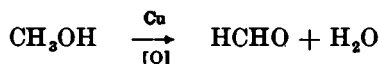

It is marketed as a 35–40 per cent. solution in water (formalin). The reactions of formaldehyde are partly typical of aldehydes and partly peculiar to itself. By evaporating an aqueous solution paraformaldehyde or *paraform* $(\text{CH}_2\text{O})_x$, an amorphous white solid is produced; it is insoluble in most solvents. When formaldehyde is distilled from a 60 per cent. solution containing 2 per cent. of sulphuric acid, it polymerises to a crystalline trimeride, trioxane, which can be extracted with methylene chloride; this is crystalline (m.p. 62° , b.p. 115°), readily soluble in water, alcohol and ether, and devoid of aldehydic properties:

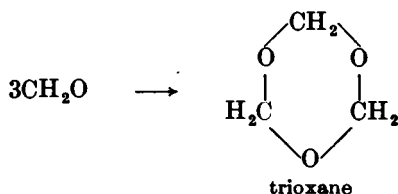

Upon heating the polymers, anhydrous gaseous formaldehyde is produced (compare Section III,17). By allowing a mixture of concentrated ammonia solution and formalin to evaporate, hexamethylenetetramine (also called *hexamine*, *urotropine*) $\text{C}_6\text{H}_{12}\text{N}_4$ is formed:

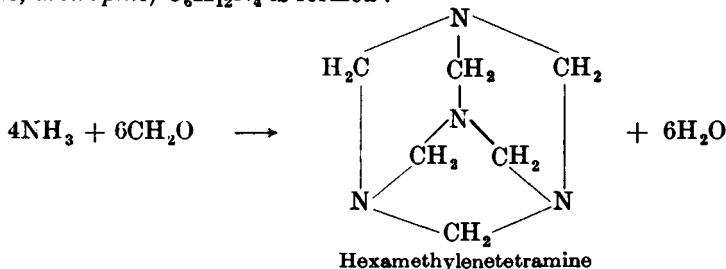

Much of the acetaldehyde of commerce is obtained by the hydration of acetylene in hot dilute sulphuric acid solution in the presence of mercuric sulphate as catalyst:

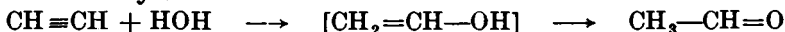

Acetaldehyde, b.p. 21° , undergoes rapid polymerisation under the influence of a little sulphuric acid as catalyst to give the trimeride paraldehyde, a liquid b.p. 124° , which is sparingly soluble in water. The reaction is reversible, but attains equilibrium when the conversion is about 95 per cent. complete; the unreacted acetaldehyde and the acid catalyst may be removed by washing with water:

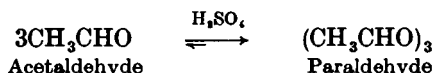

Paraldehyde is inert to oxidising agents and exhibits none of the reactions of carbonyl compounds (compare Section III,74); its constitution is similar to that of trioxane, with CH_3CH replacing HCH . In view of the low boiling point of acetaldehyde (21°) its preparation (and storage) is not conveniently carried out directly from ethyl alcohol or acetylene. When acetaldehyde is required in the laboratory, paraldehyde can be readily depolymerised by adding a trace of sulphuric acid, which immediately gives the equilibrium mixture, and fractionating this to remove the acetaldehyde from the sphere of reaction: eventually all the paraldehyde is depolymerised. Another polymeride, metaldehyde $(\text{CH}_3\text{CHO})_4$, a crystalline solid, is obtained by the action of hydrogen chloride below 0° , best in ethereal solution.

Aldehydes condense with alcohols in the presence of a catalyst (1–2.5 per

cent of an acid such as sulphuric, hydrochloric or *p*-toluene-sulphonic acid, or of calcium chloride) to yield acetals, for example :

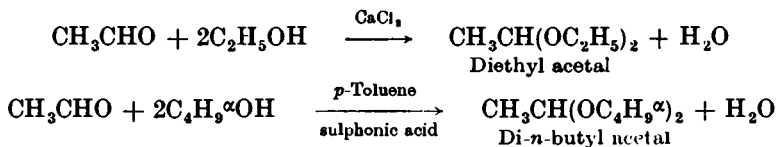

III,61.

n-BUTYRALDEHYDE

Fit up the apparatus shown in Fig. III, 61, 1. The bolt-head flask is of 500 ml. capacity and the Hempel column is filled with $\frac{1}{4}$ " glass rings

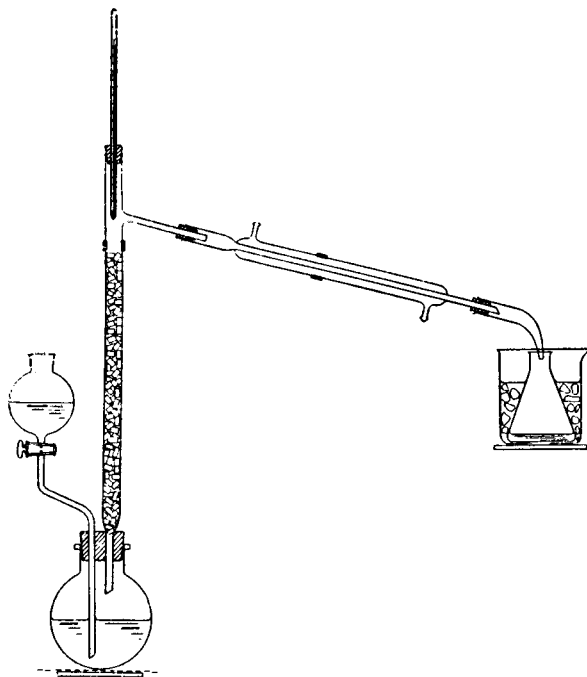

Fig. III, 61, 1.

or with $\frac{1}{8}$ " porcelain rings (1) ; the receiver is cooled in crushed ice or in cold water. Dissolve 56 g. of sodium dichromate dihydrate in 300 ml. of water and add cautiously, with stirring, 40 ml. of concentrated sulphuric acid. Place 41 g. (51 ml.) of *n*-butyl alcohol together with a few small chips of porous porcelain in the flask, and the acidified dichromate solution in the separatory funnel. Heat the *n*-butyl alcohol to boiling so that the vapours reach the lowest rings in the fractionating column. Run in the dichromate solution during about 15 minutes and at such a rate that the temperature at the top of the column does not rise above 80–85°. The oxidation to *n*-butyraldehyde proceeds with the evolution of heat, but it may be necessary to heat the mixture with a *small* flame from time to time in order to prevent the temperature from falling below 75°. When all the oxidising agent has been added, continue heating the mixture

with a small flame for 15 minutes and collect all that passes over below 90°. Separate the small volume of water (*ca.* 2 ml.) from the distillate and dry the residue (29 g.) for 30–60 minutes with 3–4 g. of anhydrous magnesium sulphate. Meanwhile detach the fractionating column from the apparatus and dry the glass or porcelain rings by washing with acetone and blowing hot air through them. Fit the column into a 100 ml. bolt head flask and arrange for distillation as before. Distil the dried distillate slowly (1–2 drops per second) through the column and collect as *n*-butyraldehyde all that distils below 76°. The yield is 13 g. Pure *n*-butyraldehyde boils at 74·5°.

Note.

(1) The approximate dimensions of the packing are 25 cm. × 18–20 mm. Any other form of efficient fractionating column may be used.

COGNATE PREPARATION

Propionaldehyde. Use 34 g. (42·5 ml.) of *n*-propyl alcohol, and a solution containing 56 g. of sodium dichromate dihydrate, 300 ml. of water and 40 ml. of concentrated sulphuric acid. The experimental details are identical with those for *n*-butyraldehyde, except that the addition of the dichromate solution occupies 20 minutes, the temperature at the top of the column is not allowed to rise above 70–75°, and during the subsequent heating for 15 minutes the liquid passing over below 80° is collected; the receiver must be cooled in ice. The yield of propionaldehyde, b.p. 47–50°, is 12 g.

III,62. *n*-HEXALDEHYDE (*Catalyst Method*)

Preparation of catalyst (“copper-chromium oxide”). Dissolve 10·4 g. of A.R. barium nitrate in 280 ml. of water at about 80° and add to this hot solution 87 g. of A.R. cupric nitrate {Cu(NO₃)₂·3H₂O}; stir the mixture and heat until a homogeneous solution results. Prepare a solution of 50·4 g. of A.R. ammonium dichromate in a mixture of 200 ml. of water and 75 ml. of concentrated ammonia solution (sp. gr. 0·88). To the ammonium chromate solution at 25–30° add the hot (80°) nitrate solution in a thin stream with stirring. Allow the mixture to cool and filter off the yellowish-brown precipitate with suction; press with a glass stopper and suck as dry as possible. Transfer the precipitate of copper barium ammonium chromate to a large evaporating dish, add sufficient water to form a moderately thick paste, and introduce pumice (4–8 mesh) with stirring until most of the paste has been transferred to the pumice: about 300 g. of pumice are required. Heat on an electric hot plate until the particles of pumice no longer adhere one to another. Remove some of the impregnated pumice (yellowish-brown) to a small evaporating dish and heat, by means of a Bunsen flame, with stirring until the colour changes through brown to a uniform black. The catalyst is now ready for use; it is essentially barium-promoted copper-chromium oxide, together with a little cupric oxide, and will be termed the “copper-chromium oxide” catalyst * deposited upon pumice.

* It differs from the “copper-chromium oxide” catalyst described in Section VI,6 in that it has not been extracted with 10 per cent. acetic acid—a process which presumably removes some copper oxide.

Pack the catalyst into a Pyrex combustion tube about 90 cm. long and 15 mm. bore, and place plugs of glass wool at 25 cm. intervals; insert into a tube furnace and adjust to a temperature of 330°: full details of the complete apparatus are given in Section III, 72 and Fig. III, 72, 1.

Dehydrogenation of *n*-hexyl alcohol. Place 100 g. (122 ml.) of *n*-hexyl alcohol in the dropping funnel (Fig. III, 72, 1). Switch on the current for the furnace and, after 2 hours, allow the alcohol to pass into the tube at the rate of 1 drop every 3–4 seconds. The commencement of the dehydrogenation will be indicated by the production of white fumes at the point where the combustion tube enters the condenser and by the passage of gas (hydrogen) in the “bubbler” at the extreme end of the apparatus. Place 0.1 g. of hydroquinone in the receiver to act as a “stabiliser” for the aldehyde. When all the *n*-hexyl alcohol has passed through the catalyst tube, remove the aqueous layer from the distillate, dry the organic layer with a little anhydrous magnesium sulphate, and distil from a lagged Claisen flask with fractionating side arm (Figs. II, 24, 2–5). Collect the fraction which passes over at 125–135° (30 g.) (1). Upon redistillation, 21 g. of *n*-hexaldehyde (2), b.p. 127–129°, are obtained.

Notes.

(1) If the high boiling residue is transferred to a small Claisen flask and distilled, some *n*-hexyl alcohol passes over first, followed by *n*-hexyl *n*-caproate (2 g.) at 240–250° (mainly 245°).

(2) About 0.1 per cent. of hydroquinone should be added as a “stabiliser” since *n*-hexaldehyde exhibits a great tendency to polymerise. To obtain *perfectly pure n-hexaldehyde*, treat the 21 g. of the product with a solution of 42 g. of sodium bisulphite in 125 ml. of water and shake; much bisulphite derivative will separate. Steam distil the suspension of the bisulphite compound until about 50 ml. of distillate have been collected; this will remove any non-aldehydic impurities together with a little aldehyde. Cool the residual aldehyde-bisulphite solution to 40–50°, and add slowly a solution of 32 g. of sodium bicarbonate in 80 ml. of water, and remove the free aldehyde by steam distillation. Separate the upper layer of *n*-hexaldehyde, wash it with a little water, dry with anhydrous magnesium sulphate and distil; the pure aldehyde passes over at 128–128.5°.

COGNATE PREPARATIONS

***n*-Valeraldehyde.** Use 100 g. (123 ml.) of *n*-amyl alcohol, and fractionate the dried distillate. Collect the fraction of b.p. 98–110° (23 g.); upon redistillation, 20 g. of *n*-valeraldehyde, b.p. 101–105°, are obtained. From the high boiling point fractions 25 g. of *n*-amyl alcohol (b.p. 135–139°) may be recovered, together with 1.5 g. of *n*-amyl *n*-valerate (b.p. 205–210°).

***n*-Butyraldehyde.** Use 100 g. (123.5 ml.) of *n*-butyl alcohol. The yield of *n*-butyraldehyde, b.p. 70–75°, is 38 g., and of *n*-butyl *n*-butyrate, b.p. 165–170°, is 2 g.; 40 g. of *n*-butyl alcohol are recovered.

Propionaldehyde. Use 100 g. (124.5 ml.) of *n*-propyl alcohol and surround the receiver by a freezing mixture. The yield of propionaldehyde, b.p. 48–49.5° (mainly 49°), is 35 g., and of *n*-propyl propionate, b.p. 120–125°, is 1 g.; 30 g. of *n*-propyl alcohol are recovered.

III.63. *n*-HEXALDEHYDE (*Ethyl Orthoformate Method*)

The ethyl orthoformate required in this preparation may be prepared by the action of sodium upon a mixture of chloroform and dry alcohol :

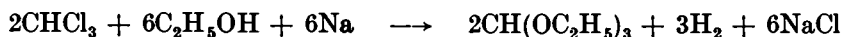

Preparation of ethyl orthoformate. Fit a 1500 ml. round-bottomed flask with a long (60–80 cm.) reflux condenser. Make sure that the apparatus is thoroughly dry. Place 750 ml. of “super-dry” ethyl alcohol (Section II,47,4) and 123 g. (82 ml.) of dry chloroform in the flask. Add 52 g. of clean sodium, cut into small pieces, through the condenser in the course of 30 minutes; when the reaction becomes vigorous, cool the outside of the flask by running water from the condenser outlet. When all the sodium has reacted and the mixture has attained room temperature, filter off the sodium chloride through a sintered glass funnel. The filtration apparatus must be thoroughly dry, and a drying tube, filled with cotton wool, should be placed between the filter flask and the pump. Wash the solid on the filter with 50 ml. of absolute alcohol and allow the washings to run into the main filtrate. Distil the solution from a water bath through an efficient fractionating column in order to recover the excess of chloroform and most of the alcohol; collect the distillate (about 500 g.) (*A*) in a filter flask protected by a drying tube. Decant the liquid remaining in the flask from a little salt which has separated, and distil it either from a Claisen flask with fractionating side arm or through an all-glass Dufton (or Widmer) column. A fraction (*B*) of low boiling point passes over first, followed by the triethyl orthoformate (triethoxymethane) at 144–146°. The yield is 35 g., but depends somewhat upon the efficiency of the fractionation.

Carry out a second run with the recovered chloroform-alcohol mixture (*A*): add 100 g. of dry chloroform and sufficient “super-dry” ethyl alcohol (200–250 ml.) to give a total volume of 750 ml. Add 52 g. of sodium as before. Remove the excess of chloroform and alcohol as before on a water bath through a fractionating column, add the intermediate fraction (*B*) from the first run, and fractionate again. The yield of product b.p. 144–146°, is 45 g.

***n*-Hexaldehyde.** The apparatus required is a 1-litre three-necked flask, provided with a dropping funnel, a mercury-sealed stirrer and a double surface condenser (carrying a cotton wool or calcium chloride guard tube). Place 15 g. of dry magnesium turnings, 25 ml. of sodium-dried ether and a small crystal of iodine in the flask. Add 3 g. (2.5 ml.) of dry *n*-amyl bromide (Sections III,35 and III,37) and set the stirrer in motion. As soon as the reaction commences, add 100 ml. of sodium-dried ether, followed by a solution of 91.5 g. (76 ml.) of dry *n*-amyl bromide in 100 ml. of anhydrous ether at such a rate that the ether refluxes steadily (about 20 minutes). If the reaction becomes too vigorous, cooling in ice water may be necessary. Reflux the solution for 30 minutes in order to complete the reaction. Remove the source of heat, cool the flask to about 5°, and add 74 g. (83 ml.) of ethyl orthoformate during about 10 minutes. Reflux the mixture for 6 hours; then arrange the condenser for distillation and remove the ether on a water

bath. Allow the reaction mixture to cool. Add 375 ml. of ice-cold 6 per cent. hydrochloric acid with stirring; keep the contents of the flask cool by the occasional addition of a little crushed ice. When all the white solid has passed into solution, transfer to a separatory funnel and remove the upper layer of *n*-hexaldehyde diacetal. Hydrolyse the acetal by distilling it with a solution of 50 g. (27.5 ml.) of concentrated sulphuric acid in 350 ml. of water; collect the aldehyde, which distils over as an oil, in a solution of 50 g. of sodium bisulphite in 150 ml. of water. Remove the oily layer (largely *n*-amyl alcohol) insoluble in the bisulphite solution and discard it. Steam distil the bisulphite solution until 100 ml. of the distillate have been collected: this will separate the remainder of the amyl alcohol and other impurities. Cool the residual bisulphite solution to about 45°, cautiously add a suspension of 40 g. of sodium bicarbonate in 100 ml. of water, and separate the resulting free aldehyde by steam distillation. Remove the upper layer (crude aldehyde) of the distillate, wash it with three 25 ml. portions of water, and dry it with 10 g. of anhydrous sodium or magnesium sulphate. Distil through a short column or from a Claisen flask with fractionating side arm, and collect the *n*-hexaldehyde (*n*-caproaldehyde) at 127–129°. The yield is 25 g.

III,64. *n*-HEXALDEHYDE (from *n*-Amyl Cyanide)

Into a 500 ml. three-necked flask, provided with a mechanical stirrer, a gas inlet tube and a reflux condenser, place 57 g. of anhydrous stannous chloride (Section II,50,11) and 200 ml. of anhydrous ether. Pass in dry hydrogen chloride gas (Section II,48,1) until the mixture is saturated and separates into two layers; the lower viscous layer consists of stannous chloride dissolved in ethereal hydrogen chloride. Set the stirrer in motion and add 19.5 g. of *n*-amyl cyanide (Sections III,112 and III,113) through the separatory funnel. Separation of the crystalline aldimine hydrochloride commences after a few minutes; continue the stirring for 15 minutes. Filter off the crystalline solid, suspend it in about 50 ml. of water and heat under reflux until it is completely hydrolysed. Allow to cool and extract with ether; dry the ethereal extract with anhydrous magnesium or calcium sulphate and remove the ether slowly (Fig. II, 13, 4, but with the distilling flask replaced by a Claisen flask with fractionating side arm). Finally, distil the residue and collect the *n*-hexaldehyde at 127–129°. The yield is 19 g.

COGNATE PREPARATION

***n*-Octaldehyde.** Use 25 g. of *n*-octonitrile, b.p. 87°/10 mm., 57 g. of anhydrous stannous chloride and 200 ml. of anhydrous ether. Isolate the aldehyde by steam distillation and ether extraction. An almost quantitative yield of *n*-octaldehyde, b.p. 65°/11 mm., is obtained.

III,65. ACETALDEHYDE (from Paraldehyde)

Assemble the simple fractional distillation apparatus shown in Fig. II, 16, 1: the round-bottomed flask should have a capacity of 200 or 250 ml. and the conical flask 100 ml. (Alternatively, a long all-glass

Dufton column may replace the Hempel column.) Place 50 ml. of paraldehyde in the flask together with 0.5 ml. of concentrated sulphuric acid (which acts as the depolymerising agent) (1) and a few small fragments of porous porcelain. Cool the receiver in crushed ice; place a *loose* plug of cotton wool between the adapter and the receiver to diminish losses due to evaporation. Warm the flask very gently on a wire gauze (or, better, in a water bath at 50–60°); do not allow the temperature at the head of the column to rise above 30–32°. The distillation must be conducted very slowly in order that the fractionation may be efficient, since acetaldehyde and paraldehyde form a constant boiling point mixture, b.p. 42° (53.4 and 46.6 mol per cent. respectively). In practice it is found that most of the acetaldehyde distils at 21–25°. Stop the distillation when 10 ml. of liquid remain in the flask: distillation to dryness may result in an explosion. The resulting acetaldehyde, produced in excellent yield, is sufficiently pure for many purposes, e.g., for use in studying the reactions of acetaldehyde. If it is not required immediately, stopper the flask loosely with a cork and keep it in the ice chest or in a refrigerator until required.

To obtain pure acetaldehyde, the product must be redistilled. Clean and dry the 200–250 ml. flask first used, immerse it in cold or ice water pour in the crude acetaldehyde rapidly, attach the fractionating column, etc. Immerse the receiver in crushed ice. Heat the flask gently in a water bath and adjust the temperature so that the aldehyde distils slowly and at a uniform temperature. The temperature recorded at the top of the column may depend partly upon the temperature of the laboratory, if this is above 21°. Pure acetaldehyde boils at 21°.

Note.

(1) The sulphuric acid may be replaced by 1–2 g. of sulphamic acid ($\text{NH}_2\text{SO}_3\text{H}$) or by *p*-toluenesulphonic acid ($p\text{-CH}_3\text{C}_6\text{H}_4\text{SO}_3\text{H}$).

III,66.

FORMALDEHYDE

Formaldehyde is a gas, b.p. — 21°, and cannot obviously be stored as such: moreover, it polymerises readily in the liquid and the gaseous state. The commercial preparation, *formalin*, is an aqueous solution containing 35–40 per cent. of formaldehyde and some methyl alcohol. The preparation of a solution of formaldehyde may be demonstrated by the following experiment.

Prepare a coil of copper wire by winding several turns around a glass tube. Heat the coil in the oxidising flame of a Bunsen burner for 1–2 minutes and plunge the spiral, whilst still red hot, into a test-tube containing a solution of 1 ml. of methyl alcohol and 5 ml. of water. Stopper the test-tube loosely, cool, remove the wire, and repeat the process two or three times. Observe the odour of the solution and use it (or formalin diluted with water) to carry out the following tests.

(i) **Resorcinol test.** Mix 1 drop of a 0.5 per cent. aqueous solution of resorcinol with 1–2 ml. of a dilute solution of formaldehyde (about 1 in 500) and pour this mixture carefully down the side of an inclined test-tube containing 2–3 ml. of concentrated sulphuric acid. A reddish-violet ring forms at the common surface of the two liquids. After a time, if

the solution is not too dilute, a white ring (consisting of a light flocculent precipitate), changing to red violet, forms in the aqueous liquid above the ring.

(ii) Action of sodium hydroxide solution. Boil a few drops of formalin solution diluted with a little water with 5 ml. of 10 per cent. sodium hydroxide solution for 5 minutes. Observe that no resin formation occurs (compare acetaldehyde and other aldehydes). Devise tests to prove that the reaction proceeds in accordance with the equation :



(iii) β -Naphthol test. Mix 3 drops of formalin, 3 ml. of 50 per cent. alcohol, 0.05 g. of β -naphthol, 3–5 drops of concentrated hydrochloric acid, and boil gently. The liquid soon becomes filled with a crystalline precipitate. Filter, wash, and recrystallise from dilute alcohol. Determine the m.p. The condensation product is methylene di- β -naphthol, m.p. 188° (decomp.) :

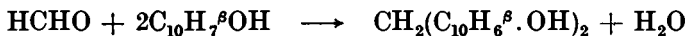

(iv) Dimedone test. Treat a neutral or slightly acid solution of dilute formaldehyde with a small quantity of a 10 per cent. alcoholic solution of dimedone (5 : 5-dimethylcyclohexane-1 : 3-dione) and stir. Filter off the precipitate after 15–20 minutes, and recrystallise it from dilute alcohol. The condensation product has m.p. 189° (compare Section III, 70,2).

III,67. HEXAMETHYLENETETRAMINE (HEXAMINE)

This preparation illustrates another point of difference between formaldehyde and other aliphatic aldehydes.

Mix 50 ml. of formalin, containing about 37 per cent. of formaldehyde, with 40 ml. of concentrated ammonia solution (sp. gr. 0.88) in a 200 ml. round-bottomed flask. Insert a two-holed cork or rubber stopper carrying a capillary tube drawn out at the lower end (as for "vacuum" distillation) and reaching almost to the bottom of the flask, and also a short outlet tube connected through a filter flask to a water pump. Evaporate the contents of the flask as far as possible on a water bath under reduced pressure. Add a further 40 ml. of concentrated ammonia solution and repeat the evaporation. Attach a reflux condenser to the flask, add sufficient absolute ethyl alcohol (about 100 ml.) in small portions to dissolve most of the residue, heat under reflux for a few minutes and filter the hot alcoholic extract, preferably through a hot water funnel (all flames in the vicinity must be extinguished). When cold, filter the hexamine, wash it with a little absolute alcohol, and dry in the air. The yield is 10 g. Treat the filtrate with an equal volume of dry ether and cool in ice. A further 2 g. of hexamine is obtained.

Hexamethylenetetramine sublimes at about 260° and is very soluble in water.

III,68. ACETAL (*Acetaldehyde Diethylacetal*)

Place 50 g. of anhydrous calcium chloride and 260 g. (323 ml.) of rectified spirit (95 per cent. ethyl alcohol) in a 1-litre narrow neck bottle, and cool the mixture to 8° or below by immersion in ice water. Introduce slowly 125 g. (155 ml.) of freshly distilled acetaldehyde, b.p. 20–22° (Section III,65) down the sides of the bottle so that it forms a layer on the alcoholic solution. Close the bottle with a tightly fitting cork and shake vigorously for 3–4 minutes: a considerable rise in temperature occurs so that the stopper must be held well down to prevent the volatilisation of the acetaldehyde. Allow the stoppered bottle to stand for 24–30 hours with intermittent shaking. (After 1–2 hours the mixture separates into two layers.) Separate the upper layer (*ca.* 320 g.) and wash it three times with 80 ml. portions of water. Dry for several hours over 6 g. of anhydrous potassium carbonate and fractionate with an efficient column (compare Section II,17). Collect the fraction, b.p. 101–104°, as pure acetal. The yield is 200 g.

COGNATE PREPARATION

Di-*n*-butyl acetal (*Acetaldehyde di-*n*-butyl acetal*). Place 44 g. (44.5 ml.) of paraldehyde, 187.5 g. (232 ml.) of *n*-butyl alcohol and 5 g. of *p*-toluenesulphonic acid in a 500 or 750 ml. round-bottomed flask. attach a reflux condenser, and reflux the mixture for 12 hours. Remove the small aqueous layer (about 1 ml.), wash with a solution of 2.5 g. of anhydrous sodium carbonate (to remove the acid), then with a mixture of "20-volume" hydrogen peroxide and 10 ml. of 10 per cent. sodium carbonate solution at 40° (to remove the excess of aldehyde), and finally with water. Dry over anhydrous potassium carbonate and distil through an efficient fractionating column (*e.g.*, a Widmer column, a Hempel column filled with $\frac{1}{4}$ " glass rings, or a modified Hempel column—see Figs. II, 15, 2–5). The fraction distilling to 120° (75 g.) consists largely of *n*-butyl alcohol, the temperature rises rapidly to 183°, and the di-*n*-butyl acetal is collected at 183–190° (largely at 188°); there is a small high boiling point residue. The yield is 110 g. Upon redistillation, the acetal boils at 186.5–187.5°.

III,69. REACTIONS AND CHARACTERISATION OF ACETALS

Acetals are usually liquid; they are almost unaffected by alkalis and are not attacked by metallic sodium nor by Fehling's solution. They are identified by reference to the alcohol and aldehyde (or ketone if a ketal) which they yield when hydrolysed in acid solution. Hydrolysis proceeds readily in dilute acid solution (*e.g.*, with 3–5 per cent. acid):

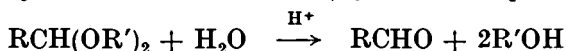

The rate of hydrolysis depends upon the solubility of the acetal in the hydrolysis medium. Acetals of low molecular weight are completely hydrolysed by refluxing for 5–10 minutes; those of higher molecular weight, and therefore of small solubility, may require 30–60 minutes, but

the rate of hydrolysis may be increased by the addition of dioxan which increases the solubility of the acetal.

CAUTION. Acetals, like ethers, may contain explosive peroxides which must be removed before distillation is attempted. The procedure to be adopted is similar to that described under *Ethers* (see Section III,60).

The experimental procedure to be followed depends upon the products of hydrolysis. If the alcohol and aldehyde are both soluble in water, the reaction product is divided into two parts. One portion is used for the characterisation of the aldehyde by the preparation of a suitable derivative (*e.g.*, the 2 : 4-dinitrophenylhydrazone, semicarbazone or dimedone compound—see Sections III,70 and III,74). The other portion is employed for the preparation of a 3 : 5-dinitrobenzoate, etc. (see Section III,27) : it is advisable first to concentrate the alcohol by distillation or to attempt to salt out the alcohol by the addition of solid potassium carbonate. If one of the hydrolysis products is insoluble in the reaction mixture, it is separated and characterised. If both the aldehyde and the alcohol are insoluble, they are removed from the aqueous layer ; separation is generally most simply effected with sodium bisulphite solution (compare Section III,74), but fractional distillation may sometimes be employed.

The formulae and physical properties of a number of common acetals are collected in Table III,69.

TABLE III,69.

ACETALS

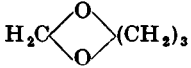
Name	Formula	B.P.	d_{4}^{20}	n_{D}^{20}
Methylal . . .	$\text{CH}_2(\text{OCH}_3)_2$	42°	0.859	1.353
Ethylal . . .	$\text{CH}_2(\text{OC}_2\text{H}_5)_2$	87	0.831	1.373
<i>n</i> -Propylal . . .	$\text{CH}_2(\text{OC}_3\text{H}_7^{\alpha})_2$	137	0.834	1.393
<i>iso</i> -Propylal . . .	$\text{CH}_2(\text{OC}_3\text{H}_7^{\beta})_2$	121	0.818	1.384
<i>n</i> -Butylal . . .	$\text{CH}_2(\text{OC}_4\text{H}_9^{\alpha})_2$	181	0.835	1.406
<i>iso</i> -Butylal . . .	$\text{CH}_2(\text{OC}_4\text{H}_9^{\beta})_2$	164	0.824	1.400
<i>n</i> -Amylal . . .	$\text{CH}_2(\text{OC}_5\text{H}_{11}^{\alpha})_2$	219	0.838	1.416
<i>n</i> -Hexylal . . .	$\text{CH}_2(\text{OC}_6\text{H}_{13}^{\alpha})_2$	255	0.841	1.423
Dimethylacetal . . .	$\text{CH}_3\text{CH}(\text{OCH}_3)_2$	64	0.852	1.366
Acetal . . .	$\text{CH}_3\text{CH}(\text{OC}_2\text{H}_5)_2$	103	0.826	1.381
<i>n</i> -Propylacetal . . .	$\text{CH}_3\text{CH}(\text{OC}_3\text{H}_7^{\alpha})_2$	147	0.830	1.397
<i>n</i> -Butylacetal . . .	$\text{CH}_3\text{CH}(\text{OC}_4\text{H}_9^{\alpha})_2$	187	0.833	1.409
<i>iso</i> -Butylacetal . . .	$\text{CH}_3\text{CH}(\text{OC}_4\text{H}_9^{\beta})_2$	176	0.821	1.403
<i>n</i> -Amylacetal . . .	$\text{CH}_3\text{CH}(\text{OC}_5\text{H}_{11}^{\alpha})_2$	222	0.839	1.418
Ethylpropylal . . .	$\text{CH}_3\text{CH}_2\text{CH}(\text{OC}_2\text{H}_5)_2$	124	0.823	—
1 : 3-Dioxan . . .		105	1.034	1.420
Acrolein acetal . . .	$\text{CH}_2=\text{CHCH}(\text{OC}_2\text{H}_5)_2$	125	0.850	—

III,70. REACTIONS AND CHARACTERISATION OF ALIPHATIC ALDEHYDES

The following reactions are characteristic of aliphatic aldehydes : those which are shared by ketones, due to the presence of the carbonyl group, are given under *Aliphatic Ketones* (Section III,74).

Use the acetaldehyde prepared in Section III,65 * for the following tests.

(i) **Reduction of ammoniacal silver nitrate solution.** Add a few drops of a dilute solution of the aldehyde to 2-3 ml. of an ammoniacal solution of silver nitrate {this contains the ion $[Ag(NH_3)_2]^+$ } in a clean test-tube. A silver mirror is deposited on the walls of the tube either in the cold or upon warming in a beaker of boiling water.

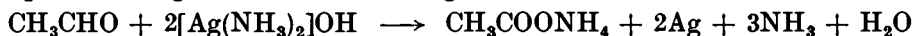

Note.

Do not heat the silver solution or allow it to stand even for a few hours, since explosive silver fulminate may be formed. The ammoniacal solution of silver nitrate is prepared by treating 3 ml. of 0.1N silver nitrate solution with very dilute ammonia solution dropwise until the precipitate which is first formed just redissolves.

It is preferable to use Tollen's ammoniacal silver nitrate reagent, which is prepared as follows : Dissolve 3 g. of silver nitrate in 30 ml. of water (solution A) and 3 g. of sodium hydroxide in 30 ml. of water (solution B). When the reagent is required, mix equal volumes (say, 1 ml.) of solutions A and B in a clean test-tube, and add dilute ammonia solution drop by drop until the silver oxide is just dissolved. Great care must be taken in the preparation and use of this reagent, which must not be heated. Only a small volume should be prepared just before use, any residue washed down the sink with a large quantity of water, and the test-tubes rinsed with dilute nitric acid.

(ii) **Reduction of Fehling's solution.** Place 4 ml. of freshly prepared Fehling's solution [made by mixing equal volumes of Fehling's solution No. 1 (copper sulphate solution) and solution No. 2 (alkaline tartrate solution)] in a test-tube. Add 2-3 drops of acetaldehyde and boil the solution. A bright red precipitate of cuprous oxide is ultimately formed.

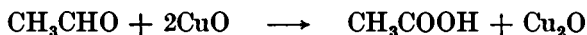

Preparation of Fehling's solution. *Solution No. 1.* Dissolve 34.64 g. of A.R. copper sulphate crystals in water containing a few drops of dilute sulphuric acid, and dilute the solution to 500 ml.

Solution No. 2. Dissolve 60 g. of pure sodium hydroxide and 173 g. of pure Rochelle salt (sodium potassium tartrate) in water, filter if necessary through a sintered glass funnel, and make up the filtrate and washings to 500 ml.

Keep the two solutions separately in tightly stoppered bottles and mix exactly equal volumes immediately before use.

(iii) **Test with Schiff's reagent (fuchsin aldehyde reagent).** Add 1 drop of acetaldehyde to 2-3 ml. of water, and to this solution add 1 ml. of Schiff's reagent. Observe the production of a pink or bluish-red colouration.

Schiff's reagent is a dilute solution of fuchsin hydrochloride (*p*-rosaniline) that has been decolourised by sulphur dioxide. This decolourisation is the result of a

* If the temperature of the laboratory is above 20°, *n*-butyraldehyde (Section III,61) may be employed for all the tests with the exception of (vii).

reaction between the *p*-rosaniline and sulphurous acid that destroys the quinonoid structure of the dye and produces a colourless compound. The aldehyde, by combining with the sulphurous acid, restores the quinonoid structure and hence the colour.

By way of caution it should be noted that free alkali or the alkali salts of weak acids will redden the reagent like an aldehyde. It is also, of course, reddened by heat or when exposed in small quantities to the air for some time. Mineral acids greatly reduce the sensitivity of the test.

Preparation of Schiff's reagent. *Method 1.* Dissolve 0.2 g. of pure *p*-rosaniline hydrochloride in 20 ml. of a cold, freshly-prepared, saturated aqueous solution of sulphur dioxide; allow the solution to stand for a few hours until it becomes colourless or pale yellow. Dilute the solution to 200 ml. and keep it in a tightly-stoppered bottle. If the bottle is not adequately stoppered, the reagent will gradually lose sulphur dioxide and the colour will return. The solution keeps well if not unnecessarily exposed to light and air.

Method 2. Add 2 g. of sodium bisulphite to a solution of 0.2 g. of *p*-rosaniline hydrochloride and 2 ml. of concentrated hydrochloric acid in 200 ml. of water.

(iv) **Action of dilute sodium hydroxide solution.** Mix a few drops of acetaldehyde with 5 ml. of water and add 2-3 drops of 10 per cent. sodium hydroxide solution. Note that the solution acquires a yellow colour and that on boiling a characteristic pungent odour (due to crotonaldehyde produced by way of the aldol) is apparent.

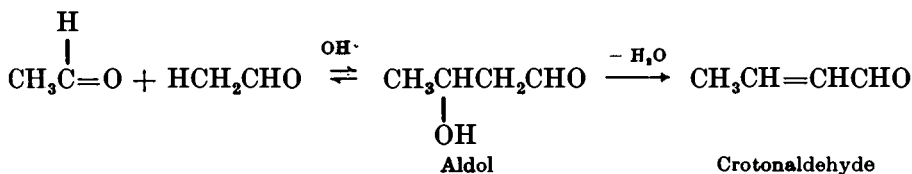

Now warm 2-3 drops of acetaldehyde with 3-4 ml. of 10-20 per cent. sodium hydroxide solution, *i.e.*, with excess of concentrated alkali solution. Observe the formation of a yellow aldehyde resin and the attendant peculiar odour.

(v) **Polymerisation.** (a) Place 2 ml. of acetaldehyde in a test-tube which is immersed in a mixture of ice and salt. Insert a thermometer in the tube and observe the temperature; remove the thermometer and wipe it with a clean cloth. Add a drop of concentrated sulphuric acid on the end of the thermometer to the acetaldehyde, remove the test-tube from the freezing mixture, stir with the thermometer for about a minute. Note the rise in temperature. Add 3-4 ml. of water, and observe the formation of a liquid polymer (paraldehyde) which is insoluble in water.

(b) Dissolve 2 ml. of acetaldehyde in 5 ml. of dry ether, cool in a freezing mixture of ice and salt, and pass in dry hydrogen chloride gas for 30-60 seconds. The solid polymer, metaldehyde, may separate in a short time, otherwise cork the tube and allow it to stand for 10-15 minutes. Filter off the crystals.

(vi) **Sodium bisulphite test.** Aldehydes react with saturated sodium bisulphite solution to yield crystalline bisulphite-addition compounds:



A condition of equilibrium is reached (70-90 per cent. of bisulphite compound with equivalent quantities of the reagents in 1 hour), but by using a large excess of bisulphite almost complete conversion into the

addition compound results. Since the reaction is reversible, the aldehyde can be recovered by adding to an aqueous solution of the bisulphite compound sufficient sodium carbonate solution or hydrochloric acid to react with the free sodium bisulphite present in the equilibrium mixture. Bisulphite compounds may therefore be employed for the purification of aldehydes or for their separation from other organic substances.

The most satisfactory reagent is a saturated solution of sodium bisulphite containing some alcohol *; it must be prepared as required since it oxidises and decomposes on keeping. Frequently, a saturated aqueous solution is used without the addition of alcohol.

Prepare 10 ml. of saturated sodium bisulphite solution and add 4 ml. of the aldehyde: shake thoroughly and observe the rise in temperature. Filter the crystalline precipitate at the pump, wash it with a little alcohol, followed by ether, and allow it to dry.

Treat a small quantity of the bisulphite addition compound with 5 ml. of 10 per cent. sodium carbonate solution, and note the odour. Repeat the experiment with 5 ml. of dilute hydrochloric acid.

(vii) β -Naphthol test. Dissolve 0.2 g. of β -naphthol in 2 ml. of cold glacial acetic acid containing 2 drops of concentrated hydrochloric acid, add a drop of acetaldehyde, shake the mixture, then warm for 5 minutes at 60° and finally to boiling. Cool the mixture, shake vigorously to induce crystallisation, or add 1 drop of 50 per cent. ethyl alcohol and shake again. Recrystallise the white crystalline compound (ethylidene di- β -naphthol) from alcohol; it should have a m.p. of 172–173°.

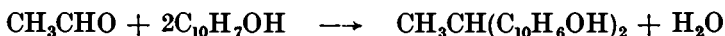

CRYSTALLINE DERIVATIVES OF ALIPHATIC ALDEHYDES

1. **2 : 4-Dinitrophenylhydrazones.** Small quantities may be prepared with the class reagent described in Section XI, 7, 4. A more satisfactory procedure is given under *Aliphatic Ketones*, Section III, 74, 1.

2. **Dimedone derivatives.** Dimedone or 5 : 5-dimethylcyclohexane-1 : 3-dione † in saturated aqueous solution ‡ or in 10 per cent. alcoholic solution gives crystalline derivatives (I) with aldehydes, but not with ketones. The reaction is :

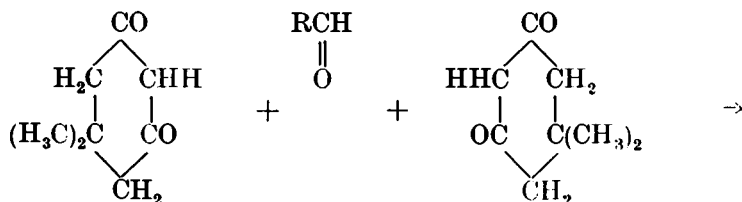

* This sodium bisulphite reagent is prepared by treating a saturated aqueous solution of sodium bisulphite with 70 per cent. of its volume of rectified (or methylated) spirit, and then adding just sufficient water to produce a clear solution.

† The bisulphite solution obtained by passing sulphur dioxide into sodium carbonate solution is not recommended since the resulting yellow solution contains free sulphurous acid which dissolves some bisulphite compounds.

‡ Also termed dimethyldihydroresorcinol and methone. The derivatives (I) are conveniently termed formaldehyde *bis*-methone (R = H), etc.

§ The solubilities in 100 ml. of water are :—19°, 0.40 g.; 25°, 0.42 g.; 50°, 1.19 g.; 80°, 3.20 g.; 90°, 3.84 g.

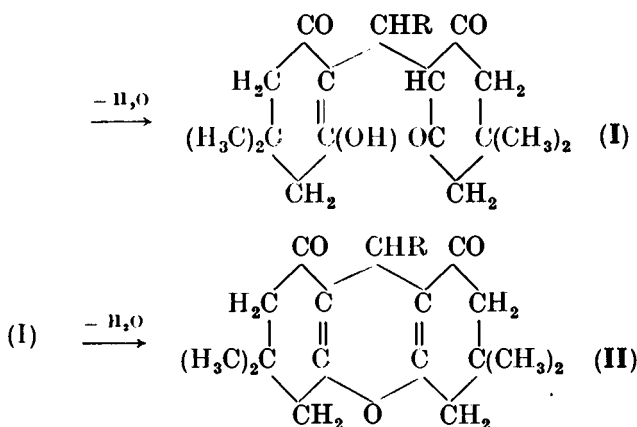

The condensation products are almost insoluble in water, but can be crystallised from *dilute* alcohol. Dimedone is therefore a good reagent for the detection and characterisation of aldehydes.

The alkylidene dimethone (dimedone) (I) upon boiling with glacial acetic acid, acetic anhydride, hydrochloric acid and other reagents frequently loses water and passes into a substituted octahydroxanthene or the "anhydride" (II), which often serves as another derivative. The derivatives (I) are soluble in dilute alkali and the resulting solutions give colourations with ferric chloride solution; on the other hand, the "anhydrides" (II) are insoluble in dilute alkali and hence can easily be distinguished from the alkylidene dimedones (I).

Add 0.1 g. of the aldehyde in 5 ml. of 50 per cent. ethanol to 2 ml. of a 10 per cent. or saturated alcoholic solution of dimedone.* If a precipitate does not form immediately, warm for 5 minutes; if the solution is still clear at the end of this period, add hot water until the mixture is just cloudy and cool to about 5°. Collect the crystalline derivative and recrystallise it from methanol - water or ethanol - water.

To prepare the "anhydride", boil a solution of 0.1 g. of the dimedone derivative (I) in 5 ml. of 80 per cent. ethanol to which 1 drop of concentrated hydrochloric acid has been added for 5 minutes, then add hot water until the mixture is just turbid, cool and collect the "anhydride" by filtration. Recrystallise it from dilute methanol.

3. Semicarbazones. For experimental details, see under *Aliphatic Ketones*, Section III, 74, 2.

For the preparation of oximes, phenylhydrazones and *p*-nitrophenylhydrazones (where applicable), see under *Aromatic Aldehydes*, Section IV, 135, 4-6.

The melting points of some crystalline derivatives of a number of selected aliphatic aldehydes are collected in Table III, 70.

* The reagent is attacked by oxidising agents with the formation of formaldehyde, hence it cannot be used for the detection of the latter (or of other aldehydes) in the presence of oxidising agents.

TABLE III,70.

ALIPHATIC ALDEHYDES

Aldehyde	B.P.	Alkylidene Dimedone (I)	Dimedone "Anhydride" (II)	2 : 4-Dinitrophenylhydrazone	Semicarbazone	<i>p</i> -Nitrophenylhydrazone	Other Derivatives
Formaldehyde	- 21°	189°	171°	166°	169 <i>d</i>	182°	Methylene di-β-naphthol, 190°
Acetaldehyde	20	141	174	168	163	129	Oxime, 47
Propionaldehyde	49	155	143	155	154 (89)	124	Oxime, 40
<i>n</i> -Butyraldehyde	75	142	141	123	106	87	—
<i>iso</i> -Butyraldehyde	64	154	144	187	126	131	—
Trimethylacetaldehyde	75	—	—	209	190	119	Oxime, 41
<i>n</i> -Valeraldehyde	104	105	113	98	—	—	Oxime, 52
<i>iso</i> -Valeraldehyde	92	155	173	123	132	110	Oxime, 48
<i>n</i> -Hexaldehyde	131	109	—	107	106	—	Oxime, 51
<i>n</i> -Heptaldehyde	155	103	112	108	109	73	Oxime, 57
<i>n</i> -Octaldehyde	170	90	101	106	101	80	Oxime, 60
<i>n</i> -Nonaldehyde	190	86	—	100	100	—	Oxime, 64
<i>n</i> -Decylaldehyde	208	92	—	104	102	—	Oxime, 69
α-Ethyl- <i>n</i> -butyraldehyde	117	102	—	134	96	—	—
α-Ethyl- <i>n</i> -hexaldehyde	163	—	—	120	254 <i>d</i>	—	—
Crotonaldehyde	102	184	167	190	199	185	Phenylhydrazone, 56 ; oxime, 119
Dietnylacetaldehyde	117	102	—	130	99	—	—
Furfural	161	162	164	230 (213)	203	154	Phenylhydrazone, 98
Tetrahydrofurfural	145	—	—	204	166	—	d_4^{20} 1.107, n_D^{20} 1.436
Aldol	83°/20	147	126	—	110	—	—
Hexahydrobenzaldehyde	162	—	—	—	173	—	Oxime, 91
Acrolein	52	192	163	165	171	151	—
α-Citronellal	207	79	173	78	84	—	d_4^{20} 0.855, n_D^{20} 1.449
Citral	229 <i>d</i>	—	—	110	164	—	d_4^{20} 0.887, n_D^{20} 1.488
Chloral (hydrate, m.p. 56°)	96	—	—	131	—	—	d_4^{20} 1.512, n_D^{20} 1.457
Bromal	174	—	—	—	—	—	—
Paraldehyde	124	—	—	—	—	—	d_4^{20} 0.994, n_D^{20} 1.420

ALIPHATIC KETONES

Aliphatic ketones may be prepared :

1. By the oxidation of secondary alcohols with potassium dichromate and dilute sulphuric acid, for example :

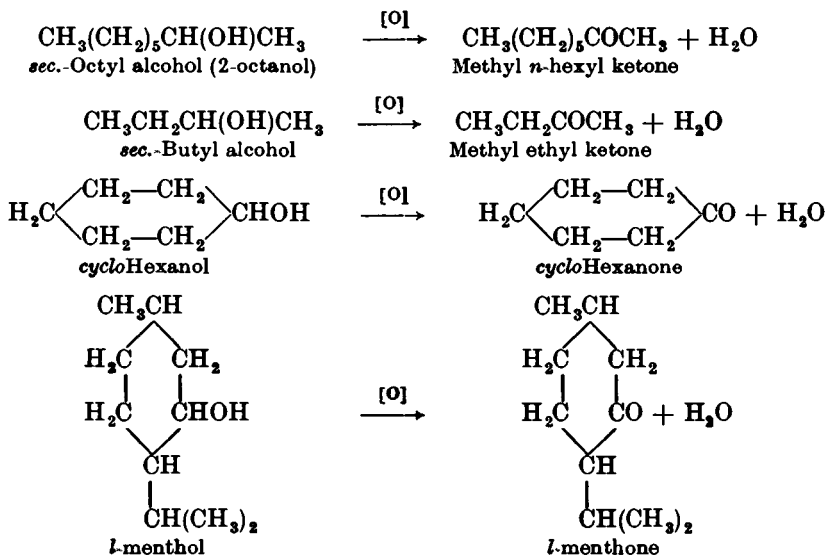

2. By passing the vapour of a monobasic acid through a tube containing manganous oxide deposited on pumice and heated to 300–350°, the metallic oxide acting as a catalyst, for example :

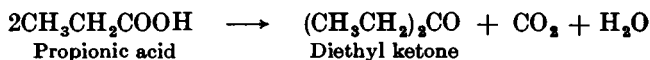

If a mixture of monobasic acids is employed, the mixed ketone may be prepared, for example :



Small quantities of the symmetrical ketones $(\text{CH}_3)_2\text{CO}$ and $(\text{CH}_3\text{CH}_2\text{CH}_2)_2\text{CO}$ (di-*n*-propyl ketone) are formed as by-products: these can easily be removed by fractional distillation through an efficient column. An excess of the cheaper reagent, acetic acid, is employed; the resulting acetone is readily removed by washing with water and little di-*n*-propyl ketone is formed under these conditions.

3. By the ketonic hydrolysis of substituted acetoacetic esters; this is brought about by the action of dilute alkali in the cold, followed by acidification and boiling. The free substituted acetoacetic acid is produced, which readily undergoes decarboxylation (since it has a carboxyl and a carbonyl group on the same carbon atom) to give a ketone, for example :

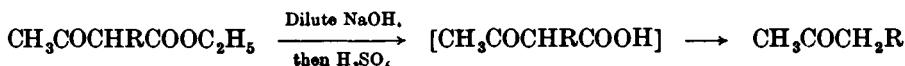

Thus if R = *n*-propyl (ethyl *n*-propylacetoacetate), methyl *n*-butyl ketone is produced. The preparation of this ketone is described in Section III, 152 under *Ethyl Acetoacetate*.

4. By pyrolysis of dibasic acids or their salts to yield cyclic ketones. The slow distillation of adipic acid with about 5 per cent. of baryta affords *cyclopentanone* in good yield :

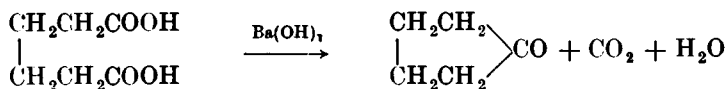

III, 71.

METHYL *n*-HEXYL KETONE

Assemble the apparatus shown in Fig. II, 13, 9 using a 500 ml. flask. If a two-way adapter is not available, the apparatus illustrated in Fig. III, 71, 1 may be employed: a dropping funnel with a long stem is bent so that it clears the condenser and may be supported in a ring, although this is not usually necessary for funnels of small capacity. Place a solution of 22.5 g. of sodium dichromate dihydrate in 150 ml. of water and 30 g. (16.5 ml.) of concentrated sulphuric acid in the flask, and add dropwise during about 30 minutes 30 g. (37 ml.) of *sec.*-octyl alcohol (capryl alcohol) (1) with frequent shaking to ensure thorough mixing (2). Heat under reflux on a boiling water bath for 2 hours, and steam distil the mixture (using the same flask, compare Fig. II, 40, 1) until oily drops cease to come over. Separate the upper layer of ketone, wash it once with water, and dry over anhydrous potassium carbonate. Distil and collect the methyl *n*-hexyl ketone (2-octanone) at 171–174°. The yield is 20 g.

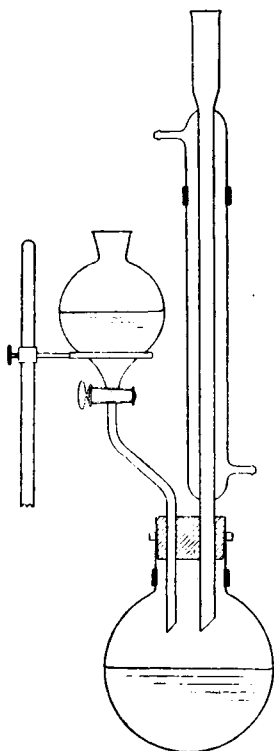

Fig. III, 71, 1.

Notes.

(1) Commercial *sec.*-octyl alcohol may be employed. A slightly better product is obtained if the latter is redistilled: b.p. 177.5–180.5°. The distillation will remove the small proportion of ketonic impurity which is frequently present in the technical alcohol.

(2) Vigorous mechanical stirring is preferable, particularly for large-scale preparations; a three-necked flask should be used. Thus for a preparation on four times the above scale, the addition of 120 g. (147 ml.) of *sec.*-octyl alcohol requires 1.5 hours and the yield is 110–115 g.

COGNATE PREPARATIONS

Methyl ethyl ketone. Use the apparatus of Fig. III, 61, 1 but with a 500 ml. round-bottomed flask. Place 40 g. (50 ml.) of *sec.*-butyl alcohol, 100 ml. of water and a few fragments of porous porcelain in the flask. Dissolve 100 g. of sodium dichromate dihydrate in 125 ml. of water in a beaker and add very slowly and with constant stirring 80 ml. of concentrated sulphuric acid; allow to cool, and transfer the resulting solution to the dropping funnel. Heat the flask on a wire gauze or in an air bath until the alcohol mixture commences to boil. Remove the flame and run in the dichromate solution slowly and at such a rate that the temperature

at the top of the column does not rise above 90–92°. Shake the flask from time to time. When all the dichromate solution has been run in, heat the flask gently and collect all the liquid which passes over below 95°. Disconnect the flask, cool, and discard the contents. Clean the flask, transfer the distillate into it, and fractionate slowly. Collect the fraction, b.p. 78–82°, as methyl ethyl ketone. Pure methyl ethyl ketone has b.p. 80°.

cycloHexanone. Dissolve 51 g. of sodium dichromate dihydrate in 250 ml. of water in a 600 ml. beaker and add carefully, with continuous stirring, 44 g. (24 ml.) of concentrated sulphuric acid. Allow the mixture to cool. Place 25 g. of *cyclohexanol* in a 500 ml. conical or flat-bottomed flask, and add the dichromate solution to it in one portion. Shake the mixture to ensure thorough mixing and observe the temperature with a thermometer. Considerable heat is evolved in the oxidation. When the temperature rises to 55°, cool the flask in a vessel of cold water or under the tap; sufficient external cooling should be applied to keep the temperature between 55° and 60°, *i.e.*, the temperature must not be allowed to fall below 55° or rise above 60°. When the temperature of the mixture no longer rises above 60° upon the removal of the external cooling, allow the flask to stand with occasional shaking for 1 hour.

Pour the reaction mixture into a 1-litre round-bottomed flask, add 250 ml. of water, fit a still head and a condenser for downward distillation (Fig. II, 13, 3, but without the thermometer). Distil the mixture until about 125 ml. of distillate (two layers) have been collected. Saturate with salt (about 30 g. are required), and separate the upper layer of *cyclohexanone*: extract the aqueous layer with 25–30 ml. of ether and combine the ether extract with the *cyclohexanone* layer. Dry with about 6 g. of anhydrous sodium or magnesium sulphate, filter the solution into a distilling flask of suitable size to which a condenser has previously been attached. Distil off the ether from a water bath—a beaker containing warm water is satisfactory. Distil the residual liquid from an air bath or a wire gauze, and collect the *cyclohexanone* at 153–156°. The yield is 16 g.

***l*-Menthone.** Dissolve 60 g. of sodium dichromate dihydrate in 300 ml. of water in a 500 ml. bolt-head flask provided with a mechanical stirrer; add slowly, while stirring the solution, 50 g. (27 ml.) of concentrated sulphuric acid. Introduce 45 g. of menthol crystals, m.p. 42–43°, in four portions and continue stirring the mixture. Heat is evolved and the temperature of the mixture rises to about 55°; if this temperature is not attained, warm gently with a small flame to this temperature. A black spongy mass is first produced, which softens as the temperature rises and finally forms a dark brown oil on the surface. The temperature falls as soon as the oxidation is complete. Transfer the reaction mixture to a separatory funnel and extract with 100 ml. of ether. Wash the ethereal extract with 100 ml. portions of 5 per cent. sodium hydroxide solution until the colour changes from dark brown to light yellow: three or four washings are usually required. Wash once with 25 ml. of water, and dry with a few grams of anhydrous sodium or magnesium sulphate. Remove the ether on a water bath (Fig. II, 13, 4 but with Claisen flask) and distil the residue under atmospheric pressure. Collect the *l*-menthone at

205–208° (38 g.). The distillation may also be conducted under reduced pressure: b.p. 98–100°/18 mm.

III,72.

DIETHYL KETONE

The complete assembly for carrying out the catalytic decomposition of acids into ketones is shown in Fig. III, 72, 1. The main part of the apparatus consists of a device for dropping the acid at constant rate into a combustion tube containing the catalyst (manganous oxide deposited upon pumice) and heated electrically to about 350°; the reaction products are condensed by a double surface condenser and collected in a flask (which may be cooled in ice, if necessary); a glass "bubbler" at the end of the apparatus indicates the rate of decomposition (evolution of carbon dioxide). The furnace may be a commercial cylindrical furnace, about 70 cm. in length, but it is excellent practice, and certainly very much cheaper, to construct it from simple materials.

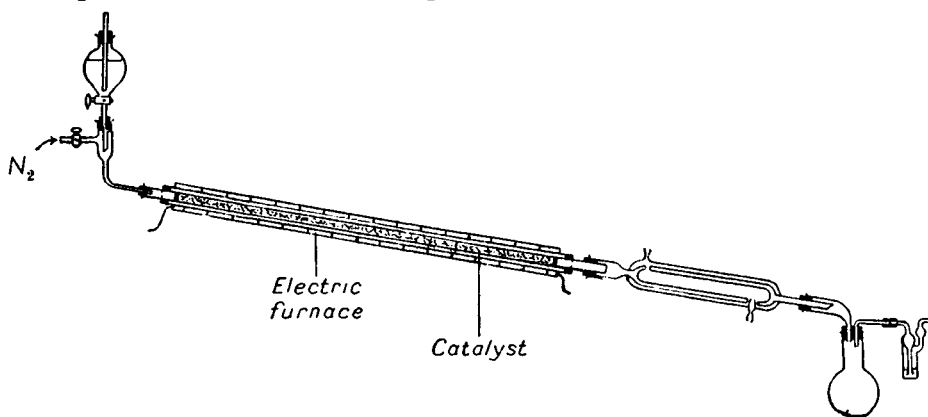

Fig. III, 72, 1.

Construction of the electric tube furnace. Secure a thin-walled iron tube, 78 cm. long and 2.8 cm. in internal diameter, and securely wrap it with asbestos cloth (*ca.* 2 mm. thickness). Wind the central 70 cm. evenly with 10 metres of nichrome wire of No. 30 S.W.G., and cover it with two thicknesses of asbestos cloth held in position by copper wire ligatures. Complete the insulation by wrapping a further two thicknesses of the asbestos cloth round the tube. Attach the two ends of the nichrome wire to two insulated connectors and then to a power point (*e.g.*, 220 volt mains). The temperature inside a Pyrex glass tube placed close to the walls of the furnace is about 350°: some adjustment of temperature may be achieved by removing one of the outer coverings of asbestos cloth. It is, however, preferable to connect the two ends of the nichrome wire to the mains through a small variable resistance (*e.g.*, 25 ohms carrying 2.5 amperes)* or to a variable ratio transformer (*e.g.*, "variac," type 200-CMH †) or to a Sunvic energy control unit (type TYB). ‡ The

* An ammeter, reading to 1.5–2.0 amperes, should be placed in the circuit.

† Supplied by Zenith Electric Ltd.

‡ Supplied by Sunvic Controls Ltd.

combustion tube may then be placed in the furnace, and the temperature determined in various positions in the tube either with a long nitrogen-filled thermometer or preferably with a thermo-couple; the temperature will be found to be constant over the central 40–50 cm. of the tube. A graph may be constructed with temperatures as ordinates and instrument (ammeter, "variac" or energy regulator unit) readings as abscissae; such a calibration is well worth while as it considerably extends the utility of the furnace.

Preparation of the catalyst. Fill a hard glass (*e.g.*, Pyrex) tube, 100 cm. long and 1.5 cm. internal diameter, with pumice (4–8 mesh). Transfer the pumice into a thick suspension of about 40 g. of freshly precipitated manganous carbonate contained in a beaker. (The manganous carbonate is prepared by adding a solution of 38 g. A.R. anhydrous sodium carbonate to a solution of 70 g. of A.R. crystallised manganous chloride, and filtering). Heat the beaker on a hot plate with vigorous stirring with a glass rod until most of the water is expelled, then transfer the solid to a shallow porcelain basin and continue the heating, with stirring, until the lumps no longer cling together; take great care to avoid local overheating. It is important to adjust the volume of water used in preparing the suspension of manganous carbonate so that most of the latter is absorbed by the pumice; if much water has to be evaporated, the manganous carbonate does not adhere satisfactorily. When many preparations are to be carried out, it is advisable to prepare a larger quantity of the catalyst in one operation.

Description of apparatus and method of use. Pack the catalyst into a hard glass or Pyrex tube, 100 cm. long and 1.5 cm. in internal diameter, and hold it in position by means of plugs of purified glass wool (Section II, 47,4). Insert the glass tube in the electric furnace and fix it centrally with the aid of asbestos pulp inserted in the annular space between the two ends. Fit up the apparatus as shown in Fig. III, 72, 1: note the constant pressure device in the dropping funnel (500 or 1000 ml. capacity) which permits the dropping of the liquid in the funnel at constant rate without the need of adjustment during the addition. Heat the pumice in a gentle stream of nitrogen for 8 hours at 360–400° in order to convert the manganous carbonate into manganous oxide, and then allow to cool in a stream of this gas. Place 740 g. (746 ml.) of redistilled propionic acid, b.p. 139–141°, in the dropping funnel, the tap of which has been previously lubricated with a "hard grease." Heat the furnace to about 350° whilst a slow stream of nitrogen is passed through the catalyst tube. After 2–3 hours adjust the stopcock so that not more than 30 drops of liquid per minute fall from the funnel into the adapter; stop the stream of nitrogen during the addition of the acid. The apparatus requires very little attention, and the circulation of the acid over the catalyst occupies 48–72 hours. The distillate consists of two layers. Separate the lower aqueous layer, salt out the ketone with solid potassium carbonate, and add it to the main ketonic layer. Treat the combined liquids with small quantities of anhydrous potassium carbonate (1) until effervescence ceases (this both removes the excess of acid and dries the ketone), filter, and distil through a short column. Collect the diethyl ketone at 101–103°. The yield is 252 g. An improved yield may be

obtained by recirculating the distillate over the catalyst, but in practice this is rarely worth while. It must be remembered that on each occasion that the catalyst is allowed to cool, a slow stream of nitrogen must be passed through the apparatus to prevent the oxidation of the manganous oxide catalyst.

Note.

(1) An alternative method of working up the distillate, which has its advantages when dealing with volatile ketones or when it is suspected that conversion into the ketone is incomplete, is to treat the combined ketones with sodium hydroxide pellets until the mixture is alkaline. Should solids separate, these may be dissolved by the addition of a little water. The ketone is then separated, dried over anhydrous potassium carbonate, and fractionated.

COGNATE PREPARATIONS

Di-*n*-propyl ketone. Use 880 g. (920 ml.) of *n*-butyric acid, b.p. 162–164°. The yield of ketone, b.p. 142–143°, is 285 g.*

Methyl *n*-propyl ketone. Use 360 g. of glacial acetic acid and 176 g. (184 ml.) of *n*-butyric acid. The yield of methyl *n*-propyl ketone, b.p. 102–104°, is 75 g.; 75 g. of acetone, b.p. 56–57°,† are also obtained.

Ethyl *n*-propyl ketone. Use 296 g. (298 ml.) of propionic acid and 352 g. (368 ml.) of butyric acid. The yield is 214 g. of ethyl *n*-propyl ketone, b.p. 122–124°; the by-products are 98 g. of diethyl ketone, b.p. 100–102° and 66 g. of di-*n*-propyl ketone, b.p. 144–146°.

Di-*n*-amyl ketone. Use 400 g. (428 ml.) of *n*-caproic acid, b.p. 204–206°. The yield of ketone, b.p. 222–226°, is 225 g.

For the preparation of *methyl n-butyl ketone* and *methyl n-amyl ketone* by another method, see Section III,152.

III,73.

cyclopENTANONE

Mix 200 g. of adipic acid intimately with 10 g. of finely-powdered, crystallised barium hydroxide. Place the mixture in a 1-litre distilling flask, fitted with a thermometer reaching to within 5 mm. of the bottom; connect the flask with a condenser and receiver. Heat the mixture gradually in an air bath (1) to 285–295° during about 90 minutes and maintain it at this temperature until only a small amount of dry residue remains in the flask; this requires a further 2 hours. The temperature must not be allowed to rise above 300°, since at this temperature the adipic acid distils quite rapidly; the best working temperature is 290°. The *cyclopentanone* distils slowly accompanied by a little adipic acid. Separate the ketone from the water in the distillate, and dry it with anhydrous potassium carbonate; this treatment simultaneously removes the traces of adipic acid present. Finally distil from a flask of suitable size and collect the *cyclopentanone* at 128–131°. The yield is 92 g.

* All the yields given refer to one circulation of the acid (or acids) over the catalyst, but can be improved by recirculating the product, from which the water layer has been removed, over the catalyst. With the higher ketones, the second circulation may result in carbonisation of the catalyst, thus rendering it inefficient.

† The symmetrical ketones, produced as by-products in the preparation of mixed ketones, are separated by distillation through an efficient fractionating column. If acetone is a by-product (as in the preparation of methyl *n*-propyl ketone), some is lost in the washing process.

Note.

(1) An iron saucepan with a layer of sand at the bottom is quite satisfactory: the distilling flask is immersed in the bath to within 2 cm. of the side arm, and two asbestos boards, cut to fit the neck of the flask, rest on top of the bath (as in Fig. II, 5, 3). Somewhat better results are obtained if the bath is filled with nickel shot.

III,74. REACTIONS AND CHARACTERISATION OF ALIPHATIC KETONES

Ketones, unlike aldehydes (Section III,70), do not (a) reduce ammoniacal solutions of silver salts, (b) reduce Fehling's solution, (c) react with Schiff's reagent, (d) yield resins with strong sodium hydroxide solution, and (e) react with the dimedone reagent. Most ketones which contain the $-\text{COCH}_3$ grouping (*e.g.*, acetone) {excluding those possessing the phenyl C_6H_5 grouping} or those which contain the >CO grouping as part of the ring (*e.g.*, cyclohexanone) react with sodium bisulphite solution to an appreciable extent. Aldehydes and those ketones which combine appreciably with sodium bisulphite react with hydrogen cyanide to form cyanohydrins :

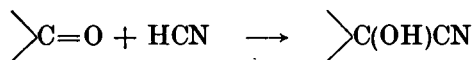

The carbonyl compound may be mixed with an aqueous solution of sodium or potassium cyanide and mineral acid is added, or the bisulphite compound may be treated with an equivalent quantity of sodium cyanide, for example :

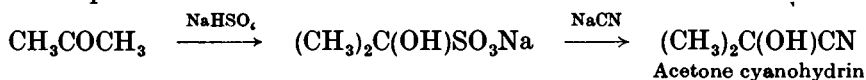

Most of the characteristic reactions of ketones ($\text{RR}'\text{CO}$) depend upon condensation with substituted amines. The reactions occur between the carbonyl group and the $-\text{NH}_2$ group of the substituted amine, and hence are also shared by aldehydes RHCO :

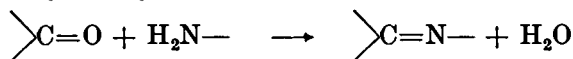

Many of these are crystalline compounds of sharp m.p. and are therefore useful for identification and characterisation. These include the condensation products with :

(i) **Hydroxylamine** (NH_2OH). The substance formed is termed an **oxime**, for example :

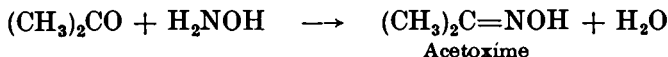

(ii) **Hydrazine** (NH_2NH_2). The product formed is called a **hydrazone**, but since this derivative possesses a free amino group it can condense with another molecule of the carbonyl compound to yield an **azine** :

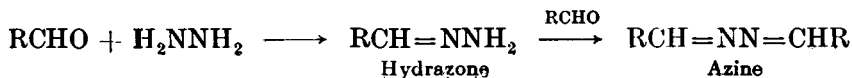

This double condensation is prevented by the use of substituted hydrazines.

(iii) **Phenylhydrazine** ($C_6H_5NHNH_2$). Carbonyl compounds react with phenylhydrazine to give phenylhydrazones. These derivatives are largely oils (or possess low melting points) for many aliphatic aldehydes and ketones, but are generally crystalline for aromatic carbonyl compounds and also for *cycloaliphatic* and heterocyclic aldehydes and ketones, for example :

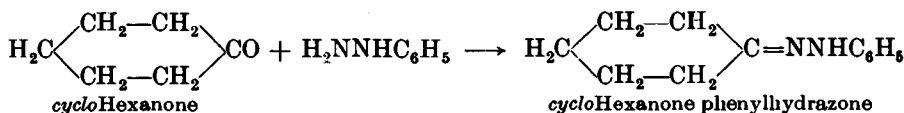

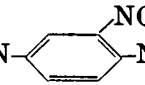
(iv) **2:4-Dinitrophenylhydrazine** (O_2N -- $NHNH_2$). The 2:4-dinitrophenylhydrazones (see Section XI,7,4) formed with this reagent are generally highly crystalline and almost insoluble in water (because of their high molecular weight) and are therefore eminently suitable for the detection and characterisation of carbonyl compounds.

(v) **Semicarbazide hydrochloride** ($NH_2CONHNH_2, HCl$). This is one of the best reagents for the characterisation of carbonyl compounds since the derivatives, known as **semicarbazones**, are readily formed, are highly crystalline, possess sharp melting points, and are easily crystallised (*e.g.*, from alcohol or acetone) :



The reagent is, however, more expensive than 2:4-dinitrophenylhydrazine.

In order to obtain practice in the preparation of the above derivatives, experimental details for a few typical examples will be given.

A. Purification of commercial cyclohexanone through the bisulphite compound

Prepare a saturated solution of sodium bisulphite at the laboratory temperature from 40 g. of finely powdered sodium bisulphite: about 70 ml. of water are required. Measure the volume of the resulting solution and treat it with 70 per cent. of its volume of rectified spirit (or methylated spirit); add sufficient water (about 45 ml.) to just dissolve the precipitate which separates. Introduce 20 g. of commercial *cyclohexanone* into the aqueous-alcoholic bisulphite solution with stirring and allow the mixture to stand for 30 minutes; stir or shake occasionally. Filter off the crystalline bisulphite compound at the pump, and wash it with a little methylated spirit.

Transfer the bisulphite compound to a separatory funnel and decompose it with 80 ml. of 10 per cent. sodium hydroxide solution. Remove the liberated *cyclohexanone*, saturate the aqueous layer with salt and extract

it with 30 ml. of ether. Combine the ether extract with the ketone layer and dry with 5 g. of anhydrous magnesium or sodium sulphate. Filter the dried ethereal solution into a 50 ml. distilling flask (1), attach a condenser, add a few fragments of porous porcelain, and distil off the ether from a water bath; take the usual precautions against fire. Distil the residual *cyclohexanone* using an air bath or an asbestos-centred wire gauze, and collect the fraction, b.p. 153–155°. The yield of pure *cyclohexanone* is 15–18 g., depending upon the purity of the sample of ketone employed.

Note.

(1) Alternatively—and this procedure is recommended—remove the ether with the apparatus shown in Fig. II, 13, 4. A slightly improved yield is obtained if a short fractionating column is used.

B. Acetoxime

Dissolve 5 g. of hydroxylamine hydrochloride in 10 ml. of water in a small conical flask and add a solution of 3 g. of sodium hydroxide in 10 ml. of water. Cool the solution in cold or ice water, and add 6 g. (7.6 ml.) of acetone slowly. Cool the flask, shake well, and leave overnight, during which time the oxime may crystallise out. If no crystals appear, cork the flask and shake vigorously when the acetoxime usually separates as colourless crystals. Filter the crystals at the pump, dry rapidly between filter paper (yield: 2.6 g.) and determine the m.p. (59°). Extract the filtrate with two 20 ml. portions of ether, and remove the solvent: a further 0.5 g. of acetoxime (m.p. 60°) is obtained. Recrystallise from light petroleum, b.p. 40–60° (*CAUTION*: inflammable) to obtain the pure acetoxime, m.p. 60°. Acetoxime sublimes when left exposed to the air.

B'. cycloHexanone Oxime

Dissolve 2.5 g. of hydroxylamine hydrochloride and 4 g. of crystallised sodium acetate in 10 ml. of water in a small flask or in a test-tube. Warm the solution to about 40° and add 2.5 g. of *cyclohexanone*. Stopper the vessel securely with a cork and shake vigorously for a few minutes: the oxime soon separates as a crystalline solid. Cool in ice, filter the crystals at the pump, and wash with a little cold water. Recrystallise from light petroleum, b.p. 60–80°, and dry the crystals upon filter paper in the air. The yield of pure *cyclohexanone oxime*, m.p. 90°, is 2.5 g.

C. cycloHexanone Phenylhydrazone

Prepare a solution of phenylhydrazine by dissolving 1.0 g. of phenylhydrazine hydrochloride and 1.5 g. of crystallised sodium acetate in 10 ml. of water; * if the resulting solution is turbid, filter. Add a solution of 0.5 ml. of *cyclohexanone* in 8 ml. of water to the reagent

* The reagent may also be prepared by dissolving 1 ml. of phenylhydrazine in a solution of 1 ml. of glacial acetic acid and 10 ml. of water. This procedure is not so convenient as that from the solid hydrochloride because of the poisonous character of phenylhydrazine (both liquid and vapour). If the liquid is accidentally spilled on the skin, wash it at once with dilute acetic acid, followed by soap and water.

contained in a test-tube, cork the tube, and shake vigorously until the phenylhydrazone has crystallised. Filter the crystals at the pump and wash well with water. Recrystallise from dilute alcohol. M.p. 77° .

D. Acetone Semicarbazone

Prepare a solution of 1.0 g. of semicarbazide hydrochloride ($\text{NH}_2\text{CONHNH}_2\cdot\text{HCl}$) and 1.5 g. of crystallised sodium acetate in 10 ml. of water in a test-tube. Add 1 ml. of acetone, close the tube with a cork and shake vigorously. Allow the mixture to stand, with occasional vigorous shaking, for 10 minutes: it is advantageous to cool in ice. Filter the crystals, wash with a little cold water, and recrystallise from water or dilute alcohol. The m.p. of acetone semicarbazone is 187° .

CRYSTALLINE DERIVATIVES OF ALIPHATIC ALDEHYDES AND KETONES

1. 2 : 4-Dinitrophenylhydrazones. Small quantities may be prepared with the class reagent described in Section XI,7,4. The following procedure is generally more satisfactory.

Suspend 0.25 g. of 2 : 4-dinitrophenylhydrazine in 5 ml. of methanol and add 0.4–0.5 ml. of concentrated sulphuric acid cautiously. Filter the warm solution and add a solution of 0.1–0.2 g. of the carbonyl compound in a small volume of methanol or of ether. If no solid separates within 10 minutes, dilute the solution carefully with 2*N* sulphuric acid. Collect the solid by suction filtration and wash it with a little methanol. Recrystallise the derivative from alcohol, dilute alcohol, alcohol with ethyl acetate or chloroform or acetone, acetic acid, dioxan, nitromethane, nitrobenzene or xylene.

The following reagent, a 0.25*M* solution of 2 : 4-dinitrophenylhydrazine, may be used for the preparation of derivatives of keto compounds. Dissolve 25 g. of 2 : 4-dinitrophenylhydrazine in 300 ml. of 85 per cent. phosphoric acid in a 600 ml. beaker on a steam bath, dilute the solution with 200 ml. of 95 per cent. ethanol, allow to stand, and filter through a sintered glass funnel. It must be emphasised that *this reagent is not suitable for the routine detection of carbonyl compounds* since it also gives a precipitate in the cold with certain amines, esters and other compounds: if, however, a dilute solution of the ketonic compound in ethanol is treated with a few drops of the reagent and the mixture diluted with water and heated, the precipitate produced with non-ketonic compounds generally dissolves.

For the preparation of 2 : 4-dinitrophenylhydrazones, dissolve the carbonyl compound (say, 0.5 g.) in 5 ml. of ethanol and add the calculated volume of the reagent. If a precipitate does not form immediately, dilute with a little water. Collect the derivative and recrystallise it as above.

2. Semicarbazones. Dissolve 1 g. of semicarbazide hydrochloride and 1.5 g. of crystallised sodium acetate in 8–10 ml. of water add 0.5–1 g. of the aldehyde or ketone and shake. If the mixture is turbid, add alcohol (acetone-free) or water until a clear solution is obtained; shake the mixture for a few minutes and allow to stand. Usually the semicarbazone crystallises from the cold solution on standing, the time varying from a few minutes to several hours. The reaction may be accelerated,

if necessary, by warming the mixture on a water bath for a few minutes and then cooling in ice water. Filter off the crystals, wash with a little cold water, and recrystallise from water or from methyl or ethyl alcohol either alone or diluted with water.

Note.

When semicarbazide is heated in the absence of a carbonyl compound for long periods, condensation to **biurea**, $\text{NH}_2\text{CONHNHCONH}_2$, m.p. 247–250° (decomp.), may result; occasionally this substance may be produced in the normal preparation of a semicarbazone that forms slowly. Biurea is sparingly soluble in alcohol and soluble in hot water, whereas semicarbazones with melting points in the same range are insoluble in water: this enables it to be readily distinguished from a semicarbazone.

3. Oximes. The method given for semicarbazones (see 2) may be employed: use 1 g. of hydroxylamine hydrochloride, 2 g. of crystallised sodium acetate and 0.5 g. of the aldehyde or ketone. It is usually advisable to warm on a water bath for 10 minutes.

For water-insoluble aldehydes or ketones, the following alternative procedure may be used. Reflux a mixture of 0.5 g. of the aldehyde or ketone, 0.5 g. of hydroxylamine hydrochloride, 5 ml. of ethanol and 0.5 ml. of pyridine on a water bath for 15–60 minutes. Remove the alcohol either by distillation (water bath) or by evaporation of the hot solution in a stream of air (water pump). Add 5 ml. of water to the cooled residue, cool in an ice bath and stir until the oxime crystallises. Filter off the solid, wash it with a little water and dry. Recrystallise from alcohol (95 per cent. or more dilute), benzene, or benzene-light petroleum (b.p. 60–80°).

4. Benzylidene derivatives. Compounds containing the ketomethylene group ($-\text{CH}_2\text{CO}$) react with benzaldehyde to yield benzylidene derivatives:

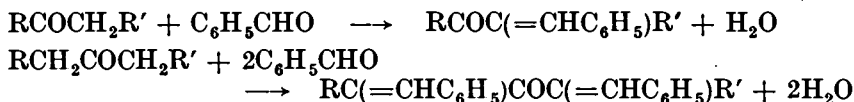

Cyclic ketones yield dibenzylidene derivatives.

Dissolve 1 g. of the ketomethylene compound and 1.1 g. or 2.2 g. of pure benzaldehyde (according as to whether the compound may be regarded as $\text{RCOCH}_2\text{R}'$ or as $\text{RCH}_2\text{COCH}_2\text{R}'$) in about 10 ml. of rectified (or methylated) spirit, add 0.5 ml. of 5*N*-sodium hydroxide solution, shake and allow the mixture to stand for about an hour at room temperature. The benzylidene derivative usually crystallises out or will do so upon "scratching" the walls of the vessel with a glass rod. Filter off the solid, wash it with a little cold alcohol, and recrystallise it from absolute alcohol (or absolute industrial spirit).

Experimental details for the preparation of oximes, phenylhydrazones and *p*-nitrophenylhydrazones will be found under *Aromatic Aldehydes*, Section IV, 135, 4–6.

Table III, 74 lists the melting points of derivatives of some selected aliphatic and cycloaliphatic ketones.

TABLE III, 74.

ALIPHATIC KETONES

Ketone	B.P.	M.P.	2 : 4-Dinitro-phenyl-hydrazone	Semicarbazone	Benzal Derivative	Phenyl-hydrazone	<i>p</i> -Nitro-phenyl-hydrazone	Other Derivatives
Acetone	56°	—	128°	190°	112°	42°	149°	Oxime, 59°
Diethyl ketone	102	—	156	139	—	—	144	Oxime, 69
Di- <i>n</i> -propyl ketone	144	—	75	133	—	—	—	—
Di- <i>iso</i> -propyl ketone	124	—	88	160	—	—	—	Oxime, 34
Di- <i>n</i> -butyl ketone	188	—	—	90	—	—	—	—
Di- <i>iso</i> -butyl ketone	168	—	92	122	—	—	—	—
Di- <i>n</i> -amyl ketone	223	14°	—	—	—	—	—	d_4^{20} 0.825, n_D^{20} 1.429
Di- <i>n</i> -hexyl ketone	255	33	—	—	—	—	97	—
Methyl ethyl ketone	80	—	115	146	—	—	129	—
Methyl <i>n</i> -propyl ketone	102	—	144	112	—	—	117	Oxime, 58
Methyl <i>iso</i> -propyl ketone	94	—	120	114	—	—	109	—
Methyl <i>n</i> -butyl ketone	128	—	107	125	—	—	88	Oxime, 49
Methyl <i>iso</i> -butyl ketone	117	—	95	132	—	—	79	Oxime, 58
Methyl <i>n</i> -amyl ketone	151	—	89	123	—	—	—	—
Methyl <i>n</i> -hexyl ketone	173	—	58	123	—	—	93	—
Chloroacetone	119	—	125	150	—	—	—	Oxime, 71
Acetol (hydroxyacetone)	146	—	129	196	—	103	—	—
Acetoin (methylacetylcarbinol)	145	—	318	185	—	—	—	—
<i>cyclo</i> Pentanone	131	—	146	210	190	55	154	Oxime, 57
<i>cyclo</i> Hexanone	156	—	162	167	118	81	147	Oxime, 91
<i>cyclo</i> Heptanone	180	—	148	162	108	—	—	—
2-Methyl <i>cyclopentanone</i>	139	—	—	184	—	—	—	—
2-Methyl <i>cyclohexanone</i>	165	—	137	197	—	—	132	Oxime, 43
3-Methyl <i>cyclohexanone</i>	170	—	155	191	122	94	119	—
4-Methyl <i>cyclohexanone</i>	171	—	134	203	99	110	128	Oxime, 39

TABLE III,74.

ALIPHATIC KETONES—continued

74]

Ketone	B.P.	M.P.	2 : 4 Dinitro- phenyl- hydrazone	Semicar- bazone	Benzal Derivative	Phenyl- hydrazone	<i>p</i> -Nitro- phenyl- hydrazone	Other Derivatives
Diacetone alcohol	166°	—	203°	—	—	—	209°	Oxime, 58°
Mesityl oxide	130	—	203	164°	—	142°	134	Oxime, 49
Pinacolone	106	—	125	158	41°	—	—	Oxime, 78
Phorone	199	28°	118	221	—	—	—	Oxime, 48
<i>iso</i> -phorone	215	—	130	199	77	68	—	Oxime, 79
Acetylacetone	139	—	209	—	—	—	—	Oxime, 149
Diacetyl	88	—	315 (Di)	279 (Di)	53	243 (Di)	230	Dioxime, 234
Acetonyl acetone	194	—	257 (Di)	220	—	120 (Di)	—	Dioxime, 137
Methyl acetoacetate	170	—	—	152	—	—	—	d_4^{20} 1.077, n_D^{20} 1.420
Ethyl acetoacetate	181	—	93	133	—	—	—	d_4^{20} 1.025, n_D^{20} 1.420
Methyl laevulinate	196	—	142	143	—	96	—	d_4^{20} 1.050, n_D^{20} 1.423
Ethyl laevulinate	206	—	102	148	—	104	—	d_4^{20} 1.011, n_D^{20} 1.423
Furoin	—	135	217	—	—	81	—	Oxime, 161
Furil	—	165	—	—	—	184	199	Dioxime, 100
<i>d</i> -Camphor	209	179	177	238	98	233	217	Oxime, 119
<i>d</i> -Carvone	230	—	191	163	—	110	175	Oxime, 73
Pulegone	224	—	147	174	—	—	—	Oxime, 119
β -Thujone	202	—	114	174	—	—	—	Oxime, 55
<i>l</i> -Menthone	209	—	146	189	—	53	—	Oxime, 59
<i>d</i> -Fenchone	193	—	140	184	—	—	—	Oxime, 167
α -Ionone	130°/13	—	151	143(108)	—	—	113	Oxime, 90
β -Ionone	139°/18	—	128	149	—	—	173	—

ALIPHATIC COMPOUNDS

347

III,75.

ACETONE CYANOHYDRIN

Equip a 1-litre three-necked flask with a mechanical stirrer, a separatory funnel and a thermometer. Place a solution of 47 g. of sodium cyanide (or 62 g. of potassium cyanide) in 200 ml. of water in the flask, and introduce 58 g. (73.5 ml.) of pure acetone. Add slowly from the separatory funnel, with constant stirring, 334 g. (275 ml.) of 30 per cent. sulphuric acid by weight. Do not allow the temperature to rise above 15–20°; add crushed ice, if necessary, to the mixture by momentarily removing the thermometer. After all the acid has been added continue the stirring for 15 minutes. Extract the reaction mixture with three 50 ml. portions of ether, dry the ethereal extracts with anhydrous sodium or magnesium sulphate, remove most of the ether on a water bath and distil the residue rapidly under diminished pressure. The acetone cyanohydrin passes over at 80–82°/15 mm. The yield is 62 g.

III,76.

n-HEPTALDOXIME

Fit a 1-litre three-necked flask with an efficient mechanical stirrer, a double surface condenser and a thermometer. Place 115 g. (141 ml.) of *n*-heptaldehyde (1) and a solution of 87 g. of hydroxylamine hydrochloride in 150 ml. of water in the flask, and stir the mixture vigorously (2). Introduce, through a separatory funnel fitted into the top of the reflux condenser by means of a grooved cork, a solution of 67 g. of anhydrous sodium carbonate in 250 ml. of water at such a rate that the temperature of the reaction mixture does not rise above 45°. Continue the stirring for 1 hour at room temperature. Separate the upper layer and wash the oil with two 25 ml. portions of water; dry with anhydrous sodium or magnesium sulphate. Distil from a Claisen flask with fractionating side arm (Figs. II, 24, 2–5) using an oil bath. A small fraction of low boiling point (containing *n*-heptonitrile and *n*-heptaldoxime) passes over first, and as soon as the temperature is constant the *n*-heptaldoxime is collected (e.g., at 103–107°/6 mm.); the temperature of the oil bath is maintained at about 30° above the boiling point of the liquid. The yield is about 110 g., and the liquid slowly solidifies on cooling and melts at 44–46°; it is sufficiently pure for conversion into *n*-heptylamine (Section III, 121). If required pure, the heptaldoxime may be recrystallised from 60 per cent. ethyl alcohol (25 g. of solid to 70 ml. of solvent) and then melts at 53–55° (the m.p. depends somewhat upon the rate of heating).

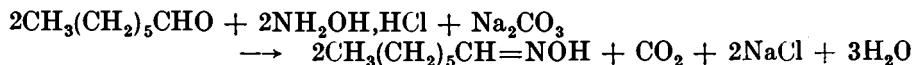

Notes.

- (1) The oenanthol should be dried and redistilled: b.p. 150–156° or 54–59°/16 mm.
- (2) The solution may be rendered homogeneous by the addition of ethyl alcohol, but the yield appears to be slightly diminished and more high boiling point material is produced.

COGNATE PREPARATION

Methyl *n*-hexyl ketoxime. From methyl *n*-hexyl ketone (Section III, 71) in 90 per cent. yield. B.p. 106–108°/12 mm.

III,77. PINACOL AND PINACOLONE

Acetone is reduced by a amalgamated magnesium largely to a bimolecular reduction product, tetramethylethylene glycol or pinacol ($(\text{CH}_3)_2\text{C}(\text{OH})\text{C}(\text{OH})(\text{CH}_3)_2$); some *isopropyl* alcohol is also formed :

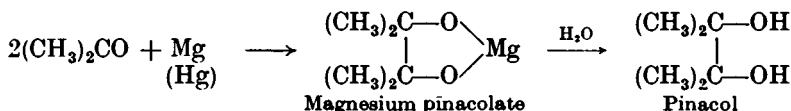

Pinacol possesses the unusual property of forming a crystalline hexahydrate, m.p. 45° , and the pinacol is separated in this form from the unreacted acetone and the *isopropyl* alcohol. The magnesium is conveniently amalgamated by dissolving mercuric chloride in a portion of the acetone; mercury is then liberated by the reaction :

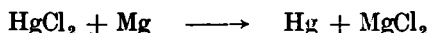

The anhydrous compound, pinacol, is a liquid; it may be prepared from the hydrate by azeotropic distillation with benzene.

Pinacol upon dehydration with acid catalysts (*e.g.*, by distillation from 6*N* sulphuric acid or upon refluxing for 3–4 hours with 50 per cent. phosphoric acid or hydrated oxalic acid) is transformed into methyl *tert.*-butyl ketone or pinacolone :

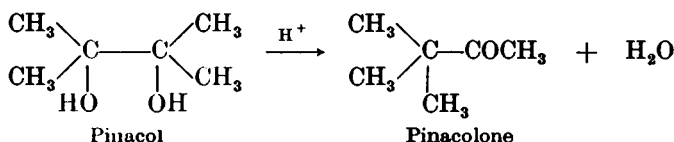

This arrangement, known as the pinacol-pinacolone rearrangement, is general for 1:2-glycols $\text{RR}'\text{C}(\text{OH})\cdot\text{C}(\text{OH})\text{R}''\text{R}'''$. The striking feature of the change is the shifting of a methyl group from one of the glycol carbon atoms to the other. This interesting transformation is believed to proceed as follows. The glycol reacts with a proton to give the oxonium ion (I); elimination of water affords the carbonium ion (II); the carbonium ion may undergo a rearrangement involving a 1:2 shift of the methyl group with its electron pair (carbanion) to give the new carbonium ion (III); the latter loses a proton to give the product of the rearrangement, pinacolone (IV).

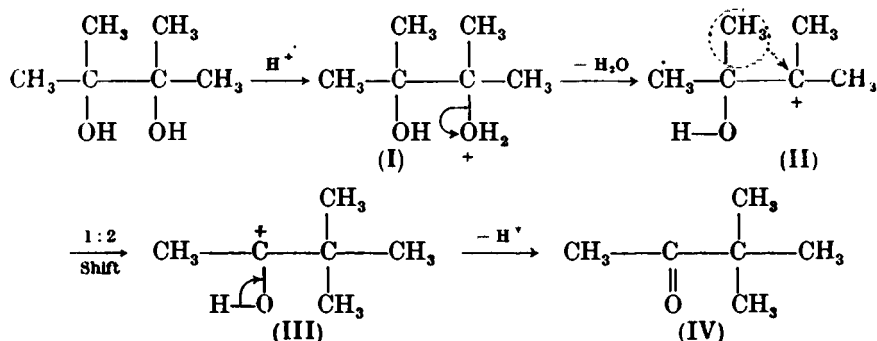

It must be pointed out that transformations of this type do not take place stepwise, as indicated above; the ultimate change is equivalent to the simultaneous separation of the hydroxyl group and attachment of the migrating

alkyl anion to the rear of the carbon atom from which the hydroxyl group is removed, this carbon atom undergoing a Walden inversion.

The pinacolone may be employed for the preparation of trimethylacetic acid (pivalic acid) by oxidation with sodium hypobromite solution :

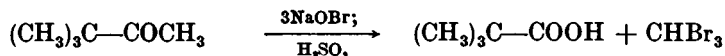

Pinacol hydrate. Place into a dry 1-litre round-bottomed flask, fitted with a separatory funnel and an efficient double surface condenser (Fig. III, 71, 1) and carrying cotton wool (or calcium chloride) guard tubes 20 g. of dry magnesium turnings and 200 ml. of anhydrous benzene. Place a solution of 22.5 g. of mercuric chloride in 100 g. (127 ml.) of dry A.R. acetone in the separatory funnel and run in about one quarter of this solution ; if the reaction does not commence in a few minutes, as indicated by a vigorous ebullition, warm the flask on a water bath and be ready to cool the flask in running water to moderate the reaction. Once the reaction has started, no further heating is required. Add the remainder of the solution at such a rate that the reaction is as vigorous as possible and yet under control. When all the mercuric chloride solution has been run in and whilst the mixture is still refluxing, add a mixture of 50 g. (63.5 ml.) of dry A.R. acetone and 50 ml. of dry benzene. When the reaction slows down, warm the flask on a water bath for 1-2 hours. During this period the magnesium pinacolate swells up and nearly fills the flask. Cool slightly, disconnect the flask from the condenser and shake until the solid mass is well broken up : it may be necessary to use a stirrer. Attach the condenser and reflux for about 1 hour, or until the magnesium has disappeared.

Now add 50 ml. of water through the separatory funnel and heat again on the water bath for 1 hour with occasional shaking. This converts the magnesium pinacolate into pinacol (soluble in benzene) and a precipitate of magnesium hydroxide. Allow the reaction mixture to cool to 50° and filter at the pump. Return the solid to the flask and reflux with a fresh 125 ml. portion of benzene for 10 minutes in order to extract any remaining pinacol ; filter and combine with the first filtrate. Distil the combined extracts to one half the original volume in order to remove the acetone : treat the residual benzene solution with 60 ml. of water and cool in an ice bath, or to at least 10-15°, with good stirring. After 30-60 minutes, filter the pinacol hydrate which has separated at the pump and wash it with benzene to remove small quantities of mercury compound present as impurities : alternatively, centrifuge the mixture in a basket centrifuge. Dry the pinacol hydrate by exposure to air at the laboratory temperature. The yield is 90 g. ; m.p. 46-57°. This product is sufficiently pure for most purposes. The crude pinacol hydrate may be purified by dissolving it in an equal weight of boiling water, treating with a little decolourising carbon if necessary, filtering the hot solution and cooling in ice ; the recovery is over 95 per cent.

Pinacol (tetramethylethyleneglycol). Pinacol hydrate may be dehydrated in the following manner (compare Section II, 39). Mix 100 g. of pinacol hydrate with 200 ml. of benzene and distil ; a mixture of water and benzene passes over. Separate the lower layer and return the upper layer

of benzene to the distilling flask. Repeat the process until the benzene distillate is clear. Finally distil the anhydrous pinacol and collect the fraction boiling at 169–173° (50 g.). The pure pinacol has m.p. 43°, but on exposure to moist air the m.p. gradually falls to 29–30° and then rises to 45–46° when hydration to the hexahydrate is complete.

Pinacolone. In a 500 ml. round-bottomed flask carrying a dropping funnel and a connection to a condenser set for distillation, place 50 g. of pinacol hydrate and 130 ml. of 6*N* sulphuric acid. Distil the mixture until the upper layer of the distillate no longer increases in volume (15–20 minutes). Separate the pinacolone layer from the water and return the latter to the reaction flask. Then add 12 ml. of concentrated sulphuric acid to the water, followed by a second 50 g. portion of pinacol hydrate. Repeat the distillation. Repeat the process twice more until 200 g. of pinacol hydrate have been used.

Dry the combined pinacolone fractions over anhydrous magnesium sulphate and distil. Collect the pinacolone at 103–107°. The yield is 62 g.

Trimethylacetic acid. In a 2.5 litre three-necked flask, fitted with a thermometer, a mechanical stirrer and dropping funnel, place a solution of 165 g. of sodium hydroxide in 1400 ml. of water. Cool to 0° in an ice-salt bath. Add 240 g. (77 ml.) of bromine with vigorous stirring at such a rate as to keep the temperature below 10° (15–20 minutes). Cool again to 0°, introduce 50 g. of pinacolone, keeping the temperature below 10°. After the solution is decolourised (*ca.* 1 hour), continue the stirring for 3 hours at room temperature. Replace the thermometer by a “knee” tube connected to a condenser for distillation; separate the bromoform and carbon tetrabromide (if present) by steam distillation; heat the flask with a powerful (*e.g.*, a Fisher) burner. Remove the burner, cool the reaction mixture to 50°, and add 200 ml. of concentrated sulphuric acid cautiously through the dropping funnel. Heat the flask again; the trimethylacetic acid passes over with about 200 ml. of water. When all the trimethylacetic acid (35–40 ml.) has distilled, a liquid heavier than water (possibly brominated pinacolone) begins to pass over. Stop the distillation at this point, separate the trimethylacetic acid from the aqueous layer, and dry it by distillation with 25 ml. of benzene (the latter carries over all the water) or with anhydrous calcium sulphate. Distil under reduced pressure and collect the trimethylacetic acid 75°–80°/20 mm. The yield is 33 g., m.p. 34–35°.

III,78.

DIACETONE ALCOHOL

Acetaldehyde (and other aldehydes containing at least one hydrogen atom in the α -position) when treated with a small quantity of dilute sodium hydroxide solution or other basic catalyst gives a good yield of aldol (β -hydroxy-*n*-butyraldehyde) (I), which readily loses water, either by heating the isolated aldol alone or with a trace of mineral acid, to form crotonaldehyde (II) :

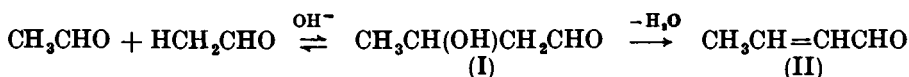

With concentrated alkali, a resin is formed from repeated aldol condensations between aldol, crotonaldehyde and acetaldehyde. A similar condensation occurs with acetone (b.p. 56°), but the equilibrium mixture contains only a few per cent. of diacetone alcohol (III), b.p. 166° :

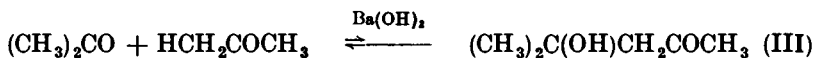

However, by using a special technique (boiling flask, containing acetone, attached to a Soxhlet apparatus filled with barium hydroxide, surmounted by a double surface condenser) and taking advantage of the fact that the dissociation of the diacetone alcohol to acetone proceeds extremely slowly in the absence of barium hydroxide, it is possible to prepare compound (III) satisfactorily. Solid barium hydroxide acts as a catalyst in the reaction; its solubility in acetone is very small. The liquid returning to the flask, heated on a water bath, contains the alcohol in small concentration; this remains in the boiling flask and only the much more volatile acetone passes into the Soxhlet apparatus and is recycled. After about 4 days the concentration of (III) in the boiling flask is 70–80 per cent., and can be easily separated from the acetone by fractional distillation.

Fit a 1-litre round-bottomed flask with a rubber stopper carrying a large Soxhlet extractor (Fig. II, 44, 4), and attach an efficient double surface condenser to the latter. Place 595 g. (750 ml.) of commercial acetone, preferably dried over anhydrous potassium carbonate, and a few fragments of porous porcelain in the flask. Insert two large paper thimbles in the Soxhlet apparatus, one above the other; fill each about three-quarters full with barium hydroxide and fill the remainder of the space with glass wool (1). Heat the flask on a water bath or steam bath so that the acetone refluxes back into the extractor rather rapidly. Continue the heating until the acetone no longer refluxes when the flask is almost completely immersed in the boiling water bath (72–120 hours). The refluxing may be interrupted at any time for as long as desired without influencing the preparation. Equip the flask with a fractionating column attached to an efficient double surface condenser set for downward distillation. Immerse the flask in an oil bath and raise the temperature gradually to 125°; maintain this temperature as long as acetone distils over. The recovery of acetone is complete when the temperature at the top of the column is about 70°. Distil the residue (2) from a Claisen flask under diminished pressure (3); a little acetone passes over first, followed by the diacetone alcohol at 71–74°/23 mm. (or 62–64°/13 mm.). The yield is 450 g.

Notes.

(1) If the outlet of the siphon tube at the bottom of the Soxhlet apparatus is well plugged with cotton wool so that no finely-divided barium hydroxide can pass into the flask, the barium hydroxide may be placed directly into the extractor until the latter is three-quarters full; the remaining space is filled with glass wool.

If crystallised barium hydroxide ($\text{Ba}(\text{OH})_2 \cdot 8\text{H}_2\text{O}$) is employed, this becomes dehydrated after one run; the anhydrous compound is just as satisfactory and may be used repeatedly.

(2) The residual liquid contains about 95 per cent. of diacetone alcohol and is satisfactory for the preparation of mesityl oxide (Section III, 79).

(3) Diacetone alcohol partially decomposes when distilled under normal pressure.

III,79.

MESITYL OXIDE

Diacetone alcohol is readily dehydrated by adding a very small quantity of iodine as catalyst and distilling slowly :

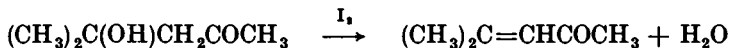

The product, an $\alpha\beta$ -unsaturated ketone, is known as mesityl oxide.

Fit a 750 ml. round-bottomed flask with a fractionating column attached to a condenser set for downward distillation. Place 500 g. of diacetone alcohol (the crude product is quite satisfactory), 0.1 g. of iodine and a few fragments of porous porcelain in the flask. Distil slowly with a small free flame (best in an air bath) and collect the following fractions : (a) 56–80° (acetone and a little mesityl oxide) ; (b) 80–126° (two layers, water and mesityl oxide) ; and (c) 126–131° (mesityl oxide). Whilst fraction (c) is distilling, separate the water from fraction (b), dry with anhydrous potassium carbonate or anhydrous magnesium sulphate, and fractionate from a small flask ; collect the mesityl oxide at 126–131°. The yield is about 400 g.

SATURATED ALIPHATIC MONOBASIC ACIDS

Saturated aliphatic acids may be prepared :—

1. By oxidation of primary alcohols with alkaline potassium permanganate solution or with a dichromate and dilute sulphuric acid, for example :

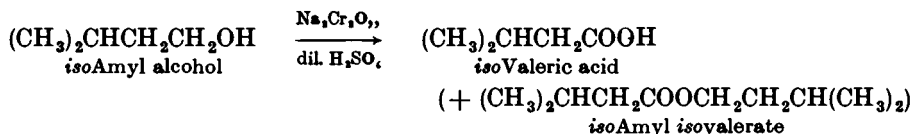
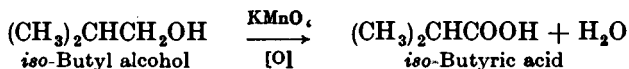

The oxidation with excess of dichromate and dilute sulphuric acid is not always satisfactory for alcohols higher than *n*-propyl because of the attendant production of appreciable amounts of esters: indeed by using a fairly high concentration of sulphuric acid, good yields of esters are obtained since esterification takes place at once, even in the cold, as long as an excess of alcohol is present, for example :

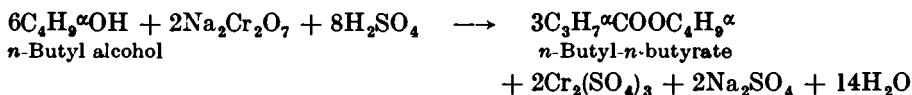

2. By oxidation of aldehydes with potassium permanganate solution, for example :

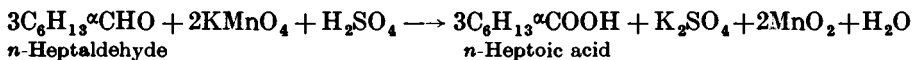

3. By hydrolysis of alkyl cyanides (or nitriles) * with alkali hydroxide solutions, for example :

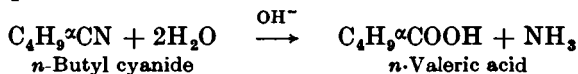

4. By the action of carbon dioxide upon a suitable Grignard reagent, for example :

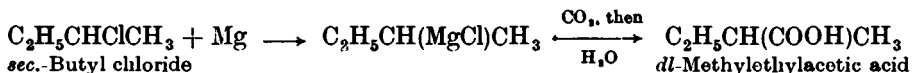

5. By hydrolysis of substituted malonic esters with 50 per cent. potassium hydroxide, followed by decarboxylation of the resulting malonic acid by heating above the m.p. or, better, by rendering the aqueous solution of the potassium salt of the dibasic acid strongly acid and refluxing the mixture, for example :

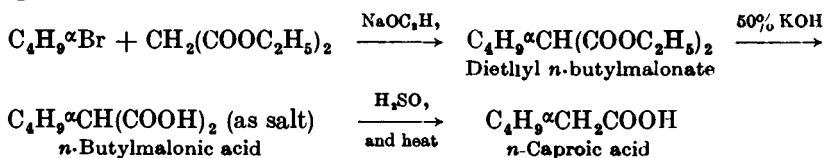

* These are readily available from the interaction of alkyl halides with sodium or potassium cyanide in aqueous-alcoholic solution (compare Section III, 113).

III,80.

isoBUTYRIC ACID

Place a mixture of 50 g. of *isobutyl* alcohol and a solution of 15 g. of sodium carbonate in 150 ml. of water in a 4-litre round-bottomed flask. Add a solution of 140 g. of potassium permanganate in 2750 ml. of water, with vigorous stirring, during 3-4 hours. Continue the stirring and cool the mixture to 4-5° by immersion in a bath of ice water. Allow the reaction mixture to attain room temperature gradually. After 12 hours, filter off (or, preferably, centrifuge) the precipitated manganese dioxide, evaporate the filtrate on a water bath to about 150 ml., and then cool. Cover the solution with a layer of ether and acidify with dilute sulphuric acid. Separate the ether layer and extract the aqueous layer two or three times with 50 ml. portions of ether. Dry the combined ethereal extracts over anhydrous sodium or magnesium sulphate, remove the ether on a water bath, and fractionate the residual liquid. Collect the *iso*-butyric acid at 153-155°. The yield is 45 g.

n-Valeric acid may be similarly prepared utilising the following quantities: 75 g. *n*-amyl alcohol (Eastman Kodak product, redistilled), 19 g. of sodium carbonate in 190 ml. of water, 220 g. of potassium permanganate in 4,500 ml. of water. Use a 5- or 6-litre flask. Concentrate the filtered aqueous solution either by evaporation on a water bath or by distillation under reduced pressure. Isolate the *n*-valeric acid as detailed above for *isobutyric* acid. The yield is 55 g., b.p. 182-185°.

COGNATE PREPARATIONS

***iso*Valeric acid.** Prepare dilute sulphuric acid by adding 140 ml. of concentrated sulphuric acid cautiously and with stirring to 85 ml. of water; cool and add 80 g. (99 ml.) of redistilled *iso*amyl alcohol. Place a solution of 200 g. of crystallised sodium dichromate in 400 ml. of water in a 1-litre (or 1.5 litre) round-bottomed flask and attach an efficient reflux condenser. Add the sulphuric acid solution of the *iso*amyl alcohol in *small* portions through the top of the condenser; * shake the apparatus vigorously after each addition. No heating is required as the heat of the reaction will suffice to keep the mixture hot. It is important to shake the flask well immediately after each addition and not to add a further portion of alcohol until the previous one has reacted; if the reaction should become violent, immerse the flask momentarily in ice water. The addition occupies 2-2.5 hours. When all the *iso*amyl alcohol has been introduced, reflux the mixture gently for 30 minutes, and then allow to cool. Arrange the flask for distillation (compare Fig. II, 13, 3, but with the thermometer omitted) and collect about 350 ml. of distillate. The latter consists of a mixture of water, *isovaleric* acid and *iso*amyl *isovalerate*. Add 30 g. of potassium (*not* sodium) hydroxide pellets to the distillate and shake until dissolved. Transfer to a separatory funnel and remove the upper layer of ester (16 g.). Treat the aqueous layer contained in a beaker with 30 ml. of dilute sulphuric acid (1 : 1 by volume) and extract the liberated *isovaleric* acid with two

* If preferred, a 1.5 litre three-necked flask, equipped with a dropping funnel, mechanical stirrer and reflux condenser, may be used and the obvious modifications of technique introduced. This procedure is recommended.

50 ml. portions of carbon tetrachloride. Keep the carbon tetrachloride extract (A).

To obtain a maximum yield of the acid it is necessary to hydrolyse the by-product, *isoamyl isovalerate*: this is most economically effected with methyl alcoholic sodium hydroxide. Place a mixture of 20 g. of sodium hydroxide pellets, 25 ml. of water and 225 ml. of methyl alcohol in a 500 ml. round-bottomed flask fitted with a reflux (double surface) condenser, warm until the sodium hydroxide dissolves, add the ester layer and reflux the mixture for a period of 15 minutes. Rearrange the flask for distillation (Fig. II, 13, 3) and distil off the methyl alcohol until the residue becomes pasty. Then add about 200 ml. of water and continue the distillation until the temperature reaches 98–100°. Pour the residue in the flask, consisting of an aqueous solution of sodium *isovalerate*, into a 600 ml. beaker and add sufficient water to dissolve any solid which separates. Add slowly, with stirring, a solution of 15 ml. of concentrated sulphuric acid in 50 ml. of water, and extract the liberated acid with 25 ml. of carbon tetrachloride. Combine this extract with extract (A), dry with a little anhydrous magnesium or calcium sulphate, and distil off the carbon tetrachloride (Fig. II, 13, 4; 150 ml. distilling or Claisen flask), and then distil the residue. Collect the *isovaleric acid* 172–176°. The yield is 56 g.

isoButyric acid. This acid may also be prepared, although in smaller yield, by the oxidation of *isobutyl alcohol* with acidified dichromate solution. Place a solution of 200 g. of crystallised sodium dichromate in 400 ml. of water in a 1.5-litre three-necked flask equipped with a dropping funnel, mechanical stirrer and reflux condenser. Dissolve 67.5 g. (84 ml.) of redistilled *isobutyl alcohol* in cold dilute sulphuric acid prepared from 140 ml. of concentrated sulphuric acid and 85 ml. of water; pour the solution into the dropping funnel. Add the sulphuric acid solution of the *isobutyl alcohol* to the stirred sodium dichromate solution at such a rate that the exothermic reaction is under control (1.5–2 hours). Reflux the mixture for 30 minutes and then distil; collect about 400 ml. of distillate. Saturate the distillate with salt, and extract it with three 75 ml. portions of ether. Shake the combined ethereal extracts with 10 per cent. sodium hydroxide solution until the aqueous solution remains alkaline. Acidify the aqueous extract with dilute sulphuric acid, saturate with salt, and extract with three 50 ml. portions of ether. Dry the combined ethereal solutions resulting from the last extraction with anhydrous magnesium sulphate, remove the ether, and distil the residue (air bath). The yield of pure *isobutyric acid*, b.p. 154°, is 30 g.

III,81.

n-HEPTOIC ACID *

Place 700 ml. of water and 161 g. (87.5 ml.) of concentrated sulphuric acid in a 1500 ml. flask. Introduce a mechanical stirrer into the flask and cool the latter in an ice bath. When the temperature is below 15°, add 85.5 g. (105 ml.) of redistilled *n*-heptaldehyde (b.p. 151–156° or

* Also termed *n*-heptanoic acid, *n*-heptylic acid, and *ocmanthic acid*.

40–42°/10 mm.), followed by 85 g. of potassium permanganate in 10–15 g. portions. Add the permanganate at such a rate that the temperature does not rise above 20° (*ca.* 1 hour). Pass sulphur dioxide into the solution (or add sodium bisulphite) until the precipitated manganese dioxide just dissolves and the solution is clear. Separate the oily layer, wash it with water, and then dry with anhydrous sodium or magnesium sulphate. Distil through a short well-lagged fractionating column, and collect the crude *n*-heptoic acid at 215–224° (75 g.). Purify the crude acid by dissolving it in a solution of 35 g. of sodium hydroxide in 175 ml. of water, and steam distil from a 500 ml. flask until a test portion is free from oil. Cool the solution remaining in the flask to room temperature and acidify cautiously with 96 ml. of concentrated hydrochloric acid. Separate the liberated oenanthic acid, dry with anhydrous sodium or magnesium sulphate, and fractionate as before. Collect the pure *n*-heptoic acid (65 g.) at 218–222°.

III,82.

n-BUTYL *n*-BUTYRATE

Fit a 1-litre three-necked flask with a mechanical stirrer, a thermometer and a separatory funnel. Place a cold solution of 120 ml. of concentrated sulphuric acid in 120 ml. of water, together with 120 g. (148 ml.) of *n*-butyl alcohol, in the flask and cool in a freezing mixture of ice and salt. Add a solution of 120 g. of crystallised sodium dichromate (or 175 g. of the moist technical hydrated salt) in 200 ml. of water from the separatory funnel to the vigorously stirred mixture at such a rate that the temperature does not rise above 20°. When most of the dichromate solution has been added, the reaction mixture becomes viscous and the stirring is rendered inefficient: allow the temperature to rise to 35° to accelerate the oxidation (above this temperature *n*-butylaldehyde, b.p. 74°, may be lost). Dilute the green, syrupy emulsion with an equal volume of water, and allow the mixture to stand in order that the separation of the oil may be as complete as possible (about 110 ml. containing the ester plus unchanged butyl alcohol, a little butylaldehyde and a little butyric acid). Wash the oil three times with water, dry it with anhydrous sodium or magnesium sulphate and distil slowly through an efficient, adequately-lagged fractionating column. Collect the fraction boiling at 150–170° (*ca.* 85 ml.) and wash it with five 7·5 ml. portions of 60 per cent. sulphuric acid (sp. gr. 1·5) (1), then with dilute sodium hydroxide solution until free from acid, and finally with water until neutral. Dry as before and fractionate. Collect the *n*-butyl *n*-butyrate at 163–167°. The yield is 50 g.

Note.

(1) *n*-Butyl alcohol is miscible with 60 per cent. sulphuric acid, but not with the ester.

III,83. *n*-VALERIC ACID (*Hydrolysis of n-Butyl Cyanide*)

Place 100 g. (105 ml.) of *n*-butyl cyanide (Section III,113) and a solution of 92 g. of pure sodium hydroxide in 260 ml. of water in a 1500 ml. round-bottomed flask, attach a double surface condenser, and reflux

over a wire gauze until the butyl cyanide layer disappears (5-10 hours). Add through the condenser 100 ml. of water, then slowly, and with external cooling, 125 ml. of 50 per cent. (by volume) sulphuric acid. Separate the upper layer of *n*-valeric acid (it may be necessary to filter first from any solid present), and dry it with anhydrous magnesium or calcium sulphate. Distil from a Claisen flask and collect the *n*-valeric acid at 183-185° (mainly 184°). The yield is 82 g. A further 5 g. of acid may be obtained by extracting the strongly acidified aqueous layer with ether (or benzene), combining the ethereal extracts with the low and high boiling point fractions of the previous distillation, removing the ether on a water bath, and distilling from a small flask.

III,84.

dl-METHYLETHYLACETIC ACID

(Carbonation of a Grignard Reagent)

Fit a 1-litre three-necked flask with a mechanical stirrer, a double surface condenser and a separatory funnel (Fig. II, 7, 11, *a*), and provide both the condenser and funnel with cotton wool (or calcium chloride) guard tubes. Place 13.4 g. of dry magnesium turnings, 50 ml. of sodium-dried ether and a crystal of iodine in the flask: introduce 3 g. (3.5 ml.) of dry *sec.*-butyl chloride (Section III,29) (1). Warm the flask on a water bath or electric hot plate to start the reaction, and then allow it to proceed by its own heat for 20 minutes. Add a further 75 ml. of anhydrous ether, followed by a solution of 43 g. (49 ml.) of dry *sec.*-butyl chloride in 275 ml. of anhydrous ether over a period of 20-25 minutes. If the reaction becomes too vigorous, cool the flask momentarily with cold water. The refluxing will continue for about 20 minutes after the addition of the halide solution owing to the heat of the reaction. When this subsides, reflux the mixture for 1 hour. Cool the flask in a mixture of ice and salt to -12° (2) and add a further 100 ml. of anhydrous ether. Replace the separatory funnel by a tube 10 mm. in diameter with side tube (as in Fig. II, 7, 12, *b*): insert a thermometer, held in position by a rubber sleeve, into the upper end. Arrange the thermometer to dip into the reaction mixture and the lower end of the wide tube to be about 6 cm. *above* the level of the liquid (this avoids the troublesome clogging of the tube with solid at a later stage); attach the side tube to a cylinder of carbon dioxide (3). Pass carbon dioxide into the flask at such a rate that the temperature does not rise above -5° when the mixture is rapidly stirred. After 2-2.5 hours, the temperature does not rise upon increasing the flow of carbon dioxide, but falls to about -12°. This drop in temperature (it is assumed, of course, that the freezing mixture is maintained) indicates the end point of the carbonation.

Immediately the reaction is complete, introduce through the condenser 250 ml. of 50 per cent. sulphuric acid (by weight) whilst cooling the mixture in ice and water and stirring vigorously. Transfer the mixture to a separatory funnel, remove the ether layer, and extract the aqueous layer with three 50 ml. portions of ether. Cool the combined ether extracts by the addition of ice, and add cautiously 100 ml. of 25 per cent. sodium hydroxide solution; run off the aqueous layer and repeat the

extraction with a further 50 ml. of alkali solution of the same strength. The organic acid is thus converted into the sodium salt and passes into the aqueous layer: test the extracts with phenolphthalein to make certain that all the acid has been removed. Distil the alkaline extract until its volume is reduced by about 10 per cent.; this removes ether and other volatile impurities. Allow to cool, and cautiously acidify with concentrated hydrochloric acid; it is advisable to stir the mixture during the acidification process. Separate the upper layer of acid. Distil the water layer from a 1-litre flask until no more oily drops pass over; saturate the distillate with salt, remove the acid layer, and combine it with the main product. Dry the combined acids with anhydrous magnesium or calcium sulphate, and distil. Collect the *dl*-methylethylacetic acid at 173–174°. The yield is 40 g.

Notes.

(1) *sec*-Butyl chloride is employed in preference to the bromide because it is cheaper and the yield of acid is slightly higher.

(2) Some of the Grignard reagent may be oxidised by the air which is drawn in when the flask is cooled: this may be avoided by passing in dry nitrogen (the gas from a cylinder is passed through two wash bottles containing concentrated sulphuric acid) until the temperature has reached -12° . A T-piece is provided in the gas circuit, and the nitrogen or carbon dioxide is admitted to the flask through the same wide tube. The effect upon the yield is, however, quite small.

(3) The gas is dried by passage through wash bottles containing concentrated sulphuric acid. Alternatively and more simply, the technique (described below for *n*-valeric acid) utilising solid carbon dioxide (Dry Ice or Drikold) may be employed.

COGNATE PREPARATION

n-Valeric acid (*carbonation of the Grignard reagent*). The method detailed above, utilising gaseous carbon dioxide with the Grignard reagent from *n*-butyl chloride or bromide, may be used. The experimental details which follow describe the technique with solid carbon dioxide (Dry Ice or Drikold) as the carbonating agent.

Prepare a Grignard reagent from 12.2 g. of magnesium, a crystal of iodine, 69 g. (54 ml.) of *n*-butyl bromide (1) and 250 ml. of anhydrous ether in a 1-litre three-necked flask, following the method of Section III,23 or the slightly modified procedure of Section III,18. Weigh out (rough balance) 125 g. of Dry Ice (2) on a piece of stiff paper: wrap the paper round the Dry Ice and, by means of a pestle, break it into small lumps, but keep the paper tightly round it. Empty the Dry Ice into a dry 1500 ml. beaker and at once pour in the Grignard reagent in a slow steady stream; any unreacted magnesium will adhere to the sides of the flask. A vigorous reaction occurs. Stir the mass well, and allow it to stand until all the Dry Ice has evaporated. Then add slowly a mixture of 300 g. of crushed ice and 75 ml. of concentrated hydrochloric acid. Stir until the gelatinous compound is decomposed and there is a clean separation into two layers. Pour the mixture into a separatory funnel; rinse the beaker with 50 ml. of ether and transfer this to the funnel. Separate the upper layer and extract the aqueous layer with three 40 ml. portions of ether. Treat the combined ethereal extracts of the crude acid with 25 per cent. sodium hydroxide solution, etc., and proceed exactly as described above

for methylethylacetic acid. Collect the *n*-valeric acid at 182–185° (3). The yield is 25 g.

Notes.

(1) Alternatively, use the equivalent amount of *n*-butyl chloride and prepare the Grignard reagent as for *sec*-butyl magnesium chloride.

(2) Dry Ice should be handled with gloves or with a dry towel; if Dry Ice is held for a long time in the hand, it may cause frost bite.

(3) A method of drying the acid, which avoids the use of a solid desiccant, consists in mixing the liquid with benzene (this solvent may be used for extracting the aqueous layer) and distilling. A mixture of benzene and water passes over first, then, when all the water has been removed, benzene distils at 80°, followed by a rapid rise in temperature to the boiling point of *n*-valeric acid (compare Section II, 39). This procedure may be applied to the drying of most liquid acids. Better results are usually obtained if the benzene solution is subjected to a preliminary drying with anhydrous magnesium or calcium sulphate.

III,85. REACTIONS AND CHARACTERISATION OF ALIPHATIC CARBOXYLIC ACIDS

(i) **Action upon sodium bicarbonate solution.** Place 1 ml. of 5 per cent. sodium bicarbonate solution upon a watch glass; introduce the pure acid (1 drop or a little of the finely-powdered solid). Evolution of carbon dioxide indicates the presence of an acid.

Test the solution so obtained for unsaturation by adding cold 1 per cent. potassium permanganate solution a drop at a time. The immediate disappearance of the purple colour and the formation of a brown turbidity indicates the presence of a double bond (*Baeyer's test*). It must be noted that many substances, not unsaturated, decolourise warm acid or neutral potassium permanganate solution.

Test a small quantity of the aqueous solution or extract of the carboxylic acid with litmus or with Universal indicator paper.

(ii) **Ester formation.** Warm a small amount of the acid with 2 parts of absolute ethyl alcohol and 1 part of concentrated sulphuric acid for 2 minutes. Cool, and pour cautiously into aqueous sodium carbonate solution contained in an evaporating dish, and smell immediately. An acid usually yields a sweet, fruity smell of an ester. (Acids of high molecular weight often give almost odourless esters.)

(iii) **Neutralisation equivalent.** It is recommended that the neutralisation equivalent (or the equivalent weight) of the acid be determined: this is the number expressing the weight in grams of the compound neutralised by one gram equivalent of alkali. Weigh out accurately about 0.2 g. of the acid (finely powdered if a solid), add about 30 ml. of water and, if necessary, sufficient alcohol to dissolve most of the acid, followed by two drops of phenolphthalein indicator. Titrate with accurately standardised 0.1*N* sodium or barium hydroxide solution.* Calculate the equivalent weight from the expression:

$$\text{Neutralisation equivalent} = \frac{\text{Grams of acid} \times 1000}{\text{ml. of alkali} \times \text{Normality of alkali}}$$

* For further details as to the standardisation of the alkali and the storage of standard alkali solutions, see Vogel, *A Text Book of Quantitative Inorganic Analysis: Theory and Practice*, Second Edition, 1951, 233 *et seq.* (Longmans, Green and Co. Ltd.).

CRYSTALLINE DERIVATIVES OF ALIPHATIC CARBOXYLIC ACIDS

1. **Amides, anilides and *p*-toluidides.** The dry acid is first converted by excess of thionyl chloride into the acid chloride :

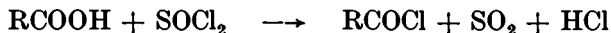

The by-products are both gaseous and the excess of thionyl chloride (b.p. 78°) may be readily removed by distillation. Interaction of the acid chloride with ammonia solution, aniline or *p*-toluidine yields the amide, anilide or *p*-toluidide respectively :

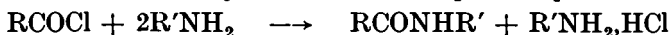
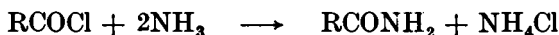

Stopper the side arm of a 25 or 50 ml. distilling flask and fit a vertical water condenser into the neck. Place 0.5–1.0 g. of the dry acid (finely powdered if it is a solid) into the flask, add 2.5–5.0 ml. of redistilled thionyl chloride and reflux gently for 30 minutes ; it is advisable to place a plug of cotton wool * in the top of the condenser to exclude moisture. Rearrange the condenser and distil off the excess of thionyl chloride † (b.p. 78°). The residue in the flask consists of the acid chloride and can be converted into any of the derivatives given below.

(a) **Amides.** Treat the acid chloride cautiously with about 20 parts of concentrated ammonia solution (sp. gr. 0.88) and warm for a few moments. If no solid separates on cooling, evaporate to dryness on a water bath. Recrystallise the crude amide from water or dilute alcohol.

Alternatively, dissolve or suspend the acid chloride in 5–10 ml. of dry ether or dry benzene, and pass in dry ammonia gas. If no solid separates, evaporate the solvent. Recrystallise the amide from water or dilute alcohol.

(b) **Anilides.** Dilute the acid chloride with 5 ml. of pure ether (or benzene), and add a solution of 2 g. of pure aniline in 15–20 ml. of the same solvent until the odour of the acid chloride has disappeared ; excess of aniline is not harmful. Shake with excess of dilute hydrochloric acid to remove aniline and its salts, wash the ethereal (or benzene) layer with 3–5 ml. of water, and evaporate the solvent [*CAUTION !*] Recrystallise the anilide from water, dilute alcohol or benzene - light petroleum (b.p. 60–80°).

***p*-Bromoanilides** are similarly prepared with *p*-bromoaniline.

(c) ***p*-Toluidides.** Proceed as under (b), but substitute *p*-toluidine for aniline.

Anilides and *p*-toluidides may also be prepared directly from the acids ‡ by heating them with aniline or *p*-toluidine respectively :

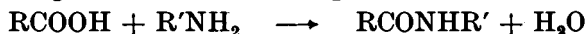

* This is more convenient than the conventional calcium chloride guard tube and possesses the advantage of cheapness and hence can easily be renewed for each experiment : it is, of course, removed during distillations.

† If the boiling point of the acid chloride is too near that of thionyl chloride to render separation by distillation practicable, the excess of the reagent can be destroyed by the addition of pure formic acid :

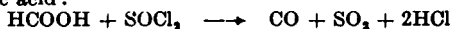

‡ Alternatively, the alkali metal salts of the acids may be heated with the hydrochloride of the appropriate base.

Place 1.0 g. of the monobasic acid and 2 g. of aniline or *p*-toluidine in a dry test-tube, attach a short air condenser and heat the mixture in an oil bath at 140–160° for 2 hours: do not reflux too vigorously an acid that boils below this temperature range and only allow steam to escape from the top of the condenser. For a sodium salt, use the proportions of 1 g. of salt to 1.5 g. of the base. If the acid is dibasic, employ double the quantity of amine and a reaction temperature of 180–200°: incidentally, the procedure is recommended for dibasic acids since the latter frequently give anhydrides with thionyl chloride. Powder the cold reaction mixture, triturate it with 20–30 ml. of 10 per cent. hydrochloric acid,* and recrystallise from dilute alcohol.

2. *p*-Bromophenacyl esters. *p*-Bromophenacyl bromide reacts with the alkali metal salts of acids to form crystalline *p*-bromophenacyl esters:



Dissolve or suspend 0.5 g. of the acid in 5 ml. of water in a small conical flask, add a drop or two of phenolphthalein indicator, and then 4–5 per cent. sodium hydroxide solution until the acid is just neutralised. Add a few drops of very dilute hydrochloric acid so that the final solution is *faintly* acid (litmus).† Introduce 0.5 g. of *p*-bromophenacyl bromide (m.p. 109°) dissolved in 5 ml. of rectified (or methylated) spirit, and heat the mixture under reflux for 1 hour: if the mixture is not homogeneous at the boiling point or a solid separates out, add just sufficient alcohol to produce homogeneity. [Di- and tri-basic acids require proportionately larger amounts of the reagent and longer refluxing periods.] Allow the solution to cool, filter the separated crystals at the pump, wash with a little alcohol and then with water. Recrystallise from dilute alcohol: dissolve the solid in hot alcohol, add hot water until a turbidity just results, clear the latter with a few drops of alcohol, and allow to cool. Acetone may sometimes be employed for recrystallisation.

3. *p*-Nitrobenzyl esters. *p*-Nitrobenzyl bromide (m.p. 100°) reacts with the alkali metal salts of acids to give *p*-nitrobenzyl esters:

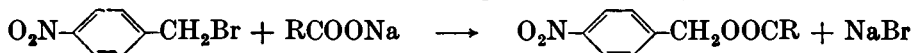

It is important that the solution of the sodium salt be *faintly* acid in order that the formation of coloured by-products in the subsequent reaction may be prevented. If the molecular weight of the monobasic acid is known, it is desirable to employ a slight excess of the sodium salt, since excess of the latter is more easily removed than the unchanged reagent.

Use the procedure given under 2 for *p*-bromophenacyl esters. If the ester does not crystallise out on cooling, reheat the reaction mixture, and add small portions of hot water to the point of incipient cloudiness and allow to cool.

* When the derivative is appreciably soluble in ether, the following alternative procedure may be employed. Dissolve the cold reaction mixture in about 50 ml. of ether, wash it with 20–30 ml. of 10 per cent. hydrochloric acid (to remove the excess of base), followed by 20 ml. of 10 per cent. sodium hydroxide solution, separate the ether layer, and evaporate the solvent [CAUTION]. Recrystallise the residue from dilute alcohol.

† If the sodium salt of the acid is available, dissolve 0.5 g. in 5 ml. of water, add a solution of 0.5 g. of the reagent in 5 ml. of alcohol, and proceed as detailed in the text after just acidifying (litmus) with dilute hydrochloric acid.

4. ***p*-Phenylphenacyl esters.** *p*-Phenylphenacyl bromide reacts with soluble salts of organic acids to yield crystalline *p*-phenylphenacyl esters :
 $p\text{-C}_6\text{H}_5\text{C}_6\text{H}_4\text{COCH}_2\text{Br} + \text{NaOOCR} \longrightarrow p\text{-C}_6\text{H}_5\text{C}_6\text{H}_4\text{COCH}_2\text{OOCR} + \text{NaBr}$

The procedure is similar to that given under 2 and 3 above. Add a weighed amount of acid (0.005 mol) to 5 ml. of water in a small conical flask and neutralise it with *N* sodium carbonate or *N* sodium hydroxide. The final solution should be faintly acid to litmus (add more of the organic acid or a few drops of dilute hydrochloric acid); unless this precaution is taken, coloured by-products are formed which are very difficult to remove. [If the alkali metal salt is available, dissolve 0.005 mol* in 5 ml. of water, and render the solution just acid to litmus by the addition of dilute hydrochloric acid.] Introduce 10 ml. of alcohol, and if the salt of the organic acid is not thrown out of solution, add 0.005 mol of *p*-phenylphenacyl bromide: reflux the mixture for periods up to 1, 2 or 3 hours according to the basicity of the acid. If the salt of the organic acid is precipitated by the alcohol, add more water until the salt dissolves. Some of the esters are sparingly soluble in the reaction mixture and crystallise from the boiling solution; in most cases, however, crystal formation does not occur until the mixture is cooled. In some instances it may be necessary to concentrate the solution before crystallisation occurs. Recrystallise the crude *p*-phenylphenacyl ester from alcohol, dilute alcohol, acetone or benzene.

Certain dibasic acids, of which the sodium or potassium salts are sparingly soluble in dilute alcohol, cause difficulty; these should be neutralised with ethylamine solution.

5. **S-Benzyl-*iso*-thiuronium salts (S-Benzyl-*iso*-thiourea salts).** S-Benzyl-*iso*-thiuronium chloride (S-benzyl-*iso*-thiourea hydrochloride) reacts with the alkali metal salts of organic acids to produce crystalline S-benzyl-*iso*-thiuronium salts :

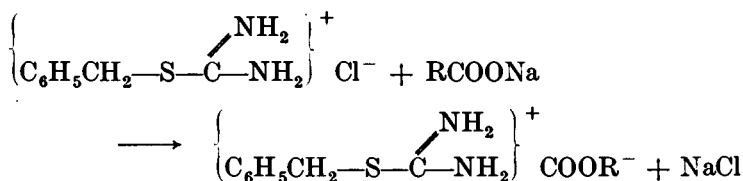

It is important not to allow the reaction mixture to become appreciably alkaline, since the free base then decomposes rapidly yielding benzyl mercaptan, which has an unpleasant odour.

Dissolve (or suspend) 0.25 g. of the acid in 5 ml. of warm water, add a drop or two of phenolphthalein indicator and neutralise carefully with *ca.* *N* sodium hydroxide solution. Then add 2-3 drops of *ca.* 0.1*N* hydrochloric acid to ensure that the solution is almost neutral (*pale* pink colour). (Under alkaline conditions the reagent tends to decompose to produce the evil-smelling benzyl mercaptan.) If the sodium salt is available, dissolve 0.25 g. in 5 ml. of water, and add 2 drops of *ca.* 0.1*N* hydrochloric acid. Introduce a solution of 1 g. of S-benzyl-*iso*-thiuronium chloride in 5 ml. of water, and cool in ice until precipitation is

* Dibasic and tribasic acids will require 0.01 and 0.015 mol respectively.

complete. Recrystallise the crude derivative from dilute alcohol or from hot water.

With some acids (*e.g.*, succinic acid and sulphanilic acid) more satisfactory results are obtained by reversing the order of mixing, *i.e.*, by adding the solution of the sodium salt of the acid to the reagent. It should be pointed out that the melting points of the derivatives as determined on the electric hot plate (Fig. *II, II, 1*) may differ by 2-3° from those obtained by the capillary tube method. In view of the proximity of the melting points of the derivatives of many acids, the mixed m.p. test (Section **I,17**) should be applied.

The melting points of the derivatives of a number of selected aliphatic acids are collected in Table **III,85**.

TABLE III,85.

ALIPHATIC CARBOXYLIC ACIDS

Acid	B.P.	M.P.	Anilide	<i>p</i> -Tolulide	Amide	<i>p</i> -Bromophenacyl Ester	<i>p</i> -Nitrobenzyl Ester	<i>p</i> -Phenylphenacyl Ester	S-Benzyl- <i>iso</i> -thluronium Salt	<i>p</i> -Bromoanilide	Hydrazide*
MONOBASIC ACIDS											
Formic	101°	8°	50°	53°	3°	140°	31°	74°	151°	119°	54°
Acetic	118	16	114	153	82	86	78	111	136	166	77
Propionic	141	—	106	126	79	63	31	102	152	148	40
<i>n</i> -Butyric	163	—	96	75	116	63	35	82	149	111	44
<i>iso</i> -Butyric	154	—	105	109	129	77	—	89	149	151	104
<i>n</i> -Valeric	186	—	83	74	106	75	—	63	156	106	—
<i>iso</i> -Valeric	176	—	113	109	136	68	—	78	159	129	68
<i>n</i> -Hexoic (<i>caproic</i>)	205	—	95	74	100	72	—	70	157	105	—
<i>n</i> -Heptoic (<i>oenanthic</i>)	223	—	71	80	95	72	—	62	—	95	—
<i>n</i> -Octoic (<i>caprylic</i>)	239	16	57	70	110	67	—	67	157	102	—
<i>n</i> -Nonoic (<i>pelargonic</i>)	254	12	57	84	95	69	—	71	—	100	—
<i>n</i> -Decoic (<i>capric</i>)	269	31	70	78	100	67	—	—	—	102	—
<i>n</i> -Undecoic	164°/15	29	71	80	103	68	—	79	—	—	—
<i>n</i> -Dodecanoic (<i>lauric</i>)	225°/100	43	78	87	99	76	—	86	141	—	105
Myristic	250°/100	58	84	93	102	81	—	90	139	—	—
Palmitic	268°/100	63	91	98	108	86	43	94	141	—	111
Stearic	291°/100	70	94	102	109	90	—	97	143	—	—
Pivalic (trimethylacetic)	164	35	133	120	154	76	—	—	—	—	—
Diethylacetic	193	—	127	116	112	—	—	77	—	—	—
<i>iso</i> -Caproic (<i>iso</i> -butylacetic)	198	—	112	63	121	77	—	70	—	—	—
α -Ethyl- <i>n</i> -hexoic	228	—	—	—	101	—	—	54	—	—	—
10-Undecenoic	275	25	67	68	87	—	—	—	149	—	—
Cyanoacetic	—	66	198	—	120	—	—	—	—	—	—
Monochloroacetic	189	63	137	162	120	105	—	116	160	—	—
Dichloroacetic	194	10	119	153	97	99	—	—	178	—	—
Trichloroacetic	196	58	95	113	141	—	80	—	148	—	—
Monobromoacetic	208	50	130	91	91	—	—	—	—	—	—
Monoiodoacetic	—	83	144	—	95	—	—	—	—	—	—
α -Chloropropionic	186	—	92	124	80	—	—	—	—	—	—
α -Bromopropionic	206	25	99	125	123	—	—	—	—	—	—
Glycollic	—	79	97	143	120	138	107	—	146	—	—
Lactic	122°/15	18	59	107	79	113	—	145	153	—	—
Acrylic	140	13	105	141	85	—	—	—	—	—	—
Crotonic	189	72	118	132	160	95	67	—	172	—	—
Furoic (<i>pyromucic</i>)	—	134	124	108	142	139	134	86	211	—	80
Sorbic	—	134	153	—	—	129	—	—	—	—	—
Oleic	204°/5	14	41	42	76	46	—	80	—	—	—
Pyruvic	165 d	13	104	130	125	—	—	—	—	—	—
Laevulinic	246	33	102	109	108	84	61	—	—	—	—

TABLE III,85.

ALIPHATIC CARBOXYLIC ACIDS (continued)

Acid	B.P.	M.P.	Anilide	<i>p</i> -Tolulide	Amide	<i>p</i> -Bromo-phenacyl Ester	<i>p</i> -Nitro-benzyl Ester	<i>p</i> -Phenyl-phenacyl Ester	S-Benzyl- <i>iso</i> -thiuronium Salt	<i>p</i> -Bromo-anilide	Hydrazide*
MONOBASIC ACIDS (continued)											
Nicotinic	—	235°	85°	150°	128°	—	—	—	—	—	—
Methoxyacetic	203	—	58	—	96	—	—	—	—	—	—
Ethoxyacetic	207	—	—	—	82	104	—	—	—	—	—
Methylethylacetic	177	—	112	93	112	55	—	—	—	—	—
α -Furylacrylic	—	141	—	—	169	—	—	—	—	—	—
Hexahydrobenzoic	233	31	144	—	186	—	—	—	—	—	—
DIBASIC AND TRIBASIC ACIDS											
Oxalic (dihdrate).	—	101°	246°	268°	—	242°	204°	165° d	198°	—	243°
Malonic	—	135	225	253	170°	—	86	175	147	—	154
Succinic	—	185	229	255	260	211	88	208	154	—	168
Glutaric	—	98	224	218	175	137	69	152	161	—	176
Adipic	—	152	239	241	220	155	106	148	163	—	171
Pimelic	—	105	156	206	—	137	—	146 d	—	—	182
Suberic	—	142	187	219	217	144	85	151	—	—	—
Azelaic	—	106	187	202	172	131	44	141	—	—	—
Sebacic	—	134	202	201	208	147	73	140	155	—	—
Malic	—	101	197	207	157	179	124	106	124	—	178
Mucic	—	214	—	—	—	—	—	149	178	—	216
Fumaric	—	286	314	—	266	—	151	—	196	—	—
Maleic	—	135	187	142	181	168	89	168	163	—	—
Mesaconic	—	204	186	212	176	—	—	—	—	—	—
Citraconic	—	93	175	—	186	—	70	109	—	—	177
Itaconic	—	165	190	—	192	117	90	—	—	—	—
Camphoric	—	187	226	—	193	—	67	—	—	—	—
rac-Tartaric	—	206	—	—	226	—	147	—	—	—	—
meso-Tartaric	—	140	—	—	190	—	93	—	—	—	—
d-Tartaric	—	170	264	—	196	216	163	204	—	—	—
Citric (hydrated).	—	100	199	189	215	148	102	146	—	—	—
Aconitic	—	191	—	—	250	186	—	—	—	—	183
											107

* See Section III,106 for details of the preparation of hydrazides.

ACID CHLORIDES OF ALIPHATIC CARBOXYLIC ACIDS

The conversion of aliphatic acids into their acid chlorides is usually accomplished with:—

1. Phosphorus trichloride. The reaction is not quite quantitative, for example:

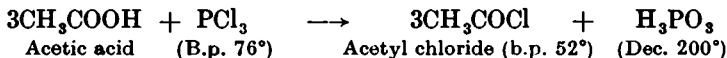

Some hydrogen chloride is evolved and small quantities of volatile phosphorus compounds are formed, due to such reactions as the following:



These may be largely removed by redistilling from a small quantity of glacial acetic acid.

Commercial preparations of acetyl chloride are best freed from volatile phosphorus compounds and dissolved hydrogen chloride by redistillation from 5–10 per cent. of the volume of pure dimethylaniline.

Very pure acid chlorides may be obtained by reaction between the anhydrous sodium salt of the acid and phosphorus oxychloride, for example:

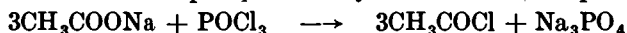

2. Thionyl chloride. This reagent (b.p. 76°) is generally used in excess of the theoretical quantity; it cannot be employed for acetyl chloride (b.p. 52°) because of the difficulty of separation by fractional distillation. Excellent results are obtained, however, with butyric acid and acids of higher molecular weight, for example:

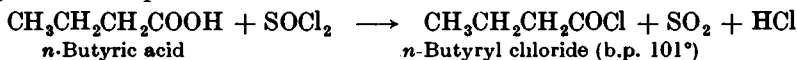

The reason for using an excess of, say, 1 mol of thionyl chloride is to avoid anhydride formation:

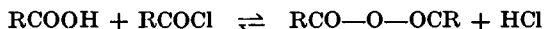

The excess of thionyl chloride displaces the equilibrium to the left not only by removing the carboxylic acid ($\text{RCOOH} + \text{SOCl}_2 \longrightarrow \text{RCOCl} + \text{SO}_2 + \text{HCl}$) but also by thus keeping up a good supply of hydrogen chloride. The use of a larger excess than 1 mol (*i.e.*, more than 2 mols of SOCl_2 per mol of RCOOH) has little, if any, advantage, but reducing the quantity to 1.2 mols of SOCl_2 per mol of RCOOH usually lowers the yield of acid chloride by 10–20 per cent.

III,86.

ACETYL CHLORIDE

Method 1. Use the apparatus depicted in Fig. III, 56, 1, but omit the thermometer: also attach a cotton wool (or calcium chloride) tube to the side arm of the filter flask receiver * in order to prevent the entrance of moisture into the apparatus. Mount the reaction flask in a water bath (*e.g.*, a large beaker or other convenient vessel). It is important that all the apparatus be perfectly dry, since both phosphorus trichloride and acetyl chloride are decomposed by water. The set-up should be assembled in the fume cupboard.

Place 25 g. (24 ml.) of glacial acetic acid in the 100 or 125 ml. distilling flask and 20 g. (12.5 ml.) of phosphorus trichloride in the funnel; fill

* A 100 ml. distilling flask may also be used.

the water bath with cold water. Add the phosphorus trichloride in small portions to the acetic acid, shaking the flask gently from time to time to ensure thorough mixing of the reagents. Allow the mixture to stand for 15 minutes, then heat the water bath at 40–50° for 30 minutes; by this time the evolution of hydrogen chloride will have ceased and the liquid in the flask will have separated into two layers. Heat the water bath to boiling so that the upper layer of crude acetyl chloride passes over; it is advantageous to cool the receiver in cold water during the distillation. Pour out the syrupy residue of phosphorous acid into a bottle provided for the purpose in the laboratory; clean and dry the flask.

Treat the distillate with 2 drops of glacial acetic acid (to destroy the phosphorus esters present) and redistil using the same apparatus as before except that the separatory funnel is replaced by a thermometer. Collect the liquid which passes over at 50–56°. Transfer the acetyl chloride to a weighed glass-stoppered bottle (since cork and rubber stoppers are attacked) and determine the weight. The yield is 22 g.

Method 2. Fit a reflux condenser into the mouth of a 250 ml. distilling flask (compare Fig. III, 28, 1) and insert, by means of a grooved cork, a small separatory funnel into the top of the condenser; close the side arm of the distilling flask with a partially bored cork. Place 65 g. of anhydrous sodium acetate (Section II, 50, 9) in the flask and 65 g. (39 ml.) of phosphorus oxychloride in the separatory funnel. Allow the phosphorus oxychloride to run in slowly on to the sodium acetate with frequent shaking; the addition should occupy about 30 minutes. Remove the separatory funnel, replace it by a cotton wool (or calcium chloride) guard tube, and allow the reaction mixture to stand for 10–12 hours. Arrange the distilling flask for distillation from a water bath (Fig. II, 13, 1); continue the distillation as long as any liquid passes over (about 3 hours) (1). Redistil the resulting acetyl chloride (39 g.) from a 100 ml. distilling flask, and attach a cotton wool guard tube to the receiver (filter flask or distilling flask). It all distils at 51–52°.

Note.

(1) The solid residue in the flask dissolves readily in cold water.

III, 87.

n-BUTYRYL CHLORIDE

Fit a reflux condenser into the short neck of a 100 or 125 ml. Claisen flask, a separatory funnel into the long neck, and plug the side arm with a small cork (compare Fig. III, 31, 1). Place 37.5 g. (22.5 ml.) of redistilled thionyl chloride in the flask and 22 g. (23 ml.) of *n*-butyric acid in the separatory funnel. Heat the flask gently on a water bath, and add the *n*-butyric acid during the course of 30–40 minutes; absorb the hydrogen chloride evolved in water using the device shown in Fig. II, 13, 8 (compare Fig. II, 8, 1). When all the acid has been introduced, heat on a water bath for 30 minutes. Rearrange the apparatus and distil: collect the crude acid chloride boiling between 70 and 110° in a distilling flask. Finally, redistil from a small Claisen flask with fractionating side arm (Fig. II, 24, 2–5) or from a flask provided with a short fractionating column (*e.g.*, an all-glass Dufton column, Fig. II, 15, 2): collect the *n*-butyryl chloride at 100–101°. The yield is 23 g.

III,88. REACTIONS AND CHARACTERISATION OF ACID CHLORIDES OF ALIPHATIC ACIDS

Carry out the following simple experiments with acetyl chloride (compare Section III,86).

(i) To a test-tube containing about 5 ml. of water add cautiously a few drops of acetyl chloride. Note that the acetyl chloride does not dissolve in the water, but on shaking reaction occurs with the evolution of heat and the formation of acetic acid.

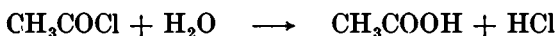

(ii) To 1 ml. of *absolute* ethyl alcohol in a dry test-tube add 1 ml. of acetyl chloride drop by drop (use a dropper pipette, Fig. II, 27, 1); keep the mixture cold by holding the tube under the tap. Note whether any hydrogen chloride gas is evolved (blow across the mouth of the tube). Pour into 2 ml. of saturated salt solution and observe the formation of an upper layer of ester (ethyl acetate) and also note the odour of the ester; if this does not appear to have a fruit-like odour, add a little sodium carbonate to neutralise the acid and examine again.

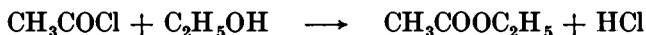

Repeat the test with 1 ml. of *n*-butyl alcohol.

(iii) Add 1 ml. of acetyl chloride, drop by drop, to 0.5–1 ml. of aniline. After the vigorous reaction is over, dilute the mixture with 5 ml. of water and observe the formation of a solid (acetanilide). Filter this off recrystallise from a little boiling water, and determine the m.p. after drying. Pure acetanilide melts at 114°.



The above simple experiments illustrate the more important properties of aliphatic acid chlorides. For characterisation, the general procedure is to hydrolyse the acid chloride by warming with dilute alkali solution, neutralise the resulting solution with dilute hydrochloric acid (phenolphthalein), and evaporate to dryness on a water bath. The mixture of the sodium salt of the acid and sodium chloride thus obtained may be employed for the preparation of solid esters as detailed under *Aliphatic Acids*, Section III,85. The anilide or *p*-toluidide may be prepared directly from the acid chloride (see (iii) above and Section III,85,1).

The physical properties of a number of aliphatic acid chlorides are collected in Table III,88.

TABLE III,88. ACID CHLORIDES (ALIPHATIC)

Acyl Chloride	B.P.	M.P.	d_{4}^{20}	n_{D}^{20}
Acetyl . . .	52°	—	1.104	1.390
Propionyl . . .	80	—	1.056	1.404
<i>n</i> -Butyryl . . .	102	—	1.028	1.412
<i>iso</i> -Butyryl . . .	92	—	1.017	1.408
<i>n</i> -Valeryl . . .	127	—	1.000	1.420
<i>iso</i> -Valeryl . . .	115	—	0.987	1.416
<i>n</i> -Caproyl (<i>n</i> -hexoyl)	152	—	0.975	1.426
<i>iso</i> -Caproyl (<i>iso</i> -butylacetyl)	144	—	0.973	—
<i>n</i> -Heptoyl . . .	175	—	0.963	1.432
<i>n</i> -Octoyl . . .	195	—	0.949	1.432
Chloroacetyl . . .	105	—	1.420	1.454
Dichloroacetyl . . .	108	—	—	—
Trichloroacetyl . . .	118	—	1.620	1.470
Oxalyl . . .	63	—	1.479	1.432
Succinyl . . .	192	17°	1.375	1.468
Glutaryl . . .	218	—	1.324	1.473
Adipyl . . .	125°/11	—	—	—

ACID ANHYDRIDES OF ALIPHATIC CARBOXYLIC ACIDS

Acid anhydrides of monobasic aliphatic acids may be prepared:—

1. By the reaction of the acid chloride with the corresponding sodium salt, for example :

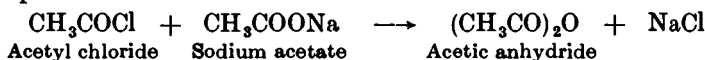

An equivalent result may be obtained by treating excess of sodium acetate with phosphorus oxychloride ; acetyl chloride is an intermediate product and the final result is :



2. By the action of keten, $\text{CH}_2=\text{C}=\text{O}$, upon acids. Acetic anhydride is formed with acetic acid :

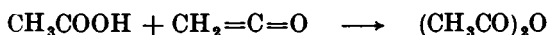

With higher aliphatic acids, RCOOH , keten yields first a mixed anhydride CH_3COOCR , which can be distilled under reduced pressure ; by slow distillation at atmospheric pressure the mixed anhydride undergoes rearrangement into the anhydride of the higher fatty acid and acetic acid, for example :

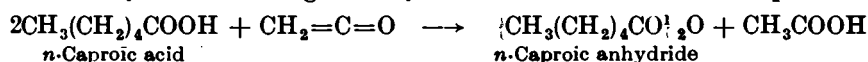

Keten itself can be prepared by the pyrolysis of acetone at 700° :

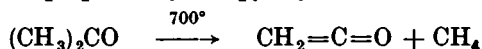

Excellent results are obtained by passing acetone vapour over an electrically heated nichrome wire spiral : an apparatus, incorporating the latter, is described in the experimental section.

3. By the interaction in benzene solution of the acid chloride with the acid in the presence of pyridine, for example :

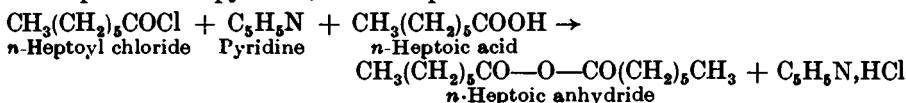

The presence of the base brings about the irreversible elimination of hydrogen chloride between the acid chloride and the acid ; the resulting pyridine hydrochloride precipitates out as the reaction progresses.

Anhydrides of dibasic acids (succinic or glutaric acid type) may be prepared :

1. By dehydration with acetyl chloride, acetic anhydride or with phosphorus oxychloride, for example :

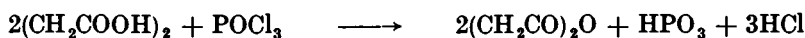
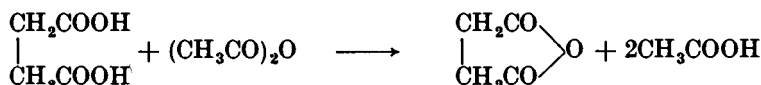
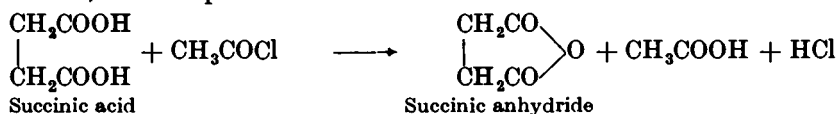

The acetic acid formed can often be used for the crystallisation of the anhydride.

2. By distilling the acid with an inert solvent of high boiling point, such as tetrachloroethane. The water passes over with the solvent and the anhydride remains, for example :

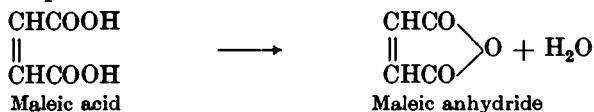

III,89. ACETIC ANHYDRIDE

Assemble an apparatus consisting of a 100 or 125 ml. distilling flask carrying a dropping funnel, the stem of which passes below the side arm : attach the distilling flask to a condenser for downward distillation and use a 50 or 100 ml. distilling flask as receiver. Place 28 g. of finely powdered anhydrous sodium acetate (for preparation, see Section II,50,9) in the flask and 20 g. (18 ml.) of acetyl chloride in the dropping funnel. Disconnect the distilling flask from the condenser and immerse it in cold water or in ice water. Add about half of the acetyl chloride drop by drop ; then remove the flask from the cooling bath and mix the contents thoroughly by cautious shaking and tapping of the flask against the palm of the hand. Return the flask to the cooling bath and run in the remainder of the acetyl chloride drop by drop. Do not allow the mixture to get so hot that it boils. When all the acetyl chloride has been added, remove the separatory funnel and replace it by a solid cork ; thoroughly mix the contents of the flask as above. Attach the flask to the condenser and receiver. Clamp the flask at such a height that it can easily be heated by a Bunsen burner. Heat the flask by means of a luminous, smoky Bunsen flame, which is kept in constant motion round the base of the flask to ensure uniform heating and minimise the danger of cracking the flask. Continue the heating until no more liquid passes over. Add 2-3 g. of finely-powdered anhydrous sodium acetate to the distillate in order to convert any unchanged acetyl chloride into acetic anhydride, insert a cork carrying a thermometer into the flask, attach a condenser, and distil slowly. Collect the fraction which passes over at 135-140° as acetic anhydride. The yield is 20 g.

III,90. KETEN

An apparatus for the preparation of keten is illustrated in Fig. III, 90, 1 ; in it acetone vapour is passed over a nichrome filament heated at 700-750°, the yield of keten exceeding 90 per cent. The construction of the filament will be apparent from the enlarged figure (b). About 350 cm. of 24 gauge nichrome wire * is formed into a tight spiral by winding the wire around a glass rod 3 mm. in diameter and stretching the coil so formed to a length of 70 cm. The filament is held in position on 1.5 cm. long platinum hooks *A* sealed into the Pyrex glass rod *B* which supports them. The three platinum hooks at the bottom of the rod are placed 120° apart ; two platinum hooks support the filament at a distance of 11 cm. above the lower end. The ends of the filament *C* are connected to tungsten leads by

* U.S. : B. and S. gauge 24 Chromel A wire, an alloy of 80% Ni and 20% Cr.

means of nickel or brass connectors *D*, 10 mm. in length and 3.5 mm. in internal diameter. The tungsten leads (24 gauge) are sealed into the glass at the points *E*; the leads are insulated by means of 6 mm. glass tubing *F*, which are held by a cork stopper *G*. If desired, the tungsten leads may be soldered immediately above the glass seal to copper wires (24 gauge) which are passed through the glass tubing seal *F*. The tungsten or copper wire leads are connected to the 220 volt a.c. mains through a variable transformer (Variac).

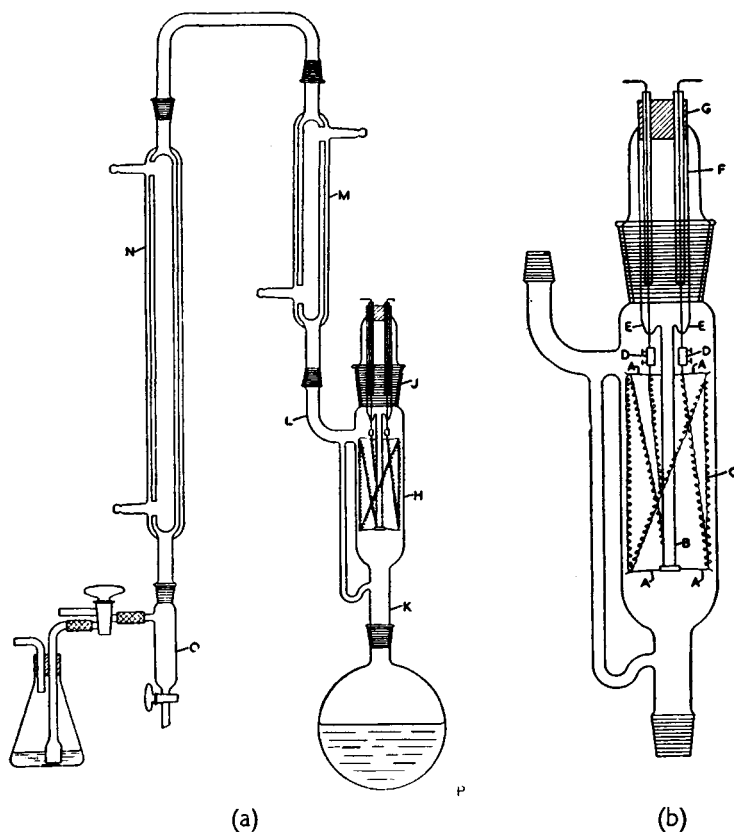

Fig. III, 90, 1.

All the glass in the apparatus is in Pyrex and connexions are made by means of standard glass joints of appropriate size. Chamber *H* is constructed from a 25 cm. length of glass tubing of 70 mm. internal diameter; the joint *J* is B55. The connecting tube *K* is in 12–15 mm. tubing, the side arm *L* is of 15 mm. tubing; the condensers *M* and *N* are efficient double surface condensers, 50 cm. and 90 cm. long respectively (the sizes are not critical); *O* is a liquid trap, constructed of 35 mm. tubing and is 120 mm. long, with side tube of 8 mm. diameter; the stopcock is for the removal of liquid from the trap.

To operate the apparatus, place acetone in the 2-litre round-bottomed flask *P* and heat the flask on a steam bath until the liquid refluxes gently

from the condenser *M*. After 5 minutes' refluxing to drive the air from the the chamber *H*, heat the filament *C* to a dull red glow (700–750°). Keten is formed almost immediately. The apparatus requires little attention, apart from occasionally removing the condensed liquid from the trap *O*. At the end of the run, the following operations must be carried out rapidly in this order: (i) remove the source of heat from the flask *P*, (ii) turn off the filament current, and (iii) open the stopcock on *O*.

The yield of keten may be determined by weighing the acetanilide produced by passing the gas stream through excess of aniline for a measured period of time. Attach two reaction flasks to both arms of the "three-way" stopcock, the first *Q* containing 25.0 g. and the second 5.0 g. of pure aniline; the second flask is introduced to prevent the escape of keten at the beginning and at the end of the determination. Cool the flasks in ice water. Pass the keten into the flask containing the larger amount of aniline for 30 minutes, then add an excess of dilute hydrochloric acid to remove the residual aniline, filter off the acetanilide, wash it with water, dry and weigh. Calculate the weight of keten produced per hour. This will be found to be of order of 0.45 mol of keten per hour.



III,91.

n-CAPROIC ANHYDRIDE

Place 116 g. (126 ml.) of dry *n*-caproic acid in a 250 ml. gas wash bottle and cool in ice. Pass in 21–23 g. of keten (Section III,90) (1). Carefully distil the reaction mixture through a highly efficient fractionating column (*e.g.*, a well-lagged Widmer or all-glass Dufton column or from a modified Pyrex Hempel column—see Section II,17) (2), using an oil bath for heating. A fraction of low boiling point, containing acetone, keten, acetic acid and a little acetic anhydride, is thus removed at atmospheric pressure. Raise the temperature of the bath to 220° over a period of 1 hour and maintain it at this temperature for 3 hours from the time distillation commences: this time is necessary to ensure that the conversion of the mixed anhydride to caproic anhydride and acetic acid is complete and that the acetic acid is completely removed. Discontinue the distillation, allow to cool somewhat and distil the residue in the flask under reduced pressure (3–10 mm.). Discard the small fraction (20 g.) of low boiling point and collect the *n*-caproic anhydride at 118–121°/6 mm. (or 109–112°/3 mm.). The yield is 90 g.

Notes.

(1) Excess of keten over the calculated quantity does not increase the yield; it leads to more acetic anhydride being collected in the low boiling point fraction.

(2) The best results are obtained with a fractionating column surrounded by an electrically-heated jacket (compare Figs. II, 17, 2, and II, 17, 3), but this is not essential for *n*-caproic anhydride. For the preparation of propionic or *n*-butyric anhydride, a highly efficient fractionating column must be used in order to obtain satisfactory results.

COGNATE PREPARATION

n-Heptoic anhydride (1). In a 250 ml. round-bottomed three-necked flask, provided with a dropping funnel, stirrer and thermometer, place 15.8 g. (16.1 ml.) of dry pyridine (Section II,47, 22) and 25 ml. of dry

benzene. Stir and add rapidly 14.8 g. (15.5 ml.) of *n*-heptoyl chloride (2): the temperature rises slightly and a pyridinium complex separates. Introduce 13.0 g. (14.1 ml.) of *n*-heptonic acid (Section III,81), with stirring, over a period of 5 minutes; the temperature rises to 60–65° and pyridine hydrochloride is formed. Continue the stirring for 10 minutes and collect the hygroscopic pyridine hydrochloride as rapidly as possible on a chilled Buchner or sintered glass funnel, and wash it with two 25 ml. portions of dry benzene. Remove the benzene from the filtrate under reduced pressure on a water bath, and distil the residue from a Claisen flask with fractionating side arm. Collect the *n*-heptonic anhydride at 170–173°/15 mm.; the yield is 20 g.

Notes.

(1) This is an example of the acid chloride - pyridine - acid method referred to in the theoretical section.

(2) Prepare *n*-heptoyl chloride from the acid by treatment with thionyl chloride as detailed for *n*-butyryl chloride (Section III,87); b.p. 173–175°.

III,92.

SUCCINIC ANHYDRIDE

Method A. In a 500 ml. round-bottomed flask, fitted with a reflux condenser attached to a gas trap (Fig. II, 13, 8), place 59 g. of succinic acid and 117.5 g. (107.5 ml.) of redistilled acetyl chloride. Reflux the mixture gently upon a water bath until all the acid dissolves (1–2 hours). Allow the solution to cool undisturbed and finally cool in ice. Collect the succinic anhydride, which separates in beautiful crystals, on a Buchner or sintered glass funnel, wash it with two 40 ml. portions of anhydrous ether, and dry in a vacuum desiccator. The yield of succinic anhydride, m.p. 118–119°, is 47 g.

Method B. In a 500 ml. round-bottomed flask, provided with a reflux condenser protected by a cotton wool (or calcium chloride) drying tube, place 59 g. of succinic acid and 102 g. (94.5 ml.) of redistilled acetic anhydride. Reflux the mixture gently on a water bath with occasional shaking until a clear solution is obtained (*ca.* 1 hour), and then for a further hour to ensure the completeness of the reaction. Remove the complete assembly from the water bath, allow it to cool (observe the formation of crystals), and finally cool in ice. Collect the succinic anhydride as in *Method A.* The yield is 45 g., m.p. 119–120°.

Method C. Place 59 g. of succinic acid in a 250 ml. Claisen flask. Fit a reflux condenser, attached to a gas trap (Fig. II, 8, 1), into the short neck. Introduce 38 g. (23 ml.) of redistilled phosphorus oxychloride into the flask, and close the long neck and side arm with well-fitting corks. Heat the mixture slowly, cautiously at first with a smoky luminous flame, directing the flame so that all parts of the mixture are fairly evenly heated—there may be considerable frothing initially—and continue the heating until no more hydrogen chloride is evolved (20–30 minutes); after the initial frothing has subsided, the flask may be heated in an air bath (Fig. II, 5, 3). Remove the condenser and arrange the flask for distillation; connect the side arm of the receiver to the sink in order to carry off the vapours (compare Fig. II, 13, 4). After a few ml. of distillate have been collected, the temperature rises to 255°; change the receiver and collect the succinic anhydride at 255–260° (42 g.,

m.p. 118–120°) (1). Purify the distillate by dissolving it in 30 ml. of redistilled acetic anhydride and cool the hot solution in ice. Filter off the crystals at the pump, wash them with two 20 ml. portions of anhydrous ether, and dry in a vacuum desiccator or rapidly at 40°. The yield of pure succinic anhydride, m.p. 119–120°, is 36·5 g.

Note.

(1) The tarry residue in the flask may be removed by warm dilute sodium hydroxide solution.

III,93. MALEIC ANHYDRIDE

Mix 100 g. of maleic acid (Section III,143) and 100 ml. of tetrachloroethane in a 250 ml. Claisen or distilling flask provided with a thermometer, and attach a Pyrex Liebig condenser. Heat the flask in an air bath (Fig. II, 5, 3) and collect the distillate in a measuring cylinder. When the temperature reaches 150°, 75 ml. of tetrachloroethane and 15–15·5 ml. of water are present in the receiver. Empty the water in the condenser and continue the distillation; change the receiver when the temperature reaches 190°. Collect the maleic anhydride at 195–197°. Recrystallise the crude anhydride from chloroform. The yield of pure maleic anhydride, m.p. 54°, is 70 g.

III,94. REACTIONS AND CHARACTERISATION OF ACID ANHYDRIDES (ALIPHATIC)

Carry out the following simple experiments with acetic anhydride (compare Section III,89).

(i) Mix 5 ml. of water in a test-tube with 0·5 ml. of acetic anhydride and shake. Observe that no apparent reaction occurs immediately. Upon warming, however, the acetic anhydride dissolves and acetic acid is formed:



(ii) Mix 2 ml. of absolute ethyl alcohol with 1 ml. of acetic anhydride. No apparent reaction occurs in the cold. Heat the mixture gently for a few minutes: the anhydride slowly passes into solution. Treat with a little sodium carbonate solution; observe the characteristic odour of ethyl acetate. If the ester does not separate from the solution, add a little salt until saturated.



Repeat the experiment with 2 ml. of *n*-butyl alcohol.

(iii) Heat a mixture of 1 ml. of aniline and 1 ml. of acetic anhydride almost to the boiling point and cool. No solid separates. Add 4–5 ml. of water and rub the walls of the test-tube with a glass rod. Crystals of acetanilide are formed. Recrystallise from a little boiling water and determine the m.p. (114°).



Perform the following experiment with *succinic anhydride*. This illustrates the formation of an anilic acid, which is usually an excellent

derivative for the characterisation of an anhydride of a dibasic acid (particularly if it is a liquid) and indirectly for the dibasic acid itself. Dissolve 0.5 g. of succinic anhydride in 15 ml. of benzene by heating on a water bath, and add a solution of 0.5 ml. of aniline in 3 ml. of benzene. The anilic acid soon separates in a crystalline form.* Cool, filter off the crystals and wash with a little benzene. Recrystallise from dilute alcohol and determine the m.p. Pure succinanilic acid (I) melts at 150°



The above simple experiments illustrate the more important properties of the anhydrides of aliphatic acids. For their characterisation, the reaction with aniline or *p*-toluidine is frequently employed. Alternatively, the anhydride may be hydrolysed with dilute alkali as detailed under *Acid Chlorides*, Section III,88, and the resulting acid characterised as in Section III,85.

The physical properties of a number of acid anhydrides (aliphatic) are given in Table III,94.

* If the anhydride of an unknown acid is being used and the anilic acid does not crystallise after the mixture has been boiled for a short time, cool the solution, wash it with dilute hydrochloric acid to remove the excess of aniline, and evaporate the solvent: the anilic acid will then usually crystallise.

TABLE III,94. ACID ANHYDRIDES (ALIPHATIC)

Anhydride	B.P	M.P.	$d_{4}^{20^{\circ}}$	$n_D^{30^{\circ}}$
Acetic	140°	—	1·081	1·390
Propionic	166	—	1·022	1·404
<i>n</i> -Butyric	198	—	0·968	1·413
<i>iso</i> -Butyric	182	—	0·956	—
<i>n</i> -Valeric	218	—	0·925	—
<i>iso</i> -Valeric(β -Methyl- <i>n</i> -butyric)	215	—	0·933	1·404
<i>n</i> -Caproic (<i>n</i> -hexoic)	245	—	0·920	1·430
<i>iso</i> -Caproic (<i>iso</i> -butylacetic)	139°/19	—	—	—
<i>n</i> -Heptoic (oenanthic)	258	17°	0·917	1·433
<i>n</i> -Octoic (capric)	285	—	0·910	1·434
Crotonic	247	—	1·040	1·474
Succinic	261	120	—	—
Glutaric	150°/10	56	—	—
Maleic	198	56	—	—
Citraconic	213	7	—	—
Itaconic	139°/30	68	—	—
<i>d</i> -Camphoric	270	220	—	—
Monochloroacetic	109°/11	46	—	—
Dichloroacetic	101°/16	—	—	—
Trichloroacetic	223	—	—	—

ALIPHATIC ESTERS

Aliphatic esters may be prepared as follows :—

1. From the acid. The interaction between an acid and an alcohol is a reversible process and proceeds very slowly, for example :

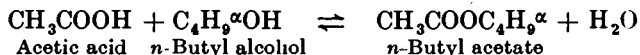

Equilibrium is only attained after refluxing for several days. If, however, about 3 per cent. (on the weight of the alcohol) of either concentrated sulphuric acid or of dry hydrogen chloride is added to the mixture, the same point of equilibrium can be reached in a few hours: the use of a mineral acid as a catalyst in the esterification was introduced by E. Fischer and Speier in 1895. When equimolecular quantities of acid and alcohol are employed, only about two-thirds of the theoretically possible yield of ester is obtained. According to the law of mass action, the equilibrium may be displaced in favour of the ester by the use of an excess of one of the components. It is frequently convenient to use an excess of the acid, but if the acid is expensive a large excess of the alcohol is more generally employed. This method of esterification, in general, gives good yields with primary alcohols, fairly good yields with secondary alcohols, and poor yields with tertiary alcohols: special methods must be adopted for the last-named (see below). Thus the order of reactivity in the esterification of acetic acid with the three isomeric butyl alcohols is primary > secondary ≫ tertiary, and this is the reverse of the order of reactivity of hydrogen chloride with the same alcohols (compare Sections III, 28, 29, 33). The difference is due to the fact that the reactions are of different kinds :

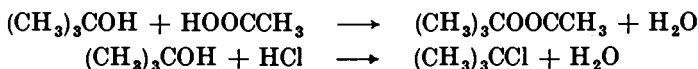

In the conversion of alcohols into alkyl halides, the *mechanism* is probably :

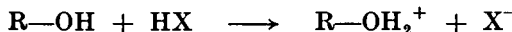

The reaction therefore involves nucleophilic displacement on carbon passing through the transition state indicated: otherwise expressed, the reaction involves nucleophilic displacement in the conjugate acid R-OH_2^+ in which the displaced group is OH_2^+ .

Two alternative mechanisms are possible for esterification, one is dependent upon an acyl-oxy process ($\text{R}'\text{-CO-OH} + \text{H OR}$) and the other an alkyl-oxy process ($\text{R}'\text{-CO-OH} + \text{HO R}$). The former is by far the more common. The detailed acyl-oxy *mechanism* envisages: (1) a preliminary addition of a proton forming a conjugate acidic ion (or oxonium ion); (2) this then undergoes an exchange reaction with an alcohol molecule which approaches along the line of the C-O^+ dipole; and (3) loss of a proton to yield the ester.

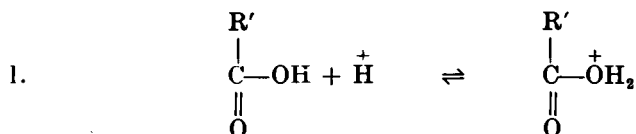

(b) By refluxing a mixture of the acid (1 mol), alcohol (3-4 mols), dry benzene (375 ml.) and concentrated sulphuric acid (58-60 g.). The ester as formed passes into the benzene layer. Upon the addition of water, separating the benzene layer, and distilling the latter (after washing and drying), benzene and alcohol pass over first, followed by the ester, for example :

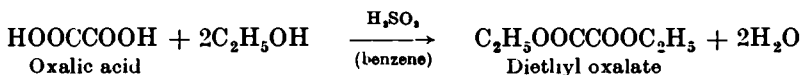

Both of these methods are more economical in the consumption of alcohol and more convenient than that in which the acid is refluxed with a large excess of alcohol in the presence of concentrated sulphuric acid. An example of the latter procedure is described :

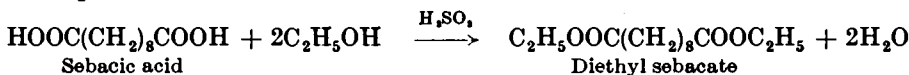

The benzene-alcohol method is useful for the esterification of valuable monobasic acids, but the b.p. of the ester must be at least 50° higher than that of benzene, for example :

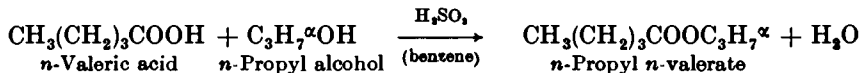

When either of the reactants is sensitive to mineral acids, the esterification can often be successfully accomplished with the aid of a cation exchange resin (hydrogen form) in the presence of benzene. Zeo-Karb 225/H, a uni-functional sulphonated polystyrene resin in the hydrogen form, may be used. Thus good yields of *isopropyl lactate* may be obtained :

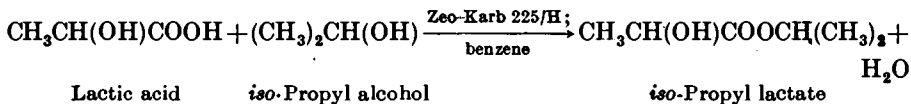

Lactic acid tends to pass into the lactide $\begin{array}{c} \text{CH}_3\text{CH}-\text{O}-\text{CO} \\ | \qquad \qquad | \\ \text{CO}-\text{O}-\text{CHCH}_3 \end{array}$ when heated in

the presence of sulphuric acid. Likewise *n*-butyl oleate is readily prepared from the alcohol and acid in the presence of Zeo-Karb 225/H. The esterification of acetic acid with the acid-sensitive furfuryl alcohol gives a 25 per cent. yield of ester in the presence of the resin; furfuryl acetate is, however, more easily prepared by boiling furfuryl alcohol with acetic anhydride and sodium acetate in the presence of benzene.

2. From the silver salt. By refluxing the dry silver salt with an alkyl halide in anhydrous ether, benzene or absolute alcohol solution, for example :

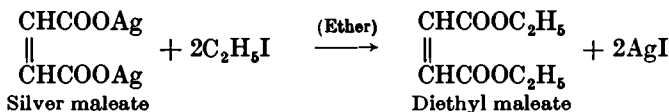

The method is generally applicable when other modes of esterification are either slow, inefficient, or likely to cause isomerisation; it is, however, time-consuming and expensive. Small quantities of acid impurities are sometimes produced, hence it is advisable to wash the ester with saturated sodium bicarbonate solution. The silver salt can usually be prepared by dissolving the acid in the calculated quantity of standard ammonium hydroxide solution and

adding an excess of silver nitrate solution: the precipitated salt is washed with water and dried at 40-50° or in a vacuum desiccator. It must be prepared in the dark.

3. From the nitrile. By refluxing a mixture of the nitrile with alcohol and concentrated sulphuric acid; the intermediate isolation of the acid is unnecessary. The net result may be represented by, for example:

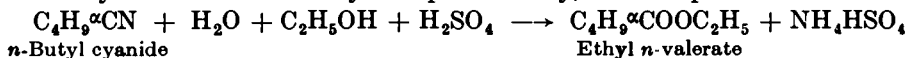

Two mechanisms of the transformation have been proposed:

(a) The intermediate formation of an amide:

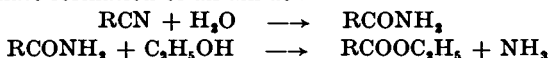

(b) The intermediate formation of an imino-ether:

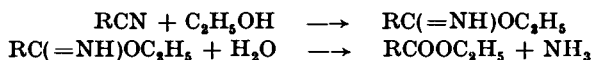

4. From the acid chloride. By the interaction of the acid chloride (prepared from the acid and thionyl chloride) and the calculated quantity of the alcohol at 0°, for example:

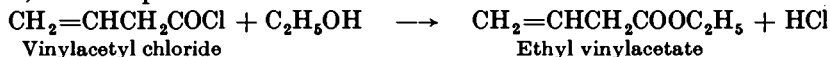

This procedure is generally applied to the esterification of highly sensitive acids, which might otherwise undergo isomerisation. Thus in the example given, no ethyl crotonate is formed.

III,95.

n-BUTYL ACETATE

Mix together 37 g. (46 ml.) of *n*-butyl alcohol and 60 g. (60 ml.) of glacial acetic acid in a 250 or 500 ml. round-bottomed flask, and add cautiously 1 ml. of concentrated sulphuric acid (use a small measuring cylinder or a burette or a calibrated dropper pipette). Attach a reflux condenser and reflux the mixture on a wire gauze for 3-6 hours (1). Pour the mixture into about 250 ml. of water in a separatory funnel, remove the upper layer of crude ester, and wash it again with about 100 ml. of water, followed by about 25 ml. of saturated sodium bicarbonate solution and 50 ml. of water. The ester must, of course, be separated between each washing. Dry the crude ester with 5-6 g. of anhydrous sodium or magnesium sulphate. Filter through a small funnel containing a fluted filter paper (Section II,29) or a small plug of cotton or glass wool into a dry 100 ml. distilling flask. Add 2-3 fragments of porous porcelain and distil on a wire gauze or from an air bath (Fig. II, 5, 3). Collect the pure *n*-butyl acetate at 124-125°. The yield is 40 g.

Note.

(1) A slightly better yield of ester can be obtained by increasing the quantity of acetic acid to 90-120 g. and refluxing for 12-18 hours. This modification is not worth while in a student's preparation.

COGNATE PREPARATIONS

sec.-Butyl acetate. Pass dry hydrogen chloride gas into 37 g. (46 ml.) of *sec.*-butyl alcohol until 1.5 g. is absorbed. Mix the solution with

60 g. of glacial acetic acid, and reflux for 10 hours. Isolate the ester as for *n*-butyl acetate. B.p. 110–112°. Yield: 35 g.

***n*-Propyl acetate.** Use 40 g. (50 ml.) of *n*-propyl alcohol, 160 g. of glacial acetic acid and 2 g. of concentrated sulphuric acid. Reflux for 12 hours. Add an equal volume of water, saturate with salt to isolate the crude ester. Treat the crude ester with saturated sodium bicarbonate solution until effervescence ceases, saturate with salt, remove the ester and dry it with anhydrous sodium or magnesium sulphate. B.p. 101–102°. Yield: 36 g.

***iso*-Propyl acetate.** Use 40 g. (51 ml.) of *iso*-propyl alcohol, 160 g. of glacial acetic acid and 2 g. of concentrated sulphuric acid. Reflux for 18 hours. Proceed as for *n*-propyl acetate. B.p. 87–88°. Yield: 31 g.

***n*-Amyl acetate.** Use 40 g. (49 ml.) of *n*-amyl alcohol, 120 g. of glacial acetic acid and 2.5 g. of concentrated sulphuric acid, and reflux for 20 hours. Isolate the ester as for *n*-butyl acetate. B.p. 146–148°. Yield: 47 g.

Methyl acetate. Use 48 g. (61 ml.) of absolute methyl alcohol, 270 g. of glacial acetic acid and 3 g. of concentrated sulphuric acid. Reflux for 5 hours. Distil the reaction mixture through a simple fractionating column (*e.g.*, a Hempel column filled with $\frac{1}{4}$ " glass or porcelain rings, or an all-glass Dufton column); the crude ester passes over at 55–56° (112 g.) and the excess of acid, etc., remaining in the flask weighs 209 g. Wash once with a *little* water, saturate with salt, wash with saturated sodium bicarbonate solution, saturate with salt, remove the ester layer, and dry with anhydrous sodium and magnesium sulphate, and distil. The methyl acetate passes over constantly at 55–56°. The yield is 92 g.

Ethyl acetate. Use 58 g. (73.5 ml.) of absolute ethyl alcohol, 225 g. of glacial acetic acid and 3 g. of concentrated sulphuric acid. Reflux for 6–12 hours. Work up as for *n*-propyl acetate. B.p. 76–77°. Yield: 32 g. Much ethyl acetate is lost in the washing process. A better yield may be obtained, and most of the excess of acetic acid may be recovered, by distilling the reaction mixture through an efficient fractionating column and proceeding as for methyl acetate.

Ethyl *n*-butyrate. Use a mixture of 88 g. (92 ml.) of *n*-butyric acid, 23 g. (29 ml.) of ethanol and 9 g. (5 ml.) of concentrated sulphuric acid. Reflux for 14 hours. Pour into excess of water, wash several times with water, followed by saturated sodium bicarbonate solution until all the acid is removed, and finally with water. Dry with anhydrous magnesium sulphate, and distil. The ethyl *n*-butyrate passes over at 119.5–120.5°. Yield: 40 g. An improved yield can be obtained by distilling the reaction mixture through an efficient fractionating column until the temperature rises to 125°, and purifying the crude ester as detailed above under methyl acetate.

III,96.

tert.-BUTYL ACETATE

Method A. Fit a 1-litre three-necked flask with a mercury-sealed stirrer, a reflux condenser, and a dropping funnel. Place 57 g. (73.5 ml.) of dry *tert.*-butyl alcohol (1), 101 g. (106 ml.) of A.R. dimethylaniline and 100 ml. of anhydrous ether in the flask, set the stirrer in motion, and

heat the mixture to gentle refluxing on a water bath. Run in 62 g. (56.5 ml.) of redistilled acetyl chloride at such a rate that moderate refluxing continues after the source of heat is removed. When about two-thirds of the acetyl chloride has been introduced, the dimethylaniline hydrochloride commences to crystallise and the mixture refluxes very vigorously. Cool immediately in an ice bath, and, after refluxing ceases, add the remainder of the acetyl chloride; then heat the mixture on a water bath for 1 hour. Cool to room temperature, add about 100 ml. of water, and continue the stirring until all the precipitated solid has dissolved. Separate the ether layer and extract with 25 ml. portions of cold 10 per cent. sulphuric acid until the acid extract does not become cloudy when rendered alkaline with sodium hydroxide solution. Finally, wash with 15 ml. of saturated sodium bicarbonate solution and dry the ethereal solution with 5 g. of anhydrous magnesium sulphate overnight. Remove the ether by distillation through an efficient fractionating column (*e.g.*, of the Widmer type) and distil the residue through the same column. Collect the *tert.*-butyl acetate at 96–98° (mainly 97–98°). The yield is 55 g.

Note.

(1) The *tert.*-butyl alcohol should be dried over quicklime or anhydrous calcium sulphate and distilled.

COGNATE PREPARATION

***tert.*-Butyl propionate.** Use 85.5 g. (110.5 ml.) of *tert.*-butyl alcohol, 151.5 g. (159 ml.) of A.R. dimethylaniline, and 110 g. (103 ml.) of propionyl chloride (compare Section III,87) and reflux for 3 hours. B.p. 117.5–118.5°. Yield: 92 g.

Method B. Fit a 500 ml. round-bottomed flask with a reflux condenser carrying a cotton wool or calcium chloride guard tube. Place 100 ml. of redistilled acetic anhydride, 100 ml. of dry *tert.*-butyl alcohol (see *Note in Method A*) and 0.3 g. of anhydrous zinc chloride in the flask and shake. Heat the mixture gradually to the reflux temperature, maintain at gentle refluxing for 2 hours, and then cool. Replace the reflux condenser by an efficient fractionating column and distil until the temperature reaches 110°. Wash the crude distillate, weighing 100–125 g., with two 25 ml. portions of water, then with 25 ml. portions of 10 per cent. potassium carbonate solution until the ester layer is neutral to litmus, and finally dry with 10 g. of anhydrous potassium carbonate. Filter off the desiccant, and distil through an efficient fractionating column (*e.g.*, Widmer column, modified Hempel column, etc.; compare Section II,17) and collect the pure *tert.*-butyl acetate at 96–98°. The yield is 70 g.

III,97.

n-BUTYL FORMATE

Into a 250 or 500 ml. round-bottomed flask provided with a reflux condenser place 46 g. (38 ml.) of A.R. formic acid (98/100 per cent.) and 37 g. (46 ml.) of *n*-butyl alcohol. Reflux for 24 hours. Wash the cold mixture with small volumes of saturated sodium chloride solution, then with saturated sodium bicarbonate solution in the presence of a little

solid sodium bicarbonate until effervescence ceases, and finally with saturated sodium chloride solution. Dry with anhydrous sodium or magnesium sulphate, and distil from a Claisen flask with fractionating side arm. Collect the *n*-butyl formate at 106–107°. Yield : 38 g.

COGNATE PREPARATIONS

Ethyl formate. Reflux a mixture of 61 g. (50 ml.) of A.R. formic acid (98/100 per cent.) and 31 g. (39.5 ml.) of absolute ethyl alcohol for 24 hours. Transfer to a Claisen flask with fractionating side arm (or attach a fractionating column to the flask), distil and collect the liquid passing over below 62°. Wash the distillate with saturated sodium bicarbonate solution and saturate with salt before removing the ester layer. Dry with anhydrous sodium or magnesium sulphate, filter, and distil. The ethyl formate passes over at 53–54°. The yield is 36 g.

***n*-Propyl formate.** Use 46 g. (38 ml.) of A.R. formic acid (98/100 per cent.) and 30 g. (37.5 ml.) of *n*-propyl alcohol, and reflux for 24 hours. Proceed as for ethyl formate, but collect the crude *n*-propyl formate up to 86°. B.p. 80.5–82°. Yield : 28 g.

III,98.

cycloHEXYL ACETATE

Pass dry hydrogen chloride into 75 g. of pure *cyclohexanol* until 1.5 g. are absorbed, mix with 135 g. of glacial acetic acid in a 500 ml. round-bottomed flask, attach a reflux condenser, and reflux for 14 hours. Pour into excess of water, wash the upper layer successively with water, saturated sodium bicarbonate solution until effervescence ceases, and water. Dry with anhydrous calcium chloride. Distil through a well-lagged fractionating column (*e.g.*, an all-glass Dufton column). A small fraction of low boiling point (containing *cyclohexene*) passes over first, followed by *cyclohexyl acetate* (57 g.) at 168–170°. Upon redistillation from a Claisen flask, the boiling point is 170–172°, mainly 171–172° (1).

Note.

(1) Boiling points over the range 150–200° appear to be about 2° lower when determined by distillation through an efficient, lagged fractionating column.

COGNATE PREPARATION

cycloHexyl formate. Use 103 g. (84.5 ml.) of A.R. formic acid (98/100 per cent.) and 75 g. of *cyclohexanol* in which 1.5 g. of dry hydrogen chloride gas are dissolved. Reflux for 14 hours. Work up as above and distil through a well-lagged column; 5.5 g. of *cyclohexene* and 57 g. of *cyclohexyl formate*, b.p. 156–158.5° (mainly 157–158.5°) are obtained. When distilled from a Claisen flask, the sample boils at 158–160° (mainly 159–160°).

III,99. DIETHYL ADIPATE (*Azeotropic Mixture Method*)

Place 146 g. of adipic acid, 360 ml. (285 g.) of absolute ethyl alcohol 180 ml. of toluene and 1.5 g. of concentrated sulphuric acid in a 1-litre round-bottomed flask, attach a *short* fractionating column connected to a downward condenser, and heat in an oil bath at 115°. When the acid

has dissolved, an azeotropic mixture of alcohol, toluene and water commences to distil at 75°; the temperature of the oil bath may then be lowered to 100–110°. Collect the distillate in a flask containing 150 g. of anhydrous potassium carbonate. Continue the distillation until the temperature at the top of the column rises to 78°. Shake the distillate thoroughly with the potassium carbonate, filter through a Buchner funnel or fluted filter paper, and return the filtrate to the flask. Heat the flask again until the temperature rises to 78–80° (1). Transfer the warm solution to a Claisen flask of suitable size and distil under reduced pressure. Alcohol and toluene pass over first, the temperature rises abruptly and the ethyl adipate distils at 138°/20 mm. (2). The yield is 195 g.

Notes.

(1) The distillate contains alcohol, toluene and water, and may be dried with anhydrous potassium carbonate and used again for esterification after the addition of the necessary quantity of alcohol; alternatively, the toluene may be recovered by washing with water, drying with anhydrous calcium chloride or anhydrous magnesium sulphate, and distilling.

(2) The b.p. may rise several degrees towards the end of the distillation owing to superheating.

III,100. DIETHYL ADIPATE (*Benzene Method*)

Place 100 g. of adipic acid in a 750 ml. round-bottomed flask and add successively 100 g. (127 ml.) of absolute ethyl alcohol, 250 ml. of sodium-dried benzene and 40 g. (22 ml.) of concentrated sulphuric acid (the last-named cautiously and with gentle swirling of the contents of the flask). Attach a reflux condenser and reflux the mixture gently for 5–6 hours. Pour the reaction mixture into excess of water (2–3 volumes), separate the benzene layer (1), wash it with saturated sodium bicarbonate solution until effervescence ceases, then with water, and dry with anhydrous magnesium or calcium sulphate. Remove most of the benzene by distillation under normal pressure until the temperature rises to 100° using the apparatus of Fig. II, 13, 4 but substituting a 250 ml. Claisen flask for the distilling flask; then distil under reduced pressure and collect the ethyl adipate at 134–135°/17 mm. The yield is 130 g.

Note.

(1) One extraction of the aqueous solution with ether is recommended.

COGNATE PREPARATIONS

Diethyl oxalate. Reflux a mixture of 45 g. of anhydrous oxalic acid (1), 81 g. (102.5 ml.) of absolute ethyl alcohol, 190 ml. of sodium-dried benzene and 30 g. (16.5 ml.) of concentrated sulphuric acid for 24 hours. Work up as for *Diethyl Adipate* and extract the aqueous layer with ether; distil under atmospheric pressure. The yield of ethyl oxalate, b.p. 182–183°, is 57 g.

Note.

(1) Anhydrous oxalic acid may be prepared by heating the finely-powdered A.R. crystallised acid, spread upon large clock glasses, in an electric oven at 105° for 6 hours, allowing to cool in a desiccator and storing in a tightly stoppered bottle.

Diethyl succinate. Reflux a mixture of 58 g. of A.R. succinic acid, 81 g. (102.5 ml.) of absolute ethyl alcohol, 190 ml. of sodium-dried

benzene and 20 g. (11 ml.) of concentrated sulphuric acid for 8 hours. Pour the reaction mixture into excess of water, separate the benzene-ester layer, and extract the aqueous layer with ether. Work up the combined ether and benzene extracts as described for *Diethyl Adipate*. B.p. 81°/3 mm. Yield: 75 g. The boiling point under atmospheric pressure is 217–218°.

Diethyl sebacate. *Method A.* Reflux a mixture of 100 g. of sebacic acid, 81 g. (102.5 ml.) of absolute ethyl alcohol, 190 ml. of sodium-dried benzene and 20 g. (11 ml.) of concentrated sulphuric acid for 36 hours. Work up as for *Diethyl Adipate*. B.p. 155–156°/6 mm. Yield: 114 g.

Method B. Reflux a mixture of 101 g. of sebacic acid, 196 g. (248 ml.) of absolute ethyl alcohol and 20 ml. of concentrated sulphuric acid for 12 hours. Distil off about half of the alcohol on a water bath dilute the residue with 500–750 ml. of water, remove the upper layer of crude ester, and extract the aqueous layer with ether. Wash the combined ethereal extract and crude ester with water, then with saturated sodium bicarbonate solution until effervescence ceases, and finally with water. Dry with anhydrous magnesium or sodium sulphate, remove the ether on a water bath, and distil the residue under reduced pressure. B.p. 155–157°/6 mm. Yield: 110 g.

III,101.

n-PROPYL *n*-VALERATE

Place a mixture of 25.5 g. of *n*-valeric acid (Sections III,83 and III,84), 30 g. (37.5 ml.) of dry *n*-propyl alcohol, 50 ml. of sodium-dried benzene and 10 g. (5.5 ml.) of concentrated sulphuric acid in a 250 ml. round-bottomed flask equipped with a vertical condenser, and reflux for 36 hours. Pour into 250 ml. of water and separate the upper layer. Extract the aqueous layer with ether, and add the extract to the benzene solution. Wash the combined extracts with saturated sodium bicarbonate solution until effervescence ceases, then with water, and dry with anhydrous magnesium sulphate. Remove the low boiling point solvents by distillation (use the apparatus of Fig. II, 13, 4 but with a Claisen flask replacing the distilling flask); the temperature will rise abruptly and the *n*-propyl *n*-valerate will pass over at 163–164°. The yield is 28 g.

III,102. *iso*PROPYL LACTATE (*Ion Exchange Resin Catalyst Method*)

Place a mixture of 53 g. of A.R. lactic acid (85–88 per cent. acid), 75 g. (85.5 ml.) of commercial anhydrous *isopropyl* alcohol, 300 ml. of benzene and 20 g. of Zeo-Karb 225/H (1) in a 700 ml. bolt-head flask, equipped with an automatic water separator (e.g., a large modified Dean and Stark apparatus with a stopcock at the lower end, see Fig. III, 126, 1) carrying an efficient reflux condenser at its upper end, and a mercury-sealed stirrer (alternatively, the liquid-sealed stirrer shown in Fig. II, 7, 11, c. may be used). Reflux the mixture, with stirring, on a steam bath for 5 hours or until water no longer collects in appreciable amount in the water separator; run off the water from time to time. Filter off the resin at the pump and wash it with two 25 ml. portions of benzene. Shake the combined filtrate and washings with about 5 g. of precipitated calcium

carbonate, filter, and wash with a little benzene. Distil the benzene solution under reduced pressure (water pump) from a Claisen flask with fractionating side arm; the *isopropyl alcohol* - benzene azeotrope (2) passes over first, followed by benzene. Collect the *isopropyl lactate* at 76°/24 mm.; it is a colourless liquid and weighs 40 g. The ester boils, with slight decomposition, at 157°/771 mm.

Notes.

(1) The cation exchange resin, hydrogen form, Zeo-Karb 225/H is supplied in small particles (30-80 mesh). If the sodium form of the resin Zeo-Karb 225 (or the equivalent Amberlite IR 105) only is available, it may be converted into the hydrogen form by treating it with about twice its volume of 2*N* sulphuric acid and stirring frequently: the resin is thoroughly washed by decantation with distilled water until the washings have a pH of 6-7, filtered and dried in the air.

(2) The b.p. of the *isopropyl* - benzene azeotrope at atmospheric pressure is 71-72°.

COGNATE PREPARATIONS

***n*-Butyl oleate.** Proceed as for *isoPropyl Lactate* using 26.5 g. of redistilled oleic acid, 37.0 g. (45.8 ml.) of *n*-butyl alcohol (the excess of the latter acts as the water carrier) and 8.0 g. of Zeo-Karb 225/H in a 250 ml. bolt-head flask. Reflux the mixture with stirring for 4 hours, allow to cool, separate the resin by suction filtration, and wash it with three 5 ml. portions of *n*-butyl alcohol. Remove the *n*-butyl alcohol from the combined filtrate and washings by distillation under reduced pressure (water pump); the residue consists of crude ester. Distil the residue under diminished pressure (oil pump) and collect the *n*-butyl oleate at 232°/9 mm. The yield is 27 g.

Furfuryl acetate. Reflux a mixture of 39.2 g. (34.8 ml.) of redistilled furfuryl alcohol, 48 g. of glacial acetic acid, 150 ml. of benzene and 20 g. of Zeo-Karb 225/H in a 500 ml. bolt-head flask, using the apparatus described under *isoPropyl Lactate*. After 3 hours, when the rate of collection of water in the water separator is extremely slow, allow to cool, separate the resin by suction filtration, and wash it with three 15 ml. portions of benzene. Remove the benzene, etc., from the combined filtrate and washings under reduced pressure (water pump) and then collect the crude ester at 74-90°/10 mm.; a small solid residue remains in the flask. Redistil the crude ester from a Claisen flask with fractionating side arm; pure furfuryl acetate passes over at 79-80°/17 mm. The yield is 14.5 g.

III,103. DIETHYL MALEATE (*Silver Salt Method*)

Preparation of silver maleate. Dissolve 65 g. of pure maleic acid (Section III,143) in the calculated quantity of carefully standardised 3.5*N* aqueous ammonia solution in a 1-litre beaker and add, whilst stirring mechanically, a solution of 204 g. of silver nitrate in 200 ml. of water. Filter off the precipitated silver maleate at the pump, wash it with distilled water, and press well with the back of a large flat glass stopper. Dry in an electric oven at 50-60° to constant weight. The yield of the dry silver salt is 150 g. Store in a vacuum desiccator in the dark.

In a 500 ml. round-bottomed flask, provided with a reflux condenser protected by a cotton wool (or calcium chloride) guard tube, place 90 g. of silver maleate, 84 g. (43.5 ml.) of colourless, dry ethyl iodide and 50 ml. of sodium-dried A.R. benzene. Within a short period of mixing a vigorous reaction sets in and it is necessary to cool the flask in running water. When the reaction has subsided, the mixture possesses the yellow colour of silver iodide. Reflux on a water bath for 10 hours. Filter at the pump on a sintered glass funnel and keep the benzene solution of the ester separately. Wash the solid well with rectified spirit and pour the washings into excess of water; separate the benzene layer and add this to the original filtrate. Wash the combined benzene solutions with water, saturated sodium bicarbonate solution, and finally with water; dry with anhydrous magnesium sulphate. Remove the benzene in a 50 ml. Claisen flask (use the apparatus shown in Fig. II, 13, 4) and distil. Diethyl maleate passes over at 219–220°. The yield is 27 g.

Note.

Ethyl maleate of almost equal purity may be obtained by refluxing a mixture of 29 g. of pure maleic acid, 37 g. (47 ml.) of absolute ethyl alcohol, 95 ml. of sodium-dried benzene and 4 ml. of concentrated sulphuric acid for 12 hours. The ester is isolated as described for *Diethyl Adipate* (Section III,100). The yield of diethyl maleate, b.p. 219–220°, is 26 g.

III,104. ETHYL *n*-VALERATE (*from n-Butyl Cyanide*)

Place 200 g. (250 ml.) of rectified spirit in a 1-litre round-bottomed flask fitted with a reflux condenser. Cool in ice and run in, slowly and with frequent shaking, 200 g. (109 ml.) of concentrated sulphuric acid. Add 83 g. (104 ml.) of *n*-butyl cyanide (Section III,113) to the mixture and reflux the whole for 10 hours. Allow to cool, pour the reaction mixture into ice water, separate the upper layer of ester and alcohol, and dry over anhydrous magnesium or calcium sulphate. Distil through a fractionating column and collect the ethyl *n*-valerate at 143–146°. A further amount of the pure ester may be obtained by redrying the fraction of low boiling point and redistilling. The yield is 110 g.

III,105. ETHYL VINYLACETATE (*Acid Chloride Method*)

Fit a reflux condenser and a dropping funnel into the two necks of a 150 ml. Claisen flask and stopper the side arm (compare Fig. III, 31, 1); place 50 g. (31 ml.) of redistilled thionyl chloride in the flask. Drop 30 g. of vinylacetic acid (Section III,144) slowly into the thionyl chloride and when the addition is complete reflux gently for 30 minutes. Rearrange the apparatus and distil the mixture slowly from an air bath (1). The excess of thionyl chloride passes over first, followed by vinylacetyl chloride at 98–99° (27 g.). Place 12.6 g. (16.0 ml.) of absolute ethyl alcohol in a 250 ml. bolt-head flask provided with a reflux condenser and dropping funnel. Cool the flask in ice and introduce the vinylacetyl chloride into the dropping funnel; insert a cotton wool (or calcium chloride) guard tube into the mouth of the funnel. Add the acid chloride dropwise (45 minutes) to the alcohol with frequent shaking. Remove the ice and allow to stand for 1 hour. Pour the reaction mixture into water,

wash with a little sodium bicarbonate solution, then with water, and dry with anhydrous magnesium or calcium sulphate. Distil from a 50 ml. Claisen flask with fractionating side arm, and collect the ethyl vinyl-acetate at 125–127°. The yield is 22 g.

Note.

(1) It is preferable to use an all-glass apparatus for all the operations described in this preparation (see Section II,60).

COGNATE PREPARATION

Ethyl cyclopropane-carboxylate. Use 22 g. of cyclopropane-carboxylic acid (Section V,33) and 40 g. (24.5 ml.) of redistilled thionyl chloride to prepare the acid chloride, b.p. 118–119° (22 g.). Treat the latter with 10.1 g. of absolute ethyl alcohol. The yield of ethyl cyclopropane-carboxylate, b.p. 132–133°, is 13 g.

III,106. REACTIONS AND CHARACTERISATION OF ALIPHATIC ESTERS

Hydrolysis (or saponification) of *n*-butyl acetate. Boil 4–5 g. of *n*-butyl acetate (Section III,95) with 50 ml. of 10 per cent. sodium hydroxide solution under reflux until the odour of the ester can no longer be detected (about 1 hour). Set the condenser for downward distillation and collect the first 10 ml. of distillate. Saturate it with potassium carbonate, allow to stand for 5 minutes, and withdraw all the liquid into a small pipette or dropper pipette. Allow the lower layer of carbonate solution to run slowly into a test-tube, and place the upper layer into a small test-tube or weighing bottle. Dry the alcohol with about one quarter of its bulk of anhydrous potassium carbonate. Remove the alcohol with a dropper pipette and divide it into two parts; use one portion for the determination of the b.p. by the Siwoloboff method (Section II,12) and convert the other portion into the 3 : 5-dinitrobenzoate (Section III, 27) and determine the m.p.

Acidify the residue in the flask with dilute sulphuric acid and distil off 10–15 ml. of the solution. Test a small portion of the distillate for acidity, and also observe the odour. Neutralise the main portion with sodium hydroxide solution (add a drop of phenolphthalein to act as indicator), evaporate to small bulk, and convert the sodium salt into the *p*-bromophenacyl ester or into some other suitable derivative (Section III,85); determine the m.p. of the derivative.

The above example serves to illustrate the basis of the procedure employed for the characterisation of aliphatic esters, *viz.*, hydrolysis to, and identification of, the parent acids and alcohols. Most esters are liquids; a notable exception is dimethyl oxalate, m.p. 54°. Many have pleasant, often fruit-like, odours. Many dry esters react with sodium, but less readily than do alcohols: hydrogen is evolved particularly on warming, and a solid sodio derivative may separate on cooling (*e.g.*, ethyl acetate yields ethyl sodioacetoacetate; ethyl adipate gives ethyl sodio cyclopentanone carboxylate).

In the routine examination of esters it is often a good plan to carry out two hydrolyses, one for the isolation and characterisation of the

parent acid, and the other for the isolation and identification of the parent alcohol.

1. Drop 1 g. of sodium into 10 ml. of ethyl alcohol in a small flask provided with a small water condenser; heat the mixture until all the sodium has dissolved. Cool, and add 1 g. of the ester and 0.5 ml. of water. Frequently the sodium salt of the acid will be deposited either at once or after boiling for a few minutes. If this occurs, filter off the solid at once, wash it with a little absolute ethyl alcohol (or absolute methylated spirit), and convert it into the *p*-bromophenacyl ester, *p*-nitrobenzyl ester or *S*-benzyl-*iso*-thiuronium salt (for experimental details, see Section III,85). If no solid separates, continue the boiling for 30–60 minutes, boil off the alcohol, allow to cool, render the product just neutral to phenolphthalein with dilute sulphuric or hydrochloric acid, convert the sodium salt present in solution into a crystalline derivative (Section III,85), and determine its melting point.

2. Boil 2 g. of the ester with 30 ml. of 10 per cent. sodium or potassium hydroxide solution under reflux for at least 1 hour. If the alcohol formed is water (or alkali) soluble, the completion of the hydrolysis will be indicated by the disappearance of the ester layer. Distil off the liquid through the same condenser and collect the first 3–5 ml. of distillate. If a distinct layer separates on standing (or upon saturation of half the distillate with potassium carbonate), remove this layer with a capillary dropper, dry it with a little anhydrous potassium carbonate or anhydrous calcium sulphate, and determine the b.p. by the Siwoloboff method (Section II,12). Whether an insoluble alcohol separates out or not, prepare a crystalline derivative (*e.g.*, the 3 : 5-dinitrobenzoate, Section III,27) and determine its m.p.

The residue in the flask will contain the sodium (or potassium) salt of the acid together with excess of alkali. Just acidify with dilute sulphuric acid and observe whether a crystalline acid separates; if it does, filter, recrystallise and identify (Section III,85). If no crystalline solid is obtained, the solution may be just neutralised to phenolphthalein and the solution of the alkali salt used for the preparation of a crystalline derivative. This will confirm, if necessary, the results of hydrolysis by method 1. If the time factor is important, either method 1 or the product of the caustic alkali hydrolysis may be used for the identification of the acid.

The following notes may be useful :

(1) The b.p., density and refractive index are valuable constants for the final characterisation of liquid esters.

(2) Some esters, *e.g.*, methyl formate, methyl oxalate, methyl succinate, methyl and ethyl tartrate, are appreciably soluble in water. These are usually easily hydrolysed by alkali.

(3) Of the common esters, methyl oxalate (solid, m.p. 54°) and ethyl oxalate (liquid) give amides almost immediately upon shaking with concentrated ammonia solution. The resulting oxamide, m.p. 417°, is valueless as a derivative. The esters may, however, be easily hydrolysed and identified as above.

(4) If the original ester is a fat or oil and produces an odour of acrolein when heated, it may be a glyceride. Esters of ethylene glycol and of glycol with simple fatty acids are viscous and of high b.p. They are hydrolysed (method 1) and the ethyl alcohol distilled off. The residue is diluted (a soap may be formed) and acidified with hydrochloric acid (Congo red paper). The acid is filtered or

extracted with ether. If no acid can be isolated by these methods, it must be simple and volatile, and should be separated by distillation. The residual aqueous solution of glycol or glycerol is neutralised, evaporated to a syrup on a water bath, and extracted with ethyl alcohol or with ethyl acetate; the alcohol is evaporated and the glycol or glycerol in the residue is identified as usual.

(5) **β -Keto esters** (*e.g.*, ethyl acetoacetate) are soluble in solutions of caustic alkalis but not in sodium carbonate solution. They give colours with freshly prepared ferric chloride solution; a little alcohol should be added to bring the ester into solution. Sodium ethoxide solution reacts to yield sodio compounds, which usually crystallise out in the cold. Phenylhydrazine yields pyrazolones. They are hydrolysed by boiling sulphuric acid to the corresponding ketones, which can be identified as usual (Section III, 74).

(6) **Unsaturated esters** decolourise a solution of bromine in carbon tetrachloride and also neutral potassium permanganate solution.

It is frequently advisable in the routine examination of an ester, and before any derivatives are considered, to determine the saponification equivalent of the ester. In order to ensure that complete hydrolysis takes place in a comparatively short time, the quantitative saponification is conducted with a standardised alcoholic solution of caustic alkali—preferably potassium hydroxide since the potassium salts of organic acids are usually more soluble than the sodium salts. A knowledge of the b.p. and the saponification equivalent of the unknown ester would provide the basis for a fairly accurate approximation of the size of the ester molecule. It must, however, be borne in mind that certain structures may effect the values of the equivalent: thus aliphatic halogenated esters may consume alkali because of hydrolysis of part of the halogen during the determination, nitro esters may be reduced by the alkaline hydrolysis medium, etc.

DETERMINATION OF THE SAPONIFICATION EQUIVALENT OF AN ESTER

The saponification equivalent or the equivalent weight of an ester is that weight in grams of the ester from which one equivalent weight of acid is obtainable by hydrolysis, or that quantity which reacts with one equivalent of alkali. The saponification equivalent is determined in practice by treating a known weight of the ester with a known quantity of caustic alkali used in excess. The residual alkali is then readily determined by titration of the reaction mixture with a standard acid. The amount of alkali that has reacted with the ester is thus obtained: the equivalent can then be readily calculated.

Obtain a 250 ml. round-bottomed flask and attach an efficient reflux condenser to it by means of a clean rubber stopper. (The rubber stopper is cleaned by warming with dilute alkali, and then thoroughly washing with distilled water.) Place the sample of ester in a weighing bottle fitted with a cork carrying a small dropper pipette (compare Fig. II, 27, 1) transfer about 1 g. of the ester, accurately weighed, to the flask. Then introduce 50 ml. of standard 0.5*N* alcoholic potassium hydroxide solution by means of a pipette into the flask, add a few chips of broken glass, attach the reflux condenser, and heat the flask gently on a water bath until hydrolysis is complete (1.5–2 hours). When cold, pour about 50 ml. of distilled water through the condenser, add 2–3 drops of phenolphthalein indicator, and titrate the excess of alkali with standard 0.5*N* or 0.25*N* hydrochloric or sulphuric acid. The end point should be a faint pink. If too much acid is accidentally added, back titrate the excess of

acid with the original alkali. Calculate the saponification equivalent from the expression :

$$\text{Saponification Equivalent} = \frac{\text{Weight of ester} \times 1000}{\text{ML. of } N \text{ KOH used}}$$

The 0.5N alcoholic potassium hydroxide solution is prepared by dissolving 8 g. of potassium hydroxide pellets in 250 ml. of rectified spirit contained in a bottle closed by a cork ; shaking is necessary. After standing for 24 hours, the clear solution is decanted or filtered from the residue of potassium carbonate.

It is essential to standardise the alcoholic potassium hydroxide solution immediately before use by titration with standard 0.5N or 0.25N hydrochloric or sulphuric acid using phenolphthalein as indicator.

Identification of the alcohol components of simple esters. The alcohol components of many simple esters may be identified as the crystalline 3 : 5-dinitrobenzoates (compare Section III,27) by heating them with 3 : 5-dinitrobenzoic acid in the presence of a little concentrated sulphuric acid :

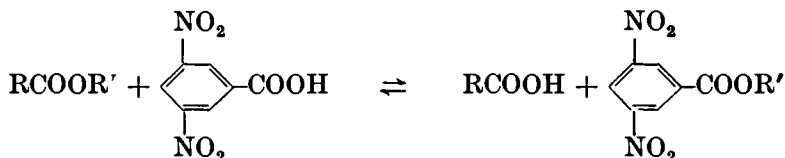

The reaction does not appear to be applicable to esters that react readily with concentrated sulphuric acid nor to those with a molecular weight in excess of about 250.

Dissolve 2 drops of concentrated sulphuric acid in 2 ml. of the ester and add 1.5 g. of 3 : 5-dinitrobenzoic acid. If the b.p. of the ester is below 150°, reflux the mixture gently ; if the b.p. is above 150° heat the mixture, with frequent shaking at first, in an oil bath at about 150°. If the 3 : 5-dinitrobenzoic acid dissolves within 15 minutes, heat the mixture for 30 minutes, otherwise 60 minutes heating is required. Allow the reaction mixture to cool, dissolve it in 25 ml. of ether, and extract thoroughly with 5 per cent. sodium carbonate solution (ca. 25 ml.). Wash the ethereal solution with water, and remove the ether. Dissolve the residue (which is usually an oil) in 5 ml. of hot alcohol, add hot water cautiously until the 3 : 5-dinitrobenzoate commences to separate, cool and stir. Recrystallise the derivative from dilute alcohol : the yield is 0.1-0.2 g.

Successful results have been obtained (Renfrow and Chaney, 1946) with ethyl formate ; methyl, ethyl, *n*-propyl, *iso*-propyl, *n*-butyl, *iso*-butyl, *sec*-butyl and *iso*-amyl acetates ; ethyleneglycol diacetate ; ethyl monochloro- and trichloroacetates ; methyl, *n*-propyl, *n*-octyl and *n*-dodecyl propionates ; ethyl butyrate ; *n*-butyl and *n*-amyl valerates ; ethyl laurate ; ethyl lactate ; ethyl acetoacetate ; diethyl carbonate ; dimethyl and diethyl oxalates ; diethyl malonate ; diethyl adipate ; di-*n*-butyl tartrate ; ethyl phenylacetate ; methyl and ethyl benzoates ; methyl and ethyl salicylates ; diethyl and di-*n*-butyl phthalates. The method fails for vinyl acetate, *tert*-butyl acetate, *n*-octadecyl propionate, ethyl and *n*-butyl stearate, phenyl, benzyl- and guaicol-acetate, methyl and ethyl cinnamate, diethyl sulphate and ethyl *p*-aminobenzoate.

Identification of the acidic components of simple esters. The following procedures may be regarded as alternative to that described above involving hydrolysis of the ester.

Anilides or p-toluidides of acids from esters. Esters are converted into the corresponding anilides or *p*-toluidides by treatment with anilino- or with *p*-toluidino-magnesium bromide, which are readily obtained from any simple Grignard reagent and aniline or *p*-toluidine :

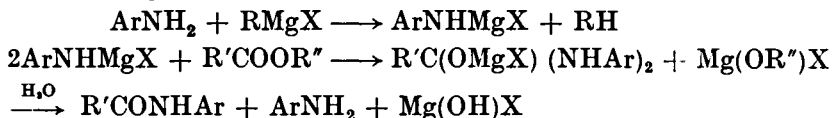

This procedure is speedy, economical, and employs materials which are readily available. It is not satisfactory for esters of dibasic acids.

Add 4.0 g. (4.0 ml.) of pure aniline dropwise to a cold solution of ethyl magnesium bromide (or iodide) prepared from 1.0 g. of magnesium, 5.0 g. (3.5 ml.) of ethyl bromide (or the equivalent quantity of ethyl iodide), and 30 ml. of pure, sodium-dried ether. When the vigorous evolution of ethane has ceased, introduce 0.02 mol of the ester in 10 ml. of anhydrous ether, and warm the mixture on a water bath for 10 minutes ; cool. Add dilute hydrochloric acid to dissolve the magnesium compounds and excess of aniline. Separate the ethereal layer, dry it with anhydrous magnesium sulphate and evaporate the ether. Recrystallise the residual anilide, which is obtained in almost quantitative yield, from dilute alcohol or other suitable solvent.

Alternatively, add a solution of 4.5 g. of *p*-toluidine in dry ether to the Grignard reagent prepared from 1.0 g. of magnesium as detailed above. Then introduce 1.0 g. (or 0.02 mol) of the ester and proceed as described for anilides.

N-Benzylamides of acids from esters. Esters are converted into the *N*-benzylamides of the corresponding acids by heating with benzylamine in the presence of a little ammonium chloride as catalyst :

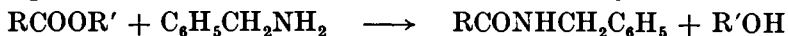

The reaction (which is essentially the direct aminolysis of esters with benzylamine) proceeds readily when R' is methyl or ethyl. Esters of higher alcohols should preferably be subjected to a preliminary methanolysis by treatment with sodium methoxide in methanol :

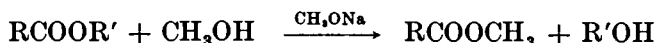

N-Benzylamides are recommended when the corresponding acid is liquid and/or water-soluble so that it cannot itself serve as a derivative. The benzylamides derived from the simple fatty acids or their esters are not altogether satisfactory (see Table below) ; those derived from most hydroxy-acids and from polybasic acids or their esters are formed in good yield and are easily purified. The esters of aromatic acids yield satisfactory derivatives but the method must compete with the equally simple process of hydrolysis and precipitation of the free acid, an obvious derivative when the acid is a solid. The procedure fails with esters of keto, sulphonic, inorganic and some halogenated aliphatic esters.

Reflux a mixture of 1 g. of the ester, 3 ml. of benzylamine and 0.1 g. of powdered ammonium chloride for 1 hour in a Pyrex test-tube fitted with a short condenser. Wash the cold reaction mixture with water to remove the excess of benzylamine. If the product does not crystallise, stir it with a little water containing a drop or two of dilute hydrochloric acid. If crystallisation does not result, some unchanged ester may be present :

boil with water for a few minutes in an evaporating dish to volatilise the ester. Collect the solid *N*-benzylamide on a filter, wash it with a little light petroleum, b.p. 100–120°, and recrystallise it from dilute alcohol, ethyl acetate or acetone.

If the ester does not yield a benzylamide by this procedure, convert it into the methyl ester by refluxing 1 g. for 30 minutes with 5 ml. of absolute methanol in which about 0.1 g. of sodium has been dissolved. Remove the methanol by distillation and treat the residual ester as above.

The melting points of the *N*-benzylamides are collected in the following Table :

N-BENZYLAMIDES OF SOME CARBOXYLIC ACIDS

Formic	60°	Oxalic	223°	Benzoic	106°
Acetic	61	Malonic	142	<i>p</i> -Aminobenzoic	90
Propionic	44	Succinic	206	<i>m</i> -Hydroxybenzoic	142
<i>n</i> -Butyric	38	Glutaric	170	<i>m</i> -Nitrobenzoic	101
<i>iso</i> -Butyric	87	Adipic	189	<i>p</i> -Nitrobenzoic	142
<i>n</i> -Valeric	42	Pimelic	154	<i>o</i> -Iodobenzoic	110
<i>iso</i> -Valeric	54	Sebacic	167	Phenylacetic	122
<i>n</i> -Caproic	53	Carbonic	169	<i>m</i> -Toluic	75
Lauric	83	Ethylmalonic	138	<i>p</i> -Toluic	133
Palmitic	95	<i>n</i> -Butylmalonic	149	Anisic	132
Myristic	90	<i>d</i> -Tartaric	199	Salicylic	136
Stearic	97	<i>dl</i> -Tartaric	210	Anthranilic	125
Glycollic	104	<i>meso</i> -Tartaric	205	Cinnamic	225
Cyanoacetic	124	<i>d</i> -Malic	157	Hydrocinnamic	85
Crotonic	114	Maleic	150	Phthalic	179
2-Furoic	111	Funaric	205	Terephthalic	266
Acrylic	237	Citric	170		
		Saccharic	201		

Acid hydrazides from esters. Methyl and ethyl esters react with hydrazine to give acid hydrazides :

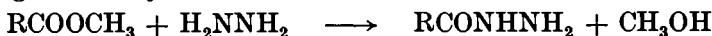

The hydrazides are often crystalline and then serve as useful derivatives. Esters of higher alcohols should be converted first to the methyl esters by boiling with sodium methoxide in methanol (see under *N*-benzylamides).

Place 1.0 ml. of hydrazine hydrate (*CAUTION* : corrosive chemical) in a test-tube fitted with a short reflux condenser. Add 1.0 g. of the methyl or ethyl ester dropwise (or portionwise) and heat the mixture gently under reflux for 15 minutes. Then add just enough absolute ethanol through the condenser to produce a clear solution, reflux for a further 2–3 hours, distil off the ethyl alcohol, and cool. Filter off the crystals of the acid hydrazide, and recrystallise from ethanol, dilute ethanol or from water.

The melting points of the hydrazides of some acids are collected in Table III,85.

In Table III,106 the boiling points, densities and refractive indices of a number of selected esters are collected.

TABLE III,106.

ALIPHATIC ESTERS

Ester	B.P.	d_{4}^{20}	n_D^{20}
Methyl formate	32°	0.974	1.344
Ethyl formate	53	0.923	1.360
<i>n</i> -Propyl formate	81	0.904	1.377
<i>iso</i> -Propyl formate	71	0.873	1.368
<i>n</i> -Butyl formate	106	0.892	1.389
<i>iso</i> -Butyl formate	98	0.876	1.386
<i>sec.</i> -Butyl formate	97	0.884	1.384
<i>tert.</i> -Butyl formate	83	—	—
<i>n</i> -Amyl-formate	131	0.885	1.400
<i>iso</i> -Amyl formate	124	0.882	1.398
<i>n</i> -Hexyl formate	154	0.879	1.407
<i>cyclo</i> Pentyl formate	138	1.000	1.432
<i>cyclo</i> Hexyl formate	161	0.994	1.443
Allyl formate	84	0.946	—
Methyl acetate	56	0.939	1.362
Ethyl acetate	77	0.901	1.372
<i>n</i> -Propyl acetate	101	0.887	1.384
<i>iso</i> -Propyl acetate	88	0.872	1.377
<i>n</i> -Butyl acetate	124	0.881	1.394
<i>iso</i> -Butyl acetate	116	0.871	1.390
<i>sec.</i> -Butyl acetate	112	0.872	1.389
<i>tert.</i> -Butyl acetate	97	0.867	1.386
<i>n</i> -Amyl acetate	148	0.875	1.402
<i>iso</i> -Amyl acetate	141	0.872	1.400
<i>n</i> -Hexyl acetate	169	0.872	1.409
<i>cyclo</i> Pentyl acetate	153	0.975	1.432
<i>cyclo</i> Hexyl acetate	172	0.970	1.442
Allyl acetate	104	0.928	1.404
Tetrahydrofurfuryl acetate	195	1.061	1.438
Furfuryl acetate	176	1.118	—
Methyl propionate	79	0.915	1.377
Ethyl propionate	98	0.892	1.384
<i>n</i> -Propyl propionate	122	0.882	1.393
<i>iso</i> -Propyl propionate	111	—	—
<i>n</i> -Butyl propionate	145	0.875	1.401
<i>n</i> -Amyl propionate	169	0.881	—
<i>iso</i> -Amyl propionate	160	0.859	1.412
<i>n</i> -Hexyl propionate	190	0.870	1.419
Allyl propionate	123	0.914	1.410
Methyl <i>n</i> -butyrate	102	0.898	1.387
Ethyl <i>n</i> -butyrate	120	0.879	1.392
<i>n</i> -Propyl <i>n</i> -butyrate	142	0.872	1.400
<i>iso</i> -Propyl <i>n</i> -butyrate	128	—	—
<i>n</i> -Butyl <i>n</i> -butyrate	165	0.869	1.406
<i>n</i> -Amyl <i>n</i> -butyrate	185	0.866	1.412
<i>iso</i> -Amyl <i>n</i> -butyrate	179	0.864	1.411
<i>n</i> -Hexyl <i>n</i> -butyrate	208	0.866	1.420
Allyl <i>n</i> -butyrate	142	0.902	1.416
Methyl <i>iso</i> -butyrate	91	0.888	1.383
Ethyl <i>iso</i> -butyrate	110	0.869	1.387

TABLE III,106. ALIPHATIC ESTERS (*continued*)

Ester	B.P.	d_{4}^{20}	n_{D}^{20}
<i>n</i> -Propyl <i>iso</i> -butyrate	134°	0·864	1·396
<i>iso</i> -Propyl- <i>iso</i> -butyrate	121	—	—
<i>n</i> -Butyl <i>iso</i> -butyrate	156	0·862	1·402
Methyl <i>n</i> -valerate	127	0·890	1·397
Ethyl <i>n</i> -valerate	144	0·874	1·400
<i>n</i> -Propyl <i>n</i> -valerate	164	0·870	1·407
<i>iso</i> -Propyl <i>n</i> -valerate	154	0·858	1·401
<i>n</i> -Butyl <i>n</i> -valerate	184	0·868	1·412
Methyl <i>iso</i> -valerate	116	0·881	1·393
Ethyl <i>iso</i> -valerate	133	0·865	1·396
<i>n</i> -Propyl <i>iso</i> -valerate	156	0·862	1·403
<i>n</i> -Butyl <i>iso</i> -valerate	176	0·861	1·409
<i>iso</i> -Butyl <i>iso</i> -valerate	171	0·853	1·406
Methyl <i>n</i> -caproate (<i>n</i> -hexoate)	149	0·885	1·405
Ethyl <i>n</i> -caproate	168	0·871	1·407
<i>n</i> -Propyl <i>n</i> -caproate	187	0·867	1·417
<i>n</i> -Butyl <i>n</i> -caproate	208	0·865	1·421
<i>n</i> -Amyl <i>n</i> -caproate	226	0·863	1·426
Methyl <i>n</i> -heptoate (oenanthate)	171	0·882	1·412
Ethyl <i>n</i> -heptoate	186	0·870	1·413
<i>n</i> -Propyl <i>n</i> -heptoate	208	0·866	1·421
<i>n</i> -Butyl <i>n</i> -heptoate	226	0·864	1·426
Methyl <i>n</i> -octoate (<i>n</i> -caprylate)	192	0·878	1·417
Ethyl <i>n</i> -octoate	206	0·869	1·418
Methyl pelargonate (<i>n</i> -nonoate)	214	—	—
Ethyl pelargonate	227	0·866	1·422
Methyl <i>n</i> -decoate (caprate)	228	0·873	1·426
Ethyl <i>n</i> -decoate	242	0·865	1·426
<i>n</i> -Propyl <i>n</i> -decoate	115°/5 mm.	0·862	1·428
<i>n</i> -Butyl <i>n</i> -decoate	123°/4	0·861	1·430
Methyl <i>n</i> -dodecanoate (laurate)	262	0·870	1·432
Ethyl <i>n</i> -dodecanoate	273	0·862	1·431
<i>n</i> -Propyl <i>n</i> -dodecanoate	140°/4	0·862	1·434
<i>n</i> -Butyl <i>n</i> -dodecanoate	154°/5	0·860	1·436
Methyl stearate	M.p. 39	—	—
Ethyl stearate	M.p. 33	—	—
Methyl chloroacetate	129	1·234	1·422
Ethyl chloroacetate	142	1·150	1·422
Methyl dichloroacetate	143	1·377	1·443
Ethyl dichloroacetate	156	1·283	1·438
Methyl trichloroacetate	152	1·488	1·457
Ethyl trichloroacetate	164	1·380	1·450
Methyl bromoacetate	144 (d)	—	—
Ethyl bromoacetate	169	1·506	1·451

TABLE III,106. ALIPHATIC ESTERS (*continued*)

Ester	B.P.	d_4^{20}	n_D^{20}
Methyl iodoacetate	170°	—	—
Ethyl iodoacetate	180	1.818*	1.508*
Methyl chlorocarbonate (chloroformate)	73	1.223	1.387
Ethyl chlorocarbonate	94	1.136	1.397
<i>n</i> -Propyl chlorocarbonate	115	1.090	1.404
<i>n</i> -Butyl chlorocarbonate	138	1.079	1.412
Methyl carbonate	90	1.071	1.369
Ethyl carbonate	126	0.976	1.384
<i>n</i> -Propyl carbonate	165	0.943	1.400
<i>n</i> -Butyl carbonate	205	0.925	1.412
<i>iso</i> -Butyl carbonate	188	0.914	1.407
Methyl crotonate	119	0.946	1.425
Ethyl crotonate	137	0.918	1.425
<i>n</i> -Propyl crotonate	157	0.908	1.428
<i>n</i> -Butyl crotonate	55°/4 mm.	0.899	1.432
<i>n</i> -Amyl crotonate	72°/5	0.894	1.436
<i>iso</i> -Amyl crotonate	60°/4	0.891	1.434
Methyl lactate	145	1.089	1.414
Ethyl lactate	154	1.030	1.415
Methyl glycollate	151	1.166	—
Ethyl glycollate	160	1.082	—
Methyl furoate	181	1.180	1.486
Ethyl furoate	197	—	—
	(M.p. 34)	1.117†	1.480
Methyl orthoformate	105	0.968	1.379
Ethyl orthoformate	143	0.893	1.390
<i>n</i> -Propyl orthoformate	91°/17	0.879	1.407
<i>n</i> -Butyl orthoformate	127°/16	0.871	1.416
Ethyleneglycol diformate	177	1.229	—
Ethyleneglycol diacetate	190	1.104	1.415
Methyl "cellosolve" acetate	144	1.088	—
"Cellosolve" acetate	156	0.976	—
"Carbitol" acetate	217	1.013	—
<i>n</i> -Butyl "carbitol" acetate	246	0.983	—
Trimethyleneglycol diacetate	210	1.069	—
Propyleneglycol diacetate	191	1.059	1.417
α -Monoaceticin (glycerol 1-acetate)	158°/15	1.206	1.416
Diacetin (mixture of $\alpha\alpha$ and $\alpha\beta$)	143°/12	1.180	—
Triacetin (glycerol triacetate)	153°/22	1.161	—
Methyl oxalate	M.p. 54	—	—
Ethyl oxalate	183	1.079	1.410
<i>n</i> -Propyl oxalate	212	1.019	1.416
<i>iso</i> -Propyl oxalate	191	0.995	1.413
<i>n</i> -Butyl oxalate	241	0.987	1.423
<i>n</i> -Amyl oxalate	139°/9	0.966	1.429
<i>iso</i> -Amyl oxalate	127°/7	0.961	1.427

* (13°)

† Values at 21° with supercooled liquid.

TABLE III,106. ALIPHATIC ESTERS (*continued*)

Ester	B.P.	d_4^{20}	n_D^{20}
Methyl malonate	179°	1.119	1.420
Ethyl malonate	197	1.055	1.414
Methyl succinate	195	1.120	1.420
Ethyl succinate	218	1.042	1.420
<i>n</i> -Propyl succinate	102°/3 mm.	1.006	1.425
<i>iso</i> -Propyl succinate	82°/3	0.985	1.418
<i>n</i> -Butyl succinate	120°/3	0.977	1.430
<i>iso</i> -Butyl succinate	116°/4	0.968	1.427
<i>n</i> -Amyl succinate	129°/2	0.960	1.434
<i>iso</i> -Amyl succinate	130°/4	0.958	1.434
Allyl succinate	104	1.051	1.452
Methyl glutarate	109°/21	1.087	1.424
Ethyl glutarate	118°/15	1.023	1.424
Methyl adipate	121°/17	1.063	1.428
Ethyl adipate	134°/17	1.009	1.428
<i>n</i> -Propyl adipate	146°/9	0.981	1.431
<i>iso</i> -Propyl adipate	120°/6	0.966	1.425
<i>n</i> -Butyl adipate	159°/17	0.945	1.435
<i>n</i> -Amyl adipate	186°/10	0.948	1.439
<i>iso</i> -Amyl adipate	184°/13	0.945	1.437
Methyl pimelate	128°/16	1.038	1.431
Ethyl pimelate	149°/18	0.993	1.430
Methyl suberate	120°/6	1.024	1.434
Ethyl suberate	131°/5	0.981	1.432
<i>n</i> -Propyl suberate	165°/8	0.962	1.435
<i>n</i> -Butyl suberate	176°/4	0.948	1.439
Methyl azelate	156°/20	1.007	1.436
Ethyl azelate	291	0.973	1.435

TABLE III.106. ALIPHATIC ESTERS (*continued*)

Ester	B.P.	M.P.	d_4^{20}	n_D^{20}
Methyl sebacate	293°	27°	—	—
Ethyl sebacate	307	—	0.964	1.437
<i>n</i> -Propyl sebacate	179°/5 mm.	—	0.950	1.439
Methyl maleate	201	—	1.150	1.442
Ethyl maleate	220	—	1.066	1.440
<i>n</i> -Propyl maleate	126°/12	—	1.025	1.443
<i>n</i> -Butyl maleate	147°/12	—	0.994	1.445
Methyl fumarate	193	102	—	—
Ethyl fumarate	214	—	1.052	1.441
<i>n</i> -Propyl fumarate	110°/5	—	1.013	1.444
<i>n</i> -Butyl fumarate	139°/5	—	0.987	1.447
Methyl mesaconate	205	—	1.120	1.454
Ethyl mesaconate	225	—	1.043	1.448
Methyl citraconate	210	—	1.112	1.448
Ethyl citraconate	228	—	1.041	1.444
Methyl <i>d</i> -tartrate	280	61	—	—
Ethyl <i>d</i> -tartrate	280	18	1.203	1.447
<i>n</i> -Propyl <i>d</i> -tartrate	297	—	1.139	—
<i>n</i> -Butyl <i>d</i> -tartrate	200°/18	22	—	—
Methyl <i>dl</i> -tartrate	282	90	—	—
Ethyl <i>dl</i> -Tartrate	280	18	1.203	1.447
<i>n</i> -Propyl <i>dl</i> -tartrate	286	25	—	—
<i>n</i> -Butyl <i>dl</i> -tartrate	320	—	1.086	—
Methyl malate	242	—	1.233	1.442
Ethyl malate	253	—	1.129	1.436
Methyl mucate	—	167	—	—
Ethyl mucate	—	164	—	—
Methyl citrate	—	76	—	—
Ethyl citrate	294	—	1.137	1.466

ALIPHATIC AMIDES

Amides of aliphatic acids may be prepared:—

1. By the dehydration of the ammonium salt of the corresponding acid by heat or by distillation, for example :

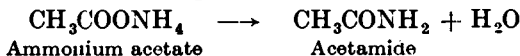

An excess of acetic acid is usually added before heating in order to repress the hydrolysis (and also the thermal dissociation) of the ammonium acetate, thus preventing the escape of ammonia. The excess of acetic acid, together with the water, is removed by slow fractional distillation. The method is rarely used except for the preparation of acetamide.

2. By heating the acid or its ammonium salt with urea :



The reaction commences at about 120°: the carbamic acid formed decomposes immediately into carbon dioxide and ammonia. The latter may form the ammonium salt with unreacted acid; the ammonium salt also reacts with urea at temperatures above 120° to yield the amide :

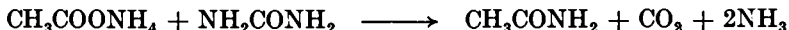

This reaction is applicable to many aliphatic acids and their ammonium salts.

3. By the action of concentrated aqueous ammonia solution upon esters. This process is spoken of as ammonolysis of the ester, by analogy with hydrolysis applied to a similar reaction with water. If the amide is soluble in water, e.g., acetamide, it may be isolated by distillation, for example :

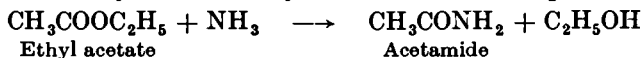

Sparingly soluble amides crystallise out from the reaction mixture upon standing, for example :

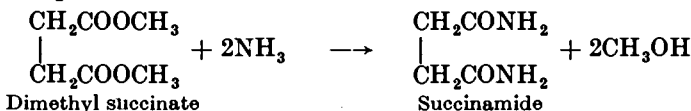

4. By the action of ammonia upon the acid chloride. The acid chloride need not be isolated, and can be obtained either by warming the acid with phosphorus trichloride until action ceases and then pouring off the crude acid chloride from the phosphorous acid, or by refluxing the acid with excess of thionyl chloride, removing the excess of the reagent by fractional distillation or by heating on a water bath. The acid chloride is then added dropwise to a well-stirred concentrated ammonia solution cooled in a freezing mixture of ice and salt. The mixture is allowed to stand overnight and the amide crystallises out. The amides of acetic, propionic and butyric acids are soluble in water and must be isolated by evaporating to dryness and extracting the residue with absolute ethyl alcohol. The following example is given :

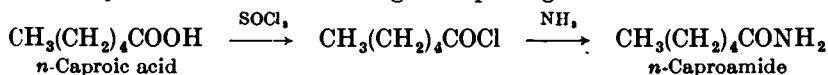

III,107. ACETAMIDE (from Ammonium Acetate or from Acetic Acid)

1. *Ammonium acetate method.* Place 77 g. of ammonium acetate and 84 g. (80 ml.) of glacial acetic acid in a 250 ml. round-bottomed flask (1)

and add a few chips of porous porcelain. Equip the flask with a fractionating column (2) carrying a thermometer and leading to a condenser set for downward distillation (Fig. II, 16, 1). Heat the flask, preferably in an air bath (Fig. II, 5, 3), so that the mixture boils very gently and the vapours do not rise appreciably in the fractionating column. After one hour increase the heat slightly so that the water formed in the reaction and a part of the acetic acid distils off very slowly at a uniform rate: collect the distillate in a 100 ml. measuring cylinder. The temperature rises to about 110° and remains at 110–112° during 2·5 hours; 85 ml. (90 g.) of liquid are collected. The temperature may rise to 115° towards the end of the distillation, but soon drops below 100°, indicating that all the acetic acid has been removed. The residue in the flask crystallises completely upon cooling; it consists of almost pure acetamide and melts at 78° after drying upon a porous tile. The yield of crude acetamide is 68 g. Redistil the crude amide from a 100 ml. distilling (or Claisen) flask equipped with an air condenser. There is a small low boiling point fraction (b.p. up to 195°) consisting of the "hold-up" of the fractionating column, and the acetamide passes over at 195–230°, largely at 215°. The yield of pure colourless acetamide, m.p. 81°, is 57 g.

The acetamide often contains a minute amount of impurity having an odour resembling mice excrement; this can be removed by washing with a small volume of a 10 per cent. solution of ethyl alcohol in ether or by recrystallisation. Dissolve 5 g. of impure acetamide in a mixture of 5 ml. of benzene and 1·5 ml. of dry ethyl acetate; warm on a water bath until all is dissolved and cool rapidly in ice or cold water. Filter off the crystals, press between filter paper and dry in a desiccator. The unpleasant odour is absent and the pure acetamide melts at 81°. Beautiful large crystals may be obtained by dissolving the acetamide (5 g.) in warm methyl alcohol (4 ml.), adding ether (40 ml.) and allowing to stand.

Notes.

(1) If desired, the ammonium acetate may be prepared by adding to 60 g. (57 ml.) of glacial acetic acid, contained in a large dish and gently warmed upon a water bath, solid ammonium carbonate (about 66 g. are required) with stirring until all the acid is neutralised; this may be detected by diluting a sample with a little water and testing with litmus. Add a further 84 g. (80 ml.) of glacial acetic acid to produce a mixture equivalent to that employed in the experiment.

(2) The fractionating column employed by the author was of the Hempel type (Fig. II, 15, 3). The dimensions were: total length, 46 cm.; diameter of column, 20 mm.; diameter of lower end, 10 mm.; effective length of column, *i.e.*, below the side arm, 31 cm.; length filled with hollow glass rings, $\frac{1}{2} \times \frac{1}{4}$ ", 26 cm. Alternatively, an all-glass Dufton column (Fig. II, 15, 2) may be employed.

2. *Urea method.* Place 25 g. of glacial acetic acid and 25 g. of urea in a 100 ml. Claisen flask. Fit an air condenser into the short neck and a 360° thermometer (with bulb in the mixture and 1 cm. from the bottom of the flask) into the long neck; close the side arm with a small cork. Tilt the flask at an angle of about 30° from the vertical so that liquid does not collect in the side arm (compare Fig. III, 31, 1). Heat the mixture gently either on a wire gauze or in an air bath (Fig. II, 5, 3). When the urea melts, shake the flask gently in order to mix the acid and urea layers. Gradually raise the temperature so that the liquid *just* refluxes in the condenser. The temperature is about 150° after 30 minutes and a white

solid (probably ammonium carbamate) commences to form in the condenser : push the solid back into the flask by means of a stout glass rod when complete blocking of the condenser appears likely. Continue the heating until the temperature of the liquid is 195–200° ; this temperature is attained after a heating period of 3–3.5 hours. Both carbon dioxide and ammonia are evolved. Allow the apparatus to cool and rearrange it for distillation. Heat the flask slowly at first ; some ammonium carbamate first sublimes into the air condenser. When the acetamide just reaches the condenser, stop the distillation momentarily, replace the condenser by another of similar size and continue the distillation. Collect the acetamide at 200–216° (most of it passes over at 214–216°) ; if it crystallises in the condenser, it may be melted by the cautious application of a flame. The yield of almost pure, colourless acetamide, m.p. 80.5°, is 22 g. It may be recrystallised, if desired, as detailed under 1.

III,108. ACETAMIDE (*from Ethyl Acetate*)

Mix 44 g. (49 ml.) of pure ethyl acetate and 90 ml. of concentrated ammonia solution (sp. gr. 0.88) in a 250 ml. distilling flask. Place a cork in the neck of the flask and close the side arm (use a small cork or insert into a hole bored part of the way through a larger cork or a short length of rubber tubing closed with a screw clip). Allow the mixture to stand with occasional shaking until it becomes homogeneous (1–2 days : a longer period of standing is not harmful). Arrange the flask for distillation in the fume cupboard using the assembly of Fig. II, 13, 1, but attach the side arm of the filter flask to a device (Fig. II, 8, 1, *a*, *b* or preferably *c*) for the absorption of the ammonia evolved in the first part of the distillation. Distil (best with the aid of an air bath, Fig. II, 5, 3) somewhat rapidly (in order to reduce the losses due to the hydrolysis of the acetamide) until the temperature rises to 170–180° ; empty the water in the jacket of the Liebig condenser when the temperature reaches about 135°. Allow the liquid remaining in the flask to cool somewhat and pour it while still fluid into a dry 100 ml. distilling flask attached to an air condenser ; use a beaker as a receiver. The liquid solidifies completely on cooling and melts at 79–80° after spreading on a porous tile ; it is almost pure acetamide and weighs 25 g. Upon distillation with a naked flame, it passes over almost completely at 216° (1) and solidifies upon cooling to a colourless crystalline solid, m.p. 81°. The yield of pure acetamide is 24 g.

Note.

(1) If the acetamide crystallises in the condenser, it may be melted by the cautious application of a flame.

COGNATE PREPARATION

Succinamide. Add 5 g. (4.8 ml.) of dimethyl succinate to 25 ml. of concentrated ammonia solution (sp. gr. 0.88) in a 100 ml. conical flask. Cork the flask and shake the contents for a few minutes : allow to stand for 24 hours with occasional shaking. Filter off the crystals of succinamide, and wash with a little cold water. Recrystallise from a little hot water. Dry in the steam oven and determine the m.p. The yield is 3.5 g. Pure succinamide melts at 254° with decomposition.

III,109.

n-CAPROAMIDE

Fit a reflux condenser into the short neck of a 125 ml. Claisen flask, a separatory funnel into the long neck, and plug the side arm with a small cork (compare Fig. III, 31, 1). Place 58 g. (62 ml.) of commercial *n*-caproic acid (1) in the flask and heat on a water bath. Add 75 g. (46 ml.) of redistilled thionyl chloride through the separatory funnel during 45 minutes; shake the flask from time to time to ensure thorough mixing. Reflux the mixture for 30 minutes. Arrange the apparatus for distillation from an air bath (Fig. II, 5, 3); the excess of thionyl chloride passes over first, followed by *n*-caproyl chloride at 145–155° (mainly at 150–155°). The yield of acid chloride is 56 g.

Place 125 ml. of concentrated ammonia solution (sp. gr. 0·88) in a 600 ml. beaker and surround the latter with crushed ice. Stir the ammonia solution mechanically, and introduce the *n*-caproyl chloride slowly by means of a suitably supported separatory funnel with bent stem. The rate of addition must be adjusted so that no white fumes are lost. The amide separates immediately. Allow to stand in the ice water for 15 minutes after all the acid chloride has been introduced. Filter off the amide at the pump; use the filtrate to assist the transfer of any amide remaining in the beaker to the filter (2). Spread the amide on sheets of filter or drying paper to dry in the air. The crude *n*-caproamide (30 g.) has m.p. 98–99° and is sufficiently pure for conversion into the nitrile (Section III,112) (3). Recrystallise a small quantity of the amide by dissolving it in the minimum volume of hot water and allowing the solution to cool; dry on filter paper in the air. Pure *n*-caproamide has m.p. 100°.

Notes.

(1) Improved yields may be obtained by first drying the acid either by adding a little anhydrous magnesium or calcium sulphate or by adding about 45 per cent. of its weight of benzene and distilling through a short column until the temperature of the vapour reaches 100° (compare *n*-Valeric Acid, Section III, 84, Note (3)).

(2) The filtrate will deposit small amounts of *n*-caproamide upon concentration to half its original volume.

(3) The process is of general application for higher (*i.e.*, > C₅) fatty acids.

III,110. REACTIONS AND CHARACTERISATION
OF ALIPHATIC AMIDES

The student should carry out the following simple experiments with acetamide or with any other aliphatic amide, *e.g.*, *n*-caproamide; they illustrate some of the general reactions of primary aliphatic amides.

(i) Boil 0·5 g. of acetamide with 3 ml. of 10 per cent. sodium hydroxide solution. Note that ammonia is evolved. Acidify and test for acetic acid in the solution.

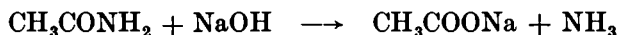

(ii) Boil 0·5 g. of acetamide with 3 ml. of dilute hydrochloric acid (1 : 1) or, better, with 10 per cent. sulphuric acid. Observe that acetic acid is evolved.



(iii) Dissolve 1 g. of acetamide in 2 ml. of water, add about 0.1 g. of yellow mercuric oxide, and warm gently. The mercuric oxide passes into solution, and a water-soluble, non-ionic mercury derivative is produced (compare Section IV,189) :

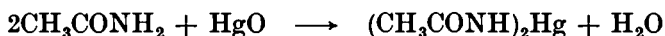

CHARACTERISATION

Aliphatic amides may be hydrolysed by boiling with 10 per cent. sodium hydroxide solution to the corresponding acid (as the sodium salt) : the alkaline solution should be acidified with dilute sulphuric acid; any water-soluble acid may then be distilled from the solution. Alternatively, hydrolysis may be effected with 10–20 per cent. sulphuric acid. The resulting aliphatic acid (usually a liquid) may be characterised as detailed in Section III,85.

Crystalline derivatives may be prepared with xanthhydrol (9-hydroxy-xanthen), but the reagent is comparatively expensive. Xanthhydrol reacts with primary amides with the formation of crystalline xanthylamides or 9-acylamidoxanthenes :

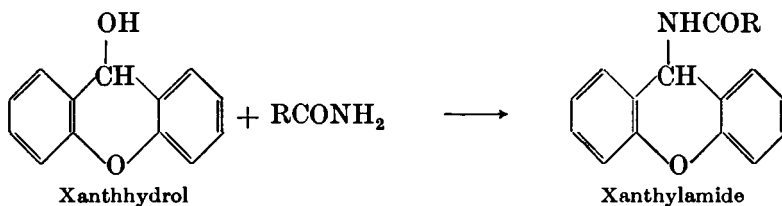

Commercial xanthhydrol may be used, but the pure white product, m.p. 120–121°, obtained by the reduction of xanthone with sodium amalgam (Section VII,16) gives better results.

1. Xanthylamides. Dissolve 0.25 g. of xanthhydrol in 3.5 ml. of glacial acetic acid ; if an oil separates (as is sometimes the case with commercial material), allow to settle for a short time and decant the supernatant solution. Add 0.25 g. of the amide, shake and allow to stand. If a crystalline derivative does not separate in about 10 minutes, warm on a water bath for a period not exceeding 30 minutes, and allow to cool. Filter off the solid xanthylamide (9-acylamidoxanthen) and recrystallise it from dioxan-water or from acetic acid-water, dry at 80° for 15 minutes and determine the m.p.

Some amides do not dissolve in glacial acetic acid ; in such cases a mixture of 2 ml. of glacial acetic acid and 3 ml. of water may be used as a solvent for the reaction.

Di- and tri-chloroacetamide, oxamide, guanidine, and cyanoguanidine (dicyanodiamide) do not give satisfactory results.

The melting points of the xanthylamides of a number of aliphatic primary amides are collected in Table III,110.

TABLE III,110. PRIMARY ALIPHATIC AMIDES

Amide	M.P.	Xanthylamide
Formamide . . .	2°(b.p.193°d.)	184°
Acetamide . . .	82°	245°
Propionamide . . .	79°	214°
<i>n</i> -Butyramide . . .	115°	187°
<i>iso</i> -Butyramide . . .	129°	211°
<i>n</i> -Valeramide . . .	106°	167°
<i>iso</i> -Valeramide . . .	136°	183°
<i>n</i> -Caproamide . . .	101°	160°
<i>n</i> -Heptamide . . .	96°	154°
<i>n</i> -Octamide . . .	107°	148°
Palmitamide . . .	106°	142°
Stearamide . . .	109°	141°
Furoamide . . .	142°	210°
Methyl carbamate . . .	54°	193°
Ethyl carbamate . . .	49°	169°
Urea . . .	132°	274°
Methyl urea . . .	102°	230°
Succinamide . . .	260°d.	275°
Succinimide . . .	126°	246°
Chloroacetamide . . .	120°	209°
Cyanoacetamide . . .	120°	223°

ALIPHATIC CYANIDES (NITRILES)

Aliphatic nitriles (cyanides) may be prepared :—

1. By the dehydration of primary amides with phosphorus pentoxide or with thionyl chloride, for example :

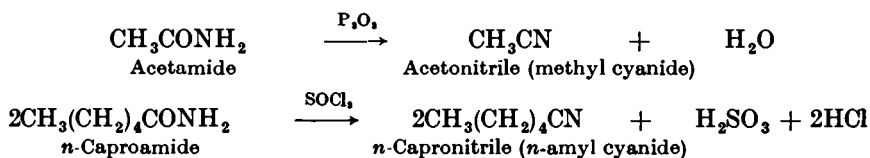

2. By refluxing an alkyl halide with sodium or potassium cyanide in aqueous - alcoholic solution, for example :

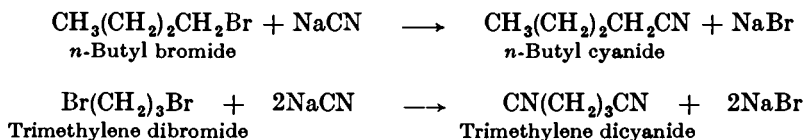

The resulting nitrile contains a little (< 1 per cent.) of *isonitrile* (*isocyanide*) ; this may be removed by washing with concentrated hydrochloric acid.

III,111.

ACETONITRILE

Attach a short Liebig condenser to a dry 250 ml. distilling flask ; use a small conical flask as a receiver. Owing to the extremely hygroscopic character of phosphoric oxide (1), the latter must be weighed out and transferred to the flask as rapidly as possible. Wrap some glazed paper around a glass tube and insert it into the flask until the lower end enters the bulb ; upon removing the glass tube, the paper roll expands and thus lines the neck of the distilling flask. Weigh out on pieces of glazed paper (using a rough balance) first 20 g. of acetamide, and then, *as rapidly as possible*, 30 g. of phosphorus pentoxide. Immediately transfer, with the aid of a spatula, the phosphoric oxide down the glazed paper cylinder into the distilling flask, then introduce the acetamide similarly, remove the paper, and at once cork the flask and mix the contents well by gentle shaking (2). Heat the flask cautiously with a small luminous flame kept in constant motion and applied uniformly over the bottom of the flask. A reaction, accompanied by much frothing, takes place. After the mixture has been heated for 4–5 minutes, distil the acetonitrile into the receiver using a somewhat larger luminous flame kept in constant motion around the flask. Add half the volume of water to the distillate, and then anhydrous potassium carbonate until the aqueous layer is saturated (about 9 g. of potassium carbonate are required for every 10 ml. of water) ; cool the flask in cold or ice water during the addition of the solid to prevent the loss of methyl cyanide by evaporation (3). Allow the excess of solid potassium carbonate to settle and decant the liquid to a small separatory funnel. Run off the lower carbonate layer, and transfer the upper layer through the mouth of the funnel to a small (25 ml.) distilling flask into which 2–3 g. of phosphorus pentoxide have been placed.

Fit a thermometer and small condenser to the flask, add 2-3 fragments of porous porcelain and distil slowly. Collect the fraction boiling at 79-82° as acetonitrile. The yield is 10 g.

Notes.

(1) Phosphorus pentoxide must be handled with great care since it produces painful burns if allowed to come in contact with the skin.

(2) Wet the papers thoroughly with water before throwing them away, as the residual phosphoric oxide may cause them to smoulder.

(3) The functions of the potassium carbonate are (a) to neutralise the acetic acid arising from the action of the phosphoric acid upon the acetamide, and (b) to "salt out" the otherwise soluble methyl cyanide as an upper layer.

III,112. *n*-AMYL CYANIDE (*n*-CAPRONITRILE) *

Place 29 g. of *n*-caproamide (Section III,109) into a 200 ml. distilling flask, and assemble the apparatus shown in Fig. III, 28, 1. Remove the trap momentarily and introduce 45 g. (27.5 ml.) of redistilled thionyl chloride: no apparent reaction takes place in the cold. Warm the mixture on a water bath or by means of a small flame for 1 hour. Arrange the apparatus for distillation and distil off the excess of thionyl chloride (*i.e.*, until the temperature reaches about 90°) and allow to cool. When cold, transfer the residue to a 100 ml. distilling flask (1). Distil from an air bath (Fig. II, 5, 3); the *n*-capronitrile passes over at 161-163° (2). The yield is 21 g.

Notes.

(1) If the residue is dark and contains some solid matter, it is advisable to add a little anhydrous ether, and to filter the ethereal extract into the 100 ml. distilling flask; the ether is removed first by distillation from a water bath using the apparatus of Fig. II, 13, 1 or Fig. II, 13, 4.

(2) The *n*-capronitrile is sometimes slightly turbid; the turbidity is readily removed by shaking with a little anhydrous calcium sulphate.

COGNATE PREPARATION

***n*-Octonitrile.** Use *n*-octamide (*n*-caprylamide) and redistilled thionyl chloride in the proportion of 1 mol to 1.5 mols. Warm the mixture on a water bath for 1 hour, distil off the excess of thionyl chloride at atmospheric pressure, and distil the residual *n*-octonitrile under diminished pressure. B.p. 87°/10 mm. The yield is almost quantitative.

III,113. *n*-BUTYL CYANIDE (*n*-VALERONITRILE) †

Into a 1500 ml. round-bottomed flask place 97.5 g. of finely-powdered sodium cyanide (1), 125 ml. of water, and a few chips of porous porcelain. Attach a reflux condenser and warm on a water bath until all the sodium cyanide dissolves. Introduce a solution of 250 g. (196 ml.) of *n*-butyl bromide (Sections III,35 and III,37) in 290 ml. of pure methyl alcohol, and reflux gently on a water bath for 28-30 hours. Cool to room temperature and remove the sodium bromide which has separated by filtration through a sintered glass funnel at the pump; wash the crystals with about 100 ml. of methyl alcohol. Transfer the filtrate and washings to

* From *n*-caproamide by SOCl₂ method.

† From *n*-butyl bromide and aqueous-alcoholic sodium cyanide.

a 1-litre round-bottomed flask, and distil off the methyl alcohol slowly from a water bath through an efficient fractionating column (*e.g.*, a Hempel or a modified Hempel column, a Widmer column, etc. ; see Section II,17). The temperature should not rise above 68–69°. Remove the fractionating column, add 500 ml. of water, connect the flask by means of a wide, bent delivery tube to a condenser set for downward distillation (Fig. II, 13, 3, but without the thermometer), and distil the mixture from a wire gauze until no more oily drops pass over. The residue in the flask contains sodium bromide, some unreacted sodium cyanide, and high boiling by-products ; allow it to cool, pour it down the main drain of the laboratory (whilst a liberal stream of water is simultaneously run from the tap), wash the flask well with water and finally with a little methylated spirit.

Separate the upper layer of crude *n*-butyl cyanide (100 g.) from the distillate. Upon drying over anhydrous calcium chloride or magnesium sulphate and then distilling from a 200 ml. flask using an air bath or a wire gauze, it boils, for the most part, at 139–141°. A small fraction of low boiling point may be obtained ; this should be dried over anhydrous calcium chloride and redistilled, thus giving a little more *n*-butyl cyanide. The resulting nitrile contains a small quantity (< 1 per cent.) of *n*-butyl *iso*-cyanide, to which the unpleasant odour is due ; it is, however, quite satisfactory for most purposes, *e.g.*, for conversion into *n*-valeric acid (Section III,83).

The *iso*-nitrile may be removed by the following procedure. Shake the crude (undistilled) *n*-butyl cyanide twice with about half its volume of concentrated hydrochloric acid and separate carefully after each washing ; then wash successively with water, saturated sodium bicarbonate solution and water. Dry with anhydrous calcium chloride or anhydrous calcium sulphate, and distil. Collect the pure *n*-butyl cyanide at 139–141°. If a fraction of low boiling point is obtained (because of incomplete drying), dry it again with anhydrous calcium sulphate and redistil. The yield is 95 g.

Note.

(1) *Sodium cyanide is very poisonous and must be handled with great care.* The hands should be washed immediately after using it. All the residual solutions containing alkali cyanides must be emptied into the main drain of the laboratory and washed down with a liberal supply of water ; they should never be treated with acid.

COGNATE PREPARATION

***n*-Hexyl cyanide.** Use 30 g. of sodium cyanide dissolved in 40 ml. of water ; 82 g. (70 ml.) of *n*-hexyl bromide (Section III,37) in 150 ml. of methyl alcohol. Remove the methyl alcohol through an efficient fractionating column, add 500 ml. of water, and separate the upper layer of crude nitrile. Purify the crude *n*-hexyl cyanide by the hydrochloric acid method. B.p. 182–184°. Yield : 40 g.

III,114. TRIMETHYLENE DICYANIDE (GLUTARONITRILE)

Fit a 2-litre round-bottomed flask with a two-holed stopper carrying a separatory funnel and a reflux condenser (Fig. III, 71, 1). Place 147 g. of finely powdered sodium cyanide and 150 ml. of water in the flask and

heat on a water bath until most of the solid passes into solution. Add a solution of 250 g. (126 ml.) of trimethylene dibromide (Section III,35) in 500 ml. of rectified spirit through the separatory funnel over a period of 30 minutes. Reflux the mixture on a water bath for 35 hours; then remove the solvent (compare Fig. III, 35, 1), using a boiling water bath. The residue in the flask consists of sodium bromide, unreacted sodium cyanide and trimethylene cyanide; the last-named alone is soluble in ethyl acetate. Extract the residue with 200 ml. of ethyl acetate. Filter the solution through a sintered glass funnel and wash the solid with about 50 ml. of ethyl acetate. Dry the filtrate, after removing the aqueous layer, with anhydrous magnesium or calcium sulphate, distil off the ethyl acetate at atmospheric pressure (about 245 ml. are recovered), allow to cool somewhat, and distil the liquid under reduced pressure. Collect the trimethylene dicyanide at 139–140°/8 mm. The yield is 95 g.

III,115. REACTIONS AND CHARACTERISATION OF ALIPHATIC NITRILES (CYANIDES)

Aliphatic nitriles are usually liquids or low melting point solids. The most important reaction of a nitrile is its hydrolysis either by an alkali or by an acid to the corresponding aliphatic acid: characterisation of the acid enables the identity of the original nitrile to be established.

(i) **Hydrolysis with alkali.** When nitriles are treated with 20–40 per cent. sodium or potassium hydroxide solution, there is no reaction in the cold; upon prolonged boiling hydrolysis proceeds comparatively slowly (compare primary amides which are rapidly hydrolysed) to the sodium salt of the acid and ammonia. The reaction is complete when ammonia is no longer evolved:

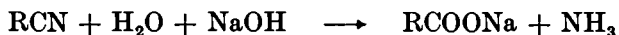

The excess of alkali is then neutralised with dilute hydrochloric acid (phenolphthalein) and the solution is evaporated to dryness on the water bath. The acid may then be characterised as the *S*-benzyl-*iso*-thiuronium salt or as the *p*-bromophenacyl ester (Section III,85). In many instances the derivative may be prepared directly from the neutralised solution.

(ii) **Hydrolysis with acid.** Most nitriles are hydrolysed by boiling with 5–8 times the weight of 50–75 per cent. sulphuric acid under reflux for 2–3 hours:

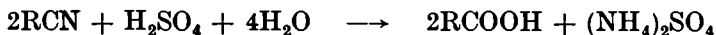

The acid, if monobasic, can usually be distilled directly from the reaction mixture. If this procedure is not possible, the reaction mixture is poured into excess of crushed ice, and the acid is isolated by ether extraction or by other suitable means. The acid is then characterised (Section III,85). The addition of hydrochloric acid (as sodium chloride; say 5 per cent. of the weight of sulphuric acid) increases the rate of the reaction.

For those nitriles which yield water-insoluble amides (*e.g.*, the higher alkyl cyanides), *hydrolysis to the amide* often leads to a satisfactory derivative. The hydration is effected by warming a solution of the nitrile in concentrated sulphuric acid for a few minutes, cooling and pouring

into water; an imino-sulphate is probably formed intermediately and this is hydrolysed:

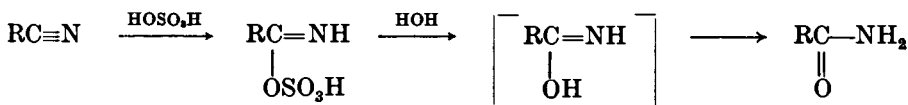

Warm a solution of 0.5 g. of the nitrile in 2 ml. of concentrated sulphuric acid to 80–90° and allow the solution to stand for 5 minutes. Cool under the tap and pour the sulphuric acid solution into 20 ml. of cold water. Filter off the precipitated solid and stir it with 5 ml. of cold 5 per cent. sodium hydroxide solution. Collect the insoluble crude amide and recrystallise it from dilute alcohol.

For practice, the student should carry out both alkaline (compare Section III,83) and acid hydrolysis of acetonitrile, *n*-valeronitrile (*n*-butyl cyanide) and *n*-capronitrile (*n*-amyl cyanide).

(iii) Nitriles may also be identified by reduction to primary amines and conversion into substituted phenylthioureas. Reduction of a nitrile with sodium and alcohol yields the primary amine, which may be identified by direct conversion into a substituted phenylthiourea.

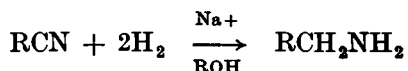

Dissolve 1.0 g. of the nitrile in 20 ml. of absolute ethanol in a dry 200 ml. round-bottomed flask fitted with a reflux condenser. Add through the top of the condenser 1.5 g. of clean sodium (previously cut into small pieces) at such a rate that the reaction, although vigorous, remains under control. When all the sodium has reacted (10–15 minutes), cool the reaction mixture to about 20°, and add 10 ml. of concentrated hydrochloric acid dropwise through the condenser whilst swirling the contents of the flask vigorously: the final solution should be acid to litmus. Transfer to a 100 ml. distilling flask connected to a condenser, and distil off about 20 ml. of liquid (dilute ethanol). Cool the flask and fit a small dropping funnel into the neck of the distilling flask. Place 15 ml. of 40 per cent. sodium hydroxide solution in the dropping funnel, attach an adapter to the end of the condenser and so arrange it that the end dips into about 3 ml. of water contained in a 50 ml. conical flask. Add the sodium hydroxide solution dropwise and with shaking: a vigorous reaction ensues. When all the alkali has been added, separate the amine by distillation until the contents of the flask are nearly dry.

Add 0.5 ml. of phenyl isothiocyanate to the distillate and shake the mixture vigorously for 3–4 minutes. If no derivative separates, crystallisation may be induced by cooling the flask in ice and "scratching" the walls with a glass rod. Filter off the crude product, wash it with a little 50 per cent. ethanol, and recrystallise from hot dilute alcohol. (See Table III,123 for melting points of phenylthiourea derivatives of amines.)

The physical properties of a number of aliphatic nitriles (cyanides) are given in Table III,115.

TABLE III,115. ALIPHATIC NITRILES (CYANIDES)

Cyanide	Nitrile	B.P.	M.P.	d_{4}^{20}	n_{D}^{20}
Methyl	Aceto-	81°	—	0.784	1.344
Ethyl	Propio-	97	—	0.783	1.366
<i>n</i> -Propyl	<i>n</i> -Butyro-	118	—	0.791	1.384
<i>iso</i> -Propyl	<i>iso</i> -Butyro-	108	—	—	—
<i>n</i> -Butyl	<i>n</i> -Valero-	141	—	0.799	1.397
<i>iso</i> -Butyl	<i>iso</i> -Valero-	131	—	0.788	—
<i>n</i> -Amyl	<i>n</i> -Capro-	162	—	0.805	1.407
<i>iso</i> -Amyl	<i>iso</i> -Capro-	154	—	0.803	1.406
<i>n</i> -Hexyl	<i>n</i> -Hepto (oenantho-)	183	—	0.810	1.414
<i>n</i> -Heptyl	<i>n</i> -Octo (caprylo-)	199	—	0.817*	1.422*
<i>n</i> -Octyl	<i>n</i> -Nono. (pelargono-)	224	—	0.822*	—
<i>n</i> -Nonyl	<i>n</i> -Decano. (caprino-)	244	—	0.829*	1.432*
<i>n</i> -Decyl	<i>n</i> -Undecano-	254	—	—	—
<i>n</i> -Undecyl	<i>n</i> -Dodecano. (lauro-)	275	—	0.827*	—
Vinyl	Acrylo-	78	—	0.806	1.391
Allyl	Vinylaceto-	118	—	0.838	1.406
Chloromethyl	Chloroaceto-	127	—	1.193	—
Methylene	Malono-	220	31°	—	—
Ethylene	Succino-	267d	54	—	—
Trimethylene	Glutaro-	286	9	0.988	1.429
Tetramethylene	Adipo-	295	—	0.962	1.439
Pentamethylene	Pimelo-	169°/15	—	0.945	1.441
Hexamethylene	Subero-	185°/15	—	0.933	1.445
Phenyl	Benzo-	189	—	1.006	1.528
Benzyl	Phenylaceto-	109°/15	—	1.016	1.523
Acetaldehyde cyano-					
hydrin	α -Hydroxypropio-	183	—	0.988	—
Ethylene cyanohydrin	β -Hydroxypropio-	221	—	—	—
Trimethylene cyano-					
hydrin	γ -Hydroxybutyro-	240	—	—	—
Trimethylene chloro-					
cyanide	γ -Chlorobutyro-	197	1.079	—	—
Methyl cyanoacetate		200	—	1.101	—
Ethyl cyanoacetate		207	—	1.063	1.418
Furan- α -	Furo-	147	—	1.082	1.480

* 15°.

ALIPHATIC AMINES

Aliphatic amines may be prepared :—

1. By treatment of an amide with sodium hypobromite or sodium hypochlorite solution (or with the halogen and alkali), the amine of one less carbon atom is produced, the net result being the elimination of the carbonyl group. An example is :

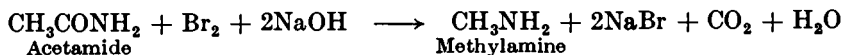

The conversion of an amide into an amine in this way is termed the **Hofmann reaction** or the **Hofmann rearrangement**.

The *mechanism* of the reaction probably involves the following stages :

(a) The formation of a *N*-haloamide :

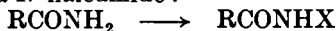

(b) In the presence of alkali, hydrogen halide is eliminated producing presumably an electronically-deficient nitrogen fragment, which rearranges to the isocyanate (I) :

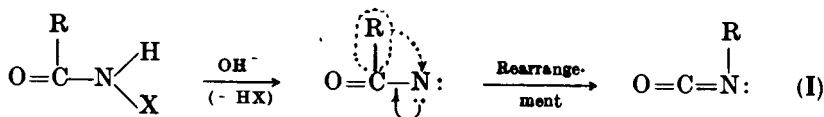

(c) Hydrolysis of the isocyanate to the primary amine :

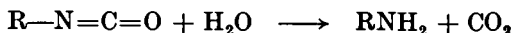

The reaction is applicable to the preparation of amines from amides of aliphatic aromatic, aryl-aliphatic and heterocyclic acids. A further example is given in Section IV, 170 in connexion with the preparation of anthranilic acid from phthalimide. It may be mentioned that for aliphatic monoamides containing more than eight carbon atoms aqueous alkaline hypohalite gives poor yields of the amines. Good results are obtained by treatment of the amide ($C > 8$) in methanol with sodium methoxide and bromine, followed by hydrolysis of the resulting *N*-alkyl methyl carbamate :



2. By the reduction of nitriles with sodium and absolute alcohol, for example :

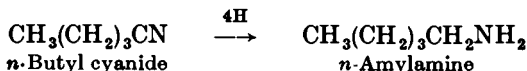

3. By the reduction of oximes with sodium and absolute ethyl alcohol, for example :

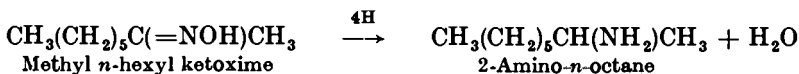
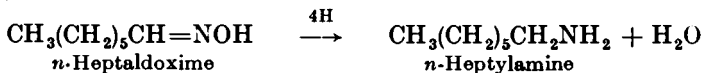

4. By the hydrolysis of dialkyl cyanamides with dilute sulphuric acid ; this method gives pure **secondary amines**. The appropriate dialkyl cyanamide is prepared by treating sodium cyanamide (itself obtained in solution from

calcium cyanamide and aqueous sodium hydroxide solution) with an alkyl halide, for example :

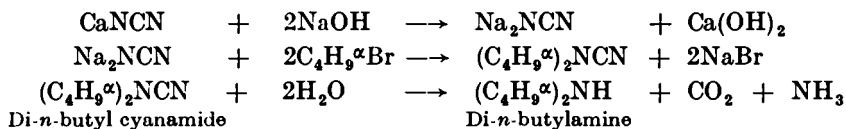

The above methods are of general application, but special procedures are available for individual amines depending upon the unique reactivity of formaldehyde. Thus when 2 parts by weight of formalin (*ca.* 35 per cent. formaldehyde) is heated with 1 part by weight of ammonium chloride at 104°, the main product is methylamine hydrochloride (methylammonium chloride). Allowing for the ammonium chloride recovered (about 35 per cent.), this corresponds roughly to the molecular ratios 2CH₂O : NH₄Cl and suggests the following mechanism of the reaction :

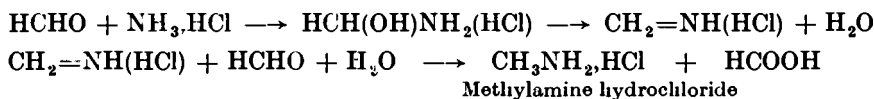

If the methylamine hydrochloride in solution from the previous reaction be heated with a further quantity of formalin at 115°, dimethylamine hydrochloride (dimethylammonium chloride) may be isolated :

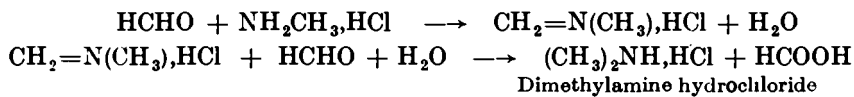

When ammonium chloride is heated to a higher temperature (160°) with a large excess of anhydrous formaldehyde (as paraformaldehyde), trimethylamine hydrochloride (trimethylammonium chloride) may be obtained :

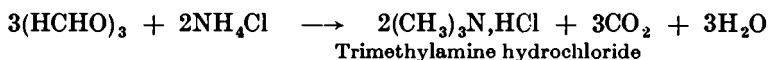

III,116. METHYLAMINE HYDROCHLORIDE (from Acetamide)

Place 25 g. of dry acetamide in a 350 ml. conical or flat-bottomed flask, and add 69 g. (23 ml.) of bromine (*CAUTION!*): a deep red liquid is produced. Cool the flask in ice water and add 10 per cent. sodium hydroxide solution (about 210 ml.) in small portions and with vigorous shaking until the solution acquires a pale yellow colour. At this stage the bromoacetamide is present in the alkaline solution. If any solid should crystallise out, add a little water.

Assemble the apparatus shown in Fig. III, 56, 1, using a 1-litre distilling flask; replace the filter flask receiver by a small funnel attached to the end of the condenser by a short length of rubber tubing and dipping about 0.5 cm. below 100 ml. of dilute hydrochloric acid (1 : 1) contained in a beaker. Place a solution of 60 g. of sodium hydroxide in 150 ml. of water, together with a few fragments of porous porcelain, in the flask and the bromoacetamide solution in the separatory funnel. Warm the solution in the flask until the thermometer in the liquid reads 60-70°. Allow the bromoacetamide solution to run slowly into the flask at such a rate that the temperature does not rise above about 70°; heat is evolved

in the reaction and if the temperature rises above 75° the flask should be surrounded momentarily by a bath of cold water. When all the solution has been added, maintain the temperature of the mixture in the flask for about 15 minutes at 65–70°; by this time the solution should be clear and colourless. Gently boil the solution and thus drive off the methylamine vapour into the dilute hydrochloric acid. As soon as the distillate is no longer alkaline (40–60 minutes), concentrate the hydrochloric acid solution by placing it in a 250 ml. distilling flask connected with a water condenser and distilling carefully from an air bath until about 25 ml. remains; then transfer the solution to an evaporating dish, evaporate to dryness on a water bath, and finally for a short time in an air oven at 100–105°. The yield of crude dry product (which is contaminated with some ammonium chloride) is about 24 g. Transfer the finely-powdered, dry solid to a 250 ml. round-bottomed flask fitted with a reflux condenser and cotton wool (or calcium chloride) guard tube. Add about 120 ml. of *absolute* ethyl alcohol (which dissolves only the methylamine hydrochloride) and boil the mixture for 10 minutes. Filter through a hot water funnel. Extract the residue with a further 50 ml. of boiling absolute alcohol and filter again. Cool the combined alcoholic extracts when colourless crystals of methylamine hydrochloride will separate out. Filter rapidly at the pump, and transfer the crystals (which are deliquescent) to a stoppered bottle. Evaporate the filtrate to about one third of the original volume, when a further crop of crystals will be obtained. Dry all the crystals in a desiccator. The yield is about 18 g.

III,117. METHYLAMINE HYDROCHLORIDE (*from Formalin*)

Place 250 g. of ammonium chloride and 500 g. of technical formaldehyde solution (formalin, 35–40 per cent. formaldehyde) in a 1-litre distilling flask: insert a thermometer dipping well into the liquid and attach a condenser for downward distillation. Heat the flask on a wire gauze or in an air bath *slowly* until the temperature reaches 104° and maintain the temperature at this point until no more distillate is collected (4–5 hours) (1). Cool the contents of the flask rapidly to room temperature and filter off the ammonium chloride (*ca.* 62 g.) which separates rapidly at the pump. Concentrate the filtrate to one half of the original volume on a water bath, when more ammonium chloride (*ca.* 19 g.) will crystallise out on cooling to room temperature. After filtration at the pump, evaporate on a water bath until a crystalline scum forms on the surface of the hot solution. Allow to cool and filter off the methylamine hydrochloride (about 96 g.) (2). Concentrate again on a water bath and thus obtain a second crop (about 18 g.) of methylamine hydrochloride. Evaporate the mother liquor as far as possible on a water bath and leave it in a vacuum desiccator over sodium hydroxide pellets for 24 hours; digest the semi-solid residue with chloroform (to remove the dimethylamine hydrochloride), filter off (2) the methylamine hydrochloride (about 20 g.) at the pump and wash it with a little chloroform. [Upon concentrating the chloroform solution to about half the original bulk, about 27 g. of dimethylamine hydrochloride may be obtained: the mother

liquor should be discarded.] Purify the crude methylamine hydrochloride by placing it together with 250 ml. of *absolute* alcohol in a 500 ml. round-bottomed flask fitted with a reflux condenser carrying a cotton wool (or calcium chloride) guard tube. Heat the mixture to boiling for about half an hour, allow the undissolved material to settle and decant the clear solution. Cool the solution when pure methylamine hydrochloride will separate : filter (2) and use the filtrate for another extraction. Four or five extractions are required to extract all the methylamine hydrochloride. The yield of recrystallised material is about 100 g.

Notes.

(1) The distillate weighs about 110 g. and contains methyl formate and methylal. If it is placed in a flask provided with a reflux condenser and a solution of 25 g. of sodium hydroxide in 40 ml. of water is added, the methyl formate is hydrolysed to sodium formate and the methylal separates on the surface. The latter may be removed, dried with anhydrous calcium chloride and distilled : about 30 g. of methylal, b.p. 37–42°, are obtained. If the aqueous layer is evaporated to dryness, about 25 g. of sodium formate are isolated.

(2) The best method of drying the precipitate of methylamine hydrochloride is by centrifuging ; the compound is hygroscopic.

III,118, DIMETHYLAMINE HYDROCHLORIDE

Proceed as in the preparation of methylamine hydrochloride (previous Section) using 200 g. of ammonium chloride and 400 g. of formalin, and heat the mixture at 104° until no more liquid distils. Cool to room temperature and filter off the ammonium chloride (*ca.* 50 g.) : add 300 g. of formalin to the filtrate, return the solution to the distilling flask, heat until the temperature reaches 115° and maintain it as nearly as possible at this temperature until no more liquid passes over (about 3–4 hours). Concentrate the residue in the distilling flask on a water bath until a scum appears on the surface of the hot liquid. Cool to room temperature and filter off the solid (*ca.* 32 g. ; impure methylamine hydrochloride containing about 25 per cent. of ammonium chloride). Pour back the filtrate into the distilling flask and heat to 120° until a sample of the liquid, on cooling, becomes semi-solid. Transfer it to a vacuum desiccator charged with sodium hydroxide pellets and leave it there for 2 days. Extract the residue with hot chloroform and filter ; on cooling, crystals of dimethylamine hydrochloride separate. A further crop can be obtained by evaporating the filtrate to about half its original volume. The yield is 120 g.

III,119. TRIMETHYLAMINE HYDROCHLORIDE

Mix 100 g. of ammonium chloride and 266 g. of paraformaldehyde in a 1-litre round-bottomed flask fitted with a long reflux condenser containing a wide inner tube (*ca.* 2 cm. diameter) ; the last-named is to avoid clogging the condenser by paraformaldehyde which may sublime. Immerse the flask in an oil bath and gradually raise the temperature. The mixture at the bottom of the flask liquefies between 85° and 105° and a vigorous evolution of carbon dioxide commences ; at once remove the burner beneath the oil bath and if the reaction becomes too violent remove

the oil bath also. Permit the reaction to proceed without further heating until the evolution of gas subsides (60-90 minutes); then raise the temperature of the bath to about 160° and maintain it at this temperature until the evolution of gas almost ceases (2·5-3·5 hours). The reaction is then complete.

When the reaction mixture has cooled somewhat, insert a separatory funnel into the neck of the flask and arrange the reflux condenser for downward distillation (as in Fig. III, 35, 1); fit the lower end of the condenser into the neck of a distilling flask or a filter flask (1) and attach the side arm by means of rubber tubing to an inverted funnel immersed to a depth of 1 cm. in 190 ml. of concentrated hydrochloric acid in a beaker. All joints must fit well as trimethylamine is very volatile and can easily be lost. Place a solution of 220 g. of sodium hydroxide in 400 ml. of water in the separatory funnel and allow it to run slowly into the warm reaction mixture. The amine distils and collects largely in the hydrochloric acid. Finally, heat the mixture for about 15 minutes to ensure that all the trimethylamine has been expelled from the reaction flask. Evaporate the hydrochloric acid solution on a water bath; the trimethylamine hydrochloride gradually crystallises out and is filtered off from time to time (2); it is dried for a few minutes at 100-105° and preserved in a tightly stoppered bottle. The solid (*ca.* 14 g.) obtained by evaporation to dryness may be tinged slightly yellow. The yield is about 150 g. (3).

Notes.

(1) The object of the intermediate flask is to trap any water which may distil with the amine; this water is generally coloured yellow and if allowed to pass into the hydrochloric acid in the receiver will contaminate the product.

(2) The most satisfactory method of drying is by centrifuging: the salt is hygroscopic.

(3) The absence of ammonium chloride and methylamine hydrochloride may be shown by the complete solubility of the product in chloroform.

III,120.

n-AMYLAMINE

Equip a three-necked 1-litre flask with a dropping funnel, an efficient mechanical stirrer and a reflux condenser (Fig. II, 7, 11). Place 55 g. of clean sodium and 200 ml. of sodium-dried toluene in the flask, heat the mixture until the toluene commences to boil, and then stir the molten sodium vigorously thus producing an emulsion. Run in through the dropping funnel a mixture of 33 g. (41·5 ml.) of *n*-butyl cyanide (Section III,113) and 60 g. (76 ml.) of absolute ethyl alcohol during 1 hour. During the addition and the subsequent introduction of alcohol and of water, the stirring should be vigorous and the temperature adjusted so that the refluxing is continuous; the heat of reaction will, in general, be sufficient to maintain the refluxing. After the *n*-butyl cyanide solution has been added, introduce gradually a further 60 g. (76 ml.) of absolute alcohol. In order to destroy any residual sodium, treat the reaction mixture slowly with 40 g. (50 ml.) of rectified spirit and then with 20 g. of water. Steam distil the contents of the flask (compare Fig. II, 41, 1) (about 2 hours) and add 40 ml. of concentrated hydrochloric acid to the distillate. Separate the toluene layer; distil the aqueous layer, which

contains alcohol and *n*-amylamine hydrochloride, until most of the alcohol is removed. Pour the contents of the flask into a large porcelain basin and evaporate to dryness on a water bath. Treat the resulting *n*-amylamine hydrochloride with a solution of 40 g. of sodium hydroxide in 200 ml. of water. Separate the *n*-amylamine layer, dry it by shaking with sodium hydroxide pellets (prolonged contact is required for complete drying), and distil. Collect the fraction boiling at 102–105° as pure *n*-amylamine. Dry the fraction of low boiling point again over sodium hydroxide and redistil; this gives an additional quantity of amine. The total yield is 30 g.

III,121.

n-HEPTYLAMINE

In a 3-litre round-bottomed flask, equipped with a long (*ca.* 150 cm.) reflux condenser with wide (*ca.* 2.5 cm.) inner tube, place a solution of 64.5 g. of *n*-heptaldoxime (Section III,76) in 1 litre of "super-dry" ethyl alcohol (Section II,47,5) and heat on a water bath. Immediately the alcohol boils, remove the flask from the water bath and introduce 125 g. of sodium, cut in small pieces, as rapidly as possible through the condenser consistent with keeping the vigorous reaction under control. The last 30 g. of sodium melts in the hot mixture and may be added very rapidly without appreciable loss of alcohol or of amine. As soon as the sodium has completely dissolved (some warming may be necessary), cool the contents of the flask and dilute with 1250 ml. of water. At once equip the flask with a condenser set for downward distillation and arrange for the distillate to be collected in a solution of 75 ml. of concentrated hydrochloric acid in 75 ml. of water contained in a 3-litre flask. Continue the distillation as long as amine passes over. Towards the end of the reaction considerable frothing sets in; then add a further 750 ml. of water to the distillation flask. The total distillate is 2–2.2 litres and contains alcohol, water, and some unreacted oxime as well as the amine hydrochloride. Evaporate the solution under reduced pressure (20–30 mm.) on a water bath (compare Fig. II, 37, 1); the amine hydrochloride will crystallise out in the flask. Cool the flask, attach a reflux condenser, and introduce 250 ml. of 40 per cent. potassium hydroxide solution. Rotate the flask to wash down the hydrochloride from the sides of the flask, cool the mixture to room temperature and transfer it to a separatory funnel. Run off the lower alkaline layer and add solid potassium hydroxide to the amine in the funnel. Again remove the lower aqueous layer, add more solid potassium hydroxide and repeat the process until no further separation of an aqueous layer occurs. Finally, transfer the amine to a small flask and leave it in contact with potassium hydroxide pellets for 24 hours. Decant the amine into a Claisen flask with fractionating side arm (the latter should be well-lagged) and distil. Collect the *n*-heptylamine at 153–157°. The yield is 40 g.

COGNATE PREPARATION

2-Amino-*n*-octane. Convert methyl *n*-hexyl ketone (Section III,71) into the ketoxime, b.p. 106–108°/12 mm., as detailed for *n*-Heptaldoxime (Section III,76). Reflux a solution of 50 g. of the oxime in 200 ml. of

"super-dry" ethyl alcohol on a water bath whilst adding 75 g. of sodium; introduce more alcohol (about 300 ml.) to maintain a vigorous reaction. When all the sodium has passed into solution, cool, dilute with 250 ml. of water and distil gently until the b.p. reaches 96°; add a further 200 ml. of water and repeat the distillation to ensure the complete removal of the alcohol. The amine remains as a layer on the strongly alkaline solution: extract it with ether, dry the ethereal solution with sodium hydroxide or anhydrous calcium sulphate, remove the ether on a water bath, and distil the residue under diminished pressure. Collect the 2-amino-*n*-octane at 58–59°/13 mm.; the b.p. under atmospheric pressure is 163–164°. The yield is 31 g.

III,122.

DI-*n*-BUTYLAMINE

Equip a 1500 ml. three-necked flask with a reflux condenser and a mercury-sealed stirrer. Place 222 ml. of water and 44 g. of finely crushed ice in the flask and add slowly, with vigorous stirring, 67 g. of commercial calcium cyanamide (1). As soon as the solid is thoroughly suspended, fit a separatory funnel into the third neck of the flask and introduce through it a cold solution of 34 g. of sodium hydroxide in 67 ml. of water; replace the funnel by a cork carrying a thermometer. Continue the vigorous stirring for 1 hour to complete the decomposition of the calcium cyanamide; if the temperature rises above 25°, add a little more ice. Add to the resulting solution of sodium cyanamide a solution of 134 g. (105 ml.) of *n*-butyl bromide (Sections III,35 and III,37) in 222 ml. of rectified spirit. Heat the mixture, with stirring on a water bath until it refluxes gently; continue the refluxing and stirring for 2.5 hours. Replace the reflux condenser by one set for downward distillation and distil the mixture until 165–170 ml. of liquid are collected: stir during distillation. Cool the residue in the flask and filter it, with suction, through a Buchner or sintered glass funnel, and wash the residue with alcohol. Extract the filtrate, which separates into two layers, first with 90 ml. and then with 45 ml. of benzene. Dry the combined benzene extracts with anhydrous magnesium or calcium sulphate, and remove the benzene in a Claisen flask (compare Fig. II, 13, 4). Finally distil under reduced pressure and collect the di-*n*-butyl cyanamide, (C₄H₉)₂NCN, at 147–151°/35 mm. The yield is 33 g.

Into a 750 ml. round-bottomed flask furnished with a reflux condenser place a solution of 34 g. (18.5 ml.) of concentrated sulphuric acid in 100 ml. of water: add 33 g. of di-*n*-butyl cyanamide and a few fragments of porous porcelain. Reflux gently for 6 hours. Cool the resulting homogeneous solution and pour in a cold solution of 52 g. of sodium hydroxide in 95 ml. of water down the side of the flask so that most of it settles at the bottom without mixing with the solution in the flask. Connect the flask with a condenser for downward distillation and shake it to mix the two layers; the free amine separates. Heat the flask when the amine with some water distils: continue the distillation until no amine separates from a test portion of the distillate. Estimate the weight of water in the distillate and add about half this amount of potassium hydroxide in the form of sticks, so that it dissolves slowly.

Cool the solution in ice while the alkali hydroxide is dissolving; some ammonia gas is evolved. When the potassium hydroxide has dissolved, separate the amine, and dry it for 24 hours over sodium hydroxide pellets. Filter into a Claisen flask and distil. Collect the di-*n*-butylamine at 157-160°. The yield is 31 g.

Note.

(1) Also known as "nitrolim" and "lime nitrogen." The fresh product contains approximately 55 per cent. of calcium cyanamide, 20 per cent. of lime, 12 per cent. of graphite and small amounts of other impurities. It should be protected from moisture when stored in order to prevent slow polymerisation to dicyanodiamide.

III,123. REACTIONS AND CHARACTERISATION OF ALIPHATIC AMINES

The more important reactions of aliphatic amines, which will assist in their detection, are given below.

Salts of amines are generally soluble in water. Upon treatment with 10 per cent. sodium hydroxide solution, the amine will separate if it is insoluble or sparingly soluble in water; if the amine is water-soluble, it can be partially volatilised by gentle warming and its presence will be suggested by a characteristic odour.

PRIMARY AMINES

(i) Reaction with nitrous acid. Dissolve 0.2 g. of the substance in 5 ml. of 2*N* hydrochloric acid; cool in ice and add 2 ml. of ice-cold 10 per cent. aqueous sodium nitrite solution. Warm gently upon a water bath, when nitrogen will be freely evolved:

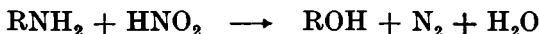

If desired, the alcohol may be identified as the 3:5-dinitrobenzoate (Section III,27); it is then best to repeat the experiment on a larger scale and to replace the dilute hydrochloric acid by dilute sulphuric acid. It must, however, be pointed out that the reaction is not always so simple as indicated in the above equation. Olefine formation and rearrangement of the alcohol sometimes occur: thus *n*-propylamine yields *n*-propyl alcohol, *isopropyl* alcohol and propylene.

(ii) Rimini's test. To a suspension or solution of 1 drop of the compound or to an equivalent quantity of the solution, add 1 ml. of pure acetone and 1 drop of freshly prepared 1 per cent. aqueous solution of sodium nitroprusside. A violet-red colour will develop within 1 minute.

(iii) Carbylamine test. To 1 ml. of 0.5*N* alcoholic potassium hydroxide solution (or to a solution prepared by dissolving a fragment of potassium hydroxide half the size of a pea in 1 ml. of alcohol) add 0.05-0.1 g. of the amine and 3 drops of chloroform, and heat to boiling. A carbylamine (*isocyanide*) is formed and will be readily identified by its extremely nauseating odour:

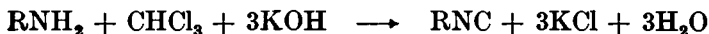

When the reaction is over, add concentrated hydrochloric acid to decompose the isocyanide and pour it away after the odour is no longer discernible. The test is extremely delicate and will often detect traces of primary amines in secondary and tertiary amines; it must therefore be used with due regard to this and other factors.

(iv) **5-Nitrosalicylaldehyde reagent test.** This test is based upon the fact that 5-nitrosalicylaldehyde and nickel ions when added to a primary amine produce an immediate precipitate of the nickel derivative of the "imine" or Schiff's base.

To 5 ml. of water add 1-2 drops of the amine; if the amine does not dissolve, add a drop or two of concentrated hydrochloric acid. Add 0.5-1 ml. of this amine solution to 2-3 ml. of the reagent; an almost immediate precipitate indicates the presence of a primary amine. A slight turbidity indicates the presence of a primary amine as an impurity. (Primary aromatic amines generally require 2-3 minutes for the test. Urea and other amides, as well as amino acids, do not react.)

The 5-nitrosalicylaldehyde reagent is prepared as follows. Add 0.5 g. of 5-nitrosalicylaldehyde (m.p. 124-125°) to 15 ml. of pure triethanolamine and 25 ml. of water; shake until dissolved. Then introduce 0.5 g. of crystallised nickel chloride dissolved in a few ml. of water, and dilute to 100 ml. with water. If the triethanolamine contains some ethanolamine (thus causing a precipitate), it may be necessary to add a further 0.5 g. of the aldehyde and to filter off the resulting precipitate. The reagent is stable for long periods.

SECONDARY AMINES

(v) **Reaction with nitrous acid.** Oily nitrosoamines (compare Sections III, 124 and IV, 100) are generally formed: no nitrogen is evolved (see (i)).

(vi) **Simon's test.** To a solution or suspension of 1 drop of the compound (or an equivalent quantity of solution) in 3 ml. of water, add 1 ml. of freshly prepared acetaldehyde solution,* followed by 1 drop of a 1 per cent. aqueous solution of sodium nitroprusside. A blue colouration is produced within 5 minutes, after which the colour gradually changes through greenish-blue to pale yellow.

(vii) **Carbon disulphide reagent test.** This test is based upon the formation from a secondary amine and carbon disulphide of a dialkyldithiocarbamate; the latter readily forms a nickel derivative with a solution of a nickel salt:

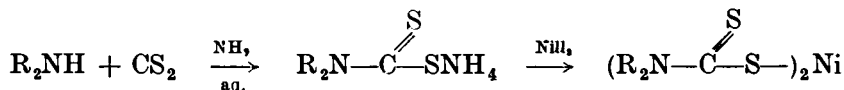

To 5 ml. of water add 1-2 drops of the secondary amine; if it does not dissolve, add a drop or two of concentrated hydrochloric acid. Place 1 ml. of the reagent in a test-tube, add 0.5-1 ml. of concentrated ammonia solution, followed by 0.5-1 ml. of the above amine solution. A precipitate indicates a secondary amine. A slight turbidity points to the presence of a secondary amine as an impurity.

* Prepare the acetaldehyde solution by plunging a red hot oxidised copper coil (made by winding a copper wire round a glass tube and heating the resulting coil in a Bunsen flame) into 5 ml. of 50 per cent. alcohol in a Pyrex test-tube. Withdraw the coil, cool the test-tube under the tap, repeat the oxidation several times, and use the cooled solution for the test.

The carbon disulphide reagent is prepared by adding to a solution of 0.5 g. of crystallised nickel chloride in 100 ml. of water enough carbon disulphide so that after shaking a globule of carbon disulphide is left at the bottom of the bottle. The reagent is stable for long periods in a well-stoppered bottle. If all the carbon disulphide evaporates, more must be added.

CRYSTALLINE DERIVATIVES OF PRIMARY AND SECONDARY ALIPHATIC AMINES

1. **Benzenesulphonyl or *p*-toluenesulphonyl derivatives.** These are generally very satisfactory. For experimental details, see under *Aromatic Amines*, Section IV, 100, 3.

2. **Phenylthioureas.** Primary and secondary amines react with phenyl isothiocyanate to yield phenylthioureas :

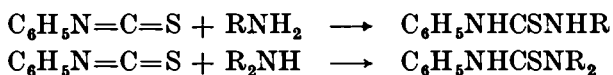

Phenyl isothiocyanate is not sensitive to water ; the reaction may be carried out with an aqueous solution of an amine.

Dissolve equivalent quantities of the reagent and of the amine in a small amount of rectified spirit. If no reaction appears to take place in the cold, reflux the mixture for 5–15 minutes. Upon cooling (and “scratching” with a glass rod, if necessary) the crystalline thiourea separates. Recrystallise it from rectified spirit or from 60–80 per cent. alcohol.

Alternatively, mix equal amounts (say, 0.2 g. of each) of the amine and phenyl isothiocyanate in a test-tube and shake for 2 minutes. If no reaction occurs, heat the mixture gently for 2 minutes and then cool in ice until the mass solidifies. Powder the solid, wash it with a little light petroleum (b.p. 100–120°), and recrystallise from rectified spirit.

α -Naphthyl isothiocyanate yields crystalline α -naphthylthioureas and is similarly applied.

3. **Picrates.** Picric acid combines with amines to yield molecular compounds (picrates), which usually possess characteristic melting points. Most picrates have the composition 1 mol amine : 1 mol picric acid. The picrates of the amines, particularly of the more basic ones, are generally more stable than the molecular complexes formed between picric acid and the hydrocarbons (compare Section IV, 9, 1).

If the amine is soluble in water, mix it with a slight excess (about 25 per cent.) of a saturated solution of picric acid in water (the solubility in cold water is about 1 per cent.). If the amine is insoluble in water, dissolve it by the addition of 2–3 drops of dilute hydrochloric acid (1 : 1) for each 2–3 ml. of water, then add a slight excess of the reagent. If a heavy precipitate does not form immediately after the addition of the picric acid solution, allow the mixture to stand for some time and then shake vigorously. Filter off the precipitated picrate and recrystallise it from boiling water, alcohol or dilute alcohol, boiling 10 per cent. acetic acid, chloroform or, best, benzene.

The following alternative procedure may sometimes be employed. Dissolve 0.5 g. of the amine in 5 ml. of rectified spirit and add 5 ml. of a cold saturated solution of picric acid in alcohol. Warm on a *water bath*

for 5 minutes and allow to cool. Collect the precipitated picrate and recrystallise it as above.

4. **N-Substituted phthalimides.** Phthalic anhydride reacts with primary amines only to yield N-substituted phthalimides :

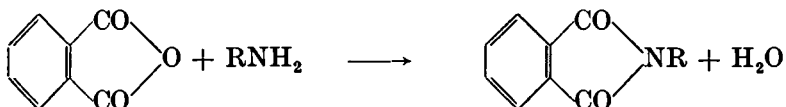

Dissolve 0.5 g. of the primary amine and 0.5 g. of pure phthalic anhydride in 5 ml. of glacial acetic acid and reflux for 20–30 minutes. (If the amine salt is used, add 1 g. of sodium acetate.) The N-substituted phthalimide separates out on cooling. Recrystallise it from alcohol or from glacial acetic acid.

Experimental details for the preparation of derivatives with benzoyl chloride and with 3-nitrophthalic anhydride are given in Section IV, 100, 2 and 7.

The melting points of the derivatives of some primary and secondary aliphatic amines are collected in Table III, 123.

Tertiary aliphatic amines are discussed under *Aromatic Tertiary Amines* in Section IV, 100.

TABLE III,123.

PRIMARY AND SECONDARY ALIPHATIC AMINES

Amine	B.P.	M.P.	d_{4}^{20}	n_D^{20}	Benzene-sulphonamide	<i>p</i> -Toluene-sulphonamide	Phenylthiourea	α -Naphthylthiourea	Picrate	<i>N</i> -Substituted Phthalimide	Benzamide
Methylamine . . .	-7°	—	—	—	30°	75°	113°	192°	215°	134°	80°
Ethylamine . . .	17	—	—	—	58	63	106	121	165	78	71
<i>n</i> -Propylamine . . .	49	—	0.717	1.388	36	52	63	103	135	66	84
<i>iso</i> -Propylamine . . .	35	—	0.689	1.374	26	51	101	143	150	86	100
<i>n</i> -Butylamine . . .	77	—	0.741	1.401	—	—	65	109	151	34	42
<i>iso</i> -Butylamine . . .	68	—	0.735	1.397	53	78	82	137	151	93	57
<i>sec</i> -Butylamine . . .	63	—	0.725	1.393	70	55	101	—	140	—	76
<i>n</i> -Amylamine . . .	105	—	0.754	1.411	—	—	69	103	139	—	—
<i>iso</i> -Amylamine . . .	97	—	0.749	1.408	—	65	102	97	138	—	—
<i>n</i> -Hexylamine . . .	129	—	0.768	—	96	—	77	79	127	—	40
<i>n</i> -Heptylamine . . .	155	—	0.777	—	—	—	75	—	121	—	—
Allylamine . . .	55	—	0.762	1.420	39	64	98	—	140	70	—
<i>cyclo</i> Hexylamine . . .	134	—	0.819	1.437	—	—	—	142	—	158	149
Ethylenediamine . . .	117	—	0.898	1.457	168	160	102	—	233	—	244
Propylenediamine . . .	120	—	0.874	—	—	—	—	—	137	—	193
Ethanolamine . . .	171	—	1.022	1.454	—	—	—	—	160	127	—
<i>l</i> -Menthylamine . . .	212	—	0.854	—	—	—	135	—	—	—	157
Benzylamine . . .	185	—	0.982	1.544	88	116	147	172	196	115	105
α -Phenylethylamine . . .	187	—	—	—	—	—	—	—	189	—	120
β -Phenylethylamine . . .	198	—	0.854	—	69	—	135	—	174	130	116
Dimethylamine . . .	7	—	—	—	47	79	135	168	158	—	41
Diethylamine . . .	56	—	0.707	1.386	42	60	34	108	155	—	42
Di- <i>n</i> -propylamine . . .	110	—	0.738	1.405	51	—	—	161	75	—	—
Di- <i>iso</i> -propylamine . . .	84	—	0.717	1.392	94	—	—	—	140	—	—
Di- <i>n</i> -butylamine . . .	159	—	0.760	1.418	—	—	86	123	59	—	—
Di- <i>iso</i> -butylamine . . .	137	—	0.746	1.409	—	—	—	—	—	—	—
Di- <i>sec</i> -butylamine . . .	135	—	0.753	1.411	—	—	—	—	—	—	—
Di- <i>n</i> -amylamine . . .	67°/4	—	0.777	1.427	—	—	—	—	—	—	—
Di- <i>iso</i> -amylamine . . .	186	—	0.771	1.423	—	—	—	118	—	—	—
Diallylamine . . .	111	—	—	—	—	—	—	—	—	—	—

TABLE III,123.

PRIMARY AND SECONDARY ALIPHATIC AMINES—continued

Amine	B.P.	M.P.	$d_{4}^{20^{\circ}}$	$n_D^{20^{\circ}}$	Benzene-sulphonamide	<i>p</i> -Toluene-sulphonamide	Phenyl-thiourea	α -Naphthyl-thiourea	Picrate	<i>N</i> -Substituted Phthallimide	Benzamide
Piperidine . . .	106°	—	0.861	1.453	94°	96°	—	—	152°	—	48
Pyrrolidine . . .	89	—	0.854	1.424	—	123	—	—	112	—	—
Morpholine . . .	130	—	1.000	1.455	119	147	—	136	148	—	75
Diethanolamino . . .	270d	28°	1.097	1.478	130	99	—	—	110	—	—
Piperazine . . .	140	104	—	—	292 (di)	173 (mono)	—	—	280	—	196 (di)

ESTER-AMIDES (DERIVATIVES OF AMINFORMIC ACID, NH ₂ COOH)											
	B.P.	M.P.	$d_{4}^{20^{\circ}}$	$n_D^{20^{\circ}}$	Derivatives						
Methyl carbamate (NH ₂ COOCH ₃)	177°	54°			<i>N-p</i> -Nitrobenzoyl, 152°; Benzal, 179°						
Ethyl carbamate (urethane)	184	50									
<i>n</i> -Propyl carbamate . . .	195	61									
<i>n</i> -Butyl carbamate . . .	204d	54									
<i>n</i> -Amyl carbamate . . .	—	57									
<i>iso</i> -Amyl carbamate . . .	—	67									
<i>N</i> -Methylurethane (Ethyl <i>N</i> -methyl carbamate)	170	—			<i>N</i> -Acetyl, 59°; <i>N</i> -Benzoyl, 161°; <i>N</i> -Nitroso, 62°						
<i>N</i> -Ethylurethane (Ethyl <i>N</i> -ethyl carbamate)	170	—	0.981	1.422							
<i>N-n</i> -Propylurethane . . .	192										
<i>N-n</i> -Butylurethane . . .	202										
<i>N-sec.</i> -Butylurethane . . .	194										
<i>N</i> -Phenylurethane (Ethyl <i>N</i> -phenyl carbamate)	237	53									
Ethyl oxanilate (C ₆ H ₅ NHCOCOOC ₂ H ₅)	—	67									

Note.—Esters of carbamic acid upon boiling with aniline yield carbanilide (m.p. 238°), ammonia and the corresponding alcohol.

III,124. N-NITROSODIMETHYLAMINE (DIMETHYL-NITROSAMINE)

Secondary amines upon treatment with nitrous acid yield nitrosamines, which are stable, neutral yellow liquids (or low melting point solids), for example :

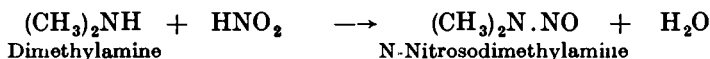

They are readily hydrolysed by boiling dilute hydrochloric acid and the original amine can be recovered by neutralisation with alkali and steam distillation. Primary aliphatic amines liberate nitrogen with nitrous acid whilst tertiary amines are unaffected.

Fit a 100 ml. distilling flask with a condenser for downward distillation. Dissolve 50 g. of dimethylamine hydrochloride (Section III,118) in 25 ml. of water and add dilute sulphuric acid until acid to Congo red paper. Place the resulting solution in the distilling flask and add gradually a solution of 45 g. of pure sodium nitrite in 50 ml. of hot water. Distil the mixture rapidly to dryness, when the nitrosamine passes over (although it is not visible as a separate layer) together with a little of the base as dimethylamine nitrite. To remove the latter, redistil the distillate with a little more dilute sulphuric acid. Add excess of solid potassium carbonate to the distillate; the nitrosamine will appear as a yellow oil. Separate the yellow oil and treat it with more solid potassium carbonate, removing the water layer as it appears, until no further action occurs. Finally transfer to a small flask and dry the liquid over fresh anhydrous potassium carbonate. Distil from a 100 ml. flask and collect the dimethylnitrosamine at 150-151°. The yield is 35 g.

COGNATE PREPARATION

N-Nitrosodiethylamine. Add 36.5 g. (51.5 ml.) of diethylamine slowly to the calculated quantity of carefully standardised 5*N*-hydrochloric acid cooled in ice (1). Introduce the solution of the hydrochloride into a solution of 39 g. of sodium nitrite (assumed to be of 90 per cent. purity) in 45 ml. of water contained in a 250 ml. distilling flask. Distil the mixture rapidly to dryness. Separate the yellow upper layer of the nitrosamine from the distillate; saturate the aqueous layer with solid potassium carbonate and remove the nitroso compound which separates and add it to the main product. Dry over anhydrous potassium carbonate and distil. Collect the diethylnitrosamine at 172-173.5°. The yield is 41 g.

Note.

(1) The experimental details describe the use of a free secondary amine for the preparation of a nitrosamine. Identical results are, of course, obtained by employing solid diethylamine hydrochloride.

Ethyl cyanoacetate, a substance of importance in synthetical work, is prepared from chloroacetic acid by the following series of reactions :

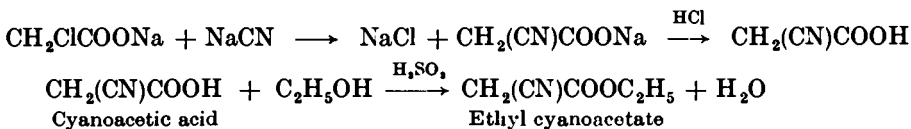

Two compounds, which may be prepared from ethyl cyanoacetate and also find application in synthetical work, may be included here. Cyanoacetamide, prepared from ethyl cyanoacetate and concentrated ammonia solution :

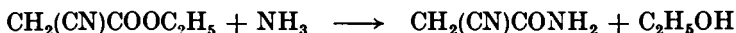

Malononitrile, obtained by the dehydration of cyanoacetamide with phosphorus pentachloride :

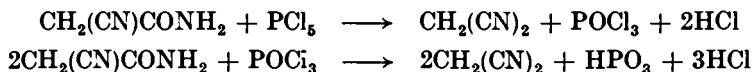

The phosphorus oxychloride formed in the reaction is a dehydrating agent also.

III,125. MONOCHLOROACETIC ACID

Assemble an apparatus consisting of a 1-litre three-necked flask carrying a thermometer, a gas distribution tube (a glass tube with a wide fritted disc sealed on at the bottom) and a reflux condenser. Connect the top of the reflux condenser to two wash bottles containing water and to a third containing sodium hydroxide ; the long tubes in the wash bottles should be just above the surface of the liquid. Place 6 g. of purified red phosphorus (Section II,50,5) and 150 g. of glacial acetic acid in the flask and weigh the apparatus on a rough balance ; heat the mixture to 100°. Pass chlorine from a cylinder, through two empty wash bottles, into the mixture and adjust the stream of chlorine so that a stream of fine bubbles issues through the gas distributor. Gradually increase the flow of chlorine and maintain the temperature inside the flask at 105–110°. Continue the passage of chlorine until the flask increases in weight by about 85 g. ; this roughly corresponds to the formation of monochloroacetic acid. The time required is 4–6 hours. The action of the chlorine is greatly facilitated by exposure of the apparatus to sunlight.

Transfer the reaction product to a 500 ml. Claisen flask and distil over a wire gauze or from an air bath. Some acetyl chloride and acetic acid passes over first, the temperature then rises, and the fraction, b.p. 150–200°, is collected separately ; run out the water from the condenser when the temperature reaches 150°. The fraction, b.p. 150–200°, solidifies on cooling. Drain off any liquid from the crystals as rapidly as possible, and redistil the solid using an air condenser. Collect the fraction b.p. 182–192° : this sets to a solid mass on cooling and melts at 63°. The yield of monochloroacetic acid is 150–175 g.

Note.

Chloroacetic acid must be handled with great care as it causes blisters on the skin.

III,126. MONOBROMOACETIC ACID AND ETHYL BROMOACETATE

Monobromoacetic acid. Place a mixture of 262 g. (250 ml.) of glacial acetic acid, 54 g. (50 ml.) of acetic anhydride and 0.5 ml. of pyridine in a 1-litre round-bottomed flask equipped with a reflux condenser (carrying a cotton wool or calcium chloride tube) and a dropping funnel, the stem of which reaches below the level of the liquid (1). Introduce a few glass beads into the flask and heat the mixture to boiling. Remove the flame, add about 1 ml. of bromine and allow the reaction to proceed until the liquid becomes colourless; this takes about 10 minutes as there appears to be a time lag in the reaction. Add the remainder of the 281g. (90 ml.) of dry bromine (Section II,49,8) as rapidly as it will react and avoiding loss through the condenser; during this period (about 2 hours) keep the acid gently boiling by means of a small flame beneath the flask. When about half of the bromine has been added, the liquid acquires a cherry red colour which it retains throughout the remainder of the bromination. Finally, heat the mixture until it becomes colourless.

Allow to cool and run in 20 ml. of water slowly to destroy the acetic anhydride. Remove the excess of acetic acid and water by heating on a water bath under reduced pressure (*ca.* 35mm.). The residue (220 g.) crystallises on cooling and consists of almost pure monobromoacetic acid (2). If it is required perfectly pure, distil the crude acid from a Claisen flask and collect the fraction of b.p. 202–204°. When distilled under diminished pressure, the acid boils at 117–118°/15 mm. Pure monobromoacetic acid has m.p. 50°.

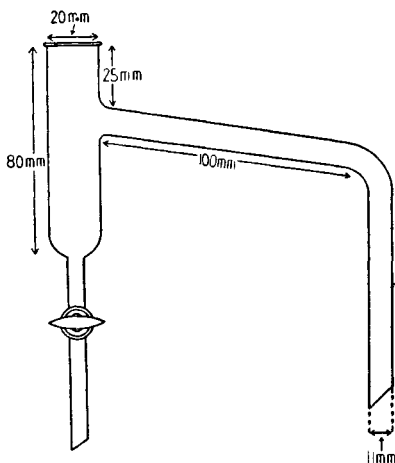

Fig. III, 126, 1.

Notes.

(1) An all-glass apparatus is recommended. Alternatively, a rubber stopper which has been used previously on several occasions (and therefore hardened somewhat) will be satisfactory.

(2) Bromoacetic acid must not be allowed to come into contact with the hands as it causes serious burns.

Ethyl bromoacetate (1). Fit a large modified Dean and Stark apparatus provided with a stopcock at the lower end (a convenient size is shown in Fig. III, 126, 1) to the 1-litre flask containing the crude bromoacetic acid of the previous preparation and attach a double surface condenser to the upper end. Mix the acid with 155 ml. of absolute ethyl alcohol, 240 ml. of sodium-dried benzene and 1 ml. of concentrated sulphuric acid. Heat the flask on a water bath: water, benzene and alcohol will collect in the special apparatus and separate into two layers, the lower layer consisting of approximately 50 per cent. alcohol. Run off the lower layer (*ca.* 75 ml.), which includes all the water formed in the

reaction together with excess of alcohol. When no more water separates, the reaction may be regarded as complete; add 20 ml. of absolute alcohol to the reaction mixture and continue refluxing for a further 30 minutes. Run off the benzene which has collected in the trap. Transfer the reaction mixture to a separatory funnel, and wash it successively with 400 ml. of water, 400 ml. of 1 per cent. sodium bicarbonate solution and 400 ml. of water. Dry over anhydrous sodium or magnesium sulphate and distil through a short, well-lagged fractionating column (*e.g.*, an all-glass Dufton column). Collect the ethyl bromoacetate at 154–155°. The yield is 205 g.

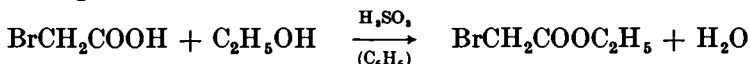

Note.

(1) Ethyl bromoacetate vapour is extremely irritating to the eyes. The preparation must therefore be conducted in a fume cupboard provided with a good draught; the material should be kept in closed vessels as far as possible.

COGNATE PREPARATIONS

α -Bromo-*n*-caproic acid. Place 100 g. (107 ml.) of freshly-distilled, dry *n*-caproic acid (b.p. 202–205°) and 150 g. (48 ml.) of dry bromine (Section II, 49, 8) in a 500 ml. flask equipped with a reflux condenser, the top of which is connected with a trap and absorption vessel containing water (compare Fig. III, 28, 1) (1). Momentarily remove the condenser and add cautiously 1.5 ml. of phosphorus trichloride. Heat the mixture on a water bath to 65–70°, when reaction will commence and hydrogen bromide is smoothly evolved. Towards the end of the reaction allow the temperature of the bath to rise to 100°. The reaction is complete when all the bromine has reacted (about 4 hours). Transfer the reaction mixture to a Claisen flask and distil first with a water pump: much hydrogen bromide is evolved and a fraction of low boiling point passes over. When all the low boiling point fraction has distilled, connect the flask to an oil pump or to the laboratory vacuum installation and collect the α -bromo-*n*-caproic acid at 116–125°/8 mm. (or at 132–140°/15 mm.). The yield is 145 g. Upon redistillation the α -bromo-*n*-caproic acid passes over almost entirely at 128–131°/10 mm.

Note.

(1) The flask should preferably be connected to the condenser by means of a ground glass joint; if not available, an old rubber stopper may be used.

α -Bromopropionic acid. Proceed as detailed for α -bromo-*n*-caproic acid using 64 g. (64.5 ml.) of freshly-distilled, dry propionic acid (b.p. 139–142°), 150 g. (48 ml.) of dry bromine and 1.5 ml. of phosphorus trichloride. The reaction commences on warming to about 50°. Collect the α -bromopropionic acid at 95–97°/10 mm. or at 100–102°/15 mm. The yield is 110 g.

Ethyl α -bromopropionate. This preparation illustrates the facile bromination of an acid chloride (propionyl chloride) in the presence of red phosphorus, and the subsequent conversion of the bromoacid chloride into the ethyl ester by direct interaction with ethanol.

In a 750 ml. three-necked flask, equipped with a dropping funnel, double-surface condenser and a device for absorbing the sulphur dioxide evolved (see Figs. II, 8, 1-2), place 220 g. (135 ml.) of redistilled thionyl chloride, and heat to boiling. Add 125 g. (126 ml.) of pure propionic acid at such a rate that the mixture refluxes gently (*ca.* 1 hour). Reflux the mixture for 30 minutes to expel dissolved sulphur dioxide, allow to cool, and add 0.5 g. of purified red phosphorus. Introduce 310 g. (100 ml.) of dry bromide during 5-7 hours to the gently boiling propionyl chloride, and then reflux the mixture for 7 hours, by which time the evolution of hydrogen bromide almost ceases. Add the crude α -bromopropionyl chloride during 2 hours to 250 ml. of absolute ethanol contained in a three-necked flask, equipped with a mechanical stirrer and reflux condenser; complete the reaction by heating on a water bath for 4 hours, when hydrogen chloride is slowly evolved. Filter the crude ester into 500 ml. of distilled water, separate the oil and wash it successively with water, sodium bicarbonate solution and water; dry. Distil at normal pressure to remove the low b.p. fraction (largely ethyl bromide: 75 g.) and then under diminished pressure. Collect the ethyl α -bromopropionate as a colourless liquid at 69-70°/25 mm.; the yield is 221 g.

III,127.

DICHLOROACETIC ACID

Fit a 1500 ml. bolt-head flask with a reflux condenser and a thermometer. Place a solution of 125 g. of chloral hydrate in 225 ml. of warm water (50-60°) in the flask, add successively 77 g. of precipitated calcium carbonate, 1 ml. of amyl alcohol (to decrease the amount of frothing), and a solution of 5 g. of commercial sodium cyanide in 12 ml. of water. An exothermic reaction occurs. Heat the warm reaction mixture with a small flame so that it reaches 75° in about 10 minutes and then remove the flame. The temperature will continue to rise to 80-85° during 5-10 minutes and then falls; at this point heat the mixture to boiling and reflux for 20 minutes. Cool the mixture in ice to 0-5°, acidify with 107.5 ml. of concentrated hydrochloric acid. Extract the acid with five 50 ml. portions of ether. Dry the combined ethereal extracts with 10 g. of anhydrous sodium or magnesium sulphate, remove the ether on a water bath, and distil the residue under reduced pressure using a Claisen flask with fractionating side arm. Collect the dichloroacetic acid at 105-107°/26 mm. The yield is 85 g.

III,128.

TRICHLOROACETIC ACID

Place 40 g. of chloral hydrate in a 250 ml. Claisen flask and heat it so that the solid just melts. Add cautiously through a dropping funnel supported over the long neck of the flask 25 g. (17 ml.) of fuming nitric acid. When the evolution of gases ceases, warm the flask gently until the evolution of brown fumes is complete. Arrange the flask for distillation and collect the liquid boiling at 194-196° (air condenser) as trichloroacetic acid; this solidifies on cooling and melts at 57°. The yield is 25 g.

III,129. GLYCINE (AMINOACETIC ACID)

Dissolve 180 g. of commercial ammonium carbonate in 150 ml. of warm water (40–50°) in a 700 ml. flask. Cool to room temperature and add 200 ml. of concentrated ammonia solution (sp. gr. 0.88). Introduce slowly, with swirling of the contents of the flask, a solution of 50 g. of chloroacetic acid (Section III,125) in 50 ml. of water [**CAUTION**: do not allow chloroacetic acid to come into contact with the skin as unpleasant burns will result]. Close the flask with a solid rubber stopper and fix a thin copper wire to hold the stopper in place: do not moisten the portion of the stopper in contact with the glass as this lubrication will cause the stopper to slide out of the flask. Allow the flask to stand for 24–48 hours at room temperature. Transfer the mixture to a distilling flask and distil in a “closed” apparatus until the volume is reduced to 100–110 ml. A convenient arrangement is to insert a drawn-out capillary tube into the flask, attach a Liebig’s condenser, the lower end of which fits into a filter flask (compare Fig. II, 37, 1) and connect the latter to a water filter pump. If the solution is not colourless, warm it with about 1 g. of decolourising carbon and filter. Treat the cold filtrate with 400 ml. of methyl alcohol: stir the solution during the addition of the methyl alcohol and cool it in an ice chest (or in a refrigerator) for 4–6 hours to permit of complete crystallisation. Filter off the crude glycine, which contains ammonium chloride as the chief impurity. Most of the latter may be removed by suspending the crystals in 150 ml. of methyl alcohol, stirring well, filtering, and washing with a little methyl alcohol and finally with ether. The yield is 25 g. Further purification may be carried out as follows. Dissolve the glycine (25 g.) in 50 ml. of warm water, shake the solution with 2 g. of decolourising carbon, and filter. Precipitate the glycine by the addition of 200 ml. of methyl alcohol; collect the glycine on a Buchner funnel, wash it with methyl alcohol and ether, and dry it in the air. The resulting glycine darkens at 237° and melts at 240° with decomposition.

COGNATE PREPARATION

dl-Alanine. Use 225 g. of ammonium carbonate, 175 ml. of water, 250 ml. of concentrated ammonia solution and 77 g. of α -bromopropionic acid (Section III,126). Proceed exactly as for glycine. The yield of α -aminopropionic acid is 30 g. The m.p., after recrystallisation from water, is 197–198° (decomp.).

III,130. α -AMINO-*n*-CAPROIC ACID (NORLEUCINE)

Place 425 ml. of concentrated ammonia solution (sp. gr. 0.88) in a 500 ml. round-bottomed flask and add slowly 75 g. of α -bromocaproic acid (Section III,126). Stopper the flask tightly and allow it to stand in a warm place (50–55°) for 30 hours. Filter the amino acid at the pump and keep the filtrate (*A*) separately. Wash the amino acid (*ca.* 26 g.) well with methyl alcohol to remove the ammonium bromide present. Evaporate the aqueous filtrate (*A*) almost to dryness on a steam bath,

and add 150 ml. of methyl alcohol. A second crop of amino acid, contaminated with ammonium bromide, is thus obtained; wash it with methyl alcohol and recrystallise from hot water, thus affording a further 7 g. of pure norleucine. The total yield is 32 g. The decomposition point is about 327°.

III,131.

ETHYL CYANOACETATE

Place 208 g. of chloroacetic acid [*CAUTION*: do not allow the acid to come into contact with the hands] and 315 g. of crushed ice in a battery jar or in a large beaker and neutralise it accurately to litmus with a cold solution of sodium hydroxide (100 g. in 300 ml. of water; about 275 ml. are required): do not allow the temperature to rise above 30° during the neutralisation. Prepare, in the fume cupboard, a solution of 125 g. of sodium cyanide (97-98 per cent. powder) in 250 ml. of water in a 3-litre flask: heat to about 55° for rapid solution and finally to boiling. Add to the resulting hot solution 100 ml. of the solution of sodium chloroacetate and remove the flame immediately the reaction commences. When the vigorous reaction has subsided somewhat, add another 100 ml. portion, followed by the remainder when the temperature commences to fall again. Boil the mixture for 5 minutes but no longer (otherwise some hydrogen cyanide may be lost and some sodium glycollate may form) and then cool with running water for 30 minutes. Filter the solution if it is not clear.

Liberate the cyanoacetic acid by adding with vigorous stirring 250 ml. (290 g.; a slight excess) of hydrochloric acid, sp. gr. 1.156. Evaporate the solution on a water bath at 60-70° under a pressure of 20-30 mm. (Fig. II, 37, 1) until practically no more distillate passes over; do not heat above 75° as considerable loss may result owing to the decomposition of the cyanoacetic acid. Add 250 ml. of rectified spirit to the residue, filter at the pump (1) from the sodium chloride, and wash the residue with another 200 ml. of rectified spirit. Evaporate the alcoholic solution under reduced pressure from a water bath (Fig. II, 37, 1) maintained at 50-60° (2) until no more liquid distils over: the residue weighs about 225 g. Add a mixture of 250 ml. of absolute ethyl alcohol and 4.5 ml. of concentrated sulphuric acid, and reflux on a water bath for 3 hours. Remove the excess of alcohol and some of the water formed by distillation under reduced pressure from a water bath. Heat the residue again with 125 ml. of absolute ethyl alcohol and 2 ml. of concentrated sulphuric acid for 2 hours, and remove the excess of alcohol under diminished pressure as before. Allow the ester to cool to room temperature and neutralise the sulphuric acid with a concentrated solution of sodium carbonate. Separate the upper layer of ester, and extract the aqueous solution with ether or benzene (about 10 per cent. of the yield is in the extract). Dry the combined products with anhydrous magnesium sulphate and transfer to a Claisen flask. Remove the solvent under normal pressure and then distil the ester under reduced pressure. Collect the ethyl cyanoacetate at 97-98°/16 mm. (or at 101-102°/19 mm. or 107-108°/27 mm.). The yield is 180 g.

Notes.

(1) It is easier to remove the sodium chloride by centrifugation. If this method is adopted, wash the salt first with 200 ml. and then with 100 ml. of ethanol.

(2) The solution containing mineral acid should not be heated above 50–60° or diethyl malonate will be formed.

COGNATE PREPARATIONS

Cyanoacetamide. Place 150 ml. of concentrated aqueous ammonia solution (sp. gr. 0.88) in a 500 ml. wide-mouthed conical flask and add 200 g. (188 ml.) of ethyl cyanoacetate. Shake the cloudy mixture: some heat is evolved and it becomes clear in about 3 minutes. Stand the loosely stoppered flask in an ice-salt mixture for 1 hour, filter rapidly with suction, and wash the solid with two 25 ml. portions of ice-cold ethanol. Dry in the air: the yield of pale yellow cyanoacetamide is 110 g. (1). Recrystallise from 190 ml. of 95 per cent. ethanol; a colourless product, m.p. 119–120°, is deposited with practically no loss.

Note.

(1) A further 25 g. of cyanoacetamide may be obtained by evaporating the original mother liquor to dryness under reduced pressure (water pump) whilst heating the flask on a steam bath. The residue is dissolved in 50 ml. of hot ethanol, the solution shaken for a few minutes with decolourising carbon, filtered with suction whilst hot, and then cooled in ice. The resulting yellowish amide is recrystallised with the addition of decolourising carbon, if necessary.

Malononitrile. Mix 75 g. of cyanoacetamide intimately with 75 g. of dry phosphorus pentachloride in a glass mortar (*FUME CUPBOARD!*). Transfer the mixture as rapidly as possible (with the aid of a large glass funnel with cut-off stem) to a 500 ml. Claisen flask fitted with a wide-bore capillary or (drawn-out) glass tube (to reduce the danger of "blocking") and a thermometer. Attach the Claisen flask by means of a long air condenser to a 200 ml. filter flask, which in turn is connected to a powerful water pump (or two glass water pumps in parallel) and a manometer. Evacuate the system to about 30 mm. of mercury and immerse the Claisen flask in a boiling water bath. The mixture gradually melts, boiling commences about 15 minutes before the solid has melted completely and the pressure rises to about 150 mm. owing to the liberation of hydrogen chloride and phosphorus oxychloride. The evolution of gas slackens in about 30–35 minutes, the boiling is then less vigorous and the pressure falls. At this point, change the receiver and immerse it in ice water. Remove the Claisen flask immediately from the water bath, wipe it dry and immerse it in an oil bath at 140° to within 10 cm. of the top of the flask. The malononitrile commences to pass over at 113°/30 mm. (or 125°/50 mm.): raise the temperature of the oil bath over a period of 25 minutes to 180°. Collect the dinitrile at 113–125°/30 mm.; if it solidifies in the air condenser melt it by the application of a small flame. Remove the oil bath when distillation has almost ceased; discolouration of the product is thus prevented. The yield of crude dinitrile is 45 g. Redistil and collect the pure malononitrile at 113–120°/30 mm. as a colourless liquid (40 g.); this quickly solidifies on cooling, m.p. 29–30°. Store in a brown bottle and protect it from the light.

(v) Upon treating a solution of an α -amino acid with a few drops of a 0.25 per cent. aqueous solution of ninhydrin (triketohydrindene hydrate), a blue colouration is produced.

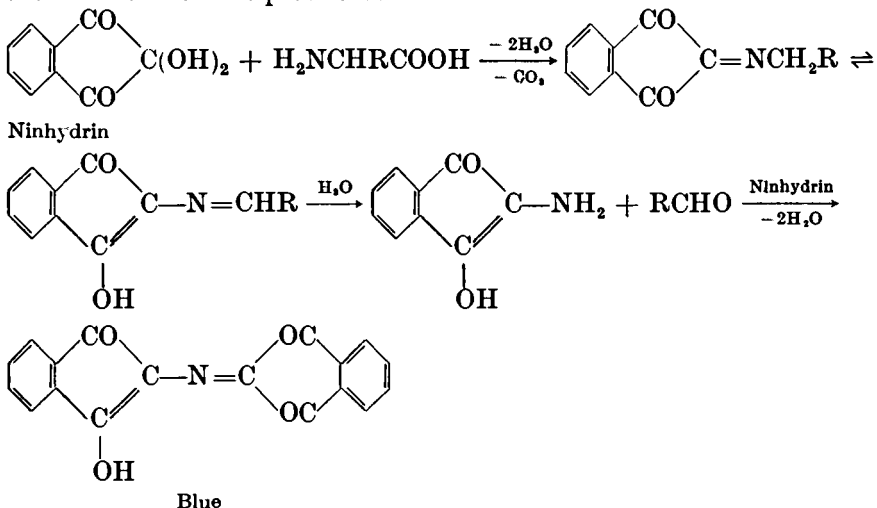

The colour test is not specific for α -amino acids: other primary amino compounds and also ammonia give a blue colouration with ninhydrin.

Crystalline derivatives of amino acids are usually produced by reaction at the amino group by treatment with appropriate reagents in alkaline solution:

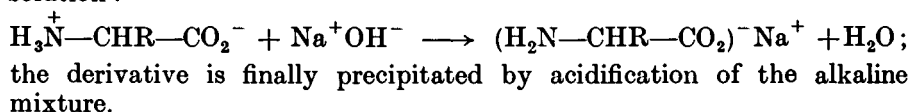

CRYSTALLINE DERIVATIVES OF AMINO ACIDS

1. **Benzoates.** Dissolve 0.5 g. of the amino acid in 10 ml. of 10 per cent. sodium bicarbonate solution and add 1 g. of benzoyl chloride. Shake the mixture vigorously in a stoppered test-tube; remove the stopper from time to time since carbon dioxide is evolved. When the odour of benzoyl chloride has disappeared, acidify with dilute hydrochloric acid to Congo red and filter. Extract the solid with a little cold ether to remove any benzoic acid which may be present. Recrystallise the benzoyl derivative which remains from hot water or from dilute alcohol.

2. **3 : 5-Dinitrobenzoates.** The following experimental details are for glycine (aminoacetic acid) and may be easily adapted for any other amino acid. Dissolve 0.75 g. of glycine in 20 ml. of *N* sodium hydroxide solution and add 2.32 g. of finely powdered 3 : 5-dinitrobenzoyl chloride. Shake the mixture vigorously in a stoppered test-tube; the acid chloride soon dissolves. Continue the shaking for 2 minutes, filter (if necessary) and acidify with dilute hydrochloric acid to Congo red. Recrystallise the derivative immediately from water or 50 per cent. alcohol.

Excess of the reagent should be avoided, if possible. If excess of dinitrobenzoyl chloride is used, this appears as the acid in the precipitate obtained upon acidifi-

cation : the acid can be removed by shaking in the cold with a mixture of 5 volumes of light petroleum (b.p. 40-60°) and 2 volumes of alcohol. The glycine derivative is insoluble in this medium. For some amino acids (leucine, valine and phenylalanine) acetic acid should be used for acidification.

3. α -Naphthylureido acids (or α -naphthylhydantoic acids). Amino acids react in alkaline solution with α -naphthyl isocyanate to yield the sodium salts of the corresponding α -naphthylureido acids, which remain in solution : upon addition of a mineral acid, the ureido acid is precipitated.

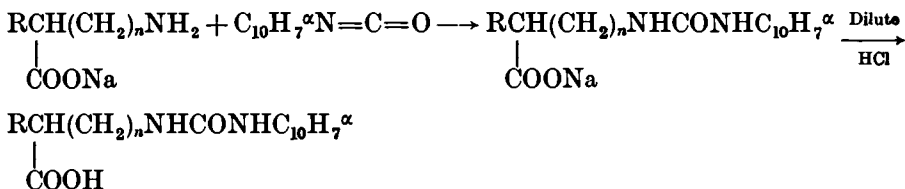

Dissolve 0.5 g. of the amino acid in slightly more than the equivalent quantity of *N* sodium hydroxide solution in a small glass bottle or flask. Add a quantity of α -naphthyl isocyanate just equivalent to the alkali (if the molecular weight of the compound is not known, use 1 g. of the reagent and the corresponding quantity of alkali), stopper the bottle or flask and shake vigorously until the odour of the reagent has disappeared. Filter off any insoluble di- α -naphthylurea (resulting from the action of water upon the excess of the reagent), and acidify the filtrate to Congo red with dilute hydrochloric acid. Filter the α -naphthylhydantoic acid at the pump, wash it with a little cold water, and recrystallise from hot water or dilute alcohol.

The phenylhydantoic acid is prepared similarly, using phenyl isocyanate. The latter is more sensitive to water than α -naphthyl isocyanate and therefore does not keep so well.

4. *p*-Toluenesulphonates. Amino acids react with *p*-toluenesulphonyl chloride (compare Section IV,100,3) under the following experimental conditions to yield, in many cases, crystalline *p*-toluenesulphonates.

Dissolve 0.01 g. equivalent of the amino acid in 20 ml. of *N* sodium hydroxide solution and add a solution of 2 g. of *p*-toluenesulphonyl chloride in 25 ml. of ether ; shake the mixture mechanically or stir vigorously for 3-4 hours. Separate the ether layer : acidify the aqueous layer to Congo red with dilute hydrochloric acid. The derivative usually crystallises out rapidly or will do so on standing in ice. Filter off the crystals and recrystallise from 4-5 ml. of 60 per cent. alcohol.

With phenylalanine and tyrosine, the sodium salt of the derivative is sparingly soluble in water and separates during the initial reaction. Acidify the suspension to Congo red : the salts pass into solution and the mixture separates into two layers. The derivative is in the ethereal layer and crystallises from it within a few minutes. It is filtered off and recrystallised.

5. **2 : 4-Dichlorophenoxyacetates.** Amino acids react with 2 : 4-dichlorophenoxyacetyl chloride to give crystalline derivatives :

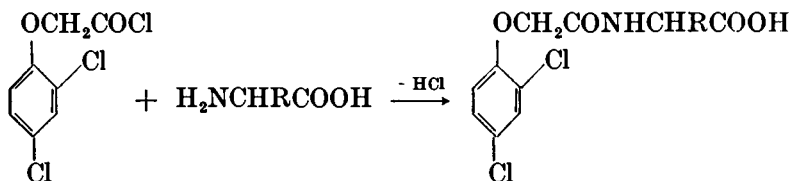

Dissolve 0.01 g. equivalent of the amino acid in 0.03 g. equivalent of *N* sodium hydroxide solution and cool to 5° in a bath of ice. Add, with rapid stirring, 0.01 g. equivalent of 2 : 4-dichlorophenoxyacetyl chloride dissolved in 5 ml. of dry benzene at such a rate (5–10 minutes) that the temperature of the mixture does not rise above 15° ; if the reaction mixture gels after the addition of the acid chloride, add water to thin it. Remove the ice bath and stir for 2–3 hours. Extract the resulting mixture with ether, and acidify the aqueous solution to Congo red with dilute hydrochloric acid. Collect the precipitate by filtration and recrystallise it from dilute alcohol.

Commercial 2 : 4-dichlorophenoxyacetic acid may be recrystallised from benzene ; m.p. 139–140°. Reflux 10 g. of the acid with 15 ml. of thionyl chloride on a steam bath for 1 hour, distil off the excess of thionyl chloride at atmospheric pressure and the residue under reduced pressure : 2 : 4-dichlorophenoxyacetyl chloride (8 g.) passes over at 155–157°/22–23 mm. It occasionally crystallises (m.p. 44.5–45.5°), but usually tends to remain as a supercooled liquid.

6. **Phthalyl derivatives.** Many amino acids condense with phthalic anhydride at 180–185° to yield crystalline phthalyl derivatives :

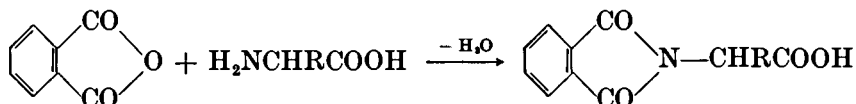

Place 0.5 g. of the amino acid and 1.0 g. of phthalic anhydride in a Pyrex test-tube and immerse the lower part of the tube in an oil bath, which has previously been heated to 180–185°. Stir the mixture occasionally during the first 10 minutes and push down the phthalic anhydride which sublimates on the walls into the reaction mixture with a glass rod. Leave the mixture undisturbed for 5 minutes. After 15 minutes, remove the test-tube from the bath : when the liquid mass solidifies, invert the test-tube and scrape out the excess of phthalic anhydride on the walls. Recrystallise the residue from 10 per cent ethanol or from water.

The melting points of the derivatives of a number of amino acids are collected in Table III, 132. Most α -amino acids decompose on heating so that the melting points would be more accurately described as decomposition points : the latter vary somewhat with the rate of heating and the figures given are those obtained upon rapid heating.

TABLE III,132.

AMINO ACIDS

Amino Acid	M.P.*	Benzoate	3:5-Dinitro- benzoate	Phenyl- ureido Acid	<i>p</i> -Toluene- sulphonate	2:4-Dichloro- phenoxy- acetate	α -Naphthyl- ureido Acid	Phthalyl Derivative
Glycine	232°	187°	179°	163°	150°	235°	191°	192°
<i>dl</i> - α -Alanine	295	166	177	174	139	213	198	161
<i>d</i> - or <i>l</i> - α -Alanine	297	151	—	190	139	199	202	—
β -Alanine	196	165	202	174	—	—	236	—
<i>dl</i> -Valine	298	132	—	164	110	159	204	102
<i>d</i> - or <i>l</i> -Valine	315	127	181	147	149	—	—	—
<i>dl</i> -Leucine	332	141	—	165	—	138	—	141
<i>d</i> - or <i>l</i> -Leucine	337	107	187	115	124	150	163	116
<i>dl</i> - <i>iso</i> -Leucine	292	118	—	—	141	143	—	—
<i>d</i> - or <i>l</i> - <i>iso</i> -Leucine	284	117	—	120	132	—	178	121
<i>dl</i> - <i>nor</i> -Leucine	327	—	—	—	124	—	—	112
<i>dl</i> -Serine	246	171	183	169	213	195	191	—
<i>dl</i> -Threonine	235	148	—	—	—	139	—	103
<i>d</i> - or <i>l</i> -Threonine	253	148	—	—	—	—	—	—
<i>dl</i> -Aspartic Acid	280	165	—	—	—	217	—	—
<i>d</i> - or <i>l</i> -Aspartic Acid	272	185	—	162	140	202	115	—
<i>dl</i> -Asparagine	—	—	—	—	—	—	—	—
<i>d</i> - or <i>l</i> -Asparagine	227	189	196	164	175	—	119	—
<i>dl</i> -Glutamic acid	227	156	—	—	213	192	—	—
<i>d</i> - or <i>l</i> -Glutamic acid	198	138	217	—	117	—	236	189
<i>dl</i> -Histidine	—	—	—	—	—	129	—	—
<i>d</i> - or <i>l</i> -Histidine	277	249	189	—	204	—	—	296
<i>dl</i> -Arginine	238	230	—	—	—	—	—	—
<i>dl</i> -Lysine	—	249	—	196	—	176	—	171
<i>d</i> - or <i>l</i> -Lysine	224	150	169	184	—	87	199	—
<i>N</i> -Phenylglycine	126	63	—	195	—	—	—	—
<i>dl</i> -Phenylalanine	274	188	93	182	135	180	—	175
<i>d</i> - or <i>l</i> -Phenylalanine	320	146	93	181	165	155	—	—
<i>dl</i> -Tyrosine	318	197	254	—	—	—	—	268

* For footnote, see p. 440.

TABLE III,132.

AMINO ACIDS—Continued

Amino Acid	M.P.*	Benzoate	3 : 5-Dinitrobenzoate	Phenylureido Acid	<i>p</i> -Toluene-sulphonate	2 : 4-Dichlorophenoxyacetate	α -Naphthylureido Acid	Phthalyl Derivative
<i>d</i> - or <i>l</i> -Tyrosine . . .	344°	166°	—	104°	119°	—	205°	—
<i>dl</i> -Tryptophane . . .	275	188	240°	—	176	148°	—	—
<i>d</i> - or <i>l</i> -Tryptophane . . .	289	104	233	166	176	—	158	—
<i>d</i> - or <i>l</i> -Cystine . . .	260	181	180	160	205	216	—	—
<i>dl</i> -Methionine . . .	272	151	—	—	105	145	—	—
<i>d</i> - or <i>l</i> -Methionine . . .	283	150	95	—	—	134	186	—
<i>dl</i> -Proline . . .	203	—	217	170	—	145	—	—
<i>d</i> - or <i>l</i> -Proline . . .	222	—	—	170	133	106	—	—
Sarcosine . . .	210	103	153	—	102	—	—	—
Anthranilic acid . . .	145	182	278	181	217	—	—	—
<i>m</i> -Aminobenzoic acid . . .	174	248	270	270	—	—	—	—
<i>p</i> -Aminobenzoic acid . . .	186	278	290	300	223	—	—	—
<i>p</i> -Aminophenylacetic acid . . .	200	206	—	—	—	—	—	—
<i>dl</i> - α -Amino- <i>n</i> -butyric acid . . .	307	147	—	170	—	—	194	—
α -Amino- <i>iso</i> -butyric acid . . .	280	202d	—	—	—	—	198	—
	Sub.							

* These melting points are probably better described as decomposition points; their values will depend somewhat upon the rate of heating.

III,133.

UREA

Wohler's classical synthesis of urea from ammonium cyanate may be carried out by evaporating solutions of sodium cyanate and ammonium sulphate :

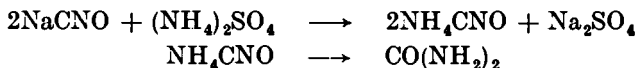

In aqueous solution at 100° the change is reversible and equilibrium is reached when 95 per cent. of the ammonium cyanate has changed into urea. Urea is less soluble in water than is ammonium sulphate, hence if the solution is evaporated, urea commences to separate, the equilibrium is disturbed, more ammonium cyanate is converted into urea to maintain the equilibrium and eventually the change into urea becomes almost complete. The urea is isolated from the residue by extraction with boiling methyl or ethyl alcohol. The mechanism of the reaction which is generally accepted involves the dissociation of the ammonium cyanate into ammonia and cyanic acid, and the addition of ammonia to the latter :

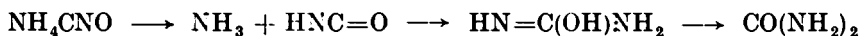

The industrial methods of preparation are :—

(i) by partial hydrolysis of cyanamide, itself derived from calcium cyanamide :

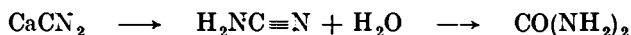

(ii) by heating ammonium carbamate (from carbon dioxide and ammonia) under pressure :

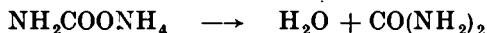

Dissolve 20 g. of sodium cyanate in 75 ml. of distilled water in an evaporating dish and mix this with a solution of 25 g. of ammonium sulphate in 75 ml. of water. Evaporate to *complete* dryness on a water bath ; break the crystalline crust from time to time by stirring with a glass rod. Transfer the residue to a 250 ml. flask fitted with a reflux condenser, add 30 ml. of absolute ethyl or methyl alcohol, and boil gently for 5–10 minutes in order to extract the urea. Filter the boiling solution through a fluted filter paper (preferably contained in a hot water funnel). Return the residue to the flask and extract again with 30 ml. of methyl or ethyl alcohol ; filter as before and wash the residue on the filter with 10 ml. of boiling alcohol. Combine the filtrates and cool in crushed ice. Filter the crystals of urea at the pump and allow to dry in the air. The yield is 8 g., m.p. 132°. A further small quantity of urea may be obtained by evaporating the alcoholic filtrate to about 10 ml. and cooling in ice.

REACTIONS OF UREA

The student should carry out the following reactions of urea :

(i) **Solubility.** Confirm that urea is very soluble in water and dissolves in hot methyl, ethyl and amyl alcohol, but is almost insoluble in ether.

(ii) **Sodium hydroxide solution.** Dissolve 0.2 g. of urea in 5 ml. of dilute sodium hydroxide solution and warm. Observe that ammonia is evolved.

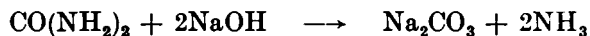

(iii) **Nitrous acid.** Dissolve 0.2 g. of urea in 2-3 ml. of dilute hydrochloric acid and add 3 ml. of dilute (about 5 per cent.) sodium nitrite solution. Effervescence occurs, and nitrogen and carbon dioxide are evolved :

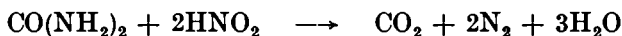

(iv) **Sodium hypobromite (or hypochlorite) solution.** Dissolve 0.5 g. of urea in 3 ml. of water and add 5-10 ml. of dilute sodium hypochlorite or hypobromite solution.* Nitrogen is evolved.

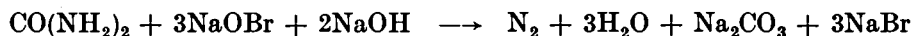

(v) **Urea nitrate.** Dissolve 0.5 g. of urea in 3 ml. of water and add 1 ml. of concentrated nitric acid. White crystals of urea nitrate ($\text{CO}(\text{NH}_2)_2 \cdot \text{HNO}_3$) separate immediately.

(vi) **Urea oxalate.** Dissolve 0.5 g. of urea in 3 ml. of water and add a solution of 0.6 g. of oxalic acid in 7 ml. of water. Upon stirring urea oxalate ($2\text{CO}(\text{NH}_2)_2 \cdot \text{H}_2\text{C}_2\text{O}_4$) crystallises out.

Urea oxalate is also sparingly soluble in amyl alcohol and since urea is soluble in this alcohol, the property may be utilised in separating urea from mixtures. An aqueous extract of the mixture is rendered slightly alkaline with sodium hydroxide solution and extracted with ether; this removes all the basic components, but not urea. The residual aqueous solution is extracted with amyl alcohol (to remove the urea): upon adding this extract to a solution of oxalic acid in amyl alcohol crystalline urea oxalate is precipitated.

(vii) **Biuret reaction.** Place 0.5 g. of urea in a dry test-tube and heat gently just above the m.p. for 1-2 minutes. Ammonia is first evolved and the residue solidifies with the formation of biuret :

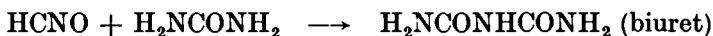

The latter may be identified by dissolving the residue in 5 ml. of water and adding 1 drop of very dilute copper sulphate solution and 2 drops of 10 per cent. sodium hydroxide solution: a violet colour is produced.

(viii) **Xanthhydrol reaction.** Add a solution of 0.1 g. of urea in 2 ml. of acetic acid to 1-2 ml. of a 5 per cent. solution of xanthhydrol in acetic acid or in methyl alcohol (see Section III,110) and warm. Filter off the dixanthhydril urea and recrystallise it from aqueous dioxan; wash with a little alcohol and ether, and dry at 80°. Determine the m.p. (274°).

III,134. THIOUREA (THIOCARBAMIDE)

Thiourea (II) may be obtained from ammonium thiocyanate (I) by an isomeric change analogous to ammonium cyanate, but the equilibrium relationship is very different (compare Section III,133) :

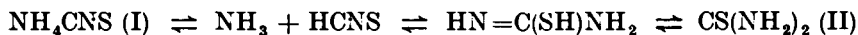

* The hypobromite solution may be prepared by treating 5 ml. of bromine water with dilute sodium hydroxide solution, dropwise, until the bromine colour is just discharged.

Between 140° and 180° equilibrium is set up at a fairly rapid rate, but only 25 per cent. of thiourea is present in the equilibrium mixture. The yield is therefore far from satisfactory.

It is prepared commercially by treating cyanamide (from calcium cyanamide) with ammonium sulphide :

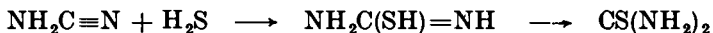

Place 50 g. of ammonium thiocyanate in a small round-bottomed flask and immerse a thermometer in the substance. Heat in an oil bath until the temperature rises to 170° and maintain it at this temperature for 1 hour. Allow the melt to cool and extract it with 60–70 ml. of hot water. Filter the solution and allow to cool when crude thiourea separates; the unchanged ammonium thiocyanate remains in the solution. Filter off the crude product and recrystallise it from a little hot water. The yield of thiourea, m.p. 172°, is 8 g.

POLYHYDRIC ALCOHOLS, FATS AND SOAPS

Polyhydric alcohols are compounds containing two or more hydroxyl groups in the molecule. The two most important are *ethylene glycol* $\text{HOCH}_2\text{CH}_2\text{OH}$ (a dihydric alcohol) and *glycerol* $\text{HOCH}_2\text{CH}(\text{OH})\text{CH}_2\text{OH}$ (a trihydric alcohol). Ethylene glycol may be obtained by the hydrolysis of ethylene dibromide or ethylene dichloride with dilute aqueous sodium hydroxide or sodium carbonate solution :

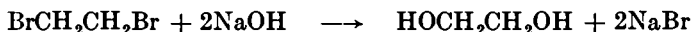

Industrially, it is produced directly from ethylene by the addition of hypochlorous acid, followed by treatment of the resulting ethylene chlorohydrin with sodium bicarbonate solution :

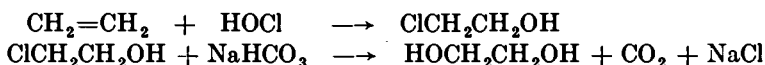

When ethylene chlorohydrin is heated with sodium hydroxide solution, the highly reactive cyclic ether, *ethylene oxide*, is formed :



Upon reaction with an alcohol in the presence of a catalyst, the monoalkyl ether of ethylene glycol is obtained :

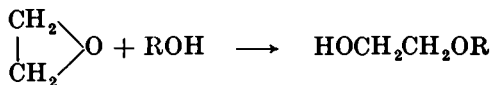

The monoalkyl ethers with $\text{R} = \text{CH}_3$, C_2H_5 and $\text{C}_4\text{H}_9^\alpha$, known respectively as *methyl cellosolve*, *cellosolve* and *butyl cellosolve*, are of great commercial value, particularly as solvents, since they combine the properties of alcohols and ethers and are miscible with water. Equally important compounds are the *carbitols* (monoalkyl ethers of diethyleneglycol) prepared by the action of ethylene oxide upon the monoethers of ethylene glycol :

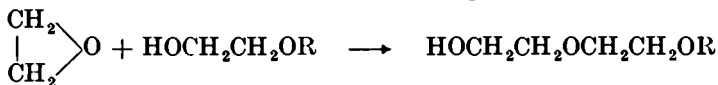

Thus with $\text{R} = \text{CH}_3$, C_2H_5 and $\text{C}_4\text{H}_9^\alpha$, the compounds are called *methyl carbitol*, *carbitol* and *butyl carbitol* respectively. None of these compounds can be conveniently prepared in the laboratory by elementary students : they are, however, readily available commercially. The preparation of one glycol, pinacol or tetramethylene glycol from acetone, has already been described (Section III,77).

The term **fat** is applied to solid esters of fatty acids with glycerol (glycerides) ; if the fat is liquid at the ordinary temperature, it is conventionally called a **fatty oil**, **vegetable oil** or **animal oil**. The acids which occur most abundantly are palmitic acid $\text{CH}_3(\text{CH}_2)_{14}\text{COOH}$, stearic acid $\text{CH}_3(\text{CH}_2)_{16}\text{COOH}$ and oleic acid $\text{CH}_3(\text{CH}_2)_7\text{CH}=\text{CH}(\text{CH}_2)_7\text{COOH}$. Upon hydrolysis, fats yield glycerol and the alkali salts of these acids (soaps) :

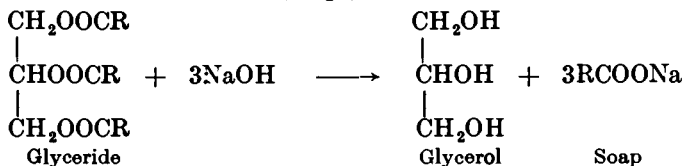

The free acids are obtained upon acidification. Fats usually consist of mixtures of glycerides. The term wax is usually applied to esters of fatty acids with other alcohols such as cetyl alcohol $\text{CH}_3(\text{CH}_2)_{14}\text{CH}_2\text{OH}$ and oleyl alcohol $\text{CH}_3(\text{CH}_2)_7\text{CH}=\text{CH}(\text{CH}_2)_7\text{CH}_2\text{OH}$.

The cleansing action of soap (sodium or potassium salts of the above-mentioned fatty acids) is connected with the colloidal properties in aqueous solution of the anions of high molecular weight. Such colloidal solutions possess the property of causing other substances (grease, oil and "dirt") to form emulsions. Another group of substances possessing excellent detergent and lathering properties consists of the sulphates of long chain alcohols, $\text{CH}_3(\text{CH}_2)_n\text{OSO}_2\text{Na}$ {common values of n include 11 (lauryl), 15 (cetyl) and 17 (stearyl)}; these alcohols are obtained by the catalytic hydrogenation of the esters of the corresponding acids or of the glycerides themselves. These detergents, marketed under the trade names of *Gardinol*, *Pentrone*, *Dreft*, *Drene*, etc., possess certain advantages over soap, e.g., they are not affected by dilute acid solutions nor by the presence of alkaline earth salts (i.e., they do not give precipitates with hard water since their calcium and magnesium salts are comparatively soluble).

Some vegetable or fatty oils (e.g., linseed, tung and oiticica oils) when exposed to air in thin layers absorb oxygen and are converted into hard but elastic solids. This change is spoken of as **drying**. **Drying oils** contain a large proportion of the glycerides of oleic ($\text{CH}_3(\text{CH}_2)_7\text{CH}=\text{CH}(\text{CH}_2)_7\text{COOH}$ or $\text{C}_{18}\text{H}_{34}\text{O}_2$), linoleic ($\text{C}_{18}\text{H}_{32}\text{O}_2$ —two ethylenic linkages), linolenic ($\text{C}_{18}\text{H}_{30}\text{O}_2$ —three ethylenic linkages) and other unsaturated acids. The reactions involved in the drying of oil films are not completely understood, but oxygen is probably absorbed at the ethylenic linkages and some form of polymerisation results. Linseed oil (obtained from flax seed) is widely used, but the fresh or raw linseed oil dries slowly; the change takes place more rapidly if the oil is previously heated to about $150\text{--}200^\circ$ and mixed with a small amount of certain metallic catalysts, for example, the cobalt, manganese and lead salts of linoleic, oleic and naphthenic acids, known as **driers**. The product is known as "boiled linseed oil." Oil paints are merely suspensions of finely divided pigments (white lead, red lead, lithopone, etc.) in boiled linseed or some other drying oil: a solvent, such as turpentine, is usually added to facilitate the application to surfaces. Varnishes consist of natural or synthetic resins dissolved in a volatile solvent; in oil varnishes, a drying oil is added to increase the elasticity and durability of the film. Synthetic drying oils are now available.

III,135. SAPONIFICATION OF A FAT. SOAP

Place 5 g. of lard (or any fat or fatty oil), 3 g. of potassium hydroxide and 40 ml. of alcohol in a 250 ml. round-bottomed flask, attach a reflux condenser, and boil for about 30 minutes. The reaction is complete when no globules of oil are present when a few drops of the mixture are mixed with a little water. Distil the reaction mixture (Fig. II, 13, 3) and recover the alcohol; dissolve the residue in 75 ml. of hot water. Carry out the following experiments with the resulting solution:—

(i) To 25 ml. of the solution add slowly and with stirring a saturated solution of sodium chloride. Filter off the precipitate of soap and wash it with a little saturated sodium chloride solution, and spread it on a watch glass to dry. Test a portion of the product for its lathering properties by rubbing it with water between the hands. Use another portion to determine whether it is soluble in water.

(ii) Mix 10 ml. of the solution with an equal volume of tap water, shake well and observe the result.

(iii) Acidify 20 ml. of the solution with dilute sulphuric acid, filter off the insoluble organic product (set the filtrate aside), wash it with water and perform the following test-tube experiments with it :—

- (a) Test its solubility in water and compare the result with that in (i).
- (b) Shake vigorously with a little sodium hydroxide solution. Determine whether the resulting solution possesses lathering properties.
- (c) Dissolve a small portion in 2–3 ml. of carbon tetrachloride and add a few drops of a solution of bromine in carbon tetrachloride. Observe the bromine is decolourised, thus indicating the presence of an unsaturated acid.

(iv) Acidify the remainder of the solution with dilute sulphuric acid, cool, filter and wash with a little water. Combine the filtrate with that from (iii), just neutralise it with sodium carbonate solution and evaporate to dryness on a water bath in a large evaporating dish. Extract the residue with 15 ml. of absolute alcohol, and filter the alcoholic solution. Evaporate the alcoholic extract on a water bath : the viscous residue consists of crude glycerol. It may be identified by conversion into the tribenzoate (see Section III,136,1).

Drying oils. Place 3 ml. of linseed oil in a test-tube, add about 0.1 g. of litharge and boil the mixture gently for 10 minutes. When cold, pour a little of the product on a watch glass and spread the oil into a thin film with the aid of a small piece of paper. Pour a little of the untreated linseed oil on another watch glass and spread it out as a thin film. Compare the times taken for the films to become dry.

III,136. REACTIONS AND CHARACTERISATION OF POLYHYDRIC ALCOHOLS

Some characteristic reactions of polyhydric alcohols are given below :

(i) They are colourless viscid liquids (or crystalline solids) freely soluble in water, but insoluble in anhydrous ether.

(ii) Upon heating with a little potassium hydrogen sulphate, they may yield aldehydes (*e.g.*, ethylene glycol yields acetaldehyde ; glycerol gives the irritating odour of acrolein, $\text{CH}_2=\text{CHCHO}$), which can be identified with Schiff's reagent and with dimedone (Section III,70,2).

(iii) Upon adding a few drops of phenolphthalein to a 1 per cent. solution of borax, a pink colouration is produced : the addition of a polyhydric alcohol causes the pink colour to disappear, but it reappears on warming and vanishes again upon cooling.

This reaction is due to the combination of two *cis* hydroxyl groups of the compound with the boric acid to form a much stronger monobasic acid :

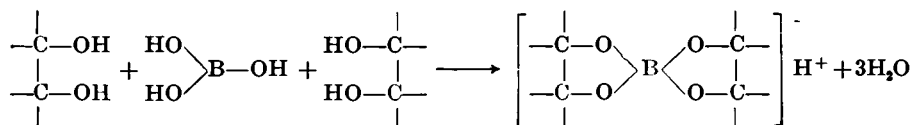

(iv) **Periodic acid test.** Periodic acid has a selective oxidising action upon 1 : 2-glycols and upon α -hydroxy aldehydes and ketones (*Malaprade reaction*) :

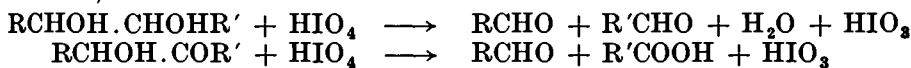

Add 1 drop (0.05 ml.) of concentrated nitric acid to 2.0 ml. of a 0.5 per cent. aqueous solution of paraperiodic acid (H_5IO_6) contained in a small test-tube and shake well. Then introduce 1 drop or a small crystal of the compound. Shake the mixture for 15 seconds and add 1-2 drops of 5 per cent. aqueous silver nitrate. The immediate production of a *white* precipitate (silver iodate) constitutes a positive test and indicates that the organic compound has been oxidised by the periodic acid. The test is based upon the fact that silver iodate is sparingly soluble in dilute nitric acid whereas silver periodate is very soluble; if too much nitric acid is present, the silver iodate will not precipitate.

An alternative procedure for the above test is as follows. Mix 2-3 ml. of 2 per cent. aqueous paraperiodic acid solution with 1 drop of dilute sulphuric acid (*ca.* 2.5*N*) and add 20-30 mg. of the compound. Shake the mixture for 5 minutes, and then pass sulphur dioxide through the solution until it acquires a pale yellow colour (to remove the excess of periodic acid and also iodic acid formed in the reaction). Add 1-2 ml. of Schiff's reagent (Section III,70) : the production of a violet colour constitutes a positive test.

CRYSTALLINE DERIVATIVES

1. **Benzoates.** The preparation of benzoates of polyhydric alcohols may be illustrated by reference to glycerol. They are usually crystalline solids.

Method 1. Place in a test-tube or small flask 1.3 g. of glycerol and 30 ml. of 10 per cent. sodium hydroxide solution; add gradually, with simultaneous shaking, 1.2 g. of benzoyl chloride. Stopper the vessel, shake for several minutes and allow to stand. Decant the solution from the pasty solid and wash the latter with cold water by decantation. Recrystallise the solid tribenzoate from dilute rectified (or methylated) spirit or from light petroleum, b.p. 40-60°; the pure compound has m.p. 76°.

Method 2. Add gradually 2.5 ml. of benzoyl chloride to a solution of 0.5 g. of glycerol in 5 ml. of pure pyridine, cooled in ice; then reflux for 1 hour. Treat the cold mixture with dilute sulphuric acid; this dissolves the pyridine salt and precipitates the glycerol tribenzoate. Wash it with sodium bicarbonate solution, followed by water, and recrystallise as in Method 1.

Derivatives of higher melting point may be obtained with *p*-nitrobenzoyl chloride; the experimental details are similar to those given above for benzoyl chloride. 3 : 5-Dinitrobenzoyl chloride (Section III,27,1) may also be used; glycerol gives unsatisfactory results with this reagent.

2. **α -Naphthyl carbamates (or α -naphthyl urethanes).** Full details are given in Section III,27,4.

The melting points of a few derivatives of selected polyhydric alcohols are collected in the following table.

TABLE III,136.

POLYHYDRIC ALCOHOLS

Alcohol	B.P.	Benzoate	<i>p</i> -Nitrobenzoate	3:5-Dinitrobenzoate	Phenylurethane	α -Naphthylurethane	Other Derivatives
2 : 3-Butanediol (1)	182°	76°	—	—	201°	—	—
1 : 2-Propanediol (2)	189	—	127°	—	153	—	—
Ethylene glycol	198	73	141	169°	157	176°	—
1 : 3-Butanediol (3)	208	—	—	—	123	—	—
1 : 3-Propanediol (4)	215	59	119	178	137	164	—
1 : 4-Butanediol (5)	230	82	175	—	183	199	—
1 : 5-Pentanediol (6)	239	—	105	—	176	147	—
Diethylene glycol (7)	244	—	—	149	—	122	—
1 : 6-Hexanediol (8)	250*	—	—	—	—	—	—
Triethylene glycol (9)	285	—	—	—	108	—	—
2-Butyne-1 : 4-diol	145°/15†	—	—	190	131	—	—
Glycerol	190d	76	188	—	180	192	—
Sorbitol	m.p. 110	129	—	—	—	—	Acetate, 99°
Mannitol	m.p. 166	149	—	—	303	—	Acetate, 121†
Pentaerythritol	m.p. 253	99	—	—	—	—	Acetate, 84

(1) 2 : 3-Butylene glycol.

(4) Trimethylene glycol.

(7) $\beta\beta'$ -Dihydroxydiethyl ether.(2) α -Propylene glycol.

(5) Tetramethylene glycol.

(8) Hexamethylene glycol.

(3) 1 : 3-Butylene glycol.

(6) Pentamethylene glycol.

(9) Ethylene glycol di-(β -hydroxyethyl) ether.

* M.p. 42°.

† M.p. 55°.

‡ The hexa-acetyl derivative, m.p. 121°, may be prepared as follows. Boil under reflux 1 part of mannitol with 5 parts by weight of acetic anhydride and 1 part of anhydrous sodium acetate or with a little anhydrous zinc chloride for 15-20 minutes, pour into excess of water, stir the mixture until the oil has solidified, and then recrystallise from methylated spirit.

CARBOHYDRATES

Carbohydrates may be divided into monosaccharides, disaccharides and polysaccharides. The monosaccharides under certain conditions react as polyhydroxy-aldehydes or polyhydroxy-ketones: two important representatives are glucose $C_6H_{12}O_6$ (an aldose) and fructose (laevulose) $C_6H_{12}O_6$ (a ketose). Upon hydrolysis di- and polysaccharides yield ultimately monosaccharides. Common disaccharides are sucrose, lactose and maltose (all of molecular formula $C_{12}H_{22}O_{11}$), whilst starch, dextrin and cellulose, $(C_6H_{10}O_5)_n$, in which $n > 4$, are typical polysaccharides.

The existence of two forms of glucose and of two isomeric methyl glucosides, as well as other experimental evidence, have led to the adoption of the ring structures (I) and (II):

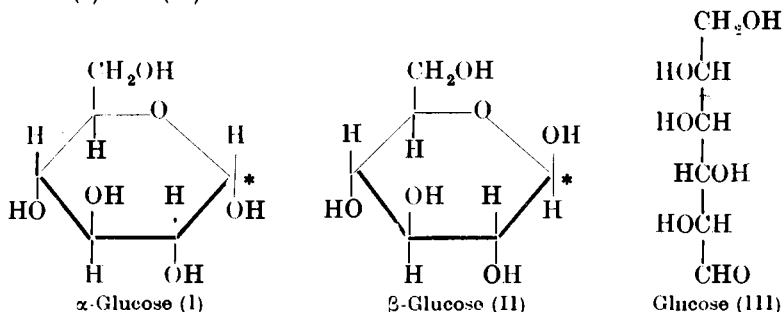

these differ only with regard to the disposition of the H and OH groups about the carbon atoms marked with an asterisk. If the ring be regarded as being in the plane of the paper, α -glucose may have this hydrogen atom above and the OH group below the plane of the paper, whilst β -glucose will have this hydrogen atom below and the OH group above the plane. Under certain conditions the ring opens and glucose reacts as an open chain compound (III). The facility with which the two isomeric forms of glucose pass into one another, in contrast to the stability of the α - and β -methyl glucosides, lends support to the view that both cyclic forms are in equilibrium with a minute amount of the open chain isomeride.

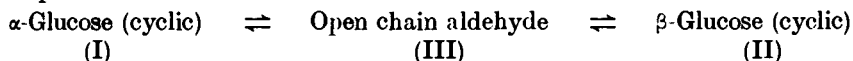

It is probable that many of the reactions of glucose in solution are due to the small amount of the open chain aldehyde present. If this reacts in a normal manner with a reagent, the equilibrium is disturbed, most of the cyclic form passes into (III) and ultimately the reaction proceeds to completion.

Fructose may be similarly formulated:

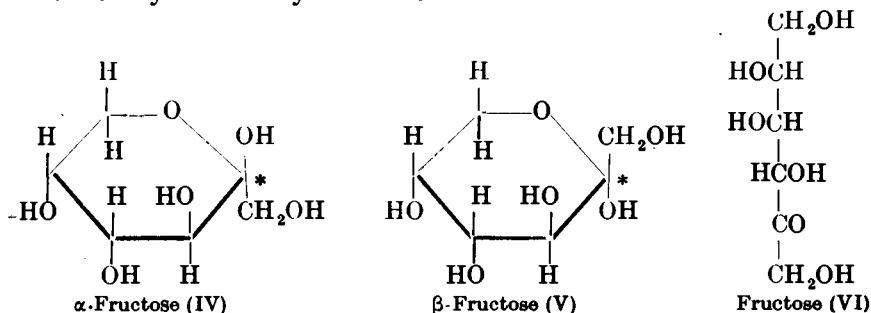

A substance, very closely related to fructose, *l*-sorbose, merits mention here as it is an intermediate in the synthesis of *l*-ascorbic acid. *d*-Glucose is converted into the alcohol sorbitol by catalytic (Cu-Cr) hydrogenation, and this upon bacterial oxidation (*Acetobacter xylinum*) gives the 2-hexose, *l*-sorbose. The latter forms a 2:3:4:6-diacetone-*l*-sorbose (condensation of acetone with two pairs of *cis* hydroxyl groups), which is oxidised by potassium permanganate to diacetone-2-keto-*l*-gulonic acid, readily hydrolysed to the free acid, 2-keto-*l*-gulonic acid. The last named upon heating with water is transformed into *l*-ascorbic acid: a better procedure consists in converting the free acid into its methyl ester and heating this with sodium methoxide in methyl alcohol, whereby the sodium salt of *l*-ascorbic acid is formed. The 2-keto-*l*-gulonic acid may be prepared more easily by oxidation of the ketose with nitric acid: preferential oxidation of the primary alcoholic group adjacent to the keto group occurs.

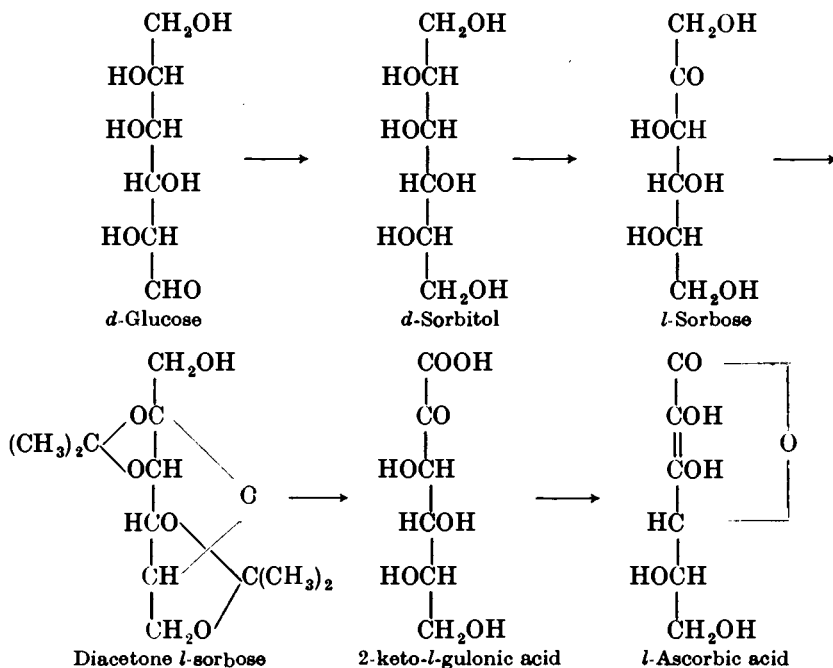

The carbohydrates containing an aldehyde or a keto group ("potential" in cyclic form) react with one molecular proportion of phenylhydrazine in the cold to form the corresponding phenylhydrazone (compare Section III, 74); these are usually soluble in water and consequently of little value for purposes of separation and identification. If, however, they are heated at 100° in the presence of excess (3-4 mols) of phenylhydrazine, the >CHOH in an aldose and the —CH₂OH group in a ketose adjacent to the phenylhydrazone group are apparently oxidised by one molecule of phenylhydrazine into a keto and aldehyde group respectively, which condense with a further molecule of phenylhydrazine to give a di-phenylhydrazone or osazone. The osazones are usually yellow, well-defined crystalline compounds and are sparingly soluble in cold water. The characteristic crystalline forms of the osazones of the commonly occurring sugars, when examined under the microscope, may be employed for their identification; the melting or decomposition points are less satisfactory since these depend to a marked degree upon the rate of heating.

reaction which ensues. Finally, heat the flask for 1 hour on a boiling water bath. Pour the contents of the flask into 125 ml. of ice water; stir the mixture and cool in ice for 30 minutes. The oil which separates out first will solidify during the stirring. Filter, wash with a little cold water, and recrystallise from methyl alcohol or from methylated spirit until the m.p. is constant; two recrystallisations generally suffice. The pure product melts at 110–111°. The yield is 3.5 g.

Note.

(1) Zinc chloride is extremely deliquescent and it must therefore be introduced into the flask as rapidly as possible. Place a small stick of zinc chloride in a glass mortar, powder rapidly, and weigh out the required quantity.

β -Glucose penta-acetate. Grind together in a dry porcelain or glass mortar 4 g. of anhydrous sodium acetate (Section II, 50, 9) and 5 g. of dry glucose and place the powdered mixture in a 200 ml. round-bottomed flask. Add 25 ml. of acetic anhydride, attach a reflux condenser and heat on a water bath until a clear solution is obtained (about 30 minutes: shake the mixture from time to time). Continue the heating for a further 2 hours. Pour the reaction mixture into 250 ml. of ice-cold water in a beaker. Break up the solid lumps and allow to stand with occasional stirring for about 1 hour. Filter the crystals at the pump, wash well with water, and recrystallise from methylated spirit (or from methyl or ethyl alcohol) until the m.p. is 131–132°; two recrystallisations are usually necessary. The yield is 7 g.

Conversion of β - into α -glucose penta-acetate. Add 0.5 g. of anhydrous zinc chloride rapidly to 25 ml. of acetic anhydride in a 200 ml. round-bottomed flask, attach a reflux condenser, and heat on a boiling water bath for 5–10 minutes to dissolve the solid. Then add 5 g. of the pure β -glucose penta-acetate, and heat on a water bath for 30 minutes. Pour the hot solution into 250 ml. of ice water, and stir vigorously in order to induce crystallisation of the oily drops. Filter the solid at the pump, wash with cold water, and recrystallise from methylated spirit or from methyl alcohol. Pure α -glucose penta-acetate, m.p. 110–111°, will be obtained. Confirm its identity by a mixed m.p. determination.

III, 138.

MUCIC ACID

Vigorous oxidation of a monosaccharide (*e.g.*, with dilute nitric acid) produces carboxyl groups at both ends of the chain. Thus galactose gives the sparingly soluble mucic acid; glucose affords the soluble saccharic acid, which is best isolated as the sparingly soluble acid potassium salt.

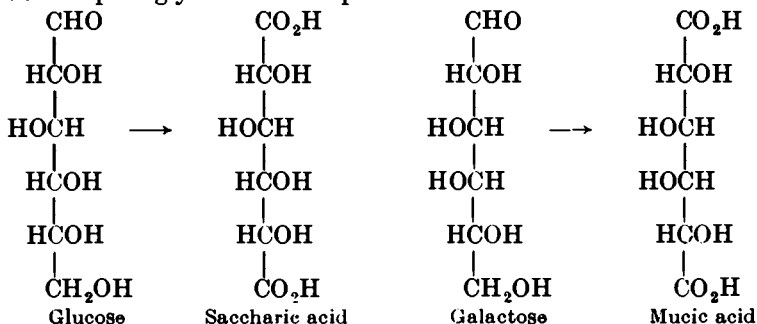

Disaccharides, *e.g.*, lactose, which yield galactose upon hydrolysis, will also give the sparingly-soluble mucic acid but in poorer yield. This reaction may be employed for the differentiation between certain disaccharides: lactose \rightarrow mucic + saccharic acids; sucrose \rightarrow saccharic acid only; maltose \rightarrow saccharic acid only.

Dissolve 10 g. of lactose (1) in 100 ml. of nitric acid, sp. gr. 1.15, in an evaporating dish and evaporate in a fume cupboard until the volume has been reduced to about 20 ml. The mixture becomes thick and pasty owing to the separation of mucic acid. When cold, dilute with 30 ml. of water, filter at the pump and set the filtrate (*A*) aside. Wash the crude acid with cold water. Purify the mucic acid by dissolving it in the minimum volume of dilute sodium hydroxide solution and reprecipitating with dilute hydrochloric acid: do not allow the temperature to rise above 25°. Dry the purified acid (about 5 g.) and determine the m.p. Mucic acid melts with decomposition at 212–213°.

Note.

(1) A much better yield is obtained if galactose is employed. Lactose is generally preferred, however, as it is much cheaper.

COGNATE PREPARATION

Saccharic acid. Use the filtrate (*A*) from the above oxidation of lactose or, alternatively, employ the product obtained by evaporating 10 g. of glucose with 100 ml. of nitric acid, sp. gr. 1.15, until a syrupy residue remains and then dissolving in 30 ml. of water. Exactly neutralise at the boiling point with a concentrated solution of potassium carbonate, acidify with acetic acid, and concentrate again to a thick syrup. Upon the addition of 50 per cent. acetic acid, acid potassium saccharate separates out. Filter at the pump and recrystallise from a small quantity of hot water to remove the attendant oxalic acid. It is necessary to isolate the saccharic acid as the acid potassium salt since the acid is very soluble in water. The purity may be confirmed by conversion into the silver salt (Section III,103) and determination of the silver content by ignition.

III,139. REACTIONS AND CHARACTERISATION OF CARBOHYDRATES

Mono- and di-saccharides are colourless solids or syrupy liquids, which are freely soluble in water, practically insoluble in ether and other organic solvents, and neutral in reaction. Polysaccharides possess similar properties, but are generally insoluble in water because of their high molecular weights. Both poly- and di-saccharides are converted into monosaccharides upon hydrolysis.

(i) **Molisch's test.** This is a general test for carbohydrates. Place 5 mg. of the substance in a test-tube containing 0.5 ml. of water and mix it with 2 drops of a 10 per cent. solution of α -naphthol in alcohol or in chloroform. Allow 1 ml. of concentrated sulphuric acid to flow down the side of the inclined tube (it is best to use a dropper pipette) so that the acid forms a layer beneath the aqueous solution without mixing with it.

If a carbohydrate is present, a red ring appears at the common surface of the liquids: the colour quickly changes on standing or shaking, a dark purple solution being formed. Shake and allow the mixture to stand for 2 minutes, then dilute with 5 ml. of water. In the presence of a carbohydrate, a dull-violet precipitate will appear immediately.

For practice, the student should apply the test to glucose, lactose, sucrose, starch and paper fibres.

(ii) **Barfoed's reagent.** This reagent may be used as a general test for monosaccharides. Heat a test-tube containing 1 ml. of the reagent and 1 ml. of a dilute solution of the carbohydrate in a beaker of boiling water. If red cuprous oxide is formed within 2 minutes, a monosaccharide is present. Disaccharides on prolonged heating (about 10 minutes) may also cause reduction, owing to partial hydrolysis to monoses.

Barfoed's reagent is prepared by dissolving 13.3 g. of crystallised neutral copper acetate in 200 ml. of 1 per cent. acetic acid solution. The reagent does not keep well.

For practice, the student should apply the test to glucose and lactose.

(iii) **Fehling's solution.** Place 5 ml. of Fehling's solution {prepared by mixing equal volumes of Fehling's solution No. 1 (copper sulphate solution) and solution No. 2 (alkaline tartrate solution—see Section III, 70, (ii)} in a test-tube and heat to gentle boiling. Add a solution of 0.1 g. of the carbohydrate in 2 ml. of water and continue to boil gently for a minute or two, and observe the result. A yellow or red precipitate of cuprous oxide indicates the presence of a reducing sugar. An alternative method of carrying out the test is to add the hot Fehling's solution dropwise to the boiling solution of the carbohydrate; in the presence of a reducing sugar the blue colour will disappear and a yellow precipitate, changing to red, thrown down.

Of the common disaccharides sucrose does not reduce Fehling's solution. If the cane sugar is hydrolysed by boiling it with dilute acid and the solution is neutralised with aqueous sodium hydroxide, the reduction of Fehling's solution occurs readily.

(iv) **Benedict's solution.** This is a modification of Fehling's solution and consists of a single test solution which does not deteriorate appreciably on standing. To 5 ml. of Benedict's solution add 0.4 ml. of a 2 per cent. solution of the carbohydrate, boil for 2 minutes and allow to cool spontaneously. If no reducing sugar is present, the solution remains clear; in the presence of a reducing sugar, the solution will contain cuprous oxide. The test may also be carried out according to the experimental details given under (iii).

Benedict's solution is prepared as follows. Dissolve 86.5 g. of crystallised sodium citrate ($2\text{Na}_3\text{C}_6\text{H}_5\text{O}_7, 11\text{H}_2\text{O}$) and 50 g. of anhydrous sodium carbonate in about 350 ml. of water. Filter, if necessary. Add a solution of 8.65 g. of crystallised copper sulphate in 50 ml. of water with constant stirring. Dilute to 500 ml. The resulting solution should be perfectly clear; if it is not, pour it through a fluted filter paper.

For practice, the student should apply tests (iii) and (iv) to glucose, lactose, maltose and sucrose.



GLUCOSAZONE

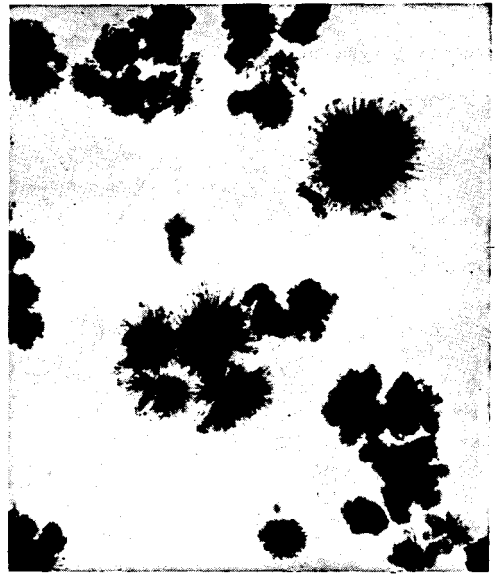

GALACTOSAZONE



ARABINOSAZONE

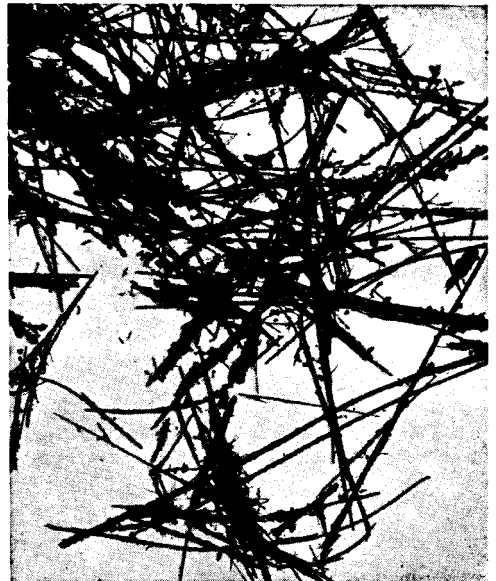

XYLOSAZONE

Fig. 111, 139, 1.

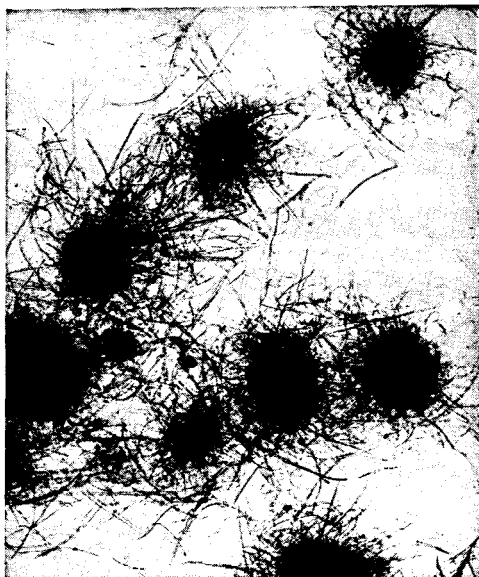

LACTOSAZONE



MALTOSAZONE



CELLOBIOSAZONE



SORBOSAZONE

Fig. 111, 139, 1.

CHARACTERISATION OF SUGARS

The melting points (more accurately termed the decomposition points) of sugars and some of their derivatives, *e.g.*, osazones, are not so definite as those of other classes or organic compounds: these vary with the rate of heating and the differences between individual members are not always large. There are, however, a number of reactions and derivatives which will assist in the characterisation of the simple sugars normally encountered by the student in his training in qualitative organic analysis.

1. Osazone formation. Certain sugars may be identified by the length of time required to form osazones upon treatment with phenylhydrazine under standard experimental conditions. Monosaccharides give precipitates at 100° within 20 minutes. The disaccharides maltose and lactose give no osazone at 100° even after 2 hours, but osazones are obtained on cooling after 10–15 minutes heating. With sucrose an osazone commences to separate after about 30 minutes, due to gradual hydrolysis into glucose and fructose, but no osazone is produced on cooling after heating for 10–15 minutes.

Place 0·20 g. of the carbohydrate, 0·40 g. of pure *white* phenylhydrazine hydrochloride (*e.g.*, of A.R. quality), 0·60 g. of crystallised sodium acetate and 4·00 ml. of water in a dry test-tube. (Weigh the quantities with an accuracy of 0·01 g.) Stopper the tube *loosely* with a cork, and stand or clamp it upright in a beaker containing boiling water. Note the time of immersion and the time when the osazone first separates. Shake the tube occasionally (without removing it from the boiling water) in order to prevent supersaturation. The precipitate separates quite suddenly: duplicate experiments should agree within 0·5 minute. Note whether the precipitate is white (mannose), yellow or orange yellow, and whether it is crystalline or “oily.”

The approximate times of osazone formation in minutes are given in Table III, 139. The product from mannose is the simple hydrazone and is practically white. Arabinose osazone separates first as an oil, whilst that from galactose is highly crystalline. Lactose and maltose give no precipitate from hot solution.

For practice, the student should prepare the osazones from glucose and fructose. He should also use the same technique for lactose and maltose, but the solution should be cooled after boiling for 10–15 minutes. The resulting osazones should be examined under the microscope: this is most simply done by withdrawing a small quantity of the crystalline suspension with a dropper pipette on to a microscope slide, and viewing under the microscope. It may be necessary to recrystallise the osazone in order to obtain the best results. The precipitate should be filtered off on a small filter paper, washed with a little cold water, and then recrystallised from hot water or from 60 per cent. alcohol or from dilute pyridine. The crystal forms should be compared with those given in Fig. III, 139, 1 (plate facing this page).^{*} The crystal forms of the osazones are more trustworthy for identification purposes than the melting points.

^{*} The photographs of the osazones were kindly supplied by Thomas Kerfoot and Co. Ltd., of Vale of Bardsey, Ashton-under-Lyne, the well-known manufacturers of sugars.

2. **Acetates.** Complete acetylation of all the hydroxyl groups is desirable in order to avoid mixtures. In some cases, the completely acetylated sugars may be obtained in the α - and β -forms depending upon the catalyst, *e.g.*, zinc chloride or sodium acetate, that is employed in the acetylation. The experimental details for acetylation may be easily adapted from those already given for α - and β -glucose penta-acetates (Section III,137).

3. ***p*-Nitrophenylhydrazones.** This reagent has been used in the characterisation of a number of monosaccharides.

Heat 0.25 g. of the compound with 3 ml. of alcohol, add 0.25 g. of *p*-nitrophenylhydrazine, and heat the suspension until the reaction appears complete. The *p*-nitrophenylhydrazone soon separates. Filter, preferably after standing overnight, wash with a little cold alcohol, and then recrystallise from alcohol.

4. **Benzoates.** Benzoyl chloride has a very limited application as a reagent in the sugar series, but it is useful for the preparation of a crystalline derivative of glucose and of fructose.

In a 50–100 ml. conical flask place a solution of 0.5 g. of glucose in 5 ml. of water, 12–15 ml. of 10 per cent. sodium hydroxide solution and 1 ml. of benzoyl chloride, cork tightly, and shake until the odour of benzoyl chloride has disappeared and a crystalline (frequently sticky) solid has separated. Filter off the solid, wash it with a little water, and recrystallise it from ethyl or *n*-butyl alcohol. (If the product is sticky, it should be removed, and spread on a porous tile before recrystallisation.) Glucose pentabenzoate has m.p. 179°. Fructose pentabenzoate, m.p. 78–79°, may be similarly prepared.

The following simple test distinguishes fructose from all other carbohydrates. Upon heating a little fructose with dilute cobalt chloride solution, cooling and treating with a little ammonia solution, a violet to purple colour is developed; the colour gradually fades and must be observed immediately after the addition of the ammonia solution. Green cobalt hydroxide is formed with all other carbohydrates.

5. **Methylphenylosazones.** *as*-Methylphenylhydrazine does not form osazones with aldoses presumably because the base or more probably the methylphenylhydrazonium ion $[C_6H_5NCH_3NH_3]^+$ will oxidise a $-CH_2OH$ but not a $>CHOH$ group: it readily forms osazones with ketoses, thus providing an excellent reagent for fructose.

Dissolve 0.2 g. of fructose in 10 ml. of water, add 0.6 g. of *as*-methylphenylhydrazine and sufficient rectified spirit to give a clear solution. Since the fructose may not be quite pure, warm the mixture slightly, allow to stand, preferably overnight, so that any insoluble hydrazones may separate; if present, remove them by filtration. Add 4 ml. of 50 per cent. acetic acid to the filtrate; it will become yellow in colour. Heat the solution on a water bath for 5–10 minutes, and allow to stand in the dark until crystallisation is complete; it may be necessary to "scratch" the walls of the vessel to induce crystallisation. Filter the crystals and wash with water, followed by a little ether. Recrystallise the orange-coloured methylphenylosazone from benzene: m.p. 152°.

The properties of a number of sugars are collected in Table III,139; the specific rotations in water are included for reference purposes.

TABLE III,139.

CARBOHYDRATES (SUGARS)

Carbohydrate	M.P.*	α_D^{20} in Water	Osazone		Other Derivatives
			M.P.	Time of Formation (Minutes)	
†D-Glucose (hydrated)	146°	90°	205°	4	Penta-acetate, α - 112°, β - 132 ; pentabenzate, 179
D-Glucose (anhydrous)		+ 52°			
D-Ribose		95			
D-Fructose	104	— 92	205	2	Penta-acetate, α - 70, β - 109 ; pentabenzate, 79
L-Rhamnose (hydrated)	125	105}	190	9	Penta-acetate, 99
L-Rhamnose (anhydrous)		+ 9			
L-Lyxose		106			
D-Galactose (hydrated)	170	120}	201	15-19	Penta-acetate, α - 95, β - 142 ; mucic acid, 213
D-Galactose (anhydrous)		+ 82			
D-Mannose		132			
D-Xylose	145	+ 19	164	7	Penta-acetate, α - 74, β - 115
L-Arabinose	160	+105	166	9	Penta-acetate, α - 59, β - 126
L-Sorbose	161	— 43	162	4	Penta-acetate, α - 94, β - 86
Maltose (hydrated)	165	100}	206	—	Octa-acetate, α - 125, β - 160
Maltose (anhydrous)		+130			
Sucrose		185			
Gentiobiose	190	+ 9·5	162	—	Octa-acetate, α - 189, β - 193
Lactose (hydrated)	223	203}	200	—	Octa-acetate, α - 152, β - 90 ; mucic acid, 213
Lactose (anhydrous)		+ 52·5			
Cellobiose		225			

* The melting points of carbohydrates (sugars) are not usually sharp and they are perhaps best expressed as decomposition points.

† The small capital letter prefix refers to configuration, related to D-glyceraldehyde, and not to the direction of optical rotation. The sign of optical rotation is expressed as (+) and (—) or as *d* and *l* or by the words *dextro* and *laevo*. Thus we have D-(—)-fructose and L-(+)-arabinose.

Notes on the Identification of Polysaccharides

Most polysaccharides are insoluble or sparingly soluble in cold water, insoluble in cold alcohol and ether, and rarely possess melting points. Only inulin melts at about 178° (dec.) after drying at 130°.

Starch. A few centigrams rubbed to a thin cream with cold water and then gradually stirred into 100 ml. of boiling water dissolve to give a nearly clear solution. This gives a deep blue colouration with a dilute solution of iodine in potassium iodide solution, temporarily decolourised by heat or by traces of free alkali, but restored on cooling or upon acidifying. It is hydrolysed by boiling with dilute hydrochloric acid to give products (largely glucose) which reduce Fehling's solution.

Cellulose. This is insoluble in water, hot and cold. It dissolves in a solution of Schweitzer's reagent (precipitated cupric hydroxide is washed free from salts and then dissolved in concentrated ammonia solution), from which it is precipitated by the addition of dilute acids. Cellulose is not hydrolysed by dilute hydrochloric acid.

Inulin. This polysaccharide melts with decomposition at about 178°. It is insoluble in cold but dissolves readily in hot water giving a clear solution which tends to remain supersaturated. It does not reduce Fehling's solution. Inulin gives no colouration with iodine solution.

Glycogen. It dissolves easily in water to an intensely opalescent solution; the opalescence is not destroyed by filtration, but is removed by the addition of acetic acid. Glycogen gives a wine colouration with iodine solution; the colouration disappears on heating and reappears on cooling. The compound does not reduce Fehling's solution: upon boiling with dilute acid glucose is produced and the resulting solution, when neutralised, therefore reduces Fehling's solution.

UNSATURATED ALIPHATIC COMPOUNDS

III,140.

ALLYL ALCOHOL

Allyl alcohol may be prepared by heating glycerol with formic acid :

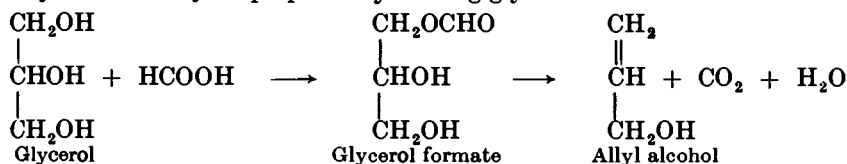

Large quantities are prepared commercially from propylene :

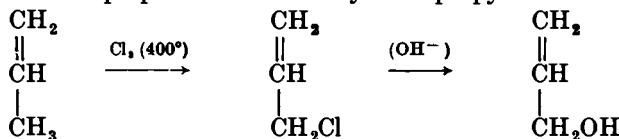

To a 1-litre distilling flask, provided with a thermometer reaching to within 1-2 cm. of the bottom, attach a condenser set for downward distillation : fit a 500 ml. distilling flask to the lower end of the condenser by means of a cork and connect the side arm of the distilling flask to a wash bottle containing concentrated sodium hydroxide solution to dissolve and decompose any acrolein formed in the subsequent reaction. Place 400 g. of glycerol, 175 g. (146 ml.) of commercial 85 per cent. formic acid and a few fragments of porous porcelain in the distilling flask. Heat the mixture *rapidly* over a burner. Carbon dioxide is evolved and a liquid distils. When the temperature reaches 195° (after 30-45 minutes), change the receiver for another distilling flask of equal size. Continue the heating until the temperature rises to 260° : the main reaction occurs at 225-235° and about 190 ml. of distillate are obtained. Allow the contents of the flask to cool to about 115°, and introduce a further 125 g. (105 ml.) of commercial 85 per cent. formic acid. Heat the flask rapidly as before and collect the fraction distilling at 195-260° (about 125 ml.). Allow the reaction mixture to cool again to about 115°, add a third portion of 125 g. (105 ml.) of formic acid, and repeat the distillation : about 90 ml. passes over at 195-260° and the residue in the flask is about 50 ml.

Treat the combined distillates of b.p. 195-260° with anhydrous potassium carbonate to neutralise the little formic acid present and to salt out the allyl alcohol. Distil the latter through a fractionating column and collect the fraction of b.p. up to 99° separately ; this weighs 210 g. and consists of 70 per cent. allyl alcohol. To obtain anhydrous allyl alcohol, use either of the following procedures :—

(i) Reflux the alcohol with successive quantities of anhydrous potassium carbonate * until the carbonate no longer becomes sticky but remains finely-divided and “flows” freely. Decant from the desiccant and distil. Allyl alcohol of 98-99 per cent. purity passes over at 94-97°. Considerable quantities of the alcohol are lost mechanically in the drying process.

* Anhydrous calcium sulphate may also be used, but the process is unnecessarily expensive.

of 100 g. of potassium hypochlorite in 750 ml. of water (1) in the flask, and stir the mixture. Heat is evolved in the reaction and after about 5 minutes chloroform commences to reflux. As soon as the reaction becomes very vigorous, stop the stirrer and cool the flask with the water from the reflux condenser so that the chloroform refluxes gently; after 20-30 minutes, when the reaction has subsided, resume the stirring and continue it until the temperature of the mixture has fallen to that of the laboratory (2-3 hours). Decompose the slight excess of hypochlorite by the addition of sodium bisulphite (about 1 g.), *i.e.*, until a test-portion no longer liberates iodine from potassium iodide solution.

Replace one of the reflux condensers by a dropping funnel and add 50 per cent. sulphuric acid (about 50 ml.) with stirring and cooling until the solution is acid to Congo red paper. Extract the cold solution with eight 50 ml. portions of ether (2) and shake the mixture well during each extraction. Dry the combined ethereal extracts with a little anhydrous magnesium or calcium sulphate, and remove the ether and chloroform slowly on a water bath. Distil the residue from a Claisen flask with fractionating side arm (Figs. II, 24, 2-4) under diminished pressure and collect the acid at 100-106°/20 mm.; this fraction solidifies on cooling and melts at 60-65°. The yield is 13 g. Recrystallise from hot water (1 g. of acid in 10 ml. of water), cool the solution in ice for 2-3 hours, filter and dry overnight in a vacuum desiccator. Alternatively, recrystallise from light petroleum, b.p. 60-80°. Pure $\beta\beta$ -dimethylacrylic acid has m.p. 68°.

Notes.

(1) The potassium hypochlorite solution may be prepared from the calcium hypochlorite marketed under the name "High Test Hypochlorite" or "H.T.H."* and containing not less than 65 per cent. of available calcium hypochlorite. Dissolve 125 g. of "H.T.H." in 500 ml. of warm water contained in a 1.5 litre round-bottomed flask, and add a warm solution of 87.5 g. of potassium carbonate and 25 g. of potassium hydroxide in 250 ml. of water. Stopper the flask and shake vigorously until the semi-solid gel first formed becomes fluid. Filter on a large Buchner funnel, wash with 100 ml. of water, and suck as dry as possible. The filtrate (about 750 ml.) contains about 100 g. of potassium hypochlorite. Alternatively, but less satisfactorily, fresh bleaching powder (*ca.* 35 per cent. calcium hypochlorite) may be used. The potassium hypochlorite solution is prepared by treating a warm (50°) solution of bleaching powder (in proportion of 100 g. in 400 ml. of water) with a warm solution of potassium carbonate and a little potassium hydroxide (70 g. K_2CO_3 + 20 g. KOH in 300 ml. of water), stirring vigorously and filtering.

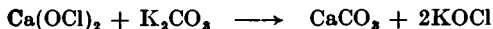

(2) A continuous ether extractor (see Figs. II, 44, 1-2) gives more satisfactory results.

III,143. MALEIC AND FUMARIC ACIDS

Maleic acid may be prepared by warming malic acid with acetyl chloride, distilling the mixture under atmospheric pressure to isolate maleic anhydride, and hydrolysing the latter by boiling with water.

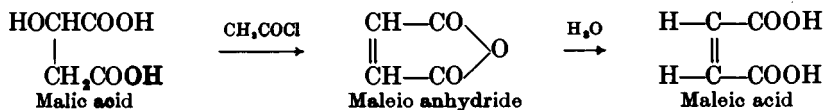

* Supplied by the Matheson Alkali Works, U.S.A.

Commercially, maleic anhydride is prepared more cheaply by the catalytic vapour phase oxidation (in the presence of vanadium pentoxide at about 400°) of benzene with atmospheric oxygen :

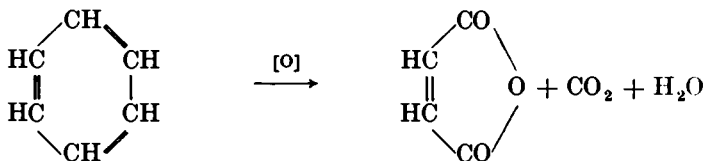

Upon heating with hydrochloric acid, maleic acid, m.p. 144°, is converted into fumaric acid, m.p. 287° :

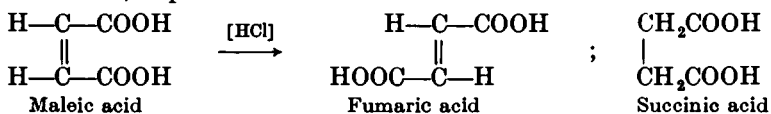

Both acids yield succinic acid, m.p. 185°, upon catalytic reduction (see Section III,150), thus establishing their structures. Maleic and fumaric acids are examples of compounds exhibiting *cis-trans* isomerism (or *geometric isomerism*). Maleic acid has the *cis* structure since *inter alia* it readily yields the anhydride (compare Section III,93). Fumaric acid possesses the *trans* structure; it does not form an anhydride, but when heated to a high temperature gives maleic anhydride.

Fumaric acid is conveniently prepared by the oxidation of the inexpensive furfural with sodium chlorate in the presence of a vanadium pentoxide catalyst :

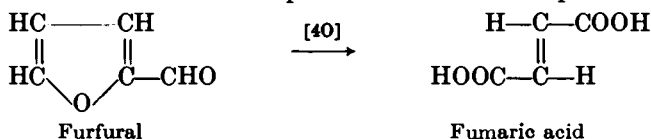

A. Maleic acid. Assemble the apparatus shown in Fig. III, 28, 1. Place 45 g. of dry maleic acid in the 200–250 ml. distilling flask and cautiously add 63 g. (57 ml.) of pure acetyl chloride. Warm the flask gently on a water bath to start the reaction, which then proceeds exothermically. Hydrogen chloride is evolved and the maleic acid passes into solution. When the evolution of gas subsides, heat the flask on a water bath for 1–2 hours. Rearrange the apparatus and distil. A fraction of low boiling point passes over first and the temperature rises rapidly to 190°; at this point run out the water from the condenser. Continue the distillation and collect the maleic anhydride at 195–200°. Recrystallise the crude maleic anhydride from chloroform (compare Section III,93); 22 g. of pure maleic anhydride, m.p. 54°, are obtained.

To obtain maleic acid, evaporate the maleic anhydride with one half of its weight of water on a water bath: remove the last traces of water by leaving in a desiccator over concentrated sulphuric acid. The resulting maleic acid has m.p. 143° and is quite pure (1). It may be recrystallised, if desired, from acetone–light petroleum (b.p. 60–80°) and then melts at 144° (1).

Note.

(1) The melting point of pure maleic acid depends to a marked degree upon the rate of heating, and values between 133° and 143–144° may be observed. Slow heating (about 20 minutes) gives a value of 133–134°; with more rapid heating

(about 10 minutes), the m.p. is 139–140°. If the acid is immersed in a bath at 140° or is placed upon the electric m.p. apparatus (Fig. II, 11, 4) at 140°, it melts sharply at 143°. The low melting points obtained by slow heating are evidently due to the formation of maleic anhydride and/or fumaric acid, which depress the m.p.

B. Conversion of maleic acid into fumaric acid. Dissolve 10 g. of maleic acid in 10 ml. of warm water, add 20 ml. of concentrated hydrochloric acid and reflux gently (provide the flask with a reflux condenser) for 30 minutes. Crystals of fumaric acid soon crystallise out from the hot solution. Allow to cool, filter off the fumaric acid, and recrystallise it from hot *N*-hydrochloric acid. The m.p. in a sealed capillary tube is 286–287°.

C. Fumaric acid from furfural. Place in a 1-litre three-necked flask, fitted with a reflux condenser, a mechanical stirrer and a thermometer, 112.5 g. of sodium chlorate, 250 ml. of water and 0.5 g. of vanadium pentoxide catalyst (1). Set the stirrer in motion, heat the flask on an asbestos-centred wire gauze to 70–75°, and add 4 ml. of 50 g. (43 ml.) of technical furfural. As soon as the vigorous reaction commences (2) *but not before*, add the remainder of the furfural through a dropping funnel, inserted into the top of the condenser by means of a grooved cork, at such a rate that the vigorous reaction is maintained (25–30 minutes). Then heat the reaction mixture at 70–75° for 5–6 hours (3) and allow to stand overnight at the laboratory temperature. Filter the crystalline fumaric acid with suction, and wash it with a little cold water (4). Recrystallise the crude fumaric acid from about 300 ml. of *N*-hydrochloric acid, and dry the crystals (26 g.) at 100°. The m.p. in a sealed capillary tube is 282–284°. A further recrystallisation raises the m.p. to 286–287°.

Notes.

(1) The vanadium pentoxide catalyst is prepared as follows: Suspend 5 g. of pure ammonium vanadate in 50 ml. of water and add slowly 7.5 ml. of pure concentrated hydrochloric acid. Allow the reddish-brown, semi-colloidal precipitate to settle (preferably overnight), decant the supernatant solution, and wash the precipitate several times by decantation. Finally, suspend the precipitate in 75 ml. of water and allow it to stand for 3 days. This treatment renders the precipitate granular and easy to filter. Filter the precipitate with suction, wash it several times with cold 5 per cent. sodium chloride solution to remove hydrochloric acid. Dry the product at 120° for 12 hours, grind it in a mortar to a fine powder, and heat again at 120° for 12 hours. The yield of catalyst is about 3.5 g.

(2) When the vigorous reaction commences, the temperature rises to about 105° and remains at this temperature for some time. The main quantity of furfural should not be added until the vigorous reaction has started: if this precaution is ignored, an explosion may result.

(3) A water bath may be used for this purpose.

(4) A small quantity (*ca.* 3 g.) of fumaric acid may be recovered from the filtrate by heating it on a water bath with 15 ml. of concentrated hydrochloric acid, evaporating to about 150 ml., and then cooling with running water. The fumaric acid which separates is recrystallised from *N*-hydrochloric acid.

III,144. CROTONIC ACID AND VINYLACETIC ACID

Crotonic acid may be prepared by condensing acetaldehyde with malonic acid in pyridine solution in the presence of a trace of piperidine (Doebner reaction; see discussion following Section IV,123).

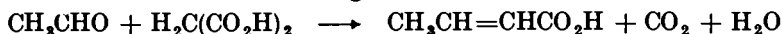

The commercial method consists in the oxidation of crotonaldehyde, which is itself prepared from acetaldehyde (see Section III,141) :

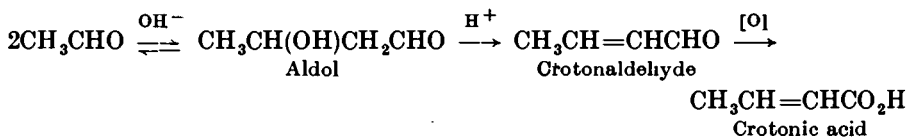

Vinylacetic acid is obtained by the hydrolysis of allyl cyanide with concentrated hydrochloric acid :

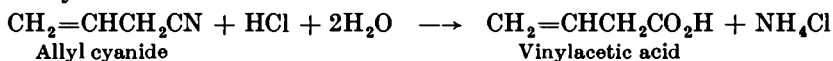

Crotonic acid exists in *cis* and *trans* forms (compare maleic and fumaric acids) :

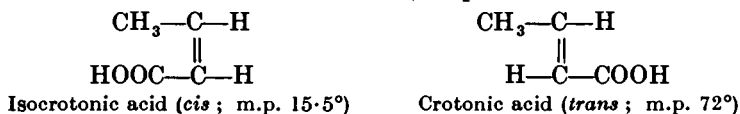

The acid prepared as above is the *trans* isomer ; isocrotonic acid is produced by special methods.

Crotonic acid is an example of an $\alpha\beta$ -unsaturated acid, whilst vinylacetic acid is a $\beta\gamma$ -unsaturated acid. Upon heating the latter with a solution of an alkali hydroxide at 100° or with sulphuric acid, it passes almost completely into the former. Actually an equilibrium mixture is produced containing 98 per cent. of crotonic acid :

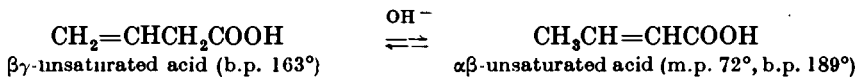

A.

Crotonic Acid

Mix together in a 250 ml. flask carrying a reflux condenser and a calcium chloride drying tube 25 g. (32 ml.) of freshly-distilled acetaldehyde with a solution of 59·5 g. of dry, powdered malonic acid (Section III,157) in 67 g. (68·5 ml.) of dry pyridine to which 0·5 ml. of piperidine has been added. Leave in an ice chest or refrigerator for 24 hours. Warm the mixture on a steam bath until the evolution of carbon dioxide ceases. Cool in ice, add 60 ml. of 1 : 1 sulphuric acid (by volume) and leave in the ice bath for 3–4 hours. Collect the crude crotonic acid (*ca.* 27 g.) which has separated by suction filtration. Extract the mother liquor with three 25 ml. portions of ether, dry the ethereal extract, and evaporate the ether ; the residual crude acid weighs 6 g. Recrystallise from light petroleum, b.p. 60–80° ; the yield of crude crotonic acid, m.p. 72°, is 20 g.

B.

Vinylacetic Acid

Allyl cyanide. Into a 1·5 litre three-necked flask (1), provided with a mercury-sealed stirrer and two long double surface condensers, place 293 g. (210 ml.) of freshly-distilled allyl bromide, b.p. 70–71° (Section III, 35) and 226 g. of dry cuprous cyanide (Section II,50,3, Method 1). Remove the mercury-sealed stirrer and replace it by a tightly fitting

Dissolve 57 g. of dry malonic acid in 92.5 ml. of dry pyridine contained in a 500 ml. round-bottomed flask, cool the solution in ice, and add 57 g. (70 ml.) of freshly-distilled *n*-heptaldehyde (oenanthol) with stirring or vigorous shaking. After a part of the aldehyde has been added, the mixture rapidly sets to a mass of crystals. Insert a cotton wool (or calcium chloride) tube into the mouth of the flask and allow the mixture to stand at room temperature for 60 hours with frequent shaking. Finally, warm the mixture on a water bath until the evolution of carbon dioxide ceases (about 8 hours) and then pour into an equal volume of water. Separate the oily layer and shake it with 150 ml. of 25 per cent hydrochloric acid to remove pyridine. Dissolve the product in benzene, wash with water, dry with anhydrous magnesium sulphate, and distil under reduced pressure. Collect the $\alpha\beta$ -nonenoic acid at 130–132°/2 mm. The yield is 62 g.

III,145. SORBIC ACID

Sorbic acid is prepared by the condensation of crotonaldehyde with malonic acid in the presence of pyridine at 100° (Doebner reaction):

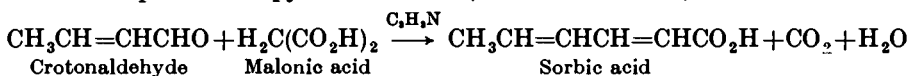

It contains a conjugated system of double bonds.

Place 40 g. (46.5 ml.) of crotonaldehyde (b.p. 101–103°), 60 g. of dry malonic acid (Section III,157) and 60 g. (61 ml.) of dry pyridine (b.p. 113–115°) in a 500 ml. round-bottomed flask, attach a reflux condenser, and heat on a water bath for 3 hours. At the end of this period the vigorous evolution of carbon dioxide will have ceased. Cool the mixture in ice and cautiously acidify it by the addition of a solution of 21.3 ml. of concentrated sulphuric acid in 50 ml. of water with shaking. Most of the sorbic acid separates out immediately; a more complete separation is obtained by cooling the solution in ice for 3–4 hours. Filter the acid at the pump and wash it with 5 ml. of ice-cold water. Recrystallise from about 125 ml. of boiling water; the maximum recovery of purified acid is achieved by leaving the solution in an ice chest or a refrigerator overnight and then filtering. The yield of sorbic acid, m.p. 134°, is 20 g.

III,146. DIALLYL (HEXADIENE-1,5)

This unsaturated hydrocarbon is easily prepared by the action of sodium upon allyl iodide or bromide:

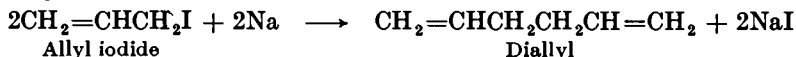

Place 56 g. of clean sodium, cut into small pieces, in a 500 ml. round-bottomed flask fitted with two 25 or 30 cm. double surface condensers in series. Weigh out 136 g. (72 ml.) of freshly distilled allyl iodide, b.p. 99–101° (Section III,39). Introduce about one quarter of the allyl iodide through the condensers. Warm the flask gently until the sodium commences to melt and immediately remove the flame. A vigorous reaction sets in and a liquid refluxes in the condensers. Add

the remainder of the allyl iodide in small portions over a period of 2 hours. Allow the mixture to cool during 3 hours and arrange the flask for distillation (compare Fig. II, 13, 3). Distil from an oil or butyl phthalate bath maintained at 90–100° when most of the hydrocarbon will pass over; finally raise the temperature of the bath to 150° in order to recover the product as completely as possible. The distillate weighs 26 g. and is almost pure diallyl. Redistil from a 50 ml. Claisen flask with fractionating side arm and containing a little sodium; all the liquid boils at 59–60°.

III,147. 2 : 3-DIMETHYL-1 : 3-BUTADIENE

Anhydrous pinacol (I) is catalytically decomposed by aqueous hydrobromic acid into dimethylbutadiene (II) and pinacolone (III); separation is effected by distillation through an efficient fractionating column :

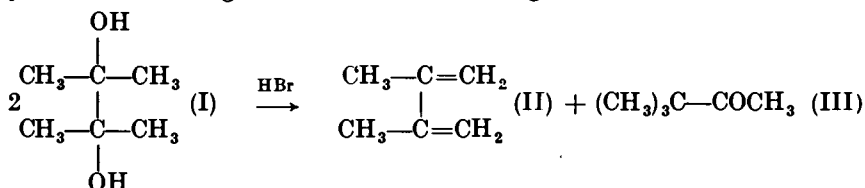

In a 1-litre round-bottomed flask, surmounted by a modified Hempel fractionating column (Fig. II, 15, 5) filled with $\frac{1}{8}$ " or $\frac{1}{4}$ " glass or porcelain rings (1), place 177 g. of anhydrous pinacol (Section III,77), 5 ml. of constant boiling point hydrobromic acid, and a few fragments of porous porcelain. Attach a condenser and a receiver to the column. Heat the flask gently in an air bath (compare Fig. II, 5, 3) and circulate cold water through the "cold finger": the rate of distillation should be 20–30 drops per minute. Collect the distillate until the temperature at the top of the column is 95° (60–70 minutes). Separate the upper non-aqueous layer, wash it twice with 50 ml. portions of water, add 0.25 g. of hydroquinone as an inhibitor, and dry it overnight with 7–8 g. of anhydrous calcium chloride. Transfer to a 500 ml. flask and distil through the same column (or through a Widmer column). Collect the following fractions: (a) 69–70.5° (70 g.), (b) 70.5–105° (7 g.), and (c) 105–106° (35 g.). Fraction (a) is pure dimethylbutadiene, (b) is an intermediate fraction and (c) is pinacolone.

Dimethylbutadiene may be kept for a limited period in an ice box or in a refrigerator; it is advisable to add about 0.2 g. of hydroquinone as an inhibitor.

Note.

(1) Any efficient fractionating column may be used (see Section II, 17).

III,148. DIMETHYLETHYNYL CARBINOL

This is an example of an acetylenic alcohol. It is prepared from acetone by the following series of reactions :

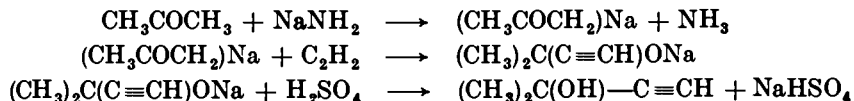

Fit a 1-litre round-bottomed flask with a three-holed stopper carrying a separatory funnel, a mechanical stirrer and a gas outlet tube leading to a fume cupboard. Place 500 ml. of anhydrous ether and 78 g. of finely-ground sodamide (Section II,50,8) in the flask and surround it with a freezing mixture of ice and salt. Stir the mixture vigorously and add 116 g. (147 ml.) of dry acetone (1) dropwise during a period of 1.5-2 hours. Pass a slow current of acetylene (from a cylinder and dried with anhydrous calcium chloride) through the flask for 2 hours in order to sweep out the ammonia; make sure that the temperature of the freezing mixture does not rise above -10° , and add Dry Ice (solid carbon dioxide) if necessary. Replace the three-holed stopper by one with two holes bearing an inlet tube reaching to the bottom of the flask (connected to a cylinder of acetylene) and a stopcock. Wire the two-holed stopper securely into the mouth of the flask. Place the flask in an ice-salt mixture and mount the whole in a shaking machine (compare Figs. II, 7, 14) and shake vigorously for 10 hours (2); maintain the mixture under a pressure of 10 lb. of acetylene as indicated by the gauge on the cylinder. Release the pressure every half hour by means of the stopcock in order to sweep out any ammonia formed from small amounts of previously unreacted sodamide.

Pour the reaction mixture cautiously into 400 g. of crushed ice and acidify it in the cold by the addition of a solution prepared by adding 55 ml. of concentrated sulphuric acid to 150 ml. of water and then cooling to 0° . Separate the ether layer and extract the aqueous layer twice with 50 ml. portions of ether. Dry the combined ethereal solutions over 50 g. of anhydrous potassium carbonate and distil the filtered solution through a Widmer column (Figs. II, 17, 1 and II, 24, 4). Collect separately the fraction boiling up to 103° , and the dimethylethynyl carbinol at $103-107^{\circ}$. Discard the high boiling point material. Dry the fraction of low boiling point with anhydrous potassium carbonate and redistil. The total yield is 75 g.

Notes.

(1) The acetone should be dried over anhydrous potassium carbonate or anhydrous calcium sulphate.

(2) The shaking period need not be continuous. The passage of acetylene may be interrupted, but the cold reaction mixture must be kept in an ice box during the intervening period.

COGNATE PREPARATION

Methylethylethynyl carbinol. Use 144 g. (179 ml.) of dry methyl ethyl ketone, and other quantities as above. The yield is 60 g., b.p. $119-123^{\circ}$.

III,149.

10-UNDECYNOIC ACID

Undecylenic acid (or 10-undecenoic acid) (I), a comparatively inexpensive commercial product obtained from castor oil, reacts with bromine in dry carbon tetrachloride to give 10:11-dibromoundecioic acid (II), which upon heating with a concentrated solution of potassium hydroxide yields 10-undecynoic acid (III):

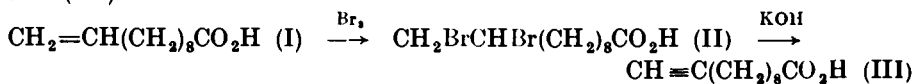

The position of the triple bond is established by oxidation of the latter by means of alkaline potassium permanganate solution to sebacic acid, $\text{HO}_2\text{C}(\text{CH}_2)_8\text{CO}_2\text{H}$, m.p. 133° .

Purify commercial undecylenic acid by distillation of, say, 250 g. under diminished pressure and collect the fraction, b.p. $152\text{--}154^\circ/6$ mm.; this has a freezing point of 23° . Dissolve 108 g. of the purified undecylenic acid in 285 ml. of dry carbon tetrachloride (1) in a 1-litre three-necked flask provided with a mercury-sealed stirrer, a dropping funnel and a reflux condenser. Cool the flask in a freezing mixture of ice and salt, stir the solution and add 96 g. (31 ml.) of dry bromine (Section II, 49, 8) during a period of 1 hour; allow the mixture to gradually warm up to the temperature of the laboratory. Arrange the flask for distillation (compare Fig. II, 41, 1, but with stirrer in central neck), remove the carbon tetrachloride by heating on a water bath, and pour the residue into a large evaporating dish. Upon standing 1-2 days (more rapidly when left in a vacuum desiccator over silica gel), the dibromo acid crystallises completely. The yield is quantitative.

Transfer the solid dibromo acid to a 2-litre round-bottomed Pyrex flask attached to a reflux condenser, add a solution of 263 g. of potassium hydroxide in 158 ml. of water, and heat in an oil bath at $150\text{--}160^\circ$ for 8 hours. Considerable frothing occurs, but this is reduced by the addition of small quantities (about 0.1 g.) of solid "Pentron-T" (largely sodium oleyl sulphonate) from time to time. Allow the mixture to stand overnight, add 1500 ml. of water, shake until all the solid dissolves, and acidify with dilute sulphuric acid to Congo red. A solid cake of acid separates on the surface of the liquid after standing for several hours. Extract with four 250 ml. portions of ether, dry with anhydrous sodium or magnesium sulphate, and remove the ether on a water bath. Transfer the residue to a 250 ml. Claisen flask and distil cautiously under diminished pressure using a free flame. A little ether and water pass over first and the temperature rises rapidly to $175^\circ/15$ min. Collect separately the fractions (a) b.p. $177\text{--}182^\circ/15$ mm. (52 g.) and (b) $182\text{--}200^\circ/15$ mm. (15 g.). The flask contains a large residue, which is discarded. Fraction (a) solidifies completely on cooling and has m.p. $37\text{--}41^\circ$; upon recrystallisation from light petroleum, b.p. $60\text{--}80^\circ$, 34 g. of pure 10-undecynoic acid, m.p. $41\text{--}42^\circ$, are obtained. Fraction (b) solidifies to a slightly "sticky" solid; upon recrystallisation from light petroleum, b.p. $60\text{--}80^\circ$, a "sticky" solid separates, which, after spreading upon a porous tile, becomes colourless and has m.p. $41\text{--}42^\circ$ (3 g.).

Note.

(1) Dry carbon tetrachloride may be prepared by distillation of the commercial product and rejection of the first 20 per cent. of the distillation.

Oxidation of 10-undecynoic acid to sebacic acid. Dissolve 2.00 g. of the acid, m.p. $41\text{--}42^\circ$, in 50 ml. of water containing 0.585 g. of pure anhydrous sodium carbonate. Saturate the solution with carbon dioxide and add 0.1*N* potassium permanganate solution (about 1500 ml.) slowly and with constant stirring until the pink colour remains for half an hour; the addition occupies about 3 hours. Decolourise the solution with a little sulphur dioxide and filter off the precipitated acid through a

weighed sintered glass crucible. Upon standing for 24 hours a further crop of acid separates. Filter this through the same crucible and dry in a vacuum desiccator over concentrated sulphuric acid. The yield of acid is 1.46 g. This has m.p. 133° and the m.p. is not depressed upon admixture with pure sebacic acid. In determining the total yield of sebacic acid, allowance must be made for the amount dissolved in the 1500 ml. of solution.

III,150. CATALYTIC REDUCTION WITH ADAMS' PLATINUM OXIDE CATALYST

Adams' platinum oxide catalyst is readily prepared from chloroplatinic acid or from ammonium chloroplatinate, and is employed for catalytic hydrogenation at pressures of one atmosphere to several atmospheres and from room temperature to about 90°. Reduction is usually carried out with rectified spirit or absolute alcohol as solvents. In some cases (*e.g.*, the reduction of benzene, toluene, xylene, mesitylene, cymene and diphenyl*), the addition to the absolute alcohol solution of 2-5 per cent. of the volume of rectified spirit which has been saturated with hydrogen chloride increases the effectiveness of the catalyst; under these conditions chlorobenzene, bromobenzene, *o*-, *m*- and *p*-bromotoluenes, *p*-dichloro- and *p*-dibromo-benzene are reduced completely but the halogens are simultaneously eliminated. Other solvents which are occasionally employed include glacial acetic acid, ethyl acetate, ethyl acetate with 17 per cent. acetic acid or 8 per cent. of alcohol. In the actual hydrogenation the platinum oxide $\text{PtO}_2 \cdot \text{H}_2\text{O}$ is first reduced to an active form of finely-divided platinum, which is the real catalyst: allowance must be made for the consumption of hydrogen in the process.

PREPARATION OF ADAMS' PLATINUM OXIDE CATALYST

Method 1. From ammonium chloroplatinate. Place 3.0 g. of ammonium chloroplatinate and 30 g. of A.R. sodium nitrate (1) in Pyrex beaker or porcelain casserole and heat gently at first until the rapid evolution of gas slackens, and then more strongly until a temperature of about 300° is reached. This operation occupies about 15 minutes, and there is no spattering. Maintain the fluid mass at 500-530° for 30 minutes, and allow the mixture to cool. Treat the solid mass with 50 ml. of water. The brown precipitate of platinum oxide ($\text{PtO}_2 \cdot \text{H}_2\text{O}$) settles to the bottom. Wash it once or twice by decantation, filter through a hardened filter paper on a Gooch crucible, and wash on the filter until practically free from nitrates. Stop the washing process immediately the precipitate tends to become colloidal (2): traces of sodium nitrate do not affect the efficiency of the catalyst. Dry the oxide in a desiccator, and weigh out portions of the dried material as required.

Method 2. From chloroplatinic acid. Dissolve 3.5 g. of the purest commercial chloroplatinic acid (3) in 10 ml. of water contained in a 250 ml. Pyrex beaker or porcelain casserole, and add 35 g. of A.R. sodium nitrate (1). Evaporate the mixture to dryness by heating gently over a Bunsen flame whilst stirring with a glass rod. Then raise the temperature

* Diphenyl is reduced comparatively slowly to *dicyclohexyl* at atmospheric pressure; a pressure of 3-5 atmospheres is recommended (use the apparatus shown in Fig. VI, 4, 1).

to 350-370° within about 10 minutes : fusion will occur accompanied by the evolution of brown oxides of nitrogen and the gradual separation of a precipitate of brown platinum oxide. If foaming occurs, stir the mixture more vigorously and direct an additional flame at the top of the reaction mixture, if necessary. If the burner beneath the beaker is removed when frothing commences, the top of the fused mass solidifies and material may be carried over the sides of the vessel. After 15 minutes, when the temperature has reached about 400°, the evolution of gas decreases considerably. Continue the heating until at the end of 2 minutes the temperature is 500-550°; at this stage the evolution of oxides of nitrogen has practically ceased and there is a gentle evolution of gas. Maintain the temperature at this point (best with the full force of a Bunsen burner) for about 30 minutes, by which time fusion is complete. Allow the mass to cool (the Pyrex beaker may crack), add 50 ml. of water, and proceed as in *Method 1*.

Method 3. From platinum metal or platinum residues. Dissolve the platinum metal or platinum residues in *aqua regia*, evaporate just to dryness several times with concentrated hydrochloric acid, dissolve the final residue in a little water and precipitate as ammonium chloroplatinate with excess of saturated ammonium chloride solution. Filter and dry the precipitate at 100°. Then proceed according to *Method 1*.

Notes.

(1) The use of an equivalent quantity of A.R. potassium nitrate is said to produce a more active catalyst.

(2) It is advisable to test a small portion of the filtrate for platinum by acidifying with hydrochloric acid and adding a few drops of stannous chloride solution : a yellow or brown colour develops according to the quantity of platinum present. The yellow colour is soluble in ether, thus rendering the test more sensitive. If platinum is found, treat the filtrate with excess of formaldehyde and sodium hydroxide solution and heat ; platinum black separates on standing and may be filtered and worked up with other platinum residues (see *Method 3*).

(3) That supplied by Johnson, Matthey and Co. Ltd. gives satisfactory results.

SIMPLE APPARATUS FOR HYDROGENATION AT ATMOSPHERIC PRESSURE

The apparatus is shown in Fig. III, 150, 1. The bottle *B* has a capacity of 2.5 litres and *A* is a narrow-mouthed 2-litre graduated cylinder. All rubber tubing is of the heavy-wall type ("pressure" tubing) and is "wired on" to the glass by means of copper wire ligatures ; the rubber stoppers in *A* and *B* are likewise fixed firmly in position by copper wires. The glass tube carrying the stopcock *3* is securely attached to the cylinder *A* in any convenient manner (copper wire, etc.). The rubber "pressure" tubing *C* is about 1 metre long. To charge the measuring cylinder with hydrogen, fill it first almost completely with water (the glass tube *F* is within 5 mm. of the top) and adjust the level of the water in the bottle *B* so that it is just above the lower tubulure. Close stopcocks *1*, *2* and *3*. By means of rubber "pressure" tubing connect a hydrogen cylinder, provided with a needle valve control, to *D*. Open the screw clip *E* and pass a slow stream of hydrogen through the T-piece. Open taps *1* and *2* and adjust the screw clip *E* so that hydrogen passes slowly into *A* ; the

displaced water enters *B*. When the level of the water in *A* is near to the 2000 ml. mark, open the screw clip *E* and simultaneously close the stopcocks *1* and *2*: shut off the hydrogen supply at the cylinder. Now open stopcocks *1* and *3* and thus refill the cylinder *A* almost completely

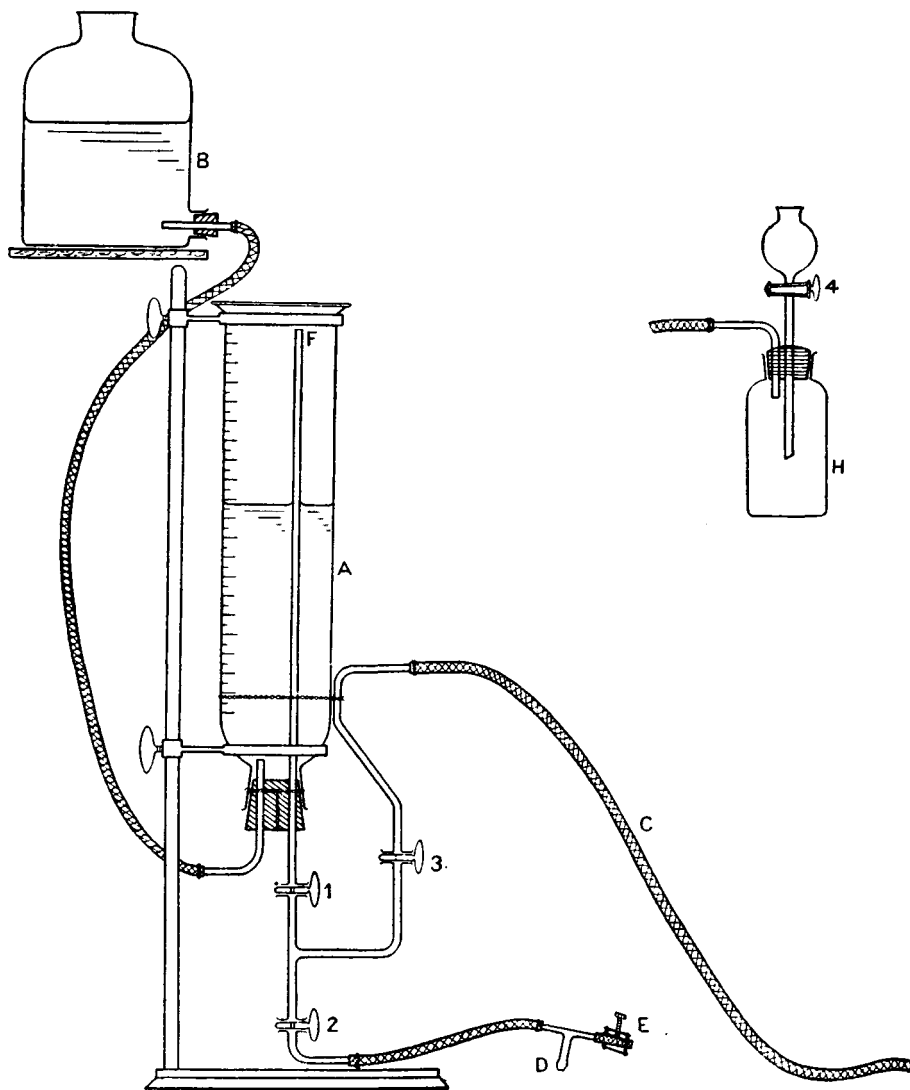

Fig. III, 150, 1.

with water; allow the hydrogen to run to waste. Repeat the process four or five times to ensure the complete elimination of any air present in *A*. Finally, charge the cylinder *A* with hydrogen; stopcocks *1*, *2* and *3* must then be kept closed.

The hydrogenation is conveniently conducted in a wide-mouthed bottle *H* of 250 ml. capacity, provided with a "head" carrying a 50 ml.

funnel and fitted into the flask by means of a ground glass joint. The funnel permits of the addition of solvents or solutions and also provides an outlet for displacing the air in the bottle. Test the apparatus for leakages in the following manner. Lubricate the ground joint with a suitable inert grease (see Section II,59) and fix the "head" tightly into the bottle by means of short lengths of rubber tubing over it and held by means of copper wire ligatures round the neck of the bottle. Clamp the bottle in the shaking machine (see Fig. II, 7, 5) and attach the rubber tubing *C*; this should be loosely clamped near the centre to prevent undue strain on the glass. Open stopcocks 1, 3 and 4 and displace the air from the bottle *H* with hydrogen. Close the stopcock 4 from time to time; this will assist the displacement of the air and will also permit the detection of a leak in the ground glass joint. Recharge the cylinder *A* with hydrogen; close stopcock 3 during this process. Open taps 1 and 3, close tap 2, equalise the levels in *A* and *B*, record the volume of hydrogen and return *B* to the position shown in the figure. Set the shaking machine in motion and observe the volume of hydrogen in *A* after 30-60 minutes. If the volume remains unchanged, there is no leak in the apparatus.

The hydrogenation bottle *J* depicted in Fig. III, 150, 2 may also be used; it incorporates a magnetic stirrer (compare Fig. II, 7, 15) in lieu of a shaking machine and therefore has many obvious advantages. The mode of use is similar to that described for bottle *H*.

REDUCTION OF MALEIC ACID TO SUCCINIC ACID

Place 0.1 g. of the catalyst in the hydrogenation vessel and then introduce a solution of 5.9 g. of pure maleic acid (Section III,143) in 75 ml. of absolute alcohol. Make sure that the catalyst is completely covered by the solution, since an explosion may occur when hydrogen is admitted if traces of the platinum oxide stick to the walls of the bottle. Lubricate the stopper with an inert grease (compare Section II,59) and insert it into the vessel; fix it securely in position by means of two short lengths of rubber tubing passing over the top of the stopper and held tightly against the neck of the bottle by means of copper wire ligatures. Connect the hydrogenation vessel *H* to the supply of hydrogen in the cylinder *A* by means of a length of rubber "pressure" tubing and firmly clamp the bottle in the shaking machine. Displace the air from the connecting tubes and from the bottle by closing stopcock 2, opening stopcocks 1, 3 and 4, and passing about 1500 ml. of hydrogen slowly from the reservoir; alternately close and open tap 4 from time to time in order to assist the displacement and also to detect any leaks in the ground glass joint. Finally, close taps 3 and 4, and recharge reservoir *A* so that it contains about 2 litres of hydrogen. Open taps 1 and 3. Equalise the water levels in *A* and *B*, open tap 4 momentarily and record the reading on *A*; raise *B* to its original position (as in Fig. III, 150, 1). Set the

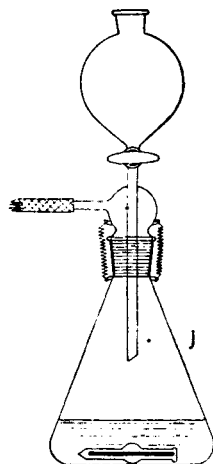

Fig. III, 150, 2.

shaking machine in motion; observe the barometric pressure and the temperature of the water in *B*. After 2 hours no further change in volume occurs and the theoretical volume of hydrogen is absorbed. Record the exact volume after equalising the levels in *A* and *B*. Filter the reaction product through two filter papers supported on a Buchner or similar funnel, and evaporate the alcoholic solution to dryness on a water bath. The residue (5.9 g.) has m.p. 184°; the m.p. is unaffected after crystallisation from 25 ml. of hot water or upon admixture with an authentic sample of succinic acid.

REDUCTION OF CINNAMIC ACID TO DIHYDROCINNAMIC ACID

Use 0.1 g. of the platinum oxide catalyst and 11.4 g. of pure cinnamic acid dissolved in 100 ml. of absolute alcohol. The theoretical volume of hydrogen is absorbed after 7-8 hours. Filter off the platinum, and evaporate the filtrate on a water bath. The resulting oil solidifies on cooling to a colourless acid, m.p. 47-48° (11.2 g.). Upon recrystallisation from light petroleum, b.p. 60-80°, pure dihydrocinnamic acid, m.p. 48-49°, is obtained.

The mono-alkyl C-substituted derivatives of ethyl acetoacetate upon treatment with sodium ethoxide and another molecule of alkyl halide afford the di-alkyl C-substituted products



these upon ketonic hydrolysis give ketones of the general formula

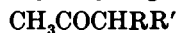

and upon acid hydrolysis yield dialkyl derivatives of acetic acid



The formation of ethyl acetoacetate is an example of a general reaction known as the **acetoacetic ester condensation** in which an ester having hydrogen on the α -carbon atom condenses with a second molecule of the same ester or with another ester (which may or may not have hydrogen on the α -carbon atom) in the presence of a basic catalyst (sodium, sodium ethoxide, sodamide, sodium triphenylmethide) to form a β -keto-ester. The *mechanism* of the reaction may be illustrated by the condensation of ethyl acetate with another molecule of ethyl acetate by means of sodium ethoxide.*

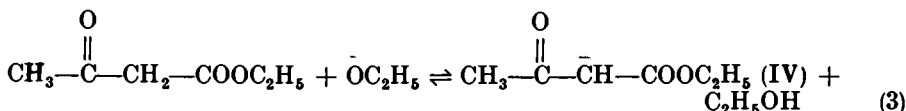
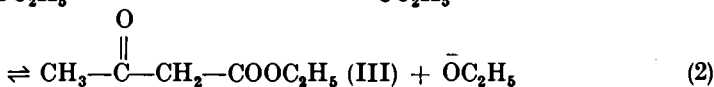
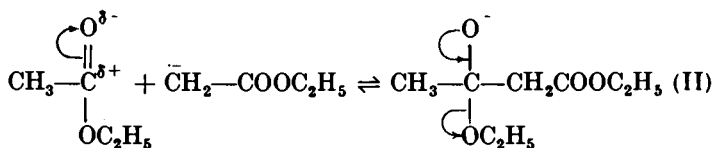
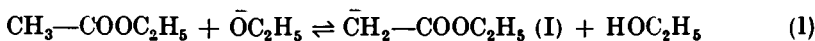

The first step is the interaction of the basic catalyst with the ester to produce the carbanion (I); the carbanion so formed then attacks the carbonyl carbon of a second molecule of ester to produce the anion (II), which is converted to ethyl acetoacetate (II) by the ejection of an ethoxide ion. Finally (III) reacts with ethoxide ion to produce acetoacetic ester anion (IV). This and other anions are mesomeric; thus (IV) may be written :

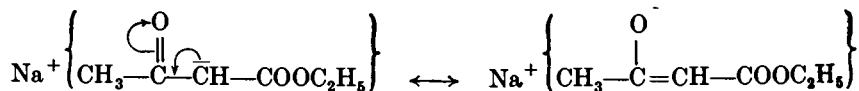

The equilibrium of the last step (3), which is not actually part of the condensation mechanism, is far to the right because of the greater basic strength of the ethoxide ion as compared to (IV), and this largely assists the forward reactions in (1) and (2). The reaction mixture contains the sodium derivative of the keto-ester, and the free ester is obtained upon acidification.

* When sodium is employed as the condensing agent, the effective reagent is still sodium ethoxide. The sodium reacts with a trace of alcohol present in the ester to give a small amount of sodium ethoxide; once the reaction commences, alcohol is generated and reacts with sodium to give more of the sodium ethoxide. Highly purified ethyl acetate does not condense in the presence of sodium.

It may be pointed out that C-alkylation of ethyl acetoacetate is readily accounted for by the mesomeric nature of the carbanion (IV), as will be evident from the following* :

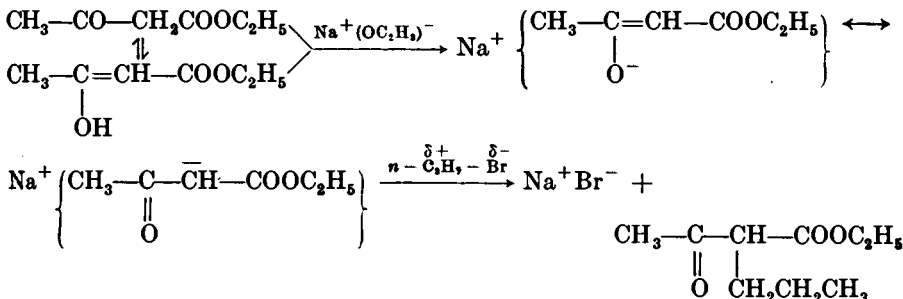

Only esters containing two α -hydrogen atoms (ethyl acetate, propionate, *n*-butyrate, etc.) can be condensed with the aid of sodium alkoxides. For esters with one α -hydrogen atom, such as ethyl *isobutyrate*, the more powerful base sodium triphenylmethide $\text{Ph}_3\text{C}^-\text{Na}^+$ leads to condensation with the formation of ethyl *α -isobutyrylisobutyrate* :

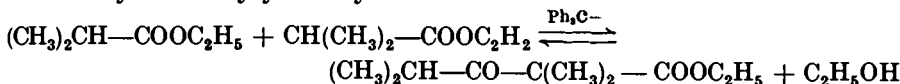

Ketonic hydrolysis with a mixture of sulphuric and acetic acids of the ethyl *isobutyrylisobutyrate* yields di-*iso*-propyl ketone :

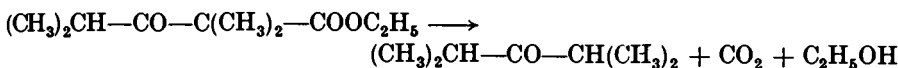

The acetoacetic ester condensation (involving the acylation of an ester by an ester) is a special case of a more general reaction termed the **Claisen condensation**. The latter is the condensation between a carboxylic ester and an ester (or ketone or nitrile) containing an α -hydrogen atom in the presence of a base (sodium, sodium alkoxide, sodamide, sodium triphenylmethide, etc.). If R—H is the compound containing the α - or active hydrogen atom, the Claisen condensation may be written :



i.e., it is a base-catalysed acylation of an active hydrogen compound by means of an ester as acylating agent. Examples include acetylacetone (Section VI,1), benzoylacetone (Section VI,2) and ethyl phenylacetoacetate (Section IX,8).

III,151. ETHYL ACETOACETATE

Into a 1-litre round-bottomed flask, fitted with a double surface condenser, place 250 g. (277 ml.) of dry ethyl acetate (1) and 25 g. of clean sodium wire (2). Warm the flask on a water bath in order to start the reaction. Once the reaction commences, it proceeds vigorously and cooling of the flask may be necessary in order to avoid loss of ethyl

* Alternatively, it may be assumed that the basic ethoxide ion attacks a hydrogen atom of the activated CH_2 group to yield the carbanion directly :

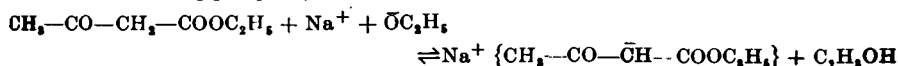

acetate through the condenser. When the vigorous action is over, warm the reaction mixture on a water bath until the sodium is completely dissolved (about 1.5 hours). Cool the resulting clear red solution and make it *slightly* acid to litmus paper by the addition of 138 ml. of 50 per cent. acetic acid. Saturate the liquid with salt, separate the upper layer of ester and dry it with anhydrous calcium chloride or anhydrous magnesium sulphate. Distil under reduced pressure (compare Fig. II, 20, 1) (3) from a Claisen flask with fractionating side arm (Figs. II, 24, 2-5). After a fore-run of ethyl acetate, collect the ethyl acetoacetate at 76-80°/18 mm. (or 86-90°/30 mm. or 72-76°/14 mm. or 69-73°/12 mm.). The yield is 55 g.

Notes.

(1) It is important to use dry ethyl acetate, but it should contain 2-3 per cent. of alcohol. The so-called absolute or anhydrous ethyl acetate of commerce is satisfactory. Experimental details for the purification of 95-97 per cent. ethyl acetate are given in Section II, 47, 19.

(2) Sodium wire, produced with a sodium press (Fig. II, 47, 1), is first collected in sodium-dried ether, the necessary quantity removed, rapidly dried between filter paper, and transferred to the flask. Thin shavings of sodium, although less satisfactory may also be employed, but it is important to avoid undue exposure of the sodium to the atmosphere which produces a surface film of sodium hydroxide.

(3) Ethyl acetoacetate decomposes slightly (with the formation of dehydracetic acid $C_6H_8O_4$) when distilled at atmospheric pressure. The extent of decomposition is reduced if the distillation is conducted rapidly. The b.p. is 180°/760 mm. and a 6° fraction should be collected. Normal pressure distillation is not recommended if a pure product is desired.

Purification of Commercial Ethyl Acetoacetate

This is an alternative experiment to the actual preparation of the ester and will give the student practice in conducting a distillation under diminished pressure. Commercial ethyl acetoacetate generally contains *inter alia* some ethyl acetate and acetic acid; these are removed in the following procedure.

Place 50 g. of technical ethyl acetoacetate in a separatory funnel and shake it with small volumes of saturated sodium bicarbonate solution until effervescence ceases, then with 10 ml. of water, and dry it with 5 g. of anhydrous magnesium sulphate or anhydrous calcium chloride. Decant the solution through a fluted filter paper (or through a small plug of cotton wool) into a 100 ml. Claisen flask, and distil under diminished pressure. Use the apparatus shown in Fig. II, 20, 1 and read Sections II, 19 and II, 20 for full experimental details. The boiling points of ethyl acetoacetate under various pressures are: 71°/12 mm.; 73°/15 mm.; 78°/18 mm.; 82°/20 mm.; 88°/30 mm.; 92°/40 mm.; 97°/60 mm.; and 100°/80 mm. When the pressure is steady, deduce the boiling point from the above data and collect the ester over an interval of 4°, *i.e.*, 2° on either side of the boiling point of the pure ester. Weigh the yield of product.

REACTIONS OF ETHYL ACETOACETATE

The experiments enumerated below illustrate the tautomeric character of ethyl acetoacetate.

(i) Dissolve 1 ml. of the ester in 4 ml. of ethyl alcohol and add 2 drops of aqueous ferric chloride solution. A deep violet-red colouration is

produced. Similar colourations are produced by many hydroxy compounds (*e.g.*, phenols) and in consequence this may be regarded as evidence for the presence of the enol form. Pour the solution into about 100 ml. of water in a conical flask, mix well, and add bromine water dropwise from a burette with vigorous shaking until the solution just becomes colourless. Upon standing the violet-red ferric chloride colouration soon reappears with gradually increasing intensity. The colour may be discharged again by bromine and will reappear on standing.

The bromine adds on at the ethylenic linkage to form the dibromo compound (I), which easily loses hydrogen bromide to give the mono-bromo keto ester (II):

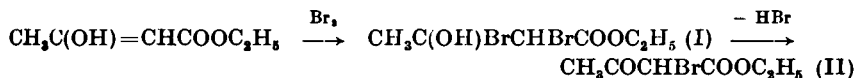

The enol form is thus temporarily removed from the solution and the ferric chloride colouration produced by the enol form consequently disappears and the solution becomes colourless. Some of the unchanged keto form of the ester then passes into the enol form in order to restore the original equilibrium and the ferric chloride colouration therefore reappears.

(ii) Shake 1 ml. of ethyl acetoacetate with 10 ml. of an ammoniacal solution of cupric sulphate; the latter may be prepared by adding 1:1-ammonia solution to Fehling's solution No. 1 (Section III,70) until the initial precipitate disappears. Shake in a corked test-tube for several minutes: a bluish-green precipitate of the cupric derivative of the enol form separates. The precipitate dissolves when the mixture is shaken with chloroform, thus proving that it is not a normal ionised salt.

(iii) Treat 2 ml. of the ester with 0.5 ml. of a freshly-prepared, saturated sodium bisulphite solution and shake. A gelatinous precipitate of the bisulphite addition compound of the keto form separates within 10 minutes.

(iv) Dissolve 0.2 g. of semicarbazide hydrochloride and 0.3 g. of crystallised sodium acetate in a few drops of water, add 5 drops of ethyl acetoacetate and enough ethyl alcohol, drop by drop, to give a homogeneous solution. Warm on a water bath at 70–80° for 10 minutes, then cool in ice, and, if necessary, scratch the walls of the tube with a glass rod. Filter off the semicarbazone at the pump, and recrystallise it from ether. Determine its m.p. (130°).

COGNATE PREPARATION

ETHYL ISOBUTYRYLISOBUTYRATE

Triphenylmethylsodium (sodium triphenylmethide). Prepare a 1.5 per cent. sodium amalgam from 15 g. of sodium and 985 g. of mercury (Section II,50,7). Place a mixture of 1000 g. of the amalgam and 74 g. of triphenylchloromethane (Section IV,203) in a 2-litre Pyrex glass-stoppered bottle and add 150 ml. of sodium-dried ether. Grease the glass stopper with a little lubricant (*e.g.*, with "Lubriscal"), insert it firmly, clamp the bottle in a mechanical shaker and shake. The reaction is strongly exothermic: cool the bottle with wet rags and stop the shaking from time to time, if necessary. A characteristic red colour appears after

about 10 minutes' shaking. After shaking for four to six hours, *cool the bottle to room temperature*, remove it from the shaker, wire the stopper down and allow the mixture to stand undisturbed overnight; sodium chloride and particles of mercury settle to the bottom.

Separate the ether solution of sodium triphenylmethide as follows. Remove the glass stopper and replace it immediately by a tightly-fitting two-holed cork carrying a short glass tube that protrudes about 1 cm. into the bottle, and a long glass tube bent into an inverted U shape. Connect the bottle through a drying train to a cylinder of nitrogen and the other arm of the U tube to a 2-litre conical flask (as in Fig. III, 151, 2) which has previously been filled with nitrogen. Seal all corks with a

coating of paraffin wax. Open the stopcock of the dropping funnel slightly and force the ether solution of triphenylmethylsodium slowly and steadily into the nitrogen-filled flask by means of a small pressure of nitrogen from the cylinder. By carefully adjusting the depth of the siphon tube in the bottle, all but 50–75 ml. of the clear ether solution may be removed.

If pure triphenylchloromethane and freshly prepared sodium amalgam are used, the yield of sodium triphenylmethide should be almost quantitative but is usually 0.15 mol per litre (1). The reagent should be used as soon as possible after its preparation.

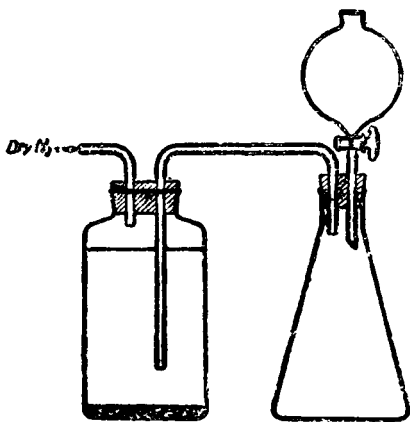

Fig. III, 151, 2.

Note.

(1) The solution may be analysed approximately as follows. Remove 25 ml. of the ether solution and run it into 25 ml. of water contained in a small separatory funnel; shake. Run off the aqueous layer into a 250 ml. conical flask and extract the ether layer with two 25 ml. portions of water. Titrate the combined aqueous extracts with 0.1N sulphuric acid, using methyl red as indicator.

Ethyl isobutyryl isobutyrate. Add 24.6 g. (28.3 ml.) of ethyl isobutyrate, b.p. 110–111°, to the solution of *ca.* 0.21 mol of sodium triphenylmethide in approximately 1400 ml. of ether contained in the 2-litre conical flask. Stopper the flask, shake well to effect complete mixing, and keep at room temperature for 60 hours. Acidify the reaction mixture by adding, with shaking, 15 ml. of glacial acetic acid, and then extract with 100 ml. of water. Wash the ethereal solution with 50 ml. portions of 10 per cent. sodium carbonate solution until free from excess acid, dry over anhydrous magnesium sulphate, and distil off the ether on a steam bath. Distil the residue under reduced pressure from a Claisen flask with fractionating side arm (Figs. II, 24, 4–5). Collect the ethyl isobutyryl isobutyrate at 95–96°/18 mm.; the yield is 15 g. The b.p. at atmospheric pressure is 201–202°.

Ketonic hydrolysis to di-iso-propyl ketone. Mix 15 g. of the ester with 30 ml. of glacial acetic acid, 10 ml. of water and 10 ml. of concentrated sulphuric acid, and reflux in a flask connected by a ground glass joint

to a reflux condenser equipped with a bubble counter (compare Fig. III, 72, 1). When evolution of carbon dioxide ceases, dilute the cooled solution with 180 ml. of water, add 100 ml. of ether and render alkaline to phenolphthalein with 20 per cent. sodium hydroxide solution. Separate the ether layer, extract the aqueous layer with two 50 ml. portions of ether, dry the combined ether layer and extracts with anhydrous magnesium sulphate, distil off the ether and fractionate the residue. The yield of di-*iso*-propyl ketone, b.p. 123–124°, is 7 g.

III,152. ETHYL *n*-PROPYLACETOACETATE AND METHYL *n*-BUTYL KETONE

Fit a 2-litre three-necked flask (1) with an efficient double surface condenser and a separatory funnel; close the central neck with a tightly fitting stopper. The apparatus must be perfectly dry. Place 34.5 g. of clean sodium, cut into small pieces (2), in the flask and clamp the flask by the wide central neck. Measure out 1 litre of "super-dry" ethyl alcohol (Section II,47,5) (3) and place about 500 ml. in the separatory funnel; insert cotton wool (or calcium chloride) guard tubes at the top of the condenser and the separatory funnel respectively. Place a large bowl beneath the flask and have a large wet towel in readiness to control the vigour of the subsequent reaction. Run in about 200 ml. of the absolute alcohol on to the sodium (4); a vigorous reaction takes place. If the alcohol refluxes violently in the condenser, cool the flask by wrapping it in the wet towel and also, if necessary, run a stream of cold water over it. As soon as the reaction moderates somewhat, introduce more alcohol to maintain rapid, but controllable, refluxing. In this manner most of the sodium reacts rapidly and the time required to produce the solution of sodium ethoxide is considerably reduced. Finally add the remainder of the alcohol and reflux the mixture on a water bath until the sodium has reacted completely. Remove the stopper in the central neck and introduce a mercury-sealed stirrer (compare Fig. II, 7, 11, a). Add 195 g. (190 ml.) of pure ethyl acetoacetate, stir the solution, and heat to gentle boiling; then run in 205 g. (151 ml.) of *n*-propyl bromide (Section III,35) over a period of about 60 minutes. Continue the refluxing and stirring until a sample of the solution is neutral to moist litmus paper (6–10 hours); the reaction is then complete.

Cool the mixture and decant the solution from the sodium bromide: wash the salt with two 20 ml. portions of absolute alcohol and add the washings to the main solution. Distil off the alcohol, which contains the slight excess of *n*-propyl bromide used in the condensation, through a short fractionating column from a water bath. The residue (A) of crude ethyl *n*-propylacetoacetate may be used directly in the preparation of methyl *n*-butyl ketone. If the fairly pure ester is required, distil the crude product under diminished pressure and collect the fraction boiling at 109–113°/27 mm. (183 g.) (B).

To prepare methyl *n*-butyl ketone, add the crude ester (A) or the redistilled ethyl *n*-propylacetoacetate (B) to 1500 ml. of a 5 per cent solution of sodium hydroxide contained in a 4-litre flask equipped with a mechanical stirrer. Continue the stirring at room temperature for

4 hours; by this time the mono-substituted acetoacetic ester is completely hydrolysed and passes into solution. Transfer the mixture to a large separatory funnel, allow to stand and remove the small quantity of unsaponified material which separates as an upper oily layer. Place the aqueous solution of sodium *n*-propylacetoacetate in a 3-litre round-bottomed flask provided with a cork fitted with a small separatory funnel and a wide bent delivery tube connected to a condenser set for downward distillation (compare Fig. III, 35, 1). Add 150 ml. of 50 per cent. sulphuric acid (sp. gr. 1.40) slowly through the separatory funnel with shaking; a vigorous evolution of carbon dioxide occurs. When the latter has subsided, heat the reaction mixture slowly to the boiling point and distil slowly until the total volume is reduced by about one half; by this time all the methyl *n*-butyl ketone should have passed over. The distillate contains the ketone, ethyl alcohol and small quantities of acetic and *n*-valeric acids. Add small portions of solid sodium hydroxide to the distillate until it is alkaline and redistil the solution until 80-90 per cent has been collected; discard the residue.

Separate the ketone layer from the water, and redistil the latter until about one third of the material has passed over. Remove the ketone after salting out any dissolved ketone with potassium carbonate (5). Wash the combined ketone fractions four times with one third the volume of 35-40 per cent. calcium chloride solution in order to remove the alcohol. Dry over 15 g. of anhydrous calcium chloride; it is best to shake in a separatory funnel with 1-2 g. of the anhydrous calcium chloride, remove the saturated solution of calcium chloride as formed, and then allow to stand over 10 g. of calcium chloride in a dry flask. Filter and distil. Collect the methyl *n*-butyl ketone at 126-128°. The yield is 71 g.

Notes.

(1) A 2-litre round-bottomed flask provided with the adapter illustrated in Fig. II, 1, 8, *d* may also be used. For preparations on one half or one quarter of this scale, a 1000 or 500 ml. flask equipped with an efficient double surface condenser will give reasonably good results.

(2) The surface layer on lumps of sodium is removed with a large knife, the clean sodium is *rapidly* weighed out on a few large filter papers and immediately transferred to a beaker containing sodium-dried ether. The sodium may then be removed at leisure, cut into small pieces and transferred to the flask.

(3) If the absolute alcohol of commerce is used, the yield is appreciably diminished.

(4) The addition of the alcohol to the sodium, although attended by a very vigorous reaction which must be carefully controlled, is preferable to the reverse procedure of adding the sodium in small pieces to the alcohol. The latter method is longer and has the further disadvantage that it necessitates frequent handling and exposure to the air of small pieces of sodium.

(5) A more complete recovery of the ketone from the aqueous solution may be obtained by repeated distillation of the aqueous layer until no appreciable amount of ketone is found in the distillate. The procedure outlined is, however, quite satisfactory.

COGNATE PREPARATION

Ethyl *n*-butylacetoacetate and methyl *n*-amyl ketone. Use 34.5 g. of sodium, 1 litre of "super-dry" absolute ethyl alcohol, 195 g. of redistilled ethyl acetoacetate, and 225 g. (177 ml.) of dry *n*-butyl bromide (Sections III,35 and III,37). This yields 280 g. of crude or 200 g. of pure ethyl *n*-butylacetoacetate, b.p. 112-116°/16 mm. Upon hydrolysis 105 g. of methyl *n*-amyl ketone, b.p. 149-151°, are isolated.

DIETHYL MALONATE

Ethyl malonate can be conveniently prepared by neutralising a solution of monochloroacetic acid with sodium bicarbonate, then heating with potassium cyanide to form sodium cyanoacetate :

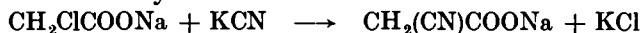

Upon warming the crude sodium cyanoacetate with ethyl alcohol and sulphuric acid, ethyl malonate is produced. Two mechanisms of the reaction have been proposed :—

(i) The cyano group is hydrolysed giving malonic acid and the latter is esterified :

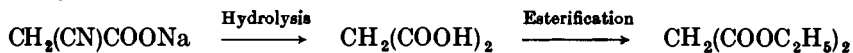

(ii) The original carboxyl group is esterified, the cyano group adds on alcohol to form an imino ester, and the latter is hydrolysed by water :

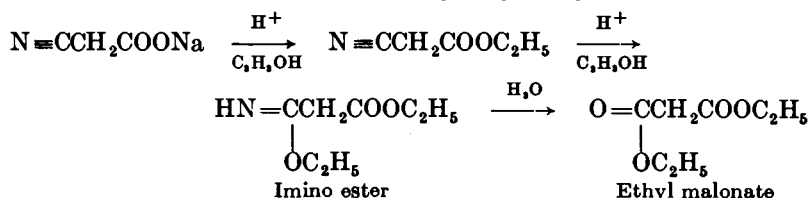

Malonic ester, like acetoacetic ester (Section III, 151), when treated with an equivalent of sodium ethoxide, forms a mono-sodium derivative, which is of great value in synthetical work. The simplest formulation of the reaction is to regard it as an attack of the basic ethoxide ion on a hydrogen atom in the CH_2 group; the hydrogen atoms in the CH_2 group are activated by the presence of the two adjacent carbethoxyl groups :

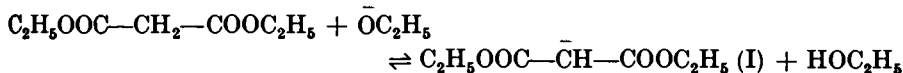

The carbanion (I) is a resonance hybrid (mesomeric anion) to which there are contributions carrying the negative charge on either carbon or oxygen :

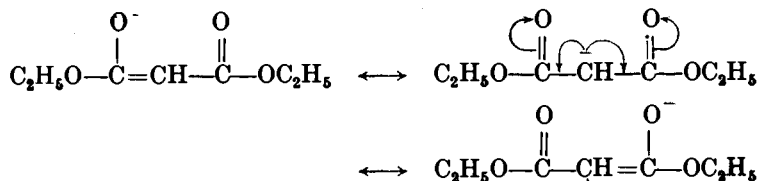

The sodio compound may be written $[\text{CH}(\text{COOC}_2\text{H}_5)_2]^- \text{Na}^+$, and it must always be borne in mind that the anion is mesomeric. The system reacts smoothly with an alkyl halide to give a C-substituted malonic ester, evidently through the carbanion (I) :

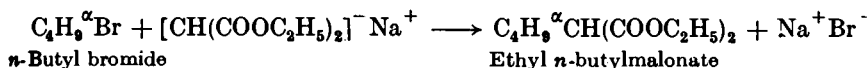

The mono-alkyl malonic ester may be hydrolysed by alcoholic potassium hydroxide to the corresponding alkyl-malonic acid :

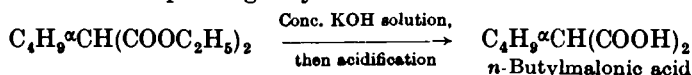

somewhat vigorous reaction is complete. Evaporate the solution, preferably on an electrically heated hot plate, with vigorous and constant stirring, until the temperature rises to 130–135°. Protect the hand by a glove during this operation; arrange that the glass window of the fume cupboard is between the dish and the face during the period of heating. Stir the mass occasionally whilst the mixture cools and, immediately it solidifies, break up the solid mass coarsely in a mortar and transfer it to a 1-litre round-bottomed flask. Add 40 ml. of absolute ethyl alcohol and attach a reflux condenser to the flask. Introduce through the condenser during 10 minutes in small portions and with frequent shaking, a cold mixture of 160 ml. of absolute ethyl alcohol and 160 ml. of concentrated sulphuric acid; some hydrogen chloride may be evolved during the final stages of the addition. Heat the flask on a water bath for 1 hour. Cool rapidly under the tap with shaking to prevent the formation of a solid mass of crystals. Add 200 ml. of water, filter at the pump, wash the undissolved salts with about 75 ml. of ether, shake up with the filtrate and transfer to a separatory funnel. Separate the upper layer, and extract the aqueous solution twice with 50 ml. portions of ether. Place the combined ethereal extracts in a separatory funnel and shake *cautiously* with concentrated sodium carbonate solution until the latter remains alkaline and no more carbon dioxide is evolved. Dry the ethereal solution over anhydrous magnesium or calcium sulphate.

Remove the ether using the apparatus shown in Fig. II, 13, 4 except that a 200 ml. Claisen flask replaces the distilling flask depicted in the diagram. Distil the residual ester under diminished pressure (Fig. II, 20, 1) and collect the ethyl malonate at 92–94°/16 mm. The yield is 105 g.

The b.p. under atmospheric pressure is 198–199°, but is attended by slight decomposition.

III,154. ETHYL *n*-BUTYLMALONATE

Prepare a solution of sodium ethoxide from 34.5 g. of clean sodium and 1-litre of "super-dry" ethyl alcohol (Section II,47,5) (1) in a 2-litre three-necked flask following the experimental conditions given under *Ethyl n-Propylacetoacetate* (Section III,152) (2). When the sodium ethoxide solution, which is vigorously stirred, has cooled to about 50°, add 247.5 g. (234.5 ml.) of redistilled diethyl malonate slowly through the separatory funnel; to the resulting clear solution introduce gradually (60–90 minutes) 205.5 g. (161.5 ml.) of redistilled *n*-butyl bromide (Sections III,35 and III,37). Reaction occurs almost immediately and much heat is evolved; if the reaction becomes violent, cool the flask by directing a stream of cold water over it. Reflux the reaction mixture on a water bath until it is neutral to moist litmus (about 2 hours). Connect the flask by means of a wide delivery tube to a condenser set for distillation (compare Fig. II, 41, 1 but with a mercury-sealed stirrer in the central neck) and distil off as much of the alcohol as possible (about 600 ml.) by heating on a water bath. Cool the contents of the flask to about 20°, add 600 ml. of water and shake well. Separate the upper layer of crude ester, dry it with anhydrous magnesium sulphate, and distil from a Claisen flask under reduced pressure (Fig. II, 20, 1). A low

boiling point fraction passes over first, followed by ethyl *n*-butylmalonate at 130–135°/20 mm. The yield is 285 g. The distillation may also be conducted under normal pressure ; the b.p. of the ester is 235–240°.

Notes.

(1) With commercial absolute ethyl alcohol, the yield is reduced to about 225 g.

(2) The preparation may be carried out on one third of the above scale in a 1-litre flask with hand shaking replacing mechanical stirring. The yield is slightly lower.

COGNATE PREPARATION

Ethyl *n*-propylmalonate. Use 34·5 g. of sodium and 345 g. (440 ml.) of "super-dry" ethyl alcohol, 240 g. (227·5 ml.) of ethyl malonate and 185 g. (136·5 ml.) of *n*-propyl bromide (Section III,35). The yield of ethyl *n*-propylmalonate, b.p. 218–225°, mainly 219·5–221·5°, is 220 g.

III,155. *n*-CAPROIC ACID (from Ethyl *n*-Butylmalonate)

Into a 2-litre, three-necked flask, fitted with a separatory funnel, a mechanical stirrer and a reflux condenser, place a hot solution of 200 g. of potassium hydroxide in 200 ml. of water. Stir the solution and add slowly 200 g. of ethyl *n*-butylmalonate (Section III,154). A vigorous reaction occurs and the solution refluxes. When all the ester has been added, boil the solution gently for 2–3 hours, *i.e.*, until hydrolysis is complete : a test portion should dissolve completely in water. Dilute with 200 ml. of water and distil off 200 ml. of liquid in order to ensure the complete removal of the alcohol formed in the hydrolysis (1) ; it is best to connect the flask by means of a wide delivery tube to a condenser set for downward distillation (compare Fig. II, 41, 1 but with a mercury-sealed stirrer in the centre neck). Replace the separatory funnel and the reflux condenser.

To the cold residue in the flask add, through the separatory funnel, a cold solution of 320 g. (174 ml.) of concentrated sulphuric acid in 450 ml. of water : add the acid slowly with stirring in order to prevent excessive foaming. The solution becomes hot. Reflux the mixture for 3–4 hours and allow to cool. Separate the upper layer of the organic acid and extract the aqueous portion with four 150 ml. portions of benzene (2). Combine the acid layer with the benzene extracts, wash it with 25 ml. of water, and dry with anhydrous magnesium sulphate. Distil off the benzene through a short fractionating column until the vapours reach a temperature of about 100°. Transfer the residue to a Claisen flask with a fractionating side arm (the latter should be well lagged and, preferably, electrically heated) and distil from an air bath. Collect the *n*-caproic acid at 200–206°. The yield is 80 g.

If desired, the distillation may be conducted under reduced pressure. The boiling points under various pressures are 99°/10 mm. and 111°/20 mm. ; a 3° fraction should be collected.

Notes.

(1) It is essential to remove the alcohol completely, otherwise some ethyl *n*-caproate, b.p. 168°, is formed which will contaminate the final product.

(2) Better results are obtained if a continuous extraction apparatus (*e.g.* Fig. II, 44, 2) is employed. Ether may also be used as the solvent.

COGNATE PREPARATIONS

***n*-Valeric acid.** Ethyl *n*-propylmalonate (Section III,156) may be similarly converted into *n*-valeric acid, b.p. 183–185° (compare Sections III,83 and III,84); the yield is 75 per cent. of the theoretical.

Pelargonic acid (*n*-Nonoic acid), CH₃(CH₂)₇COOH. Equip a 1-litre, three-necked flask with a reflux condenser, a mercury-sealed stirrer, a dropping funnel and a thermometer. Place 23 g. of sodium, cut in small pieces, in the flask, and add 500 ml. of anhydrous *n*-butyl alcohol (1) in two or three portions: follow the experimental details given in Section III,152 for the preparation of a solution of sodium ethoxide. When the sodium has reacted completely, allow the solution to cool to 70–80° and add 160 g. (152 ml.) of redistilled ethyl malonate rapidly and with stirring. Heat the solution to 80–90°, and place 182.5 g. (160 ml.) of *n*-heptyl bromide (compare experimental details in Section III,37) in the dropping funnel. Add the bromide slowly at first until precipitation of sodium bromide commences, and subsequently at such a rate that the *n*-butyl alcohol refluxes gently. Reflux the mixture until it is neutral to moist litmus (about 1 hour).

Transfer the entire reaction mixture, including the precipitated sodium bromide and the small volume of water used to rinse the reaction flask, to a 3-litre flask. Add a solution of 140 g. of pure potassium hydroxide in an equal quantity of water slowly and with shaking. Attach a reflux condenser to the flask, introduce a few fragments of porous porcelain and heat the mixture cautiously, with occasional shaking, until refluxing commences. Heat to gentle refluxing until hydrolysis is complete (about 5 hours, *i.e.*, until a test portion is completely miscible with excess of water). Immediately equip the flask for steam distillation as in Fig. II, 41, 3 and steam distil the mixture until no more *n*-butyl alcohol passes over. Treat the residue cautiously with 270 ml. of concentrated hydrochloric acid whilst shaking gently, and reflux the mixture for 1 hour; if sodium chloride separates as a solid cake, take care during the heating that the flask does not crack. When cold, transfer the mixture to a separatory funnel and remove the oil to a 750 ml. round-bottomed flask. Heat it under an air-cooled reflux condenser in an oil bath at 180° until the evolution of carbon dioxide ceases (about 2 hours) (2). Decant the oil into a Claisen flask with fractionating side arm (the latter should be well lagged) and distil under reduced pressure. Collect the pelargonic acid at 140–142°/12 mm. The yield is 115 g.

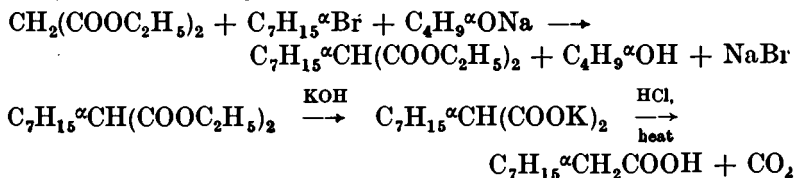
**Notes.**

(1) This is conveniently prepared by drying commercial *n*-butyl alcohol with anhydrous potassium carbonate or anhydrous calcium sulphate, distilling through a column, and collecting the fraction, b.p. 117–118°.

(2) An additional small quantity of pelargonic acid may be obtained by treating the solid residue with 50 ml. of concentrated hydrochloric acid.

III,156. *n*-PROPYLMALONIC ACID

Dissolve 156 g. of pure potassium hydroxide in 156 ml. of water in a 1.5 litre round-bottomed flask and add 500 ml. of rectified spirit to produce a homogeneous solution. Introduce 220 g. of ethyl *n*-propylmalonate (Section III,154) slowly and with shaking. Attach a vertical double surface condenser and reflux the mixture for 3 hours; hydrolysis is then complete, *i.e.*, a test portion dissolves completely in excess of water. Distil off as much alcohol as possible on a water bath, and dissolve the residue in a comparatively small volume of water. Cool the solution in a large beaker surrounded by ice; add dilute sulphuric acid slowly from a suitably supported dropping funnel, whilst stirring vigorously with a mechanical stirrer, until the solution is acid to Congo red paper. Extract the solution with three 150 ml. portions of ether, dry the ethereal extract with anhydrous magnesium or sodium sulphate, and distil off the ether on a water bath. Spread the syrupy residue in thin layers upon large clock glasses (1); after 2-3 days, filter off the crystals at the pump, using light petroleum, b.p. 40-60°, to facilitate the transfer from the clock glasses to the sintered glass filter funnel. Spread the crystals on a porous tile to remove traces of oily impurities; the crude *n*-propylmalonic acid has m.p. 95-96°. Spread the filtrate and washings on large clock glasses as before and filter off the solid which crystallises after 1 day. Repeat the process until no further crystals are obtained. Recrystallise all the crystals from hot benzene. The yield of pure *n*-propylmalonic acid, m.p. 96°, is 110 g.

Note.

(1) An alternative procedure is to leave the syrupy residue in a vacuum desiccator over anhydrous calcium chloride and silica gel, and to filter off the successive crops of crystals as they separate. These are washed with light petroleum, b.p. 40-60°, spread on a porous tile and recrystallised.

COGNATE PREPARATIONS

***n*-Butylmalonic acid.** This acid may be similarly prepared from *Ethyl n-Butylmalonate* (Section III,154) and melts at 102° after recrystallisation from benzene.

SOME ALIPHATIC DICARBOXYLIC ACIDS

Malonic acid may be prepared from chloroacetic acid by the following series of reactions (compare *Diethyl Malonate*, Section III,153) :—

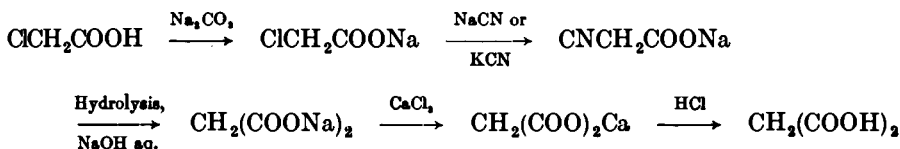

Glutaric acid ($n = 3$), pimelic acid ($n = 5$) and suberic acid ($n = 6$) may be obtained from the corresponding dibromides. These are converted by aqueous-alcoholic potassium or sodium cyanide into the dinitriles, and the latter are smoothly hydrolysed by 50 per cent. sulphuric acid into the dicarboxylic acids :

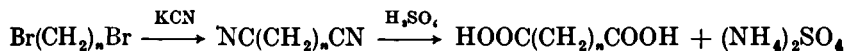

Trimethylene dibromide (Section III,35) is easily prepared from commercial trimethylene glycol, whilst hexamethylene dibromide (1 : 6-dibromohexane) is obtained by the red P - Br₂ reaction upon the glycol ; 1 : 6-hexanediol is prepared by the reduction of diethyl adipate (sodium and alcohol ; lithium aluminium hydride ; or copper-chromium oxide and hydrogen under pressure). Pentamethylene dibromide (1 : 5-dibromopentane) is readily produced by the red P-Br₂ method from the commercially available 1 : 5 pentanediol or tetrahydropyran (Section III,37). Pentamethylene dibromide is also formed by the action of phosphorus pentabromide upon benzoyl piperidine (I) (from benzoyl chloride and piperidine) :

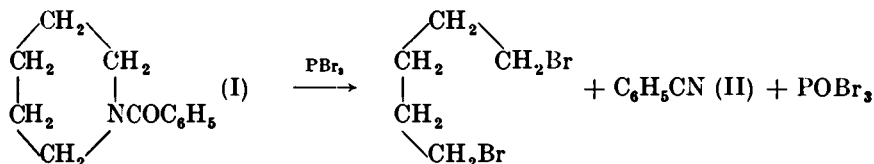
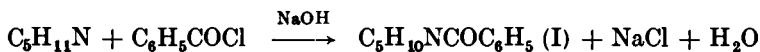

The benzonitrile (II) is removed by treatment with concentrated sulphuric acid.

The oxidation of *cyclopentanone* (Section III,73) with dilute nitric acid gives glutaric acid accompanied by some succinic acid ; the latter is removed as the sparingly-soluble barium salt :

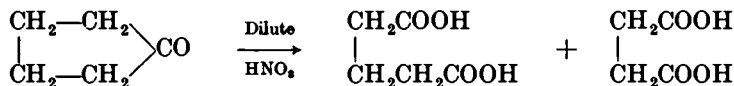

Adipic acid is conveniently prepared by the oxidation of *cyclohexanol* (or *cyclohexanone*) with concentrated or with 50 per cent. nitric acid :

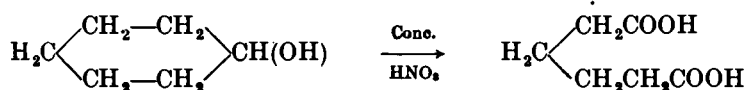

The preparation of *αs*-dimethylsuccinic acid according to the following scheme has a number of points of interest :

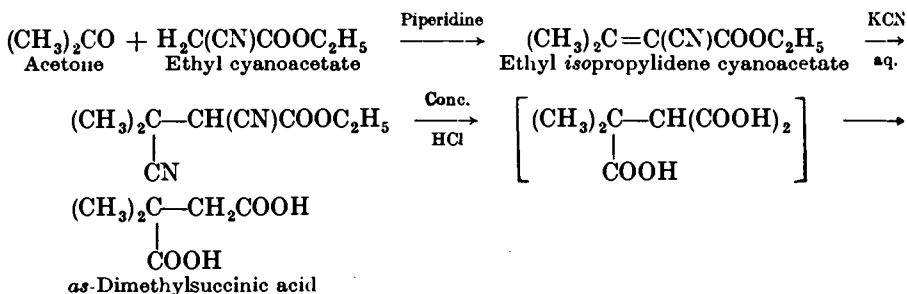

The formation of ethyl isopropylidene cyanoacetate is an example of the **Knoevenagel reaction** (see Discussion before Section IV,123). With higher ketones a mixture of ammonium acetate and acetic acid is an effective catalyst ; the water formed is removed by azeotropic distillation with benzene. The essential step in the reaction with aqueous potassium cyanide is the addition of the cyanide ion to the β-end of the αβ-double bond :

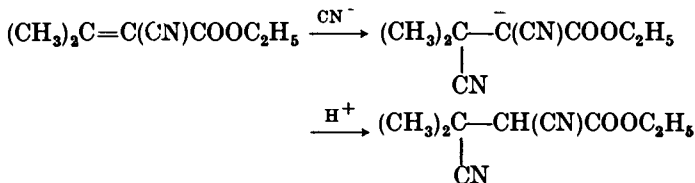

III,157.

MALONIC ACID

Conduct the preparation in the fume cupboard. Dissolve 250 g. of redistilled chloroacetic acid (Section III,125) in 350 ml. of water contained in a 2.5 litre round-bottomed flask. Warm the solution to about 50°, neutralise it by the cautious addition of 145 g. of anhydrous sodium carbonate in small portions ; cool the resulting solution to the laboratory temperature. Dissolve 150 g. of sodium cyanide powder (97–98 per cent. NaCN) in 375 ml. of water at 50–55°, cool to room temperature and add it to the sodium chloroacetate solution ; mix the solutions rapidly and cool in running water to prevent an appreciable rise in temperature. When all the sodium cyanide solution has been introduced, allow the temperature to rise ; when it reaches 95°, add 100 ml. of ice water and repeat the addition, if necessary, until the temperature no longer rises (1). Heat the solution on a water bath for an hour in order to complete the reaction. Cool the solution again to room temperature and slowly dissolve 120 g. of solid sodium hydroxide in it. Heat the solution on a water bath for 4 hours. Evolution of ammonia commences at 60–70° and becomes more vigorous as the temperature rises (2). Slowly add a solution of 300 g. of anhydrous calcium chloride in 900 ml. of water at 40° to the hot sodium malonate solution ; mix the solutions well after each addition. Allow the mixture to stand for 24 hours in order to convert the initial cheese-like precipitate of calcium malonate into a coarsely crystalline form. Decant the supernatant solution and wash the solid by decantation four times with 250 ml. portions of cold water. Filter at the pump,

suck the calcium malonate as dry as possible, and dry in the air or in an electrically-heated oven at 40–50°; the yield is 450 g.

Place the dry calcium malonate in a 2-litre round-bottomed flask, which is surrounded by a freezing mixture of ice and salt. Place 400 ml. of alcohol-free ether (3) in the flask and stir the mixture vigorously with a mechanical stirrer. Add 450 ml. of concentrated hydrochloric acid (4) gradually through a dropping funnel with bent stem. Remove the ether layer, and extract the aqueous solution five times with 150 ml. of ether. Much more satisfactory extraction of the acid is achieved by the use of a continuous extractor (Figs. II, 44, 1 and II, 44, 2) and this procedure is recommended. Dry the ethereal solution with anhydrous sodium or magnesium sulphate and distil off the ether on a water bath. The residue (malonic acid) crystallises and, after drying in the air, melts between 132° and 134° according to the purity of the chloroacetic acid originally employed. The yield is 215 g. This acid is sufficiently pure for most purposes, but if it is required perfectly pure it may be crystallised from benzene-ether containing 5 per cent. of light petroleum (b.p. 60–80°): the m.p. of the pure acid is 136°.

Notes.

(1) If the reaction is allowed to become too vigorous, hydrogen cyanide is liberated and some glycolate is formed.

(2) Most of the ammonia is evolved in about 1 hour. The vapour should be tested periodically for the presence of ammonia with mercurous nitrate paper.* If traces are still present after 3–4 hours, the solution should be steam distilled for 30 minutes.

(3) If the ether contains alcohol, some esterification of the acid may occur during the extraction period.

(4) One ml. of concentrated hydrochloric acid is required for each gram of calcium malonate; the volume should be adjusted in accordance with the yield of the calcium salt.

III,158. GLUTARIC ACID (*from Trimethylene Dicyanide*)

In a 2-litre round-bottomed flask, equipped with a double surface condenser, place 60 g. of trimethylene dicyanide (Section III,114) and 900 g. of 50 per cent. sulphuric acid (by weight). Reflux the mixture for 10 hours and allow to cool. Saturate the solution with ammonium sulphate and extract with four 150 ml. portions of ether; dry the ethereal extracts with anhydrous sodium or magnesium sulphate. Distil off the ether on a water bath; the residual glutaric acid (69 g.) crystallises on cooling and has m.p. 97–97.5°. Upon recrystallisation from chloroform, or benzene, or benzene mixed with 10 per cent. by weight of ether, the m.p. is 97.5–98°.

COGNATE PREPARATIONS

Suberic acid. Prepare hexamethylene dibromide from hexamethylene glycol (Section III,15) according to the procedure described in Section III,35). Convert the 1 : 6-dibromohexane, b.p. 114–115°/12 mm., into hexamethylene dicyanide, b.p. 178–180°/15 mm., by refluxing it with a 20–25 per cent. excess of aqueous-alcoholic sodium cyanide solution (compare Section III,114), distilling off the liquid under diminished

* See A. I. Vogel, *A Text-Book of Macro and Semimicro Qualitative Inorganic Analysis*, Fourth Edition, 1954, Longmans, Green & Co. Ltd.

pressure whilst heating on a water bath, adding water to the residue, and exhaustively extracting with ether: upon evaporating the ether, and distilling the residue under diminished pressure, the dinitrile is obtained.

Heat a mixture of hexamethylene dicyanide with 15 times its weight of 50 per cent. sulphuric acid by weight under reflux for 10 hours. The acid crystallises out on cooling. Filter off the suberic acid upon a sintered glass funnel, and recrystallise it from acetone: m.p. 141–142°. The yield is 90 per cent. of the theoretical.

Pimelic acid. This may be prepared from 1 : 5-pentanediol or tetrahydropyran, through the dibromide (Sections III,35 and III,37) and dinitrile exactly as described for *Suberic Acid*. An alternative method for the preparation of 1 : 5-dibromopentane, together with full details of the subsequent steps, is given in the following Section.

III,159. PIMELIC ACID (*from Benzoyl Piperidine*)

Benzoyl piperidine. In a 1-litre three-necked flask, equipped with a mechanical stirrer, separatory funnel and a thermometer, place 85 g. (99 ml.) of redistilled piperidine (b.p. 105–108°) and a solution of 53 g. of sodium hydroxide in 400 ml. of water. Stir the mixture and introduce during the course of 1 hour 140 g. (115.5 ml.) of redistilled benzoyl chloride: maintain the temperature at 35–40°. Cool to room temperature and extract the benzoyl piperidine with ether. Wash the ethereal solution with a little water to remove any dissolved sodium hydroxide, and dry with anhydrous potassium carbonate. Remove the ether on a water bath and distil the residue under diminished pressure (Fig. II, 20, 1). Collect the benzoyl piperidine at 184–186°/15 mm.; it is an almost colourless viscous liquid and crystallises on standing in colourless needles m.p. 46°. The yield is 170 g.

Pentamethylene dibromide (1 : 5-Dibromopentane). Place 126 g. of benzoyl piperidine in a 500 ml. Claisen flask. Cool in ice and add 182 g. (64 ml.) of phosphorus tribromide (Section II,49,9). Introduce slowly, whilst the flask is cooled in ice, 121 g. (39 ml.) of dry bromine (Section II,49,8); shake the flask after each addition of bromine. Connect the flask for distillation under reduced pressure (Fig. II, 20, 1). Heat the Claisen flask very gently in an air bath (Fig. II, 5, 3) for 30 minutes and then distil so that the liquid passes over very slowly during 1 hour. Remove the air bath and distil with a free flame until no more liquid passes over and a yellow solid (PBr_5) collects in the condenser. Pour the distillate with vigorous stirring into 400 g. of crushed ice and allow to stand in order to decompose the phosphorus oxybromide (1). Dissolve the oil which separates in 600 ml. of light petroleum, b.p. 40–60° (2), which has previously been treated with small portions of concentrated sulphuric acid until the latter remained colourless. Wash the extract with sodium carbonate solution until the latter remains alkaline then wash with a little water. Shake in a separatory funnel with 10 ml. portions of concentrated sulphuric acid until the acid remains practically colourless. Wash the light petroleum extract successively with water, sodium carbonate solution, and water, and dry with anhydrous calcium chloride or anhydrous calcium sulphate. Remove the light petroleum

under atmospheric pressure and distil the residue under reduced pressure. Collect the pentamethylene dibromide at 98–100°/13 mm. The yield is 97 g.

Notes.

(1) The decomposition of the phosphorus oxybromide may also be conducted in a 1-litre three-necked flask charged with 400 g. of finely crushed ice and fitted with a reflux condenser and mechanical stirrer.

(2) The following is a modification of the process described and gives quite satisfactory results. Wash the crude mixture of benzonitrile and dibromopentane with sodium carbonate solution until the latter remains alkaline, and then with water. Distil it under reduced pressure and collect the fraction boiling up to 120°/18 mm. Dissolve this in twice its volume of light petroleum, b.p. 40–60°, which has previously been shaken with small volumes of concentrated sulphuric acid until the acid remains colourless. Shake the solution with 5 per cent. of its volume of concentrated sulphuric acid, allow to settle, and run off the sulphuric acid layer; repeat the extraction until the acid is colourless or almost colourless. Wash successively with water, sodium carbonate solution and water, dry over anhydrous calcium chloride or calcium sulphate, and distil off the solvent. Distil the residue under diminished pressure and collect the 1 : 5-dibromopentane at 98–100°/13 mm.

Pentamethylene dicyanide (1 : 5-Dicyanopentane). In a 500 ml. round-bottomed flask, equipped with a reflux condenser, place a solution of 29 g. of potassium cyanide (or the equivalent quantity of powdered sodium cyanide) in 30 ml. of warm water and add a solution of 45 g. of pentamethylene dibromide in 75 ml. of rectified spirit. Reflux the mixture on a water bath for 8 hours. Remove the solvent under diminished pressure, using a water bath. Extract the residue 4–5 times with 100 ml. portions of ether, dry the combined ethereal extracts with anhydrous calcium chloride or anhydrous calcium sulphate, and distil off the ether under atmospheric pressure. Distil the residue under diminished pressure and collect the pentamethylene dicyanide at 168–170°/15 mm. The yield is 18 g.

Pimelic acid. Heat a mixture of 18 g. of pentamethylene dicyanide and 250 g. of 50 per cent. sulphuric acid by weight in a 750 ml. round-bottomed flask under reflux for 9 hours. Most of the pimelic acid separates from the cold reaction mixture. Filter off the crystalline acid upon a sintered glass funnel. Saturate the filtrate with ammonium sulphate and extract it with three 50 ml. portions of ether. Dissolve the residue on the filter (which is slightly discoloured, but is fairly pure pimelic acid) in the combined ethereal extracts, dry with anhydrous sodium or magnesium sulphate, and remove the ether by distillation. Recrystallise the residual solid acid from benzene containing 5 per cent. of ether. The yield of pure pimelic acid, m.p. 105–106°, is 22 g.

III,160. GLUTARIC ACID (*from cyclopentanone*)

Fit a 3-litre round-bottomed flask with a long reflux condenser and a dropping funnel (1). Place a mixture of 400 ml. of concentrated nitric acid and 600 ml. of water in the flask and heat nearly to boiling. Allow 100 g. (116 ml.) of *cyclopentanone* (Section III,73) to enter the hot acid dropwise, taking care that the first few drops are acted upon by the acid, otherwise an explosion may occur; the addition is complete in 1 hour. Much heat is evolved in the reaction so that the flame beneath the flask must be considerably lowered. Owing to the evolution of nitrous fumes, the reaction should be carried out in the fume cupboard or the fumes

should be passed into a water trap (Fig. II, 8, 1, c). Transfer to a large evaporating dish and evaporate the solution to dryness on a water bath : an oil is obtained, which solidifies on cooling (m.p. 80–85°) and consists of a mixture of glutaric acid (ca. 85 per cent.) and succinic acid (ca. 15 per cent.) (2). Dissolve the mixture in 100 ml. of concentrated ammonia solution (sp. gr. 0.88) and 100 ml. of water, boil to expel the excess of ammonia, and add a slight excess of 40 per cent. barium chloride solution. Filter off the precipitate of barium succinate. Strongly acidify the filtrate with dilute hydrochloric acid and extract with five 100 ml. portions of ether (or until no more glutaric acid is obtained upon evaporating the final ethereal extract) (3). Dry the combined ethereal extracts with anhydrous sodium or magnesium sulphate, and distil off the ether. Recrystallise the cold residue from benzene. The yield of pure glutaric acid, m.p. 97°, is 70 g.

Notes.

(1) The corks are badly attacked by the nitric acid and must be renewed in each run. An asbestos stopper, prepared as described in Section III, 161, can be used repeatedly.

(2) An alternative method of separation consists in treating the dry residue several times with a warm mixture of benzene and ether. The residual solid (about 20 g.) is moderately pure succinic acid, m.p. 183–184°. Upon evaporating the benzene-ether extract, and recrystallising the residue from chloroform or from benzene, about 70 g. of glutaric acid, m.p. 95–96°, are obtained.

(3) A continuous extractor (Fig. II, 44, 2) gives the best results and is recommended.

III, 161.

ADIPIC ACID

Into a 3-litre three-necked flask, fitted with a dropping funnel, a mechanical stirrer (1) and a long reflux condenser, place 1900 ml. (2700 g.) of concentrated nitric acid, sp. gr. 1.42. Since oxides of nitrogen are evolved in the subsequent oxidation, the reaction should be carried out in a fume cupboard, or the oxides of nitrogen are led by a tube from the top of the condenser to a water trap (Fig. II, 8, 1, c). Heat the nitric acid to boiling, set the stirrer in motion, add a few drops of *cyclohexanol* and make certain that these are acted upon by the acid before adding more ; an explosion may result if *cyclohexanol* is allowed to accumulate in the acid. Once the reaction has started, add 500 g. of *cyclohexanol* through the dropping funnel at such a rate that all is introduced in 4–5 hours ; if the addition of the secondary alcohol is too slow, the corks (2), which are attacked by nitrous fumes, may have to be replaced before the operation is complete. Keep the reaction mixture at the boiling point during the addition of the *cyclohexanol* and for a further period of about 15 minutes in order to complete the oxidation. Pour the warm reaction mixture into a beaker ; upon cooling, the adipic acid crystallises. Filter on a large sintered glass funnel, and wash with 200 ml. of cold water. Recrystallise the crude acid from 700 ml. of concentrated nitric acid ; filter and wash as above. The yield of recrystallised adipic acid, m.p. 152°, is 400 g. (3).

Notes

(1) If mechanical stirring is omitted, a 5 or 6 litre flask should be used. Here it is essential that the mixture be vigorously boiled.

(2) Corks are badly attacked and must be renewed in each run. It is preferable to employ asbestos-sodium silicate stoppers, which can be used repeatedly,

and are prepared as follows. Cut thin asbestos paper in strips about 2.5 cm. wide moisten these with water glass solution, and wind the strips round the end of a condenser, etc., until a stopper of the correct size is formed. Assemble the apparatus, coat the stoppers with water glass, and allow to harden overnight.

(3) The scale of this preparation may be considerably reduced, if desired, by obvious modifications of the apparatus.

III,162. *as*-DIMETHYLSUCCINIC ACID

Into a 500 ml. round-bottomed flask, provided with a double surface condenser, place 50 g. (63 ml.) of pure, dry acetone, 50 g. (47 ml.) of ethyl cyanoacetate (Section III,131) and 0.5 g. of piperidine. Allow to stand for 60 hours and heat on a water bath for 2 hours. Treat the cold reaction mixture with 100 ml. of ether, wash with dilute hydrochloric acid, then with water, and dry over anhydrous sodium or magnesium sulphate. Distil under diminished pressure and collect the ethyl *isopropylidene* cyanoacetate (ethyl α -cyano- $\beta\beta$ -dimethylacrylate) at 114–116°/14 mm. (1). The yield is 39 g.

Dissolve 20 g. of the cyano ester in 100 ml. of rectified spirit and add a solution of 19.2 g. of pure potassium cyanide in 40 ml. of water. Allow to stand for 48 hours, then distil off the alcohol on a water bath. Add a large excess of concentrated hydrochloric acid and heat under reflux for 3 hours. Dilute with water, saturate the solution with ammonium sulphate, and extract with four 75 ml. portions of ether. Dry the combined ethereal extracts with anhydrous sodium or magnesium sulphate, and distil off the ether. Recrystallise the residual acid from excess concentrated hydrochloric acid, and dry in the air. The yield of pure *as*-dimethylsuccinic acid, m.p. 141–142°, is 12 g.

Note.

(1) Higher (including *cycloaliphatic*) ketones may be condensed with ethyl cyanoacetate under the following conditions. Mix 0.50 mol of ethyl cyanoacetate, 0.55–0.70 mol of the ketone, 0.02 mol of piperidine and 50 ml. of dry benzene, and heat under reflux for 12–24 hours in an apparatus incorporating an automatic water separator (Fig. III, 126, 1; compare Fig. III, 57, 2). Piperidine may be replaced by a catalyst composed of 7.7 g. (0.1 mol) of ammonium acetate and 24 g. (0.4 mol) of glacial acetic acid. Wash the cold reaction mixture with three 25 ml. portions of 10 per cent. sodium chloride solution, and remove the benzene on a water bath under reduced pressure. Transfer the residue to a 1-litre bottle containing a solution of 65 g. of sodium bisulphite in 250 ml. of water and shake mechanically for 2–6 hours. Dilute the turbid solution, which contains the sodium bisulphite addition compound, with 400 ml. of water, and extract the ethyl cyanoacetate with three 50 ml. portions of benzene. Cool the bisulphite solution in ice, and add dropwise, with mechanical stirring, an ice-cold solution of 28 g. of sodium hydroxide in 110 ml. of water. Extract the regenerated unsaturated ester at once with four 25 ml. portions of benzene, wash the extracts with 50 ml. of 1 per cent. hydrochloric acid, and dry with anhydrous magnesium sulphate. Filter and distil from a Claisen flask with fractionating side arm under reduced pressure; the benzene may be conveniently removed by distilling at atmospheric pressure until the temperature rises to 90°. Diethyl ketone yields ethyl α -cyano- $\beta\beta$ -diethylacrylate {ethyl (1-ethylpropylidene)-cyanoacetate}, b.p. 123–125°/12 mm. or 96–97°/3 mm.; di-*n*-propyl ketone gives ethyl α -cyano- $\beta\beta$ -di-*n*-propylacrylate {ethyl (1-propylbutylidene)-cyanoacetate}, b.p. 136–137°/11 mm. or 116–117°/4 mm. The yield is 60–70 per cent.

The appropriate succinic acid can be prepared by condensation of the unsaturated cyano ester with alcoholic potassium cyanide.

ALIPHATIC SULPHUR COMPOUNDS

Mercaptans (or thio-alcohols or thiols), the sulphur analogues of the alcohols, were formerly prepared by the interaction of an alkyl halide and sodium hydrosulphide in alcoholic solution :

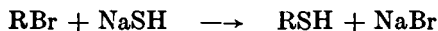

A better method involves the interaction of an alkyl bromide and thiourea to form an alkyl *iso*-thiourea, followed by hydrolysis of the latter with sodium hydroxide solution, for example :

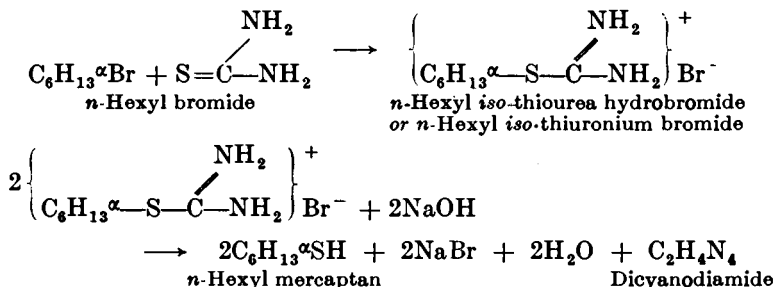

The lower members have remarkably disagreeable odours, but the offensive odour diminishes with increasing carbon content until it almost disappears at about $\text{C}_{10}\text{H}_{21}^\alpha\text{SH}$, *n*-dodecyl (lauryl) mercaptan.

The **alkyl sulphides or thioethers**, the sulphur analogues of the ethers, are conveniently obtained by boiling alkyl halides with anhydrous sodium sulphide in alcoholic solution, for example :

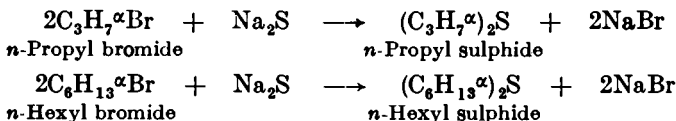

The **dialkyl disulphides** may be prepared by the oxidation of an alkaline solution of a mercaptan with iodine, for example :

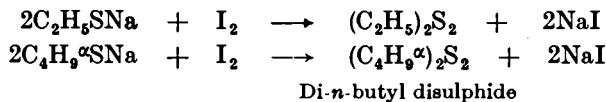

Xanthates (or **xanthogenates**), *e.g.*, CS(OR)SK , are formed by the reaction between carbon disulphide and an alcoholic solution of potassium hydroxide, for example :

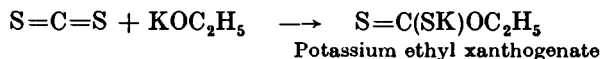

The **xanthates** react with alkyl halides to give the **di-esters of dithiocarbonic acid** $\{\text{O}=\text{C}(\text{SH})_2 \rightleftharpoons \text{S}=\text{C}(\text{SH})\text{OH}\}$, for example :

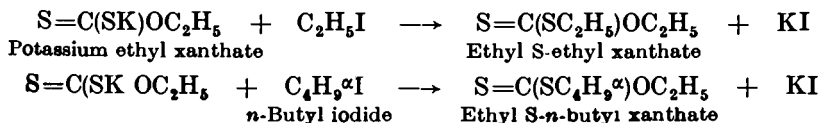

III,163. *n*-HEXYL MERCAPTAN (*n*-HEXYL THIOL)

Into a 500 ml. bolt-head or three-necked flask, equipped with a glycerine-sealed stirrer (Fig. II, 7, 10) and a reflux condenser, place 62.5 g. (53.5 ml.) of *n*-hexyl bromide (Section III,37) and a solution of 38 g. of thiourea (Section III,134) in 25 ml. of water. Connect a tube from the top of the condenser leading to an inverted funnel (Fig. II, 8, 1, a) just immersed in potassium permanganate solution in order to prevent the escape of unpleasant odours. Stir the mixture vigorously and heat under reflux for 2 hours; the mixture becomes homogeneous after about 30 minutes and the additional heating ensures the completeness of the reaction. Add a solution of 30 g. of sodium hydroxide in 300 ml. of water and reflux, with stirring, for a further 2 hours; during this period the mercaptan separates since it is largely insoluble in the alkaline medium. Allow to cool and separate the upper layer of almost pure *n*-hexyl mercaptan (35 g.). Acidify the aqueous layer with a cold solution of 7 ml. of concentrated sulphuric acid in 50 ml. of water, and extract it with 75 ml. of ether. Combine the ethereal extract with the crude thiol, dry with anhydrous magnesium or sodium sulphate, and remove the ether on a water bath. Distil the residue using an air bath (Fig. II, 5, 3) and collect the *n*-hexyl mercaptan at 150–152°. The yield is 37.5 g.

COGNATE PREPARATION

***n*-Butyl mercaptan.** Use 51 g. (40 ml.) of *n*-butyl bromide (Sections III,35 and III,37), 38 g. of thiourea and 25 ml. of water. Reflux, with stirring, for 3 hours; the mixture becomes homogeneous after 1 hour. Allow to cool and separate the upper layer of the mercaptan (*A*). Acidify the aqueous layer with a cold solution of 7 ml. of concentrated sulphuric acid in 50 ml. of water, cool and saturate with salt; remove the upper layer of *n*-butyl mercaptan (*B*) and combine it with (*A*). Extract the aqueous liquid with 75 ml. of ether, dry the ethereal extract with anhydrous sodium or calcium sulphate, and distil off the ether from a water bath through a fractionating column (compare Fig. II, 15, 3). Combine the residue with (*A*) and (*B*), and distil. Collect the *n*-butyl mercaptan at 97–99°. The yield is 24 g.

General remarks on the preparation of mercaptans. The above method is of quite general application. If the bromide is inexpensive, the extraction with ether may be omitted, thus rendering the preparation of thiols a comparatively easy and not unduly unpleasant operation. The following mercaptans may be prepared in yields of the same order as those for *n*-butyl and *n*-hexyl mercaptans: ethyl, b.p. 35–36°; *n*-propyl, b.p. 66–67°; isopropyl, b.p. 51–52°; isobutyl, b.p. 87–88°; *n*-amyl, b.p. 124–125°; *n*-heptyl, b.p. 175–176°; *n*-octyl, b.p. 198–200° or 98–100°/22 mm.; *n*-nonyl, b.p. 220–222° or 98–100°/15 mm.; *n*-decyl, b.p. 96–97°/5 mm. or 114°/13 mm.; *n*-undecyl, b.p. 103–104°/3 mm.; *n*-dodecyl, b.p. 111–112°/3 mm. or 153–155°/24 mm.; *n*-tetradecyl, b.p. 176–180°/22 mm.; benzyl, b.p. 195°.

III,164. DI-*n*-PROPYL SULPHIDE

Place 56 g. of finely-powdered, anhydrous sodium sulphide ("fused" sodium sulphide) and 100 ml. of rectified spirit in a 500 ml. round-bottomed flask equipped with a reflux condenser. To the boiling mixture

add 46 g. (34 ml.) of *n*-propyl bromide (Section III,35) slowly and reflux for 6 hours. Distil off the alcohol on a water bath, and add a large excess of water to the distillate. Separate the upper layer of crude sulphide, wash it with three 40 ml. portions of 5 per cent. sodium hydroxide solution, then with water until the washings are neutral, and dry over anhydrous calcium chloride or anhydrous calcium sulphate. Distil from a 50 ml. Claisen flask and collect the *n*-propyl sulphide at 141–143°. The yield is 20 g. If the sulphide is required perfectly pure, it should be redistilled from a little sodium.

COGNATE PREPARATION

Di-*n*-hexyl sulphide. Use 83 g. (71 ml.) of *n*-hexyl bromide (Section III,37), 56 g. of finely-powdered, anhydrous sodium sulphide and 100 ml. of rectified spirit. Reflux on a water bath for 20 hours. Distil off the alcohol from a water bath; very little sulphide is obtained upon adding excess of water to the distillate. Add excess of water to the residue in the flask and separate the upper layer of crude *n*-hexyl sulphide. Purify as for *n*-propyl sulphide, but distil under reduced pressure. Collect the *n*-hexyl sulphide at 113–114°/4 mm. The yield is 45 g.

III,165.

DIETHYL DISULPHIDE

Fit a 500 ml. three-necked flask with a mechanical stirrer and a double surface condenser. Cool the flask in ice, introduce 38.5 g. (46 ml.) of ethyl mercaptan and 175 ml. of 15 per cent. sodium hydroxide solution, and stir the mixture. When all the mercaptan has reacted, add with constant stirring, 67.5 g. of iodine gradually (during about 2 hours) by momentarily removing the rubber stopper from the third neck of the flask and replacing it immediately the iodine has been introduced. After each addition the iodine gradually disappears and an oily layer forms on the surface of the liquid. Stir the mixture (1) for a further 2.5 hours and allow to stand for 2 hours: transfer to a separatory funnel. Remove the colourless upper layer and extract the aqueous layer with ether. Combine the ethereal extract with the upper layer, wash it with one third of its volume of 15 per cent. sodium hydroxide solution, then twice with water, partially dry it with anhydrous calcium chloride, and remove the ether on a water bath. The resulting colourless liquid usually has a slight odour of mercaptan. Wash it three times with one third of its volume of 5 per cent. sodium hydroxide solution, followed by water until free from alkali, and then dry with anhydrous calcium chloride or anhydrous calcium sulphate. Distil, using an air bath, and collect the diethyl disulphide at 151–152°. The yield is 27 g.

Note.

(1) The mixture should be colourless, otherwise difficulty will be experienced in the subsequent purification of the product. If the reaction mixture is coloured by iodine (due to volatilisation of some of the mercaptan), add just sufficient ethyl mercaptan to decolourise it.

COGNATE PREPARATION

Di-*n*-butyl disulphide. Use 45 g. (53.5 ml.) of *n*-butyl mercaptan (Section III,163), 135 ml. of 15 per cent. sodium hydroxide solution and

55 g. of iodine. The iodine may be dissolved in 40 per cent. potassium iodide solution, if desired. Wash the *colourless* upper layer (see *Note 1* above) three times with one third of its volume of 5 per cent. sodium hydroxide solution, then with water until free from alkali, dry over anhydrous calcium chloride or anhydrous calcium sulphate, and distil under reduced pressure. Collect the di-*n*-butyl disulphide at 84°/3 mm. The yield is 35 g. The b.p. under atmospheric pressure is 230–231°.

III,166. POTASSIUM ETHYL XANTHATE

Into a 500 ml. round-bottomed flask, fitted with a reflux condenser, place 42 g. of potassium hydroxide pellets and 120 g. (152 ml.) of absolute ethyl alcohol. Heat under reflux for 1 hour. Allow to cool and decant the liquid from the residual solid into another dry 500 ml. flask; add 57 g. (45 ml.) of A.R. carbon disulphide slowly and with constant shaking. Filter the resulting almost solid mass, after cooling in ice, on a sintered glass funnel at the pump, and wash it with two 25 ml. portions of ether (sp. gr. 0.720), followed by 25 ml. of anhydrous ether. Dry the potassium ethyl xanthate in a vacuum desiccator over silica gel. The yield is 74 g. If desired, it may be recrystallised from absolute ethyl alcohol, but this is usually unnecessary.

COGNATE PREPARATION

Potassium *n*-butyl xanthate. Use 100 g. (123.5 ml.) of dry *n*-butyl alcohol, 18 g. of potassium hydroxide pellets, and 36 g. (28.5 ml.) of A.R. carbon disulphide. The yield of pure, dry potassium *n*-butyl xanthate $\text{CS}(\text{OC}_4\text{H}_9)_2\text{SK}$, is 42 g.

III,167. ETHYL S-ETHYL XANTHATE

Place 32 g. of potassium ethyl xanthate (Section III,166) and 50 ml. of absolute ethyl alcohol in a 500 ml. round-bottomed flask provided with a double surface condenser. Add 32 g. (16.5 ml.) of ethyl iodide. No reaction appears to take place in the cold. Heat on a water bath for 3 hours: a reaction sets in within 15 minutes and the yellow reaction mixture becomes white owing to the separation of potassium iodide. Add about 150 ml. of water, separate the lower layer, and wash it with water. Dry it with anhydrous calcium chloride or anhydrous calcium sulphate and distil from a 50 ml. Claisen flask. Collect the ethyl S-ethyl xanthate at 196–198°. The yield is 23 g.

COGNATE PREPARATION

Ethyl S-*n*-butyl xanthate. Use 32 g. of potassium ethyl xanthate, 37 g. (23 ml.) of *n*-butyl iodide (Section III,40) and 50 ml. of absolute ethyl alcohol. Reflux on a water bath for 3 hours. Pour into 150 ml. of water, saturate with salt (in order to facilitate the separation of the upper layer), remove the upper xanthate layer, wash it once with 25 ml. of saturated salt solution, and dry with anhydrous calcium chloride or anhydrous calcium sulphate. Distil from a 50 ml. Claisen flask under reduced pressure. Collect the pale yellow ethyl S-*n*-butyl xanthate at 90–91°/4 mm. The yield is 34 g.

III,168. REACTIONS AND CHARACTERISATION OF MERCAPTANS (THIOLS)

Mercaptans RSH (also thioethers or sulphides R'SR" and disulphides R'SSR") are generally liquids and possess unpleasant odours.

Upon fusion with caustic alkali (for experimental details, see Section IV,33,I) and acidification of the aqueous extract, hydrogen sulphide is evolved (detected by lead acetate paper). This test is given by all organic compounds of divalent sulphur (RSH, R'SR" and R'SSR").

Alkyl mercaptans are partly soluble in solutions of caustic alkalis, but their salts are hydrolysed in dilute aqueous solution back to the free mercaptans. Thiophenols are soluble in alkali hydroxide solutions. Upon treatment with sodium, hydrogen is evolved.

CRYSTALLINE DERIVATIVES OF THIOLS

Of the crystalline derivatives of thiols, those formed with 3 : 5-dinitrobenzoyl chloride are not very satisfactory since they have, in general lower melting points than those of the corresponding alcohols (compare Section III,27,I) and do not differ widely from ethyl to *n*-heptyl. The best results are obtained with 2 : 4-dinitrochlorobenzene.

1. Alkyl (or Aryl) 2 : 4-dinitrophenyl-sulphides (or thioethers) and the corresponding sulphones. Mercaptans react with 2 : 4-dinitrochlorobenzene in alkaline solution to yield crystalline thioethers (2 : 4-dinitrophenyl-sulphides) (I) :

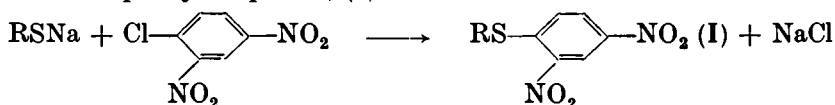

The sulphides (I) can be readily oxidised in glacial acetic acid solution by potassium permanganate to the corresponding sulphones (II) ; the latter exhibit a wide range of melting points and are therefore particularly valuable for the characterisation of mercaptans :

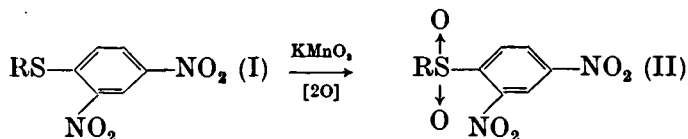

Preparation of 2 : 4-dinitrophenyl-sulphides. Dissolve about 0.5 g. (or 0.005 mol) of the mercaptan in 10–15 ml. of rectified spirit (or in the minimum volume necessary for solution ; warming is permissible) and add 2 ml. of 10 per cent. sodium hydroxide solution. Mix the resulting sodium mercaptide solution with a solution of 1 g. of 2 : 4-dinitrochlorobenzene in 5 ml. of rectified spirit. Reaction may occur immediately with precipitation of the thioether. In any case reflux the mixture for 10 minutes on a water bath in order to ensure the completeness of the reaction. Filter the hot solution rapidly ; allow the solution to cool when the sulphide will crystallise out. Recrystallise from alcohol.

Preparation of the sulphones. Dissolve the 2 : 4-dinitrophenyl-sulphide in the minimum volume of warm glacial acetic acid and add 3 per cent. potassium permanganate solution with shaking as fast as decolourisation occurs. Use a 50 per cent. excess of potassium permanganate : if the sulphide tends to precipitate, add more acetic acid. Just decolourise the solution with sulphur dioxide (or with sodium bisulphite or alcohol) and add 2-3 volumes of crushed ice. Filter off the sulphone, dry, and recrystallise from alcohol.

2. **3 : 5-Dinitrothiobenzoates.** Mercaptans react with 3 : 5-dinitrobenzoyl chloride in the presence of pyridine as a catalyst to yield 3 : 5-dinitrothiobenzoates :

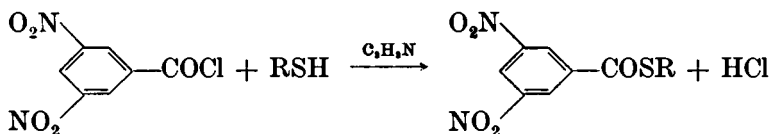

Mix 0.2 g. of 3 : 5-dinitrobenzoyl chloride, 6 drops of the mercaptan and 1-3 drops of pyridine in a test-tube, and heat the mixture in a beaker of boiling water until fumes of hydrogen chloride cease to appear (15-30 minutes). Add a few drops of water, followed by a drop or two of pyridine to eliminate the excess of the reagent. The product solidifies upon stirring with a glass rod. Add water, filter, and recrystallise from dilute alcohol or dilute acetic acid.

The melting points of the derivatives of the more commonly occurring thiols are collected in Table III, 168.

TABLE III,168.

MERCAPTANS (THIOLS)

Mercaptan (Thiol)	B.P.	M.P.	2 : 4-Dinitro-phenyl-thioether	2 : 4-Dinitro-phenyl-sulphone	3 : 5-Dinitro-thio-benzoate
Methyl	6°	—	128°	190°	—
Ethyl	36	—	115	160	62°
<i>n</i> -Propyl	67	—	81	128	52
<i>iso</i> -Propyl	58	—	95	141	84
<i>n</i> -Butyl	97	—	66	92	49
<i>iso</i> -Butyl	88	—	76	106	64
<i>n</i> -Amyl	126	—	80	83	40
<i>iso</i> -Amyl	117	—	59	95	43
<i>n</i> -Hexyl	151	—	74	97	—
<i>n</i> -Heptyl	176	—	82	101	53
<i>n</i> -Octyl	199	—	78	98	—
<i>n</i> -Nonyl	220	—	86	92	—
<i>n</i> -Decyl	114°/13	—	85	93	—
<i>n</i> -Dodecyl (lauryl)	154°/24	—	89	101	—
<i>n</i> -Hexadecyl (cetyl)	—	51°	91	105	—
Allyl	90	—	72	105	—
<i>cyclo</i> Hexyl	159	—	148	172	—
Furfuryl	84°/65	—	130	—	—
Dimethylene di- (1)	146	—	248	—	—
Trimethylene di-	169	—	194	—	—
Pentamethylene di-	123°/27	—	170	—	—
Hexamethylene di-	119°/15	—	218	—	—
Phenyl (thiophenol)	169	—	121	161	149
<i>o</i> -Thiocresol	194	15	101	155	—
<i>m</i> -Thiocresol	195	—	91	145	—
<i>p</i> -Thiocresol	195	44	103	190	—
Benzyl	194	—	130	183	120
α -Phenylethyl	105°/23	—	90	133	—
α -Thionaphthol	161°/20	—	176	—	—
β -Thionaphthol	162°/20	81	145	—	—
Diphenyl	—	111	146	170	—
Thienyl	166	—	119	143	—

(1) Ethylene dithioglycol.

RESOLUTION OF A RACEMIC COMPOUND

III,169. DETERMINATION OF THE ROTATORY POWER

When a beam of light is passed through a crystal of Iceland spar, two beams are transmitted, each vibrating in a plane which is perpendicular to the other. A Nicol prism is composed of two sections of Iceland spar so cut, and again sealed with Canada balsam, that one of the rays is refracted to the side and absorbed so that all the light which passes through is vibrating in one plane only. The light is said to be plane polarized. If this polarized light is examined by means of another Nicol prism, it will be found that on rotating the latter, the field of view appears alternately light and dark and the minimum of brightness follows the maximum as the prism is rotated through an angle of 90° : the field of view will appear dark when the axes of the two prisms are at right angles to one another. The prism by which the light is polarized is termed the polarizer, and the second prism, by which the light is examined, is called the analyzer.

If, when the field of view appears dark, a tube containing a solution of cane sugar (sucrose) is placed between the two prisms, the field lights up; one of the prisms must be turned through a certain angle α before the original dark field is restored. The solution of cane sugar has therefore the power of turning or rotating the plane of polarized light through a certain angle, and is accordingly said to be optically active. Since the plane of vibration of polarized light may be rotated either clockwise or anti-clockwise, it is necessary to observe a convention regarding the sign of rotation. When, in order to obtain darkness, the analyzer has to be turned clockwise (*i.e.*, to the right), the optically active substance is said to be dextro-rotatory; it is laevo-rotatory when the analyzer must be rotated anti-clockwise (*i.e.*, to the left).

The obvious disadvantage of the above simple instrument (polarimeter) is the difficulty of determining the precise "end point" or the point of maximum darkness. The human eye is a poor judge of absolute intensities, but is capable of matching the intensities of two simultaneously viewed fields with great accuracy. For this reason all precision polarimeters are equipped with an optical device that divides the field into two or three adjacent parts (half-shadow or triple-shadow polarimeter) such that when the "end point" is reached the sections of the field become of the same intensity. A very slight rotation of the analyzer will cause one part to become lighter and the other darker. The increase in sensitivity so attained is illustrated by the fact that an accuracy of at least $\pm 0.01^\circ$ is easily obtained with the use of an "end point" device, whereas with the unaided eye the settings are no more accurate than $\pm 4-5^\circ$.

A half-shadow polarimeter (Lippich type) * is illustrated diagrammatically in Fig. III, 169, 1. Here two polarized rays are produced by means of the main Nicol prism *P* and a small Nicol prism *P'*; the latter

* For further details and a description of the triple-shadow polarimeter, see text books of practical physical chemistry, for example, Daniels, Mathews and Williams, *Experimental Physical Chemistry*, 4th Edition, 1949, p. 34 (McGraw-Hill); Findlay and Kitchener, *Practical Physical Chemistry*, 1954, p. 180 (Longmans, Green and Co. Ltd.).

covers half the field of the large polarizer P and its plane of polarization is slightly inclined to that of P . The angles between the planes of polarization may be altered by a slight rotation of the polarizer P . Upon rotating the analyzer A , a position will be found at which one beam will be completely, the other only partially, extinguished; the one half of the

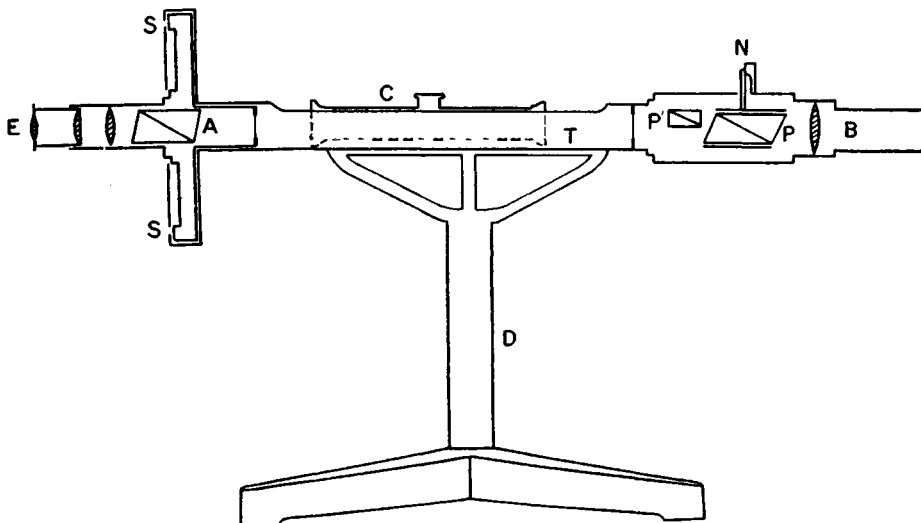

Fig. III, 169, 1.

field of view will therefore appear dark, while the other will still remain light (as in Fig. III, 169, 2, *a*). Upon rotating the analyzer A still further, a second position will be found at which only the second beam will be extinguished and the field will have the appearance shown in (*c*). When, however, the analyzer occupies an intermediate position, the field of view will appear of uniform brightness (as in *b*) and this is the position

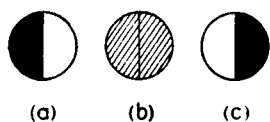

Fig. III, 169, 2.

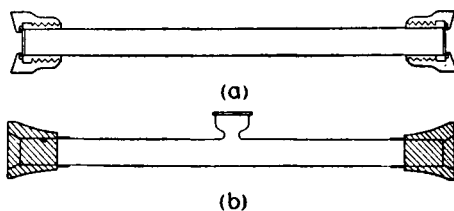

Fig. III, 169, 3.

to which the analyzer must be set. In Fig. III, 169, 1, B is a collimator tube, P the polarizer, P' the subsidiary Nicol prism, N is a device for moving P and thus altering the "half-shadow angle," T the trough (shown without cover) which houses the polarimeter tube C , A is the analyzer, E the eyepiece, S the circular scale fitted with vernier, and D the heavy support stand for the apparatus. Two forms of polarimeter tube are shown in Fig. III, 169, 3. The common type (*a*) consists of a tube of thick glass with accurately ground ends: the tube is closed by

means of circular plates of glass with parallel sides, which are pressed together against the ends of the tube by means of screw caps. The caps must not be screwed so tightly as to cause strain as this would cause a rotation; the glass plates at the end must be clear and the exposed surfaces must be dry. In a modification, the tube is surrounded by a jacket to permit the circulation of water at constant temperature by means of a pump. Tube (b) has the opening at the side. The unit of length in polarimetry is 1 dm., hence the tubes are generally made in lengths which are fractions or multiples of this quantity, [e.g., 0.5, 1, 2 or 4 dm.

The magnitude of the optical rotation depends upon (i) the nature of the substance, (ii) the length of the column of liquid through which the light passes, (iii) the wave length of the light employed, (iv) the temperature, and (v) the concentration of the optically active substance, if a solute. In order to obtain a measure of the rotatory power of a substance, these factors must be taken into account. As a rule the wave length employed is either that for the sodium D line, 5893 Å (obtained with a sodium vapour lamp) or the mercury green line, 5461 Å (produced with a mercury vapour lamp provided with a suitable filter). The temperature selected is 20° or that of the laboratory t° C. The specific rotation for a homogeneous active liquid at a temperature t for the D sodium line is given by :

$$[\alpha]_D^t = \frac{\alpha}{ld}$$

where α is the angular rotation, l is the length of the column of liquid in decimetres and d is the density at temperature t . The specific rotation for a solution of an optically active substance is likewise given by :

$$[\alpha]_D^t = \frac{100\alpha}{lc} = \frac{100\alpha'}{lpd}$$

where l is the length of the column of liquid in decimetres, c is the number of grams of the substance dissolved in 100 ml. of the solution, p is the number of grams of the substance dissolved in 100 g. of the solution and d is the density of the solution at the temperature t . In expressing the specific rotation of a substance in solution, the concentration and the solvent (which has an influence on the rotation) must be clearly stated. The molecular rotation is :

$$[M]_D^t = \frac{[\alpha]_D^t \times M}{100}$$

M is the molecular weight.

III,170. RESOLUTION OF *sec.*-OCTYL ALCOHOL (*dl*-2-OCTANOL) INTO ITS OPTICALLY ACTIVE COMPONENTS (*d*- AND *l*-2-OCTANOL)

sec.-Octyl alcohol {methyl *n*-hexyl carbinol $\text{CH}_3\text{CH}(\text{OH})(\text{CH}_2)_5\text{CH}_3 \equiv \text{C}_8\text{H}_{17}\text{OH}$ } is converted by heating with phthalic anhydride into *sec.*-octyl hydrogen phthalate :



This substance (*dA*, *LA*) contains a free carboxyl group and is treated in warm acetone solution with an equimolecular quantity of the optically active base brucine (*LB*); upon cooling, the brucine salt (*dA*, *LB*) separates out first in a moderately pure condition, whilst the brucine salt (*LA*, *LB*) remains in solution :

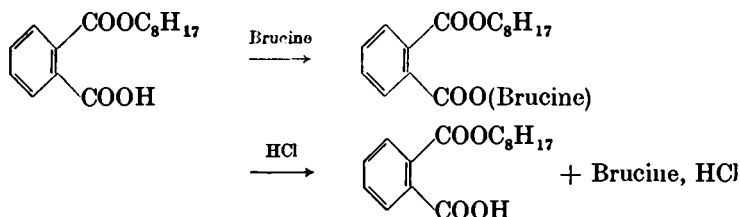

The latter upon decomposition with dilute hydrochloric acid yields *laevo sec.*-octyl hydrogen phthalate: the crystalline brucine salt, when similarly treated, affords the *dextro sec.*-octyl hydrogen phthalate. These are recrystallised and separately hydrolysed with sodium hydroxide solution to yield pure *l*- and *d*-*sec.*-octyl alcohols :

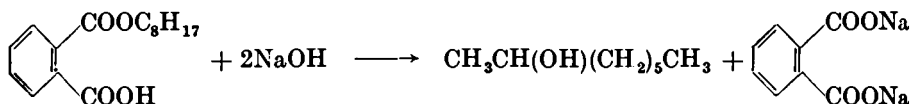

* Heat a mixture of 65 g. of dry *sec.*-octyl alcohol (b.p. 178–180°), 74 g. of pure phthalic anhydride (1) and 40 g. of dry pyridine on a water bath for 1 hour, and allow to cool. Dissolve the resulting viscous mass in an equal volume of acetone. Add slowly, preferably with stirring, 55 ml. of concentrated hydrochloric acid diluted with an approximately equal volume of crushed ice: if an oil separates before all the hydrochloric acid has been added, introduce more acetone to render the mixture homogeneous. Add ice-water until the oil is completely precipitated; this usually sets to a hard mass within 1–2 hours. If the resulting mass is semi-solid or pasty (2), transfer it to a large flask and pass steam through it until the methyl *n*-hexyl ketone is removed, *i.e.*, until the steam distillate is clear; pour the contents of the flask whilst still warm into a beaker. The *dl*-*sec.*-octyl hydrogen phthalate solidifies completely on cooling. Filter the octyl hydrogen phthalate at the pump, wash it with water, grind it thoroughly in a mortar with water, filter again and dry in the air. The crude material is quite satisfactory for the subsequent resolution (3).

Introduce 197 g. of anhydrous brucine or 215 g. of the air-dried dihydrate (4) into a warm solution of 139 g. of *dl*-*sec.*-octyl hydrogen phthalate in 300 ml. of acetone and warm the mixture under reflux on a water bath until the solution is clear. Upon cooling, the brucine salt (*dA*, *LB*) separates as a crystalline solid. Filter this off on a sintered glass funnel, press it well to remove mother liquor, and wash it in the funnel with 125 ml. of acetone. Set the combined filtrate and washings (W) aside. Cover the crystals with acetone and add, slowly and with stirring, a slight excess (to Congo red) of dilute hydrochloric acid (1 : 1 by volume; about 60 ml.); if the solution becomes turbid before the introduction of

* The following experimental details were kindly supplied by Dr. J. Kenyon, F.R.S.

the acid is complete, add more acetone to produce a clear liquid. Add ice-water until the precipitation of the active *sec.*-octyl hydrogen phthalate (crude *dA*) is complete; filter (5), wash with cold water and dry in the air. The yield is about half that of the *dl*-ester originally taken (6).

Concentrate the combined filtrate and washings (W) to about half the original volume, and pour it into slightly more than the calculated amount of dilute hydrochloric acid (use a mixture of 30 ml. of concentrated hydrochloric acid and 30 ml. of ice-water); then add about 300 ml. of water. Collect the active *sec.*-octyl hydrogen phthalate (crude *LA*) as above (5). The weight of the air-dried ester is about half that of the *dl*-ester originally used (7).

Crystallise the two lots of crude active *sec.*-octyl hydrogen phthalates separately twice from 90 per cent. acetic acid; use 2 g. of acetic acid to each gram of solid. The recrystallised esters, if optically pure (8), will melt sharply at 75°; if the melting points are below 75°, further recrystallisation is necessary. The yields of optically pure products, m.p. 75°, are 48 g. and 49 g. respectively.

To obtain optically pure *l*- and *d*-*sec.*-octyl alcohols, steam distil the respective esters with 30 per cent. sodium hydroxide solution; use the proportions 1 mol of ester to 2 mols of sodium hydroxide. Separate the alcohols from the steam distillate, dry over anhydrous potassium carbonate, and distil under diminished pressure. Both samples boil at 86°/20 mm. (9) and have the following rotations:

$$[\alpha]_D^{17^\circ} + 9 \cdot 9^\circ, [\alpha]_{5461}^{17^\circ} + 11 \cdot 8^\circ; [\alpha]_D^{17^\circ} - 9 \cdot 9^\circ, [\alpha]_{5461}^{17^\circ} - 11 \cdot 8^\circ.$$

The yields from the *sec.*-octyl hydrogen phthalates are almost quantitative.

Notes.

(1) If the presence of phthalic acid is suspected, it may be readily removed by mixing with cold chloroform; phthalic anhydride dissolves readily, but the acid is insoluble.

(2) This is due to methyl *n*-hexyl ketone in the original *sec.*-octyl alcohol; it is most easily separated by steam distillation as described.

(3) The inactive *sec.*-octyl hydrogen phthalate may be recrystallised from light petroleum, b.p. 60–80°, or from glacial acetic acid, and then melts at 55°.

If the *sec.*-octyl alcohol is pure, the yield of pure material is almost quantitative.

(4) Commercial brucine is usually the tetrahydrate $C_{22}H_{26}O_4N_2 \cdot 4H_2O$; upon air drying, this loses two molecules of water of crystallisation and passes into the dihydrate.

(5) The filtrates from the decomposition of the brucine salts with dilute hydrochloric acid should be carefully preserved. The brucine is recovered by the addition of an excess of dilute ammonia solution (1 : 4); if the solution becomes turbid before all the ammonia solution is added, introduce a little alcohol until the solution becomes clear. After several hours in an open beaker, filter off the brucine, wash it well with cold water and dry it in the air.

(6) The rotation in absolute alcohol is about $[\alpha]_D + 44^\circ$, $[\alpha]_{5461} + 47^\circ$.

(7) The rotation in absolute alcohol is about $[\alpha]_D - 44^\circ$, $[\alpha]_{5461} - 47^\circ$.

(8) The optically pure salts have rotations in alcohol of $[\alpha]_D - 48 \cdot 4^\circ$, $[\alpha]_{5461} - 58 \cdot 5^\circ$, and $[\alpha]_D + 48 \cdot 4^\circ$, $[\alpha]_{5461} + 58 \cdot 5^\circ$ respectively. A preliminary check of the optical purity is, however, more simply made by a m.p. determination; the rotation is determined, if desired, when the m.p. is 75°.

(9) The boiling point under atmospheric pressure is 179°.

CHAPTER IV

AROMATIC COMPOUNDS

AROMATIC HYDROCARBONS

Aromatic hydrocarbons may be prepared by the following methods :—

1. **Wurtz - Fittig reaction.** The interaction of an aryl halide, alkyl halide and sodium gives a reasonable yield of an alkyl aryl hydrocarbon, for example :



The by-products are $\text{C}_4\text{H}_9^\alpha\text{—C}_4\text{H}_9^\alpha \equiv n\text{-C}_8\text{H}_{18}$, *n*-octane (b.p. 125°) and $\text{C}_6\text{H}_5\text{—C}_6\text{H}_5$, diphenyl (b.p. 254°), and can be readily separated by distillation.

Two *mechanisms* have been proposed for the Wurtz reaction (compare Section III,7) and for the Wurtz-Fittig reaction. According to one, sodium reacts with the alkyl halide to produce a sodium halide and a free radical, which subsequently undergoes coupling, disproportionation, etc. :

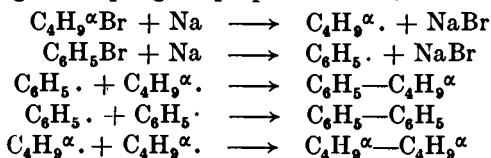

The other mechanism involves the intermediate formation of organosodium compounds :

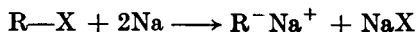

The products from a mixture of alkyl and aryl halides may be represented by the following scheme :

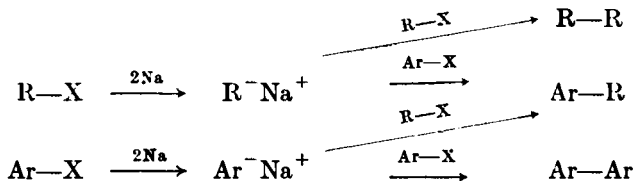

The fact that *n*-butylbenzene can be prepared in reasonable yield by the action of sodium upon a mixture of bromobenzene and *n*-butyl bromide can be partly explained on the assumption that *n*-butyl bromide reacts with phenylsodium more rapidly than does bromobenzene. It is interesting to note that *n*-butylbenzene can be prepared either from benzylsodium and *n*-propyl bromide or from phenylsodium and *n*-butyl bromide (Section VI,29).

2. **Friedel and Crafts reaction.** An alkyl halide condenses with an aromatic hydrocarbon in the presence of anhydrous aluminium chloride to yield, in the first instance, a hydrocarbon in accordance with the following scheme :—

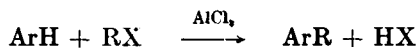

The reaction does not, however, stop at the stage of mono-substitution since the alkylbenzene ArR initially produced undergoes alkylation more easily than the original hydrocarbon ArH : mixtures of substances therefore result and extensive purification is required in order to isolate the mono-substituted compound. Furthermore, alkyl halides, which are capable of isomerisation, are generally isomerised during the condensation; thus *n*-propyl halides and benzene give *iso*-propylbenzene, *n*-butyl halides yield *sec.*-butyl derivatives, etc. Some mono-alkylbenzenes may be prepared by using an excess of the hydrocarbon, which also acts as a diluent in moderating the violence of the reaction and prevents the undue formation of poly-alkylbenzenes, for example:

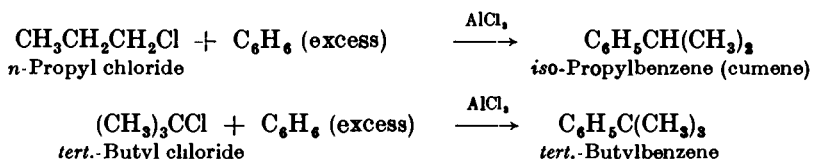

Other catalysts which may be used in the Friedel-Crafts alkylation reaction include ferric chloride, antimony pentachloride, zirconium tetrachloride, boron trifluoride, zinc chloride and hydrogen fluoride but these are generally not so effective in academic laboratories. The alkylating agents include alkyl halides, alcohols and olefines.

The *mechanism* of the reaction is generally considered to proceed by way of carbonium ions (alkyl cations) which attack the aromatic nucleus:

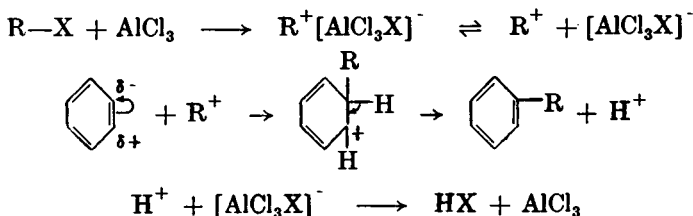

The formation of *isopropylbenzene* when *n*-propyl chloride is employed as the alkylating agent is readily accounted for by the isomerisation of the alkyl carbonium (or alkylum) ion:

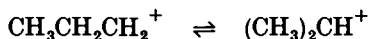

possibly by transfer of a hydride ion from secondary carbon to primary carbonium ion.

Two interesting applications of the Friedel and Crafts reaction to the preparation of aromatic hydrocarbons will be described, *viz.* :—

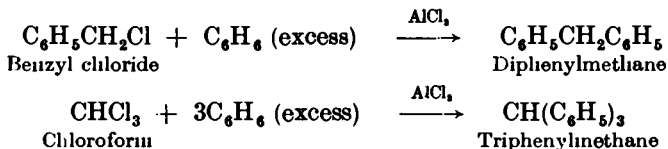

By-products are formed in both preparations: thus in the former, anthracene, and *o*- and *p*-dibenzylbenzenes are present in the fraction of high boiling point. Diphenylmethane is more conveniently obtained by the interaction of benzyl chloride and benzene in the presence of aluminium amalgam:

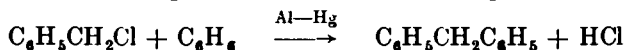

3. **Clemmensen reduction of aldehydes and ketones.** Upon reducing aldehydes or ketones with amalgamated zinc and concentrated hydrochloric acid, the main products are the hydrocarbons ($>C=O \rightarrow >CH_2$), but variable quantities of the secondary alcohols (in the case of ketones) and unsaturated substances are also formed. Examples are :

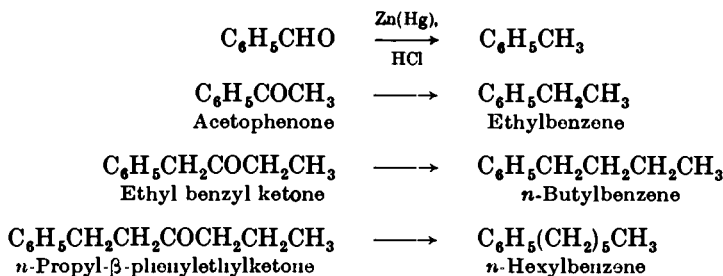

The ketones are readily prepared, for example, acetophenone from benzene, acetyl chloride (or acetic anhydride) and aluminium chloride by the Friedel and Crafts reaction ; ethyl benzyl ketones by passing a mixture of phenylacetic acid and propionic acid over thoria at 450° ; and *n*-propyl- β -phenylethylketone by circulating a mixture of hydrocinnamic acid and *n*-butyric acid over thoria (for further details, see under *Aromatic Ketones*, Sections IV,136, IV,137 and IV,141).

Purely aromatic ketones generally do not give satisfactory results : pinacols and resinous products often predominate. The reduction of ketonic compounds of high molecular weight and very slight solubility is facilitated by the addition of a solvent, such as ethanol, acetic acid or dioxan, which is miscible with aqueous hydrochloric acid. With some carbonyl compounds, notably keto acids, poor yields are obtained even in the presence of ethanol, etc., and the difficulty has been ascribed to the formation of insoluble polymolecular reduction products, which coat the surface of the zinc. The addition of a hydrocarbon solvent, such as toluene, is beneficial because it keeps most of the material out of contact with the zinc and the reduction occurs in the aqueous layer at such high dilution that polymolecular reactions are largely inhibited (see Section IV,143).

4. **Wolff - Kishner reduction of aldehydes and ketones.** Upon heating the hydrazone or semicarbazone of an aldehyde or ketone with potassium hydroxide or with sodium ethoxide solution (sealed tube), the corresponding hydrocarbon is obtained :

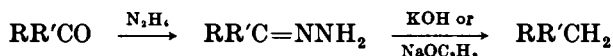

The **Huang - Minlon modification** of the reaction has the following advantages: (i) the actual isolation of the hydrazone is unnecessary, (ii) the reaction time is considerably reduced, (iii) the reaction can be carried out at atmospheric pressure and on a large scale, and (iv) the yields are usually excellent. The hydrazone is first formed *in situ* by refluxing a solution of the carbonyl compound in a moderate amount of diethylene glycol or triethylene glycol with the commercial 85 or 90 per cent. hydrazine hydrate and about 3 equivalents of potassium hydroxide for 1 hour ; the water and excess of hydrazine are removed by distillation until a favourable temperature for the decomposition of the hydrazone is attained (170° - 190°) and the solution is refluxed for 3-5 hours longer.

Allow to cool and add 50 ml. of rectified spirit during 30 minutes through a small separatory funnel fitted into the top of the condenser by means of a grooved cork; introduce a mixture of 25 ml. of rectified spirit and 25 ml. of water during 30 minutes, followed by 50 ml. of water. This treatment will remove the excess of sodium. Reflux the resulting mixture for 2-3 hours. Add 500 ml. of water and filter at the pump from some sludge which is generally present; it is advisable to wash the latter with a little ether. Transfer to a separatory funnel, remove the upper hydrocarbon layer, and wash it successively with 25 ml. of dilute sulphuric acid and 50 ml. of water; dry over anhydrous magnesium or sodium sulphate and distil (50 ml. Claisen flask and air bath, Fig. II, 5, 3). Collect the *n*-butylbenzene at 178-188° (20 g.); an appreciable dark residue containing diphenyl remains in the flask. Upon redistillation, the *n*-butylbenzene boils at 178-184° (1).

Note.

(1) The *n*-butylbenzene contains some unsaturated hydrocarbons: these can be removed by repeated shaking with small quantities of concentrated sulphuric acid (see Section III,7, Note 2).

IV,2. *iso*-PROPYLBENZENE (CUMENE)

Fit a two-litre three-necked flask with a separatory funnel, a mechanical stirrer and a reflux condenser; attach to the top of the condenser a tube leading to an inverted funnel or an adapter dipping just below the surface of a weighed quantity of water in a beaker or flask (compare Fig. II, 13, 8). Place 700 g. (795 ml.) of dry benzene (1) and 20 g. of anhydrous aluminium chloride (2) in the flask, and set the stirrer in motion. Add a mixture of 300 g. (342 ml.) of dry benzene and 100 g. (112.5 ml.) of *n*-propyl chloride (compare Section III,28) or 157 g. (116 ml.) of *n*-propyl bromide (Section III,35) dropwise into the flask. Warm the flask to about 80° on a water bath; the hydrogen halide evolved will be absorbed in the water. When this has increased in weight by 47 g. (104 g. for hydrogen bromide), pour the reaction mixture on to ice, remove the upper layer of hydrocarbon, wash it successively with dilute sodium hydroxide solution and water, and then dry with anhydrous magnesium sulphate. Distil through a well-lagged fractionating column (compare Fig. II, 15, 5 and Fig. II, 16, 1; see Sections II,15-II,17); the excess of benzene passes over first, followed by *iso*-propylbenzene at 151-153°. The yield is 118 g.

Notes.

(1) The moisture present in commercial benzene may be conveniently removed by distilling off about one-tenth of the liquid; the first fraction contains all the moisture. It is generally unnecessary to distil the remaining liquid before use unless the technical benzene is suspected of being highly impure.

(2) The yield of *iso*-propylbenzene is influenced considerably by the quality of the anhydrous aluminium chloride employed. It is recommended that a good grade of technical material be purchased in small bottles containing not more than 100 g. each; undue exposure to the atmosphere, which results in some hydrolysis, is thus avoided. Sealed bottles containing the reagent sometimes have a high internal pressure; they should be wrapped in a dry cloth and opened with care.

IV,3.

tert.-BUTYLBENZENE

Into a 1-litre three-necked flask, equipped as in Section IV,2, place 50 g. of anhydrous aluminium chloride (1) and 200 ml. of dry benzene; cool in a bath of crushed ice. Stir the mixture and add 50 g. (59 ml.) of *tert.*-butyl chloride (Section III,33) from the separatory funnel during 4–5 hours; the first addition should be 3–4 ml. in order to prevent the benzene from freezing. Maintain the mixture at a temperature of 0–5° by the addition of salt to the ice, if necessary. When all the *tert.*-butyl chloride has been run in, continue the stirring for 1 hour longer. Remove the separatory funnel and add 200 g. of finely-crushed ice in small portions with stirring; finally add 100 ml. of cold water to complete the decomposition of the intermediate addition compound. Arrange the flask for steam distillation (Fig. II, 41, 1) and steam distil the resulting reaction mixture. Transfer the steam distillate to a separatory funnel, remove the upper hydrocarbon layer, extract the water layer with two 50 ml. portions of ether, and combine the extracts with the upper layer. Dry with anhydrous magnesium sulphate, distil off the ether on a water bath, and fractionally distil the residue twice, using a well-lagged column (compare Fig. II, 15, 5 and Fig. II, 16, 1). Collect the *tert.*-butylbenzene at 165–170°. The yield is 45 g. Pure *tert.*-butylbenzene boils at 168·5°.

Note.

(1) In an alternative procedure 25 g. of anhydrous ferric chloride replace the aluminium chloride, the mixture is cooled to 10°, and the 50 g. of *tert.*-butyl chloride is added. The mixture is slowly warmed to 25° and maintained at this temperature until no more hydrogen chloride is evolved. The reaction mixture is then washed with dilute hydrochloric acid and with water, dried and fractionally distilled. The yield of *tert.*-butyl benzene, b.p. 167–170°, is 60 g.

IV,4.

DIPHENYLMETHANE

Method A (Friedel and Crafts reaction). Assemble an apparatus (1) consisting of a 500 ml. round-bottomed flask, a two-way addition tube (Fig. II, 1, 8, c) and a reflux condenser (see Fig. II, 13, 9 but with the separatory funnel replaced by a well-fitting cork); attach a water trap to the top of the condenser to absorb the hydrogen chloride produced in the reaction (compare Figs. III, 28, 1 and II, 8, 1). Place 38·5 g. (35 ml.) of redistilled benzyl chloride and 150 ml. of dry benzene (see Section IV,2, Note 1) in the flask. Weigh out 12 g. of anhydrous aluminium chloride (Section IV,2, Note 2) into a dry-stoppered test-tube with the minimum exposure to the atmosphere. Cool the flask in a bath of crushed ice and add about one-fifth of the aluminium chloride. Shake the mixture; a vigorous reaction will set in within a few minutes and hydrogen chloride will be evolved. When the reaction has subsided, add a further portion of the aluminium chloride and repeat the process until all has been introduced. The mixture should be kept well shaken and immersed in a freezing mixture during the addition. Finally reflux the mixture on a water bath for 30 minutes. Allow to cool. Cautiously add 100 g. of crushed ice, followed by 100 ml. of water in order to decompose the aluminium complex. Shake the mixture well, transfer to a separatory funnel, and run off the lower aqueous layer. Wash the upper layer

(benzene solution of diphenylmethane, etc.) successively with dilute hydrochloric acid and water; dry the benzene solution with anhydrous calcium chloride (warming on a water bath is advantageous). Remove the benzene with the aid of the apparatus shown in Fig. II, 13, 4 (50 or 100 ml. distilling flask). Distil the remaining liquid through an air condenser (Fig. II, 13, 2) either with a free flame or from an air bath (Fig. II, 5, 3). Collect the diphenylmethane at 250–275° (the pure substance boils at 262°) (2); there is an appreciable high boiling point residue. The distillate should solidify on cooling in ice and scratching with a glass rod, or by seeding with a crystal of the pure material. If it does not crystallise, redistil from a small flask and collect the fraction of b.p. 255–267°; this generally crystallises on cooling and melts at 24–25°. The yield is 30 g.

Notes.

(1) For preparations on a large scale a three-necked flask, provided with a reflux condenser, a mercury-sealed mechanical stirrer and the addition device shown in Fig. II, 7, 12, c, is recommended.

(2) Alternatively, the distillation may be conducted under diminished pressure; the fraction, b.p. 125–130°/10 mm., is collected. The removal of the benzene must then be conducted in a Claisen flask (compare Fig. II, 13, 4).

Method B (with aluminium amalgam). Assemble the apparatus shown in Fig. II, 13, 9, using a 1500 ml. round-bottomed flask. Place 500 g. (585 ml.) of dry benzene and 2.5 g. of aluminium amalgam (1) in the flask, and 125 g. (114 ml.) of redistilled benzyl chloride in the dropping funnel; insert a calcium chloride (or cotton wool) guard tube into the mouth of the latter. Heat the benzene to boiling on a water bath and remove the apparatus from the bath. Add the benzyl chloride slowly and at such a rate that the solution boils gently; hydrogen chloride is evolved and this may be absorbed by a trap (compare Figs. III, 28, 1 and II, 8, 1) fitted to the top of the condenser. If the reaction is slow in starting, do not add more than about 15 g. of benzyl chloride at first; warm on a water bath until hydrogen chloride is evolved indicating that reaction has set in. When all the benzyl chloride has been introduced (*ca.* 1 hour), heat the reaction mixture on a water bath for about 15 minutes or until the evolution of hydrogen chloride ceases. When cold, decant the benzene solution from the small quantity of tarry matter, wash it successively with 5 per cent. sodium hydroxide solution and water, and dry with anhydrous calcium chloride or magnesium sulphate. Remove the benzene at atmospheric pressure (Fig. II, 13, 4, but with distilling flask replaced by a Claisen flask) and distil the residue under reduced pressure. Collect the following fractions:—(i) up to 125°/10 mm.; (ii) 125–130°/10 mm. (this is the main fraction); and (iii) 130–150°/10 mm. Combine fractions (i) and (iii) and redistil; collect that boiling at 125–130°/10 mm. separately and add it to the fraction (ii). Upon cooling in ice, fraction (ii) (diphenylmethane) crystallises and melts at 24–25°. The yield is 85 g. The pure compound melts at 26–27°.

Note.

(1) The aluminium amalgam is prepared as described in Section II, 50, 12. After washing with water, it should first be washed with methyl alcohol and finally with a little dry benzene.

IV,5.

TRIPHENYLMETHANE

The apparatus required is similar to that described for *Diphenylmethane* (Section IV,4). Place a mixture of 200 g. (230 ml.) of dry benzene and 40 g. (26 ml.) of *dry* chloroform (1) in the flask, and add 35 g. of anhydrous aluminium chloride in portions of about 6 g. at intervals of 5 minutes with constant shaking. The reaction sets in upon the addition of the aluminium chloride and the liquid boils with the evolution of hydrogen chloride. Complete the reaction by refluxing for 30 minutes on a water bath. When cold, pour the contents of the flask very cautiously on to 250 g. of crushed ice and 10 ml. of concentrated hydrochloric acid. Separate the upper benzene layer, dry it with anhydrous calcium chloride or magnesium sulphate, and remove the benzene in a 100 ml. Claisen flask (see Fig. II, 13, 4) at atmospheric pressure. Distil the remaining oil under reduced pressure; use the apparatus shown in Fig. II, 19, 1, and collect the fraction b.p. 190–215°/10 mm. separately. This is crude triphenylmethane and solidifies on cooling. Recrystallise it from about four times its weight of ethyl alcohol (2); the triphenylmethane separates in needles and melts at 92°. The yield is 30 g.

Notes.

(1) The chloroform is dried by leaving it over anhydrous calcium chloride or anhydrous calcium sulphate for about 12 hours.

(2) Triphenylmethane dissolves in about one-third of its weight of warm benzene; it crystallises with one molecule of benzene of crystallisation which is lost on exposure to air or heating on a water bath or by recrystallisation from alcohol.

IV,6.

ETHYLBENZENE

Method A (Clemmensen reduction)

Prepare 200 g. of amalgamated zinc in a 2-litre three-necked flask as detailed in Section II,50, 13. Fit the flask with a reflux condenser, a mercury-sealed stirrer and a gas entry tube reaching to within 1 cm. of the bottom; connect the last-named through an intermediate empty wash bottle to a Kipp's apparatus supplying hydrogen chloride gas (Section II,48, 1). Place a mixture of 500 ml. of concentrated hydrochloric acid and 100 ml. of water in the flask and introduce 100 g. of acetophenone (Section IV, 136). Stir the mixture and pass in a slow stream of hydrogen chloride gas whilst warming the flask on an asbestos-centred wire gauze by means of a small flame. If the reaction becomes unduly vigorous, stop the supply of hydrogen chloride until it subsides somewhat. Most of the zinc dissolves after 6 hours, by which time the reaction is almost complete; allow to stand overnight. Arrange the apparatus for steam distillation (Fig. II, 41, 1) and pass steam into the flask, heated by means of a small flame, until the distillate is clear. Separate the upper hydrocarbon layer, wash it with 5 per cent. sodium hydroxide solution, then with water, and dry over anhydrous magnesium sulphate. Distil from a 100 ml. Claisen flask and collect the ethylbenzene (1) at 134–135°. The yield is 50 g.

Note.

(1) The ethylbenzene contains some unsaturated compounds. These can be removed by repeated shaking with 5 per cent. of the volume of concentrated

sulphuric acid until the latter is colourless or, at most, very pale yellow. The hydrocarbon is then washed with 5 per cent. sodium carbonate solution, then with water, and dried over anhydrous magnesium sulphate. It is then distilled twice from sodium when pure ethylbenzene, b.p. 135° , is obtained.

Unsaturated hydrocarbons are present in nearly all products of the Clemmensen reduction of aromatic ketones and must be removed, if the hydrocarbon is required pure, by the above process. Secondary alcohols, often produced in small amount, are not appreciably steam-volatile.

COGNATE PREPARATIONS

Toluene. Use 200 g. of amalgamated zinc and 100 g. of freshly-distilled benzaldehyde. The yield of toluene, b.p. $109-110^{\circ}$, is 40 g.

***n*-Butylbenzene.** Use 225 g. of amalgamated zinc and 100 g. of ethyl benzyl ketone (Section IV,141). The yield of *n*-butylbenzene, b.p. $180-183^{\circ}$, is 75 g. With 200 g. of amalgamated zinc and 75 g. of butyrophenone, $C_6H_5COCH_2CH_2CH_3$ (Section IV,137), the yield of *n*-butylbenzene, b.p. $181-184^{\circ}$, is 40 g.

***n*-Hexylbenzene.** Use 200 g. of amalgamated zinc and 100 g. of *n*-propyl- β -phenylethylketone (Section IV,141); the yield of crude *n*-hexylbenzene, b.p. $218-230^{\circ}$, is 55 g. This, when purified by treatment with concentrated sulphuric acid and distillation from sodium, yields 40 g. of fairly pure *n*-hexylbenzene, b.p. $220-225^{\circ}$ (mainly $222-224^{\circ}$).

Method B (Huang - Minlon modification of Wolff - Kishner reduction)

Place 36.0 g. of redistilled acetophenone, b.p. 201° (Section IV,136), 300 ml. of diethylene glycol, 30 ml. of 90 per cent. hydrazine hydrate and 40 g. of potassium hydroxide pellets in a 500 ml. Claisen flask provided with a reflux condenser and a thermometer dipping into the liquid (compare Fig. III, 31, 1). Warm the mixture on a boiling water bath until most of the potassium hydroxide has dissolved and then reflux (free flame) for one hour. Arrange the apparatus for distillation and distil until the temperature in the liquid rises to 175° (1); keep the distillate (ca. 50 ml.). Replace the reflux condenser in the flask and continue the refluxing for 3 hours.

Separate the upper hydrocarbon layer from the distillate and extract the aqueous layer twice with 20 ml. portions of ether; dry the combined upper layer and ethereal extracts with anhydrous magnesium sulphate, remove the ether on a water bath, and distil the residue from a 50 ml. Claisen flask. Collect the ethylbenzene at $135-136^{\circ}$; the yield is 20 g. By extracting the syrupy liquid in the reaction flask with three 30 ml. portions of ether, a further 2 g. of ethylbenzene, b.p. 136° , may be obtained.

Note.

(1) The reduction takes place at a comparatively low temperature and is fairly rapid for acetophenone. With higher ketones, the upper layer of the initial distillate should be returned to the contents of the flask and the refluxing continued for 3-5 hours. The reaction mixture and aqueous distillate are then combined, extracted with ether, etc.

IV,7.

n-PROPYLBENZENE

Into a 1500 ml. three-necked flask, equipped with a dropping funnel, a mercury-sealed stirrer and a double surface condenser (the last-named provided at its upper end with a guard tube filled with a mixture of

anhydrous calcium chloride and soda lime in order to prevent the ingress of moisture and carbon dioxide into the apparatus), place 24.3 g. of clean, dry magnesium turnings, 100 ml. of anhydrous ether and a small crystal of iodine (1). Charge the dropping funnel with a solution of 126.5 g. (115 ml.) of freshly distilled benzyl chloride (b.p. 177–179°) in 500 ml. of sodium-dried ether. Allow about 12 ml. of this solution to run into the flask; if the reaction does not commence within a minute or two, partially immerse the flask in a water bath at about 40°. Remove the flask from the bath immediately reaction sets in and commence stirring the mixture. Add the remainder of the benzyl chloride during 30 minutes; control the vigorous reaction by immersing most of the flask in ice water. The reaction usually continues for about 15 minutes after all the benzyl chloride has been introduced, and is completed by refluxing for a further 15 minutes. Add to the vigorously stirred benzyl magnesium chloride solution 308 g. (261 ml.) of diethyl sulphate (see discussion before Section III,49) during 1 hour and cool the flask in ice water if the reaction becomes unduly vigorous; after the addition, continue the stirring with gentle boiling for 15 minutes. Into a large beaker place 500 ml. of water, 500 g. of finely-crushed ice and 100 ml. of concentrated hydrochloric acid and stir mechanically; add the cold reaction mixture from a separatory funnel. Separate the upper ethereal layer and remove the ether by distillation from a water bath through a fractionating column. Pour the residue into 500 ml. of 10 per cent. sodium hydroxide solution in about 50 per cent. ethyl alcohol, and reflux the mixture for one hour to decompose any unaltered diethyl sulphate. Dilute with a large volume of water in order to throw out the hydrocarbon, separate the *n*-propylbenzene and dry it by allowing it to stand over 10 g. of potassium hydroxide pellets overnight. Distil from a little sodium through a well-lagged fractionating column (compare Sections II,15–II,17) and collect the *n*-propylbenzene at 156–159° (2). The yield is 70 g.

Notes.

(1) For further general details on the preparation of the Grignard reagent, see Section III,17.

(2) This contains only a small proportion of unsaturated compounds; these are easily removed by three washings with one tenth of the volume of concentrated sulphuric acid (compare Section III,7, Note 2). The resulting pure *n*-propylbenzene boils at 158–159°.

IV,8.

n-AMYLBENZENE

Prepare a solution of benzyl magnesium chloride in a 2-litre three-necked flask from 24.3 g. of magnesium turnings, 600 ml. of sodium-dried ether and 126.5 g. (115 ml.) of redistilled benzyl chloride; follow the experimental details given under *n*-Propylbenzene (Section IV,7). Cool the flask in running water or in ice water. Place a solution of 456 g. of *n*-butyl-*p*-toluenesulphonate (Section IV,198) in about twice its volume of anhydrous ether in the dropping funnel, and add it slowly with stirring, at such a rate that the ether just boils; a white solid soon forms. The addition is complete after about 2 hours. Pour the reaction product

slowly into a mechanically-stirred mixture of 1 kilo of finely-crushed ice, 1 litre of water and 125 ml. of concentrated hydrochloric acid contained in a 4 or 5-litre beaker; the precipitated magnesium *p*-toluenesulphonate will ultimately pass into solution. Separate the ether layer, extract the aqueous layer with about 250 ml. of ether, and add the extract to the original ether layer. Wash the ethereal solution with about 100 ml. of water and dry it with about 10 g. of anhydrous potassium carbonate. Distil off the ether through a short fractionating column on a water bath; add 5-7 g. of sodium in small pieces to the residue and reflux for about 2 hours (in order to remove any benzyl alcohol formed by the atmospheric oxidation of the benzyl magnesium chloride). Decant the solution and distil from an air bath through a well-lagged and efficient fractionating column (compare Sections II,15-II,17) (1); collect the fraction of b.p. 190-210°. Redistil and collect the *n*-amylbenzene at 198-203°. The yield is 90 g.

Note.

(1) About 20 g. of *n*-butyl chloride, b.p. 76-80°, may be recovered by carefully refractionating the distillate that passes over below 85°.

IV,9. CHARACTERISATION OF AROMATIC HYDROCARBONS

Unlike aliphatic hydrocarbons, aromatic hydrocarbons can be sulphonated and nitrated; they also form characteristic "molecular compounds" with picric acid, styphnic acid and 1:3:5-trinitrobenzene. Many of the reactions of aromatic hydrocarbons will be evident from the following discussion of crystalline derivatives suitable for their characterisation.

1. Picrates. Many aromatic hydrocarbons (and other classes of organic compounds) form molecular compounds with picric acid, for example, naphthalene picrate $C_{10}H_8 \cdot C_6H_2(NO_2)_3OH$. Some picrates, *e.g.*, anthracene picrate, are so unstable as to be decomposed by many, particularly hydroxylic, solvents; they therefore cannot be easily recrystallised. Their preparation may be accomplished in such non-hydroxylic solvents as chloroform, benzene or ether. The picrates of hydrocarbons can be readily separated into their constituents by warming with dilute ammonia solution and filtering (if the hydrocarbon is a solid) through a moist filter paper. The filtrate contains the picric acid as the ammonium salt, and the hydrocarbon is left on the filter paper.

Picrates are usually prepared by mixing solutions of equivalent quantities of the two components in the minimum volume of rectified spirit and allowing to cool; the derivative separates in a crystalline condition. It is filtered off, washed with a little ether, and pressed on a porous tile. If the picrate is stable, it is recrystallised from alcohol, ethyl acetate or ether.

The following are typical experimental details for the preparation of naphthalene picrate. Dissolve 0.1 g. of naphthalene and 0.2 g. of picric acid separately in the minimum volume of hot rectified spirit (about 2 ml.), mix the solutions and allow to cool. Filter and wash with 2 ml. of alcohol. Recrystallise from hot alcohol, ethyl acetate or ether.

2. **Styphnates.** Aromatic hydrocarbons (and also some amines and heterocyclic bases) form 1:1-addition products with styphnic acid (2:4:6-trinitroresorcinol),

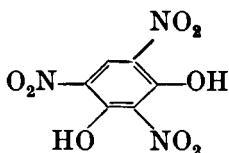

These derivatives do not crystallise quite so well as the corresponding picrates, but are frequently of great value. Benzene and its simple homologues do not give stable derivatives.

Dissolve equimolecular amounts of the hydrocarbon and styphnic acid in the minimum volume of hot acetic acid and allow to cool. Filter off the crystalline derivative which separates, wash it with a little acetic acid and dry in the air. Determine the m.p. Recrystallise from acetic acid and again determine the m.p.

Benzene must be employed as the solvent for anthracene styphnate since most other solvents lead to dissociation.

3. Addition compounds with 1:3:5-trinitrobenzene

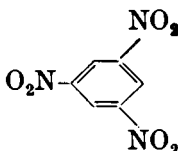

This reagent affords compounds (1:1) with aromatic hydrocarbons and other classes of organic compounds (heterocyclic compounds, aromatic ethers, etc.).

Dissolve equimolecular quantities of the hydrocarbon and 1:3:5-trinitrobenzene in hot alcohol, benzene or glacial acetic acid, and allow to cool. Filter off the solid which separates and recrystallise it from one of these solvents.

4. **Aroylbenzoic acids.** Aromatic hydrocarbons condense with phthalic anhydride in the presence of anhydrous aluminium chloride producing aroylbenzoic acids in good yields:

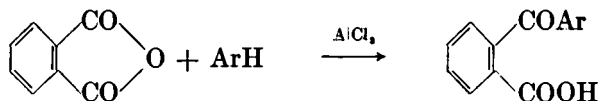

Place a mixture of 1.0 g. of the hydrocarbon, 10 ml. of dry methylene chloride or ethylene dichloride or *sym.*-tetrachloroethane, 2.5 g. of powdered anhydrous aluminium chloride and 1.2 g. of pure phthalic anhydride in a 50 ml. round-bottomed flask fitted with a short reflux condenser. Heat on a water bath for 30 minutes (or until no more hydrogen chloride fumes are evolved), and then cool in ice. Add 10 ml. of concentrated hydrochloric acid cautiously and shake the flask gently for 5 minutes. Filter off the solid at the pump and wash it with 10–15 ml. of cold water. Boil the resulting crude aroylbenzoic acid with 10 ml. of 2.5*N* sodium carbonate solution and 0.2 g. of decolourising carbon for 5 minutes, and filter the hot solution. Cool, add about 10 g. of crushed ice and acidify

to Congo Red with dilute hydrochloric acid (1 : 1 ; 5–6 ml.). Collect the aroylbenzoic acid by suction filtration and recrystallise it from dilute alcohol or from acetic acid. The derivatives prepared from benzene and toluene crystallise with water of crystallisation ; this is removed by drying at 100°.

5. Nitro derivatives. No general experimental details for the preparation of nitro derivatives can be given, as the ease of nitration and the product formed frequently depend upon the exact experimental conditions. Moreover, some organic compounds react violently so that nitrations should always be conducted on a small scale. The derivatives already described are usually more satisfactory : for this reason the nitro derivatives have been omitted from Table IV,9.

Three typical nitrations will, however, be described in order to illustrate the results which may be obtained.

Benzene. Add 0.5 ml. of benzene slowly and with shaking and cooling to a mixture of 4 ml. each of concentrated sulphuric and nitric acids. Heat the mixture carefully until it just boils, cool and pour into excess of cold water. Filter off the precipitate, wash it free from acid and recrystallise it from dilute alcohol. *m*-Dinitrobenzene m.p. 90°, is formed.

Toluene. Proceed as for *Benzene* but use 0.5 ml. of toluene and a mixture of 3 ml. of concentrated sulphuric acid and 2 ml. of fuming nitric acid. Gently warm the mixture over a free flame for 1–2 minutes, cool, and pour into 20 ml. of ice water. Recrystallise the product from dilute alcohol. 2 : 4-Dinitrotoluene, m.p. 71°, is obtained.

Diphenyl. Reflux a mixture of 1 g. of diphenyl, 2 ml. of glacial acetic acid and 0.5 ml. of fuming nitric acid for 10 minutes. Pour into 20 ml. of cold water, filter off the precipitate, wash it with cold water until free from acid, and recrystallise from alcohol. The product is 4-nitrodiphenyl, m.p. 114°.

6. Oxidation of a side chain by alkaline permanganate. Aromatic hydrocarbons containing side chains may be oxidised to the corresponding acids : the results are generally satisfactory for compounds with one side chain (*e.g.*, toluene or ethylbenzene → benzoic acid ; nitrotoluene → nitrobenzoic acid) or with two side chains (*e.g.*, *o*-xylene → phthalic acid).

Suspend in a round-bottomed flask 1 g. of the substance in 75–80 ml. of boiling water to which about 0.5 g. of sodium carbonate crystals have been added, and introduce slowly 4 g. of finely-powdered potassium permanganate. Heat under reflux until the purple colour of the permanganate has disappeared (1–4 hours). Allow the mixture to cool and carefully acidify with dilute sulphuric acid. Heat the mixture under reflux for a further 30 minutes and then cool. Remove any excess of manganese dioxide by the addition of a little sodium bisulphite. Filter the precipitated acid and recrystallise it from a suitable solvent (*e.g.*, benzene, alcohol, dilute alcohol or water). If the acid does not separate from the solution, extract it with ether, benzene or carbon tetrachloride.

Data for a number of typical aromatic hydrocarbons are collected in Table IV,9.

TABLE IV,9.

AROMATIC HYDROCARBONS

Hydrocarbon	B.P.	M.P.	$d_{4}^{20^{\circ}}$	$n_D^{20^{\circ}}$	Picrate	Aroyl- benzole Acid	Compound with 1 : 3 : 5- Trinitro- benzene	Styphnate	Other Derivatives
Benzene	80°	6°	0.879	1.501	—	128°	—	—	<i>m</i> -Dinitro, 90°
Toluene	110	—	0.867	1.497	—	138	—	—	2 : 4-Dinitro, 71
<i>o</i> -Xylene	144	—	0.880	1.505	—	167	—	—	4 : 5-Dinitro, 71
<i>m</i> -Xylene	139	—	0.864	1.497	—	126	—	—	2 : 4 : 6-Trinitro, 182
<i>p</i> -Xylene	138	13	0.861	1.496	—	132	—	—	2 : 3 : 5-Trinitro, 139
Ethylbenzene	135	—	0.868	1.496	97°	128	—	—	2 : 4 : 6-Trinitro, 37
<i>n</i> -Propylbenzene	159	—	0.864	1.493	103	126	—	—	—
<i>iso</i> -Propylbenzene (1)	151	—	0.862	1.491	—	134	—	—	2 : 4 : 6-Trinitro, 109
Pseudo-cumene (2)	169	—	—	1.504	97	—	—	—	3 : 5 : 6-Trinitro, 185
<i>n</i> -Butylbenzene	182	—	0.860	1.490	—	98	—	—	—
<i>sec</i> -Butylbenzene	172	—	0.861	1.490	—	—	—	—	CrO ₃ → C ₆ H ₅ COCH ₃
<i>tert</i> -Butylbenzene	169	—	0.867	1.493	—	—	—	—	2 : 4-Dinitro, 62
<i>n</i> -Amylbenzene	204	—	0.859	1.488	—	—	—	—	Dibromo, 64
Mesitylene (3)	164	—	0.865	1.499	97	212	—	—	—
<i>p</i> -Cymene (4)	177	—	0.857	1.490	—	124	—	—	2 : 6-Dinitro, 54
Durene (5)	193	79	—	—	—	264	—	—	3 : 6-Dinitro, 207
Préhnitene (6)	204	—	0.901	1.523	90	—	—	—	5 : 6-Dibromo, 208
<i>iso</i> -Durene (7)	197	—	0.891	1.513	—	—	—	—	4 : 6-Dinitro, 157
Pentamethylbenzene	231	54	—	—	131	—	121°	—	—
Hexamethylbenzene	264	164	—	—	170	—	174	—	—
<i>cyclo</i> Hexylbenzene	236	7	0.950	1.533	—	—	—	—	4-Nitro, 59
Naphthalene	218	80	—	—	150	173	156	168°	1-Nitro, 61
α -Methylnaphthalene	241	—	1.019	1.618	141	168	—	—	4-Nitro, 71
β -Methylnaphthalene	241	34	—	—	115	190	123	—	1-Nitro, 81
$\alpha\alpha'$ -Dinaphthyl	—	160	—	—	145	—	—	—	—
$\beta\beta'$ -Dinaphthyl	—	188	—	—	184	—	—	—	—

TABLE IV.9.

AROMATIC HYDROCARBONS (continued)

Hydrocarbon	B.P.	M.P.	d_4^{20}	n_D^{20}	Picrate	Aroyl- benzole Acid	Compound with 1:3:5- Trinitro- benzene	Styphnate	Other Derivatives
Diphenyl	255°	70°	—	—	—	226°	—	—	4:4'-Dinitro, 234° ; 4:4'-Dibromo, 164°
Dibenzyl	284	52	—	—	—	—	102°	—	4:4'-Dinitro, 180
Anthracene	340	216	—	—	138°	—	164	180°	Anthraquinone, 286
Phenanthrene	340	100	—	—	143	—	164	142	Phenanthraquinone, 202
Chrysene	—	254	—	—	273	214	186	—	—
Fluorene (8)	294	114	—	—	84	228	105	134	2:7-Dibromo, 165
Retene (9)	390	99	—	—	123	—	139	141	—
Acenaphthene	278	95	—	—	162	200	168	154	5-Nitro, 101
Pyrene	—	150	—	—	222	—	245	191	—
Tetralin (10)	207	—	0.971	1.540	—	154	—	—	5:7-Dinitro, 95
Indene	182	—	0.992	1.576	98	—	102	—	—
Hydrindene	177	—	0.965	1.538	—	—	—	—	—
Styrene (11)	146	—	0.909	1.546	—	—	—	—	—
Stilbene (12)	306	124	—	—	—	—	120	142	—
Diphenylmethane	262	25	—	—	—	—	—	—	2:4:2':4'-Tetra- nitro, 172
Triphenylmethane	358	92	—	—	—	—	—	—	Triphenylcarbinol, 162

(1) Cumene.

(2) 1:2:4-Trimethylbenzene.

(3) 1:3:5-Trimethylbenzene.

(4) 4-*iso*Propyl-1-methylbenzene.

(5) 1:2:4:5-Tetramethylbenzene.

(6) 1:2:3:4-Tetramethylbenzene.

(7) 1:2:3:5-Tetramethylbenzene.

(8) Diphenylenemethane.

(9) 7-*iso*Propyl-1-methylphenanthrene.

(10) 1:2:3:4-Tetrahydronaphthalene.

(11) Phenylethylene.

(12) *trans* 1:2-Diphenylethylene.

NITRATION OF AROMATIC HYDROCARBONS

Aromatic hydrocarbons may be nitrated, *i.e.*, the hydrogen atoms replaced by nitro (NO_2) groups, with concentrated nitric acid in the presence of concentrated sulphuric acid, for example :

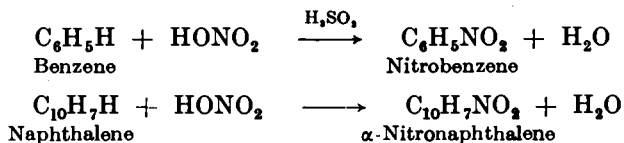

The function of the sulphuric acid is to furnish a strongly acid medium and to convert the nitric acid into the highly reactive nitronium ion NO_2^+ , which is the real nitrating agent :

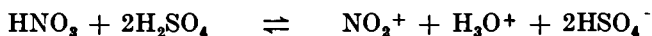

The *mechanism* of the aromatic substitution may involve the attack of the electrophilic NO_2^+ ion upon the nucleophilic aromatic nucleus to produce the carbonium ion (I) ; the latter transfers a proton to the bisulphate ion, the most basic substance in the reaction mixture

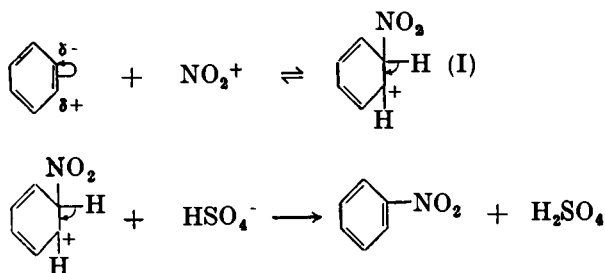

Nitrations are usually carried out at comparatively low temperatures ; at higher temperatures there may be loss of material because of the oxidising action of the nitric acid. For substances which do not nitrate readily with a mixture of concentrated nitric and sulphuric acids ("mixed acid"), the intensity of the reaction may be increased *inter alia* by the use of fuming sulphuric acid (containing up to 60 per cent. of sulphur trioxide) or by fuming nitric acid. Thus nitrobenzene is converted by a mixture of fuming nitric acid and concentrated sulphuric acid into about 90 per cent. of *m*-dinitrobenzene and small amounts of the *o*- and *p*-isomers ; the latter are eliminated in the process of recrystallisation :

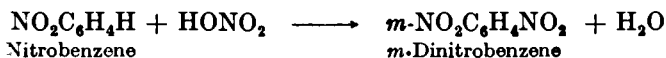

p-Nitrotoluene is similarly converted largely into 2 : 4-dinitrotoluene :



Nitration of bromobenzene with "mixed acid" yields largely *p*-bromonitrobenzene accompanied by a little of the *o*-isomeride :

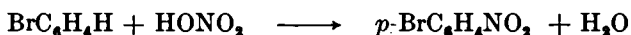

An interesting reaction, which is particularly valuable for the preparation of diphenyl derivatives, consists in heating copper powder or, better, copper bronze with an aryl halide (Ullmann reaction), for example :



The use of dimethylformamide (b.p. 153°) as a solvent and diluent often increases the yield materially. The vigour of the exothermic reaction which occurs with a relatively reactive aryl halide is moderated and, furthermore, the dimethylformamide is easily removed from the reaction product since it is water soluble. Aryl halides which are inert under the usual Ullmann conditions do not react in the presence of dimethylformamide.

A brief account of aromatic substitution may be usefully given here as it will assist the student in predicting the orientation of disubstituted benzene derivatives produced in the different substitution reactions. For the nitration of nitrobenzene the substance must be heated with a mixture of fuming nitric acid and concentrated sulphuric acid : the product is largely *m*-dinitrobenzene (about 90 per cent.), accompanied by a little *o*-dinitrobenzene (about 5 per cent.) which is eliminated in the recrystallisation process. On the other hand phenol can be easily nitrated with dilute nitric acid to yield a mixture of *ortho* and *para* nitrophenols. It may be said, therefore, that orientation is *meta* with the

nitro group and *ortho-para* with the hydroxyl group. The nitro group $\text{—}\overset{+}{\text{N}}=\overset{\ominus}{\text{O}}$ is unsaturated and possesses a positively charged atom in the key position adjacent to the benzene ring, whereas the hydroxyl group is fully saturated. The *meta*-directing nitro group renders substitution more difficult, *i.e.*, exerts a deactivating effect on the aromatic nucleus : the *ortho-para* directive hydroxyl group, however, facilitates substitution, *i.e.*, exerts an activating influence on the aromatic nucleus. Most other substituent groups are sufficiently similar to the types exemplified by the nitro group or the hydroxyl group to justify an empirical classification into *meta* and *ortho-para* directing groups.

The *meta* directing groups include those in which the atom directly attached to the aromatic nucleus is either positively charged or strongly unsaturated. These are, in order of decreasing effectiveness :—

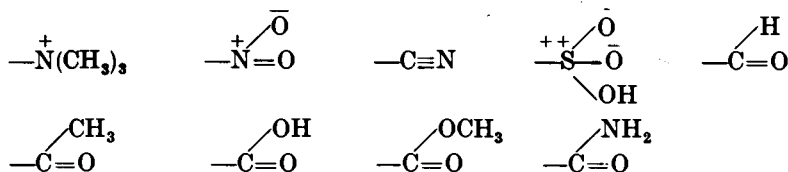

The *ortho-para* directing groups include those which are saturated or only weakly unsaturated at the point of the attachment of the ring. These are ($\text{—N}(\text{CH}_3)_2$, —NH_2 and —OH are by far the most powerful) :—

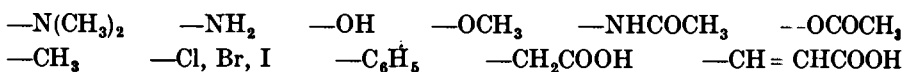

The following rules, relating to the course of aromatic substitution (Hammick and Illingworth, 1930), will be found useful :

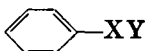
(i) If in a mono-substituted benzene derivative , Y is in a higher group of the periodic table than X, or if, being in the same group, Y is of lower atomic weight than X, then a second atom or group of atoms that enters the nucleus will do so in the *meta* position to the group XY. In all other cases, including that in which the group XY is a single atom, a second entering atom or group goes to the *ortho* and *para* positions.

(ii) The effect of ionic charges on XY is given by the statement that a positive charge directs *meta*, and a negative charge directs *ortho* and *para*.

To apply the above rules, only the following elements need be considered.

Group	I	II	III	IV	V	VI	VII	
	H	Be	B	C	N	O	F	If Y consists solely of hydrogen atoms, (Group I), rule (1) applies; if Y consists partly of hydrogen and partly of another element,
						S	Cl	
							Br	
							I	

both attached to X, then the effect of the hydrogen can usually be neglected and the rules applied to the remaining elements alone.

IV.10.

NITROBENZENE

Place 50 g. (35 ml.) of concentrated nitric acid in a 500 ml. round-bottomed flask, and add, in portions with shaking, 74 g. (40 ml.) of concentrated sulphuric acid. Keep the mixture cool during the addition by immersing the flask in cold water. Place a thermometer (110° range) in the acid mixture. Introduce 26 g. (30 ml.) of benzene in portions of 2-3 ml.; shake the flask well, to ensure thorough mixing, after each addition of the benzene. Do not allow the temperature of the mixture to rise above 55°; immerse the flask, if necessary, in cold water or in ice water. When all the benzene has been added, fit a reflux condenser to the flask and heat it in a water bath maintained at 60° (but not appreciably higher) for 40-45 minutes; remove the flask from time to time from the bath and shake it vigorously to ensure good mixing of the immiscible layers. Pour the contents of the flask into about 500 ml. of cold water in a beaker, stir the mixture well in order to wash out as much acid as possible from the nitrobenzene, and allow to stand. When the nitrobenzene has settled to the bottom, pour off the acid liquor as completely as possible, and transfer the residual liquid to a separatory funnel. Run off the lower layer of nitrobenzene and reject the upper aqueous layer; return the nitrobenzene to the separatory funnel and shake it vigorously with about 50 ml. of water. Separate the nitrobenzene as completely as possible and run it into a small conical flask containing about 5 g. of anhydrous calcium chloride. If the nitrobenzene does not become clear on shaking because of the presence of emulsified water, warm the mixture, with shaking, for a short period on a water bath; the cloudiness will soon disappear. Filter the cold product through a small fluted filter paper into a small (50 or 100 ml.) distilling flask attached to an air condenser (Fig. II, 13, 2). Heat the flask on an asbestos-centred wire gauze or preferably in an air bath (Fig. II, 5, 3) and collect the fraction which boils at 206-211°. Do not distil quite to dryness nor allow the

temperature to rise above 214° , for there may be a residue of *m*-dinitrobenzene and higher nitro compounds and an explosion may result. The yield of nitrobenzene is 35 g. (1). Pure nitrobenzene is a clear, pale yellow liquid, b.p. 210° .

Note.

(1) Nitrobenzene (and many other liquid organic compounds containing nitrogen) is appreciably toxic and its vapour should not be allowed to escape into the atmosphere of the laboratory; the delivery tube of the condenser should pass well into the mouth of the receiver flask. The liquid is also a skin poison; if it is accidentally spilled on the skin, it should be removed by washing with a little methylated spirit, followed by soap and warm water.

IV,11.

α -NITRONAPHTHALENE

Prepare a mixture of 40 ml. of concentrated nitric acid and 40 ml. of concentrated sulphuric acid as detailed in the previous Section. Introduce 50 g. of *finely-powdered* naphthalene in small quantities at a time and with vigorous shaking: maintain the temperature at 45 – 50° and cool in ice water if necessary. When all the naphthalene has been added, warm the mixture on a water bath at 55 – 60° for 30–40 minutes or until the smell of naphthalene has disappeared. Pour the mixture into 500 ml. of cold water; the nitronaphthalene will sink to the bottom. Decant the liquid. Boil the solid cake with 200 ml. of water for 20 minutes and pour the water away. Transfer the oil to a large flask and subject it to steam distillation (Fig. II, 40, 1); any unattacked naphthalene will thus be removed. Pour the warm contents of the flask into a beaker containing a large volume of water which is vigorously stirred. Filter off the granulated α -nitronaphthalene at the pump, press it well, and recrystallise it from dilute alcohol. The yield of α -nitronaphthalene, m.p. 61° , is 60 g.

IV,12.

m-DINITROBENZENE

Place 37.5 g. (21 ml.) of concentrated sulphuric acid and 22.5 g. (15 ml.) of fuming nitric acid, sp. gr. 1.5, in a 250 or 500 ml. round-bottomed flask; add a few fragments of unglazed porcelain or of broken glass. Attach a reflux condenser and place the apparatus in a fume chamber. Add slowly, in portions of about 3 ml., 15 g. (12.5 ml.) of nitrobenzene; after each addition, shake the flask to ensure thorough mixing. Heat the mixture, with frequent shaking, on a boiling water bath; securely clamp both the flask and condenser since the acid fumes usually attack the cork. Allow the mixture to cool somewhat and pour it cautiously with vigorous stirring into about 500 ml. of cold water; the dinitrobenzene soon solidifies. Filter with suction, wash thoroughly with cold water, and allow to drain as completely as possible.

Transfer the crude dinitrobenzene to a 250 ml. flask fitted with a reflux condenser, add 80–100 ml. of methylated (or rectified) spirit and heat on a water bath until all the crystalline solid dissolves. If the resulting solution is not quite clear, filter it through a fluted filter paper on a large funnel which has previously been warmed or through a warm Buchner funnel. Colourless crystals of *m*-dinitrobenzene (15 g.) are deposited on cooling. If the m.p. is below 89 – 90° , recrystallisation is necessary.

IV,13.

2 : 4-DINITROTOLUENE

Place 18 g. (12 ml.) of fuming nitric acid, sp. gr. 1.5, and 30 g. (16.5 ml.) of concentrated sulphuric acid and a few fragments of broken glass in a 250 or 500 ml. round-bottomed flask. Add gradually, in small portions, 14 g. of *p*-nitrotoluene; do not allow the temperature to rise above 50° and cool the flask, if necessary, by immersion in cold water. Place a small funnel in the mouth of the flask and heat on a water bath at 90–95° for 30 minutes. Allow to cool almost to the laboratory temperature and pour the reaction mixture slowly into about 500 ml. of ice water containing a few small pieces of ice. Filter the crude dinitrotoluene through a Buchner funnel at the pump, wash it thoroughly with cold water, and drain as completely as possible. Recrystallise from the minimum volume of hot methyl alcohol (flask, reflux condenser, and water bath; experimental details as in Section IV,12). The yield of pure 2 : 4-dinitrotoluene, m.p. 71°, is 12.5 g.

IV,14.

p-BROMONITROBENZENE

Prepare a mixture of 28.5 g. (20 ml.) of concentrated nitric acid and 37 g. (20 ml.) of concentrated sulphuric acid in a 250 ml. round-bottomed flask (Section IV,10) and cool it to the laboratory temperature. Attach a reflux condenser to the flask. Add 16 g. (10.5 ml.) of bromobenzene (Section IV,18) in portions of 2–3 ml. during about 15 minutes: shake the flask vigorously during the whole process and do not allow the temperature to rise above 50–60° by cooling in running water, if necessary. When the temperature no longer tends to rise owing to the heat of reaction, heat the flask on a boiling water bath for 30 minutes; clamp the flask and condenser securely. Allow to cool to room temperature and pour the reaction mixture with stirring into 200 ml. of cold water. Filter the bromonitrobenzene at the pump, wash well with cold water, and finally drain as far as possible. Recrystallise from 100 to 125 ml. of methylated spirit (flask, reflux condenser and water bath; see Section IV,12). When cold, filter the almost pure *p*-bromonitrobenzene, m.p. 125°. The yield is 14 g. The mother liquor contains the *o*-bromonitrobenzene, contaminated with some of the *p*-isomeride.

IV,15.

2 : 2'-DINITRODIPHENYL

Place 50 g. of *o*-chloronitrobenzene and 75 g. of clean dry sand in a 250 ml. flask equipped with a mechanical stirrer. Heat the mixture in an oil or fusible metal bath to 215–225° and add, during 40 minutes, 50 g. of copper bronze or, better, of activated copper bronze (Section II,50, 4) (1). Maintain the temperature at 215–225° for a further 90 minutes and stir continuously. Pour the hot mixture into a Pyrex beaker containing 125 g. of sand and stir until small lumps are formed; if the reaction mixture is allowed to cool in the flask, it will set to a hard mass, which can only be removed by breaking the flask. Break up the small lumps by powdering in a mortar, and boil them for 10 minutes with two 400 ml.

portions of alcohol; filter after each extraction. Cool the filtered extracts in ice, and collect the crude product on a Buchner funnel. Concentrate the filtrate to about half the original volume and thus obtain a second crop of crystals. The total yield of crude solid should be about 24 g.; if it is less than this, a third extraction of the reaction product should be made. Dissolve the crude solid in about 400 ml. of hot alcohol, add a little decolourising charcoal, boil for a few minutes, filter and cool in ice. Recrystallise again from hot alcohol. The yield of pure 2 : 2'-dinitrodiphenyl, m.p. 123–124°, is 20–22 g. (2).

The experimental conditions for conducting the above reaction in the presence of dimethylformamide as a solvent are as follows. In a 250 ml. three-necked flask, equipped with a reflux condenser and a tantalum wire Hershberg-type stirrer, place 20 g. of *o*-chloronitrobenzene and 100 ml. of dimethylformamide (dried over anhydrous calcium sulphate). Heat the solution to reflux and add 20 g. of activated copper bronze in one portion. Heat under reflux for 4 hours, add another 20 g. portion of copper powder, and continue refluxing for a second 4-hour period. Allow to cool, pour the reaction mixture into 2 litres of water, and filter with suction. Extract the solids with three 200 ml. portions of boiling ethanol: alternatively, use 300 ml. of ethanol in a Soxhlet apparatus. Isolate the 2 : 2'-dinitrodiphenyl from the alcoholic extracts as described above: the yield of product, m.p. 124–125°, is 11.5 g.

Notes.

(1) If the temperature is allowed to rise above 240°, reduction of the nitro groups will occur and carbazole will be formed.

(2) The filtrates should be evaporated to small bulk and the separated solid recrystallised twice from alcohol.

IV,16A. REACTIONS AND CHARACTERISATION OF AROMATIC NITRO COMPOUNDS

Nitro compounds, when liquid, have characteristic odours, are insoluble in water, highly refractive and with a density greater than unity. Many are crystalline solids. Most nitro compounds are slightly coloured, generally yellow; the intensity of the colour increases with the number of nitro groups. The following reactions will assist in their detection.

(i) **Action of alkali.** Provided acidic groups are absent, simple aromatic nitro compounds are practically unaffected by caustic alkalis, but a yellow or orange colour may develop. Aromatic compounds that contain two or more nitro groups in *meta* positions to each other, when treated in alcohol or acetone solution with aqueous alkali, give a red colouration.

(ii) **Reduction to the hydroxylamine.** This is a general test for a nitro group. With a neutral reducing agent, nitro compounds yield the corresponding hydroxylamines (compare Section IV,83), which can be detected by their action upon Tollens's reagent (see Section III,70, (i)):

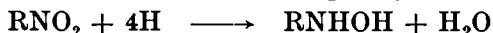

It must be noted, however, that nitroso, azoxy and azo compounds when subjected to the same treatment yield respectively hydroxylamines, hydrazo and hydrazine compounds, all of which reduce ammoniacal silver nitrate solution in the cold.

Dissolve 0.5 g. of the substance in 10 ml. of 50 per cent. alcohol, add 0.5 g. of solid ammonium chloride and about 0.5 g. of zinc powder. Heat the mixture to boiling, and allow the ensuing chemical reaction to proceed for 5 minutes. Filter from the excess of zinc powder, and test the filtrate with Tollen's reagent {Section III,70, (i)}. An immediate black or grey precipitate or a silver mirror indicates the presence of a hydroxylamine formed by reduction of the nitro compound. Alternatively, the filtrate may be warmed with Fehling's solution, when cuprous oxide will be precipitated if a hydroxylamine is present. Make certain that the original compound does not affect the reagent used.

CRYSTALLINE DERIVATIVES

1. Reduction with tin and hydrochloric acid and characterisation of the resulting primary amine. Add 10 ml. of concentrated hydrochloric acid in small portions to a mixture of 1 g. of the compound and 3 g. of granulated tin contained in a small (say, 50 ml.) flask fitted with a reflux condenser. Shake the flask well to ensure thorough mixing during the addition of the acid. After 10 minutes warm under reflux at 100° with vigorous shaking until the nitro compound has dissolved and its odour is no longer apparent. (If the nitro compound dissolves slowly, add a few ml. of alcohol.) Cool the reaction mixture, and cautiously make it alkaline with 20-40 per cent. sodium hydroxide solution. Isolate the liberated amine by steam distillation or by ether extraction. Test a small portion qualitatively for an amine and then identify it as detailed under *Aromatic Amines*, Section IV,100.

2. Oxidation of side chains. Aromatic nitro compounds that contain a side chain (*e.g.*, nitro derivatives of alkyl benzenes) may be oxidised to the corresponding acids either by alkaline potassium permanganate (Section IV,9, 6) or, preferably, with a sodium dichromate - sulphuric acid mixture in which medium the nitro compound is more soluble.

Mix 1 g. of the nitro compound with 4 g. of sodium dichromate and 10 ml. of water in a 50 ml. flask, then attach a reflux condenser to the flask. Add slowly and with shaking 7 ml. of concentrated sulphuric acid. The reaction usually starts at once; if it does not, heat the flask gently to initiate the reaction. When the heat of reaction subsides, boil the mixture, cautiously at first, under reflux for 20-30 minutes. Allow to cool, dilute with 30 ml. of water, and filter off the precipitated acid. Purify the crude acid by extraction with sodium carbonate solution, precipitation with dilute mineral acid, and recrystallisation from hot water, benzene, etc.

A number of selected aromatic nitro compounds are collected in Table IV,16A. It will be noted that a few nitro aromatic esters have been included in the Table. These are given here because the nitro group may be the first functional group to be identified; aromatic nitro esters should be treated as other esters and hydrolysed for final identification.

TABLE IV,16A. AROMATIC NITRO COMPOUNDS

Nitro Compound	B.P.	M.P.	Nitro Compound	B.P.	M.P.
Nitrobenzene (1)	211°	5°	<i>m</i> -Nitrobenzyl cyanide	—	62°
<i>o</i> -Nitrotoluene (2)	222	—	<i>p</i> -Nitrobenzyl cyanide	—	117
<i>m</i> -Nitrotoluene (3)	229	16	<i>o</i> -Nitrobenzyl alcohol	270°	74
<i>p</i> -Nitrotoluene	238	54	<i>m</i> -Nitrobenzyl alcohol	—	27
3-Nitro- <i>o</i> -xylene	240	15	<i>p</i> -Nitrobenzyl alcohol	—	93
4-Nitro- <i>o</i> -xylene	254	30	2 : 4-Dinitrochlorobenzene	315	51
2-Nitro- <i>m</i> -xylene	226	—	2 : 4-Dinitrobromobenzene	—	75
4-Nitro- <i>m</i> -xylene	244	—	2 : 4-Dinitroiodobenzene	—	88
5-Nitro- <i>m</i> -xylene	273	74			
2-Nitro- <i>p</i> -xylene	237	—	<i>o</i> -Nitroanisole	265	10
2-Nitro- <i>p</i> -cymene (4)	264	—	<i>m</i> -Nitroanisole	258	39
Nitroresitylene	255	44	<i>p</i> -Nitroanisole	259	54
			<i>o</i> -Nitrophenetole	267	2
α -Nitronaphthalene	304	61	<i>m</i> -Nitrophenetole	284	34
β -Nitronaphthalene	—	79	<i>p</i> -Nitrophenetole	283	60
2-Nitrodiphenyl	320	37			
4-Nitrodiphenyl	—	114	2 : 4-Dinitroanisole	—	95
<i>o</i> -Dinitrobenzene	—	118	2 : 4-Dinitrophenetole	—	87
<i>m</i> -Dinitrobenzene	—	90	2 : 4 : 6-Trinitroanisole	—	68
<i>p</i> -Dinitrobenzene	—	173	2 : 4 : 6-Trinitrophenetole	—	79
2 : 4-Dinitrotoluene	—	71			
1 : 8-Dinitronaphthalene	—	173	Methyl <i>o</i> -nitrobenzoate	275	—
1 : 5-Dinitronaphthalene	—	217	Methyl <i>m</i> -nitrobenzoate	—	78
2 : 2'-Dinitrodiphenyl	—	124	Methyl <i>p</i> -nitrobenzoate	—	96
4 : 4'-Dinitrodiphenyl	—	236	Ethyl <i>o</i> -nitrobenzoate	—	30
1 : 3 : 5-Trinitrobenzene	—	122	Ethyl <i>m</i> -nitrobenzoate	297	47
2 : 4 : 6-Trinitrotoluene	—	82	Ethyl <i>p</i> -nitrobenzoate	—	57
<i>o</i> -Nitrochlorobenzene	245	33	Methyl <i>o</i> -nitrocinnamate	—	73
<i>m</i> -Nitrochlorobenzene	236	46	Methyl <i>m</i> -nitrocinnamate	—	124
<i>p</i> -Nitrochlorobenzene	242	83	Methyl <i>p</i> -nitrocinnamate	—	161
<i>o</i> -Nitrobromobenzene	261	42	Ethyl <i>o</i> -nitrocinnamate	—	44
<i>m</i> -Nitrobromobenzene	256	56	Ethyl <i>m</i> -nitrocinnamate	—	79
<i>p</i> -Nitrobromobenzene	256	127	Ethyl <i>p</i> -nitrocinnamate	—	142
<i>o</i> -Nitroiodobenzene	—	54	Methyl 3-nitrosalicylate	—	132
<i>m</i> -Nitroiodobenzene	—	38	Ethyl 3-nitrosalicylate	—	118
<i>p</i> -Nitroiodobenzene	—	174	Methyl 5-nitrosalicylate	—	119
2 : 5-Dichloronitrobenzene	267	56	Ethyl 5-nitrosalicylate	—	102
3 : 4-Dichloronitrobenzene	255	43	Dimethyl 3-nitrophthalate	—	69
<i>o</i> -Nitrobenzyl chloride	—	49	Diethyl 3-nitrophthalate	—	46
<i>m</i> -Nitrobenzyl chloride	—	46	Dimethyl 4-nitrophthalate	—	66
<i>p</i> -Nitrobenzyl chloride	—	71	Diethyl 4-nitrophthalate	—	34
<i>o</i> -Nitrobenzyl bromide	—	47	Methyl 3 : 5-dinitrobenzoate	—	112
<i>m</i> -Nitrobenzyl bromide	—	59	Ethyl 3 : 5-dinitrobenzoate	—	94
<i>p</i> -Nitrobenzyl bromide	—	100	Methyl 3 : 5-dinitrosalicylate	—	127
<i>o</i> -Nitrobenzyl iodide	—	75	Ethyl 3 : 5-dinitrosalicylate	—	99
<i>m</i> -Nitrobenzyl iodide	—	86			
<i>p</i> -Nitrobenzyl iodide	—	127	Phenylnitromethane	227	—
<i>o</i> -Nitrobenzyl cyanide	—	84			

(1) d_4^{20} 1.204; n_D^{20} 1.553.(2) d_4^{20} 1.168; n_D^{20} 1.546.(3) d_4^{20} 1.157; n_D^{20} 1.547.(4) d_4^{20} 1.074; n_D^{20} 1.531.

IV,16B. REACTIONS AND CHARACTERISATION OF ALIPHATIC NITRO COMPOUNDS

The following reactions will assist in the detection of aliphatic nitro compounds.

(i) **Action of alkali.** Add a few drops of the nitro compound to 1 ml. of 10 per cent. sodium hydroxide solution ; it dissolves to produce, in general, a yellow solution. Acidify with dilute hydrochloric acid ; the nitro compound is regenerated.

(ii) **Reduction to the hydroxylamine.** This test gives a positive result {see *Aromatic Nitro Compounds*, Section IV,16A, (ii)}.

(iii) **Sodium salt of the aci-form.** Dissolve 0.2 g. of sodium in 5 ml. of anhydrous methanol, and cool to room temperature. Add 0.5 ml. of the nitro compound, shake and cool. Both primary and secondary nitro compounds yield sodium derivatives

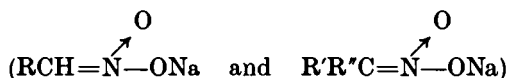

which may be filtered off and washed with methanol to remove traces of sodium methoxide. It should be kept moist with methanol ; the sodium derivative, if allowed to dry, may become very explosive. Also, upon contact with a trace of water, it is liable to decompose with explosive violence. The sodium derivative may be dissolved by successively adding small quantities to cold water with continual stirring.

Add a little of the sodium derivative to about 5 ml. of water in a test-tube, followed by a drop of ferric chloride solution. A deep red colouration is produced but rapidly disappears as the iron is precipitated as ferric hydroxide.

The colouration is due to the production of an acid by partial hydrolysis :

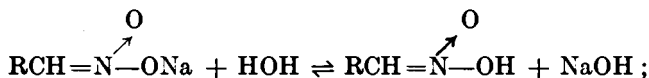

the acid, like many hydroxy compounds (compare *Phenols*, Section IV,114), gives a marked colouration with ferric chloride solution.

(iv) **Distinction between primary, secondary and tertiary aliphatic nitro compounds.** Dissolve a few drops of the nitro compound in concentrated sodium hydroxide solution, and add excess of sodium nitrite solution. Upon cautiously acidifying with dilute sulphuric acid, added a drop at a time, the following effects may be observed :—

(a) **Primary nitro compound :** intense red colour, disappearing upon acidification. The colouration is that of the alkali salt of the nitrolic acid (nitro oxime) —

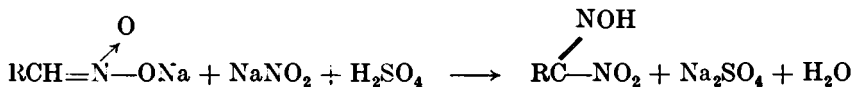

(b) **Secondary nitro compound :** dark blue or blue green colour due to nitro-nitroso derivatives. The coloured compound is soluble in chloroform.

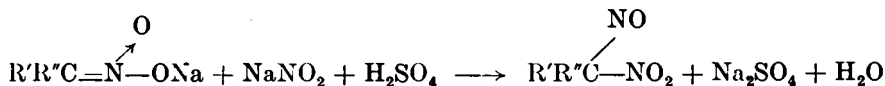

(c) **Tertiary compound :** no colouration.

CHARACTERISATION

Reduction with tin and hydrochloric acid and characterisation

of the primary amine. Experimental details are given in Section IV,16A, 1. The amine is fairly volatile and cannot be diazotised (see Section III,123).

Most aliphatic nitro compounds are liquids: the physical properties (boiling point, density and refractive index) therefore provide valuable information for purposes of identification.

The physical properties of a number of aliphatic nitro compounds are listed in Table IV,16B.

TABLE IV,16B. ALIPHATIC NITRO COMPOUNDS

Nitro Compound	B.P.	d_4^{20}	n_D^{20}
Nitromethane	101°	1·137	1·381
Nitroethane	114	1·050	1·392
1-Nitropropane	131	1·001	1·401
2-Nitropropane	120	0·988	1·394
1-Nitro- <i>n</i> -butane	152	0·971	1·410
1-Nitro- <i>n</i> -pentane	66°/16 mm.	0·953	1·418
1-Nitro- <i>n</i> -hexane	82°/15	0·940	1·423
Phenylnitromethane	227	1·160	1·532

HALOGENATION OF AROMATIC HYDROCARBONS

Benzene and substituted benzenes do not react appreciably with chlorine and bromine in the cold, but in the presence of "halogen carriers," such as aluminium amalgam, pyridine, iodine and iron, reaction takes place readily, affording in the first instance the mono-halogen derivative as the main product. Di-substituted products (largely the *p*-isomeride) are obtained if the proportion of the halogen is increased. The following examples are given :

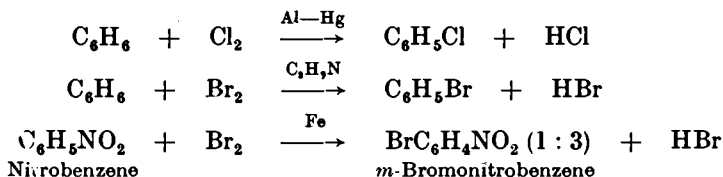

The halogen carriers or aromatic halogenation catalysts are usually all electrophilic reagents (ferric and aluminium halides, etc.) and their function appears to be to increase the electrophilic activity of the halogen. Thus the mechanism for the bromination of benzene in the presence of iron can be represented by the following scheme :

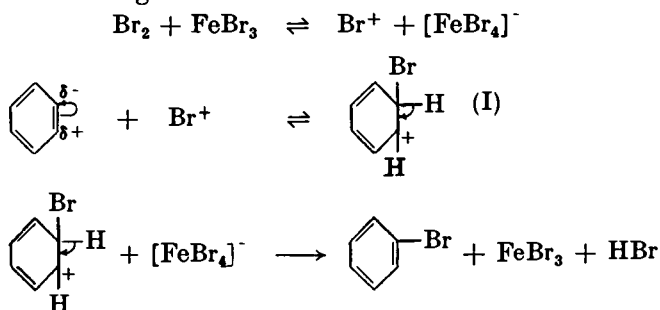

The base $[\text{FeBr}_4]^-$ facilitates the elimination of a proton from the carbonium ion (I).

The reaction must be carried out in the absence of direct sunlight, since sunlight causes direct addition of the halogen to the hydrocarbon, particularly if the latter is warm ; benzene, for example, yields the hexahlide :

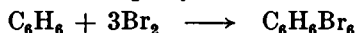

Comparable results are not obtained with the less reactive iodine, because the hydrogen iodide formed tends to reduce the iodo compound and a condition of equilibrium is produced :

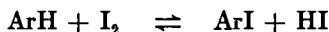

However, if an oxidising agent (fuming nitric acid or sodium persulphate) is present to destroy the hydrogen iodide as it is formed, the equilibrium is displaced and the iodo compound may be conveniently prepared, for example :

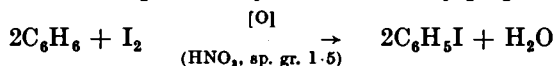

Condensed aromatic hydrocarbons may be brominated directly with bromine in the presence of a solvent, such as carbon tetrachloride :

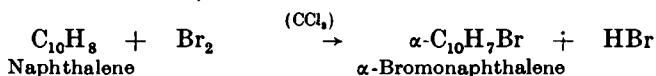

In the absence of catalysts, toluene when treated with chlorine (or bromine) at the boiling point, preferably with exposure to sunlight or other bright light source, undergoes halogenation in the side chain. The entrance of the first chlorine atom, for example, proceeds at a much faster rate than the entrance of the second chlorine atom so that in practice the major portion of the toluene is converted into benzyl chloride before appreciable chlorination of benzyl chloride occurs :



Rapid side-chain chlorination of toluene proceeds in the dark with sulphuryl chloride in the presence of dibenzoyl peroxide (0.001–0.005 mol per mol of SO_2Cl_2) as catalyst :

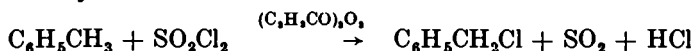

With excess of sulphuryl chloride, benzal chloride is formed, but chlorination does not proceed beyond this stage.

The replacement of a hydrogen atom in an aromatic compound by a chloromethyl ($-\text{CH}_2\text{Cl}$) group in a single operation is termed chloromethylation. The reaction consists essentially in the interaction with formaldehyde and hydrogen chloride in the presence of a catalyst such as zinc chloride or aluminium chloride (Blanc chloromethylation reaction). Thus benzyl chloride, accompanied by a little *p*-xylylene dichloride, m.p. 100° , may be obtained in good yield by passing hydrogen chloride gas into a suspension of paraformaldehyde and anhydrous zinc chloride in benzene. The paraformaldehyde depolymerises under the influence of the hydrogen chloride and the formaldehyde probably condenses as the addition product with hydrogen chloride HOCH_2Cl :

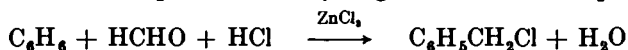

The formaldehyde may be replaced by methylal $\text{CH}_2(\text{OCH}_3)_2$ or by chloromethyl ether $\text{CH}_3\text{OCH}_2\text{Cl}$, produced from paraformaldehyde, hydrogen chloride and methyl alcohol :



Monoalkyl benzene derivatives yield *para* chloromethyl compounds, frequently accompanied by small amounts of the *ortho* isomeride. The reaction is similar in some respects to that of Friedel and Crafts. Chloromethylation is of great value in synthetic work as the $-\text{CH}_2\text{Cl}$ group can be converted into other groups such as $-\text{CH}_2\text{OH}$, $-\text{CHO}$, $-\text{CH}_2\text{OR}$, $-\text{CH}_2\text{CN}$, $-\text{CH}_2\text{CH}(\text{COOC}_2\text{H}_5)_2$ and $-\text{CH}_3$.

It is convenient to describe here certain polyvalent iodine compounds, formed by such substances as iodobenzene and *p*-iodotoluene. Iodobenzene in chloroform solution reacts readily with chlorine to form iodobenzene dichloride (*phenyl iododichloride*) (I) :

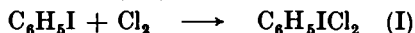

This is converted by aqueous sodium hydroxide into iodobenzene (II) :

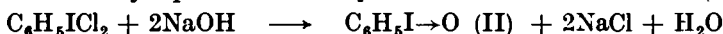

Iodobenzene undergoes a slow change on keeping; this change can be accelerated by heat and consists in a disproportionation to iodoxybenzene (III) and iodobenzene :

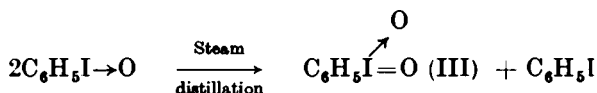

In practice, the iodosobenzene is steam distilled; pure iodobenzene is thus removed as formed.

The interaction of iodosobenzene and iodoxybenzene in the presence of aqueous sodium hydroxide yields the soluble diphenyliodonium iodate (IV); upon adding potassium iodide solution, the sparingly soluble diphenyliodonium iodide (V), analogous to ammonium iodide is precipitated:

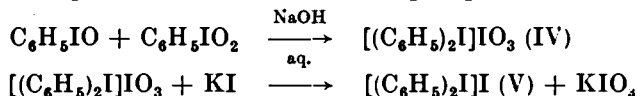

IV,17.

CHLOROBENZENE

Into a 500 ml. bolt-head flask,* provided with an inlet tube (1) extending to within 1 cm. of the bottom and a reflux (double surface) condenser connected with a device (Fig. II,8, 1) for absorbing the hydrogen chloride gas subsequently evolved, place 220 g. (250 ml.) of sodium-dried A.R. benzene and 0.5 g. of aluminium amalgam (2). Weigh the flask and contents. Immediately pass in dry chlorine from a cylinder, preferably through an intermediate empty wash bottle. An exothermic reaction occurs and much hydrogen chloride is evolved. Cool the flask by immersion in a bath of cold water and allow the chlorination to proceed until the liquid has increased in weight by 85 g. Pour the liquid into about 250 ml. of cold water, separate the lower layer of chlorobenzene, and wash it successively with dilute sodium hydroxide solution and water; dry with anhydrous calcium chloride or anhydrous magnesium sulphate. Distil, using a well-lagged fractionating column (e.g., Fig. II, 16, 1), and collect the fraction b.p. 127–135° (3). Redistil and collect the pure chlorobenzene at 131–132°. The yield is about 155 g.

Notes.

(1) A gas distribution tube, provided with a sintered glass plate at its lower end is to be preferred.

(2) Prepared as described in Section IV,4, *Method B, Note 1*.

(3) The high boiling point residue contains *p*- (b.p. 173°, m.p. 53°) and *o*-dichlorobenzene (b.p. 179°), which may be separated, upon cooling in ice, the moderately pure solid *para* isomer separates out.

IV,18.

BROMOBENZENE

Place 50 g. (57 ml.) of dry A.R. benzene and 0.5 ml. of dry pyridine (1) (dried over potassium hydroxide pellets) in a 500 ml. round-bottomed flask. Attach a reflux condenser to the flask and an inverted funnel (just dipping into some water in a beaker) to the top of the condenser (Fig. II, 13, 8, b). Partially immerse the flask in a bath of cold water, supported upon a tripod and gauze. Carefully pour 125 g. (40 ml.) of bromine (for precautions to be taken with bromine, see Section III,35, *Note 1*) through a condenser and immediately insert the absorption device into the upper end of the condenser. A vigorous reaction soon occurs and hydrogen bromide is evolved which is absorbed by the water in the beaker; when the reaction slackens, warm the bath to 25–30° for

* Also termed a wide-necked flask or round-bottomed flask with short ring neck (Pyrex). A three-necked flask may also be used and the obvious modifications made.

1 hour. Finally raise the temperature of the bath to 65–70° for a further 45 minutes or until all the bromine has disappeared (no red vapours visible) and the evolution of hydrogen bromide has almost ceased. Keep the solution of hydrogen bromide in the beaker (2).

Two methods are available for isolating the pure bromobenzene.

Method 1. Arrange the flask containing the reaction mixture for steam distillation as in Fig. II, 40, 1. Proceed with the steam distillation until crystals of *p*-dibromobenzene appear in the condenser. Change the receiver and continue with the distillation until all the *p*-dibromobenzene has passed over; from time to time run out the water from the condenser so that the crystals melt and run down into the receiver. Reject the residue in the flask. Transfer the first distillate to a separatory funnel, wash it with a little water, and dry the lower layer with a little anhydrous magnesium sulphate or anhydrous calcium chloride: filter. Distil slowly from a small distilling flask; use a wire gauze or an air bath (Fig. II, 5, 3). Collect the fraction which passes over at 150–170°; pour the residue (R), while it is still hot, into a small beaker or porcelain basin for the isolation of *p*-dibromobenzene. Redistil the fraction of b.p. 150–170° and collect the bromobenzene at 154–157° (3). The yield is 60 g.

To isolate pure *p*-dibromobenzene, filter the second portion of the steam distillate through a small Buchner funnel with suction; press the crystals as dry as possible. Combine these crystals with the residue (R) and recrystallise from hot ethyl alcohol (for experimental details, see Section IV, 12) with the addition of 1–2 g. of decolourising charcoal; use about 4 ml. of alcohol (methylated spirit) for each gram of material. Filter the hot solution through a fluted filter paper, cool in ice, and filter the crystals at the pump. The yield of *p*-dibromobenzene, m.p. 89°, is about 12 g.

Method 2. Transfer the dark-coloured reaction product to a separatory funnel and shake successively with water, with sufficient 5–10 per cent. sodium hydroxide solution to ensure that the washings are alkaline to litmus, and finally with water. Dry with anhydrous magnesium sulphate or calcium chloride. Filter through a fluted filter paper into a small distilling flask and distil slowly. Collect the crude bromobenzene at 150–170°; pour the residue whilst still hot into a small porcelain basin. Redistil the liquid of b.p. 150–170° (3) and collect the bromobenzene at 154–157°; the yield is about 60 g.

Isolate the pure *p*-dibromobenzene from the residue in the basin by the procedure described in *Method 1*. The yield is about 10 g.

Notes.

(1) Other halogen carriers may be used, e.g., 1–2 g. of iron filings, or 1 g. of aluminium amalgam. The bromine must then be added slowly from a dropping funnel to the benzene warmed on a water bath; the apparatus shown in Fig. II, 13, 9 is suitable and a trap for the hydrogen bromide must, however, be inserted into the top of the condenser. After all the bromine has been introduced, the mixture is heated on a water bath until no red vapours are visible above the liquid. The subsequent procedure is as above.

(2) This solution should be returned to the storeroom for subsequent recovery as constant boiling point hydrobromic acid. If time permits the students should carry out this operation. Distil slowly from a distilling flask and when the tem-

perature rises to 126°, collect the constant boiling point acid. This contains 48 per cent of HBr and is a useful reagent in the laboratory.

(3) The best results are obtained by distillation from a small flask through a short fractionating column: a Hempel column filled with glass rings (Fig. II, 16, 1) and lagged with asbestos cloth or several thicknesses of linen cloth is quite satisfactory.

IV,19.

m-BROMONITROBENZENE

Equip a 1-litre three-necked flask with a separatory funnel, a mercury-sealed mechanical stirrer (1) and a double surface reflux condenser carrying an outlet tube connected to a gas trap (Fig. II, 8, 1). Make all joints with asbestos paper-sodium silicate stoppers (Section III,161, Note 2); moderately satisfactory results may be obtained by employing "old" rubber stoppers. Support the flask in an oil bath. Place 90 g. (75 ml.) of dry, freshly-distilled nitrobenzene in the flask. Weigh out 10 g. of iron powder, "reduced by hydrogen" ("ferrum reductum"). Heat the oil bath to 135-145° and introduce 3 g. of the iron powder by temporarily removing the separatory funnel. Into the latter place 62.5 g. (20 ml.) of dry bromine (Section II,49, 8) and run it into the flask at such a rate that bromine vapours do not rise appreciably in the condenser (ca. 20 minutes). Continue stirring and heating for 1 hour before adding a further 3 g. of iron powder and 20 ml. of dry bromine in a similar manner. Stir for a further hour, add another 3 g. of iron powder and 20 ml. of bromine. When there is no more bromine vapour in the condenser, make a final addition of 1 g. of iron powder and heat for 1 hour longer.

Pour the resulting dark reddish-brown liquid into 500 ml. of water to which 17 ml. of saturated sodium bisulphite solution has been added (the latter to remove the excess of bromine). Steam distil the resulting mixture (Fig. II, 41, 1); collect the first portion of the distillate, which contains a little unchanged nitrobenzene, separately. Collect about 4 litres of distillate. Filter the yellow crystalline solid at the pump, and press well to remove the adhering liquid. The resulting crude *m*-bromonitrobenzene, m.p. 51-52°, weighs 110 g. If required pure, distil under reduced pressure (Fig. II, 19, 1) and collect the fraction of b.p. 117-118°/9 mm.; it then melts at 56° and the recovery is about 85 per cent.

Note.

(1) Mechanical stirring, although not essential and replaceable by occasional shaking by hand, is advantageous.

IV,20.

α -BROMONAPHTHALENE

Use a 500 ml. three-necked flask equipped as in Section IV,19, but mounted on a water bath. Place 128 g. of naphthalene and 45 ml. of dry carbon tetrachloride in the flask, and 177 g. (55 ml.) of bromine in the separatory funnel. Heat the mixture to gentle boiling and run in the bromine at such a rate that little, if any, of it is carried over with the hydrogen bromide into the trap; this requires about 3 hours. Warm gently, with stirring, for a further 2 hours or until the evolution of hydrogen bromide ceases. Replace the reflux condenser by a condenser set for downward distillation, stir, and distil off the carbon tetrachloride as completely as possible. Mix the residue with 8 g. of sodium

hydroxide pellets and stir at 90–100° for 3 hours; this treatment will remove impurities which gradually evolve hydrogen bromide. Transfer the liquid to a Claisen flask with fractionating side arm (Figs. II, 24, 2–5) and distil under diminished pressure. Collect the following fractions:— (i) up to 131°/12 mm. (or 144°/20 mm.); (ii) 132–135°/12 mm. (or 145–148°/20 mm.); and (iii) above 135°/12 mm. (or 148°/20 mm.). Fraction (ii) is almost pure α -bromonaphthalene. Fraction (i) contains unchanged naphthalene, whilst (iii) contains dibromonaphthalene. Cool fraction (i) in ice when most of the naphthalene will crystallise out; filter this off on a sintered glass funnel, combine the filtrate with fraction (iii), redistil and collect the α -bromonaphthalene fraction separately. The total yield of colourless product is 150 g.

IV,21.

IODOBENZENE

Equip a 500 ml. three-necked flask with a reflux condenser, a mercury-sealed mechanical stirrer and separatory funnel, and support it on a water bath. Attach an absorption device (Fig. II, 8, 1, c) to the top of the condenser (1). Place 134 g. (152 ml.) of A.R. benzene and 127 g. of iodine in the flask, and heat the water bath to about 50°; add 92 ml. of fuming nitric acid, sp. gr. 1.50, slowly from the separatory funnel during 30 minutes. Oxides of nitrogen are evolved in quantity. The temperature rises slowly without the application of heat until the mixture boils gently. When all the nitric acid has been introduced, reflux the mixture gently for 15 minutes. If iodine is still present, add more nitric acid to the warm solution until the purple colour (due to iodine) changes to brownish-red.

Separate the lower oily layer, mix with it an equal volume of 10 per cent. sodium hydroxide solution, and steam distil from a 1-litre flask until no more oil passes over. A yellow solid, consisting of nitro compounds, may collect towards the end of the distillation; remove this by mechanical stirring of the oil for about 3 hours with 7 ml. of concentrated hydrochloric acid, 100 ml. of water and 70 g. of iron filings in a 1-litre three-necked flask connected with a reflux condenser. Allow the mixture to cool and filter. Render the filtrate distinctly acid to Congo red with hydrochloric acid and again steam distil. Separate the oil, dry it with anhydrous calcium chloride or magnesium sulphate, and distil with the aid of a suitably lagged fractionating column or from a Claisen flask with fractionating side arm (Figs. II, 24, 2–5); collect the fraction of b.p. 180–190°. Upon redistillation, pure iodobenzene, b.p. 184–186°, is obtained. The yield is 180 g.

Note.

(1) "Old" rubber stoppers may be used, but are slightly attacked. Asbestos-sodium silicate stoppers (for preparation, see Section III, 161, Note 2) or ground glass joints are, of course, to be preferred.

IV,22

BENZYL CHLORIDE (*Chlorination of Toluene*)

Method 1. Fit a 500-ml. three-necked flask with a thermometer (the bulb of which is within 2 cm. of the bottom), and inlet tube extending to the bottom of the flask, and a double surface condenser. Use "old"

rubber stoppers throughout (1). Connect the top of the condenser through a calcium chloride (or cotton wool) guard tube to two wash bottles containing 10 per cent. sodium hydroxide solution: the long lead-in tubes in the wash bottles should be just above the surface of the alkali solution in order to avoid "sucking back." Place 100 g. (115.5 ml.) of dry toluene and a few chips of porous plate in the flask. Boil the toluene gently and pass in a stream of chlorine from a cylinder—interpose an empty wash bottle between the flask and the cylinder—until the thermometer registers 157–158° (2). The reaction time may be considerably shortened by exposing the mixture to bright sunlight or to a small mercury-vapour lamp; if neither of these is practicable, support a 200-watt lamp a few inches from the flask.

Transfer the reaction mixture to a Claisen flask and distil under atmospheric pressure until the temperature reaches 135–140° (3). Distil the residue under diminished pressure and collect the benzyl chloride at 64–69°/12 mm. The latter upon redistillation boils largely at 63–65°/12 mm. The yield of benzyl chloride is about 100 g.

Notes.

(1) Ideal connections for chlorine are ground glass joints, but previously used and well-fitting rubber stoppers give satisfactory results. Owing to the poisonous character of chlorine, the apparatus should be fitted up in the fume cupboard.

(2) An alternative method of determining the completion of the reaction is to weigh the flask and toluene, and to stop the passage of chlorine when the increase in weight is 37 g.

(3) The benzyl chloride may also be isolated by distillation under atmospheric pressure. The material boiling between 165° and 185° is collected and redistilled; the final product is collected at 178–182° (pure benzyl chloride has b.p. 179°). The resulting benzyl chloride is, however, of lower purity unless an efficient fractionating column is used.

Method 2. In a 500-ml. round-bottomed flask, fitted with an efficient reflux condenser, place 92 g. (106 ml.) of toluene, 68 g. (41 ml.) of redistilled sulphuryl chloride and 1 g. of dibenzoyl peroxide (Section IV, 196). Reflux gently, when a vigorous reaction takes place: the reaction is complete in 30 minutes. Isolate the benzyl chloride as described in *Method 1*. The yield is 50 g.

COGNATE PREPARATION

Benzal chloride (benzylidene chloride). Use 100 g. of toluene and continue the passage of chlorine until the increase in weight of the flask and contents is 74 g. or, alternatively, until the temperature rises to 187°. Collect the benzal chloride at 204–208° or at 104–105°/30 mm. Pure benzylidene chloride has b.p. 206°.

IV, 23. BENZYL CHLORIDE (*Chloromethylation of Benzene*)

Into a 1-litre three-necked flask, equipped with a reflux (double surface) condenser, a mechanical stirrer (preferably of the Hershberg type, Fig. II, 7, 8) and a gas lead-in tube extending to near the bottom of the flask, place 200 g. (227 ml.) of dry benzene, 20 g. of paraformaldehyde (1) and 20 g. of finely-pulverised, anhydrous zinc chloride. Support the flask on a water bath so arranged that the level of the water in it is about

the same height as the reaction mixture. Heat the bath to 60° and pass in (through an intervening empty wash bottle) a rapid stream of hydrogen chloride (Section II, 48, I) until no more gas is absorbed (about 20 minutes): allow to cool. Transfer the reaction mixture to a separatory funnel, wash it successively with two 50 ml. portions of cold water, two 50 ml. portions of saturated sodium bicarbonate solution (2) and finally with 20 ml. of water. Dry with anhydrous calcium chloride or magnesium sulphate, and distil under normal pressure from a Claisen flask with fractionating side arm (Figs. II, 24, 2-5) until the temperature rises to 100-110°. After cooling somewhat, distil under reduced pressure and collect the benzyl chloride at 63-65°/12 mm. The yield is 70 g. Some (about 4 g.) *p*-xylylene dichloride, m.p. 100°, and a small amount of diphenylmethane are present in the residue in the flask.

Notes.

(1) Formalin (40 per cent.) may also be used; the proportions are then 200 g. of benzene, 38 g. of 40 per cent. formalin and 50 g. of pulverised zinc chloride.

(2) It is essential to remove all the zinc salts in the washing process, otherwise the product largely resinifies during the distillation.

COGNATE PREPARATIONS

***p*-Ethylbenzyl chloride.** Use a mixture of 250 g. of dry ethylbenzene (Section IV, 6), 30 g. of paraformaldehyde and 20 g. of anhydrous pulverised zinc chloride, and proceed exactly as detailed for benzyl chloride. Collect the *p*-ethylbenzyl chloride at 95-96°/15 mm.; the yield is 100 g.

α -Chloromethylnaphthalene. **CAUTION:** Both α -chloromethylnaphthalene and the by-products are lachrymators and vesicants. The preparation should therefore be conducted in a fume cupboard (hood) and precautions should be taken in the handling of the substance and the apparatus.

In a 1-litre flask, fitted with a reflux condenser and Hershberg stirrer, place 64 g. of naphthalene, 27.5 g. of paraformaldehyde, 65 ml. of glacial acetic acid, 41 ml. of 85 per cent. orthophosphoric acid and 107 g. (90.5 ml.) of concentrated hydrochloric acid. Heat the mixture, with vigorous stirring, in a water bath at 85-90° for 6 hours: maintain the level of the water bath at the same height as that of the stirred reaction mixture. Cool the mixture to room temperature, transfer it to a 500 ml. separatory funnel, wash the crude product with two 250 ml. portions of cold water (5-10°), then with 125 ml. of cold 10 per cent. potassium carbonate solution, and finally with 125 ml. of cold water: the product is the lower layer in all the washings. Add 50 ml. of ether, dry the ethereal solution by standing over 2.5 g. of anhydrous potassium carbonate with frequent shaking for 1 hour, run off the lower aqueous layer, add a further 5.6 g. of anhydrous potassium carbonate, and leave for 8-10 hours. Distil off the ether at atmospheric pressure and the residue under reduced pressure: use a Claisen flask with short side tube and a distilling flask as receiver (compare Fig. II, 19, 1; alternatively, the flask shown in Fig. II, 19, 3 may be employed). A fore-run of unreacted naphthalene, amounting to about 9 g., passes over at 120-126°/9 mm.; care should be taken that the naphthalene does not solidify in the side arm by gently warming, if necessary. This is followed (the receiver should be changed at this point) by 56 g.

of α -chloromethylnaphthalene at 147–152°/13 mm. An appreciable brown residue, containing bis-(chloromethyl)-naphthalene and di- α -naphthylmethane, remains in the flask.

IV,24. IODOBENZENE DICHLORIDE

Equip a 500-ml. three-necked flask with a mechanical stirrer, an inlet tube at least 10 mm. in diameter for the introduction of chlorine, and an outlet tube carrying a calcium chloride (or cotton wool) guard tube. Charge the flask with 75 ml. of chloroform (dried with anhydrous calcium chloride : see Section II,47,25) and 51 g. of iodobenzene (Section IV,21) ; adjust the inlet tube so that it terminates about 5 mm. above the surface of the liquid. Set up the apparatus in the fume cupboard and protect it from the light. Cool the flask in an ice-salt mixture and pass in dry chlorine (1) as rapidly as the solution will absorb it until an excess is present (1.5–2 hours). Filter the yellow, crystalline iodobenzene dichloride at the pump, wash it sparingly with chloroform and dry it in the air upon filter paper. The yield is 65 g. The substance decomposes slowly upon standing ; it may be kept unchanged for a short period in a well-fitting, ground glass stoppered bottle.

Note.

(1) Chlorine from a cylinder is passed through two wash bottles containing concentrated sulphuric acid, then through an empty wash bottle filled with glass wool to remove spray.

IV,25. IODOSOBENZENE

Cool a large glass mortar in ice and then place in it 50 g. of anhydrous sodium carbonate, 55 g. of iodobenzene dichloride (Section IV,24) and 100 g. of finely crushed ice. Grind the mixture thoroughly until all the ice has melted and a thick paste results. Add 140 ml. of 5*N*-sodium hydroxide in 20 ml. portions and triturate vigorously after each addition ; finally add 120 ml. of water and allow to stand overnight. Filter with suction, press well with a large flat glass stopper on the filter, transfer to a beaker, and stir with 300 ml. of water (1). Filter again at the pump transfer again to a beaker containing 300 ml. of water, filter and wash with about 200 ml. of water on the filter. Dry in the air upon filter papers, stir with a little chloroform (to dissolve a little iodobenzene which is present), filter with suction, and dry on filter paper in the air. The yield is 27 g.

Iodosobenzene explodes violently at about 220°, so that determinations of the melting point should not be attempted. It may, however, be converted into iodobenzene diacetate in the following manner. Dissolve 2 g. of iodosobenzene in 6 ml. of glacial acetic acid ; boiling is usually necessary. Cool. The resulting diacetate is readily soluble in acetic acid but is insoluble in ether. Add about 50 ml. of ether in order to precipitate the iodobenzene diacetate. Filter and wash with ether. The yield is

2 g., m.p. 157°. It may be recrystallised from benzene, and will keep indefinitely (unlike the iodobenzene dichloride).

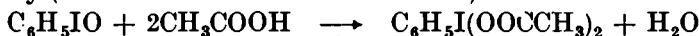

Note.

(1) The filtrate contains some diphenyliodonium salts; these may be recovered as the sparingly soluble diphenyliodonium iodide (about 8 g.) (Section IV,27) by the addition of potassium iodide.

IV,26. IODOXYBENZENE

Fit up a 1-litre round-bottomed flask for steam distillation (Fig. II, 40, 1) and place in it 22 g. of iodosobenzene (Section IV,25) made into a thin paste with water (1). Steam distil until almost all the iodobenzene has been removed (about 9 g.); cool the residue in the flask at once, filter the white solid with suction and dry in the air. Wash it with a little chloroform, filter with suction, and dry in the air upon filter paper. The yield is 10.5 g. It may be recrystallised from 800-900 ml. of water. Iodoxybenzene melts with explosive decomposition at 237°.

Note.

(1) Iodosobenzene when heated directly may decompose with explosive violence, particularly when dry.

IV,27. DIPHENYLIODONIUM IODIDE

Grind together 12 g. of iodoxybenzene (Section IV,26), 11 g. of iodosobenzene (Section IV,25) with 25 ml. of water, add 100 ml. of *N* sodium hydroxide solution and stir for 24 hours in a 1-litre vessel. Dilute with 500 ml. of cold water, stir thoroughly, allow to settle, and decant the supernatant solution of diphenyliodonium iodate, through a fluted filter paper. Extract the solid residue with two 250 ml. portions of water, and decant the extract through a fluted filter paper: a small tarry residue remains. To the combined filtrates add an aqueous solution containing 10 g. of potassium iodide. Allow the bulky white precipitate of diphenyliodonium iodide to stand for 1.5 hours with occasional shaking, and then filter it with suction. Dry on a porous tile. The yield is 15 g. The product melts at 173-175° with vigorous decomposition.

IV,28. REACTIONS AND CHARACTERISATION OF HALOGENATED AROMATIC HYDROCARBONS

The following reactions will assist the student in the identification of halogenated aromatic hydrocarbons.

(i) **Alcoholic silver nitrate solution.** Chlorobenzene and similar nuclear substituted compounds do not react. Benzyl chloride and other aromatic compounds with the halogen in the side chain react rapidly.

For details of test, see under *Alkyl Halides*, Section III,42,(ii).

(ii) **Alcoholic potassium hydroxide solution.** This reagent gives similar results to alcoholic silver nitrate solution.

For details of test, see under *Alkyl Halides*, Section III,42,(iii).

CRYSTALLINE DERIVATIVES

1. **Nitration products.** Although no general method of nitration can be given, the following procedure is widely applicable.

Add 1 g. of the compound to 4 ml. of concentrated sulphuric acid and cautiously introduce, drop by drop, 4 ml. of fuming nitric acid. Warm the mixture on a water bath for 10 minutes, then pour it on to 25 g. of crushed ice (or 25 ml. of ice water). Collect the precipitate by filtration at the pump, and recrystallise it from dilute alcohol.

Twenty per cent. oleum may be substituted for the concentrated sulphuric acid for compounds which are difficult to nitrate.

2. Reaction with chlorosulphonic acid ("chlorosulphonylation"). Sulphonamides. Many aryl halides, either alone or in chloroform solution, when treated with excess of chlorosulphonic acid afford the corresponding sulphonyl chlorides in good yield (compare Section IV,106): the latter may be readily converted into the aryl sulphonamides by reaction with concentrated ammonia solution or with solid ammonium carbonate.

The following give abnormal results when treated with chlorosulphonic acid alone, preferably at 50° for 30–60 minutes:—fluobenzene (4:4'-difluorodiphenylsulphone, m.p. 98°); iodobenzene (4:4'-di-iododiphenylsulphone, m.p. 202°); *o*-dichlorobenzene (3:4:3':4'-tetrachlorodiphenylsulphone, m.p. 176°); and *o*-dibromobenzene (3:4:3':4'-tetrabromodiphenylsulphone, m.p. 176–177°). The resulting sulphones may be crystallised from glacial acetic acid, benzene or alcohol, and are satisfactory for identification of the original aryl halide. In some cases sulphones accompany the sulphonyl chloride; they are readily separated from the final sulphonamide by their insolubility in cold 6*N* sodium hydroxide solution; the sulphonamides dissolve readily and are reprecipitated by 6*N* hydrochloric acid.

Procedure 1. Dissolve 1 g. of the compound in 5 ml. of chloroform in a test-tube and cool in ice. Add 5 ml. of chlorosulphonic acid (*CAUTION* in handling) dropwise and with shaking. When the initial evolution of hydrogen chloride subsides, remove the reaction mixture from the ice and, after 20 minutes, pour it into a 50 ml. beaker filled with crushed ice. Separate the chloroform layer, wash it well with water, and evaporate the solvent. Recrystallise the residual aryl sulphonyl chloride from light petroleum (b.p. 40–60°), chloroform or benzene; this is not essential for conversion into the sulphonamide.

Procedure 2. Follow Procedure 1 except that no solvent is employed. Pour the syrupy reaction mixture on to crushed ice, remove the resulting aryl sulphonyl chloride and/or sulphone, if a solid, by filtration with suction and, if a liquid, by means of a small separatory funnel or dropper, and wash with water.

To convert the aryl sulphonyl chloride into the sulphonamide, use either of the following methods:—

(i) Boil 0.5 g. with 5 ml. of concentrated ammonia solution, sp. gr. 0.88, for 10 minutes, cool to room temperature, add 10 ml. of cold water, filter with suction, wash well, and recrystallise to constant m.p. from dilute alcohol; dry at 100°.

(ii) Mix the product from the chlorosulphonylation (0.5 g.) with 2.0 g. of dry, powdered ammonium carbonate and heat at 100° for 30 minutes. Wash with several 10 ml. portions of cold water, filter, and recrystallise from dilute alcohol.

If the presence of a sulphone is suspected, treat the product with 6*N* sodium hydroxide solution (only the sulphonamide dissolves), filter and reprecipitate the sulphonamide by 6*N* hydrochloric acid.

3. **Oxidation of side chains.** The oxidation of halogenated toluenes and similar compounds and of compounds with side chains of the type $-\text{CH}_2\text{Cl}$ and $-\text{CH}_2\text{OH}$ proceeds comparatively smoothly with alkaline permanganate solution (for experimental details, see under *Aromatic Hydrocarbons*, Section IV,9,6 or under *Aromatic Ethers*, Section IV,106). The resulting acid may be identified by a m.p. determination and by other tests (see Section IV,175).

4. **Picrates.** Some halogen derivatives of the higher aromatic hydrocarbons form picrates (for experimental details, see under *Aromatic Hydrocarbons*, Section IV,9, 1), for example, α -chloronaphthalene (m.p. 137°), α -bromonaphthalene (m.p. 134°), and β -bromonaphthalene (m.p. 86°).

The properties of a number of aromatic halogen compounds are collected in Table IV,28.

TABLE IV, 28.

AROMATIC HALOGEN COMPOUNDS

Compound	B.P.	M.P.	d_{4}^{20}	n_{D}^{20}	Nitration Product		Sulphonamide (-SO ₂ NH ₂ , 1)		Other Derivatives
					Position	M.P.	Position	M.P.	
Fluorobenzene	85°	—	1.024	1.466	—	—	4, F	125°	Sulphone, 98°
Chlorobenzene	132	—	1.107	1.525	2 : 4	52°	4, Cl	143	—
Bromobenzene	156	—	1.494	1.560	2 : 4	75	4, Br	162	—
Iodobenzene	188	—	1.831	1.620	4	174	—	—	Sulphone, 202
<i>o</i> -Fluorotoluene	114	—	—	—	—	—	3, CH ₃ ; 4, F	105	<i>o</i> -Fluobenzoic acid, 127
<i>m</i> -Fluorotoluene	116	—	—	—	—	—	2, CH ₃ ; 4, F	173	<i>m</i> -Fluobenzoic acid, 124
<i>p</i> -Fluorotoluene	116	—	0.998	1.469	—	—	2, CH ₃ ; 5, F	141	<i>p</i> -Fluobenzoic acid, 186
<i>o</i> -Chlorotoluene	159	—	1.082	1.527	3 : 5	64	3, CH ₃ ; 4, Cl	126	<i>o</i> -Chlorobenzoic acid, 141
<i>m</i> -Chlorotoluene	162	—	1.072	1.522	4 : 6	91	2, CH ₃ ; 4, Cl	185	<i>m</i> -Chlorobenzoic acid, 158
<i>o</i> -Chlorotoluene	162	7°	1.071	1.521	2	38	2, CH ₃ ; 5, Cl	143	<i>p</i> -Chlorobenzoic acid, 242
<i>o</i> -Bromotoluene	181	—	1.425	—	3 : 5	82	3, CH ₃ ; 4, Br	146	<i>o</i> -Bromobenzoic acid, 148
<i>m</i> -Bromotoluene	183	—	1.410	—	4 : 6	103	2, CH ₃ ; 4, Br	168	<i>m</i> -Bromobenzoic acid, 155
<i>p</i> -Bromotoluene	185	26	1.390	—	2	47	2, CH ₃ ; 5, Br	165	<i>p</i> -Bromobenzoic acid, 251
<i>o</i> -Iodotoluene	207	—	1.698	—	6	103	—	—	<i>o</i> -Iodobenzoic acid, 162
<i>m</i> -Iodotoluene	204	—	1.698	—	—	—	—	—	<i>m</i> -Iodobenzoic acid, 186
<i>p</i> -Iodotoluene	211	35	—	—	—	—	—	—	<i>p</i> -Iodobenzoic acid, 269
Benzyl chloride	179	—	1.100	1.539	—	—	—	—	S Benzyl- <i>iso</i> -thiuronium picrate, 188
Benzal chloride	205	—	1.250	1.550	—	—	—	—	Benzaldehyde phenyl- hydrazone, 156
Benzo-trichloride	220	—	1.173	—	—	—	—	—	Benzoic acid, 121
Benzyl bromide	198	—	1.438	—	—	—	—	—	—
Benzal bromide	156°/23	—	—	1.541	—	—	—	—	—
Benzyl iodide	93°/10	24	—	—	—	—	—	—	—
<i>o</i> -Difluorobenzene	—	92	—	—	—	—	—	—	—
<i>m</i> -Difluorobenzene	—	82	—	—	—	—	—	—	—
<i>p</i> -Difluorobenzene	—	88	—	—	—	—	—	—	—
<i>o</i> -Dichlorobenzene	180	—	1.305	1.551	4 : 5	110	3 : 4, diCl	135	Sulphone, 176

TABLE IV,28.

AROMATIC HALOGEN COMPOUNDS (continued)

Compound	B.P.	M.P.	$d_{4}^{20^{\circ}}$	$n_{D}^{20^{\circ}}$	Nitration Product		Sulphonamide (-SO ₂ NH ₂ : 1)		Other Derivatives
					Position	M.P.	Position	M.P.	
<i>m</i> -Dichlorobenzene	173°	—	1.288	1.546	4 : 6	103°	2 : 4, diCl	180°	—
<i>p</i> -Dichlorobenzene	174	53°	—	—	2	54	2 : 5, diCl	180	—
<i>o</i> -Dibromobenzene	224	7	1.956	1.609	4 : 5	114	3 : 4, diBr	176	Sulphone, 177°
<i>m</i> -Dibromobenzene	219	—	1.952	1.606	4	62	2 : 4, diBr	189	—
<i>p</i> -Dibromobenzene	219	89	—	—	2 : 5	84	2 : 5, diBr	195	—
<i>o</i> -Di-iodobenzene	287	27	—	—	—	—	—	—	—
<i>m</i> -Di-iodobenzene	285	40	—	—	—	—	—	—	—
<i>p</i> -Di-iodobenzene	285	129	—	—	2 : 5	171	—	—	—
<i>o</i> -Bromochlorobenzene	195	—	1.646	1.580	—	—	—	—	—
<i>p</i> -Bromochlorobenzene	195	67	—	—	—	72	—	—	—
<i>o</i> -Bromiodobenzene	257	—	2.262	1.665	—	—	—	—	—
<i>p</i> -Bromiodobenzene	251	92	—	—	—	—	—	—	—
2 : 4-Dichlorotoluene	199	—	1.249	1.549	3 : 5	104	2 : 4, diCl, 5Me	176	2 : 4-Dichlorobenzoic acid, 164
2 : 6-Dichlorotoluene	199	—	1.269	1.551	3	53	2 : 4, diCl, 3Me	204	2 : 6-Dichlorobenzoic acid, 139
2 : 5-Dibromotoluene	236	—	1.811	—	—	—	—	—	2 : 5-Dibromobenzoic acid, 157
3 : 4-Dibromotoluene	240	—	1.811	—	—	—	—	—	3 : 4-Dibromobenzoic acid, 235
1 : 2 : 4-Trichlorobenzene	213	17	1.468	1.554	5	56	—	—	—
1 : 2 : 3-Trichlorobenzene	218	53	—	—	4	56	2 : 3 : 4, triCl	230	—
1 : 3 : 5-Tribromobenzene	271	120	—	—	—	—	2 : 4 : 6, triBr	222d	—
1 : 2 : 4 : 5-Tetrachlorobenzene	240	140	—	—	3	99	—	—	—
1 : 2 : 4 : 5-Tetrabromobenzene	—	181	—	—	3	168	—	—	—
Bromomesitylene	225	-1	—	—	—	—	—	—	—
2-Bromocymene	234	—	1.267	—	—	—	—	—	—

TABLE IV,28.

AROMATIC HALOGEN COMPOUNDS (*continued*)

Compound	B.P.	M.P.	d_{4}^{20}	n_{D}^{20}	Nitration Product		Sulphonamide (-SO ₂ NH ₂ , 1)		Other Derivatives
					Position	M.P.	Position	M.P.	
Hexachlorobenzene	—	229°	—	—	—	—	—	—	—
α-Fluoronaphthalene	214°	—	1.134	1.594	—	—	—	—	Picrate, 113°
β-Fluoronaphthalene	—	60	—	—	—	—	—	—	Picrate, 101
α-Chloronaphthalene	259	—	1.191	1.633	4 : 5	180°	4, Cl	186°	Picrate, 137
β-Chloronaphthalene	256	61	—	—	1 : 8	175	7, Cl	232	Picrate, 81
α-Bromonaphthalene	281	—	1.484	1.658	4	85	4, Br	193	Picrate, 134
β-Bromonaphthalene	282	59	—	—	—	—	7, Br	208	Picrate, 86
α-Iodonaphthalene	302	—	—	—	—	—	—	—	Picrate, 127
β-Iodonaphthalene	309	54	—	—	—	—	—	—	Picrate, 95
2-Chlorodiphenyl	273	32	—	—	—	—	—	—	<i>o</i> -Chlorobenzoic acid, 141
4-Chlorodiphenyl	291	77	—	—	—	—	—	—	<i>p</i> -Chlorobenzoic acid, 242
2-Bromodiphenyl	297	—	—	—	—	—	—	—	<i>o</i> -Bromobenzoic acid, 148 (CrO ₃)
4-Bromodiphenyl	310	89	—	—	—	—	—	—	<i>p</i> -Bromobenzoic acid, 251 (CrO ₃)
2-Iododiphenyl	158°/6	—	—	—	—	—	—	—	—
4-Iododiphenyl	—	114	—	—	—	—	—	—	—
1 : 2-Dichloronaphthalene	296	35	—	—	—	—	—	—	—
1 : 2-Dibromonaphthalene	—	68	—	—	—	—	—	—	—
2 : 2'-Dichlorodiphenyl	—	60	—	—	—	—	—	—	—
4 : 4'-Dichlorodiphenyl	—	149	—	—	—	—	—	—	<i>p</i> -Chlorobenzoic acid, 242 (CrO ₃)
2 : 2'-Dibromodiphenyl	—	81	—	—	—	—	—	—	—
4 : 4'-Dibromodiphenyl	—	164	—	—	—	—	—	—	<i>p</i> -Bromobenzoic acid, 251 (CrO ₃)
Naphthalene tetrachloride (1 : 2 : 3 : 4)	—	183	—	—	—	—	—	—	—

SULPHONATION OF AROMATIC HYDROCARBONS

Aromatic hydrocarbons may be mono-sulphonated by heating with a slight excess of concentrated sulphuric acid; for benzene, oleum (7-8 per cent. SO_3) gives somewhat better results. The reaction is usually complete when all the hydrocarbon has dissolved. Examples are:

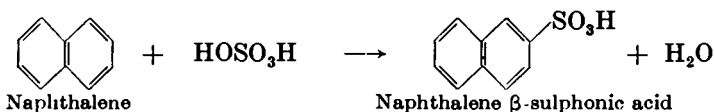
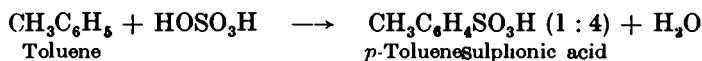
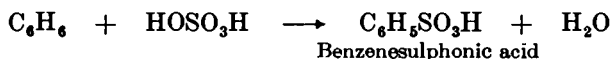

Because of the great solubility of sulphonic acids in water and the consequent difficulty in crystallisation, the free sulphonic acids are not usually isolated but are converted directly into the sodium salts. The simplest procedure is partly to neutralise the reaction mixture (say, with solid sodium bicarbonate) and then to pour it into water and add excess of sodium chloride. An equilibrium is set up, for example:

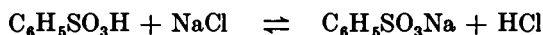

The high sodium ion concentration results in facile crystallisation of the sodium salt. This process of salting out with common salt may be used for recrystallisation, but sodium benzenesulphonate (and salts of other acids of comparable molecular weight) is so very soluble in water that the solution must be almost saturated with sodium chloride and consequently the product is likely to be contaminated with it. In such a case a pure product may be obtained by crystallisation from, or Soxhlet extraction with, absolute alcohol; the sulphonate is slightly soluble but the inorganic salts are almost insoluble. Very small amounts of sulphones are formed as by-products, but since these are insoluble in water, they separate when the reaction mixture is poured into water:

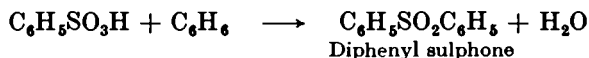

The sulphonation of toluene at 100-120° results in the formation of *p*-toluenesulphonic acid as the chief product, accompanied by small amounts of the *ortho* and *meta* isomers; these are easily removed by crystallisation in the presence of sodium chloride. Sulphonation of naphthalene at about 160° yields largely the β -sulphonic acid; at lower temperatures (0-60°) the α -sulphonic acid is produced almost exclusively.

Sulphonation is a reversible reaction and, in general, an excess of sulphuric acid is employed, for example:



If, however, the water formed is removed as formed (compare the preparation of di-*n*-butyl ether, Section III,57), the sulphuric acid may react completely and the method may be employed for the preparation of the free sulphonic acid.

The *mechanism* of aromatic sulphonation may be similar to that previously described for nitration and halogenation, involving attack of the electrophilic SO_3H^+ ion. The latter may be formed thus :

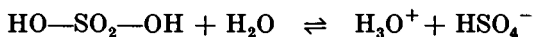
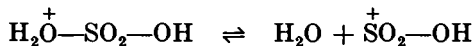
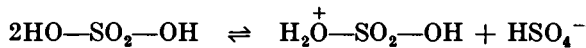

The $\overset{+}{\text{S}}\text{O}_2-\text{OH}$ ion attacks the nucleophilic aromatic nucleus :

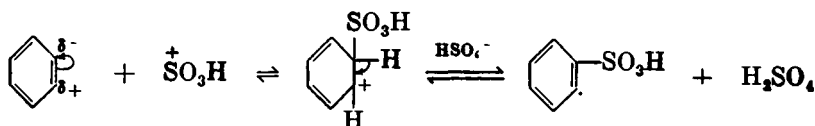

It has been suggested that SO_3 is the actual electrophilic reagent leading to $\text{C}_6\text{H}_5\text{SO}_3^-*$, the anion of $\text{C}_6\text{H}_5\text{SO}_3\text{H}$. However, in sulphuric acid, the following equilibrium probably exists :

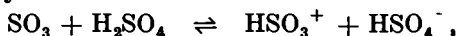

and it may well be that both SO_3 and HSO_3^+ are the active reagents. A further complication is the reversibility of the over-all sulphonation reaction.

IV,29. SODIUM BENZENESULPHONATE

Into a 200-ml. round-bottomed flask place 75 g. (40 ml.) of fuming sulphuric acid, sp. gr. 1.88, containing 7-8 per cent. of sulphur trioxide. Add, with frequent shaking, 20 g. (22.5 ml.) of thiophene-free benzene (1) in portions of about 3 ml. during about 15 minutes. Make sure that the first portion has dissolved before adding the next portion, etc.; maintain the temperature of the reaction mixture between 30° and 50° , and cool in a vessel of cold water if necessary. When all the benzene has completely reacted, cool and pour the reaction mixture slowly and with constant stirring into about 200 ml. of water. Cool to the laboratory temperature and, if necessary, filter from any diphenylsulphone $\text{C}_6\text{H}_5\text{SO}_2\text{C}_6\text{H}_5$ (a by-product) which may separate. Partially neutralise the acid solution by adding carefully and in small portions 24 g. of sodium bicarbonate : then add 40 g. of sodium chloride and heat until it dissolves. Filter the hot solution with suction through a Buchner funnel (previously warmed in the steam oven or by pouring boiling water through it), transfer the warm filtrate to a beaker, and cool rapidly (ice and cold water) with stirring. Filter the sodium benzenesulphonate which separates on a Buchner funnel and press well with a wide glass stopper; wash with about 30 ml. of a filtered saturated sodium chloride solution and press

* This anion may be formed according to the following scheme :

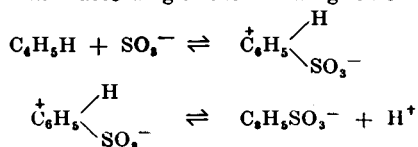

the crystals as dry as possible. Finally wash with a little alcohol. Dry in the air upon filter paper, powder, and dry in the oven at 100–110°. The yield of the dry sodium benzenesulphonate is about 20 g. The product contains traces of sodium chloride and other salts, but is pure enough for most purposes. The impurities may be completely removed by recrystallisation from rectified spirit; about 18 ml. are required for each gram of solid. The volume of alcohol required for recrystallisation may be considerably reduced by the use of a Soxhlet extractor (Figs. II, 44, 4–6).

Note.

(1) Commercial benzene may be purified by shaking repeatedly with 10 per cent. of its volume of concentrated sulphuric acid until the acid layer is almost colourless, then washing successively with cold water, 10 per cent. sodium carbonate solution and water, and drying with anhydrous calcium chloride or magnesium sulphate. Distillation then yields pure benzene.

COGNATE PREPARATION

Sodium *p*-bromobenzenesulphonate. Equip a 500-ml. bolt-head or three-necked flask with a separatory funnel, a mechanical stirrer (*not* mercury-sealed) and a thermometer. Place 75 g. (40 ml.) of fuming sulphuric acid, sp. gr. 1.88 (7–8 per cent. SO₃) in the flask and 40 g. (27 ml.) of bromobenzene (Section IV, 18) in the separatory funnel. Add the bromobenzene in small portions so that the temperature does not rise above 100°. If any bromobenzene remains unattacked, warm the mixture on a water bath until all of it has passed into solution. Allow to cool, and pour the reaction mixture in a thin stream with stirring into 140 ml. of cold water. If a precipitate separates (dibromodiphenylsulphone BrC₆H₄SO₂C₆H₄Br, a by-product), filter the warm solution at the pump. Add 55 g. of sodium chloride to the filtrate and heat (with stirring) until the salt dissolves. Cool the solution rapidly with stirring, filter the separated crude sulphonate at the pump, and press the crystals as dry as possible. Upon drying in the air, the yield is 47 g. To purify the crude sodium *p*-bromobenzenesulphonate, powder the crystals in a mortar, transfer to a beaker, add 75 ml. of a filtered, saturated solution of sodium chloride, stir, heat on a water bath for 30 minutes, allow to cool, filter and press the crystals as dry as possible; finally wash with a little alcohol. Dry in the air by spreading upon filter papers. The yield of purified sodium *p*-bromobenzenesulphonate is 45 g. The product, although pure enough for most practical purposes, contains traces of sodium chloride and other salts: these can be removed either by recrystallisation from hot rectified spirit (1 g. of salt requires *ca.* 25 ml. of alcohol) or, more economically, by extraction with alcohol in a Soxhlet apparatus (Figs. II, 44, 4–6).

IV.30. SODIUM *p*-TOLUENESULPHONATE

Into a 500-ml. bolt-head or three-necked flask, provided with a mechanical stirrer and a reflux condenser, place 60 g. (69 ml.) of thiophene-free toluene (Section II, 47, 16) and 60 g. (33 ml.) of concentrated sulphuric acid. Heat the mixture, with stirring, in an oil bath maintained at

110-120°. When the toluene layer has disappeared (*ca.* 1 hour), allow the reaction mixture to cool to room temperature. Pour it with stirring into 250 ml. of cold water; filter from any solid substance which may separate. Partly neutralise the acid solution by adding cautiously and in small portions 30 g. of sodium bicarbonate. Heat the solution to boiling and saturate it with sodium chloride (about 100 g. of salt are required), filter hot through a hot water funnel (Fig. II, 1, 6) or through a Buchner funnel previously warmed to about 100°. Transfer the hot filtrate to a beaker and cool the solution, with stirring, in ice. Filter the crystals at the pump (rinse any residual crystals out of the beaker with a little of the filtered mother liquor), press well with a large glass stopper, and wash with 30 ml. of saturated salt solution. To recrystallise the crude sodium *p*-toluenesulphonate, dissolve it in 200-250 ml. of water, heat to boiling, saturate with salt, allow to cool somewhat, stir with 2-3 g. of decolourising charcoal (if the solution is coloured), and filter the hot solution with suction through a previously warmed Buchner funnel. Transfer the warm filtrate to a beaker and cool in ice; filter the sulphonate with suction through a Buchner funnel, wash it with 20 ml. of saturated sodium chloride solution, press well, and finally wash with a little alcohol. Dry the hydrated crystals in air upon filter papers, powder in a mortar, and then dry in a steam oven or in an air oven at 100-110°. The yield of anhydrous sodium *p*-toluenesulphonate is 50 g. It still contains traces of sodium chloride and other salts; these can be removed by recrystallisation from rectified spirit (1 g. of solid to about 40 ml. of alcohol) or by extraction in a Soxhlet apparatus with boiling alcohol (Figs. II, 44, 4-6).

IV,31. SODIUM β -NAPHTHALENESULPHONATE

Equip a 500-ml. bolt-head or three-necked flask with a separatory funnel, a thermometer with its bulb about 2 cm. from the bottom, and a mechanical stirrer; the bearing for the stirrer consists of a glass tube lubricated with a little glycerine. Place 100 g. of naphthalene in the flask and heat it either in an air bath (Fig. II, 5, 3) or by means of a free flame. When the naphthalene melts, start the stirrer and adjust the heating so that the temperature is $160 \pm 5^\circ$. Run in 166 g. (90 ml.) of concentrated sulphuric acid from the funnel during 5-6 minutes: take care to maintain the temperature at 160° and remove the flame if necessary. Stir for 5 minutes and pour the solution into 750 ml. of cold water. If the sulphonation has been properly conducted, there will be no precipitate of naphthalene but about 4 g. of insoluble di- β -naphthyl sulphone $C_{10}H_7SO_2C_{10}H_7$, may separate. Boil with 3-4 g. of decolourising carbon and filter with suction through a Buchner funnel. Partly neutralise the clear solution by carefully adding 40 g. of sodium bicarbonate in small portions. Heat the solution to the boiling point, saturate with sodium chloride (about 70 g. are required) and then set aside to crystallise. Filter the crude sodium β -naphthalenesulphonate at the pump and recrystallise from hot 10 per cent. sodium chloride solution; dry by heating on a water bath or in a steam oven. The yield is 140 g.

IV,32. p-TOLUENESULPHONIC ACID

Use the apparatus employed for *Di-n-butyl Ether* (Fig. III, 57, 2); it is advantageous to have the "water separator tube" calibrated (as in the Dean and Stark apparatus), otherwise place sufficient water in *A* so that with a further 9 ml. the water level is at *B*. Place 87 g. (100 ml.) of thiophene-free toluene (Section II,47,16) and 37 g. (20 ml.) of concentrated sulphuric acid (92 per cent. H_2SO_4 by weight) in the 250 or 300-ml. bolt-head flask and heat to gentle boiling. When 9 ml. of water have been collected in the "water separator tube" (4-5 hours), extinguish the flame. The water is derived partly from the reaction (6.25 ml.) and partly from the sulphuric acid. Add 6.3 ml. of water to the cold contents of the flask; crystallisation then occurs. Spread the resulting solid on a porous tile and press well with a glass stopper; toluene and *o*-toluenesulphonic acid are thus removed. Dissolve the residual solid (47 g.) in about 22 ml. of water and saturate the solution with hydrogen chloride gas; use any convenient device (*e.g.*, a small funnel) to prevent "sucking back." After several hours the acid crystallises out as colourless prisms. Filter rapidly through a sintered glass funnel, wash with a little concentrated hydrochloric acid, and dry in a vacuum desiccator charged with stick potassium hydroxide and anhydrous calcium chloride. The yield is 35 g., m.p. 105-106° (sealed tube).

IV,33. REACTIONS AND CHARACTERISATIONS OF AROMATIC SULPHONIC ACIDS

Sulphonic acids are frequently crystalline solids, readily soluble in water and often hygroscopic. Because of the difficulty of isolation of the free acids, they are usually encountered as the alkali metal salts.

(i) **Fusion with caustic alkali.** When the preliminary tests for elements indicate the presence of sulphur (and frequently also of a metal), it is advisable to carry out a fusion with caustic alkali. In a nickel crucible of about 20 ml. capacity mix thoroughly 0.5-1 g. of the substance with 3 g. of potassium hydroxide pellets and 4-5 drops of water. Support the crucible in a circular hole in a sheet of asbestos or uralite board of such size that it fits tightly and only about one-third is below the board; this will ensure that the contents of the crucible are not contaminated by sulphur compounds from the gas flame. (Alternatively, place the nickel crucible in a larger iron crucible fitted with an asbestos ring so arranged that the nickel crucible is held about 5 mm. from the bottom of the iron crucible). Heat the crucible so that the mixture *just* melts and continue the fusion with occasional stirring with a small nickel spatula for 5-10 minutes. Allow to cool, add about 5 ml. of water and dissolve the mass by warming with a small flame. Pour the solution into a small test-tube; acidify by the cautious addition of 50 per cent. sulphuric acid. Note whether there is any odour of sulphur dioxide: test for this gas either with filter paper moistened with acidified potassium dichromate solution, or better, by the highly sensitive sulphur dioxide test reagent. In the

latter case it is best to use the semimicro technique for the identification of evolved gases.*



The sulphur dioxide test reagent is prepared by mixing 50 ml. of 0.1N hydrochloric acid, 15 ml. of *N* barium chloride solution and 5 ml. of 0.1N potassium permanganate solution. Its use is based upon the transient formation of barium sulphite which is immediately oxidised by the permanganate to give a white precipitate of insoluble barium sulphate; the permanganate solution is simultaneously decolourised. The method is inapplicable in the presence of hydrogen sulphide, which gives the same visible result.

Extract the acidified solution with ether, remove the ether and identify the phenol in the usual manner (see Section IV, 114).† Add a few drops of bromine water or nitric acid to the aqueous layer and test for sulphate with barium chloride solution.

Once the presence of a sulphonate group has been established (and, if possible, the phenol isolated), the compound may be characterised by the preparation of a derivative. It must be remembered that both *sulphoxides* RSOR' and *sulphones* $\text{RSO}_2\text{R}'$ yield sulphur dioxide on fusion with caustic alkali and acidification.

CRYSTALLINE DERIVATIVES

1. Sulphonamides. Mix together 1.0 g. of the dry acid or 1.2 g. of the anhydrous salt with 2.5 g. of phosphorus pentachloride ‡ and heat under a reflux condenser in an oil bath at 150° for 30 minutes. Cool the mixture, add 20 ml. of dry benzene, warm on a steam bath and stir the solid mass well to extract the sulphonyl chloride: filter. Add the benzene solution slowly and with stirring to 10 ml. of concentrated ammonia solution. If the sulphonamide precipitates, separate it by filtration; if no solid is obtained, evaporate the benzene on a steam bath. Wash the sulphonamide with a little cold water, and recrystallise from water, aqueous ethanol or ethanol to constant m.p.

The procedure is not usually applicable to aminosulphonic acids owing to the interaction between the amino group and the phosphorus pentachloride. If, however, the chlorosulphonic acid is prepared by diazotisation and treatment with a solution of cuprous chloride in hydrochloric acid, the crystalline chlorosulphonamide and chlorosulphonanilide may be obtained in the usual way. With some compounds, the amino group may be protected by acetylation. Sulphonic acids derived from a phenol or naphthol cannot be converted into the sulphonyl chlorides by the phosphorus pentachloride method.

The **sulphonanilides** may be prepared by either of the following methods:—(i) Reflux the solution of the sulphonyl chloride in benzene obtained as above, with 2.5 g. of aniline for 1 hour. Concentrate the benzene solution to half its volume and cool in ice. Collect the solid which separates on a filter, wash with hot water, and recrystallise from ethanol or dilute ethanol.

(ii) Treat the crude sulphonyl chloride (isolated by evaporating the solvent after extraction with benzene (or ether or chloroform) as above) with 1 g. of *p*-toluidine and 30 ml. of *ca.* 2*N* sodium hydroxide solution.

* See, for example, Vogel, *A Text-Book of Macro and Semimicro Qualitative Inorganic Analysis*, Fourth Edition, 1954, p. 181 (Longmans, Green and Co. Ltd.).

† The phenol cannot always be isolated in good yield, particularly if it contains substituent groups, owing to the destructive action of the alkali fusion upon the radical R.

‡ If preferred, the PCl_5 may be replaced by 4–5 ml. of POCl_3 and the mixture refluxed for 4 hours. The subsequent procedure is identical with that given in the text.

Shake for 10-15 minutes. Extract the alkaline solution with ether to remove excess of *p*-toluidine, acidify, filter, and recrystallise the residue as in (i).

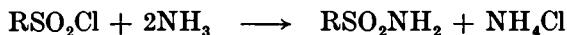

2. **S-Benzyl-*iso*-thiuronium salts (S-Benzyl-*iso*-thiourea salts)*** (for a discussion of this reagent, see under *Carboxylic Acids*, Section III, 85,4). If the substance is the free sulphonic acid, dissolve 0.5 g. of it in 5-10 ml. of water, add a drop or two of phenolphthalein indicator, and neutralise with *ca.* *N* sodium hydroxide solution. Then add 2-3 drops of 0.1*N* hydrochloric acid to ensure that the solution is almost neutral (*pale* pink colour); under alkaline conditions the reagent tends to decompose to produce the evil-smelling benzyl mercaptan.

To a solution of 0.5 g. of the salt in 5 ml. of water and 2-3 drops of 0.1*N* hydrochloric acid (or to a solution of the acid treated as above), add a slight excess of a cold, 15 per cent. aqueous solution of benzyl-*iso*-thiourea hydrochloride (if the molecular weight of the compound is not known, use a solution of 1 g. of the reagent in 5 ml. of water), and cool in ice. Filter off the crystalline derivative and recrystallise it from 50 per cent. alcohol.

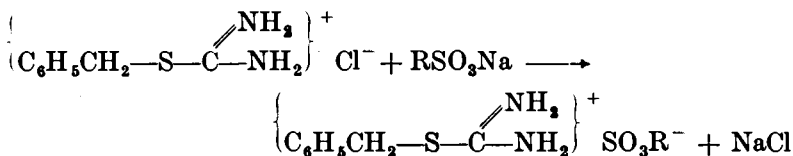

3. **Sulphonacetamides.** Sulphonacetamides are derivatives of sulphonamides (Section IV,33A), but since the latter are readily prepared from the sulphonic acids or their salts, sulphonacetamides may be employed for the characterisation of sulphonic acids; for this reason they are included in this Section.

Sulphonamides upon heating with acetyl chloride are converted into the *N*-acetyl derivatives or sulphonacetamides:



The sulphonacetamides (R = H) are freely soluble in sodium bicarbonate solution thus rendering purification facile. Sulphonacetamides are moderately strong acids, and can generally be titrated in aqueous or aqueous-alcoholic solution with phenolphthalein as indicator. The acidic properties of sulphonacetamides may be used to effect a separation of a sulphonamide from a *N*-alkylsulphonamide. Acetylation of such a mixture gives a sulphonacetamide and a *N*-alkylsulphonacetamide, of which only the former is soluble in sodium bicarbonate solution. Both sulphonacetamides and *N*-alkylsulphonacetamides are readily hydrolysed by boiling with excess of 5 per cent. potassium hydroxide solution for about 1 hour, followed by acidification with dilute hydrochloric acid, giving the corresponding sulphonamides and *N*-alkylsulphonamides respectively.

* Also known as S-benzylthiuronium salts and as S-benzyl- ψ -thiuronium salts.

Reflux 1 g. of the sulphonamide with 2.5 ml. of acetyl chloride for 30 minutes; if solution is not complete within 5 minutes, add up to 2.5 ml. of glacial acetic acid. Remove the excess of acetyl chloride by distillation on a water bath, and pour the cold reaction mixture into water. Collect the product, wash with water and dissolve it in warm sodium bicarbonate solution. Acidify the filtered solution with glacial acetic acid; filter off the precipitated sulphonacetamide and recrystallise it from aqueous alcohol.

The melting points of a number of sulphonacetamides are:—benzene-sulphonic acid, 125°; *p*-toluenesulphonic acid, 137°; *p*-bromobenzene-sulphonic acid, 203°; *m*-nitrobenzenesulphonic acid, 189°; *p*-nitrobenzenesulphonic acid, 192°; naphthalene- α -sulphonic acid, 185°; and naphthalene- β -sulphonic acid, 146°.

4. ***p*-Toluidine salts of sulphonic acids.** These are prepared by the interaction of the sulphonic acid or its sodium salt with *p*-toluidine hydrochloride in aqueous solution:

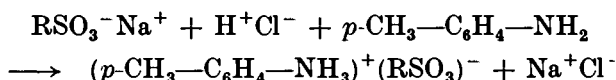

Dissolve 1 g. of the sulphonic acid or its sodium salt in the *minimum* volume of boiling water and add a saturated aqueous solution of 1 g. of *p*-toluidine hydrochloride. Cool, filter off the precipitate of the *p*-toluidine salt, and recrystallise it from hot water or from dilute ethanol.

The melting points of the derivatives of a number of selected sulphonic acids are collected in Table IV, 33; the melting points of the corresponding sulphonyl chlorides are included for purposes of reference.

TABLE IV,33.

SULPHONIC ACIDS

Acid	Sulphon- amide, ArSO ₂ NH ₂	S-Benzyl- iso-thi- uronlum Salt	Sulphon- anilide ArSO ₂ NHPh	<i>p</i> -Tolul- dine Salt	Sulphonyl Chloride, ArSO ₂ Cl
Benzenesulphonic	153°	150°	110°	205°	—
<i>o</i> -Toluenesulphonic	156	170	136	204	68°
<i>m</i> -Toluenesulphonic	108	—	96	—	12
<i>p</i> -Toluenesulphonic	137	182	103	198	71
<i>o</i> -Chlorobenzenesulphonic	188	—	—	—	28
<i>m</i> -Chlorobenzenesulphonic	148	—	—	—	—
<i>p</i> -Chlorobenzenesulphonic	144	175	104	209	53
<i>o</i> -Bromobenzenesulphonic	186	—	—	—	51
<i>m</i> -Bromobenzenesulphonic	154	—	—	—	—
<i>p</i> -Bromobenzenesulphonic	166	170	119	216	75
<i>o</i> -Nitrobenzenesulphonic	193	—	115	—	69
<i>m</i> -Nitrobenzenesulphonic	168	146	126	222	64
<i>p</i> -Nitrobenzenesulphonic	179	—	136	—	80
Sulphanilic	164	187	200	—	—
Orthanilic	153	132	—	—	—
Metanilic	142	148	—	—	—
<i>o</i> -Sulphobenzoic (salt)	—	206	—	200	79
<i>m</i> -Sulphobenzoic	170	163	—	—	20
<i>p</i> -Sulphobenzoic	236	213	—	—	57
Phenol- <i>p</i> -sulphonic	177	169	—	202	—
Thymolsulphonic	—	213	—	—	—
<i>o</i> -Xylenesulphonic	144	208	—	—	52
<i>m</i> -Xylenesulphonic	138	146	110	—	34
<i>p</i> -Xylenesulphonic	148	184	—	—	25
Naphthalene- α -sulphonic	150	137	112	181	68
Naphthalene- β -sulphonic	217	191	132	221	79
Anthraquinone- α -sulphonic	—	191	216	—	217
Anthraquinone- β -sulphonic	261	211	193	—	197
1-Naphthylamine-4-sulphonic	206	195	—	—	—
1-Naphthylamine-5-sulphonic	260	180	—	—	—
1-Naphthylamine-6-sulphonic	219	191	—	—	—
1-Naphthylamine-7-sulphonic	181	—	—	—	—
1-Naphthylamine-8-sulphonic	—	300	140	—	—
2-Naphthylamine-1-sulphonic	—	139	—	—	—
2-Naphthylamine-6-sulphonic	—	184	—	—	—
1-Naphthol-2-sulphonic	—	170	—	—	—
1-Naphthol-4-sulphonic	—	104	200	196	—
1-Naphthol-5-sulphonic	—	—	201	—	—
2-Naphthol-1-sulphonic	—	136	—	162	124
2-Naphthol-6-sulphonic	238	217	—	248	—
2-Naphthol-8-sulphonic	—	218	195	232	—
Benzene- <i>o</i> -disulphonic	254	206	241	—	143
Benzene- <i>m</i> -disulphonic	229	214	144	—	63
Benzene- <i>p</i> -disulphonic	288	—	—	—	131
Naphthalene-1 : 4-disulphonic	273	—	179	—	—
Naphthalene-1 : 5-disulphonic	310	257	249	332	183
Naphthalene-1 : 6-disulphonic	298	235	—	315	129
Naphthalene-2 : 6-disulphonic	305	256	—	360	225
Naphthalene-2 : 7-disulphonic	243	211	—	300	159
2-Naphthylamine-4 : 8-disulphonic	—	210	—	—	—
2-Naphthylamine-5 : 8-disulphonic	—	276	—	—	—
2-Naphthylamine-6 : 7-disulphonic	—	—	—	—	—

TABLE IV,33. SULPHONIC ACIDS (*continued*)

Acid	Sulphonamide ArSO ₂ NH ₂	S-Benzyl- <i>iso</i> -thiuronium Salt	Sulphonamide ArSO ₂ NHPh	<i>p</i> -Toluidine Salt	Sulphonyl Chloride, ArSO ₂ Cl
1-Naphthylamine-3 : 6-disulphonic	—	—	—	—	—
1-Naphthylamine-3 : 8-disulphonic	—	—	—	—	—
1-Naphthol-3 : 6-disulphonic	—	217°	—	—	—
1-Naphthol-4 : 8-disulphonic	—	205	—	—	—
2-Naphthol-3 : 6-disulphonic	—	233	202°	—	—
2-Naphthol-6 : 8-disulphonic	—	228	195	—	162°
<i>d</i> -Camphorsulphonic	132°	210	—	—	88

ALIPHATIC SULPHONIC ACIDS

Sulphonic Acid	B.P.	Sulphonyl chloride, b.p.	Sulphonamide, m.p.	S-Benzyl- <i>iso</i> -thiuronium salt, m.p.	Sulphonamide, m.p.
Methane . . .	167°/10	163°	90°	—	99°
Ethane . . .	—	177	59	115°	58
2-Propane . . .	—	79°/18	60	—	84
1-Propane . . .	—	78°/13	52	—	—
1-Butane . . .	—	75°/10	45	—	—

IV,33A. REACTIONS AND CHARACTERISATION OF AROMATIC SULPHONAMIDES

Sulphonamides are most readily identified by hydrolysis with concentrated hydrochloric acid or with 80 per cent. sulphuric acid (for experimental details, see Section X,7,12) :

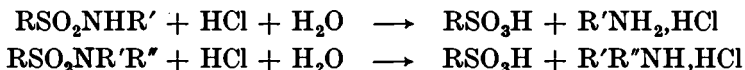

The amine is removed by the addition of alkali and characterised by a suitable derivative; the sulphonic acid may then be recovered as the sodium salt and converted into a crystalline derivative, *e.g.*, the *S*-benzyl-*iso*-thiuronium salt.

Primary sulphonamides RSO_2NH_2 may be most simply characterised by condensation with xanthhydrol to yield the corresponding *N*-xanthylsulphonamides :

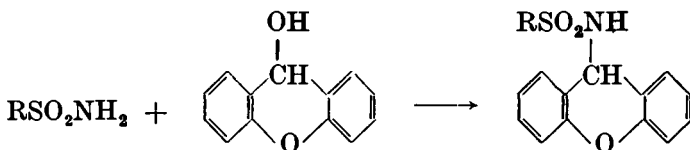

The best results are obtained with freshly prepared xanthhydrol (reduction of xanthone with sodium amalgam, Section VII,16). Dissolve 0.25 g. of xanthhydrol and 0.25 g. of the primary sulphonamide in 10 ml. of glacial acetic acid. Shake for 2-3 minutes at the laboratory temperature and allow to stand for 60-90 minutes. Filter off the derivative, recrystallise it from dioxan-water (3 : 1), and dry at room temperature under water pump suction for 30 minutes.

The melting points of a number of *N*-xanthylsulphonamides are collected in Table IV,33A.

TABLE IV,33A. AROMATIC SULPHONAMIDES

Sulphonamide	M.P.	<i>N</i> -Xanthylsulphonamide
Benzene-	153°	200°
Toluene- <i>o</i> -	156	183
Toluene- <i>p</i> -	137	197
Benzene-1 : 3-di-	229	170
<i>p</i> -Ethylbenzene-	110	196
2 : 4-Dimethylbenzene-	137	188
2 : 5-Dimethylbenzene-	147	176
2 : 4 : 6-Trimethylbenzene-(mesityl-)	142	203
<i>p</i> -Aminobenzene-(sulphanilamide)	165	208
Saccharin.	224	198

Sulphonamides may also be characterised as sulphonacetamides : for experimental details, see Section IV,33,3.

AROMATIC AMINES AND THEIR SIMPLE DERIVATIVES

AROMATIC AMINES

Aromatic amines may be divided into three classes :—

(i) **Primary amines** : (a) purely aromatic with the amino group directly attached to the aromatic ring, *e.g.*, aniline $C_6H_5NH_2$, and (b) with the NH_2 group in the side chain, *e.g.*, benzylamine $C_6H_5CH_2NH_2$. The latter possesses properties similar to those of aliphatic amines (Section III,123).

(ii) **Secondary amines** : (a) purely aromatic amines, *e.g.*, diphenylamine $(C_6H_5)_2NH$, and (b) aromatic-aliphatic amines, *e.g.*, monomethylaniline $C_6H_5NHCH_3$.

(iii) **Tertiary amines** : (a) purely aromatic amines, *e.g.*, triphenylamine $(C_6H_5)_3N$, and (b) aromatic-aliphatic amines, *e.g.*, dimethylaniline $C_6H_5N(CH_3)_2$.

Arylamines are generally prepared by the reduction of nitro compounds. When only small quantities are to be reduced and the time element is important and cost is a secondary consideration, tin and hydrochloric acid may be employed, for example :

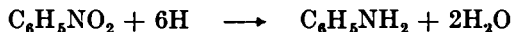

The various stages in the reduction may be represented as follows :

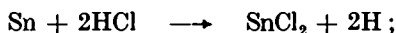

stannous chloride is itself an excellent reducing agent :

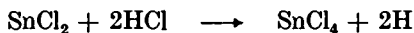

i.e., $Sn \equiv 4H$; this must be borne in mind when calculating the quantities required for the reaction. The stannic chloride forms the complex chlorostannic acid with hydrochloric acid, which combines with the aniline produced in the reaction :

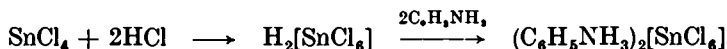

With a large excess of sodium hydroxide solution, the salt complex is decomposed and the free amine is liberated :



On the technical scale, the cheaper iron and hydrochloric acid is employed as the reducing agent :

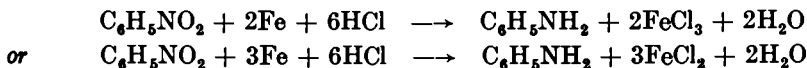

In practice, however, the amount of hydrochloric acid employed is less than 5 per cent. of the amounts indicated by either of the above equations. Various explanations have been advanced to account for this ; one is that the following reaction is catalysed by acid or by hydroxonium ions :

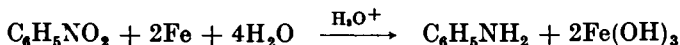

Benzylamine may be obtained by the **Gabriel synthesis**, which depends upon the use of potassium phthalimide. The latter upon heating with benzyl

165-190° is generally termed the Leuckart reaction. The procedure has been satisfactorily applied to many aliphatic-aromatic, alicyclic and aliphatic-heterocyclic ketones, some aromatic ketones and aldehydes, and to some aliphatic aldehydes and ketones boiling at about 100° or higher. The method is superior to that involving the formation and reduction of aldoximes and ketoximes (compare Section III,121), particularly with compounds in which functional groups are present that are readily attacked by reducing agents, *e.g.*, in the preparation of amines from *p*-chloro-, *p*-bromo- and *p*-nitro-acetophenone. The reaction is an example of *reductive aminolysis* of aldehydes and ketones: an equivalent result is obtained by reduction of a mixture of an aldehyde or ketone and ammonia in ethanol in the presence of Raney nickel under pressure.

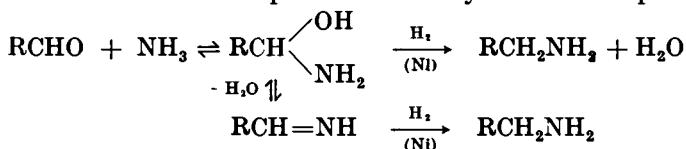

In the naphthalene series, α -naphthylamine is easily obtained by the reduction of the readily accessible α -nitronaphthalene:

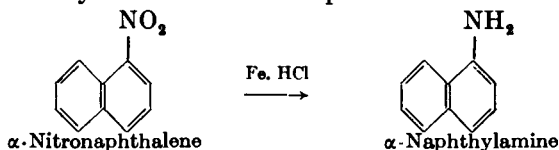

β -Nitronaphthalene is not formed by direct nitration. For the preparation of β -naphthylamine, the Bucherer reaction may be applied to β -naphthol, *i.e.*, by heating with ammoniacal ammonium sulphite solution at 150° (under pressure). The reaction involves the addition of the bisulphite to the keto form of β -naphthol:

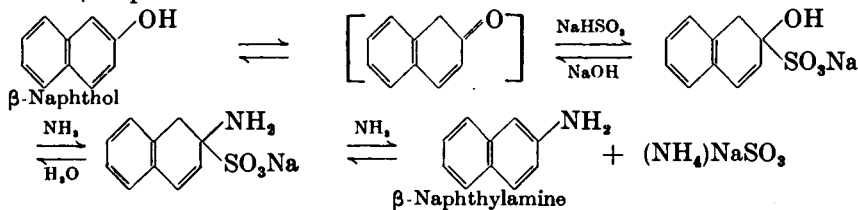

The amination reaction is reversible; thus β -naphthylamine can be reconverted into β -naphthol by heating with aqueous sodium bisulphite solution, then adding alkali and boiling until all the ammonia is expelled.

The reversibility of the Bucherer reaction is utilised in the preparation of 2-*p*-tolylamino-5-hydroxynaphthalene-7-sulphonic acid (II) from 2-amino-5-hydroxynaphthalene-7-sulphonic acid or "J" acid (I) by heating with *p*-toluidine and sodium bisulphite solution:

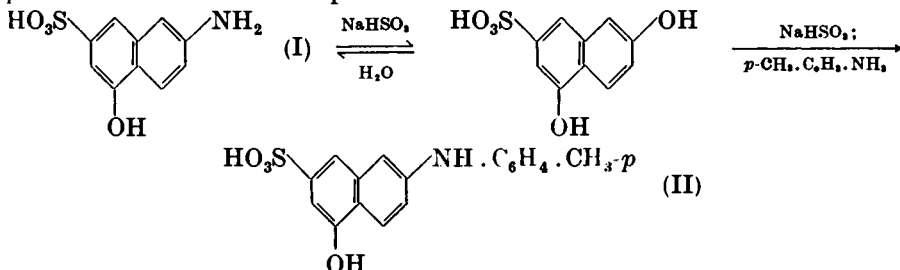

CAUTION: Attention is drawn to the carcinogenic properties (leading to papilloma of the bladder) of β -naphthylamine and to a much smaller degree of α -naphthylamine and of benzidine. In consequence, the manufacture of β -naphthylamine has ceased altogether in Great Britain. Great care should therefore be taken in the preparation and handling of β -naphthylamine, by the use of rubber gloves and by conducting all operations in a fume cupboard provided with a powerful exhaust system.

Secondary and tertiary amines are not generally prepared in the laboratory. On the technical scale **methylaniline** is prepared by heating a mixture of aniline hydrochloride (55 parts) and methyl alcohol (16 parts) at 120° in an autoclave. For **dimethylaniline**, aniline and methyl alcohol are mixed in the proportion of 80 : 78, 8 parts of concentrated sulphuric acid are added and the mixture heated in an autoclave at 230 – 235° and a pressure of 25–30 atmospheres. Ethyl- and diethyl-aniline are prepared similarly. One method of isolating pure methyl- or ethyl-aniline from the commercial product consists in converting it into the *N*-nitroso derivative with nitrous acid, followed by reduction of the nitroso compound with tin and hydrochloric acid :

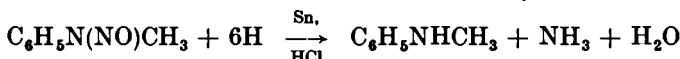
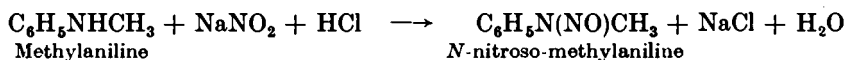

Commercial dialkyl-anilines may be purified by refluxing with an excess of acetic anhydride : any unchanged aniline and monoalkyl-aniline are converted into the difficultly-volatile acetyl derivatives :

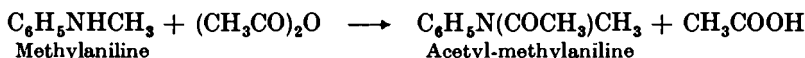
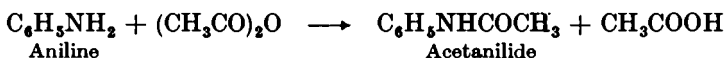

Upon fractionation, the acetic acid and acetic anhydride pass over first, followed by the pure dialkyl-aniline.

A convenient method for preparing pure ***NN*-dialkyl anilines** and substituted anilines directly from the corresponding amines consists in heating the latter with trialkyl orthophosphates :

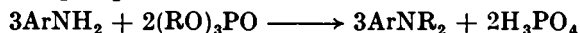

Thus good yields (> 60 per cent) are obtained with aniline and methyl, ethyl, *n*-propyl and *n*-butyl phosphates ; with α - and β -naphthylamine and methyl or ethyl phosphate ; nuclear substituted anilines and methyl or ethyl phosphate.

The nitroso compound (diphenylnitrosamine) of the purely aromatic secondary amine diphenylamine is a crystalline solid, and therefore provides an interesting preparation eminently suitable for students :

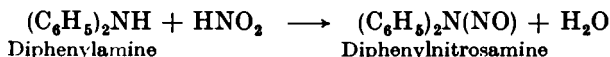

Tertiary aliphatic - aromatic amines, unlike those of the aliphatic series, react with nitrous acid with the formation of *C*-nitroso compounds ; the nitroso group enters almost exclusively in the *para* position if available, otherwise in the *ortho* position. Thus dimethylaniline yields ***p*-nitrosodimethylaniline** :

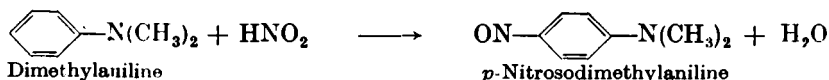

It is interesting to observe that the hydrochloride is yellow, whereas the free base is a green crystalline compound.

N-Nitrosomethylaniline undergoes an interesting molecular rearrangement in ether-alcoholic solution under the catalytic influence of hydrogen chloride. The substance rearranges to *p*-nitroso-*N*-methylaniline which separates as the hydrochloride; this involves the migration of the nitroso group from the side chain to the *p*-position (compare *Sulphanilic Acid*, Section IV,55):

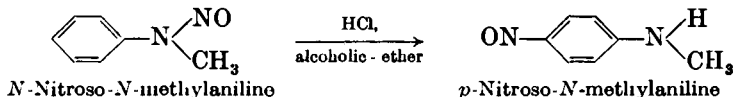

It is convenient to include under *Aromatic Amines* the preparation of *m*-nitroaniline as an example of the selective reduction of one group in a polynitro compound. When *m*-dinitrobenzene is allowed to react with sodium polysulphide (or ammonium sulphide) solution, only one of the nitro groups is reduced and *m*-nitroaniline results. Some sulphur separates, but the main reaction is represented by:

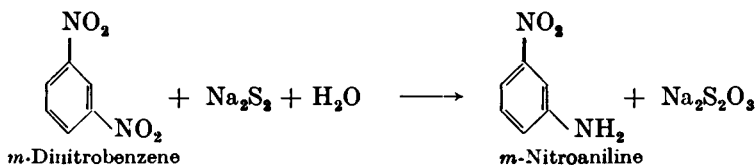

IV,34.

ANILINE

Method A. Reduction with tin and hydrochloric acid. Into a 500-ml. round-bottomed flask equipped with a reflux condenser, place 25 g. (21 ml.) of nitrobenzene and 45 g. of granulated tin. Measure out 100 ml. of concentrated hydrochloric acid. Pour about 15 ml. of this acid down the condenser and shake the contents of the flask steadily. The mixture becomes warm and before long the reaction should be quite vigorous; if it boils very vigorously, moderate the reduction somewhat by temporarily immersing the flask in cold water. When the initial reaction slackens of its own accord, pour another 15 ml. of hydrochloric acid down the condenser, shake the flask steadily to ensure thorough mixing, and cool again if the reduction becomes too violent. Do not cool more than is necessary to keep the reaction under control; keep the mixture well shaken. Proceed in this way until all the 100 ml. of acid has been added. Finally heat the mixture on a boiling water bath for 30–60 minutes, *i.e.*, until the odour of nitrobenzene is no longer perceptible and a few drops of the reaction mixture when diluted with water yield a perfectly clear solution. During the course of the reduction, particularly during the cooling, the complex of aniline hydrochloride and stannic chloride may separate as a white or yellow crystalline solid.

Cool the reaction mixture to room temperature and add gradually a solution of 75 g. of sodium hydroxide in 125 ml. of water; if the mixture boils during the addition of the alkali, cool again. The hydroxide of tin which is first precipitated should all dissolve and the solution should be strongly alkaline: the aniline separates as an oil. Equip the flask for steam distillation as in Fig. II, 40, 1, and pass steam into the warm

mixture until, after the distillate has ceased to pass over as a turbid liquid, a *further* 120 ml. of clear liquid are collected. Since aniline is appreciably soluble (*ca.* 3 per cent.) in water, it must be "salted out" by saturating the distillate with salt. Use about 20 g. of commercial salt for each 100 ml. of liquid. Transfer the distillate, saturated with salt, to a separatory funnel, add about 40 ml. of ether, and shake to ensure intimate mixing of the solution and the ether; relieve the pressure within the funnel by momentarily lifting the stopper. [All flames in the vicinity must be extinguished during the extraction.] Allow the two layers to separate; run off the lower aqueous layer into a beaker, and pour the remaining ethereal layer through the mouth of the funnel into a 200 ml. flask. Return the aqueous solution to the funnel and extract with a further 40 ml. of ether. Proceed as before, and pour the ethereal extract into the flask. Dry the combined ethereal solutions with a few grams of anhydrous potassium carbonate (1): shake the well-stoppered flask for several minutes. Alternatively, conduct the drying operation in a separatory funnel; stand a beaker beneath the funnel to collect the solution should the stopcock accidentally fall out or leak.

Remove the ether with the aid of the apparatus shown in Fig. II, 13, 4; the distilling flask should have a capacity of 50–75 ml. and the solution should first be filtered through a small fluted filter paper. Remember to place 2–3 fragments of porous porcelain in the flask. Since ether is extremely volatile and also highly inflammable, the flask must be heated in a beaker or bath of warm water; the water should be warmed in another part of the laboratory. Before commencing the distillation, read Section II,13 (on the method of using the apparatus of Fig. II, 13, 4) and also Section II,14 (fire hazards attending the distillation of inflammable solvents). When all the ethereal solution has been introduced into the flask and no more ether distils on a boiling water bath, detach the Buchner flask receiver and pour the ether into the ETHER RESIDUES bottle. Run out the water from the condenser, have two small conical flasks available as receivers, and distil the aniline either by direct heating over a wire gauze or, preferably, using an air bath (Fig. II, 5, 3). A small quantity of ether may pass over during the early part of the distillation; it is therefore advisable to interpose an asbestos or uralite board between the receiver and the flame. Collect the fraction b.p. 180–184° in a weighed conical flask. The yield of aniline is 18 g.

Pure aniline has a b.p. of 184°. When freshly distilled it is a colourless liquid, but becomes discoloured on standing, particularly when exposed to light owing to atmospheric oxidation. The colour may usually be removed by distillation from a little zinc dust.

Note.

(1) Calcium chloride cannot be used to dry the ethereal solution because it combines with aniline (and other amines) to form molecular compounds. The best drying agent is sodium or potassium hydroxide (pellet form).

Method B. Reduction with iron and hydrochloric acid. Place 40 ml. of water and 30 g. of grease-free iron filings (1) in a 750- or 1,000-ml. round-bottomed flask, and 25 g. (21 ml.) of nitrobenzene in a small beaker or conical flask. Warm the former on a water bath at about 60°. Add

1 ml. of nitrobenzene and 2.5 ml. of concentrated hydrochloric acid, and shake well; the temperature will rise appreciably. In the subsequent reduction maintain the temperature inside the flask at 80–90° by alternate heating on a water bath or cooling the flask in running water as may be found necessary. Add the nitrobenzene 1–2 ml. at a time over a period of 20–30 minutes. Test for completeness of the reaction (when the smell of nitrobenzene can no longer be detected at the mouth of the flask) by removing a small portion and diluting with dilute hydrochloric acid; the odour of nitrobenzene should be absent and a clear solution should be formed. (If nitrobenzene is present, warm on a water bath under reflux and with frequent shaking until the reduction is complete.) Render the reaction mixture alkaline by the cautious addition of 5 g. of anhydrous sodium carbonate, and steam distil (Fig. II, 40, 1) until the steam distillate is no longer turbid and a further 100 ml. of clear liquid passes over. Measure the total volume of the distillate, transfer it to a separatory funnel, add 20 g. of commercial salt for each 100 ml. of liquid present and shake vigorously until the salt dissolves. The aniline may be isolated, if desired, by ether extraction as in *Method 1*. An alternative procedure is to carefully separate the upper layer and pour it into a 50 or 75 ml. distillation flask. Use the assembly shown in Fig. II, 12, 1 and heat the flask either on a wire gauze or in an air bath (Fig. II, 5, 3). A little water passes over first; collect this separately. When aniline commences to distil, stop the distillation. Run out the water from the condenser, dry out the inner tube, and continue the distillation. Collect the aniline at 180–184° (2). The yield is 18 g.

Notes.

(1) Commercial "Iron filings, grease free" are quite satisfactory. If fine iron filings are used, they should be washed with ether and dried in the air.

(2) If the presence of unreduced nitrobenzene is suspected (odour and/or high b.p. residue), treat all the product with excess of dilute hydrochloric acid and remove the nitrobenzene either by steam distillation or by ether extraction; render the residue alkaline with sodium hydroxide solution and isolate the aniline as before.

COGNATE PREPARATIONS

***p*-Toluidine** ($\text{NH}_2\text{C}_6\text{H}_4\text{CH}_3$ 1 : 4). Reduce *p*-nitrotoluene with tin and hydrochloric acid and isolate the amine by ether extraction. Since *p*-toluidine is a solid (m.p. 45°; b.p. 200°), it may crystallise in the condenser used for steam distillation: it is easily melted by stopping the current of cooling water in the condenser for a moment or two.

***o*-Chloroaniline**. The vapours of *o*-chloroaniline are toxic and produce serious after-effects: the preparation must therefore be conducted in a fume cupboard. In a 2-litre three-necked flask, equipped with a mechanical stirrer, a reflux condenser and a glass funnel, the hole of which is plugged by means of a glass rod covered with a rubber tube, place 480 g. of iron filings and 360 ml. of water. Heat the mixture on a boiling water bath and, when hot, remove the water bath. While stirring vigorously, add 40 g. of *o*-chloronitrobenzene through the funnel and at the same time introduce 10 ml. of concentrated hydrochloric acid by means of a separatory funnel fitted into the top of the condenser with a grooved

cork. A vigorous reaction commences as soon as the acid has been added. Then introduce 200 g. of melted *o*-chloronitrobenzene through the funnel all at once. After about 10 minutes, add 50 ml. of concentrated hydrochloric acid, as before, at such a rate (about 15-20 minutes) that vapours of *o*-chloroaniline do not escape from the top of the condenser. Heat on a water bath, with stirring, for 1 hour in order to complete the reaction. Then add a solution of 20 g. of sodium hydroxide in 40 ml. of water to decompose any chloroaniline hydrochloride that might have formed. Filter the reaction mixture whilst still hot; separate the lower layer of the filtrate (*o*-chloroaniline) from the water layer. Return the iron residues to the flask and boil with 200 ml. of benzene: filter the hot benzene solution through the same funnel and wash the iron residues with a second 200 ml. of hot benzene. Combine the benzene extracts with the *o*-chloroaniline originally separated from the water, dry with anhydrous magnesium sulphate, and remove most of the benzene under normal pressure. Transfer the residue (**CAUTION**: the vapours are toxic) to a 400 ml. Claisen flask and distil under reduced pressure (Fig. II, 20, 1): some benzene passes over first, followed by *o*-chloroaniline at 113-117°/20 mm. The yield is 185 g. The *o*-chloroaniline may also be distilled under ordinary pressure without decomposition: b.p. 206-209°.

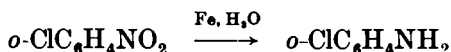

p-Chloroaniline may be similarly prepared from *p*-chloronitrobenzene; 240 g. of the latter give 185 g. of *p*-chloroaniline, b.p. 128-131°/20 mm., m.p. 71°.

IV,35.

β-PHENYLETHYLAMINE

Saturate commercial absolute methyl alcohol with ammonia (derived from a cylinder) at 0°; the resulting solution is *ca.* 10*N*. Dissolve 58 g. of benzyl cyanide (Section IV,147) (1) in 300 ml. of the cold methyl alcoholic ammonia, and place the solution in a high pressure hydrogenation bomb (Section VI,4); add 10 ml. of settled Raney nickel catalyst (Section VI,5), securely fasten the cap and introduce hydrogen until the pressure is 500-1000 lb. Shake the bomb or set the mechanical stirring device in motion, and heat at 100-125° until absorption of hydrogen ceases (about 2 hours). Allow the bomb to cool, open it, and remove the contents. Rinse the bomb with two 100 ml. portions of anhydrous methyl alcohol and pour the combined liquids through a fluted filter paper to remove the catalyst; do not permit the catalyst to become dry since it is likely to ignite. Remove the solvent and ammonia by distillation (fume cupboard!), and fractionate the residue through a short column or from a Claisen flask with fractionating side arm (Figs. II, 24, 2-5). Collect the β-phenylethylamine at 92-93°/18 mm. The yield is 54 g. The purity can be checked by conversion into the hydrochloride, m.p. 218-219°.

Note.

(1) Minute amounts of halide have a powerful poisoning effect upon the catalyst; it is advisable to distil the benzyl cyanide from Raney nickel.

IV,36.

 α -PHENYLETHYLAMINE

Place 125 g. of ammonium formate, 75 g. of acetophenone (Section IV, 136) and a few chips of porous porcelain in a 250 ml. Claisen flask with fractionating side arm (Figs. II, 24, 2-5); insert a cork carrying a thermometer extending nearly to the bottom of the flask, and attach a short condenser set for downward distillation to the side arm. Heat the flask with a small flame or in an air bath; the mixture first melts to two layers and distillation occurs. The mixture becomes homogeneous at 150-155° and reaction takes place with slight frothing. Continue the heating, more slowly if necessary, until the temperature rises to 185° (about 2 hours); acetophenone, water and ammonium carbonate distil. Stop the heating at 185°, separate the upper layer of acetophenone from the distillate, and return it without drying to the flask. Heat the mixture for 3 hours at 180-185° and then allow to cool; the acetophenone may be recovered from the distillate by extraction with 20 ml. of benzene (1). Transfer the reaction mixture to a 250 ml. separatory funnel and shake it with 100 ml. of water to remove formamide and ammonium formate. Run off the crude α -phenylethylformamide into the original Claisen flask; extract the aqueous layer with two 15 ml. portions of benzene, transfer the benzene extracts to the flask, add 75 ml. of concentrated hydrochloric acid and a few chips of porous porcelain. Heat the mixture cautiously until about 30 ml. of benzene are collected, and boil gently for a further 40 minutes; hydrolysis proceeds rapidly to α -phenylethylamine hydrochloride except for a small layer of unchanged acetophenone. Allow the reaction mixture to cool, remove the acetophenone by extraction with 25 ml. of benzene and then with three 15 ml. portions of the solvent (1). Transfer the aqueous acid solution to a 500-ml. round-bottomed flask equipped for steam distillation, cautiously add a solution of 62.5 g. of sodium hydroxide in 125 ml. of water, and steam distil: heat the distillation flask so that the volume remains nearly constant. Most of the amine is contained in the first 500 ml. of distillate; stop the operation when the distillate is only faintly alkaline. Discard the residue in the flask which contains *inter alia* a little di-(α -phenylethyl)-amine. Extract the distillate with five 25 ml. portions of benzene, dry the extract with sodium hydroxide pellets, and distil off the benzene (Fig. II, 13, 4) but use a flask having an inset side arm (compare Fig. II, 1, 3, d) * and a soda lime guard tube); the amine attacks cork and rubber and absorbs carbon dioxide from the air. Collect the α -phenylethylamine at 184-186° (2). The yield is 45 g.

Notes.

(1) The acetophenone may be recovered by washing the benzene solution with dilute alkali, drying with anhydrous magnesium sulphate and distilling; the fraction b.p. 198-205° is collected.

(2) The b.p. under diminished pressure has been given as 80-81°/18 mm. To obtain a very pure sample of the amine, dissolve 1 part (by weight) of the above product with a solution of 1.04 parts of crystallised oxalic acid in 8 parts of hot water, add a little decolourising carbon, and filter. The filtered solution deposits crystals of the acid oxalate; about 5 g. of this salt remains in each 100 ml. of

* An all-glass apparatus is the most satisfactory (compare Sections II, 54 *et seq.*).

mother liquor, but most can be recovered by evaporation and further crystallisation. The amine may be liberated from the pure acid oxalate with sodium or potassium hydroxide, steam distillation, and purification as described above. The salt provides a convenient method of obtaining a known weight of the amine in water, since it can be weighed out and decomposed with alkali hydroxide.

IV,37. α -NAPHTHYLAMINE

Into a 3-litre round-bottomed flask place 80 g. of grease-free iron filings, 80 ml. of water and 4 ml. of concentrated hydrochloric acid, and warm the mixture to about 50°. Add 60 g. of α -nitronaphthalene (Section IV,11) in small portions at a time, and shake the flask vigorously after each addition. Maintain the temperature throughout the reduction at 70–80°. Follow the experimental details given in Section IV,34. The reduction is complete when a test sample is completely soluble in dilute hydrochloric acid. Render the reaction mixture alkaline by the addition of a little sodium carbonate. Add water and filter with suction on a Buchner funnel; wash with a little water, press well, and dry the iron residue containing the naphthylamine in the air (1). Transfer to a distilling or Claisen flask, and distil under reduced pressure until the distillate is highly coloured; use the apparatus depicted in Fig. II, 19, 1 or in Fig. II, 19, 3–4. The α -naphthylamine solidifies on cooling; it has m.p. 50°, b.p. 300°. The yield is 30 g.

Note.

(1) The α -naphthylamine may also be isolated directly from the neutralised reaction mixture by distillation with superheated steam (Section I,6).

IV,38. β -NAPHTHYLAMINE

Pass a stream of sulphur dioxide into 200 ml. of cooled, concentrated ammonia solution (sp. gr. 0.88) until 50 g. of gas have been absorbed. Place this ammonium sulphite solution together with 72 g. of β -naphthol (Section IV,102) in an autoclave (see Section VI,4) provided with a stirrer or shaking mechanism. Securely fasten the cap and heat at 150° with continual shaking or stirring for 8 hours; allow to cool with shaking or stirring. Remove the reaction mixture from the apparatus with the aid of about 250 ml. of water. Filter on a Buchner funnel. Dissolve the crude material in a boiling mixture of 75 ml. of concentrated hydrochloric acid and 200 ml. of water, and then dilute with 500 ml. of water. Add 5 g. of decolourising carbon, boil for 5 minutes, and filter through a hot water funnel from any undissolved dinaphthylamine ($C_{10}H_7NHC_{10}H_7$). Pour the hot filtrate with stirring into a solution of 60 g. of sodium hydroxide in 250 ml. of water. Make sure that the resulting slurry is alkaline to phenolphthalein; cool it with stirring to 20°, filter with suction, and wash with 1 litre of cold water. Press well. Dry the product to constant weight at 50–60°. The yield of β -naphthylamine, m.p. 111–112°, isolated as a light tan powder, is 68 g.

CAUTION. This compound has carcinogenic properties and great care should be taken to avoid all contact with it during its isolation and drying.

COGNATE PREPARATION

2-*p*-Tolylamino-5-hydroxynaphthalene-7-sulphonic acid. Reflux a mixture of 108 g. of pure *p*-toluidine, 108 g. of "J" acid (2-amino-5-hydroxynaphthalene-7-sulphonic acid), 84 g. of sodium bisulphite and 250 ml. of water for 30 hours in a 1500 ml. three-necked flask, equipped with a reflux condenser and mechanical stirrer. Add sodium carbonate until the mixture is alkaline and remove the excess of *p*-toluidine by steam distillation. Keep the residual solution in a refrigerator until crystallisation is complete, filter with suction on a Buchner funnel, and wash with 25 ml. of saturated sodium chloride solution. Dissolve the product in *ca.* 350 ml. of hot water to which sufficient hydrochloric acid is added to render the mixture acid to Congo red. Keep in a refrigerator until crystallisation is complete, filter with suction, wash with a little ice-cold hydrochloric acid, followed by a small volume of ice-cold water. Dry the residual 2-*p*-tolylamino-5-hydroxynaphthalene-7-sulphonic acid at 100°; the yield is 95 g.

IV,39.

BENZYLAMINE (*Gabriel Synthesis*)

Benzyl phthalimide. Grind together 53 g. of finely powdered, anhydrous potassium carbonate and 147 g. of phthalimide (Section IV,169) in a glass mortar, transfer the mixture to a 750 ml. round-bottomed flask, and treat it with 252 g. (230 ml.) of redistilled benzyl chloride. Heat in an oil bath at 190° under a reflux condenser for 3 hours. Whilst the mixture is still hot, remove the excess of benzyl chloride by steam distillation. The benzyl phthalimide commences to crystallise near the end of the steam distillation. At this point, cool the mixture rapidly with vigorous stirring so that the solid is obtained in a fine state of division. Filter the solid with suction on a Buchner funnel, wash well with water and drain as completely as possible; then wash once with 200 ml. of 60 per cent. ethanol and drain again. The yield of crude product, m.p. 100–110°, is 180 g. Recrystallise from glacial acetic acid to obtain pure benzyl phthalimide, m.p. 116°: the recovery is about 80 per cent.

Benzylamine. Warm an alcoholic suspension of 118.5 g. of finely powdered benzyl phthalimide with 25 g. of 100 per cent. hydrazine hydrate (*CAUTION*: corrosive liquid): a white, gelatinous precipitate is produced rapidly. Decompose the latter (when its formation appears complete) by heating with excess of hydrochloric acid on a steam bath. Collect the phthalyl hydrazide which separates by suction filtration, and wash it with a little water. Concentrate the filtrate by distillation to remove alcohol, cool, filter from the small amount of precipitated phthalyl hydrazide, render alkaline with excess of sodium hydroxide solution, and extract the liberated benzylamine with ether. Dry the ethereal solution with potassium hydroxide pellets, remove the solvent (compare Fig. II, 13, 4) on a water bath and finally distil the residue. Collect the benzylamine at 185–187°: the yield is 50 g.

COGNATE PREPARATION

β -Phenylethylamine. Prepare β -phenylethyl phthalimide as above by substituting β -phenylethyl bromide (Section III,37) for benzyl

chloride: recrystallise the crude product from glacial acetic acid; m.p. 131–132°. Convert it into β -phenylethylamine by treatment with hydrazine hydrate and hydrochloric acid as described for benzylamine. The yield of β -phenylethylamine, b.p. 200–205°, is about 95 per cent.

IV,40. PURE METHYLANILINE FROM COMMERCIAL METHYLANILINE

***N*-Nitrosomethylaniline (methylphenylnitrosamine).** Place 53.5 g. of pure commercial monomethylaniline, 72.5 ml. of concentrated hydrochloric acid and 200 g. of crushed ice in a 500 ml. beaker equipped with a mechanical stirrer. Support a separatory funnel with a long bent stem (as in Fig. III, 35, 1) containing a solution of 36 g. of sodium nitrite in 125 ml. of water over the beaker. Stir the solution and run in the sodium nitrite solution during 10 minutes; do not allow the temperature to rise above 10° and add more ice if necessary. Continue the stirring for a further hour. Separate the oily layer, wash it once with 50 ml. of water, and dry it with anhydrous magnesium or calcium sulphate. Distil under reduced pressure from a 100 ml. Claisen flask. Collect the *N*-nitrosomethylaniline (a pale yellow liquid) at 120°/13 mm. The yield is about 65 g.

Reduction of *N*-nitrosomethylaniline. Into a 1 litre round-bottomed flask, fitted with a reflux condenser, place 39 g. of *N*-nitrosomethylaniline and 75 g. of granulated tin. Add 150 ml. of concentrated hydrochloric acid in portions of 25 ml. (compare Section IV,34); do not add the second portion until the vigorous action produced by the previous portion has subsided, etc. Heat the reaction mixture on a water bath for 45 minutes, and allow to cool. Add cautiously a solution of 135 g. of sodium hydroxide in 175 ml. of water, and steam distil (see Fig. II, 40, 1); collect about 500 ml. of distillate. Saturate the solution with salt, separate the organic layer, extract the aqueous layer with 50 ml. of ether and combine the extract with the organic layer. Dry with anhydrous potassium carbonate, remove the ether on a water bath (compare Fig. II, 13, 4), and distil the residual liquid using an air bath (Fig. II, 5, 3). Collect the pure methylaniline at 193–194° as a colourless liquid. The yield is 23 g.

COGNATE PREPARATIONS

Pure ethylaniline from commercial ethylaniline.

***N*-Nitrosoethylaniline (ethylphenylnitrosoamine).** Use 60.5 g. of pure commercial monoethylaniline, 72.5 ml. of concentrated hydrochloric acid and 200 g. of crushed ice: also 36 g. of sodium nitrite in 125 ml. of water. The yield of *N*-nitrosoethylaniline (a yellow liquid), b.p. 131°/20 mm., is about 65 g.

Reduction of *N*-nitrosoethylaniline. Employ 38 g. of *N*-nitrosoethylaniline, 75 g. of granulated tin and 150 ml. of concentrated hydrochloric acid. After all the acid has been added, heat on a water bath for 75 minutes and allow to cool. Treat the almost solid crystalline mass

with a solution of 135 g. of sodium hydroxide in 175 ml. of water with cooling of the flask in running water: steam distil until no more oily drops pass over (about 500 ml. of distillate). The distillate is first colourless, but gradually assumes a violet colour. Complete the preparation as for methylaniline. Collect the ethylaniline (a practically colourless liquid) at 202–203°. The yield is 24 g.

Note on the laboratory preparation of monoethylaniline. Although the laboratory preparation of monomethyl- or monoethyl-aniline is hardly worth while, the following experimental details may be useful to those who wish to prepare pure monoethylaniline directly from aniline. In a flask, fitted with a double surface reflux condenser, place 50 g. (49 ml.) of aniline and 65 g. of ethyl bromide, and boil gently for 2 hours or until the mixture has almost entirely solidified. Dissolve it in water and boil off the small quantity of unreacted ethyl bromide. Render the mixture alkaline with concentrated sodium hydroxide solution, extract the precipitated bases with three 50 ml. portions of ether, and distil off the ether. The residual oil contains aniline, mono- and di-ethylaniline. Dissolve it in excess of dilute hydrochloric acid (say, 100 ml. of concentrated acid and 400 ml. of water), cool in ice, and add with stirring a solution of 37 g. of sodium nitrite in 100 ml. of water; do not allow the temperature to rise above 10°. This leads to the formation of a solution of phenyl diazonium chloride, of *N*-nitrosoethylaniline and of *p*-nitrosodiethylaniline. The nitrosoethylaniline separates as a dark coloured oil. Extract the oil with ether, distil off the ether, and reduce the nitrosoamine with tin and hydrochloric acid (see above). The yield of ethylaniline is 20 g.

Notes on the preparation of secondary alkylarylamines. The preparation of *n*-propyl-, *isopropyl*- and *n*-butyl-anilines can be conveniently carried out by heating the alkyl bromide with an excess (2.5–4 mols) of aniline for 6–12 hours. The tendency for the alkyl halide to yield the corresponding tertiary amine is thus repressed and the product consists almost entirely of the secondary amine and the excess of primary amine combined with the hydrogen bromide liberated in the reaction. The separation of the primary and secondary amines is easily accomplished by the addition of an excess of 50 per cent. zinc chloride solution: aniline and its homologues form sparingly soluble additive compounds of the type B_2ZnCl_2 whereas the alkylanilines do not react with zinc chloride in the presence of water. The excess of primary amine can be readily recovered by decomposing the zincchloride with sodium hydroxide solution followed by steam distillation or solvent extraction. The yield of secondary amine is about 70 per cent. of the theoretical.

The experimental details for mono-*n*-propylaniline are as follows. Reflux a mixture of 230 g. of aniline and 123 g. of *n*-propyl bromide for 8–10 hours. Allow to cool, render the mixture alkaline, and add a solution of 150 g. of zinc chloride in 150 g. of water. Cool the mixture and stir: after 12 hours, filter at the pump and drain well. Extract the thick paste several times with boiling light petroleum, b.p. 60–80° (it is best to use a Soxhlet apparatus), wash the combined extracts successively with water and dilute ammonia solution, and then dry over anhydrous potassium carbonate or anhydrous magnesium sulphate. Remove the solvent on a water bath, and distil the residue from a Claisen flask with fractionating side arm (well lagged). Collect the *n*-propylaniline at 218–220°; the yield is 80 g. Treat the pasty solid zincchloride with an excess of sodium hydroxide solution and steam distil: 130 g. of pure aniline are recovered.

*iso*Propylaniline, b.p. 206–208°, and *n*-butylaniline, b.p. 235–237°, may be similarly prepared.

Pure dialkylanilines may be prepared by refluxing the monoalkylaniline (1 mol) with an alkyl bromide (2 mols) for 20–30 hours; the solid product is treated with excess of sodium hydroxide solution, the organic layer separated, dried and distilled. The excess of alkyl bromide passes over first, followed by the dialkylaniline. Di-*n*-propylaniline, b.p. 242–243°, and di-*n*-butylaniline b.p. 269–270°, are thus readily prepared.

Diphenylnitrosamine. Dissolve 8.5 g. of pure diphenylamine in 70 ml. of warm alcohol; also 4 g. of sodium nitrite in 6 ml. of water. Cool each solution in ice until the temperature falls to 5°. Add 6 ml. of concentrated hydrochloric acid slowly and with stirring to the diphenylamine solution, and immediately (otherwise diphenylamine hydrochloride may crystallise out) pour the sodium nitrite solution rapidly into the well-stirred mixture. The temperature soon rises to 20–25° and the diphenylnitrosamine crystallises out. Cool the mixture in ice water for 15–20 minutes, filter with suction on a Buchner funnel, wash with water to remove sodium chloride, and press well with a wide glass stopper. Recrystallise from methylated spirit (for details, see Section IV,12). The yield of pure diphenylnitrosamine (pale yellow crystals), m.p. 68°, is 8.5 g.

IV,41.

BENZYLANILINE

Equip a 500 ml. three-necked flask with a separatory funnel, a mechanical stirrer and a reflux condenser; mount the assembly on a water bath. Place 35 g. of pure sodium bicarbonate, 35 ml. of water and 124 g. (121 ml.) of aniline in the flask, and 42 g. (35 ml.) of freshly distilled benzyl chloride (b.p. 177–179°) in the separatory funnel protected by a calcium chloride (or cotton wool) guard tube. Heat the flask and contents to 90–95°, stir vigorously, and run in the benzyl chloride slowly (about 1 hour). Continue the heating and stirring for a further 3 hours. Allow to cool. Filter with suction, separate the organic layer from the filtrate and wash it with 25 ml. of saturated salt solution. Dry with anhydrous magnesium sulphate and filter again with suction. Distil from a Claisen flask with fractionating side arm (Figs. II, 24, 2–5) under reduced pressure: aniline (about 80 g.) distils at 81°/12 mm. and the temperature rises rapidly. Collect the benzylaniline at 170–190°/12 mm. (most of it distils at 178–180°/12 mm.); this solidifies on cooling, melts at 34–36°, and is sufficiently pure for most purposes. The yield is 52 g. If required perfectly pure, it may be recrystallised from about 35 ml. of light petroleum, b.p. 60–80°; cool the solution in a freezing mixture to induce crystallisation, filter at the pump, wash with a little cold light petroleum, press and dry. The recrystallised benzylaniline has m.p. 36°.

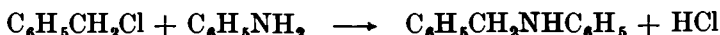

IV,42

DIMETHYLANILINE

Place 28 g. (27.5 ml.) of pure aniline and 28 g. (23 ml.) of purified methyl phosphate in a 500 ml. round-bottomed flask equipped with a reflux condenser. Heat gently at first and remove the flame when the vigorous and exothermic reaction commences. When the latter subsides,

two layers are present ; heat under gentle reflux for two hours. Cool the mixture to about 50° , add a solution of 25 g. of sodium hydroxide in 100 ml. of water, reflux the mixture for 1 hour, then pour into a 600 ml. beaker and allow to cool to room temperature. Pour off the oily layer of amine from the solid sodium phosphate, add water to the latter and extract the aqueous solution with ether. Dry the combined oil and ether extract with anhydrous magnesium sulphate, distil off the ether, treat the residue with an equal volume of acetic anhydride and allow to stand overnight. (The acetic anhydride treatment will remove any mono-alkylaniline present.) Then add hydrochloric acid (20 ml. of the concentrated acid and 30 ml. of water), shake until the base dissolves, extract the solution with two 30 ml. portions of ether, and add 25 per cent. sodium hydroxide solution to the water layer to liberate the base. Collect the oil by extracting the mixture with ether, dry the ethereal solution with anhydrous magnesium sulphate, and remove the ether on a water bath. Distil the residue, using an air condenser, and collect the dimethylaniline at $192-193^{\circ}$. The yield is 28 g.

COGNATE PREPARATIONS

Diethylaniline. Use 28 g. of pure aniline and 36 g. (34 ml.) of purified ethyl phosphate, and proceed exactly as described for dimethylaniline. The reaction is not so vigorous initially. Separation into two layers occurs after 30 to 90 minutes. The yield of diethylaniline, b.p. $215-216^{\circ}$, is 41-5 g.

Pure dimethylaniline from commercial dimethylaniline. Into a 250 ml. round-bottomed flask fitted with a reflux condenser place 50 g. (52.5 ml.) of a good commercial sample of dimethylaniline and 25 g. (23 ml.) of acetic anhydride. Heat under reflux for 3 hours, and allow to cool. Transfer to a 100 ml. Claisen flask equipped for distillation, and distil using a wire gauze or, better, an air bath (Fig. II, 5, 3). Some acetic acid and the excess of acetic anhydride passes over first, followed by pure dimethylaniline (a colourless liquid) at $193-194^{\circ}$. There is a small dark residue in the flask. The yield depends upon the purity of the commercial sample, but is usually 30-40 g.

Pure diethylaniline from commercial diethylaniline. Use 50 g. (53.5 ml.) of a good commercial specimen of diethylaniline and 25 g. (23 ml.) of acetic anhydride, and reflux for 4 hours. Distil and collect the pure diethylaniline at $216-217^{\circ}$ as a pale yellow liquid. The yield is 30-40 g.

IV.43.

p-NITROSODIMETHYLANILINE

Dissolve 30 g. (31.5 ml.) of technical dimethylaniline in 105 ml. of concentrated hydrochloric acid contained in a 600 ml. beaker, and add finely-crushed ice until the temperature falls below 5° . Stir the contents of the beaker mechanically (or, less satisfactorily, with a thermometer) and slowly add (*ca.* 10 minutes) a solution of 18 g. of sodium nitrite in 30 ml. of water from a separatory funnel, the stem of which dips beneath the surface of the liquid. Maintain the temperature below 8° by the

addition of ice, if necessary. When all the nitrite solution has been added, allow the mixture to stand for 1 hour, filter the yellow crystalline *p*-nitrosodimethylaniline hydrochloride at the pump, wash it with 40 ml. of dilute hydrochloric acid (1 : 1), drain well, and finally wash with a little alcohol. The yield is good and depends upon the purity of the original dimethylaniline. If the pure hydrochloride is required, it may be recrystallised from hot water in the presence of a little dilute hydrochloric acid; yellow needles, m.p. 177°. Recrystallisation is, however, unnecessary if the free base is to be prepared.

Transfer 30 g. of the hydrochloride to a 500 ml. separatory funnel, add 100 ml. of water and shake until a thin paste of uniform consistency is obtained; add 10 per cent. aqueous sodium hydroxide solution in the cold with shaking until the whole mass has become bright green (the colour of the free base) and the mixture has an alkaline reaction. Extract the free base by shaking with two 60 ml. portions of benzene (1). Dry the combined benzene extracts with a little anhydrous potassium carbonate, and filter into a distilling flask fitted with a water condenser. Distil off about half of the benzene, and pour the residual hot benzene solution into a beaker. Upon cooling, the *p*-nitrosodimethylaniline crystallises in deep green leaflets. Filter these off and dry them in the air. The yield of *p*-nitrosodimethylaniline, m.p. 85°, from the hydrochloride is almost quantitative.

Note.

(1) The base is only slightly soluble in ether, thus rendering its use uneconomical. It may be extracted with chloroform and precipitated from the dried chloroform solution with carbon tetrachloride.

COGNATE PREPARATION

***p*-Nitroso-*N*-methylaniline.** Dissolve 5 g. of *N*-nitrosomethylaniline (Section IV,40) in 10 ml. of anhydrous ether, and add 20 g. of a saturated solution of hydrogen chloride in absolute alcohol. Allow to stand. After some time a mass of crystalline needles of the hydrochloride of 4-nitroso-*N*-methylaniline separates. Filter with suction on a sintered glass funnel and wash with a mixture of alcohol and ether. Dissolve the solid in water and add a slight excess of sodium carbonate solution or dilute ammonia solution. Filter off the blue-green free base, and recrystallise it from benzene. The yield of *p*-nitroso-*N*-methylaniline, m.p. 118°, is 4.5 g.

IV,44.

m-NITROANILINE

Prepare a solution of sodium polysulphide by dissolving 40 g. of crystallised sodium sulphide, $\text{Na}_2\text{S} \cdot 9\text{H}_2\text{O}$ (1), in 150 ml. of water, adding 10 g. of finely powdered sulphur, and warming until a clear solution is produced. Heat a mixture of 25 g. of *m*-dinitrobenzene (Section IV,12) and 200 ml. of water contained in a 1-litre beaker until the water boils gently: stir the solution mechanically. Place the sodium polysulphide solution in a dropping funnel and clamp the funnel so that the end of the stem is immediately above the beaker. Add the sodium polysulphide solution during 30-45 minutes to the vigorously stirred, boiling mixture, and boil

gently for a further 20 minutes. Allow to cool ; this can be accomplished more rapidly by adding ice. Filter at the pump and wash with cold water. Transfer to a 600 ml. beaker containing 150 ml. of water and 35 ml. of concentrated hydrochloric acid, and boil for 15 minutes ; the *m*-nitroaniline dissolves leaving the sulphur and any unchanged *m*-dinitrobenzene. Filter and precipitate the *m*-nitroaniline from the filtrate by the addition of excess of concentrated aqueous ammonia solution. Filter off the product and recrystallise it from boiling water. The yield of *m*-nitroaniline (bright yellow needles) is 12 g. ; m.p. 114°.

Note.

(1) Crystallised sodium sulphide is very deliquescent and only a sample which has been kept in a tightly-stoppered bottle should be used.

ACETYLATION OF AROMATIC AMINES

Acetyl derivatives of aromatic amines may be prepared either with acetic anhydride or acetic acid or with a mixture of both reagents. Primary amines react readily upon warming with acetic anhydride to yield, in the first instance, the mono-acetyl derivative, for example :

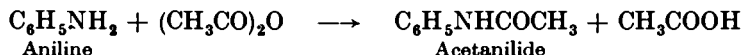

If the heating be prolonged and excess of acetic anhydride is employed, variable amounts of the diacetyl derivative are formed :

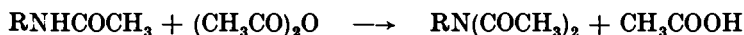

The production of diacetyl derivatives is facilitated by the presence of substituents in the *ortho* position: thus an excellent yield of diacetyl-*o*-toluidine results when *o*-toluidine is heated with an excess of the reagent :

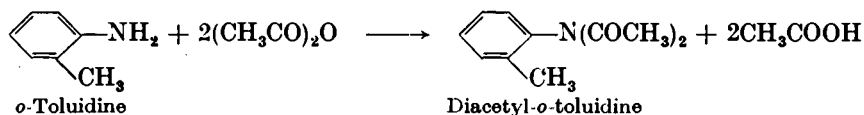

In general, however, the diacetyl derivatives are unstable in the presence of water, undergoing hydrolysis to the mono-acetyl compound, so that when they (or a mixture of mono- and di-acetyl derivatives) are crystallised from an aqueous solvent, *e.g.*, dilute alcohol, only the mono-acetyl derivative is obtained. A further disadvantage of the use of acetic anhydride in the absence of a solvent is that all the impurities in the amine are generally present in the reaction product. Heavily substituted amines, *e.g.*, 2 : 4 : 6-tribromoaniline, react extremely slowly with acetic anhydride, but in the presence of a few drops of concentrated sulphuric acid as catalyst acetylation occurs rapidly, for example :

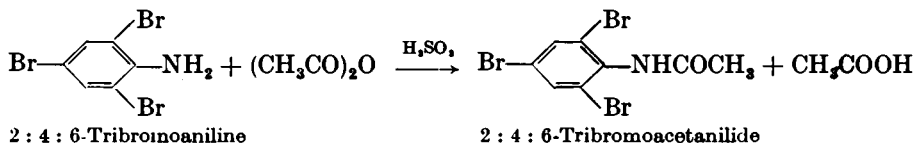

The disadvantages attending the use of acetic anhydride alone are absent when the acetylation is conducted in aqueous solution according to the following procedure. The amine is dissolved in water containing one equivalent of hydrochloric acid, slightly more than one equivalent of acetic anhydride is added to the solution, followed by enough sodium acetate to neutralise the hydrochloric acid, and the mixture is shaken. The free amine which is liberated is at once acetylated. It must be pointed out that the hydrolysis of acetic anhydride at room temperature is extremely slow and that the free amine reacts much more readily with the anhydride than does the water: this forms the experimental basis for the above excellent method of acetylation.

Acetylation with acetic anhydride is comparatively expensive because of the cost of the reagent. The use of the inexpensive glacial acetic acid depends upon the displacement of the reversible equilibrium :

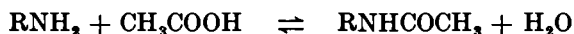

to the right by removal of the water (and a little acetic acid) by distillation. An alternative technique, suitable for laboratory preparations, is to employ a mixture of acetic acid and acetic anhydride.

Mono-substitution products of primary amines cannot easily be prepared by direct action of the appropriate reagent; for example, bromination of aniline yields largely the 2:4:6-tribromo derivative and nitration results in much oxidation. If, however, the amino group is protected as in acetanilide, smooth substitution occurs. Thus with bromine, *p*-bromoacetanilide is the main product; the small quantity of the *ortho* isomeride simultaneously formed can be easily eliminated by crystallisation. Hydrolysis of *p*-bromoacetanilide gives *p*-bromoaniline:

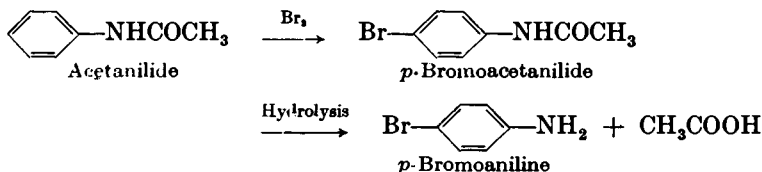

Nitration leads similarly to *p*-nitroacetanilide, which can be hydrolysed to *p*-nitroaniline:

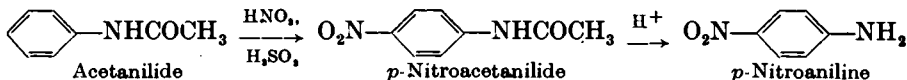

IV,45.

ACETANILIDE

Method 1. In a 1 litre beaker or flask containing 500 ml. of water, introduce 18.3 ml. of concentrated hydrochloric acid and 20.5 g. (20 ml.) of aniline. Stir until the aniline passes completely into solution. (If the solution is coloured, add 3–4 g. of decolourising carbon, warm to about 50° with stirring for 5 minutes, and filter at the pump or through a fluted filter paper.) To the resulting solution add 27.7 g. (25.6 ml.) of redistilled acetic anhydride, stir until it is dissolved, and immediately pour in a solution of 33 g. of crystallised sodium acetate in 100 ml. of water. Stir vigorously and cool in ice. Filter the acetanilide with suction, wash with a little water, drain well, and dry upon filter paper in the air. The yield of colourless, almost pure acetanilide, m.p. 113°, is 24 g. Upon recrystallisation from about 500 ml. of boiling water to which about 10 ml. of methylated spirit has been added (compare *Method 3*), the m.p. is raised to 114°; the first crop weighs 19 g.

Method 2. In a 500 ml. round-bottomed flask, equipped with a reflux condenser, place 20.5 g. (20 ml.) of aniline, 21.5 g. (20 ml.) of acetic anhydride, 21 g. (20 ml.) of glacial acetic acid, and 0.1 g. of zinc dust (1). Boil the mixture gently for 30 minutes, and then pour the hot liquid in a thin stream into a 1 litre beaker containing 500 ml. of cold water whilst stirring continually. When cold (it is preferable to cool in ice), filter the crude product at the pump, wash with a little cold water, drain well and dry upon filter paper in the air. The yield of acetanilide, m.p. 113°, is 30 g. It may be recrystallised as in *Method 1* affording 21 g. of pure acetanilide, m.p. 114°.

Method 3. Fit up the apparatus shown in Fig. IV, 45, 1 using a 250-ml. round-bottomed flask. Do not pass water through the glass jacket since the condenser will be employed only as an air condenser: the empty filter flask is used merely as a trap to prevent the escape of vapours into

the atmosphere. Place 20.5 g. (20 ml.) of aniline, 26 g. (25 ml.) of glacial acetic acid, and 0.1 g. of zinc dust (1) in the flask, and boil the mixture over a wire gauze at such a rate that the thermometer reads about 105°. After 2-3 hours, the water formed in the reaction together with a little acetic acid will have been driven off, and the temperature registered by the

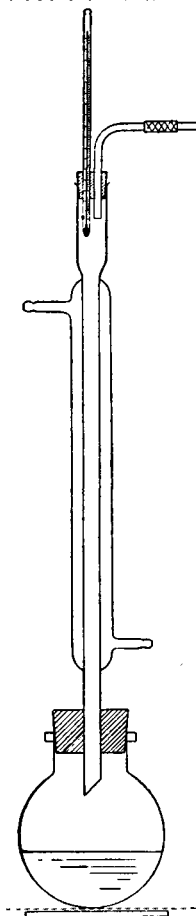

Fig. IV, 45, 1.

thermometer will commence to fluctuate: the process is then complete. Pour the hot liquid (2) in a thin stream into a 1 litre beaker containing 500 ml. of water. Stir the mixture well and cool in cold water or, preferably, in ice. Collect the crude acetanilide on a Buchner funnel and wash it with cold water. Place the moist acetanilide in a large beaker or porcelain dish, and add gradually about 750 ml. of boiling water (3). It must be remembered that the crude acetanilide melts slightly below 114°; the substance may therefore melt when heated with water (for theoretical explanation, see Section I,18). All the material, liquid or solid, must be dissolved: the addition of a little alcohol will assist the process of solution. Filter, if necessary, through a hot water funnel (Fig. II, 1, 6) or through a Buchner funnel through which boiling water has been poured. If the solution is coloured, add 3-4 g. of decolourising carbon before filtration. Allow the solution to cool, filter when cold, drain well, and dry upon filter paper in the air. The yield of pure acetanilide, m.p. 114°, is 19 g.

Notes.

(1) The zinc reduces the coloured impurities in the aniline and also helps to prevent oxidation of the amine during the reaction.

(2) If the reaction mixture is allowed to cool, it will set to a solid cake in the flask.

(3) The acetanilide may also be recrystallised from toluene (*inflammable*): use a reflux condenser. For practice, recrystallise 5 g. from 50 ml. of toluene.

IV,46.

DIACETYL-*o*-TOLUIDINE

Boil a mixture of 10 g. (10 ml.) of *o*-toluidine and 38 g. (35 ml.) of acetic anhydride in a 75 or 100 ml. Claisen flask fitted with a reflux condenser (Fig. III, 28, 1, but with trap replaced by a calcium chloride or cotton wool guard tube) for 1 hour. Arrange the flask for distillation under reduced pressure (compare Fig. II, 20, 1) and distil: acetic acid and the excess of acetic anhydride pass over first, followed by the diacetyl derivative at 152-153°/20 mm.: some mono-acetyl-*o*-toluidine (1-2 g.) remains in the flask. The yield of diacetyl-*o*-toluidine is 14-15 g.; it is a colourless, somewhat unstable liquid, which slowly solidifies to yield crystals, m.p. 18°.

To prepare the (mono-) acetyl-*o*-toluidine, warm a mixture of 5 g.

(5 ml.) of *o*-toluidine and 5.5 g. (5 ml.) of acetic anhydride over a free flame for 2 minutes, and pour the hot mixture into 100 ml. of cold water. Stir the mixture, warm to decompose any excess of acetic anhydride if present, and allow to cool. Filter at the pump, wash with cold water, and recrystallise from alcohol. The yield is 6 g., m.p. 110°.

IV,47. 2 : 4 : 6-TRIBROMOACETANILIDE

2 : 4 : 6-Tribromoaniline. Assemble the apparatus depicted in Fig. IV, 47, 1. The distilling flask *B* has a capacity of 100 ml. and the bolt-head flask *A* (which may be replaced by a flat-bottomed flask) is 1 litre. Into the flask place 10 g. of aniline, 100 ml. of water and 10 ml. of concentrated hydrochloric acid; shake until the aniline has dissolved and dilute with 400 ml. of water. Charge the distilling flask with 60 g. (19 ml.) of bromine. Surround the flask *A* by an ice bath and immerse the flask *B* in a water bath maintained at 30–40°. Interpose a wash bottle partially filled with water between the reaction flask and a water pump; this will permit the rate of aspiration to be observed and will also serve to detect the escape of bromine vapours from the reaction flask since a small amount of bromine will impart a distinctly yellow colour to the water. Apply gentle suction by means of a water pump. Continue the passage of bromine vapour until the solution in *A* assumes a distinctly yellow colour (2–3 hours); the reaction is then complete. Filter the tribromoaniline on a Buchner funnel, wash it thoroughly with water to remove hydrobromic acid, and suck as dry as possible. Recrystallise from methylated (or rectified) spirit. The yield is 22 g.; m.p. 120°.

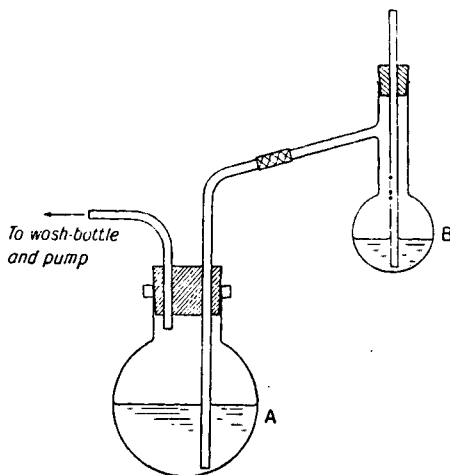
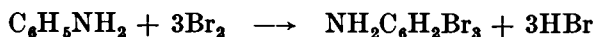

Fig. IV, 47, 1.



An alternative method of preparation consists in dissolving the aniline in 4 times its weight of glacial acetic acid in a beaker, and running in slowly from a tap funnel, while the solution is well stirred with a mechanical stirrer, the theoretical amount of bromine dissolved in twice its volume of glacial acetic acid. The beaker should be cooled in ice during the addition as the reaction is exothermic. The final product (a pasty mass) should be coloured yellow by the addition of a little more bromine if necessary. Pour into excess of water, filter at the pump, wash well with water, press thoroughly, and dry. The yield of tribromoaniline, m.p. 119–120°, is quantitative. Recrystallise a small portion from methylated (or rectified) spirit; m.p. 120°.

2 : 4 : 6-Tribromoacetanilide. Dissolve 1 g. of 2 : 4 : 6-tribromoaniline in 20 ml. of acetic anhydride and add 2 drops of concentrated

sulphuric acid. After 10 minutes, pour the reaction mixture into excess of warm water. Filter off the tribromoacetanilide, wash and dry: the m.p. is 231°. Recrystallise from alcohol: the m.p. is raised to 232°.

IV,48.

p-BROMOACETANILIDE

Dissolve 13.5 g. of finely powdered acetanilide in 45 ml. of glacial acetic acid in a 350 ml. conical flask. In another small flask dissolve 17 g. (5.3 ml.) of bromine in 25 ml. of glacial acetic acid, and transfer the solution to a burette or a separatory funnel supported over the flask. [For precautions attending the use of bromine, see Section III,35, Note 1. The preparation should be conducted in a fume cupboard.] Add the bromine solution slowly and with constant shaking to ensure thorough mixing: stand the flask in cold water. When all the bromine has been added, the solution will have an orange colour due to the slight excess of bromine; a part of the reaction product may crystallise out. Allow the final reaction mixture to stand at room temperature for 30 minutes with occasional shaking. Pour the reaction product into 400 ml. of water; rinse the flask with about 100 ml. of water. Stir the mixture well and if it is appreciably coloured, add just sufficient sodium bisulphite solution to remove the orange colour. Filter the crystalline precipitate with suction on a Buchner funnel, wash thoroughly with cold water, and press as dry as possible with a wide glass stopper. Recrystallise from dilute methyl alcohol or ethyl alcohol (methylated spirit). The yield of *p*-bromoacetanilide, colourless crystals m.p. 167°, is 18 g.

IV,49.

p-BROMOANILINE

Method 1 (Acid hydrolysis). Dissolve 18 g. of *p*-bromoacetanilide in 35 ml. of boiling ethanol contained in a 500 ml. round-bottomed flask equipped with a reflux condenser. Support a separatory funnel by means of a grooved cork in the top of the condenser, and charge it with 22 ml. of concentrated hydrochloric acid. Add the hydrochloric acid in small portions to the boiling solution. Reflux for 30-40 minutes or until a test portion remains clear when diluted with water. Dilute with 150 ml. of water, and fit the flask with a wide delivery tube leading to a condenser set for downward distillation (compare Fig. II, 13, 3). Distil the mixture from an air bath (Fig. II, 5, 3) or upon an asbestos-centred wire gauze, and collect about 100 ml. of distillate; the latter consists of ethyl acetate, ethyl alcohol and water. Pour the residual solution of *p*-bromoaniline hydrochloride into 100 ml. of ice water, and add, with vigorous stirring, 5 per cent. sodium hydroxide solution until just alkaline. The *p*-bromoaniline separates as an oil, which soon crystallises. Filter the crystals at the pump, wash with cold water, and dry in the air upon pads of filter paper. The yield is 14 g., m.p. 66°. Recrystallisation from dilute alcohol, which results in appreciable loss, is usually unnecessary.

Method 2 (Alkaline hydrolysis). Use a solution of 15 g. of *p*-bromoacetanilide in 30 ml. of boiling ethyl alcohol, and add a solution of 7.5 g. of potassium hydroxide in 10 ml. of water. Reflux for 40 minutes, dilute with 120 ml. of water, and distil until 75 ml. of distillate (alcohol and water) are collected; pour the residue into 150 ml. of cold water.

The *p*-bromoaniline separates as an oil, which soon solidifies. Filter at the pump and wash with cold water. Purify the crude *p*-bromoaniline as follows. Dissolve it in a mixture of 120 ml. of water and 75 ml. of concentrated hydrochloric acid, add 1–2 g. of decolourising carbon, and warm on a water bath for 10 minutes. Filter through a fluted paper or through two thicknesses of filter paper on a Buchner funnel. Pour the filtrate *slowly* and with vigorous stirring into a mixture of 60 ml. of 10 per cent. sodium hydroxide solution and 100 g. of crushed ice. The *p*-bromoaniline crystallises out. Filter, etc. as in *Method 1*. The yield is 11·5 g.

IV,50.***p*-NITROACETANILIDE**

Add 25 g. of finely powdered, dry acetanilide to 25 ml. of glacial acetic acid contained in a 500 ml. beaker; introduce into the well-stirred mixture 92 g. (50 ml.) of concentrated sulphuric acid. The mixture becomes warm and a clear solution results. Surround the beaker with a freezing mixture of ice and salt, and stir the solution mechanically. Support a separatory funnel, containing a cold mixture of 15·5 g. (11 ml.) of concentrated nitric acid and 12·5 g. (7 ml.) of concentrated sulphuric acid, over the beaker. When the temperature of the solution falls to 0–2°, run in the acid mixture gradually while the temperature is maintained below 10°. After all the mixed acid has been added, remove the beaker from the freezing mixture, and allow it to stand at room temperature for 1 hour. Pour the reaction mixture on to 250 g. of crushed ice (or into 500 ml. of cold water), whereby the crude nitroacetanilide is at once precipitated. Allow to stand for 15 minutes, filter with suction on a Buchner funnel, wash it thoroughly with cold water until free from acids (test the wash water), and drain well. Recrystallise the pale yellow product from alcohol or methylated spirit (see Section IV,12 for experimental details), filter at the pump, wash with a little cold alcohol, and dry in the air upon filter paper. [The yellow *o*-nitroacetanilide remains in the filtrate.] The yield of *p*-nitroacetanilide, a colourless crystalline solid of m.p. 214°, is 20 g.

IV,51.***p*-NITROANILINE**

Heat a mixture of 15 g. of *p*-nitroacetanilide and 75 ml. of 70 per cent. sulphuric acid (1) under a reflux water condenser for 20–30 minutes or until a test sample remains clear upon dilution with 2–3 times its volume of water. The *p*-nitroaniline is now present in the liquid as the sulphate. Pour the clear hot solution into 500 ml. of cold water and precipitate the *p*-nitroaniline by adding excess of 10 per cent. sodium hydroxide solution or of concentrated ammonia solution. When cold (cool the mixture in ice water, if necessary), filter the yellow crystalline precipitate at the pump, wash it well with water, and drain thoroughly. Recrystallise it from a mixture of equal volumes of rectified (or methylated) spirit and water or from hot water. Filter, wash and dry. The yield of *p*-nitroaniline, m.p. 148°, is 11 g.

Note.

(1) The 70 per cent. sulphuric acid is prepared by adding 60 ml. of concentrated sulphuric acid cautiously and in a thin stream with stirring to 45 ml. of water.

BENZOYLATION OF AROMATIC AMINES

In general, benzylation of aromatic amines finds less application than acetylation in preparative work, but the process is often employed for the identification and characterisation of aromatic amines (and also of hydroxy compounds). Benzoyl chloride (Section IV, 185) is the reagent commonly used. This reagent is so slowly hydrolysed by water that benzylation can be carried out in an aqueous medium. In the Schotten-Baumann method of benzylation the amino compound or its salt is dissolved or suspended in a slight excess of 8–15 per cent. sodium hydroxide solution, a small excess (about 10–15 per cent. more than the theoretical quantity) of benzoyl chloride is then added and the mixture vigorously shaken in a stoppered vessel (or else the mixture is stirred mechanically). Benzylation proceeds smoothly and the sparingly soluble benzoyl derivative usually separates as a solid. The sodium hydroxide hydrolyses the excess of benzoyl chloride, yielding sodium benzoate and sodium chloride, which remain in solution :



The benzoyl compounds frequently occlude traces of unchanged benzoyl chloride, which thus escape hydrolysis by the caustic alkali; it is therefore advisable, wherever possible, to recrystallise the benzoyl derivatives from methyl, or ethyl alcohol or methylated spirit, since these solvents will esterify the unchanged chloride and so remove the latter from the recrystallised material. Sometimes the benzoyl compound does not crystallise well: this difficulty may frequently be overcome by the use of *p*-nitrobenzoyl chloride or 3:5-dinitrobenzoyl chloride, which usually give highly crystalline derivatives of high melting point (see Section IV, 114).

Examples of benzylation under Schotten-Baumann conditions are:—

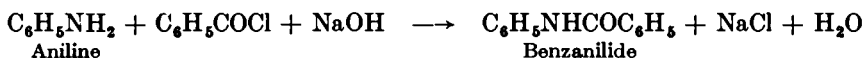

Benzanilide is more conveniently prepared, particularly on a larger scale, by heating together aniline and benzoic acid :

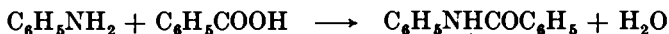

Benzoyl compounds are readily hydrolysed by heating with about 70 per cent. sulphuric acid (alkaline hydrolysis is very slow for anilides) :

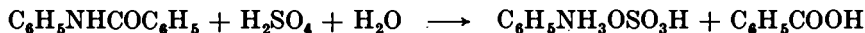

This procedure is of importance in connexion with the identification of substituted amines.

IV.52. BENZANILIDE (*Schotten-Baumann Reaction*)

Place 5.2 g. (5 ml.) of aniline and 45 ml. of 10 per cent. aqueous sodium hydroxide solution in a wide-necked bottle (or, if not available, a conical flask), and then add 8.5 g. (7 ml.) of benzoyl chloride, stopper, and shake vigorously for 10–15 minutes. Heat is evolved in the reaction. The crude benzoyl derivative separates as a white powder. When the reaction is complete (*i.e.*, when the odour of benzoyl chloride can no longer be detected: smell cautiously), make sure that the reaction mixture is

alkaline. Dilute with water. Filter off the product with suction on a Buchner funnel, break up the mass on the filter (if necessary), wash well with water, and drain. Recrystallise from hot alcohol (or methylated spirit); filter the hot solution through a hot water funnel or through a warm Buchner funnel. Collect the crystals which separate and dry in the air or in the steam oven. The yield of benzanilide, m.p. 162° , is 9 g.

Hydrolysis of benzanilide. Place 5 g. of benzanilide and 50 ml. of 70 per cent. sulphuric acid* in a small flask fitted with a reflux condenser, and boil gently for 30 minutes. Some of the benzoic acid will vapourise in the steam and solidify in the condenser. Pour 60 ml. of hot water down the condenser: this will dislodge and partially dissolve the benzoic acid. Cool the flask in ice water; filter off the benzoic acid (aniline sulphate does not separate at this dilution), wash well with water, drain, dry upon filter paper, and identify by m.p. (121°) and other tests. Render the filtrate alkaline by cautiously adding 10 per cent. sodium hydroxide solution, cool and isolate the aniline by ether extraction. Recover the ether and test the residue for aniline (Section IV,100).

COGNATE PREPARATION

Benzoyl *p*-toluidide. Use 3.3 g. of *p*-toluidine, 25 ml. of 10 per cent. sodium hydroxide solution and 4.2 g. (3.5 ml.) of benzoyl chloride. Proceed as above. The yield of benzoyl *p*-toluidide, m.p. 158° , is 4.5 g.

IV.53.

BENZANILIDE

Into a 500 ml. round-bottomed flask place 150 g. (147 ml.) of aniline and 125 g. of benzoic acid; melt the mixture to reduce the total volume and add a further 75 g. of benzoic acid. Immerse the flask in an oil bath and connect it to a condenser for downward distillation. Raise the temperature of the oil bath rapidly to $180-190^{\circ}$; distillation then commences. Maintain the temperature of the bath at $180-190^{\circ}$ until no more aniline and water distils (about 2 hours), then raise the temperature slowly to 225° and hold the bath at this temperature until distillation ceases (1-2 hours). Remove the flask from the oil bath and when the contents have cooled below 180° , add 110 g. (107.5 ml.) of aniline. Repeat the distillation at $180-190^{\circ}$ and 225° as before (4-6 hours). Pour the hot mixture into a large evaporating dish and allow it to solidify. Powder the purplish-grey solid very finely, and pour it with vigorous stirring into a 2- or 3-litre beaker containing a mixture of 100 ml. of concentrated hydrochloric acid and 1100 ml. of water. Continue the mechanical stirring for 1 hour. Filter the solid with suction on a Buchner funnel. Repeat the stirring with acid twice in order to remove the aniline as completely as possible. Stir the solid for 1 hour with 1200 ml. of water, and filter. Again stir for 1 hour with 1200 ml. of *ca.* *N*. sodium hydroxide solution to remove the excess of benzoic acid and filter at the pump. Finally stir for 2 hours with 1500 ml. of water, filter, drain, dry in the air upon sheets of filter paper, then dry to constant weight upon large clock glasses at $90-100^{\circ}$. The resulting crude benzanilide is purplish-grey, weighs 260 g. and melts at $158-160^{\circ}$. It is pure enough for most practical purposes, but can be further purified as follows. Dissolve 100 g. in 750 ml.

* Seventy per cent. sulphuric acid is prepared by adding 40 ml. of the concentrated acid cautiously and with stirring and cooling to 30 ml. of water.

of hot ethyl alcohol, add 10 g. of decolourising carbon, and boil for a short time; filter through a hot water funnel and leave to crystallise overnight. Collect the almost colourless crystals on a Buchner funnel and dry them; the yield is 85 g., m.p. 161°.

IV,54. HIPPURIC ACID (BENZOYL GLYCINE)

Dissolve 5 g. of glycine (Section III,129) in 50 ml. of 10 per cent. sodium hydroxide solution contained in a wide-mouthed bottle or in a conical flask. Add 10·8 g. (9·0 ml.) of benzoyl chloride in five portions to the solution. Stopper the vessel and shake vigorously after each addition until all the chloride has reacted. Transfer the solution to a beaker and rinse the bottle (conical flask) with a little water. Place a few grams of crushed ice in the solution and add concentrated hydrochloric acid slowly and with stirring until the mixture is acid to Congo red paper. Collect the resulting crystalline precipitate of hippuric acid (benzoyl aminoacetic acid), which is contaminated with a little benzoic acid, upon a Buchner funnel, wash with cold water and drain well. Place the solid in a small beaker with 20 ml. of carbon tetrachloride, cover the beaker with a watch glass and boil the mixture gently for 10 minutes (1). Allow the mixture to cool slightly, filter by gentle suction, and wash the hippuric acid on the filter with 3-4 ml. of carbon tetrachloride. Recrystallise from boiling water (about 100 ml.) with the addition of a little decolourising carbon if necessary, filter through a hot water funnel, and allow to crystallise. Collect the pure hippuric acid in a Buchner funnel and dry it in the steam oven. The yield is 9 g., m.p. 187°.

Note.

(1) The carbon tetrachloride extraction removes any benzoic acid which may be present.

SULPHONATION OF AROMATIC AMINES

If aniline is treated with excess of concentrated sulphuric acid and the resulting mixture, which contains aniline sulphate, is heated at 180° until a test portion when mixed with sodium hydroxide solution no longer liberates aniline, *p*-aminobenzenesulphonic acid or **sulphanilic acid** is formed; this separates as the dihydrate upon pouring the cooled mixture into water. The reaction probably proceeds as follows :

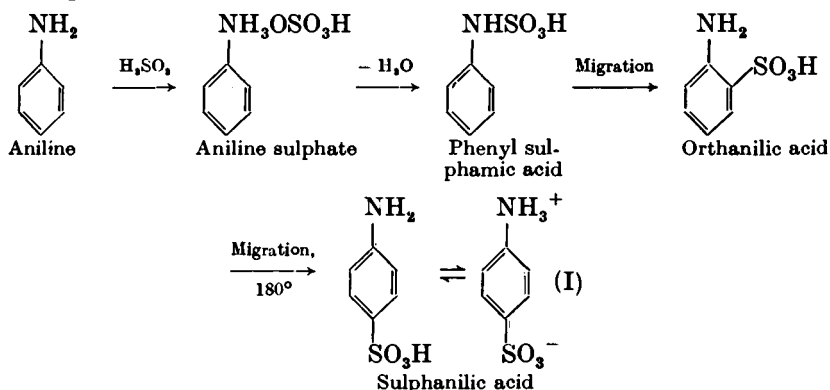

The suggested mechanism involves the initial loss of water from aniline mono-sulphate with the formation of phenyl sulphamic acid; upon gentle heating the $-\text{SO}_3\text{H}$ group migrates first to the *ortho* position to give orthanilic acid, and at a higher temperature (180°) rearranges to sulphanilic acid. It is believed that sulphanilic acid exists largely as the double charged ion (I) in aqueous solution.

α -Naphthylamine similarly yields 1-naphthylamine-4-sulphonic acid or **naphthionic acid** :

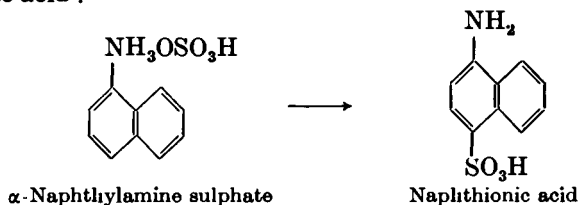

o-Aminobenzenesulphonic acid or **orthanilic acid** may be prepared from commercial *o*-chloronitrobenzene by the following procedure :

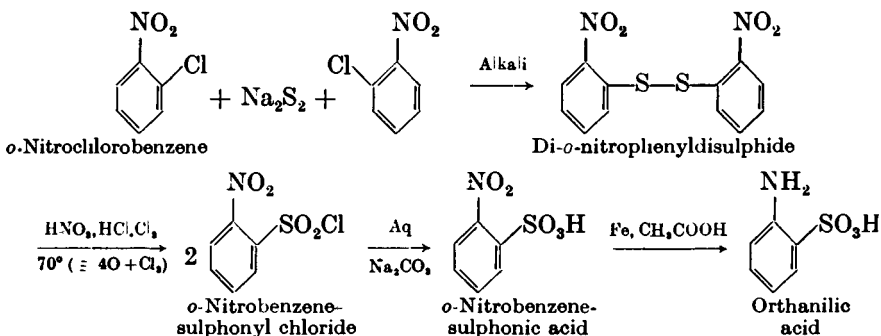

m-Aminobenzenesulphonic acid or metanilic acid is prepared by sulphonating nitrobenzene with fuming sulphuric acid (20 per cent. SO_3) and reducing the resulting *m*-nitrobenzenesulphonic acid with iron filings and water :

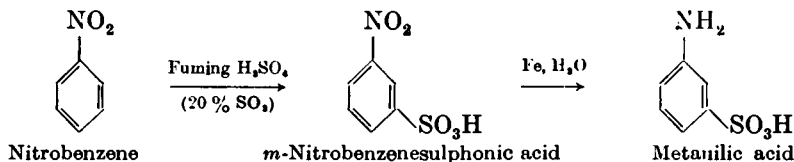

IV.55.

SULPHANILIC ACID

Place 20.4 g. (20 ml.) of aniline in a 250 ml. conical or round-bottomed flask and cautiously add 74 g. (40 ml.) of concentrated sulphuric acid in small portions ; swirl the mixture gently during the addition and keep it cool by occasionally immersing the flask in cold water. Support the flask in an oil bath, and heat the mixture at 180–190° (fume cupboard) for about 5 hours (1). The sulphonation is complete when a test portion (2 drops) is completely dissolved by 3–4 ml. of *ca.* 2*N* sodium hydroxide solution without leaving the solution cloudy. Allow the product to cool to about 50° and pour it carefully with stirring into 400 g. of cold water or of crushed ice. Allow to stand for 10 minutes, and collect the precipitated sulphanilic acid on a Buchner funnel, wash it well with water, and drain. Dissolve the crude sulphanilic acid in the minimum volume of boiling water (450–500 ml.) ; if the resulting solution is coloured, add about 4 g. of decolourising carbon and boil for 10–15 minutes. Filter through a hot water funnel (Fig. II, 1, 6) or through a Buchner funnel and flask which have been preheated by the filtration of boiling distilled water. Upon cooling, the sulphanilic acid dihydrate separates in colourless crystals. When the filtrate is quite cold, filter the crystals with suction, wash with about 10 ml. of cold water, and press thoroughly with a wide glass stopper. Dry between sheets of special absorbent paper or in a desiccator containing anhydrous calcium chloride ; in the latter case, the water of crystallisation (and hence the crystalline form) is lost. The yield of sulphanilic acid is 20–22 g. The substance does not melt sharply and no attempt should be made to determine the melting point ; the crystals are efflorescent.

Note.

(1) If 40 ml. of 10 per cent. oleum be cautiously added to the aniline sulphate mixture, sulphonation proceeds much more rapidly and the time of heating is reduced from 5 hours to 1 hour.

IV.56.

NAPHTHIONIC ACID

Place a mixture of 25 g. of α -naphthylamine (Section IV,37) and 125 g. (69.5 ml.) of concentrated sulphuric acid in a 250 ml. conical or round-bottomed flask, and heat in an oil bath for 4–5 hours or until a test sample, when made alkaline with sodium hydroxide solution and extracted with ether, yields no naphthylamine upon evaporation of the ether. Pour the warm reaction mixture cautiously and with stirring into 300 ml. of cold

water; the difficultly soluble naphthionic acid, which may be contaminated with a little naphthylamine sulphate, separates out. When cold, filter off the acid at the pump and wash it with cold water until free from sulphuric acid. Dissolve the crude naphthionic acid in the minimum volume (about 350 ml.) of 5 per cent. sodium hydroxide solution (*i.e.*, until about neutral) and saturate the resulting solution of sodium naphthionate with common salt. Allow to stand, when sodium naphthionate separates as white crystals. Filter with suction, drain, and dry in the steam oven. Place the solid in a small beaker with 20 ml. of carbon tetrachloride, cover the beaker with a watch glass and boil the mixture gently on a water bath for 10 minutes, filter by gentle suction, and wash the sodium naphthionate with a little solvent. This process removes any naphthylamine which may be present. The yield of sodium naphthionate is 20–35 g.; this is the form commonly encountered in commerce. To prepare the free acid, dissolve the sodium salt in the minimum volume of boiling water, add the calculated quantity of concentrated hydrochloric acid corresponding to the weight of sodium salt employed (acid to Congo red), and allow to cool. Collect the resulting naphthionic acid hemihydrate upon a Buchner funnel, wash with a little cold water, drain well, and dry upon filter paper or in the steam oven. If desired, it may be recrystallised from boiling water. The yield is 10–18 g.

IV.57.

ORTHANILIC ACID

Di-*o*-nitrophenyl disulphide. Place 120 g. of crystallised sodium sulphide (1) and 500 ml. of rectified spirit in a 1-litre round-bottomed flask provided with a reflux condenser. Heat the flask on a water bath until the sulphide dissolves. Then add 16 g. of finely-powdered sulphur and continue the heating until all the sulphur dissolves forming a brownish-red solution of sodium disulphide (2). Prepare a solution of 105 g. of commercial *o*-nitrochlorobenzene in 175 ml. of rectified spirit in a 2-litre round-bottomed flask equipped with a reflux condenser; by means of a dropping funnel, fitted into the top of the condenser with a grooved cork, add the sodium disulphide solution slowly and at such a rate that the reaction is under control. Heat the mixture on a water bath, gently at first until the violent reaction subsides, and then with the water boiling vigorously for 2 hours. Allow to cool. Filter with suction on a Buchner funnel. Transfer the mixture of organic disulphide and sodium chloride to a 400 ml. beaker and stir thoroughly with 175 ml. of water to remove the salt. Filter at the pump, drain well, and wash the crystalline residue on the filter with 35 ml. of alcohol to remove any unreacted *o*-chloronitrobenzene. The residual di-*o*-nitrophenyl disulphide melts at 193–195° and weighs 70 g.

Notes.

(1) Crystallised sodium sulphide $\text{Na}_2\text{S}\cdot 9\text{H}_2\text{O}$ is very deliquescent, and only a sample which has been kept in a tightly-stoppered bottle should be used; crystals as dry as possible should be selected. Alternatively, an equivalent amount of analysed fused sodium sulphide may be employed; this dissolves somewhat more slowly in alcohol.

(2) If some sodium disulphide separates at the bottom of the flask, this should be dissolved in a little more rectified spirit and added to the chloronitrobenzene solution.

***o*-Nitrobenzenesulphonyl chloride.** Equip a 1-litre three-necked flask with an inlet tube for introducing chlorine well beneath the surface of the liquid (compare Section III,125), an efficient liquid-sealed stirrer, and a reflux condenser. Set up the assembly in the fume cupboard and absorb the excess of chlorine in sodium hydroxide solution as detailed under *Chloroacetic Acid* (Section III,125). Place 60 g. of di-*o*-nitrophenyl disulphide, 300 ml. of concentrated hydrochloric acid and 60 ml. of concentrated nitric acid in the flask, pass a stream of chlorine from a cylinder into the mixture at the rate of 2 bubbles per second, and warm the solution to 70° on a water bath. After about 30 minutes, the disulphide melts and the solution assumes an orange-red colour; after the melting stage has been reached, the passage of the chlorine and the heating are continued for 1 hour. Immediately separate the sulphonyl chloride from the supernatant liquid by decantation, wash with two 90 ml. portions of water at about 70°, and allow to solidify. Drain the water from the solid mass as completely as possible. Dissolve the sulphonyl chloride in 45 ml. of glacial acetic acid at 50–60°, and rapidly filter the solution at the pump. Cool the filtrate in cold water and stir it vigorously so that the sulphonyl chloride separates in small crystals. Triturate the mixture well with 300 ml. of cold water and decant through a Buchner funnel; repeat the process twice. Finally add 300 ml. of cold water and 3 ml. of concentrated ammonia solution to the mixture, stir well and filter immediately, through a Buchner funnel, wash with 60 ml. of water, drain well, and dry in the air. The yield of moderately pure *o*-nitrobenzenesulphonyl chloride, m.p. 64–65°, is 72 g. The undried material may be used in the preparation of orthanilic acid.

Orthanilic acid. Fit a 1-litre three-necked flask with a liquid-sealed mechanical stirrer and a reflux condenser. Place 60 g. of *o*-nitrobenzenesulphonyl chloride, 30 g. of anhydrous sodium carbonate and 180 ml. of water in the flask. Heat the mixture to boiling, with stirring; the hydrolysis of the sulphonyl chloride to the sulphonic acid is complete within 40 minutes after the compound has melted. Filter the orange-red solution and acidify (to litmus) with acetic acid (about 7.5 ml. are required). Transfer the solution to the original flask (which has been thoroughly rinsed with water) and equipped as before. Heat the solution to boiling, and add 105 g. of finely-divided iron filings (about 20 mesh) with vigorous stirring at the rate of about 7.5 g. every 15 minutes. The mixture soon becomes deep brown and exhibits a tendency to froth. Complete the reaction by stirring for a further 4 hours, *i.e.*, until a test portion when filtered yields an almost colourless filtrate; if the filtrate is orange or red, the heating and stirring must be continued. When the reduction is complete, add 2 g. of decolourising carbon, filter the hot reaction mixture at the pump, and wash the residue with three 15 ml. portions of hot water: combine the washings with the main solution. Cool the filtrate to about 15°, and add 28.5 ml. of concentrated hydrochloric acid slowly, and cool to 12–15°. Filter the acid with suction on a Buchner funnel, wash with a little cold water, followed by a little ethyl alcohol, and dry upon filter paper in the air. The yield is 97 g.; the orthanilic acid has a purity of 97–99 per cent. If required perfectly pure, it may be recrystallised from hot water; it decomposes at about 325°.

IV,58.

METANILIC ACID

In a 500 ml. bolt-head flask, provided with a mechanical stirrer, place 70 ml. of oleum (20 per cent. SO_3) and heat it in an oil bath to 70° . By means of a separatory funnel, supported so that the stem is just above the surface of the acid, introduce 41 g. (34 ml.) of nitrobenzene slowly and at such a rate that the temperature of the well-stirred mixture does not rise above $100\text{--}105^\circ$. When all the nitrobenzene has been introduced, continue the heating at $110\text{--}115^\circ$ for 30 minutes. Remove a test portion and add it to the excess of water. If the odour of nitrobenzene is still apparent, add a further 10 ml. of fuming sulphuric acid, and heat at $110\text{--}115^\circ$ for 15 minutes: the reaction mixture should then be free from nitrobenzene. Allow the mixture to cool and pour it with good mechanical stirring on to 200 g. of finely-crushed ice contained in a beaker. All the nitrobenzenesulphonic acid passes into solution; if a little sulphone is present, remove this by filtration. Stir the solution mechanically and add 70 g. of sodium chloride in small portions: the sodium salt of *m*-nitrobenzenesulphonic acid separates as a pasty mass. Continue the stirring for about 30 minutes, allow to stand overnight, filter and press the cake well. The latter will retain sufficient acid to render unnecessary the addition of acid in the subsequent reduction with iron. Spread upon filter paper to dry partially.

Place 84 g. of iron filings and 340 ml. of water in a 1.5 or 2-litre bolt-head flask equipped with a mechanical stirrer. Heat the mixture to boiling, stir mechanically, and add the sodium *m*-nitrobenzenesulphonate in small portions during 1 hour. After each addition the mixture foams extensively: a wet cloth should be applied to the neck of the flask if the mixture tends to froth over the sides. Replace from time to time the water which has evaporated so that the volume is approximately constant. When all the sodium salt has been introduced, boil the mixture for 20 minutes. Place a small drop of the suspension upon filter paper and observe the colour of the "spot": it should be a pale brown but not deep brown or deep yellow. If it is not appreciably coloured, add anhydrous sodium carbonate cautiously, stirring the mixture, until red litmus paper is turned blue and a test drop upon filter paper is not blackened by sodium sulphide solution. Filter at the pump and wash well with hot water. Concentrate the filtrate to about 200 ml., acidify with concentrated hydrochloric acid to Congo red, and allow to cool. Filter off the metanilic acid and dry upon filter paper. A further small quantity may be obtained by concentrating the mother liquid. The yield is 55 g.

DIAZONIUM SALTS

Primary aromatic amines differ from primary aliphatic amines in their reaction with nitrous acid. Whereas the latter yield the corresponding alcohols ($\text{RNH}_2 \rightarrow \text{ROH}$) without formation of intermediate products (see Section III, 123, test (i)), primary aromatic amines yield diazonium salts. Thus aniline gives phenyldiazonium chloride (sometimes termed benzene-diazonium chloride) $\{\text{C}_6\text{H}_5\text{N}_2\}^+\text{Cl}^-$; the exact mode of formation is not known, but a possible route is through the phenylnitrosoammonium ion thus :

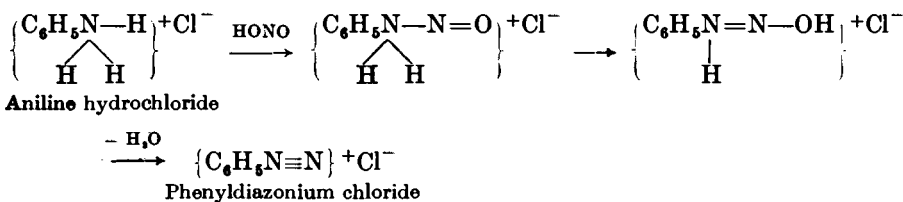

Phenyldiazonium chloride and other similar diazonium compounds are very soluble in water, are completely insoluble in ether and other organic solvents, and are completely dissociated in aqueous solution to organic cations and inorganic anions (*e.g.*, chloride ions) : a convenient formulation is therefore, for example, $\text{C}_6\text{H}_5\text{N}_2^+\text{Cl}^-$.

The experimental conditions necessary for the preparation of a solution of a diazonium salt, diazotisation of a primary amine, are as follows. The amine is dissolved in a suitable volume of water containing 2.5-3 * equivalents of hydrochloric acid (or of sulphuric acid) by the application of heat if necessary, and the solution is cooled in ice when the amine hydrochloride (or sulphate) usually crystallises. The temperature is maintained at 0-5°, an aqueous solution of sodium nitrite is added portion-wise until, after allowing 3-4 minutes for reaction, the solution gives an *immediate* positive test for excess of nitrous acid with an external indicator—moist potassium iodide-starch paper † :

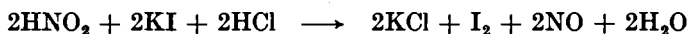

The precipitated amine hydrochloride (or sulphate), if any, dissolves during the diazotisation to give a clear solution of the highly soluble diazonium salt. The general reaction may be written :

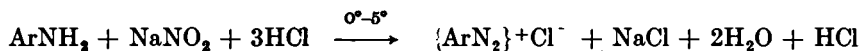

The excess of acid (0.5-1 equivalents) maintains a proper condition of acidity required to stabilise the diazonium salt solution by reducing the secondary

* In those cases where a large excess of acid is harmful, the proportion may be reduced to 2.2 equivalents.

† In actual practice it is found that some time before the theoretical quantity of sodium nitrite has been added, the solution will give a blue colouration (presumably, in part, by atmospheric oxidation) within a few seconds of being placed upon the test paper. It must, however, be remembered that towards the end of the diazotisation the reaction with nitrous acid is somewhat slow, and it is imperative to wait a few minutes before making the test, and furthermore only an *immediate* blue colouration has any significance. It is advisable to dilute the drop of the test solution with a few drops of water on a watch glass before making the test. It is recommended that about 10 per cent. excess of sodium nitrite of good quality (97-98 per cent. NaNO_2 ; *e.g.*, sodium nitrite recryst. or A.R.) be employed; this will serve as an additional check. If a slight excess of sodium nitrite is accidentally added, it may be decomposed by the addition of a little urea or sulphamic acid; alternatively a small amount of the primary amine, dissolved in the acid used, may be added.

changes to a minimum, *e.g.*, the interaction of some of the diazonium salt with unchanged amine to form a diazoamino compound, a reaction which occurs readily in neutral solution :

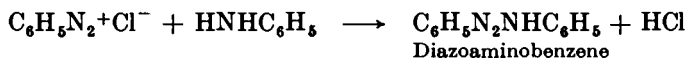

The amines are comparatively weak bases, so that a certain amount of free amine will be produced by salt hydrolysis unless an excess of acid is present. The reaction mixture must be kept very cold during the process (which is exothermic in character), otherwise the diazonium salt may be partially converted into the corresponding hydroxy compound :

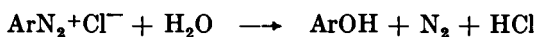

Some amines, such as the nitroanilines and the naphthylamines, give somewhat more stable diazonium compounds and may be diazotised at room temperature, when the reaction proceeds more rapidly. If the amine salt is only sparingly soluble in water, it should be suspended in the acid in a fine state of division (this is generally attained by cooling a hot solution and stirring vigorously), and it passes into solution as the soluble diazonium salt is formed.

To prepare the solid phenyldiazonium chloride or sulphate, the reaction is conducted in the absence of water as far as possible. Thus the source of nitrous acid is one of its organic esters (*e.g.*, amyl nitrite) and a solution of hydrogen chloride gas in absolute alcohol; upon the addition of ether only the diazonium salt is precipitated as a crystalline solid, for example :

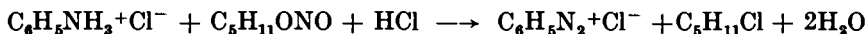

Solid diazonium salts are very sensitive to shock when perfectly dry and detonate violently upon gentle heating: they are, therefore, of little value for preparative work. Happily, most of the useful reactions of diazonium compounds can be carried out with the readily-accessible aqueous solutions, so that the solid (explosive) diazonium salts are rarely required.

When an aqueous solution of phenyldiazonium chloride or of *p*-tolyl-diazonium hydrogen sulphate is treated with an equivalent of potassium iodide and warmed on a water bath, iodobenzene or *p*-iodotoluene is formed in good yield :

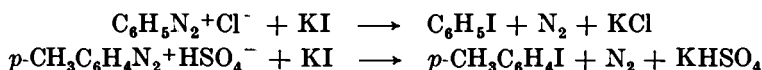

This simple procedure cannot be applied in the preparation of the corresponding chloro and bromo compounds. Sandmeyer (1884) found that the replacement of the diazonium group by halogen can be successfully accomplished in the presence of the appropriate cuprous salt, thus providing an excellent method for the preparation of nuclear substituted aromatic compounds from the corresponding amines. The reaction has been extended to groups other than halogens, for example, the cyano (—CN) and the thiocyanate (—SCN) radicals. The detailed technique of the Sandmeyer reaction may be illustrated by reference to the preparation of *p*-chlorotoluene from *p*-toluidine. The amine is diazotised in the presence of hydrochloric acid with sodium nitrite at 0–5°, and a solution of an equimolecular quantity of cuprous chloride in hydrochloric acid is added; a deep brown, sparingly soluble complex of cuprous chloride and

the diazonium salt is formed (e.g., $\text{CH}_3\text{C}_6\text{H}_4\text{N}_2\text{Cl}, \text{CuCl}$), and when the temperature is raised, decomposition ensues accompanied by the evolution of nitrogen, the disappearance of the solid and the separation of an oily layer of *p*-chlorotoluene:

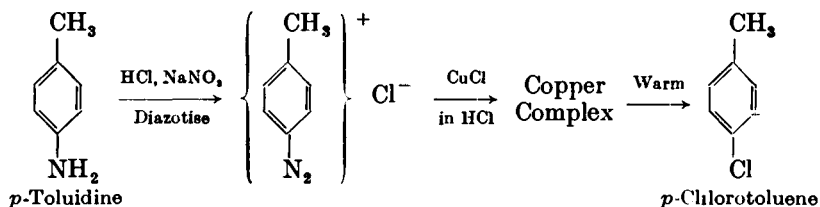

The following *mechanism* of the Sandmeyer reaction has been proposed as a result of a kinetic study, and incidentally accounts for the formation of the azo compounds as by-products. The catalyst is the CuCl_2^- ion produced in the dissolution of cuprous chloride in the chloride solution:

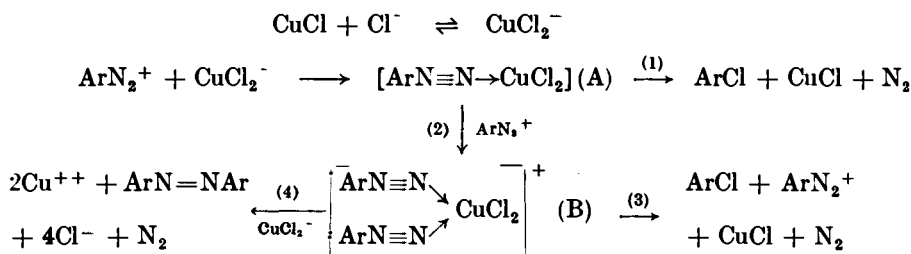

The complex (A) is formed by coordination of the terminal diazo nitrogen atom with the copper in CuCl_2^- . This complex decomposes into ArCl (1). The complex (A) may also react with more ArN_2^+ to give the complex (B), and this may decompose to give ArCl (3) and the azo compound (4). When ArN_2^+ is present in large concentration (as when all or most is added at the outset), step (2) is faster than step (1), so that most of the ArCl arises from step (3). The yield of azo compound depends upon the CuCl_2^- concentration. If ArN_2^+ is kept low by a gradual addition technique, reaction (1) predominates and, in consequence, the yield of azo compound is small.

The following additional examples of cognate preparations are given:

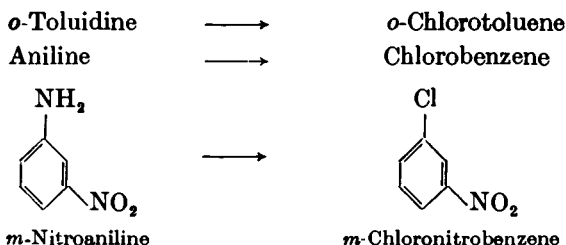

In the preparation of bromo compounds by the Sandmeyer reaction, the amine is generally diazotised in sulphuric acid solution (or in hydrobromic acid solution), and the resulting aryldiazonium sulphate (or bromide) is treated with a solution of cuprous bromide in excess of hydrobromic acid; the addition

complex is then decomposed by gentle heating and the bromo compound isolated by steam distillation, for example :

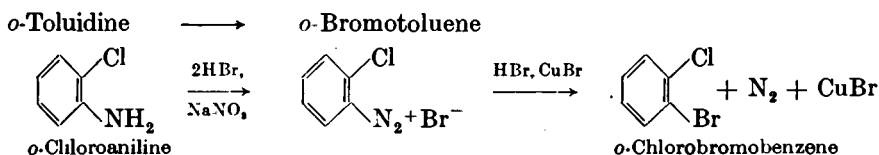
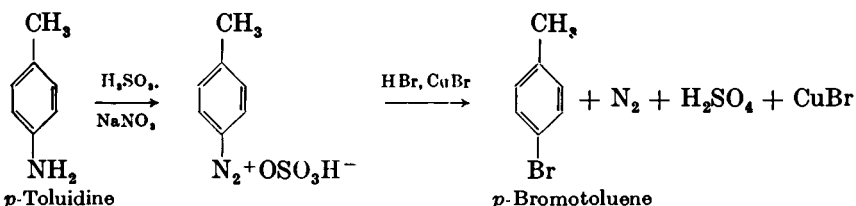

For the preparation of *m*-bromotoluene, the following sequence of reactions from *p*-toluidine may be used :

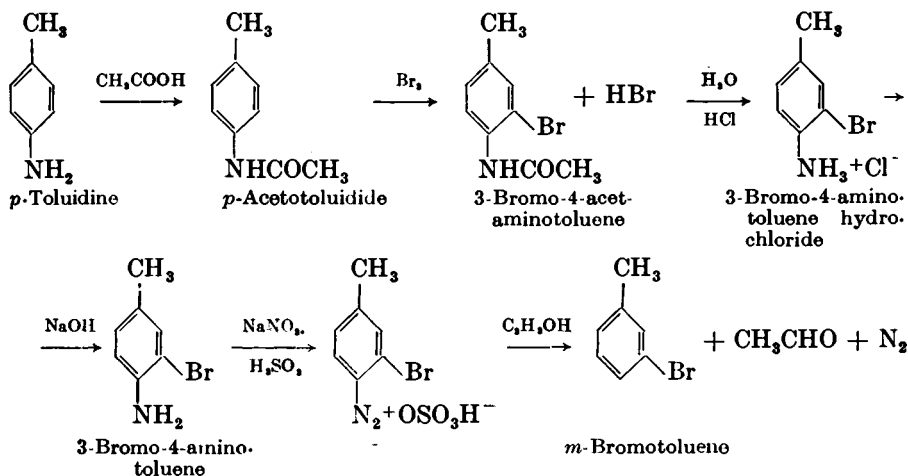

Gattermann (1890) found that the preparation of the cuprous halide may be avoided by making use of the fact that finely-divided copper (*e.g.*, freshly-precipitated or "reduced by hydrogen" or copper bronze) acts catalytically in the decomposition of solutions of diazonium salts, for example :

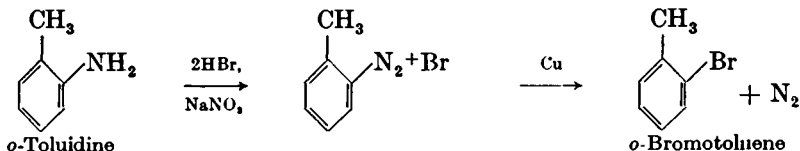

The yields by the Gattermann reaction are usually not as high as those by Sandmeyer's method. Copper powder is also employed in the preparation of sulphinic acids, for example :

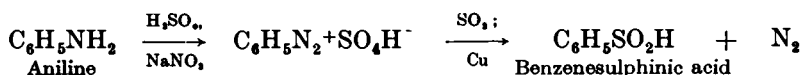

The Sandmeyer reaction may also be applied to the preparation of nitriles. The solution of the diazonium salt is added to a solution of cuprous cyanide in excess of sodium or potassium cyanide solution (sometimes improved yields are obtained by substituting nickel cyanide for cuprous cyanide), for example :

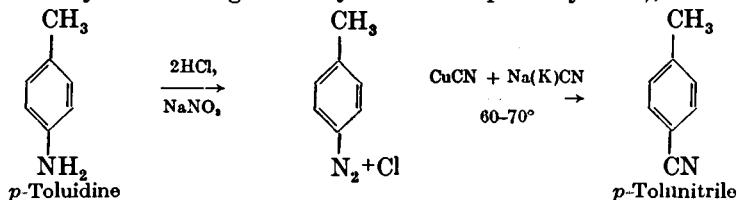

Similarly aniline $\text{C}_6\text{H}_5\text{NH}_2$ is converted into benzonitrile $\text{C}_6\text{H}_5\text{CN}$. Hydrolysis of the nitrile with sodium hydroxide solution, followed by acidification, yields the corresponding acid, for example :

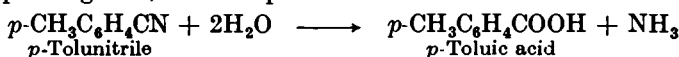

By adding a concentrated solution of sodium borofluoride to a solution of a diazonium salt, the diazonium fluoborate is precipitated; this decomposes into the aryl fluoride when cautiously heated, for example :

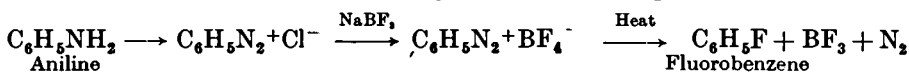

The boron trifluoride is absorbed in sodium hydroxide solution. Similarly *p*-toluidine $\text{p-CH}_3\text{C}_6\text{H}_4\text{NH}_2$ yields *p*-fluorotoluene $\text{p-CH}_3\text{C}_6\text{H}_4\text{F}$.

The controlled thermal decomposition of dry aromatic diazonium fluoborates to yield an aromatic fluoride, boron trifluoride and nitrogen is known as the Schiemann reaction. Most diazonium fluoborates have definite decomposition temperatures and the rates of decomposition, with few exceptions, are easily controlled. Another procedure for preparing the diazonium fluoborate is to diazotise in the presence of the fluoborate ion. Fluoboric acid may be the only acid present, thus acting as acid and source of fluoborate ion. The insoluble fluoborate separates as it is formed; side reactions, such as phenol formation and coupling, are held at a minimum; temperature control is not usually critical and the temperature may rise to about 20° without ill effect; efficient stirring is, however, necessary since a continuously thickening precipitate is formed as the reaction proceeds. The modified procedure is illustrated by the preparation of *p*-fluoroanisole :

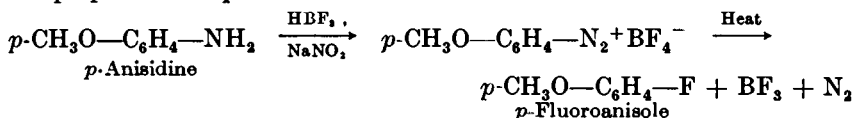

The mechanism of the Schiemann reaction is not known with certainty. Two schemes, which have been proposed, are given below. One involves carbonium ion formation :

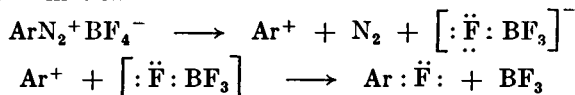

Another postulates the intermediate formation of a free radical :

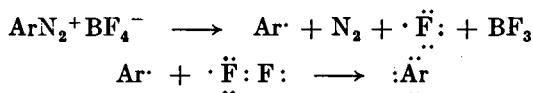

An interesting application of the diazo reaction is to the preparation of the otherwise difficultly accessible *o*- and *p*-dinitrobenzenes; *o*- or *p*-nitrophenyl-diazonium fluoroborates react with sodium nitrite in the presence of copper powder to yield *o*- or *p*-dinitrobenzene :

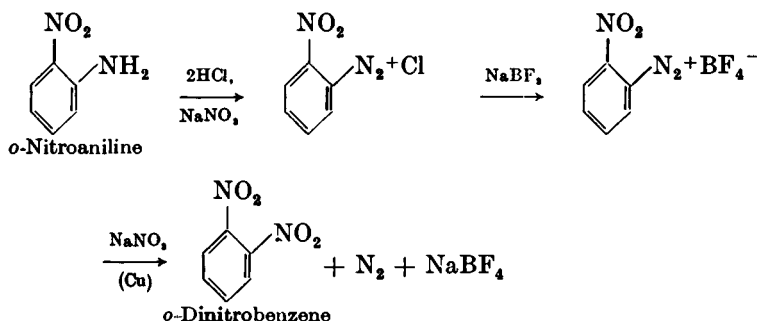

It may be mentioned that diazonium fluoroborates containing the nitro group usually decompose suddenly and with violence upon heating, hence if *o*- or *p*-fluoronitrobenzene are required, the fluoroborates (in 10-20 g. quantities) should be mixed with 3-4 times their weight of pure dry sand (or barium sulphate or sodium fluoride) and heated cautiously until decomposition commences; intermittent heating will be required to complete the reaction.

When a solution of a diazonium salt is heated, the diazo group is replaced by hydroxyl and nitrogen is evolved :

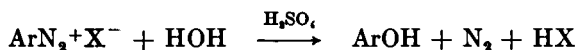

The diazonium hydrogen sulphate is used in preference to the diazonium chloride, because the latter gives small quantities of the chloro compound as a by-product :

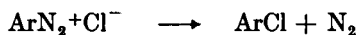

The solution must be strongly acid in order to avoid the coupling reaction between the undecomposed diazonium salt and the phenol (see under *Azo Dyes*). For the preparation of phenol and the cresols, the aqueous solution of the diazonium compound is warmed to about 50°; at higher temperatures the reaction may become unduly vigorous and lead to appreciable quantities of tarry compounds :

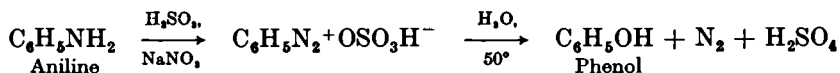

Similarly $\text{CH}_3\text{C}_6\text{H}_4\text{NH}_2$ (toluidines) \longrightarrow $\text{CH}_3\text{C}_6\text{H}_4\text{OH}$ (cresols).

For certain substituted amines, a higher temperature (*e.g.*, boiling 40-60 per cent. sulphuric acid) is necessary to decompose the diazonium salt completely, for example :

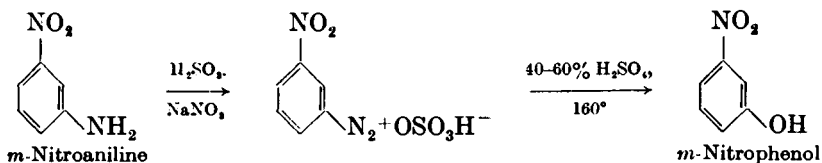

The diazonium group may be replaced by hydrogen, thus effecting the removal of the primary amino group, **deamination**, by the following methods:

(i) By boiling with ethyl alcohol :



An example of this is given in Section IV,63—the conversion of 3-bromo-4-aminotoluene into *m*-bromotoluene. Another application is to the preparation of *sym*.-tribromobenzene (Section IV,72) :

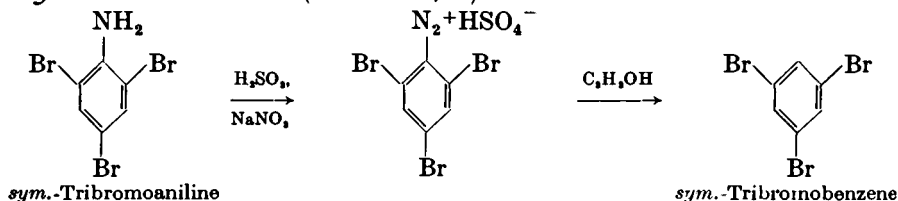

With simple aromatic compounds, appreciable quantities of the corresponding ethyl ethers are formed as by-products :

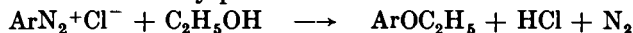

so that deamination with ethyl alcohol does not give a pure product.

(ii) By the use of an alkali stannite solution, for example :

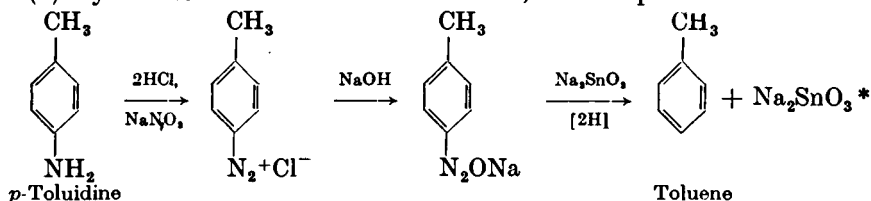

(iii) By treatment with a large excess of hypophosphorous acid, for example:

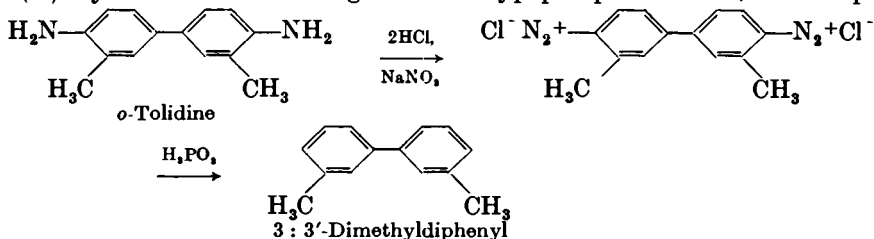

Alkaline formaldehyde solution has also been employed for deamination.

An interesting coupling reaction with the diazonium salt derived from anthranilic acid leads to an excellent method for the preparation of diphenic acid. The reaction occurs with cuprous salts in ammoniacal solution :

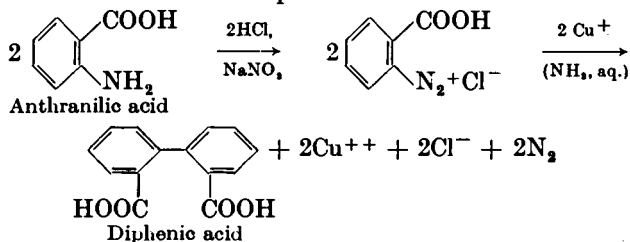

* It is possible that an unstable di-imine is first formed and rapidly loses nitrogen :



Phenylarsonic acid may be obtained from the reaction between phenyldiazonium chloride and sodium arsenite in the presence of a trace of copper sulphate :

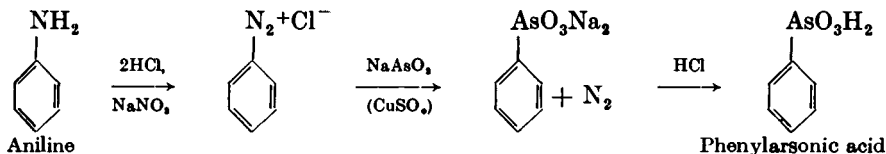

The conversion of an aromatic diazonium compound into the corresponding arsonic acid by treatment with sodium arsenite in the presence of a catalyst, such as copper or a copper salt, is called the **Bart reaction**. A modification of the reaction employs the more stable diazonium fluoborate in place of the diazonium chloride. This is illustrated by the preparation of *p*-nitrophenylarsonic acid :

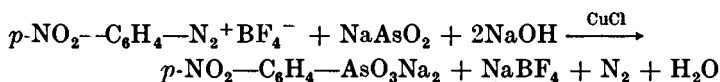

CAUTION. Diazonium compounds have been used for the preparation of :—

(a) Mercaptans—by treatment with a solution of sodium hydrogen sulphide, for example :

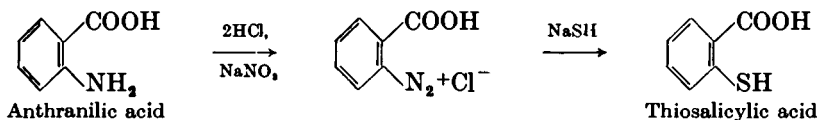

(b) Xanthogenates—by reaction with aqueous potassium xanthogenate, and thence to mercaptans by treatment with potassium hydroxide, for example :

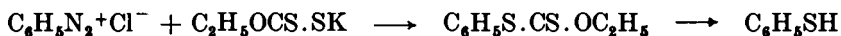

(c) Disulphides—by interaction with a solution of sodium disulphide.

It cannot be too strongly emphasised that in all these reactions violently explosive diazo sulphides and related compounds may be formed, and another less hazardous method for the preparation of the desired compound should be used, if possible. The following reactions are known to lead to dangerous explosions :—

(i) diazotised *o*-nitroaniline, *m*-chloroaniline, 4-chloro-*o*-toluidine or β -naphthylamine and sodium disulphide ;

(ii) diazotised *m*-nitroaniline and potassium xanthate ; and

(iii) diazotised aniline, *p*-bromoaniline, toluidines and naphthylamines and sodium hydrogen sulphide.

IV,59. SOLID PHENYLDIAZONIUM CHLORIDE

Dissolve 3.5 g. of aniline hydrochloride in 20 ml. of absolute ethyl alcohol contained in a 50 ml. conical flask, and add 0.5 ml. of a saturated solution of hydrogen chloride in absolute ethyl alcohol. Cool in ice and add 4 g. (4.6 ml.) of *iso*-amyl nitrite (compare Section III,53) gradually. Allow the mixture to stand for 5–10 minutes at the room temperature, and precipitate the diazonium salt by the gradual addition of ether. Filter off the crystals at the pump on a small Buchner funnel, wash it with 5 ml. of alcohol - ether (1 : 1), and then with 10 ml. of ether. Keep

the phenyldiazonium chloride moist with ether. Do not touch the material, even when it is moist with ether, with a spatula or hard object; it may explode. Allow not more than 0.5 g. to dry on a filter paper, and cautiously warm it in a flame; it will explode. Dissolve all the solid phenyldiazonium chloride in water; it is then rendered harmless.

COGNATE PREPARATION

Solid phenyldiazonium hydrogen sulphate. Dissolve 2.5 g. (2.5 ml.) of aniline in 25 ml. of absolute ethyl alcohol contained in a 50 ml. conical flask. (If rectified spirit, 95 per cent. C_2H_5OH , is used, the yield is somewhat diminished, but the stability of the preparation is increased and consequently the element of danger attending the preparation is slightly decreased.) Add 5 g. (2.75 ml.) of concentrated sulphuric acid very slowly and with continuous shaking; some aniline sulphate may crystallise out, but will dissolve at a later stage. Add 3.25 g. (3.5 ml.) *iso*-amyl nitrite drop by drop from a small tap funnel; throughout the addition keep the mixture well stirred with the thermometer, out of sunlight, and at a temperature of 30–35° (if necessary by gentle warming on a water bath, maintained not above 40°). When all the *iso*-amyl nitrite has been added, allow the solution to stand for 10 minutes to complete the reaction, and then immerse the flask in ice water for at least 15 minutes. The phenyldiazonium sulphate separates as colourless or pale green, needle-shaped crystals. Filter the crystals at the pump using a small Buchner funnel, and wash the solid with 3–4 ml. of absolute ethyl alcohol (or rectified spirit, see note above). Remember that phenyldiazonium sulphate should be not allowed to become quite dry, and should certainly not be touched with a hard object; an explosion may result. Immediately the preparation is complete, dissolve the product in water.

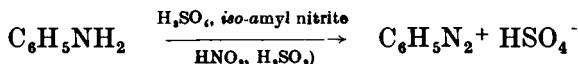

IV.60.

IODOBENZENE

Dissolve 20 g. (19.6 ml.) of aniline in a mixture of 55 ml. of concentrated hydrochloric acid (1) and 55 ml. of water contained in a 350 ml. conical flask. Place a thermometer in the solution and immerse the flask in a bath of crushed ice (2); cool until the temperature of the stirred solution falls below 5°. Dissolve 16 g. of sodium nitrite in 75 ml. of water and chill the solution by immersion in the ice bath; add the sodium nitrite solution (3) in small volumes (2–3 ml. at a time) to the cold aniline hydrochloride solution, and keep the latter well stirred with the thermometer. Heat is evolved by the reaction. The temperature should not be allowed to rise above 10° (add a few grams of ice to the reaction mixture if necessary) otherwise appreciable decomposition of the diazonium compound and of nitrous acid will occur. Add the last 5 per cent. of the sodium nitrite solution more slowly (say, about 1 ml. at a time) and, after stirring for 3–4 minutes, test a drop of the solution diluted with 3–4 drops of water with potassium iodide - starch paper (4); if no *immediate* blue colour

is obtained at the point of contact with the paper, add a further 1 ml. of the nitrite solution, and test again after 3-4 minutes. Continue until a slight excess of nitrous acid is present.

To the solution of phenyldiazonium chloride add a solution of 36 g. of potassium iodide in 40 ml. of water slowly and with shaking. Nitrogen is evolved. Allow the mixture to stand for a few hours. Fit the flask with an air condenser (5) and heat it cautiously in a boiling water bath until evolution of gas ceases. Allow to cool. Decant as much as possible of the upper aqueous layer and render the residual aqueous and organic layers alkaline by the cautious addition of 10 per cent. sodium hydroxide solution, *i.e.*, until a drop of the well-shaken mixture withdrawn on a glass rod imparts a blue colour to red litmus paper. The alkali converts any phenol present into sodium phenoxide, which, unlike phenol itself, is not volatile in steam. Immediately transfer the mixture to a steam distillation apparatus (Fig. II, 40, 1) and steam distil until no more oily drops pass over. Transfer the distillate to a separatory funnel and run off the lower layer of iodobenzene into a small conical flask. The crude iodobenzene should have a pale yellow colour; if it is dark in colour, return it to the separatory funnel and shake it with a little sodium bisulphite solution until a pale yellow colour is obtained, then remove the heavy layer as before. Dry with about 1 g. of anhydrous calcium chloride or anhydrous magnesium sulphate: filter through a fluted filter paper into a small distilling flask equipped with a short air condenser (Fig. II, 13, 2). Distil using an asbestos-centred wire gauze or, better, an air bath (Fig. II, 5, 3) and collect the fraction b.p. 185-190° (6). The yield of iodobenzene (an almost colourless liquid) is 33 g.; the compound gradually develops a yellow colour upon exposure to light.

Notes.

(1) In computing the volume of acid required in the diazotisation process, it is helpful to remember that 100 ml. of concentrated hydrochloric acid, sp. gr. 1.18, contain 42.4 g. of HCl, and 100 ml. of concentrated sulphuric acid, sp. gr. 1.84, contain 176 g. H₂SO₄.

(2) For preparations on a larger scale, a stoneware vessel may be conveniently employed and the lowering of temperature achieved by the addition of a quantity of crushed ice equal in weight to that of the hydrochloric acid and water. The mixture should be stirred mechanically.

(3) It is advisable to add the sodium nitrite solution, particularly in preparations on a larger scale, through a separatory or dropping funnel with the tip of the stem extending well below the surface of the liquid: this will prevent loss of nitrous acid by surface decomposition into oxides of nitrogen.

(4) It is advisable to test the potassium iodide-starch paper with acidified sodium nitrite solution: the commercial test paper is, particularly if it has been kept for a considerable period, sometimes almost 'useless.' The solution must contain an excess of acid at all times, *i.e.*, it must give a blue colour on Congo red paper.

(5) In large scale preparations, the mixture should be transferred to a large flask before heating.

(6) The iodobenzene is conveniently distilled under reduced pressure and the fraction b.p. 77-80°/20 mm. or 63-64°/8 mm. collected. The product has a higher degree of purity than that obtained directly from benzene (Section IV, 21).

COGNATE PREPARATIONS

***p*-Iodotoluene.** Use 27 g. of *p*-toluidine, 63 ml. of concentrated hydrochloric acid and 63 ml. of water: warm, if necessary, until all the amine dissolves. Cool the solution with vigorous stirring to 0-5° by

immersion in a freezing mixture of ice and salt and the addition of a little crushed ice. Diazotise by the introduction, with stirring (mechanical or with a thermometer), of a solution of 18.5 g. of sodium nitrite in 40 ml. of water; maintain the temperature of the solution at 0–5° if possible, but do not allow it to rise above 10°. Add a solution of 44 g. of potassium iodide in an equal weight of water gradually and with stirring. Allow to stand for 1 hour at the laboratory temperature and then heat cautiously on a water bath until evolution of nitrogen ceases. Allow to cool: a dark-coloured oil settles to the bottom and soon solidifies. Pour off as much of the aqueous layer as possible, add 1–2 g. of sodium bisulphite to remove the dark colour (gentle warming may be necessary), and then render the mixture alkaline with 10 per cent. sodium hydroxide solution in order to fix any cresol which may be formed. Steam distil the mixture and employ a beaker as the receiver; if the *p*-iodotoluidine solidifies in the condenser, turn off the condenser water for a few moments until the solid melts and runs down into the receiver. Filter off the solid in the receiver and recrystallise it from alcohol. The yield of *p*-iodotoluene (colourless plates), m.p. 35°, b.p. 211–212°, is 50 g.

***p*-Iodonitrobenzene.** Stir a mixture of 50 g. of *p*-nitroaniline (Section IV,51), 75 g. (41 ml.) of concentrated sulphuric acid and 300 ml. of water for 1 hour. Cool the mixture to 0–5°, and diazotise with a solution of 25 g. of sodium nitrite in 75 ml. of water. Filter the cold solution, and add the filtrate with stirring to a solution of 100 g. of potassium iodide in 300 ml. of water. Collect the precipitated solid by suction filtration and recrystallise it from ethyl alcohol. The yield of *p*-iodonitrobenzene, m.p. 151°, is 73 g.

IV,61.

***p*-CHLOROTOLUENE**

In a 1.5 or 2-litre round-bottomed flask, prepare cuprous chloride from 105 g. of crystallised copper sulphate as detailed in Section II,50, 1. Either wash the precipitate once by decantation or filter it at the pump and wash it with water containing a little sulphurous acid; dissolve it in 170 ml. of concentrated hydrochloric acid. Stopper the flask loosely (to prevent oxidation) and cool it in an ice-salt mixture whilst the diazotisation is being carried out.

Dissolve 36 g. of *p*-toluidine in 85 ml. of concentrated hydrochloric acid and 85 ml. of water contained in a 750 ml. conical flask or beaker. Cool the mixture to 0° in an ice-salt bath with vigorous stirring or shaking and the addition of a little crushed ice. The salt, *p*-toluidine hydrochloride, will separate as a finely-divided crystalline precipitate. Add during 10–15 minutes a solution of 24 g. of sodium nitrite in 50 ml. of water (1); shake or stir the solution well during the diazotisation, and keep the mixture at a temperature of 0–5° by the addition of a little crushed ice from time to time. The hydrochloride will dissolve as the very soluble diazonium salt is formed; when all the nitrite solution has been introduced, the solution should contain a trace of free nitrous acid. Test with potassium iodide-starch paper (see Section IV,60).

Pour the cold diazonium chloride solution slowly and with shaking into the cold cuprous chloride solution (2). The mixture becomes very

thick, owing to the separation of an addition product between the diazonium salt and the cuprous chloride ($\text{CH}_3\text{C}_6\text{H}_4\text{N}_2^+\text{Cl}^-$, CuCl). Allow the mixture to warm up to room temperature without external heating, and shake occasionally (3). When the temperature reaches about 15° , the solid addition complex commences to break down with the liberation of nitrogen and the formation of an oily layer of *p*-chlorotoluene. Warm the mixture on a water bath to about 60° to complete the decomposition of the double salt; shake occasionally. When the evolution of nitrogen ceases, steam distil the mixture (compare Fig. II, 40, 1) until no more oily drops are present in the distillate. Transfer the distillate to a separatory funnel, and remove the layer of *p*-chlorotoluene. Wash it successively with 30 ml. of 10 per cent. sodium hydroxide solution (to remove any *p*-cresol which may be present), water, an equal volume of concentrated sulphuric acid (to remove a trace of azo compound that usually colours the crude product and cannot be removed by distillation), and water (to remove the acid). Dry with 3-4 g. of anhydrous calcium chloride or anhydrous magnesium sulphate, decant or filter through a small fluted filter paper into a small distilling flask (Fig. II, 13, 2), and distil on an asbestos-centred gauze or from an air bath (Fig. II, 5, 3). Collect the *p*-chlorotoluene at $158\text{--}162^\circ$ (a colourless liquid; m.p. $6\text{--}7^\circ$); the yield is 33 g.

Notes.

(1) The sodium nitrite solution is conveniently added from a dropping funnel; it is recommended, particularly for preparations on a larger scale, that the tip of the stem of the funnel dip well below the surface of the liquid.

(2) The diazonium salt solution decomposes on standing and hence must be mixed with the cuprous chloride solution without delay. Mechanical stirring is an advantage.

(3) For preparations on a larger scale, mechanical stirring is essential and should be continued for 2-3 hours after the solution has attained room temperature.

COGNATE PREPARATIONS

***o*-Chlorotoluene.** Proceed as for *p*-chlorotoluene, but use 36 g. of *o*-toluidine. Collect the *o*-chlorotoluene at $155\text{--}158^\circ$; the yield is 33 g.

Chlorobenzene. Prepare a solution of phenyldiazonium chloride from 31 g. (30.5 ml.) of aniline, 85 ml. of concentrated hydrochloric acid, 85 ml. of water, and a solution of 24 g. of sodium nitrite in 50 ml. of water (for experimental details, see Section IV, 60). Prepare cuprous chloride from 105 g. of crystallised copper sulphate (Section II, 50, 1), and dissolve it in 170 ml. of concentrated hydrochloric acid. Add the cold phenyldiazonium chloride solution with shaking or stirring to the cold cuprous chloride solution; allow the mixture to warm up to room temperature. Follow the experimental details given above for *p*-chlorotoluene. Wash the chlorobenzene separated from the steam distillate with 40 ml. of 10 per cent. sodium hydroxide solution (to remove phenol), then with water, dry with anhydrous calcium chloride or magnesium sulphate, and distil. Collect the chlorobenzene (a colourless liquid) at $131\text{--}133^\circ$ (mainly 133°). The yield is 29 g.

***m*-Chloronitrobenzene.** This preparation is very similar to that of *p*-chlorotoluene, but certain modifications must be introduced. The quantities required are: 46 g. of *m*-nitroaniline (Section IV, 44), 85 ml. of concentrated hydrochloric acid, 85 ml. of water, and a solution of 24 g.

of sodium nitrite in 50 ml. of water (if the resulting diazonium salt solution is not clear, it must be filtered); cuprous chloride, from 105 g. of crystallised copper sulphate (Section II,50, 1), dissolved in 170 ml. of concentrated hydrochloric acid. Run the diazonium salt solution into the solution of cuprous chloride while the temperature is kept at 25–30° (water bath); at lower temperatures the decomposition of the unstable addition compound proceeds too slowly and would cause too violent an evolution of nitrogen upon warming, and at a higher temperature the formation of tarry by-products increases. Warm the mixture under a reflux condenser on a water bath until the evolution of nitrogen ceases. Steam distil (1); if the *m*-chloronitrobenzene solidifies in the condenser, turn off the condenser water for a few moments until the solid melts and runs down into the receiver. Allow the steam distillate to cool, decant the water, and shake the solid with 200 ml. of 1 per cent. sodium hydroxide solution at 50° (to remove *m*-nitrophenol, if present). Allow the mixture to cool, filter with suction, wash with a little cold water and dry in the air. Determine the m.p. If this is not satisfactory, *i.e.*, if it is appreciably below 44–45°, purify the product either by recrystallisation from a small volume of alcohol or preferably by distillation under diminished pressure (Figs. II, 19, 1 and II, 19, 3–4); it boils at 124–125°/18 mm. or 116–117°/12 mm. and the distillate solidifies to a pale yellow solid, m.p. 44–45°. The yield is 50–55 g., depending upon the purity of the original *m*-nitroaniline.

Note.

(1) The steam distillation may be omitted, if desired, by utilising the following method of purification. Allow the reaction mixture to cool, decant the aqueous layer and dissolve the residue in about 150 ml. of benzene. Wash the benzene solution with water, 1 per cent. sodium hydroxide solution, and finally with water; dry with anhydrous magnesium sulphate, distil off the benzene on a water bath, and distil the residue under diminished pressure.

IV,62. *p*-BROMOTOLUENE (by the Sandmeyer Reaction)

Method 1. Prepare a solution of cuprous bromide by refluxing 31.5 g. of crystallised copper sulphate, 10 g. of clean copper turnings, 77 g. of crystallised sodium bromide, 15 g. (8.2 ml.) of concentrated sulphuric acid and 500 ml. of water contained in a 2.5 litre round-bottomed flask over a flame for 3–4 hours until the solution acquires a yellowish colour; if the blue colour is not discharged, add a few grams of sodium bisulphite to complete the reduction.

In a 1 litre flask mix 53.5 g. of *p*-toluidine and 400 ml. of water, and then add cautiously 98 g. (53.5 ml.) of concentrated sulphuric acid; warm until the *p*-toluidine dissolves. Cool the flask in a bath of ice and salt to 0–5°; add about 100 g. of crushed ice to the contents of the flask in order to accelerate the cooling. Add slowly and with frequent shaking a solution of 35 g. of sodium nitrite in 60 ml. of water until a slight excess of sodium nitrite is present (see Section IV,60); keep the temperature of the mixture below 10°.

Equip the 2.5 litre flask holding the cuprous solution for steam distillation (Fig. II, 40, 1) with the addition of a third tube (7–8 mm. in diameter) leading almost to the bottom of the flask; attach a short-stemmed,

separatory funnel to this by means of a short length of rubber "pressure" tubing and support the funnel in a ring clamped to a retort stand. Heat the cuprous bromide solution to boiling, add the *p*-tolylidiazonium sulphate solution from the separatory funnel whilst steam is passed rapidly through the mixture. In order to reduce the amount of decomposition of the diazonium salt solution, transfer only about one-fourth to the separatory funnel (the remainder being kept in the freezing mixture) and run this into the cuprous bromide solution: when the funnel is nearly empty, transfer a further portion of the cold diazonium solution to it without interrupting the addition. Add all the diazonium solution in this way during 20–30 minutes. Continue the steam distillation until no more organic matter distils. Render the distillate alkaline with 20 per cent. sodium hydroxide solution (to remove any *p*-cresol present), shake well, and separate the crude *p*-bromotoluene. In order to obtain a colourless product, wash the crude substance with 40–50 ml. of warm (30°) concentrated sulphuric acid, then with water, sodium hydroxide solution, and finally with water. If the *p*-bromotoluene solidifies, warm the wash liquids to 30° before use; unless this is done, considerable loss may occur. Dry over anhydrous magnesium sulphate or calcium chloride, warm, filter, and distil through an air-cooled condenser (Fig. II, 13, 2). Collect the *p*-bromotoluene at 182–184°. The yield is 60 g.; m.p. 25–26°.

Method 2. Prepare 40 g. of cuprous bromide according to Section II, 50, 2 (about 75 g. of crystallised copper sulphate are required) and dissolve it in 40 ml. of constant boiling point hydrobromic acid (48% HBr) contained in a 2.5 litre round-bottomed flask.

Prepare a solution of *p*-tolylidiazonium chloride from 53.5 g. of *p*-toluidine using the proportions and experimental conditions given under *p*-Chlorotoluene (Section IV, 61). Add the diazonium chloride solution to the boiling cuprous bromide solution, and proceed as in *Method 1*. The yield of pure, colourless *p*-bromotoluene, b.p. 182–184° (mainly 183°), is 40 g.; m.p. 26°.

COGNATE PREPARATIONS

***o*-Bromotoluene.** Use 53.5 g. of *o*-toluidine and the other components as above. The yield of *o*-bromotoluene, b.p. 178–181°, is of the same order.

***o*-Chlorobromobenzene.** Place a mixture of 64 g. of *o*-chloroaniline (Section IV, 34) and 175 ml. of constant boiling point hydrobromic acid (sp. gr. 1.48; 100 ml. contains 71 g. of HBr) in a 1-litre flask set in an ice-salt bath, and cool it to 0–5° by the addition of a little ice. Add, with shaking or stirring, a solution of 35 g. of sodium nitrite in 70 ml. of water until a slight excess of nitrous acid is present (starch-potassium iodide paper test; Section IV, 60); maintain the temperature below 10° by the addition of ice if necessary. Prepare a solution of 40 g. of cuprous bromide in 40 ml. of 48 per cent. hydrobromic acid contained in a 2.5-litre round-bottomed flask (see *Method 2* above), heat to boiling, and add the *o*-chlorophenyldiazonium bromide solution as above. When all the latter has been introduced, pass steam through the mixture until no more organic material distils. Follow the procedure, including purification, given for *p*-Bromotoluene. Collect the *o*-chlorobromobenzene (a colourless liquid) at 200–202°. The yield is 85 g.

This procedure may be employed for *m*-chlorobromobenzene, b.p. 191–194° from *m*-chloroaniline; *m*-dibromobenzene, b.p. 215–217°, from *m*-bromoaniline; and *o*-bromoanisole, b.p. 114–116°/29 mm. from *o*-anisidine (the sulphuric acid washing is omitted in the last example).

β-Bromonaphthalene. The preparation from β-naphthylamine, which has carcinogenic properties, is avoided by the use of 2-naphthylamine-1-sulphonic acid ("2-amino-1-naphthalenesulphonic acid"); the latter is obtained commercially by cautious treatment of β-naphthol with sulphuric acid—the SO₃H group first enters the 1-position—followed by the Bucherer reaction. Diazotisation and reaction with cuprous bromide yields 2-bromonaphthalene-1-sulphonic acid; heating with sulphuric acid eliminates the sulphonic acid group to give 2-bromonaphthalene.

Dissolve 223 g. of 2-naphthylamine-1-sulphonic acid, with stirring, in 1700 ml. of 0.6*N* sodium hydroxide solution: add, with stirring, an aqueous solution of 69 g. of sodium nitrite, and filter the resulting solution. Place 500 ml. of concentrated hydrochloric acid and 200 g. of crushed ice in a 2½ gallon battery jar or earthenware crock and equip the latter with a mechanical stirrer. Introduce the filtered solution of sodium nitrite and sodium 2-naphthylamine-1-sulphonate* slowly with stirring, and maintain the temperature at 0–5° by adding crushed ice. Collect the reddish-brown precipitate which forms on a large Buchner funnel and wash it with about 1 litre of ice water. Whilst the diazotisation is in progress, suspend 320 g. of cuprous bromide (from 600 g. of crystallised copper sulphate; Section II,50,2) in 150 ml. of 48 per cent. hydrobromic acid and 400 ml. of water. Add the damp cake of the diazonium compound portionwise and with vigorous stirring to the cuprous bromide suspension contained in a 2.5 litre battery jar or beaker. After the vigorous evolution of nitrogen has subsided, heat the mixture to 95–100° on a steam bath and then filter the hot mixture through a large Buchner funnel. Pour the filtrate back into the battery jar and add 225 g. of potassium chloride with stirring. Allow the resulting paste to cool to room temperature, filter with suction, and wash with 500 ml. of 20 per cent. aqueous potassium chloride. Dry the reddish-brown precipitate of 2-bromonaphthalene-1-sulphonic acid in the air overnight, and transfer it to a 2.5 litre round-bottomed flask. Add dilute sulphuric acid (prepared from 400 ml. of the concentrated acid and 400 g. of crushed ice), attach a reflux condenser, and reflux the mixture gently, using an electric heating mantle, for 12–16 hours. Cool to room temperature; pour on to about 1 kg. of crushed ice. Transfer the mixture with the aid of 1 litre of benzene to a large separatory funnel, shake well, remove the benzene layer and wash the latter with water until the washings are neutral to litmus. Dry the benzene solution with anhydrous magnesium sulphate, remove the benzene at atmospheric pressure and distil the residue under reduced pressure. Collect the β-bromonaphthalene at 100–101°/2 mm. or at 140°/20 mm.; this solidifies to a pale yellow solid, m.p. 56–57°. The yield is 135 g.

The pale yellow colour cannot be removed by redistillation or recrystallisation; the coloured product probably contains some amino compound rendering it unsuitable for conversion into a Grignard reagent. A pure

* If the solid sodium salt is available, it may be dissolved in 1700 ml. of distilled water and a solution containing 69 g. of sodium nitrite added.

white product may be obtained by the following chromatographic procedure (see Section II,46). Dissolve 100 g. of the coloured compound in 350 ml. of *n*-hexane and pass the solution through a 3-4" column of activated alumina (80-200 mesh); wash the column with 300 ml. of *n*-hexane. Remove the *n*-hexane by distillation: 98 g. of pure β -bromonaphthalene, m.p. 58°, remains. This is sufficiently pure for use in Grignard reactions.

IV,63.

m-BROMOTOLUENE

The successive stages in the preparation are as follows:—

***p*-Acetotoluidide and *m*-bromo-*p*-acetotoluidide (3-bromo-4-acetaminotoluene).** Prepare a solution of *p*-acetotoluidide in glacial acetic acid by boiling 107 g. of *p*-toluidine with 400 ml. of glacial acetic acid in a 1-litre round-bottomed flask, provided with a reflux condenser, for 2 hours. Remove the reflux condenser, replace it by a mechanical stirrer, and stir the solution vigorously; some *p*-acetotoluidide may separate as small crystals as the temperature falls (1). When the temperature has fallen to about 45°, add 162.5 g. (51 ml.) of bromine from a separatory funnel at such a rate that the temperature of the well-stirred mixture is maintained at 50-55°. A precipitate may separate during the addition which requires 30-40 minutes, but this dissolves later. Continue the stirring for a further 30 minutes after all the bromine has been added. Then pour the reaction mixture in a thin stream into a well-stirred mixture of 1 kilo of crushed ice and 1 kilo of water to which 14 g. of solid sodium bisulphite has been added. If the colour of the bromine persists, add a little more sodium bisulphite. Filter the crystalline 3-bromo-4-acetaminotoluene with suction on a Buchner funnel, wash thoroughly with water and press well. Dry in the air until the weight does not exceed 250 g. (2); further purification is unnecessary before proceeding to the next stage.

3-Bromo-4-aminotoluene hydrochloride. Transfer the partially dried 3-bromo-4-acetaminotoluene to a 1.5-litre round-bottomed flask, add 250 ml. of rectified spirit, and reflux on a water bath until the solid dissolves completely. Introduce through the condenser 250 ml. of concentrated hydrochloric acid to the boiling solution and continue the refluxing for a further 3 hours. During this time crystals of 3-bromo-4-aminotoluene hydrochloride separate. Pour the hot mixture into a 1-litre beaker and cool thoroughly. Filter the crystals of the hydrochloride at the pump through a Buchner funnel and wash rapidly with two 50 ml. portions of chilled rectified spirit. The yield of the hydrochloride is 150 g.

3-Bromo-4-aminotoluene. Suspend the hydrochloride in 400 ml. of water in a 1-litre beaker equipped with a mechanical stirrer. Add a solution of 70 g. of sodium hydroxide in 350 ml. of water. The free base separates as a dark heavy oil. After cooling to 15-20°, transfer the mixture to a separatory funnel and run off the crude 3-bromo-4-aminotoluene. This weighs 125 g. and can be used directly in the next step (3).

***m*-Bromotoluene.** To a cold mixture of 400 ml. of rectified spirit and 100 ml. of concentrated sulphuric acid contained in a 2.5-litre round-bottomed flask, provided with an efficient mechanical stirrer, add 125 g. of crude 3-bromo-4-aminotoluene. Stir the solution and cool to 5°;

then add slowly a solution of 74 g. of pure sodium nitrite in 135 ml. of water from a separatory funnel taking care that the temperature does not rise above 10°. Continue the stirring for 20 minutes after all the nitrite solution has been added in order to complete the diazotisation (test with potassium iodide - starch paper for the presence of free nitrous acid). Add 17.5 g. of copper bronze (which has been washed with ether) or copper powder (Section II, 50, 4) to the diazotised solution, and replace the stirrer by a long double surface condenser. Have an ice bath at hand to cool the flask if the reaction becomes too vigorous. Warm the flask *cautiously* on a water bath until a vigorous evolution of gas commences, then immerse at once in an ice bath to prevent loss through the condenser by too rapid evolution of nitrogen and acetaldehyde. When the reaction has subsided, again warm the flask gently, and finally heat on a boiling water bath for 10 minutes. At the end of the reaction, the colour of the solution changes from reddish-brown to yellow. Add 1 litre of water and steam distil the mixture as long as oily drops pass over. Separate the heavy yellow oil, wash it with two 100 ml. portions of 10 per cent. sodium hydroxide solution, once with 50 ml. of water, twice with 75 ml. portions of ice-cold concentrated sulphuric acid, once with 50 ml. of water, and finally with 50 ml. of 5 per cent. sodium carbonate solution. Dry with 2-3 g. of anhydrous magnesium sulphate or calcium chloride, and filter through a little glass wool into a distilling flask. Distil, using an air condenser, and collect the *m*-bromotoluene (a colourless liquid) at 180-183°. The yield is 65 g.

Notes.

(1) If the mixture is cooled in ice, most of the *p*-acetotoluidide separates out in a crystalline form. It may be recrystallised from alcohol.

(2) Unless the material is at least partly dried before hydrolysis, the yield of hydrochloride is reduced because of its solubility. If pure 3-bromo-4-acetaminotoluene is required, the crude material may be recrystallised from 50 per cent. alcohol with the addition of a little decolourising carbon; it separates as colourless needles, m.p. 116-117° (180 g.).

(3) If pure 3-bromo-4-aminotoluene is required, the crude base may be purified either by steam distillation or, more satisfactorily, by distillation under reduced pressure. The oil is dried with 5 g. of sodium hydroxide pellets, and distilled under reduced pressure from a Claisen flask with a fractionating side arm: a little *p*-toluidine may be present in the low boiling point fraction, and the pure substance is collected at 92-94°/3 mm. or at 120-122°/30 mm. The purified amine solidifies on cooling and melts at 17-18°.

IV, 64. *o*-BROMOTOLUENE (by the Gattermann Reaction)

In a 1 or 1.5 litre round-bottomed flask prepare a solution of 53.5 g. of *o*-toluidine in 170 ml. of 48 per cent. hydrobromic acid, cool to 5° by immersion in a bath of ice and salt. Diazotise by the gradual addition of a solution of 36.5 g. of sodium nitrite in 50 ml. of water; stopper the flask after each addition and shake until all red fumes are absorbed. Keep the temperature between 5° and 10°. When the diazotisation is complete, add 2 g. of copper powder or copper bronze, attach a reflux condenser to the flask, and heat very cautiously on a water bath. *Immediately* evolution of gas occurs, cool the flask in crushed ice; unless the

flask is rapidly removed from the water bath, the reaction may become so violent that the contents may be shot out of the flask. When the vigorous evolution of nitrogen moderates, heat the flask on a water bath for 30 minutes. Then dilute with 400 ml. of water, and steam distil the mixture until about 750 ml. of distillate are collected. Render the distillate alkaline with 10 per cent. sodium hydroxide solution (about 50 ml.) and separate the lower red layer of crude *o*-bromotoluene. Wash it with two 20 ml. portions of concentrated sulphuric acid (which removes most of the colour) and then twice with water. Dry with anhydrous magnesium sulphate or calcium chloride, and distil from a Claisen flask with lagged fractionating side arm. Collect the *o*-bromotoluene at 178–181°.

IV,65.**BENZENESULPHINIC ACID**

Dissolve 9.3 g. (9.1 ml.) of aniline in a mixture of 19.6 g. (10.7 ml.) of concentrated sulphuric acid and 100 ml. of water, and cool to about 5°. Diazotise by the addition of a solution of 7.0 g. of sodium nitrite in 15 ml. of water to an end point with potassium iodide-starch paper; maintain the temperature below 10°. Add an ice-cold mixture of 40 g. (22 ml.) of concentrated sulphuric acid and 30 ml. of water, cool in ice and pass sulphur dioxide into the solution until there is no further increase in weight (about 25 g.). The solution should not develop any appreciable colour, during this operation and should remain quite clear. When the solution is saturated with sulphur dioxide, transfer it to a beaker provided with a mechanical stirrer, and add copper powder (Section II,50, 4) or copper bronze (previously washed with ether) gradually until no more nitrogen is evolved (about 50 g. of copper powder are required). Filter at the pump and wash the precipitate with several small amounts of dilute ammonia solution to remove any sulphinic acid which may have separated: add the washings to the filtrate. The combined filtrate and washings should be acid to Congo red paper. Treat it with concentrated ferric chloride solution as long as any precipitate forms. Filter the precipitate of ferric benzenesulphinic acid, and wash it with a little water. Decompose the ferric salt with a slight excess of 5 per cent. sodium hydroxide solution, and filter the precipitated ferric hydroxide. Acidify the filtrate and extract the sulphinic acid with ether. Upon evaporation of the solvent, pure benzenesulphinic acid, m.p. 84°, is obtained as a colourless crystalline solid. The yield is 10 g. It oxidises in the air.

IV,66.***p*-TOLUNITRILE (*p*-TOLYL CYANIDE)**

Cuprous cyanide solution (compare Section II,50, 3). Prepare the following solutions:—

- (i) 100 g. of powdered copper sulphate pentahydrate in 320 ml. of water (warming may be necessary), contained in a 1 litre round-bottomed flask;
- (ii) 28 g. of sodium bisulphite in 80 ml. of water (this may require filtering); and
- (iii) 28 g. of commercial potassium cyanide (98–99 % KCN) in 80 ml. of water.

Warm the copper sulphate solution to 50–60°, and add dilute sulphuric acid until it is acid to Congo red. Add the sodium bisulphite solution,

previously warmed to 60°, during 1-2 minutes with shaking (1), and immediately add the potassium cyanide solution, also warmed to 60°, in five portions with vigorous shaking (1). There is a slight frothing and a white precipitate of cuprous cyanide is formed. After 10 minutes, filter with suction on a Buchner funnel and wash the precipitate with four 25 ml. portions of hot water. Transfer the precipitate to a 1-litre round-bottomed flask, and dissolve it either in a solution of 40 g. of sodium cyanide in 100 ml. of water or in a solution of 52 g. of potassium cyanide in 125 ml. of water.

Diazotise 36 g. of *p*-toluidine, following the method given under *p*-Chlorotoluene (Section IV, 61). Warm the cuprous cyanide solution on a water bath to about 60°, and add the cold diazonium salt solution in small quantities at a time, shaking vigorously (1) after each addition and taking care to maintain the temperature of the mixture at 60-70°. Attach a reflux condenser to the flask and heat on a boiling water bath for 15-20 minutes in order to complete the reaction. Equip the flask for steam distillation (Fig. II, 40, 1), and pass steam into the mixture until no more yellow oil passes over; if the oil solidifies in the condenser tube, turn off the condenser water, and, after the material melts and flows through, slowly turn on the water again. Cool the distillate in ice water, and when the crude *p*-tolunitrile has solidified, filter it at the pump and press well to remove liquid impurities. Dry upon filter paper or in a desiccator. Mix the dried product with 2-3 g. of decolourising carbon, transfer to a small distilling flask, and distil using an air condenser (Fig. II, 13, 2). Collect the pure *p*-tolunitrile at 215-219° (2); this solidifies on cooling and melts at 29°. The yield is 26 g.

Notes.

(1) Mechanical stirring is preferable.

(2) The crude substance may also be distilled under diminished pressure and the *p*-tolunitrile collected at 104-106°/20 mm.

Hydrolysis of *p*-tolunitrile to *p*-toluic acid. Boil a mixture of 5 g. of *p*-tolunitrile, 80 ml. of 10 per cent. aqueous sodium hydroxide solution and 15 ml. of alcohol under a reflux condenser. (The alcohol is added to prevent the nitrile, which volatilises in the steam, from crystallising in the condenser; it also increases the speed of hydrolysis. The alcohol may be omitted in the hydrolysis of nitriles which are liquid at the ordinary temperature, e.g., benzonitrile.) The solution becomes clear after heating for about 1 hour, but continue the boiling for a total period of 1.5 hours to ensure complete hydrolysis. Detach the condenser and boil the solution for a few minutes in the open flask to remove dissolved ammonia and incidentally some of the alcohol (**CAUTION**!). Cool, and add concentrated hydrochloric acid until precipitation of the *p*-toluic acid is complete. When cold, filter off the *p*-toluic acid with suction and wash with a little cold water. Recrystallise from a mixture of equal volumes of water and alcohol (methylated spirit) or from benzene. The yield of *p*-toluic acid, m.p. 178°, is 5.5 g.

COGNATE PREPARATIONS

Benzonitrile (phenyl cyanide). Prepare a cuprous cyanide solution in a 500 ml. round-bottomed flask as above, but use the following quantities: 65 g. of crystallised copper sulphate in 205 ml. of water, 18 g. of sodium bisulphite in 52 ml. of water, and 18 g. of potassium cyanide in

52 ml. of water ; dissolve the precipitated cuprous cyanide in a solution of 26 g. of sodium cyanide in 65 ml. of water or of 33.5 g. of potassium cyanide in 90 ml. of water. Diazotise 20 g. (19.6 ml.) of aniline, following the experimental details given under *Iodobenzene* (Section IV,60). Add the cold phenyldiazonium chloride solution to the cuprous cyanide solution warmed at 60–70° and proceed as for *p-Tolunitrile*. Extract the steam distillate with three 30 ml. portions of ether, shake the ethereal solution with 20 ml. of 10 per cent. sodium hydroxide solution (to remove traces of phenol produced by the decomposition of the diazonium chloride solution), then with an equal volume of dilute sulphuric acid (to remove traces of the evil-smelling phenyl *iso*-cyanide C₆H₅NC), and finally with an equal volume of water. Dry the ethereal extract over anhydrous magnesium sulphate or calcium chloride, distil off the ether from a small flask using the apparatus shown in Fig. II, 13, 4 ; then fit a short air condenser to the flask (Fig. II, 13, 2) and distil the benzonitrile. Collect the fraction of b.p. 188–191°. The yield is 16 g.

Hydrolysis of benzonitrile to benzoic acid. Boil 5.1 g. (5 ml.) of benzonitrile and 80 ml. of 10 per cent. sodium hydroxide solution in a 250 ml. round-bottomed flask fitted with a reflux water condenser until the condensed liquid contains no oily drops (about 45 minutes). Remove the condenser, and boil the solution in an open flask for a few minutes to remove free ammonia. Cool the liquid, and add concentrated hydrochloric acid, cautiously with shaking, until precipitation of benzoic acid is complete. Cool, filter the benzoic acid with suction, and wash with cold water ; dry upon filter paper in the air. The benzoic acid (5.8 g.) thus obtained should be pure (m.p. 121°). Recrystallise a small quantity from hot water and redetermine the m.p.

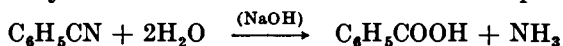

***o*-Tolunitrile.** The preparation is similar to that described for *p-Tolunitrile* except that *p*-toluidine is replaced by *o*-toluidine. The *o*-tolunitrile is isolated by steam distillation ; the oil, which may be dissolved in a little benzene, is distilled. The *o*-tolunitrile passes over as an almost colourless liquid at 94–96°/20 mm.

IV,67.

FLUOROBENZENE

Dissolve 46.5 g. (45.5 ml.) of aniline in a mixture of 126 ml. of concentrated hydrochloric acid and 126 ml. of water contained in a 1-litre beaker. Cool to 0–5° in a bath of ice and salt, and add a solution of 36.5 g. of sodium nitrite in 75 ml. of water in small portions ; stir vigorously with a thermometer (1) and maintain the temperature below 10°, but preferably at about 5° by the addition of a little crushed ice if necessary. The diazotisation is complete when a drop of the solution diluted with 3–4 drops of water gives an immediate blue colouration with potassium iodide-starch paper ; the test should be performed 3–4 minutes after the last addition of the nitrite solution. Prepare a solution of 76 g. of sodium fluoborate (2) in 150 ml. of water, cool, and add the chilled solution slowly to the diazonium salt solution ; the latter must be kept well stirred (1) and the temperature controlled so that it is below 10°. Allow to stand for 10 minutes with frequent stirring. Filter

the precipitated phenyldiazonium fluoborate with suction on a Buchner funnel (3), drain well, and wash the yellow solid with about 30 ml. of ice water, 15 ml. of methyl alcohol, and 30–40 ml. of ether; suck the solid as free as possible from liquid after each washing. Spread the salt upon absorbent filter paper and dry overnight in a vacuum desiccator or, if possible, in a current of air. The yield of phenyldiazonium fluoborate is 60–65 g.; the pure salt melts with decomposition at 119–120°.

Assemble the apparatus shown in Fig. IV, 67, 1; this is self-explanatory. The distilling flask has a capacity of 250 ml. and the beaker contains 150 ml. of 10 per cent. sodium hydroxide solution. All corks must fit well and should be coated with paraffin wax (by dipping into molten wax, and allowing to drain). Place half of the yield of the dry phenyldiazonium fluoborate in the distilling flask. Heat the solid gently with a small luminous flame at one point near its surface until decomposition begins; withdraw the flame and allow the reaction to continue

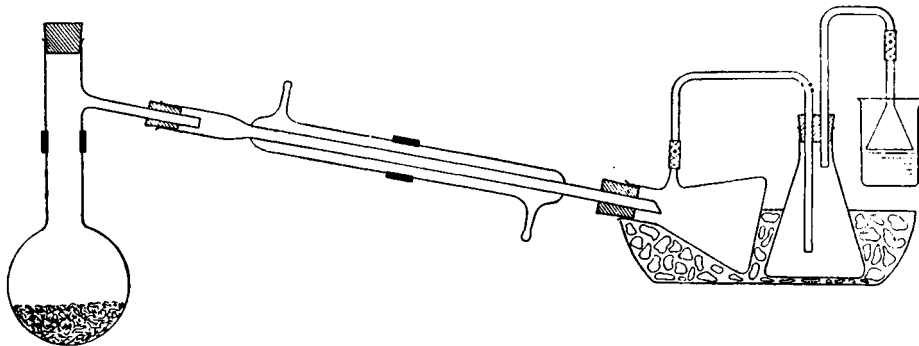

Fig. IV, 67, 1.

as long as it will (4). Continue the cautious heating from time to time as may be necessary to keep the reaction going. When the decomposition appears to be complete, heat the flask more strongly to drive off any remaining fluorobenzene. Allow to cool, add the other half of the borofluoride through a glazed paper funnel, and decompose it as before; finally heat the flask strongly until no more fumes of boron trifluoride are evolved in order to drive off the last traces of fluorobenzene. Most of the fluorobenzene collects in the first receiver. Wash the combined distillates three times with an equal volume of 10 per cent. sodium hydroxide solution (5) or until the washings are almost colourless; this will remove any phenol present. Remove the last sodium hydroxide washing as completely as possible, and then shake with an equal volume of almost saturated sulphate solution. Dry over anhydrous calcium chloride or magnesium sulphate, and distil from 50 ml. distilling flask (Fig. II, 13, 2 but with a Liebig condenser replacing the air condenser). Collect the fluorobenzene (a colourless liquid) at 84–85°. The yield is 24 g.

Notes.

(1) Mechanical stirring, although not essential for small scale preparations, is advantageous and increases the yield slightly.

(2) The use of sodium fluoborate solution supersedes the less convenient fluoboric acid and permits the preparation to be carried out in ordinary glass vessels.

If it is desired to employ fluoboric acid HBF_4 , it can be prepared by adding 100 g. of A.R. boric acid in small proportions to 325 g. of A.R. hydrofluoric acid (40 per cent. HF) cooled in ice; the hydrofluoric acid is contained in a Bakelite beaker, a beaker coated with wax or in a lead vessel. A simple container may also be prepared by cutting off the neck of the wax bottle (in which the hydrofluoric acid is supplied) with a large (*e.g.*, a "butcher's") knife which has been slightly warmed. One-third of the above solution should be employed in the preparation. *Handle with great care.*

Note on precautions to be adopted when using hydrofluoric acid. Attention is directed to the fact that hydrofluoric acid in contact with the skin produces extremely painful burns. In case of accident, the burned surface, which becomes white, is held under running water until the natural colour returns. A paste made from magnesium oxide and glycerine should be applied immediately; this is said to be helpful in preventing the burn becoming serious. It is advisable to wear acid-resisting rubber gloves and protective goggles.

(3) It is better to employ a large sintered glass funnel for filtering; the fluoborate can then be stirred well after each washing before suction is applied.

(4) If the reaction becomes too vigorous, it may be necessary to cool the flask by covering it with a damp cloth. Normally the decomposition proceeds smoothly under the intermittent heating. If the salt is damp, the reaction may proceed more vigorously and unless the flask is cooled, it may pass beyond control.

(5) The density of fluorobenzene is about 1.025 at room temperature; it is important to use the correct strength of sodium hydroxide solution in order to obtain a clear separation of the two layers.

COGNATE PREPARATIONS

***p*-Fluorotoluene.** Dissolve 53.5 g. of *p*-toluidine in a mixture of 126 ml. of concentrated hydrochloric acid and 126 ml. of water contained in a 1-litre beaker; warming is generally necessary; Cool the mixture to 0° in a bath of ice and salt with vigorous stirring with a thermometer (or, better, mechanically) and the addition of a little crushed ice. The *p*-toluidine hydrochloride will separate as a finely-divided crystalline precipitate. Add during about 15 minutes, in small portions and preferably from a separatory funnel supported over the beaker, a solution of 36.5 g. of sodium nitrite in 75 ml. of water until a slight excess of nitrous acid is present; commence testing when about 5 ml. of nitrite solution remains. Maintain the temperature preferably below 5-7° during the diazotisation by the addition of a little crushed ice if necessary; stir vigorously all the time (compare Section IV,61). Add a chilled solution of 76 g. of sodium borofluoride in 150 ml. of water slowly and with good stirring to the cold diazonium salt solution. Continue stirring for about 15 minutes. Filter the *p*-tolylidiazonium fluoborate on a Buchner or sintered glass funnel, wash with about 30 ml. of ice water, 15 ml. of methyl alcohol, and 30-40 ml. of ether. Dry overnight upon absorbent paper in a vacuum desiccator or, if possible, in a current of air. The yield of *p*-tolylidiazonium borofluoride is 78 g.; it melts with decomposition at 114°. Decompose the salt in two equal lots, and work up as for *Fluorobenzene*. The yield of pure *p*-fluorotoluene (a colourless liquid), b.p. 116-117 is 27 g.

***p*-Fluoroanisole.** To 105 ml. of *ca.* 42 per cent. fluoboric acid (*CAUTION*: corrosive chemical) (1) diluted with an equal volume of water, contained in a 600 ml. beaker, add 31 g. of *p*-anisidine. Place the beaker in an ice bath and stir the solution mechanically. Add a solution of 17.5 g. of sodium nitrite in 35 ml. of water slowly and maintain the

temperature at about 10°. Stir the solution vigorously towards the end of the reaction, cool the mixture to 0°, and filter with suction on a sintered glass funnel. Wash the precipitate successively with 30-40 ml. of cold 5 per cent. fluoboric acid, 40 ml. of ice-cold methanol, and several times with ether. Dry overnight by spreading the salt thinly on absorbent paper supported upon a screen or wire netting allowing circulation underneath. The yield of *p*-methoxyphenyldiazonium fluoborate is 54 g. Decompose the dry salt as detailed for *Fluorobenzene*. Return the small amount of product in the receiver to the distilling flask and steam distil. Extract the steam distillate with two 50 ml. portions of ether, wash the ethereal solution with 50 ml. of 10 per cent. sodium hydroxide solution, followed by water, and dry over anhydrous magnesium sulphate. Remove the ether on a steam bath and distil the residue. Collect the *p*-fluoroanisole at 156-157°. The yield is 16 g.

Note.

(1) The fluoboric acid may be prepared by adding 92 g. of A.R. boric acid slowly and with constant stirring to 250 g. of hydrofluoric acid (40-48 per cent.) in a copper, lead or a waxed-lined beaker. A lead rod may be used for stirring. All operations should be carried out in a fume cupboard.

4 : 4'-Difluorodiphenyl. Bis-diazotise a solution of 46 g. of benzidine (Section IV,88) in 150 ml. of concentrated hydrochloric acid and 150 ml. of water by means of a solution of 35 g. of sodium nitrite in 60 ml. of water ; add about 200 g. of crushed ice during the process (compare *p*-*Fluorotoluene* above). Filter the solution and add it to a filtered solution of 85 g. of sodium borofluoride in 150 ml. of water. Stir for several minutes, collect the precipitated bis-diazonium borofluoride by suction filtration, wash with 5 ml. of ice-cold water, and dry at 90-100°. Place the dry salt in a flask fitted with an air condenser, immerse the flask in an oil bath, and slowly raise the temperature to 150° (*Fume Cupboard*!). When decomposition of the salt is complete, steam distil the mixture ; collect the 4 : 4'-difluorodiphenyl which passes over and recrystallise it from ethanol. The yield is 21 g., m.p. 92-93°.

IV,68.

o-DINITROBENZENE

Dissolve 34 g. of *o*-nitroaniline in a warm mixture of 63 ml. of concentrated hydrochloric acid and 63 ml. of water contained in a 600 ml. beaker. Place the beaker in an ice-salt bath, and cool to 0-5° whilst stirring mechanically ; the *o*-nitroaniline hydrochloride will separate in a finely-divided crystalline form. Add a cold solution of 18 g. of sodium nitrite in 40 ml. of water slowly and with stirring to an end point with potassium iodide-starch paper ; do not allow the temperature to rise above 5-7°. Introduce, whilst stirring vigorously, a solution of 40 g. of sodium borofluoride in 80 ml. of water. Stir for a further 10 minutes, and filter the solid diazonium fluoborate with suction on a sintered glass funnel. Wash it immediately once with 25 ml. of cold 5 per cent. sodium borofluoride solution, then twice with 15 ml. portions of rectified (or methylated) spirit and several times with ether ; in each washing stir

the fluoborate well before applying suction. The *o*-nitrophenyldiazonium fluoborate weighs about 50 g.; the pure substance melts with decomposition at 135°.

Dissolve 200 g. of sodium nitrite in 400 ml. of water in a 2-litre beaker provided with an efficient mechanical stirrer, and add 40 g. of copper powder (either the precipitated powder or copper bronze which has been washed with a little ether). Suspend the fluoborate in about 200 ml. of water and add it slowly to the well-stirred mixture. Add 4–5 ml. of ether from time to time to break the froth. The reaction is complete when all the diazonium compound has been added. Transfer the mixture to a large flask and steam distil until no more solid passes over (about 5 litres of distillate). Filter off the crystalline solid in the steam distillate and dry upon filter paper in the air; this *o*-dinitrobenzene (very pale yellow crystals) has m.p. 116° (*i.e.*, is practically pure) and weighs 29 g. It may be recrystallised from alcohol; the recrystallised solid melts at 116.5°.

COGNATE PREPARATION

***p*-Dinitrobenzene.** Use 34 g. of *p*-nitroaniline (Section IV,51) and proceed exactly as above to the point where all the suspension of *p*-nitrophenyldiazonium fluoborate has been added. Filter the reaction mixture with suction, wash the residue well with water, twice with 25 ml. of 5 per cent. sodium hydroxide solution, and finally with water. Dry the solid at 100–110°, powder it, and extract it with four 150 ml. portions of boiling benzene. Distil off the benzene on a water bath, and recrystallise the residue from about 120 ml. of boiling glacial acetic acid. The yield of *p*-dinitrobenzene (reddish-yellow crystals), m.p. 173°, is 30 g. Further recrystallisation from alcohol affords pale yellow crystals of the same m.p.

IV,69.

PHENOL (*from Aniline*)

Add 49 g. (27 ml.) of concentrated sulphuric acid cautiously and with stirring to 200 ml. of water in a 1 litre round-bottomed flask, and to the resulting hot solution add 23 g. (22.5 ml.) of aniline; warm the mixture gently until all the aniline dissolves. Add 200 ml. of cold water and cool the mixture in ice until the temperature falls below 5°. During the cooling process, keep the mixture well shaken. This will ensure that any aniline sulphate which separates will be in a finely-divided crystalline form; this dissolves rapidly as the diazotisation proceeds. Add a cold solution of 18 g. of sodium nitrite in 35 ml. of water slowly and with constant shaking to an end point with potassium iodide-starch paper; follow the precautions given under *Iodobenzene*, Section IV,60. When all the sodium nitrite solution has been introduced, allow the solution to stand at room temperature for 15–20 minutes to ensure complete diazotisation. Place the flask in a water bath, and heat the latter until the temperature of the diazotised solution reaches 50°. Continue the heating for 15 minutes or until the evolution of nitrogen ceases, taking care that the temperature of the solution does not exceed 55°. Steam distil (see Fig. II, 40, 1) the reaction mixture until 400 ml. of distillate are collected. Transfer the distillate to a separatory funnel, add about 20 g. of salt and

shake until it has dissolved. Extract with three 50 ml. portions of ether; remember to run off the lower aqueous layer and to decant the ethereal solution through the mouth of the funnel into a 250 ml. conical flask at each extraction. Dry the combined ether extracts with 3–4 g. of anhydrous potassium carbonate or magnesium sulphate. Distil off the ether in a 50 or 75 ml. distilling flask using the apparatus depicted in Fig. II, 13, 4. When all the ether has been removed, fit the distilling flask with a thermometer and an air condenser (Fig. II, 13, 2), and distil from a wire gauze or an air bath. A little ether passes over first (*CAUTION* against fire) and the temperature rises rapidly. Collect the phenol at 179–183° (pure phenol boils at 182° and melts at 43°) in a small weighed specimen tube or flask. It should crystallise on cooling; if it remains supercooled, crystallisation may be induced by scratching the vessel with a glass rod whilst cooling in ice water or by seeding with a small crystal of pure phenol. The yield is 14 g.

Note.

Phenol should not be allowed to come into contact with the skin for it causes painful burns. The best antidote for phenol burns is a saturated solution of bromine in glycerine: if all undissolved bromine is allowed to settle out before the solution is used, there is no danger of bromine burns. Lime water may also be employed.

COGNATE PREPARATION

***p*-Cresol.** Use 27 g. of *p*-toluidine, but otherwise proceed exactly as for phenol. Collect the *p*-cresol at 197–202°; this solidifies on cooling. The yield is 15 g. Pure cresol has m.p. 36°, b.p. 202°.

IV,70.

m-NITROPHENOL

Add 101 g. (55 ml.) of concentrated sulphuric acid cautiously to 75 ml. of water contained in a 1 litre beaker, and introduce 35 g. of finely powdered *m*-nitroaniline (Section IV,44). Add 100–150 g. of finely crushed ice and stir until the *m*-nitroaniline has been converted into the sulphate and a homogeneous paste results. Cool to 0–5° by immersion of the beaker in a freezing mixture, stir mechanically, and add a cold solution of 18 g. of sodium nitrite in 40 ml. of water over a period of 10 minutes until a permanent colour is immediately given to potassium iodide-starch paper: do not allow the temperature to rise above 5–7° during the diazotisation. Continue the stirring for 5–10 minutes and allow to stand for 5 minutes; some *m*-nitrophenyldiazonium sulphate may separate. Decant the supernatant liquid from the solid as far as possible.

While the diazotisation is in progress, cautiously add 165 ml. of concentrated sulphuric acid to 150 ml. of water in a 1-litre round-bottomed flask. Heat the mixture just to boiling. Add the supernatant liquid (diazonium solution) from a separatory funnel supported over the flask at such a rate that the mixture boils very vigorously (about 30 minutes). Then add the residual damp solid (or suspension) in small portions; avoid excessive frothing. When all the diazonium salt has been introduced, boil for a further 5 minutes and pour the mixture into a 1-litre beaker

set in ice water, and stir vigorously to obtain a homogeneous crystal magma. When cold, filter at the pump, drain well and wash with four 20 ml. portions of ice water. Recrystallise by dissolving the crude product in hot dilute hydrochloric acid (1 : 1 by volume), decant from any residual dark oil, filter and cool to 0°, when light yellow crystals separate (1). Spread these upon a large sheet of filter paper, and dry in the air in a warm room. The mother liquid deposits a further crop (about 2 g.) upon standing for 24 hours. The yield of *m*-nitrophenol, m.p. 96°, is 23 g.

Note.

(1) When working with larger quantities of material, it is more convenient (and a better yield is obtained) to purify the air-dried product by distillation under diminished pressure. Use the apparatus pictured in Fig. II, 19, 4, and add a few fragments of porous porcelain to the solid. No air inlet can be employed to prevent bumping since this may lead to explosive decomposition. Collect the pure *m*-nitrophenol at 160–165°/12 mm.; always allow the flask to cool before admitting air otherwise the residue may decompose with explosive violence. The recovery is over 90 per cent. of the pure *m*-nitrophenol.

IV,71. TOLUENE (from *p*-Toluidine)

Diazotise 10.7 g. of *p*-toluidine, following the procedure given under *p*-Chlorotoluene (Section IV,61). Pour the cold solution of *p*-tolylidiazonium chloride very slowly into a solution of 15 g. of sodium hydroxide in 45 ml. of water cooled to about 5°. While the diazotisation is in progress, prepare a solution of 30 g. of stannous chloride in 75 ml. of water in a 500 ml. round-bottomed flask, and add a solution of 30 g. of sodium hydroxide in 30 ml. of water with shaking until the initial precipitate of stannous hydroxide nearly redissolves. Fit the flask with a reflux condenser, and cool the resulting solution of sodium stannite in ice. Add the cold, alkaline diazonium salt solution through the top of the condenser in small quantities at a time. After each addition there is a vigorous evolution of nitrogen and a brown oil (impure toluene) separates: do not add a further portion of the diazonium solution until effervescence due to the preceding portion has ceased. Steam distil the mixture (Fig. II, 40, 1), separate the toluene from the distillate, dry it with a little anhydrous magnesium sulphate, and distil from a small distilling flask. Pure toluene passes over at 110°. The yield is 6 g.

Note.

Benzene may be prepared similarly from phenyldiazonium chloride (Section IV,60).

IV,72. *sym.*-TRIBROMOBENZENE

Dissolve 10 g. of *sym.*-tribromoaniline (Section IV,47) in 60 ml. of rectified spirit and 15 ml. of benzene in a 200 ml. bolt-head flask by heating on a water bath. Add, from a burette or small graduated pipette, 5.3 g. (3.5 ml.) of concentrated sulphuric acid to the hot solution and gently swirl the liquid. Attach a reflux condenser to the flask and heat on a water bath until the clear solution boils. Detach the condenser, remove the flask from the water bath, and add 3.5 g. of powdered sodium

nitrite in two approximately equal portions ; after each addition, fit the condenser to the flask and shake the flask vigorously. The heat of reaction will cause the solution to boil vigorously ; when the reaction subsides, add the second portion of the sodium nitrite. Heat the flask on a boiling water bath as long as gas is evolved ; shake well from time to time. Allow the solution to cool for ten minutes, and then immerse the flask in an ice bath. A mixture of tribromobenzene and sodium sulphate crystallises out. Filter with suction on a Buchner funnel, wash with a small quantity of alcohol, and then repeatedly with water to remove all the sodium sulphate. Dissolve the crude tribromobenzene (7.5 g.) in a boiling mixture of 120 ml. of glacial acetic acid and 30 ml. of water (1), boil the solution with 2.5 g. of decolourising carbon, and filter through a hot water funnel or a preheated Buchner funnel : allow the solution to cool. Collect the crystals on a Buchner funnel and wash with a small quantity of chilled rectified spirit to remove the acetic acid. Dry in the air upon filter paper. The yield of *sym.*-tribromobenzene (colourless crystals), m.p. 122°, is 6.5 g.

Note.

(1) Methylated spirit may also be employed for recrystallisation.

IV.73.

3 : 3'-DIMETHYLDIPHENYL

Make a thin paste of 21.5 g. of finely-powdered *o*-tolidine (a commercial product) with 300 ml. of water in a 1-litre beaker, add 25 g. (21 ml.) of concentrated hydrochloric acid, and warm until dissolved. Cool the solution to 10° with ice, stir mechanically, and add a further 25 g. (21 ml.) of concentrated hydrochloric acid (1) ; partial separation of *o*-tolidine dihydrochloride will occur. Add a solution of 15 g. of sodium nitrite in 30 ml. of water as rapidly as possible, but keep the temperature below 15° : a slight excess of nitrous acid is not harmful in this preparation. Add the clear, orange tetrazonium solution to 175 ml. of 30 per cent. hypophosphorous acid (2), and allow the mixture to stand, loosely stoppered, at room temperature for 16–18 hours. Transfer to a separatory funnel, and remove the upper red oily layer. Extract the aqueous layer with 50 ml. of benzene. Dry the combined upper layer and benzene extract with anhydrous magnesium sulphate, and remove the benzene by distillation (compare Fig. II, 13, 4) from a Widmer or similar flask (Figs. II, 24, 3–5) : heat in an oil bath to 150° to ensure the removal of the last traces of benzene. Distil the residue at *ca.* 3 mm. pressure and a temperature of 155°. Collect the 3 : 3'-dimethyldiphenyl as a pale yellow liquid at 114–115°/3 mm. ; raise the bath temperature to about 170° when the temperature of the thermometer in the flask commences to fall. The yield is 14 g.

Notes.

(1) If the hydrochloric acid is added all at once instead of in two portions as detailed, a solid will be obtained consisting of *o*-tolidine coated with its dihydrochloride, and the diazotisation will proceed slowly.

(2) If the quantity of hypophosphorous acid is doubled, the yield is increased by 1 g.

IV,74. DIPHENIC ACID (*from Anthranilic Acid*)

The special reducing agent (a solution containing cupro-ammonia ions) is first prepared. Dissolve 63 g. of crystallised copper sulphate in 250 ml. of water in a 1-litre beaker, add 100 ml. of concentrated ammonium hydroxide solution (sp. gr. 0.88), and cool the solution to 10°. Dissolve 17.8 g. of hydroxylammonium chloride or 21 g. of hydroxylammonium sulphate in 60 ml. of water, cool to 10°, and add 42.5 ml. of 6*N* sodium hydroxide solution; if the resulting solution of hydroxylamine is not clear, filter it at the pump. Without delay add the hydroxylamine solution, with stirring, to the ammoniacal cupric sulphate solution. Reduction occurs at once, a gas is evolved, and the solution assumes a pale blue colour. Protect the reducing agent from the air if it is not used immediately.

Grind 25 g. of anthranilic acid with 46 ml. of concentrated hydrochloric acid and 75 ml. of water in a glass mortar, and transfer the suspension to a 500 ml. round-bottomed flask which is provided with a mechanical stirrer. Cool the contents of the flask in an ice bath to 0-5°, and add a solution of 13.2 g. of sodium nitrite in 175 ml. of water from a dropping funnel during about 20 minutes. Keep the diazonium solution below 5° and, if it is not clear, filter it by suction through a chilled Buchner funnel immediately before use.

Surround the reducing solution in the 1-litre beaker (which is equipped with a mechanical stirrer) with a bath of crushed ice so that the temperature of the solution is about 10°. Attach, by means of a short length of rubber "pressure" tubing, to the stem of a dropping funnel a glass tube which dips well below the surface of the solution and is bent upwards at the end and constricted so that the opening is about 2 mm. (this arrangement ensures that the diazonium solution reacts with the ammoniacal solution in the beaker and prevents the latter rising in the stem of the funnel). Place about 45 ml. of the cold diazonium solution in the funnel and add it at the rate of about 10 ml. per minute whilst the mixture is stirred. Add the remainder of the diazonium solution at the same rate; continue the stirring for 5 minutes after the addition is complete. Heat the solution rapidly to boiling and carefully acidify with 125 ml. of concentrated hydrochloric acid; the diphenic acid precipitates as pale brown crystals. Allow to stand overnight and filter with suction; wash the crude diphenic acid with about 25 ml. of cold water. Suspend the crude acid in 100 ml. of water and add 20 g. of solid sodium bicarbonate. Filter the resulting solution by gravity, and then boil with about 0.5 g. of decolourising carbon; filter and acidify the filtrate while still hot with excess of dilute hydrochloric acid (1 : 1). Collect the precipitated diphenic acid on a Buchner funnel, wash it with 20 ml. of cold water, and dry at 100°. The yield of diphenic acid is 18 g.; it melts at 227-228° and usually possesses a light cream colour.

IV,75. PHENYLARSONIC ACID

In a 1500 ml. beaker, provided with a mechanical stirrer, place 46.5 g. (45.5 ml.) of aniline, 101 ml. of concentrated hydrochloric acid and 250 ml. of water, and enough finely crushed ice to make a volume of about

750 ml. ; stir vigorously and add slowly (during *ca.* 20 minutes) a solution of 36.5 g. of sodium nitrite in 125 ml. of water.

Concurrently with the preparation of the phenyldiazonium chloride solution, prepare a cold suspension of sodium arsenite. Place 250 ml. of water in a 3-litre round-bottomed flask equipped with a mechanical stirrer. Heat the water to boiling, add 125 g. of anhydrous sodium carbonate, and, as soon as the carbonate has dissolved, introduce 62.5 g. of pure arsenious oxide and 3 g. of crystallised copper sulphate with stirring. When all the solids have dissolved, cool the solution with stirring under a stream of tap water until the temperature has fallen to 15°.

Continue the stirring and cool the suspension of sodium arsenite to 0° in a freezing mixture of ice and salt. Add the cold phenyldiazonium chloride solution, following the method given under *p*-Bromotoluene (Section IV,62), during about 20 minutes : hold the temperature below 5° if possible, but do not allow it to rise above 10°. Frothing occurs due to the escape of nitrogen ; it can easily be controlled by the occasional addition of a little benzene. Continue the stirring for 1 hour after the diazonium solution has been added, and filter the mixture to remove the solid material which separates. Wash the solid with 125 ml. of cold water ; concentrate the combined filtrate and washings over a free flame to about 400 ml. Add concentrated hydrochloric acid (about 25 ml.) to the hot, concentrated, deep brown solution until no more tarry material separates. Filter the tar through a fluted filter paper, and add more hydrochloric acid until, after filtering, a pale yellow solution is obtained. Precipitate the phenylarsonic acid by the addition of concentrated hydrochloric acid (about 63 ml.) ; avoid too large an excess of hydrochloric acid for this will dissolve some of the product. Filter the cold mixture at the pump on a Buchner funnel and wash it with 50 ml. of cold water. Dissolve the pale yellow crystals in 125 ml. of boiling water, add 5 g. of decolourising carbon, filter the solution through a hot water funnel and allow the filtrate to cool. Collect the crystals and dry in a steam oven. The yield of phenylarsonic acid (white crystals) is 45 g. ; they melt at 155–158° with decomposition into the anhydride $C_6H_4AsO_2$.

COGNATE PREPARATION

***p*-Nitrophenylarsonic acid.** Dissolve 52 g. of sodium meta-arsenite ($NaAsO_2$) and 16 g. of sodium hydroxide in 600 ml. of water (1) contained in a 2-litre beaker and suspend 6 g. of cuprous chloride in the solution. Suspend the *p*-nitrophenyldiazonium fluoborate obtained from 34 g. of *p*-nitroaniline (2) in 300 ml. of cold water and add the suspension, with vigorous mechanical stirring, during 1 hour to the mixture. Control the foaming that accompanies the evolution of nitrogen by the occasional addition of small volumes of amyl alcohol or ethyl ether. As the reaction proceeds, introduce 100 ml. of 10 per cent. sodium hydroxide solution in 20 ml. portions in order to maintain the correct alkalinity. Continue the stirring for a further hour, warm the mixture at 60° for 30 minutes, filter with suction through a sintered glass funnel, and wash the residue on the funnel with two 40 ml. portions of water. Add concentrated hydrochloric

acid to the combined filtrate and washings until the solution is acid to litmus paper, filter, add activated charcoal to the filtrate and concentrate the solution over a flame to about 200 ml. Filter the hot solution at the pump and render the filtrate acid to Congo red with concentrated hydrochloric acid. Upon cooling, finally in ice, the *p*-nitrophenylarsonic acid separates. Filter the crystals with suction and dissolve them in 10 per cent. ammonia solution. Filter the solution, render acid to Congo red with concentrated hydrochloric acid and set aside to cool, preferably overnight. Collect the pure *p*-nitrophenylarsonic acid, wash with small volumes of ice-cold water, and dry in the steam oven. The yield is 47 g., m.p. 298–300° (decomp.).

Notes.

(1) Alternatively, prepare the sodium meta-arsenite solution by dissolving 39.6 g. A.R. arsenious oxide and 32 g. of A.R. sodium hydroxide in 600 ml. of water.

(2) Prepare the diazonium fluoborate from 34 g. of *p*-nitroaniline as detailed in Section IV,68 for *o*-Nitroaniline.

SOME AZO DYESTUFFS

Azo compounds ($\text{ArN}=\text{NAr}$) are prepared by the interaction of a diazonium salt with a phenol in the presence of sodium hydroxide, for example :

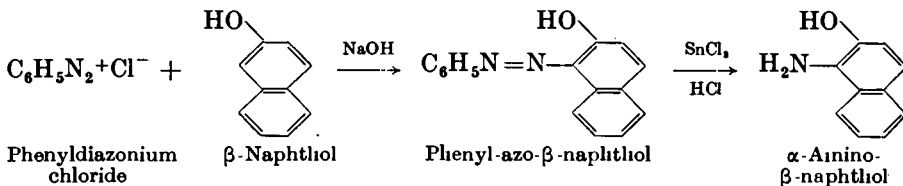

or from a diazonium salt and an amine in the presence of sodium acetate, for example :

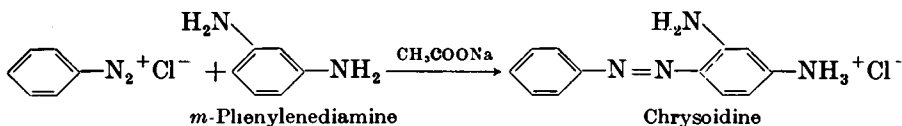

The azo dyes are not of any great practical value owing to their slight solubility in water. The introduction of a sulphonic acid group into the molecule has no effect upon the colour, but renders the dye water-soluble—a fact of great commercial value. The simplest way of achieving this is to employ an amine, *e.g.*, sulphanilic acid, in which the $-\text{SO}_3\text{H}$ group is already present.

Sulphanilic acid, which is conventionally represented as $p\text{-H}_2\text{NC}_6\text{H}_4\text{SO}_3\text{H}$ and is designated more correctly as the internal salt or zwitterion $p\text{-}^+\text{H}_3\text{NC}_6\text{H}_4\text{SO}_3^-$, is sparingly soluble in water. It is best diazotised by bringing it into solution as the sodium salt by adding the calculated quantity of sodium carbonate, introducing the requisite quantity of sodium nitrite, and pouring the solution on to a mixture of hydrochloric acid and ice; nitrous acid and the dipolar sulphanilic acid are liberated together and immediately react, and after a short time the internal diazonium salt (p -diazoniumphenylsulphonic acid) separates from the solution. This condenses with a solution of, say, dimethylaniline in acetic acid (hydrochloric acid should not be used, because the coupling reaction is rendered difficult by a high concentration of hydrogen ions) to give a product, which on treatment with sodium hydroxide yields the sodium salt, known as **methyl orange** :

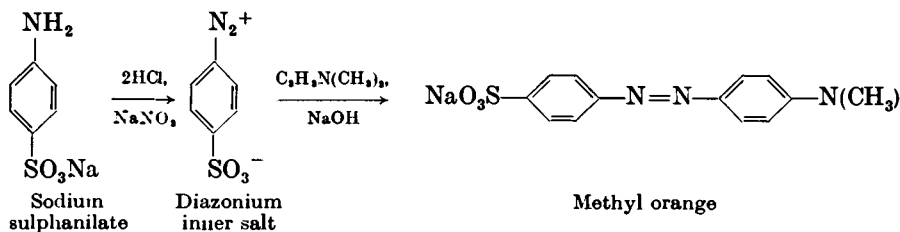

This substance is more useful as an indicator than as a dye, for it changes colour at a certain concentration of hydrogen ions ($\text{pH } 3.1\text{--}4.4$). Treatment

of a solution of methyl orange with a strong acid gives rise to a red form—this is essentially an internal salt, which is stabilised by resonance.

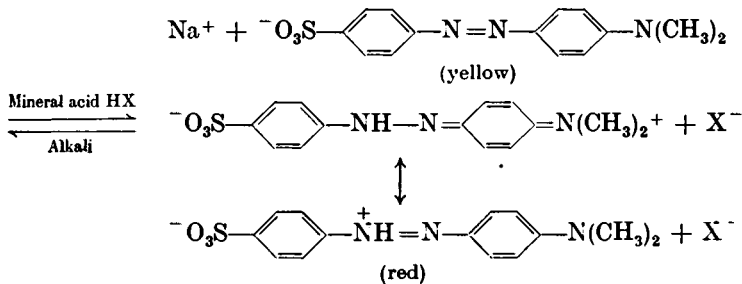

By condensation of diazotised sulphanilic acid with β -naphthol in the presence of sodium hydroxide, the useful dyestuff **Orange II** (*p*-sulphobenzene-azo- β -naphthol) is obtained :

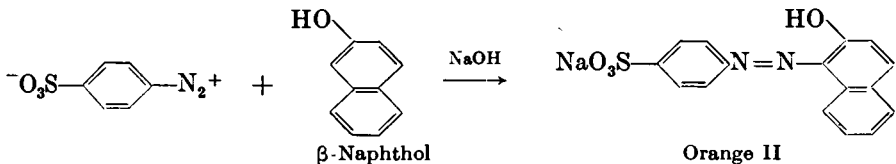

The valuable indicator **methyl red** (*o*-carboxybenzene-azo-dimethylaniline) is obtained by coupling diazotised anthranilic acid with dimethylaniline :

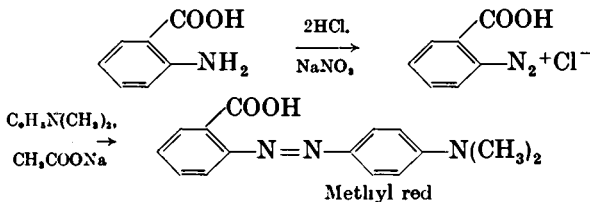

The colour change is red (pink) to yellow over the pH range 4.2-6.3.

It is interesting to note that azo dyestuffs may be conveniently reduced either by a solution of stannous chloride in hydrochloric acid or by sodium hypsulphite. Thus phenyl-azo- β -naphthol yields both aniline and α -amino- β -naphthol (see formula above), and methyl orange gives *p*-aminodimethylaniline and sulphanilic acid :

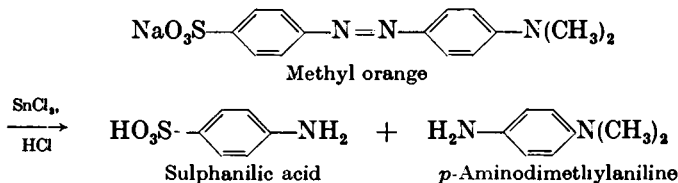

The general reaction may be written in the form :

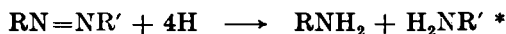

* The equations are :—

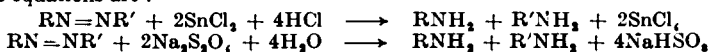

and is of great importance in determining the constitutions of azo compounds. If RNH_2 contains a sulphonic acid group, the reaction product may be neutralised and $\text{R}'\text{NH}_2$ extracted with ether.

Attention has previously (see *Diazonium Salts*) been drawn to the fact that unless an excess of hydrochloric (or mineral) acid is used in the diazotisation process, coupling occurs between the diazonium salt and the amine to give diazoamino compounds. Thus phenyldiazonium chloride and aniline yield diazoaminobenzene. This substance may be conveniently prepared by dissolving two equivalents of aniline in three equivalents of hydrochloric acid, and adding one equivalent of sodium nitrite in aqueous solution followed by two equivalents of sodium acetate :

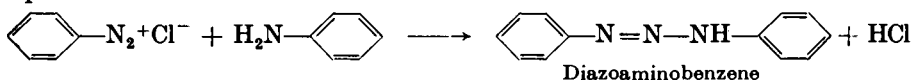

If diazoaminobenzene is dissolved in aniline with a small quantity of aniline hydrochloride and the mixture kept at about 40° for a short time, it is converted in good yield into *p*-amino-azobenzene :

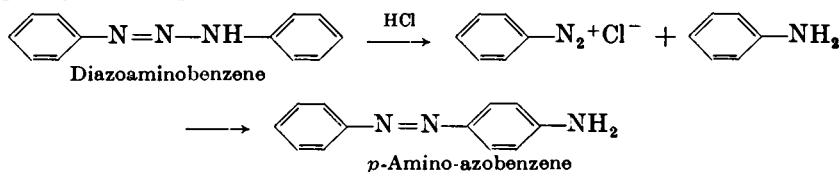

The *mechanism* of the diazoamino-aminoazo rearrangement is dependent upon :—

(a) an equilibrium involving the diazoamino compound, the acid, phenyldiazonium chloride and aniline :

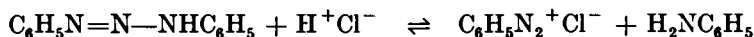

(b) a reaction, under the weakly acid conditions, of the phenyldiazonium ion and the *p*-position of aniline :

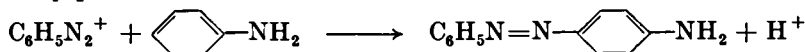

This view is supported by the fact that if diazoaminobenzene is dissolved in dimethylaniline in the presence of the hydrochloride of the latter, the main product is *p*-dimethylamino-azobenzene, $\text{C}_6\text{H}_5\text{N}=\text{NC}_6\text{H}_4\text{N}(\text{CH}_3)_2$; this is because dimethylaniline couples in the nucleus more readily than does aniline. The reaction is an electrophilic displacement of hydrogen by the diazonium ion :

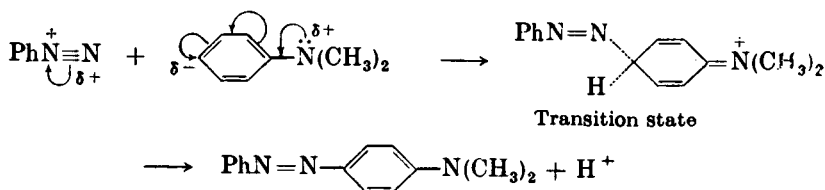

IV,76. PHENYL-AZO- β -NAPHTHOL *

Dissolve 5.0 g. (4.9 ml.) of aniline in 16 ml. of concentrated hydrochloric acid and 16 ml. of water contained in a small beaker or conical flask. Diazotise by the addition of a solution of 4.0 g. of sodium nitrite

* Also termed benzene-azo- β -naphthol.

in 20 ml. of water ; follow the method given in Section IV,60. Prepare a solution of 7·8 g. of β -naphthol in 45 ml. of 10 per cent. sodium hydroxide solution in a 250 ml. beaker ; cool the solution to 5° by immersion in an ice bath, assisted by the direct addition of about 25 g. of crushed ice. Stir the naphthol solution vigorously and add the cold diazonium salt solution *very slowly* : a red colour develops and red crystals of phenyl-azo- β -naphthol soon separate. When all the diazonium salt solution has been added, allow the mixture to stand in an ice bath for 30 minutes with occasional stirring. Filter the solution through a Buchner funnel with *gentle suction*, wash well with water, and drain thoroughly by pressing the crystals with the back of a large glass stopper. Recrystallise one-fourth of the product from glacial acetic acid (30–35 ml.) : retain the remainder for reduction by stannous chloride. Filter the recrystallised product with suction, wash with a little alcohol (or methylated spirit) to eliminate acetic acid, and dry upon filter paper. The yield of deep red crystals is about 3 g. Pure phenyl-azo- β -naphthol has m.p. 131° ; if the m.p. is low, recrystallise the dry product from alcohol.

Reduction with stannous chloride. α -Amino- β -naphthol hydrochloride. Into a 350 or 500 ml. round-bottomed flask, provided with a reflux condenser and containing 100 ml. of methylated spirit, place the crude phenyl-azo- β -naphthol reserved above and boil gently until most of the azo compound has dissolved. Meanwhile dissolve 20 g. of a good grade of stannous chloride in 60 ml. of concentrated hydrochloric acid (warming is necessary to produce a clear solution),* add this to the contents of the flask and boil under reflux for a further 30 minutes. All the azo compound dissolves rapidly and is reduced by the stannous chloride ; the solution acquires a very pale brown colour. Decant the solution to a beaker and cool in ice : the α -amino- β -naphthol hydrochloride separates as fine greyish-white crystals. Filter with suction, and wash with dilute hydrochloric acid (1 : 4). Recrystallise from the minimum volume of hot water which contains a few drops of stannous chloride solution in an equal weight of hydrochloric acid (this reduces atmospheric oxidation), cool the clear solution in an ice bath, and collect the recrystallised product as before. Dry the colourless crystals in a desiccator. The yield is 3–4 g. The compound will remain colourless, or nearly so, if protected from light during storage.

IV,77.

CHRYSOIDINE

Prepare a solution of phenyldiazonium chloride from 5·0 g. (4·9 ml.) of aniline as detailed in Section IV,60, and keep it in an ice bath. Meanwhile dissolve 6·0 g. of a good grade of *m*-phenylene diamine, preferably redistilled before use (Section IV,93), in 60 ml. of 2*N* hydrochloric acid in a 600 ml. beaker, cool, and add the phenyldiazonium chloride solution rapidly and with vigorous stirring. Then add sodium acetate solution (say, 20 g. of the trihydrate in 50 ml. of water) slowly and with stirring until precipitation of the dyestuff is complete ; continue stirring for 1 hour. Heat to the boiling point and filter through a heated funnel, if necessary. Add 40 g. of sodium chloride to the filtrate, heat on a steam bath until the precipitated dyestuff becomes crystalline, allow to cool, filter, wash with a little water, and dry in the air. The yield of chrysoidine is 10 g.

* Sodium hyposulphite (dithionite) $\text{Na}_2\text{S}_2\text{O}_4$ may also be employed for the reduction : see under *Methyl Orange*, Section IV,78.

IV.78. METHYL ORANGE

In a 250 ml. conical flask place 10.5 g. of sulphanilic acid dihydrate, 2.65 g. of anhydrous sodium carbonate and 100 ml. of water, and warm until a clear solution is obtained. Cool the solution under the tap to about 15°, and add a solution of 3.7 g. of sodium nitrite in 10 ml. of water. Pour the resulting solution slowly and with stirring into a 600 ml. beaker containing 10.5 ml. of concentrated hydrochloric acid and 60 g. of crushed ice (1). Test for the presence of free nitrous acid with potassium iodide-starch paper after 15 minutes. Fine crystals of the diazobenzene sulphonate will soon separate; do not filter these off as they will dissolve during the next stage of the preparation. Dissolve 6.05 g. (6.3 ml.) of dimethylaniline in 3.0 ml. of glacial acetic acid, and add it with vigorous stirring to the suspension of diazotised sulphanilic acid. Allow the mixture to stand for 10 minutes; the red or acid form of methyl orange will gradually separate. Then add slowly and with stirring 35 ml. of 20 per cent sodium hydroxide solution: the mixture will assume a uniform orange colour due to the separation of the sodium salt of methyl orange in fine particles. Direct filtration of the latter is slow, hence, whilst stirring the mixture with a thermometer, heat it almost to the boiling point. Most of the methyl orange will dissolve. Add about 10 g. of sodium chloride (to assist the subsequent separation of the methyl orange) and warm at 80–90° until the salt has dissolved. Allow the mixture to cool undisturbed for 15 minutes and then cool in ice water; this gives a fairly easily filterable product. Filter off the methyl orange at the pump, but apply only gentle suction so as to avoid dragging the particles into the pores of the filter paper; rinse the beaker with a little saturated salt solution and drain well. Recrystallise from hot water (about 150 ml. are required); filter the hot solution, if necessary, through a hot water funnel or through a preheated Buchner funnel (prepared by pouring boiling water through it). Reddish-orange crystals of methyl orange separate as the solution cools. Filter these at the pump, drain well, wash with a little alcohol, and finally with a small volume of ether. The yield is 13 g. Methyl orange, being a salt, has no well-defined m.p.

Note.

(1) An alternative procedure is to cool the solution containing the sodium sulphanilate and sodium nitrite in a bath of crushed ice to about 5° and then add 10.5 ml. of concentrated hydrochloric acid diluted with an equal volume of water slowly and with stirring; the temperature must not be allowed to rise above 10° and an excess of nitrous acid should be present (the solution is tested after standing for 5 minutes). The subsequent stages in the preparation—addition of dimethylaniline solution, *etc.*—are as above.

Reduction of methyl orange to *p*-aminodimethylaniline. Method 1. Dissolve 2.0 g. of methyl orange in the minimum volume of hot water and to the hot solution add a solution of 8 g. of stannous chloride in 20 ml. of concentrated hydrochloric acid until decolourisation takes place; gentle boiling may be necessary. Cool the resulting solution in ice; a crystalline precipitate consisting of sulphanilic acid and some *p*-aminodimethylaniline hydrochloride separates out. In order to separate the free base, add 10 per cent. sodium hydroxide solution until the precipitate of tin hydroxide redissolves. Extract the cold solution with three or four 20 ml. portions of ether, dry the extract

with anhydrous potassium carbonate, and remove the ether by distillation. The residual base soon crystallises, particularly if it is stirred with a glass rod; it melts at 41°.

Method 2. Suspend 2.0 g. of methyl orange in 4 ml. of water, and add a small quantity of sodium hyposulphite ($\text{Na}_2\text{S}_2\text{O}_4$). Heat the mixture and add more sodium hyposulphite until the colour is discharged. The sulphanilic acid remains in the solution as sodium sulphanilate and the *p*-aminodimethylaniline may be extracted with ether as in *Method 1*.

IV,79. ORANGE II (β -NAPHTHOL ORANGE)

Diazotise 10.5 g. of sulphanilic acid dihydrate as described under *Methyl Orange* (Section IV,78), and keep the suspension of the diazonium compound in ice water until required. Dissolve 7.2 g. of a good grade of β -naphthol in 40 ml. of cold 10 per cent. sodium hydroxide solution in a 600 ml. beaker, cool to 5°, and pour in, with stirring, the well-mixed suspension of diazotised sulphanilic acid. Coupling takes place readily and the dyestuff separates as a crystalline paste. Stir well and, after 10 minutes, heat the mixture until all the solid has dissolved. Add 20 g. of sodium chloride (to decrease the solubility of the product further) and warm until this dissolves. Allow the solution to cool spontaneously in the air for 1 hour, and then cool in ice until crystallisation is complete. Collect the product on a Buchner funnel and apply gentle suction; wash with a little saturated salt solution, and dry at 80°. The product weighs about 22 g., and contains about 20 per cent. of sodium chloride; further purification is unnecessary for dyeing purposes. To obtain pure, crystalline Orange II, dissolve the crude substance in the minimum volume of boiling water, allow to cool to about 80°, add about twice the volume of rectified (or methylated) spirit, and allow crystallisation to proceed spontaneously. When cold, filter at the pump, wash the pure dyestuff (it is a dihydrate) with a little alcohol, and dry in the air. The yield is 14 g.

IV,80. METHYL RED

Dissolve 65 g. of pure anthranilic acid (1) in a mixture of 50 ml. of concentrated hydrochloric acid and 150 ml. of water by heating; filter off any insoluble impurities. Transfer the solution to a 2-litre beaker, surrounded by an ice bath and provided with a mechanical stirrer. Add 250 g. of crushed ice and 75 ml. of concentrated hydrochloric acid, and stir continuously. When the temperature has fallen to about 3°, slowly introduce a cold solution of 36 g. of sodium nitrite in 70 ml. of water to a permanent end point with potassium iodide-starch paper. This is best done by attaching to the stem of a 50 ml. dropping funnel a glass tube which dips well below the surface of the solution and is bent upwards at the end and constricted so that the opening is about 2 mm.; this arrangement ensures that the entrance of the acid liquor into the nitrite solution is prevented. It is essential that the temperature be kept between 3° and 5° during the diazotisation, otherwise tarry by-products are formed. To the resulting solution of the diazonium salt, add fairly rapidly 84.8 g. (88.5 ml.) of dimethylaniline. Continue the stirring for 1 hour and maintain the temperature at about 5°.

Dissolve 68 g. of crystallised sodium acetate in 100 ml. of water, and dilute to 120 ml. Add 50 ml. of this solution to the reaction mixture and stir for a further 4 hours; eliminate any appreciable amount of foamy solid by the addition of a few drops of ethyl acetate. Allow the mixture to stand overnight in an ice box or in a refrigerator: the temperature must be kept below 7°. Then add the remainder of the sodium acetate solution with stirring to the mixture cooled in an ice bath, stir for an additional period of 2-3 hours, and allow the temperature to rise to 20-25° during 24 hours. Introduce just sufficient sodium hydroxide solution with stirring to cause the mixture to have a distinct odour of dimethylaniline (24 ml. of a 40 per cent. solution are usually required), and allow to stand at room temperature (20-25°) for 48 hours or longer. (The formation of the azo compound is a very slow reaction, but is accelerated by increasing the pH of the solution.) Filter off the solid at the pump, wash it first with water, then with 40 ml. of 10 per cent. acetic acid (to remove the dimethylaniline), and finally with water (the last filtrate is pale pink); drain well. Dry the solid in the air for 24 hours. Suspend the solid in 400 ml. of methyl alcohol in a 1500 ml. bolt-head flask: stir the mixture on a water bath under a reflux condenser for 1 hour, cool in ice and filter. Wash with 400 ml. of cold methyl alcohol and dry in the air. The yield of crude methyl red is 85 g. (2). Purify by extraction with 700 ml. of boiling toluene (3) in a Soxhlet apparatus (Fig. II, 44, 5 or 6). When the extraction is complete, remove the flask containing the almost boiling toluene to a bath containing water at 90-100° and arrange that the level of the water is slightly above that of the toluene in the flask. The temperature thus falls slowly and large crystals are obtained. Finally allow to cool to room temperature. Filter off the crystals and wash with a little toluene. The yield of methyl red, m.p. 181-182°, is 79 g.

Notes.

(1) If crude anthranilic acid is employed, it should be titrated against standard alkali with phenolphthalein as indicator, and the weight adjusted in accordance with the purity.

(2) The sodium salt of methyl red may be prepared by dissolving the crude product in an equal weight of 35 per cent. sodium hydroxide which has been diluted to 350 ml., filtering, and evaporating under diminished pressure (Fig. II, 37, 1). The resulting sodium salt forms orange leaflets. This water-soluble product is very convenient for use as an indicator. Incidentally, the toluene extraction is avoided.

(3) Methyl red may also be recrystallised from glacial acetic acid.

IV,81.

DIAZOAMINOBENZENE

In a 250 ml. flask place 75 ml. of water, 24 g. (20 ml.) of concentrated hydrochloric acid and 14 g. (13.7 ml.) of aniline. Shake vigorously (1) and then add 50 g. of crushed ice. Run in a solution of 5.2 g. of sodium nitrite in 12 ml. of water, with constant shaking, during a period of 5-10 minutes. Allow to stand with frequent shaking (1) for 15 minutes, and add a solution of 21.0 g. of crystallised sodium acetate in 40 ml. of water during 5 minutes. A yellow precipitate of diazoaminobenzene begins to form immediately; allow to stand with frequent shaking for 45 minutes and do not allow the temperature to rise above 20° (add ice,

if necessary). Filter the yellow diazoaminobenzene on a Buchner funnel, wash with it 250 ml. of cold water, drain as completely as possible, and spread it on a sheet of filter paper to dry. The yield of crude diazoaminobenzene, m.p. 91° , is 15 g. (2). Recrystallise a small portion from light petroleum, b.p. $60-80^{\circ}$: the pure compound, m.p. 97° , is obtained.

Notes.

(1) For preparations on a larger scale, mechanical stirring is recommended: a beaker or bolt-head flask should be used.

(2) About 200 ml. of light petroleum is required for recrystallisation. It is therefore advisable, for the sake of economy when the preparation is conducted by a large class of students, that only about 1 g. of the crude material be recrystallised from this solvent. The crude compound may be employed in the preparation of *p*-amino-azobenzene.

IV.82.

p-AMINO-AZOBENZENE

Dissolve 5 g. of finely-powdered diazoaminobenzene (Section IV.81) in 12-15 g. of aniline in a small flask and add 2.5 g. of finely-powdered aniline hydrochloride (1). Warm the mixture, with frequent shaking, on a water bath at $40-45^{\circ}$ for 1 hour. Allow the reaction mixture to stand for 30 minutes. Then add 15 ml. of glacial acetic acid diluted with an equal volume of water: stir or shake the mixture in order to remove the excess of aniline in the form of its soluble acetate. Allow the mixture to stand, with frequent shaking, for 15 minutes: filter the amino-azobenzene at the pump, wash with a little water, and dry upon filter paper. Recrystallise the crude *p*-amino-azobenzene (3.5 g.; m.p. 120°) from 15-20 ml. of carbon tetrachloride to obtain the pure compound, m.p. 125° . Alternatively, the compound may be recrystallised from dilute alcohol, to which a few drops of concentrated ammonia solution have been added.

To prepare the hydrochloride, dissolve about 1 g. of the compound (which need not be perfectly dry) in about 8 ml. of alcohol. Add this solution to boiling dilute hydrochloric acid (10 ml. of the concentrated acid and 80 ml. of water). Boil for 5 minutes, filter the hot solution if necessary, and allow to cool. *p*-Amino-azobenzene hydrochloride separates in steel-blue crystals. Filter, wash with a little dilute hydrochloric acid, and dry.

To recover the free base, dissolve the hydrochloride in the minimum volume of boiling alcohol, add concentrated ammonia solution dropwise until a clear solution results and the blue colour has become light brown. Add water carefully until a cloudiness appears, warm on a water bath until the cloudiness just disappears, and allow to cool. Yellow crystals of *p*-amino-azobenzene separate on cooling.

Note.

(1) The aniline hydrochloride may be prepared by treating 2 g. of aniline with an excess (about 3 ml.) of concentrated hydrochloric acid in a small beaker, cooling, filtering at the pump, washing with a *small* volume of ether, and drying between filter paper.

INTERMEDIATE PRODUCTS IN THE REDUCTION OF NITRO COMPOUNDS

The reduction of an aromatic nitro compound with a powerful reducing agent (tin or stannous chloride and hydrochloric acid ; iron and dilute hydrochloric acid ; hydrogen and a platinum catalyst) leads to a good yield of the corresponding primary amine, *e.g.*, nitrobenzene \rightarrow aniline. The process is by no means a simple one : by the use of milder reducing agents and by the control of the hydrogen ion concentration (*pH*) of the solution, a number of intermediate products may be isolated, some of which are products of direct reduction and others are formed through secondary changes. Particularly fine control may be obtained by electrolytic reduction, *e.g.*, it can be carried out in solutions of varying *pH*, and the size and material of the electrodes as well as the current density may be varied within wide limits. Haber (1900) thus established that the reduction of nitrobenzene proceeds in the following stages :—

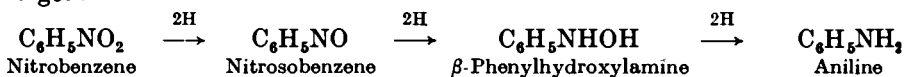

The initial product, nitrosobenzene, is so easily reduced to β -phenylhydroxylamine that it has never been isolated in the free state, but its presence has been established by reaction in solution with hydroxylamine to yield a phenyldiazonium salt, which couples readily with a α -naphthylamine to form the dyestuff phenyl-azo- α -naphthylamine (compare Section IV, 77) :

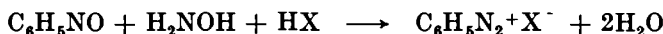

Under the catalytic influence of alkali, nitrosobenzene and β -phenylhydroxylamine react to yield azoxybenzene :

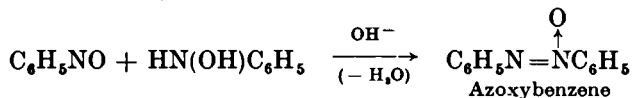

Further reduction in alkaline solution (say, with zinc powder) leads to azobenzene and hydrazobenzene :

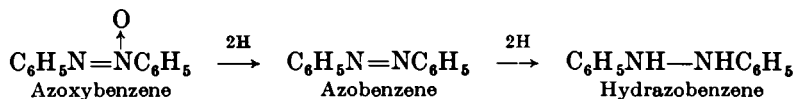

Electrolytic reduction of hydrazobenzene gives aniline :

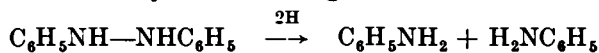

The various intermediate compounds may be prepared in the laboratory, and convenient methods are described below.

β -Phenylhydroxylamine is formed when aniline is treated with a "neutral" reducing agent, *e.g.*, zinc powder and aqueous ammonium chloride solution :

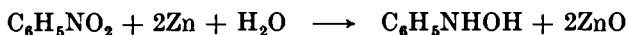

This extremely reactive substance rearranges, in the presence of acids, with the production of *p*-aminophenol :

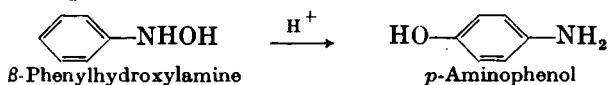

Nitrosobenzene may be obtained by the oxidation of β -phenylhydroxylamine with acid dichromate solution at 0° :

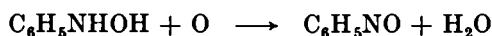

The solid is colourless and is probably dimolecular : it dissociates to a green monomer upon melting or in solution.

Azoxybenzene is readily prepared by reduction of nitrobenzene in an alkaline medium with dextrose or sodium arsenite :

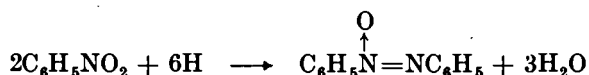

Reduction of nitrobenzene in methyl or ethyl alcoholic sodium hydroxide solution with zinc powder leads to azobenzene or hydrazobenzene according to the proportion of zinc powder employed :

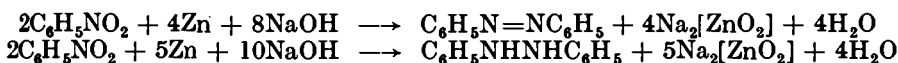

Hydrazobenzene may be oxidised to azobenzene by sodium hypobromite solution at 0° .

In the presence of acids, hydrazobenzene rearranges to give about 70 per cent. of **benzidine** (4 : 4'-diaminodiphenyl) and about 30 per cent. of *diphenylene* (2 : 4'-diaminodiphenyl) :

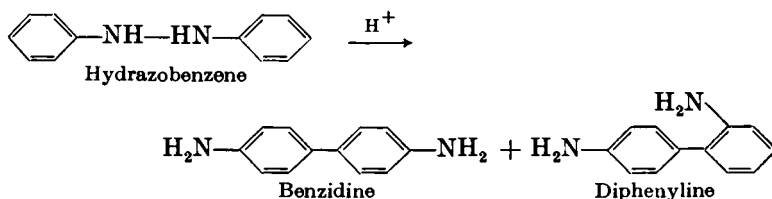

The conversion of a hydrazobenzene into a diaminodiphenyl upon treatment with acid is termed the **benzidine rearrangement**. The following *mechanism* for the formation of benzidine from hydrazobenzene appears reasonable :

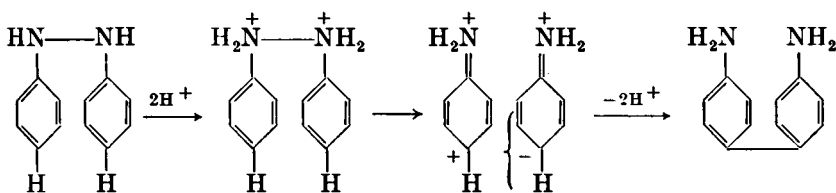

The rearranging entity has been shown to be the bivalent cation ; the adjacent charges may so weaken the N—N link that charges of nearly integral size may be built up in the 4 and 4' positions. In the bent, but strainless, cation the minimum separation of the two *p*-positions would suffice for the establishment of a largely electrostatic bond, which could pass smoothly into the covalent rearrangement product (benzidine).

IV.83.

β -PHENYLHYDROXYLAMINE

In a 2 litre beaker, equipped with a thermometer and mechanical stirrer, place 25 g. of ammonium chloride, 800 ml. of water and 50 g. (41.6 ml.) of nitrobenzene (1). Stir the mixture vigorously, and add 59 g. of

zinc powder of 90 per cent. purity (2) during about 15 minutes ; the rate of addition should be such that the temperature rapidly rises to 60–65° and remains in this range until all the zinc has been added. Continue the stirring for a further 15 minutes, by which time the reduction is complete as is shown by the fact that the temperature commences to fall. Filter the warm reaction mixture at the pump to remove the zinc oxide, and wash it with 100 ml. of hot water. Place the filtrate in a conical flask, saturate it with common salt (about 300 g.), and cool in an ice bath for at least one hour to ensure maximum crystallisation of the desired product. Filter the pale yellow crystals of β -phenylhydroxylamine with suction and drain well. The yield of crude, dry product is about 38 g. ; this contains a little salt and corresponds to about 29 g. of pure phenylhydroxylamine as determined by its separation from inorganic materials by dissolution in ether. The substance deteriorates upon storage and is therefore used immediately for a secondary preparation (e.g., nitrosobenzene, Section IV,84 or cupferron, Section VII,6). If required perfectly pure, it may be recrystallised from benzene-light petroleum (b.p. 40–60°) or from benzene alone ; the resulting pure compound is somewhat more stable and has a melting point of 81°.

Notes.

(1) Redistilled or A.R. nitrobenzene should be used. It must not be acid in reaction.

(2) The zinc powder should be analysed (for method, see, for example, Vogel, *Quantitative Inorganic Analysis : Theory and Practice*, Second Edition ; 1952, p. 812; Longmans, Green and Co., Ltd.), and a proportional quantity employed if the zinc content is not 90 per cent.

Conversion of β -phenylhydroxylamine into *p*-aminophenol. Add 4.4 g. of recrystallised β -phenylhydroxylamine to a mixture of 20 ml. of concentrated sulphuric acid and 60 g. of ice contained in a 1 litre beaker cooled in a freezing mixture. Dilute the solution with 400 ml. of water, and boil until a sample, tested with dichromate solution, gives the smell of quinone and not of nitrosobenzene or nitrobenzene (ca. 10–15 minutes). Neutralise the cold reaction mixture with sodium bicarbonate, saturate with salt, extract twice with ether, and dry the ethereal extract with anhydrous magnesium or sodium sulphate. Distil off the ether ; *p*-aminophenol, m.p. 186°, remains. The yield is 4.3 g.

IV,84.

NITROSOBENZENE

In a 2 litre bolt-head flask, equipped with an efficient mechanical stirrer, place 60.5 g. (50 ml.) of pure nitrobenzene and a solution of 30 g. of ammonium chloride in 1 litre of water. Stir vigorously and add 75 g. of a good quality zinc powder (about 90 per cent. purity) in small portions over a period of 5 minutes. The main reaction occurs about 5 minutes after the addition and the temperature rises. When the temperature reaches about 65°, add enough ice to the well-stirred mixture to reduce the temperature to 50–55°. Filter the solution through a Buchner funnel twenty minutes after the first portion of zinc powder was introduced ; wash the zinc oxide residues with 600–700 ml. of boiling water.

Transfer the filtrate and washings to a 4 litre round-bottomed flask or beaker and cool *immediately* to 0–1° by the addition of sufficient crushed ice and leave at least 250 g. unmelted. Without delay, add with stirring a cold solution of concentrated sulphuric acid (150 ml. of the concentrated acid to which sufficient ice has been added to reduce the temperature to –5°). Then add an ice-cold solution of 34 g. of crystallised sodium dichromate in 125 ml. of water as rapidly as possible to the stirred solution. After 2–3 minutes, filter the straw-coloured precipitate of nitrosobenzene on a Buchner funnel and wash it with 200 ml. of water. Steam distil the nitrosobenzene, preferably from an all-glass apparatus (compare Fig. II, 61, 5) since cork and rubber are readily attacked, as rapidly as possible; the nitrosobenzene tends to decompose at the elevated temperature. Cool the receiver in ice because the compound has a high vapour pressure at room temperature. The nitrosobenzene condenses to a green liquid, which solidifies to a white solid; care should be taken that the solid does not clog the condenser by turning off the water supply from time to time. Stop the distillation when yellow oily material appears in the condenser. Filter; grind the nitrosobenzene in a glass mortar with a little water. Filter at the pump, wash it with water until the washings are no longer brown, and drain as completely as possible. Dry the solid between layers of filter paper. The yield of nitrosobenzene, m.p. 66–67°, is 30 g. A pure product, m.p. 68°, may be obtained by recrystallisation from a small volume of alcohol with good cooling: the compound should be dried over anhydrous calcium chloride at atmospheric pressure. The substance may be kept for 1–2 days at room temperature and for longer periods at 0°.

IV,85.

AZOXYBENZENE

Equip a 500 ml. three-necked flask with an efficient stirrer (*e.g.*, a Hershberg stirrer, Fig. II, 7, 8) and a reflux condenser; stopper the third neck. Place a solution of 30 g. of sodium hydroxide in 100 ml. of water, and also 20.5 g. (17.1 ml.) of pure nitrobenzene in the flask, immerse it in a water bath maintained at 55–60°, and add 21 g. of anhydrous dextrose in small portions, with continuous stirring, during 1 hour. Then heat on a boiling water bath for 2 hours. Pour the hot mixture into a 1 litre round-bottomed flask and steam distil (Fig. II, 40, 1) to remove aniline and nitrobenzene. When the distillate is clear (*i.e.*, after about 1 litre has been collected), pour the residue into a beaker cooled in an ice bath. The azoxybenzene soon solidifies. Filter with suction, grind the lumps of azoxybenzene in a mortar, wash with water, and dry upon filter paper or upon a porous plate. The yield of material, m.p. 35–35.5°, is 13 g. Recrystallise from 7 ml. of rectified spirit or of methyl alcohol; the m.p. is raised to 36°.

IV,86.

AZOBENZENE

Method 1 (from nitrobenzene). Support a 1 litre three-necked flask, equipped with a mercury-sealed stirrer and a reflux condenser, on a water bath, and place a solution of 65 g. of sodium hydroxide in 150 ml. of

water, 50 g. (41.5 ml.) of pure nitrobenzene and 500 ml. of methyl alcohol in the flask. Add 53 g. of zinc powder (1) to the mixture, start the stirrer, and reflux for 10 hours (2). Filter the mixture while hot, and wash the precipitate of sodium zincate with a little methyl alcohol. The strongly alkaline filtrate is not always clear: render it neutral to litmus by the cautious addition of concentrated hydrochloric acid, and filter again. Distil off the methyl alcohol from the filtrate, cool the residue in ice, and filter off the solid azobenzene. The crude azobenzene contains occluded zinc salts. To remove these, add the crude product to 100 ml. of 2 per cent. hydrochloric acid, warm to about 70° in order to melt the azobenzene, and stir mechanically for 5 minutes; continue the stirring whilst the mixture is immersed in ice water in order to solidify the azobenzene. Filter, wash well with water, drain thoroughly, and recrystallise from a mixture of 145 ml. of rectified spirit and 12 ml. of water; collect the azobenzene and dry in the air. The yield of pure azobenzene (reddish-orange crystals), m.p. 67–68°, is 31 g. (3).

Notes.

(1) This weight assumes 100 per cent. purity. The zinc powder should be analysed and a proportional quantity employed according to the zinc content (see Section IV,83, *Note 2*).

(2) At the end of this time, the reddish mixture should be free from the odour of nitrobenzene; if it is not, reflux for 2–3 hours longer.

(3) Frequently the recrystallized azobenzene has m.p. 61°, which is unaffected by recrystallisation from alcohol. Upon distillation from a 50 ml. distilling flask fitted with a short air condenser, the m.p. is raised to 67.5° and the recovery is about 90 per cent.: one recrystallisation from diluted alcohol (as above) then gives perfectly pure azobenzene of m.p. 68.5°.

Method 2 (from hydrazobenzene). Prepare a solution of sodium hypobromite by adding 10 g. (3.2 ml.) of bromine dropwise to a cold solution of 6.0 g. of sodium hydroxide in 75 ml. of water immersed in an ice bath. Dissolve 9.5 g. of hydrazobenzene (Section IV,87) in 60 ml. of ether contained in a separatory funnel, and add the cold sodium hypobromite solution in small portions. Shake for 10 minutes, preferably mechanically. Separate the ether layer, pour it into a 100 ml. distilling flask, and distil off the ether by warming gently on a water bath. Dissolve the warm liquid residue in about 30 ml. of alcohol, transfer to a small beaker, heat to boiling on a water bath, add water dropwise to the hot solution until the azobenzene just commences to separate, render the solution clear again with a few drops of alcohol, and cool in ice water. Filter the orange crystals at the pump, and wash with a little 50 per cent. alcohol. Dry in the air. The yield is 8 g.

IV,87. HYDRAZOBENZENE (*sym.*DIPHENYLHYDRAZINE)

Support a 1500 ml. three-necked flask, equipped with a mercury-sealed stirrer and a double surface reflux condenser, on a water bath, and place a solution of 84 g. of sodium hydroxide in 185 ml. of water, 50 g. (41.5 ml.) of nitrobenzene and 500 ml. of methyl alcohol in the flask. Add 70 g. of zinc powder (1), start the stirrer, and reflux for 10 hours. The solution gradually assumes the reddish colour of azobenzene and then on further

reduction, turns to a pale yellow (due to hydrazobenzene). If the colour is not almost completely discharged at the end of the refluxing period, add a further 10 g. of zinc powder, and reflux for 2-3 hours longer. Filter the hot solution through a pre-heated Buchner funnel and wash the sodium zincate upon the filter with a little hot methanol. Pour the filtrate into a large flask (2), stopper it loosely, and cool it in a freezing mixture of ice and salt to accelerate crystallisation. After 1 hour filter off the almost colourless crystals of hydrazobenzene at the pump as rapidly as possible (take care not to draw air through them unnecessarily), wash with 50 per cent. methyl alcohol to which a little sulphurous acid has been added until the filtrate is no longer alkaline. Dry in a vacuum desiccator. The resulting almost colourless hydrazobenzene (15 g.; m.p. 125°) is sufficiently pure for the preparation of benzidine or of azobenzene. If it is required pure (m.p. 126° with production of a yellow colour), it may be recrystallised from hot alcohol containing a little ammonium sulphide or sulphurous acid (these assist in preventing atmospheric oxidation).

Owing to the great tendency of hydrazobenzene to undergo oxidation, all operations involving filtration should be carried out as rapidly as possible and air should not be drawn through it unnecessarily. The substance should be dried in a vacuum desiccator: it can only be preserved in a colourless condition if it is kept in an atmosphere of carbon dioxide or nitrogen or in sealed vessels.

Notes.

(1) This weight of zinc powder assumes 100 per cent. purity. The zinc content should be determined (see Section IV,83, *Note 2*) and a corresponding adjustment made.

(2) If the methyl alcohol is distilled off before thorough cooling in a freezing mixture, the yield of hydrazobenzene is appreciably increased, but the product is considerably more coloured due to admixture with a trace of azobenzene. About 12 g. of impure hydrazobenzene may be recovered by distilling off the methyl alcohol from the filtrate after the colourless hydrazobenzene has been collected.

IV,88.

BENZIDINE

Dissolve 9.5 g. of hydrazobenzene (Section IV,87) in the minimum volume of ether (about 90 ml. are usually required), and add this solution in small portions from a separatory funnel to 100 ml. of ice-cold dilute hydrochloric acid (1 : 1) contained in a 350 ml. conical flask: stopper the flask and shake after each addition. Benzidine hydrochloride separates out during the reaction. After all the hydrazobenzene has been introduced, add 50 ml. of concentrated hydrochloric acid and allow the mixture to stand for 30 minutes in ice water. Filter the benzidine hydrochloride at the pump, wash it first with 20 ml. of dilute hydrochloric acid (1 : 1) and then with two or three 20 ml. portions of ether (to dissolve any unchanged hydrazobenzene) (1).

To obtain the free base, dissolve the crude hydrochloride in 150-200 ml. of water, filter, and cool rapidly to about 20°. Pour the solution with stirring into a mixture of 150 g. of crushed ice and 50 ml. of 10 per cent. sodium hydroxide solution contained in a litre beaker. Filter off the

benzidine, which separates as greyish-white flocks, with suction on a Buchner funnel, and wash it thoroughly with water. Recrystallise from hot water (about 40 ml.) or from alcohol (about 15 ml.); collect the crystals and dry them in a steam oven or in a vacuum desiccator (2). The yield of pure, anhydrous benzidine, m.p. 128° , is 5 g.

Note.

(1) The hydrochloride (about 9 g.) may be recrystallised by dissolving in hot water and adding concentrated hydrochloric acid to the slightly cooled solution, but this is generally unnecessary. The diphenylene may be isolated by rendering the filtrate from the benzidine hydrochloride strongly alkaline with sodium hydroxide solution, cooling in ice, filtering, and recrystallising from alcohol; the yield is 0.5 g., m.p. 45° .

(2) Benzidine crystallises from water as the monohydrate; the m.p. of the latter is unsatisfactory, since water is lost gradually above about 95° .

REDUCTION OF DIAZONIUM COMPOUNDS. ARYL HYDRAZINES

Phenyldiazine may be prepared by reducing phenyldiazonium chloride solution with excess of warm sodium sulphite solution, followed by acidification with hydrochloric acid, when the hydrochloride crystallises out on cooling. Treatment of the latter with excess of sodium hydroxide solution liberates the free base. The reaction is believed to proceed through the following stages :—

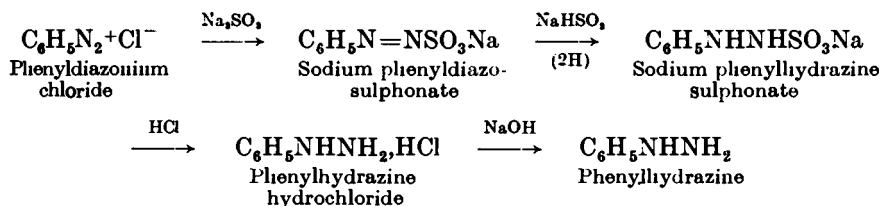

It may also be prepared by the reduction of phenyldiazonium chloride with the calculated amount of a solution of stannous chloride in hydrochloric acid, but the yield is not so high as that obtained by the above sulphite method :

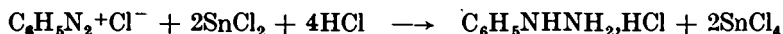

p-Nitrophenylhydrazine may be similarly prepared from *p*-nitrophenyldiazonium chloride by reduction with sodium or ammonium sulphite :

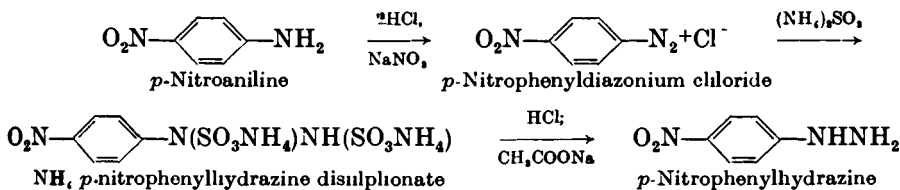

This method cannot be applied to polynitro amines, since these are so weakly basic that they can be diazotised only under special conditions in strongly acidic solutions. In such cases use may, however, be made of the mobility conferred upon halogen atoms by the presence of nitro groups in the *ortho* and *para* positions. Thus the valuable reagent 2:4-dinitrophenylhydrazine is readily prepared by the condensation of 2:4-dinitrochlorobenzene with hydrazine :

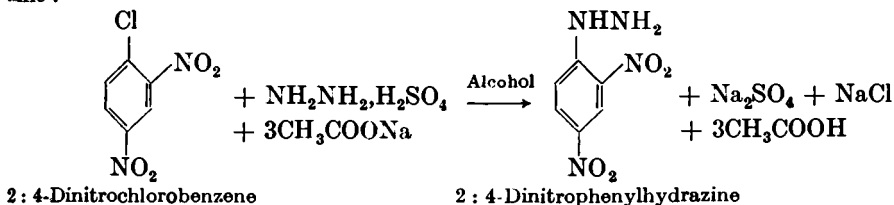

The reaction represented is that with hydrazine solution, produced from hydrazine sulphate and sodium acetate in the presence of aqueous alcohol. Excellent results are also obtained by interaction of the commercially available 60-64 per cent. hydrazine solution with a solution of 2:4 dinitrochlorobenzene in triethylene glycol or in diethylene glycol at about 20°.

IV.89.

PHENYLHYDRAZINE

Place 130 ml. of concentrated hydrochloric acid in a 1.5 litre round-bottomed flask, equipped with a mechanical stirrer and immersed in a freezing mixture of ice and salt. Start the stirrer and, when the temperature has fallen to about 0° , add 60 g. of finely-crushed ice (1), run in 47.5 g. (46.5 ml.) of pure aniline during about 5 minutes, and then add another 60 g. of crushed ice. Dissolve 35 g. of sodium nitrite in 75 ml. of water, cool to $0-3^{\circ}$, and run in the cold solution from a separatory funnel, the stem of which reaches nearly to the bottom of the flask. During the addition of the nitrite solution (*ca.* 20 minutes), stir vigorously and keep the temperature as near 0° as possible by the frequent addition of crushed ice. There should be a slight excess of nitrous acid (potassium iodide-starch paper test) at the end of 10 minutes after the last portion of nitrite is added.

In the meantime, prepare a sodium sulphite solution as follows. In a 2-litre beaker or bolt-head flask place 50 g. of sodium hydroxide (2) and add 500 ml. of water. When the sodium hydroxide has dissolved, add 112.5 g. of recrystallised sodium bisulphite (3), and stir mechanically until the solid has dissolved. Cool the resulting solution to about 25° and add a few drops of phenolphthalein indicator solution. Introduce small quantities of sodium bisulphite until the pink colour of the solution just disappears, then stir in a further 12 g. of sodium bisulphite (the total weight required should not exceed 135-140 g.). Cool this solution, with stirring, to about 5° by immersion in an ice bath, then add about 60 g. of crushed ice. Run in the ice-cold diazonium solution as rapidly as possible, while stirring vigorously. The reaction mixture immediately acquires a bright orange-red colour. Slowly heat the solution to $60-70^{\circ}$ on a water bath and maintain this temperature for 30-60 minutes, *i.e.*, until the colour becomes quite dark. Acidify the solution to litmus with concentrated hydrochloric acid (40-50 ml. are required); continue the heating on a boiling water bath until the colour becomes much lighter and in any case for 4-6 hours. If any solid is present, filter the solution. To the hot, clear solution add, with stirring, 500 ml. of concentrated hydrochloric acid; cool, first in running water, and then in a freezing mixture to 0° . The phenylhydrazine hydrochloride separates as yellowish or pinkish crystals. Collect them on a Buchner funnel, drain, wash with 25 ml. of dilute hydrochloric acid (1 : 3), and press well with a large glass stopper (4).

Liberate the free base by adding to the phenylhydrazine hydrochloride 125 ml. of 25 per cent. sodium hydroxide solution. Extract the phenylhydrazine with two 40 ml. portions of benzene, dry the extracts with 25 g. of sodium hydroxide pellets or with anhydrous potassium carbonate: thorough drying is essential if foaming in the subsequent distillation is to be avoided. Most of the benzene may now be distilled under atmospheric pressure, and the residual phenylhydrazine under reduced pressure. For this purpose, fit a small dropping funnel to the main neck of a 100 ml. Claisen flask (which contains a few fragments of porous porcelain) and assemble the rest of the apparatus as in Fig. II, 20, 1, but do not connect the "Perkin triangle" to the pump. Run in about 40 ml. of the benzene solution into the flask, heat the latter in an air bath (Fig. II, 5, 3) so that

the benzene distils over steadily. Allow the remainder of the benzene solution to run in from the dropping funnel as fast as the benzene itself distils over. When all the benzene solution has been introduced into the flask, close the stopcock on the funnel, and continue the heating until the temperature on the thermometer reads about 90°. Allow to cool. Replace the dropping funnel by a rubber stopper carrying a capillary tube reaching to the bottom of the flask, and distil under diminished pressure. Collect the phenylhydrazine at 137–138°/18 mm. (or at 119–120°/12 mm.). The yield of almost colourless liquid is 70 g.; it crystallises on cooling in ice and then melts at 23°. Phenylhydrazine slowly darkens on exposure to light.

CAUTION. Phenylhydrazine is highly poisonous and produces unpleasant burns in contact with the skin. Wash off immediately any liquid which has come into contact with the skin first with 2 per cent. acetic acid, then with soap and water.

Notes.

(1) External cooling may be dispensed with if more ice is added.

(2) This weight assumes 100 per cent. purity of the sodium hydroxide. If the commercial solid is used, its purity should be determined and a corresponding adjustment made in the weight.

(3) The sodium sulphite solution may also be prepared by dissolving 100 g. of pure (or a corresponding quantity of commercial) sodium hydroxide in about 125 ml. of water, and then diluting to 750 ml. The flask is cooled in running water, a few drops of phenolphthalein indicator are added, and sulphur dioxide passed in until the pink colour just disappears (it is advisable to add a further 1–2 drops of the indicator at this point) and then for 2–3 minutes longer. It is best to remove a sample for test from time to time, dilute with 3–4 volumes of water, and test with 1 drop of phenolphthalein.

(4) If desired, the phenylhydrazine hydrochloride may be purified by recrystallisation. The crude hydrochloride is boiled with 6 times its weight of water and a few grams of decolourising carbon. After filtering, a volume of concentrated hydrochloric acid equal in volume to one-third of the solution is added, and the mixture cooled to 0°. Pure white crystals are obtained in 85–90 per cent. yield.

IV,90.

p-NITROPHENYLHYDRAZINE

Dissolve 10 g. of *p*-nitroaniline (Section IV,51) in a mixture of 21 ml. of concentrated hydrochloric acid and an equal volume of water, and cool rapidly to 0° in order to obtain the hydrochloride of the base in a fine state of division. Diazotise in the usual way (see Section IV,68) by the gradual addition of a solution of 6.0 g. of sodium nitrite in 12 ml. of water. Continue the stirring for a few minutes, filter the solution rapidly, and add it from a separatory funnel to an ice-cold solution of 41 g. of sodium sulphite (90 per cent. $\text{Na}_2\text{SO}_3 \cdot 7\text{H}_2\text{O}$) in 100 ml. of water containing 4 g. of sodium hydroxide (1); stir the mixture during the addition which requires about 5 minutes. (If the diazonium solution is added too rapidly, an orange-red precipitate of sodium *p*-nitrodiazobenzene sulphonate is produced, and is apt to form a resin.) Allow the solution to stand for 5 minutes, acidify with 70 ml. of concentrated hydrochloric acid, and heat on a water bath at 25° for 3 minutes, when yellow needles commence to separate. Allow to stand overnight, filter off the crystals, heat them with 20 ml. of concentrated hydrochloric acid on a water bath for 7 minutes, and allow to cool. Filter off the precipitate, consisting of

p-nitrophenylhydrazine hydrochloride and sodium salts, dissolve it in water and treat the solution with a concentrated solution of sodium acetate: the free base will separate out in an almost pure state (7–8 g.). The *p*-nitrophenylhydrazine may be recrystallised from alcohol and is obtained as light brown crystals, m.p. 158° (decomp.).

Note.

(1) The alkaline sodium sulphite solution may be replaced by saturated ammonium sulphite solution prepared as follows. Pass sulphur dioxide into a mixture of 1 part of concentrated ammonia solution (sp. gr. 0.88) and two parts of crushed ice in a freezing mixture until the liquid smells strongly of sulphur dioxide, and then neutralise with ammonia solution. This solution slowly deposits ammonium sulphite crystals and contains about 0.25 g. of SO₂ per ml. Use 60 ml. of this ice-cold ammonium sulphite solution to which 8 ml. of concentrated ammonia solution are added. After the addition of the solution of *p*-nitrophenyldiazonium chloride, allow the mixture to stand for 1 hour in a freezing mixture, filter off the yellow precipitate of ammonium *p*-nitrophenylhydrazine disulphonate, heat it on a water bath with 20 ml. of concentrated hydrochloric acid at 70–80° for 7 minutes, cool the blood-red solution, and dissolve the resulting precipitate of *p*-nitrophenylhydrazine hydrochloride and ammonium salts in water, and isolate the base as above.

IV.91.

2 : 4-DINITROPHENYLHYDRAZINE

Suspend 35 g. of finely-powdered hydrazine sulphate in 125 ml. of hot water contained in a 400 ml. beaker, and add, with stirring, 118 g. of crystallised sodium acetate or 85 g. of potassium acetate. Boil the mixture for 5 minutes, cool to about 70°, add 80 ml. of rectified spirit, filter at the pump and wash with 80 ml. of hot rectified spirit. Keep the filtered hydrazine solution for the next stage in the preparation.

Equip a 1 litre three-necked flask or a 1 litre bolt-head flask with a reflux condenser and a mercury-sealed stirrer. Dissolve 50.5 g. of commercial 2 : 4-dinitro-1-chlorobenzene in 250 ml. of rectified spirit in the flask, add the hydrazine solution, and reflux the mixture with stirring for an hour. Most of the condensation product separates during the first 10 minutes. Cool, filter with suction, and wash with 50 ml. of warm (60°) rectified spirit to remove unchanged dinitrochlorobenzene, and then with 50 ml. of hot water. The resulting 2 : 4-dinitrophenylhydrazine (30 g.) melts at 191–192° (decomp.), and is pure enough for most purposes. Distil off half the alcohol from the filtrate and thus obtain a less pure second crop (about 12 g.): recrystallise this from *n*-butyl alcohol (30 ml. per gram). If pure 2 : 4-dinitrophenylhydrazine is required, recrystallise the total yield from *n*-butyl alcohol or from dioxan (10 ml. per gram): this melts at 200° (decomp.).

The following alternative method of preparation is recommended. Dissolve 50 g. of purified 2:4-dinitrochlorobenzene (1) in 100 ml. of triethylene glycol (gentle warming may be necessary; alternatively, 125 ml. of warm diethylene glycol may be used) in a 600 ml. beaker and cool, with mechanical stirring, in an ice bath to 15–18°. Place 15 ml. of commercial 60–65 per cent. hydrazine solution in a small separatory funnel supported over the beaker. Add the hydrazine solution to the stirred solution in the beaker at such a rate that the temperature is maintained between 15° and 20° (20–30 minutes). When

the exothermic reaction is over, digest the paste on a boiling water bath with 50 ml. of methanol for 15-20 minutes. Cool the reaction mixture, filter with suction and wash with a little methanol. Dry at 100°. The yield of 2:4-dinitrophenylhydrazine, m.p. 192-193° (decomp.), is 46 g. The product is pure enough for most purposes: the pure compound may be obtained by recrystallisation from *n*-butyl alcohol or from dioxan as described above.

COGNATE PREPARATION

2:4-Dinitroaniline. This preparation is another illustration of the mobile character of the chlorine atom in 2:4-dinitro-1-chlorobenzene:

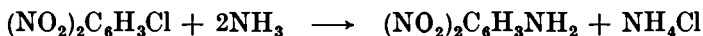

Place a mixture of 18 g. of ammonium acetate and 50 g. of commercial 2:4-dinitro-1-chlorobenzene (1) in a 250 ml. bolt-head flask, and fit it with a reflux condenser and inlet tube (at least 2 cm. diameter in order to prevent clogging) which terminates just above the surface of the reaction mixture. Half immerse the flask in an oil bath. Pass ammonia gas (from a cylinder) through a bubble counter, which contains a solution of 3 g. of potassium hydroxide in 2.5 ml. of water, into the mixture. Heat the oil bath to 170°, and pass the ammonia gas at the rate of 3-4 bubbles per second for 6 hours. Allow the reaction mixture to cool, break up the solid cautiously with a glass rod, add 100 ml. of water, heat to boiling and filter while hot. Dissolve the residue in 500 ml. of boiling rectified (or methylated) spirit, and add water (*ca.* 150 ml.) until the solution becomes turbid; heat until the turbidity disappears and allow the clear solution to cool overnight. Filter the crystals at the pump and dry in the steam oven. The yield is 35 g., m.p. 176-177°. To obtain a perfectly pure product, recrystallise again from alcohol and water; use 20 ml. of alcohol per gram of solid: 31.5 g. of pure 2:4-dinitroaniline, m.p. 180°, are thus obtained.

Note.

(1) It is advisable to recrystallise the commercial dinitrochlorobenzene from alcohol; m.p. 51-52°.

AROMATIC DIAMINES

Compounds containing two primary amino groups attached to a benzene ring can be prepared by the reduction of dinitro compounds and of nitroanilines, usually with tin or stannous chloride and hydrochloric acid or with iron and very dilute hydrochloric acid. *Para*-diamines may also be obtained by the reduction of aromatic amino-azo compounds (e.g., *p*-aminodimethylaniline from methyl orange, see Section IV,78). *p*-Phenylenediamine may also be prepared from *p*-nitroacetanilide: reduction with iron and acid yields *p*-aminoacetanilide, which may be hydrolysed to the diamine.

Experimental details are given for *o*-phenylenediamine, which is conveniently prepared by the reduction of *o*-nitroaniline in alcoholic sodium hydroxide solution with zinc powder :

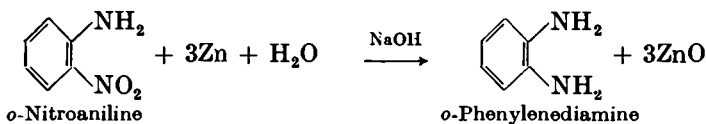

and for *m*-phenylenediamine :

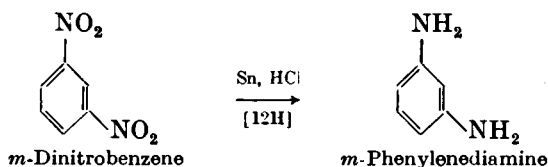

IV,92.

***o*-PHENYLENEDIAMINE**

Equip a 750 ml. three-necked flask with a reflux condenser and a liquid-sealed mechanical stirrer, and place in it 46 g. of *o*-nitroaniline, 27 ml. of 20 per cent. sodium hydroxide solution and 170 ml. of rectified spirit. Stir the mixture vigorously and heat it on a water bath to gentle boiling. Remove the source of heat from beneath the bath, and introduce 5 g. portions of zinc powder at such a rate that the solution is kept boiling (1); add 90 g. of zinc powder (2) in all. Reflux the mixture, with stirring, for 1 hour; the colour of the solution changes from deep red to nearly colourless. Filter the hot mixture at the pump; return the zinc residue to the flask and extract it with two 100 ml. portions of hot rectified spirit. Combine the extracts with the filtrate, add 2 g. of sodium hyposulphite ($\text{Na}_2\text{S}_2\text{O}_4$), and concentrate the solution under reduced pressure (water pump) on a steam bath to a volume of 80–100 ml.; use the apparatus shown in Fig. II, 37, 1. Cool the solution in a freezing mixture of ice and salt, collect the pale yellow crystals on a Buchner funnel, wash once with 10–15 ml. of ice water, and dry in a vacuum desiccator. The yield of crude *o*-phenylenediamine, m.p. 98–100°, is 33 g. This is sufficiently pure for most practical purposes. If a pure material is required (3), dissolve the crude product in 100–115 ml. of hot water containing 1 g. of sodium hyposulphite and add a few grams of decolourising carbon, filter, and cool in an ice-salt mixture. Collect the colourless crystals of pure *o*-phenylenediamine on a Buchner funnel, wash with 10 ml. of

ice water, and dry in a vacuum desiccator; the yield is 28.5 g., m.p. 100-101°. It darkens rapidly upon exposure to light.

Notes.

(1) Sometimes the reaction stops suddenly; it is then necessary to add a further 10 ml. of 20 per cent. sodium hydroxide solution and warm to the boiling point: this causes the reaction to continue. Occasionally, the reduction becomes very vigorous: a wet towel and a bath of ice water should be kept close at hand.

(2) This weight of zinc powder assumes 100 per cent. purity: an equivalent amount of less pure material may be used (see Section IV,83, Note 2).

(3) The crude *o*-phenylenediamine may be converted into the dihydrochloride and the salt purified in the following manner. Dissolve it in 60 ml. of concentrated hydrochloric acid and 40 ml. of water containing 2 g. of stannous chloride, and treat the hot solution with 2-3 g. of decolourising carbon. Filter, add 100 ml. of concentrated hydrochloric acid to the hot colourless filtrate, and cool in a freezing mixture of ice and salt. Collect the colourless crystals of the dihydrochloride on a Buchner or sintered glass funnel, wash with a small volume of concentrated hydrochloric acid, and dry in a vacuum desiccator over sodium hydroxide. The yield is 51 g.

IV,93.

m-PHENYLENEDIAMINE

In a 2-litre round-bottomed flask, provided with a reflux condenser, place 25 g. of *m*-dinitrobenzene (Section IV,12) and 100 g. of granulated tin; add 200 ml. of concentrated hydrochloric acid in 15 ml. portions according to the procedure described under *Aniline* (Section IV,34, *Method 1*). When all the acid has been introduced, complete the reduction by heating on a water bath for 1 hour. Dilute with 750 ml. of water, heat nearly to boiling, and pass hydrogen sulphide into the liquid until all the tin is precipitated as the sulphide. Filter a small quantity from time to time and test for completeness of precipitation with hydrogen sulphide. Allow the precipitate to settle overnight, decant the clear liquid, and filter the residue with suction through two or three filter papers (1). Add sodium hydroxide solution to the filtrate until the latter is strongly alkaline, and extract several times with ether. Dry over anhydrous potassium carbonate or sodium hydroxide pellets, remove the ether, and then distil the residue: use an air condenser after all the ether has passed over. Collect the portion boiling between 280° and 284°: this solidifies on standing to crystalline *m*-phenylenediamine, m.p. 63°. The yield is 13 g.

Note.

(1) The dihydrochloride may be obtained by evaporating the filtrate on a water bath until crystals appear, and then cooling in ice. The crystals are filtered at the pump, washed with a little concentrated hydrochloric acid, and dried in a vacuum desiccator over sodium hydroxide.

A little hydrogen sulphide is evolved in the reaction and triphenylguanidine is formed as a by-product, probably in accordance with the following scheme :

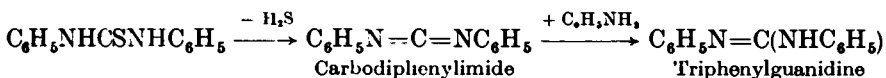

Place 25 g. of crude thiocarbanilide (Section IV,94) and 100 ml. of concentrated hydrochloric acid in a 250 ml. distilling flask ; plug the side arm of the flask, and fit a reflux condenser into the neck (Fig. III, 28, 1 but with the trap omitted). Reflux gently in the fume cupboard for 30 minutes. Arrange the flask for distillation (compare Fig. II, 13, 1) and distil the mixture until the oily phenyl *iso*-thiocyanate has all passed over ; the volume remaining in the flask will be 25–30 ml. Crystals of triphenylguanidine hydrochloride may appear in the distilling flask during the latter part of the distillation. Dilute the distillate with an equal volume of water, and extract the mustard oil with ether ; wash the extract with a little sodium carbonate solution, and dry over anhydrous calcium chloride or magnesium sulphate. Remove the ether using a small distilling flask (Fig. II, 13, 4) and then distil the residual oil. Collect the phenyl *iso*-thiocyanate at 217–220° (1). The yield is 10 g.

To isolate the triphenylguanidine, dilute the residue in the flask with 50 ml. of water, add 2–3 g. of decolourising carbon, warm, and filter. Cool the solution in ice, and filter off the hydrochloride at the pump. Dissolve it in the minimum volume of hot water, render the solution alkaline with sodium hydroxide, and allow to cool. Filter off the free base (triphenylguanidine), and recrystallise it from alcohol ; it separates in colourless crystals, m.p. 144°. The yield is 3 g.

Note.

(1) It may also be distilled under diminished pressure ; see Section IV,96.

IV,96. PHENYL *iso*-THIOCYANATE (from Aniline)

Phenyl *iso*-thiocyanate may be prepared in quantity directly from aniline. Aniline, carbon disulphide and concentrated aqueous ammonia react to form the sparingly soluble ammonium phenyldithiocarbamate ; this is decomposed by lead nitrate to produce phenyl *iso*-thiocyanate :

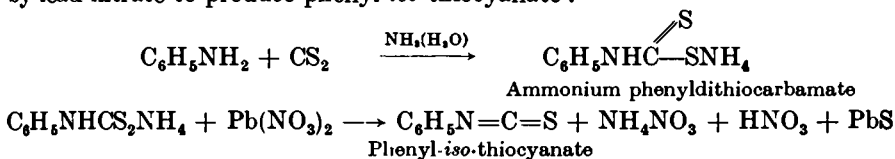

Equip a 500 ml. three-necked flask with a powerful mechanical stirrer and a separatory funnel ; leave the third neck open or loosely stoppered. Introduce, while the flask is cooled in a freezing mixture of ice and salt, 90 ml. of concentrated ammonia solution (sp. gr. 0·88) and 54 g. (43 ml.) of pure (*e.g.*, A.R.) carbon disulphide. Stir the mixture and run in 56 g. (55 ml.) of pure aniline from the separatory funnel during about 20 minutes ; stir for a further 30 minutes, and allow to stand for another 30 minutes. A heavy precipitate of ammonium phenyldithiocarbamate separates. Transfer the salt to a 5 litre round-bottomed flask by four extractions with 200 ml. portions of water. Add to the resulting solution, with

constant stirring, a solution of 200 g. of lead nitrate in 400 ml. of water; lead sulphide precipitates. Steam distil the mixture into a receiver containing 10 ml. of *ca.* *N*-sulphuric acid as long as organic material passes over (2-3 litres of distillate). Separate the oil, dry it over anhydrous calcium chloride or magnesium sulphate, and distil under diminished pressure. Collect the phenyl *iso*-thiocyanate at 120-121°/35 mm. or at 95°/12 mm. The yield is 62 g.

COGNATE PREPARATION

***p*-Bromophenyl *iso*-thiocyanate**, *p*-BrC₆H₄NCS. Add 41 ml. of concentrated ammonia solution (sp. gr. 0·88) slowly to a solution of 45 g. of *p*-bromoaniline (Section IV,49), 30 g. (24 ml.) of A.R. carbon disulphide and 40 ml. of rectified spirit (95 % C₂H₅OH) at 10-15° contained in a flask. Stopper the flask, cover it with a damp towel, and shake the milky suspension occasionally until a clear solution is obtained: do not allow the temperature to rise above 30°. Considerable heat is evolved, and the intermediate dithiocarbamate soon crystallises out. Allow to stand overnight, filter the crystals, wash with a little ether, dissolve in 1500 ml. of water, and stir mechanically while a solution of 87 g. of lead nitrate in 175 ml. of water is slowly added. Continue the stirring for 20 minutes, and isolate the *p*-bromophenyl *iso*-thiocyanate by steam distillation into a receiver containing 5 ml. of *ca.* *N* sulphuric acid; if the substance solidifies in the condenser, stop the cooling water until the solid has melted and run into the receiver. Filter the cold solid product, wash with a little water, and dry in the air upon filter paper. The yield is 15 g., m.p. 61°.

In this modified procedure the presence of alcohol is essential otherwise no *iso*-thiocyanate is obtained. The process may be applied to other substituted anilines.

IV,97. PHENYLUREA * (*Cyanate Method*)

Salts of primary aromatic amines react with solutions of alkali cyanates to yield first the amine cyanate, which then undergoes molecular rearrangement to the arylurea, for example:

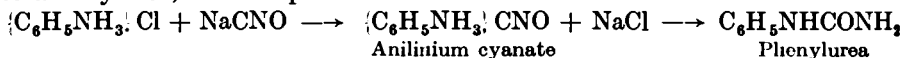

The monoarylurea may be prepared directly from the amine by heating it in aqueous solution with an equivalent quantity of alkali cyanate and excess of acetic acid, for example:

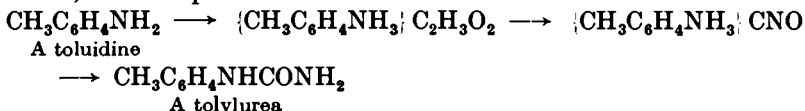

Method 1 (from the amine hydrochloride). Dissolve 13·0 g. of aniline hydrochloride in 200 ml. of water and filter, if necessary, from any insoluble matter into a 350 ml. beaker or conical flask. Add a solution of 6·5 g. of pure sodium cyanate in 50 ml. of warm water. Allow to stand for a few hours until crystallisation is complete. Filter with suction on a Buchner funnel, and wash with a little cold water. Dry in the steam

* Also termed monophenylurea.

oven. The phenylurea is usually colourless and melts at 148° , *i.e.*, is pure: the yield is 9 g. If the m.p. is somewhat low or if the product is slightly discoloured, dissolve it in 9–10 times its weight of boiling water, add cautiously 1–2 g. of decolourising carbon, and filter with the aid of a hot water funnel or a Buchner funnel and flask which have been preheated by the filtration of some boiling distilled water. Allow to cool, collect and dry the crystals as above.

Method 2 (from the free amine). Dissolve 9.3 g. (9.1 ml.) of aniline in 10 ml. of glacial acetic acid diluted to 100 ml. contained in a 250 ml. beaker or conical flask, and add with stirring or shaking a solution of 6.5 g. of pure sodium cyanate in 50 ml. of warm water. Allow to stand for 30 minutes, then cool in ice, and allow to stand for a further 30 minutes. Filter at the pump, wash with water and dry in the steam oven. The resulting phenylurea is generally colourless and has a m.p. of 148° (*i.e.*, is pure): the yield is 11 g. If the colour or the m.p. of the product is not quite satisfactory, recrystallise it from boiling water (10 ml. per gram) as in *Method 1*.

COGNATE PREPARATION

***p*-Tolylurea.** Dissolve 10.7 g. of *p*-toluidine in a warm mixture of 10 ml. of glacial acetic acid and 50 ml. of water, and then dilute with 150 ml. of hot water. Introduce, with stirring or shaking, a solution of 6.5 g. of pure sodium cyanate in 50 ml. of hot water. The *p*-tolylurea precipitates almost immediately. Allow to stand several hours, filter at the pump, wash with water, and dry in the steam oven. The yield of *p*-tolylurea, m.p. $180\text{--}180.5^{\circ}$, is 14 g. Recrystallise by dissolving the crude product under reflux in about 95 ml. of methylated spirit and adding hot water in small portions until the solution is just turbid: warm until the solution is clear and allow to cool; filter and dry. The resulting *p*-tolylurea melts sharply at 181° .

***p*-Bromophenylurea.** Proceed as for *p*-Tolylurea, but use 17.2 g. of *p*-bromoaniline dissolved in a mixture of 50 ml. of glacial acetic acid and 100 ml. of water at 35° ; add gradually a solution of 6.5 g. of sodium cyanate in 50 ml. of water at 35° . The yield of crude *p*-bromophenylurea is 19 g.; m.p. 227° . Recrystallise from aqueous alcohol (240 ml. ethanol and 30 ml. of water); m.p. 228° . The m.p. depends somewhat upon the rate of heating.

IV.98. PHENYLUREA (*Urea Method*)

Salts of primary aromatic amines react with a solution of urea to give the corresponding arylureas, for example:

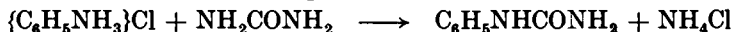

The *mechanism* of the reaction involves the intermediate formation of an amine cyanate (see previous Section); in aqueous solution urea behaves as an equilibrium mixture with ammonium cyanate:

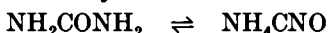

Some *sym.*-diphenylurea is also formed and the quantity increases with continued refluxing:

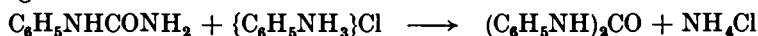

The diarylurea is insoluble in boiling water and is therefore easily separated from the monoarylurea, which is readily soluble. The proportion of diarylurea is highest for aniline and decreases with substituted anilines.

Dissolve 65 g. of aniline hydrochloride and 120 g. of urea in 200 ml. of water contained in a 1-litre round-bottomed flask; filter the solution, if necessary. Add 4 ml. of concentrated hydrochloric acid and 4 ml. of glacial acetic acid. Fit a reflux condenser to the flask, introduce a few fragments of broken porcelain, and boil the mixture for 30 minutes. Fine white crystals (largely *sym.*-diphenylurea) appear after about 15 minutes and gradually increase in amount as the refluxing is continued. Cool the flask in ice and filter with suction. Separate the mixture of phenylurea and diphenylurea (*ca.* 42 g.) by boiling with 500 ml. of water and filter at the pump through a preheated Buchner funnel into a warm flask; cool the filtrate, collect the phenylurea, drain well and dry in the steam oven. The phenylurea melts at 146–147° and weighs 30 g.; recrystallisation from hot water raises the m.p. to 148°. The crude diphenylurea (residue from first recrystallisation after drying at 100°) has m.p. 241° and weighs 10 g.; recrystallisation from glacial acetic acid or ethyl acetate with the addition of a little decolourising carbon gives a colourless product, m.p. 242°.

COGNATE PREPARATIONS

***p*-Tolylurea.** Reflux a mixture of 18 g. *p*-toluidine hydrochloride, 30 g. of urea, 50 ml. of water, 1 ml. of concentrated hydrochloric acid and 1 ml. of glacial acetic acid contained in a 250 ml. bolt-head flask for 1 hour. The mixture becomes cloudy after about 10 minutes and a solid gradually collects at the surface of the liquid. Cool the reaction mixture in ice, filter with suction and wash with two 25 ml. portions of cold water. Drain well and dry the crude product at 120° for 2 hours; the yield is 18 g., m.p. 175°. Recrystallise as follows: dissolve the solid in 125 ml. of absolute industrial spirit, add hot water until the solution is just turbid, warm until the solution is clear (filter, if necessary, through a preheated Buchner funnel) and allow to cool. Filter; dry at 120°. The yield of *p*-tolylurea, m.p. 181°, is 12 g. Concentrate the mother liquor to about half the original volume, cool and filter; a further 2·5 g. of *p*-tolylurea, m.p. 180°, is obtained.

***p*-Methoxyphenylurea.** Proceed as for *Phenylurea* but use 79 g. of *p*-anisidine hydrochloride in place of 65 g. of aniline hydrochloride; reflux the mixture for 1 hour. Cool the reaction mixture slowly to 0°, filter and recrystallise from boiling water. The yield of *p*-methoxyphenylurea, m.p. 168°, is 60 g.

***p*-Ethoxyphenylurea.** Proceed as for *Phenylurea* but use 87 g. of *p*-phenetidine hydrochloride; reflux the mixture for 45–90 minutes. The product commences to separate after 20–30 minutes and increases rapidly until the entire contents of the flask suddenly set to a solid mass: withdraw the source of heat *immediately* at this point. Cool to room temperature, add 150 ml. of water, stir, filter with suction, and wash with cold water. Suspend the solid in 2 litres of boiling water, add 1 g. of decolourising carbon, boil for 5 minutes, and filter through a hot water funnel:

cool the colourless filtrate slowly to 0°, collect the solid which separates and dry at 100°. The yield of *p*-ethoxyphenylurea, m.p. 174°, is 60 g.

IV,99.

***p*-IODOANILINE**

This preparation illustrates the direct iodination of a primary aromatic amine by iodine; the sodium bicarbonate removes the hydrogen iodide as formed:

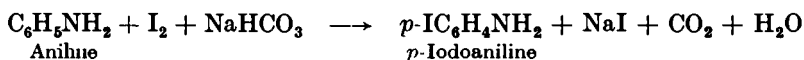

Into a 1-litre beaker, provided with a mechanical stirrer, place 36.8 g. (36 ml.) of aniline, 50 g. of sodium bicarbonate and 350 ml. of water; cool to 12–15° by the addition of a little crushed ice. Stir the mixture, and introduce 85 g. of powdered, resublimed iodine in portions of 5–6 g. at intervals of 2–3 minutes so that all the iodine is added during 30 minutes. Continue stirring for 20–30 minutes, by which time the colour of the free iodine in the solution has practically disappeared and the reaction is complete. Filter the crude *p*-iodoaniline with suction on a Buchner funnel, drain as completely as possible, and dry it in the air. Save the filtrate for the recovery of the iodine (1). Place the crude product in a 750 ml. round-bottomed flask fitted with a reflux double surface condenser add 325 ml. of light petroleum, b.p. 60–80°, and heat in a water bath maintained at 75–80°. Shake the flask frequently and after about 15 minutes, slowly decant the clear hot solution into a beaker set in a freezing mixture of ice and salt, and stir constantly. The *p*-iodoaniline crystallises almost immediately in almost colourless needles; filter and dry the crystals in the air. Return the filtrate to the flask for use in a second extraction as before (2). The yield of *p*-iodoaniline, m.p. 62–63°, is 60 g.

Notes.

(1) The iodine may be recovered from the aqueous filtrate, containing sodium iodide, in the following manner. Add 33 ml. of concentrated sulphuric acid and a solution of 65 g. of sodium dichromate in 65 ml. of water. Allow the iodine to settle, wash it three times by decantation, filter, and allow to dry on a clock glass. The weight of crude iodine is about 50 g.

(2) Two extractions usually suffice, but if much organic material remains, a third extraction should be made. If the *p*-iodoaniline from the second and third extractions is coloured, it should be refluxed for a short period in light petroleum solution with a little decolourising carbon and filtered through a hot water funnel (**CAUTION**: inflammable).

COGNATE PREPARATION**5-IODO-2-AMINOTOLUENE**

A good yield of 5-iodo-2-aminotoluene may be obtained by intimately mixing *o*-toluidine hydrochloride, iodine and calcium carbonate, and then adding water to the mixture. The liberated hydriodic acid reacts at once with the calcium carbonate and the hydriodide of the base is not formed.

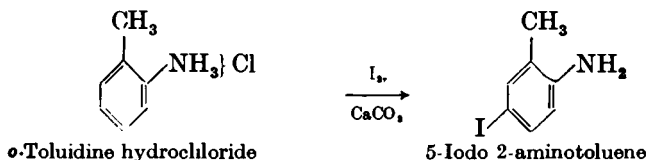

Triturate 20 g. of dry *o*-toluidine hydrochloride and 35.5 g. of powdered iodine in a mortar and then grind in 17.5 g. of precipitated calcium carbonate. Transfer the mixture to a conical flask, and add 100 ml. of distilled water with vigorous shaking of the flask. Allow the mixture to stand for 45 minutes with occasional agitation, then heat gradually to 60–70° for 5 minutes, and cool. Transfer the contents of the flask to a separatory funnel, extract the base with three 80 ml. portions of ether, dry the extract with anhydrous calcium chloride or magnesium sulphate, and remove the excess of solvent. The crude 5-iodo-2-aminotoluene separates in dark crystals. The yield is 32 g. Recrystallise from 50 per cent. alcohol; nearly white crystals, m.p. 87°, are obtained.

IV,100. REACTIONS AND CHARACTERISATION OF AROMATIC AMINES

Those reactions which are common to both aliphatic and aromatic amines and have been described under *Aliphatic Amines* (Section III,123) will not be repeated in this Section except where differences in experimental technique occur.

PRIMARY AMINES

(i) **Carbylamine test.** See Section III,123,(iii). The following alternative technique may be employed. Add 1 drop of the liquid (or 0.02 g. of the solid) amine to 2 ml. of alcohol. Place 1 drop of the resulting *ca.* 1 per cent. solution in a small test-tube with 1 drop of chloroform and 4 ml. of 10 per cent. sodium hydroxide solution; heat the solution gently. The unpleasant odour of an *iso*-cyanide will be apparent with a primary amine.

(ii) **5-Nitrosalicylaldehyde reagent test.** A positive result is obtained in 2–3 minutes.

(iii) **Reaction with nitrous acid and the formation of an azo dye.** Dissolve 1.0 ml. (1.0 g.) of aniline (or the equivalent quantity of any other amine) in 3 ml. of concentrated hydrochloric acid and 5 ml. of water, and cool the solution to 0–5°. Add a cold solution of 1.0 g. of sodium nitrite in 5 ml. of water slowly (preferably by means of a dropper) and with stirring until, after standing for 3–4 minutes, an immediate positive test for nitrous acid is obtained. Remove 1 drop of the solution, dilute with 4–5 drops of water, and apply to potassium iodide-starch paper; an immediate blue colouration should be obtained. Divide the resulting diazonium solution into two parts. To one portion add a cold solution of 0.4 g. of β -naphthol in 4 ml. of 5 per cent. sodium hydroxide solution. A coloured (*e.g.*, orange-red) dye is formed; this may be filtered off and recrystallised from water, alcohol or acetic acid (for an explanation of the reaction involved, see Section IV,76). Warm the other half of the solution: nitrogen is evolved and a phenol is produced (see Section IV,69); note the odour.

Primary aromatic diamines cannot be diazotised (tetrazotised) and coupled normally. Thus *o*-phenylenediamine yields a triazole derivative and *m*-phenylenediamine gives an azo dye (Bismarck brown) by self-coupling.

SECONDARY AMINES

(iv) Carbylamine test. This is negative if the secondary amine is free from primary aromatic amine.

(v) Reaction with nitrous acid. Nitrosamines are formed (compare Section IV,40); these are usually yellow oils or low m.p. solids, and give the Liebermann nitroso reaction. The latter reaction consists in warming the nitrosamine with phenol and concentrated sulphuric acid. The sulphuric acid liberates nitrous acid from the nitrosamine, the nitrous acid reacts with the phenol to form *p*-nitrosophenol, which then combines with another molecule of phenol to give a red indophenol. In alkaline solution the red indophenol yields a blue indophenol anion:

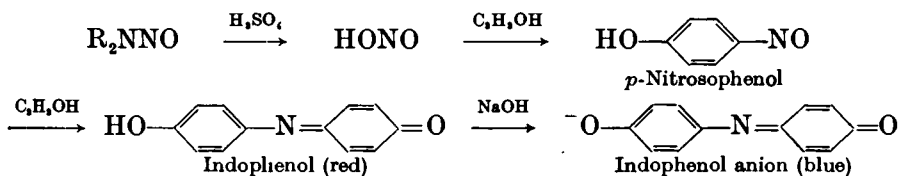

Dissolve 1 g. of the secondary amine in 3-5 ml. of dilute hydrochloric acid or of alcohol (in the latter case, add 1 ml. of concentrated hydrochloric acid). Cool to about 5° and add 4-5 ml. of 10 per cent. sodium nitrite solution, and allow to stand for 5 minutes. Add 10 ml. of water, transfer to a small separatory funnel and extract the oil with about 20 ml. of ether. Wash the ethereal extract successively with water, dilute sodium hydroxide solution and water. Remove the ether on a previously warmed water bath: no flames should be present in the vicinity. Apply Liebermann's nitroso reaction to the residual oil or solid thus. Place 1 drop or 0.01-0.02 g. of the nitroso compound in a dry test-tube, add 0.05 g. of phenol and warm together for 20 seconds; cool, and add 1 ml. of concentrated sulphuric acid. An intense green (or greenish-blue) colouration will be developed, which changes to pale red upon pouring into 30-50 ml. of cold water; the colour becomes deep blue or green upon adding excess of sodium hydroxide solution.

TERTIARY AMINES

(vi) Carbylamine test. This is negative for pure tertiary amines.

(vii) Reaction with nitrous acid. The dialkyl-anilines yield green solid *p*-nitroso compounds (compare Section IV,42). Thus dimethylaniline reacts with nitrous acid to yield *p*-nitrosodimethylaniline:

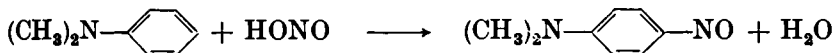

Dissolve 1.0 g. of dimethylaniline in 10 ml. of dilute hydrochloric acid (1:1), cool to 0-5°, and slowly add, with stirring, a solution of 0.70 g. of sodium nitrite in 4 ml. of water. After 20-30 minutes, filter off the precipitated yellow hydrochloride,* and wash it with a little dilute hydrochloric acid. Dissolve the precipitate in the minimum volume

* The hydrochloride may not separate with other dialkylanilines. Add a slight excess of sodium carbonate or sodium hydroxide to the solution, extract the free base with ether, etc.

of water, add a solution of sodium carbonate or sodium hydroxide to decompose the hydrochloride (*i.e.* until alkaline), and extract the free base with ether. Evaporate the ether, and recrystallise the residual green crystals of *p*-nitrosodimethylaniline from light petroleum (b.p. 60–80°) or from benzene. The pure compound has m.p. 85°.

The *p*-nitroso compounds do not give Liebermann's nitroso reaction.

(viii) Separation of primary, secondary and tertiary amines (Hinsberg's method). When a mixture of primary, secondary and tertiary amines is shaken with benzenesulphonyl chloride in the presence of dilute sodium hydroxide solution, the following reactions occur:—

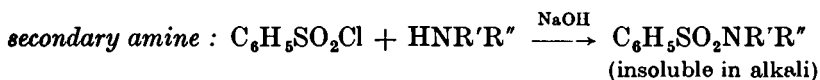
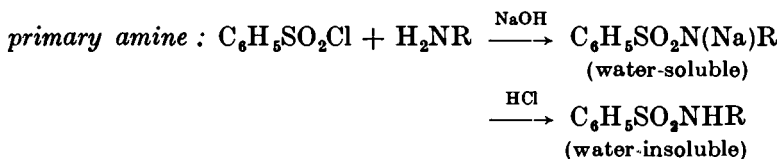

tertiary amine ; does not react, and may be removed by steam distillation or solvent extraction.

The benzenesulphonyl derivatives are crystalline solids and may be filtered off. They may be identified and separated from one another by taking advantage of the fact that the derivative from the primary amine is soluble in dilute sodium hydroxide solution (since it contains a hydrogen atom attached to nitrogen and activated by the strongly unsaturated sulphonyl group) whilst the derivative of the secondary amine is insoluble in dilute alkali (since it contains no corresponding hydrogen atom) :

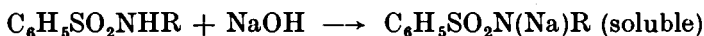

Upon acidifying the solution of the sodium derivative with hydrochloric acid, the corresponding sulphonamide $C_6H_5SO_2NHR$ is precipitated. By boiling the sulphonamides with 10–12 times the weight of 25 per cent. hydrochloric acid or, better, with 80 per cent. sulphuric acid, rendering alkaline with sodium hydroxide and extracting with ether, the original primary and/or secondary amines may be recovered :

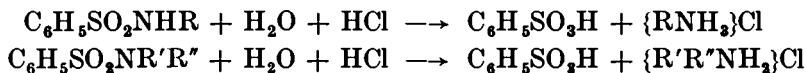

Certain primary amines yield disulphonyl derivatives, which are insoluble in alkali and therefore may be confused with the monosulphonyl derivatives of secondary amines.

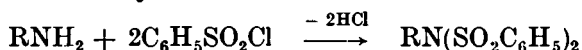

These may be hydrolysed to the monosulphonyl derivatives by boiling for 30 minutes with a 5 per cent. solution of sodium ethoxide in ethyl alcohol :



There are complications in applying the Hinsberg test to certain amines containing hydroxyl, nitro and carboxyl groups, *e.g.*, *p*-*N*-methylaminobenzoic acid $\{\text{CH}_2\text{NHC}_6\text{H}_4\text{COOH (1 : 4)}\}$ may behave in this test as a primary amine (soluble in alkali) so that it is essential to consider the properties of the original compound in conjunction with the results of the test.

p-Toluenesulphonyl chloride may replace benzenesulphonyl chloride.

The following experimental details will illustrate how the Hinsberg separation of amines may be carried out in practice.

Method 1. Treat 2.0 g. of the mixture of amines with 40 ml. of 10 per cent. sodium hydroxide solution and add 4 g. (3 ml.) of benzenesulphonyl chloride (or 4 g. of *p*-toluenesulphonyl chloride) in small portions. Warm on a water bath to complete the reaction. Acidify the alkaline solution with dilute hydrochloric acid when the sulphonamides of the primary and secondary amines are precipitated. Filter off the solid and wash it with a little cold water; the tertiary amine will be present in the filtrate. To convert any disulphonamide that may have been formed from the primary amine into the sulphonamide, boil the solid under reflux with 2.0 g. of sodium dissolved in 40 ml. of absolute ethyl alcohol for 30 minutes. Dilute with a little water and distil off the alcohol: filter off the precipitate of the sulphonamide of the secondary amine. Acidify the filtrate with dilute hydrochloric acid to precipitate the derivative of the primary amine. Recrystallise the respective derivatives from alcohol or from dilute alcohol, and identify them *inter alia* by a determination of the m.p.

Method 2. Place a 3.0 g. sample of the mixture of amines in a flask, add 6 g. (4.5 ml.) of benzenesulphonyl chloride (or 6 g. of *p*-toluenesulphonyl chloride) and 100 ml. of a 5 per cent. solution of sodium hydroxide. Stopper the flask and shake vigorously until the odour of the acid chloride has disappeared: open the flask occasionally to release the pressure developed by the heat of the reaction. Allow the mixture to cool, and dissolve any insoluble material in 60–75 ml. of ether. If a solid insoluble in both the aqueous and ether layer appears at this point (it is probably the sparingly soluble salt of a primary amine, *e.g.*, a long chain compound of the type $\text{C}_6\text{H}_5(\text{CH}_2)_n\text{NH}_2$), add 25 ml. of water and shake; if it does not dissolve, filter it off. Separate the ether and aqueous layers. The ether layer will contain the unchanged tertiary amine and the sulphonamide of the secondary amine. Acidify the alkaline aqueous layer with dilute hydrochloric acid, filter off the sulphonamide of the primary amine, and recrystallise it from dilute alcohol. Extract the ether layer with sufficient 5 per cent. hydrochloric acid to remove all the tertiary amine present. Evaporate the ether to obtain the sulphonamide of the secondary amine: recrystallise it from alcohol or dilute alcohol. Finally, render the hydrochloric acid extract alkaline by the addition of dilute sodium hydroxide solution, and isolate the tertiary amine.

The above reactions will serve to place an amine into its class—primary, secondary or tertiary. For complete characterisation, a crystalline derivative should be prepared. A large number of derivatives of amines are available: the following will be found useful.

CRYSTALLINE DERIVATIVES OF PRIMARY AND SECONDARY AMINES

1. **Acetyl derivatives.** Primary and secondary amines are best acetylated with acetic anhydride :

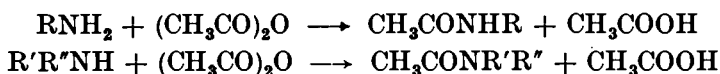

Acetyl chloride is not so satisfactory since an equivalent quantity of the amine hydrochloride is simultaneously produced :

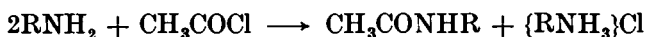

Reflux gently in a test-tube under a short air condenser 1 g. of the base with 2.5 mols {or 3.0 g. (3.0 ml.) if the molecular weight is unknown} of redistilled acetic anhydride for 10–15 minutes. Cool the reaction mixture and pour it into 20 ml. of cold water (*CAUTION*). Boil to decompose the excess of acetic anhydride. When cold, filter the residual insoluble acetyl derivative and wash it with a little cold water. Recrystallise from water or from dilute alcohol.

Certain *ortho* substituted derivatives of aromatic amines are difficult to acetylate under the above conditions owing to steric hindrance. The process is facilitated by the addition of a few drops of concentrated sulphuric acid (compare Section IV,47), which acts as a catalyst, and the use of a large excess of acetic anhydride.

Excellent results may be obtained by conducting the acetylation in aqueous solution (*cf.* Section IV,45). Dissolve 0.5 g. of the amine in 2*N* hydrochloric acid, and add a little crushed ice. Introduce a solution of 5 g. of hydrated sodium acetate in 25 ml. of water, followed by 5 ml. of acetic anhydride. Shake the mixture in the cold until the smell of acetic anhydride disappears. Collect the solid acetyl derivative, and recrystallise it from water or dilute alcohol.

2. **Benzoyl derivatives.** Both primary and secondary amines form benzoyl derivatives under the conditions of the Schotten-Baumann reaction (see Section IV,52 and preceding discussion).

Suspend 1 g. (or 1 ml.) of the substance in 20 ml. of 5 per cent. sodium hydroxide solution * in a well-corked boiling tube or small conical flask, and add 2 ml. of redistilled benzoyl chloride, *ca.* 0.5 ml. at a time, with constant shaking, and cooling in water (if necessary). Shake vigorously for 5–10 minutes until the odour of the benzoyl chloride has disappeared. Make sure that the mixture has an alkaline reaction. Filter off the solid benzoyl derivative, wash it with a little cold water, and recrystallise it from alcohol or dilute alcohol.

If the benzoyl derivative is soluble in alkali, precipitate it together with the benzoic acid derived from the reagent by the addition of hydrochloric acid : filter and extract the product with cold ether or light petroleum (b.p. 40–60°) to remove the benzoic acid.

The following alternative procedure is sometimes useful. Heat the amine with the theoretical quantity of benzoyl chloride (if the molecular weight is unknown, use an equal weight of benzoyl chloride in the preliminary experiment) to 100° for 20–30 minutes. Allow to cool, add excess of 5 per cent. sodium hydroxide solution and shake, if necessary,

* Potassium hydroxide solution gives a slightly better yield of the benzoyl derivative.

until the odour of benzoyl chloride has disappeared. Filter off the precipitate, wash it with cold water, and recrystallise it from alcohol or dilute alcohol.

3. **Benzenesulphonyl or *p*-toluenesulphonyl derivatives.** The Hinsberg procedure for the separation of primary, secondary and tertiary amines is given under (viii) above, and this method may be used. The following experimental details may, however, be found useful for the preparation of derivatives of primary and secondary amines.

Treat 1 g. (1 ml.) of the amine with 4 mols of 10 per cent. sodium or potassium hydroxide solution (say, 20 ml.), and add 1.5 mols (or 3 g. if the molecular weight is unknown) of benzenesulphonyl or *p*-toluenesulphonyl chloride in small portions with constant shaking. To remove the excess of acid chloride, either shake vigorously or warm gently. Acidify with dilute hydrochloric acid and filter off the sulphonamide. Recrystallise it from alcohol or dilute alcohol.

If the presence of a disulphonyl derivative from a primary amine is suspected (*e.g.*, formation of a precipitate in alkaline solution even after dilution), reflux the precipitate, obtained after acidifying, with a solution of 1 g. of sodium in 20 ml. of rectified spirit for 15 minutes. Evaporate the alcohol, dilute with water, and filter if necessary: acidify with dilute hydrochloric acid. Collect the sulphonyl derivative and recrystallise it from alcohol or dilute alcohol.

It is generally more convenient to employ the solid *p*-toluenesulphonyl chloride (m.p. 69°) rather than the liquid benzenesulphonyl chloride. Moreover, the benzenesulphonamides of certain secondary amines are oils or low melting point solids that may be difficult to crystallise: the *p*-toluenesulphonamides usually have higher melting points and are more satisfactory as derivatives. Technical *p*-toluenesulphonyl chloride may be purified by dissolving it in benzene and precipitating with light petroleum (b.p. 40-60°).

Feebly basic amines, *e.g.*, the nitroanilines, generally react so slowly with benzenesulphonyl chloride that most of the acid chloride is hydrolysed by the aqueous alkali before a reasonable yield of the sulphonamide is produced; indeed, *o*-nitroaniline gives little or no sulphonamide under the conditions of the Hinsberg test. Excellent results are obtained by carrying out the reaction in *pyridine solution*:

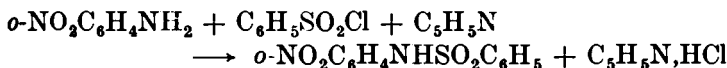

Reflux a mixture of 1 g. (1 ml.) of the amine, 2-3 g. of benzenesulphonyl chloride and 6 ml. of pyridine for 30 minutes. Pour the reaction mixture into 10 ml. of cold water and stir until the product crystallises. Filter off the solid and recrystallise it from alcohol or dilute alcohol.

Most amines react so rapidly in pyridine solution that the reaction is usually complete after refluxing for 10-15 minutes.

4. **Benzal derivatives.** *Primary* aromatic amines generally condense directly with benzaldehyde to form benzal derivatives (Schiff's bases or anils):

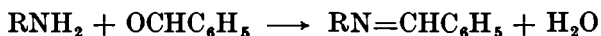

These are often crystalline and therefore useful for the characterisation of primary amines. Diamines may, of course, yield di-benzal derivatives.

Heat the amine with one or two mols of redistilled benzaldehyde (according as to whether the base is a monamine or diamine) to 100° for 10 minutes; if the molecular weight is unknown, use 1 g. of the base and 1 or 2 g. of benzaldehyde. Sometimes a solvent, such as alcohol (5 ml.) or acetic acid, may be used. Recrystallise from alcohol, dilute alcohol or benzene.

5. **Picrates.** Experimental details will be found under *Aliphatic Amines*, Section III,123, 3.

6. **2:4-Dinitrophenyl derivatives.** The halogen atom in 2:4-dinitrochlorobenzene is reactive and coloured crystalline compounds (usually yellow or red) are formed with primary and with secondary amines:

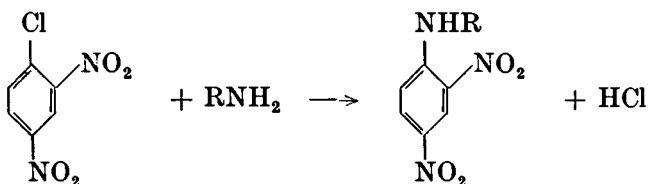

Dissolve 1.0 g. (or 1.0 ml.) of the amine and 1.0 g. of 2:4-dinitrochlorobenzene in 5-10 ml. of ethanol, add a slight excess of anhydrous potassium carbonate or of powdered fused sodium acetate, reflux the mixture on a water bath for 20-30 minutes, and then pour into water. Wash the precipitated solid with dilute sodium carbonate solution, followed by dilute hydrochloric acid. Recrystallise from ethanol, dilute alcohol or glacial acetic acid.

Note. Dinitrochlorobenzene must be handled with care: it is a skin irritant. If it touches the skin, wash it off immediately with methylated spirit.

7. **Derivatives with 3-nitrophthalic anhydride.** 3-Nitrophthalic anhydride reacts with primary and secondary amines to yield nitrophthalamic acids; it does not react with tertiary amines. The phthalamic acid derived from a primary amine undergoes dehydration when heated to 145° to give a neutral *N*-substituted 3-nitrophthalimide. The phthalamic acid from a secondary amine is stable to heat and is, of course, soluble in alkali. The reagent therefore provides a method for distinguishing and separating a mixture of primary and secondary amines.

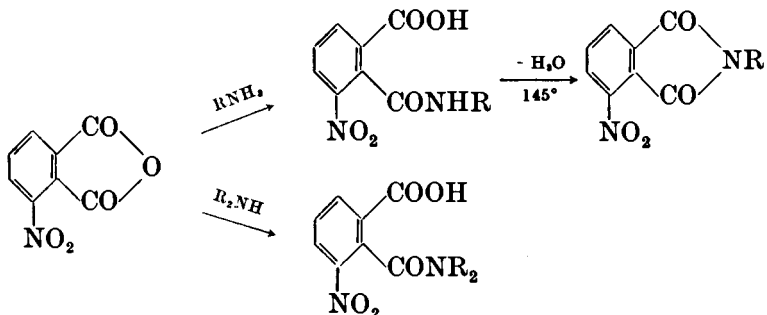

Heat 0.5 g. (or 0.5 ml.) of the amine with 0.5 g. of pure 3-nitrophthalic anhydride (Section VII,19) in an oil bath at 145-150° for 10-20 minutes,

pour the reaction mixture into a small mortar or Pyrex dish, and allow it to solidify. Recrystallise from alcohol, aqueous alcohol or alcohol-acetone.

8. Formyl derivatives. Formic acid condenses with primary and secondary amines to yield formyl derivatives :



With *o*-phenylenediamine, benziminoazole is formed :



Reflux 0.5 g. of the amine with 5 ml. of 90 per cent. formic acid (CAUTION in handling) for 10 minutes, and dilute the hot solution with 10 ml. of cold water. Cool in ice and, in some cases, saturate with salt if the derivative does not separate immediately. Filter, wash with cold water, and recrystallise from water, alcohol or light petroleum (b.p. 60–80°).

9. Phenylthioureas. Experimental details are given under *Aliphatic Amines*, Section III, 123, 2.

The melting points of the derivatives of a number of selected primary and secondary aromatic amines are given in Tables IV, 100A and IV, 100B respectively.

TABLE IV, 100A.

PRIMARY AROMATIC AMINES

Amine	B.P.	M.P.	Acetamide	Benzamide	Benzene-sulphonamide	<i>p</i> -Toluenesulphonamide	Benzal Derivative	Picrate	3-Nitro-phthalimide	2:4-Dinitro-phenyl Derivative	Formyl Derivative	Phenylthio-urea
Aniline	183°	—	114°	163°	112°	103°	54°	—	138°	156°	47°	154°
<i>o</i> -Toluidine	200	—	112	144	124	110	—	213°	150	126	59	136
<i>m</i> -Toluidine	203	—	66	125	95	114	—	200	130	161	—	104
<i>p</i> -Toluidine	200	45°	154	158	120	118	—	181	156	137	53	141
<i>vic.</i> - <i>m</i> -Xylidine (1)	215	11	177	168	—	212	—	180	—	—	176	148
<i>asym.</i> - <i>m</i> -Xylidine (2)	216	—	130	192	130	181	—	209	—	156	114	152
<i>sym.</i> - <i>m</i> -Xylidine (3)	220	10	144	136	—	—	—	209	—	—	77	153
<i>p</i> -Xylidine (4)	214	15	142	140	—	232	—	—	—	150	—	—
Mesidine (5)	232	—	216	206	—	167	—	193	—	—	—	193
α -Naphthylamine	300	50	160	161	169	157	73	163	223	190	139	165
β -Naphthylamine	294	113	134	162	102	133	—	195	212	179	122	129
Benzylamine	185	—	60	106	88	116	—	199	143	—	—	156
β -Phenylethylamine	198	—	51	116	69	—	—	167	—	—	—	135
<i>cyclo</i> Hexylamine	134	—	104	149	—	—	—	—	—	—	—	—
<i>o</i> -Chloroaniline	209	—	88	99	130	105	34	134	136	150	77	156
<i>m</i> -Chloroaniline	230	—	79	122	121	138	—	177	172	184	58	124
<i>p</i> -Chloroaniline	232	71	179	193	122	95	62	178	199	167	102	152
<i>o</i> -Bromoaniline	229	32	99	116	—	90	—	129	—	161	—	146
<i>m</i> -Bromoaniline	251	18	88	120	—	—	—	180	187	—	—	143
<i>p</i> -Bromoaniline	—	66	167	204	134	101	67	180	202	158	—	148
<i>o</i> -Iodoaniline	—	60	110	139	—	—	—	112	—	—	—	—
<i>m</i> -Iodoaniline	—	25	119	151	—	128	—	—	—	—	—	—
<i>p</i> -Iodoaniline	—	63	184	222	—	—	86	—	—	—	109	153
<i>o</i> -Anisidine (6)	225	5	88	60	89	127	—	200	185	151	83	136
<i>m</i> -Anisidine	251	—	80	—	—	68	—	169	158	138	57	—
<i>p</i> -Anisidine	246	57	130	154	96	114	62	—	197	141	81	144
<i>o</i> -Phenetidine (7)	228	—	79	104	102	164	—	—	164	164	62	137
<i>m</i> -Phenetidine	248	—	96	103	—	157	—	158	—	—	52	138
<i>p</i> -Phenetidine	254	—	135	173	143	107	76	69	173	118	76	148

TABLE IV, 100A.

PRIMARY AROMATIC AMINES (continued)

Amine	B.P.	M.P.	Acetamide	Benzamide	Benzene-sulphonamide	<i>p</i> -Toluenesulphonamide	Benzal Derivative	Picrate	3-Nitro-phthalimide	2:4-Dinitrophenyl Derivative	Formyl Derivative	Phenylthiourea
3-Bromo-4-aminotoluene	240°	26°	117°	149°	—	—	—	—	—	—	—	—
5-Bromo-2-aminotoluene	240	59	157	115	—	—	—	—	—	—	—	—
3-Nitro-4-aminotoluene	—	117	96	148	103°	146°	78°	—	—	—	—	—
4-Nitro-2-aminotoluene	—	107	151	186	172	—	116	—	—	—	179°	—
5-Nitro-2-aminotoluene	—	129	202	174	159	174	—	—	—	—	—	—
1-Nitro-2-naphthylamine	—	126	123	168	156	160	—	—	—	—	—	—
5-Nitro-1-naphthylamine	—	119	220	—	183	—	—	—	—	—	199	—
<i>o</i> -Aminodiphenyl	299	50	121	102	—	—	—	—	—	—	75	—
<i>p</i> -Aminodiphenyl (8)	302	51	171	230	—	255	—	—	—	—	172	—
2:4-Dichloroaniline	245	63	146	117	128	—	—	106°	—	116°	—	—
2:5-Dichloroaniline	251	50	132	120	—	—	—	—	—	—	—	166°
2:4-Dibromoaniline	—	79	146	134	—	—	—	124	—	—	146	171
2:4:6-Trichloroaniline	—	78	206	174	—	—	—	83	—	—	180	—
2:4:6-Tribromoaniline	—	120	—	232	198	—	95	—	—	—	222	—
<i>o</i> -Nitroaniline	—	71	94	98	104	110	—	73	171°	—	122	—
<i>m</i> -Nitroaniline	—	114	155	157	136	139	73	143	219	—	134	160
<i>p</i> -Nitroaniline	—	148	216	199	139	191	115	100	255	—	194	—
2:4-Dinitroaniline	—	180	121	220	—	219	—	—	—	—	—	—
2:6-Dinitroaniline	—	138	197	—	—	—	—	—	—	—	—	—
<i>o</i> -Phenylenediamine	257	102	186	301	186	202	106	208	—	—	170	—
<i>m</i> -Phenylenediamine	283	64	191	240	194	172	105	184	—	172	155	—
<i>p</i> -Phenylenediamine	267	141	304	>300	247	266	140	—	—	177	206	—
2:4-Diaminotoluene (9)	292	99	224	224	191	192	175	—	—	184	177	—
2:5-Diaminotoluene	273	64	220	307	—	—	—	—	—	—	—	—
Anthranilic acid	—	146	185	181	214	217	127	—	—	—	168	—
<i>m</i> -Aminobenzoic acid	—	174	250	—	—	—	119	—	—	—	225	—
<i>p</i> -Aminobenzoic acid	—	187	251	278	212	—	193	—	—	—	268	—
Benzidine	—	126	317	352	235	243	238	—	—	—	—	—
<i>o</i> -Tolidine (10)	—	129	314	265	—	—	152	185	—	—	254	—

TABLE IV,100A.

PRIMARY AROMATIC AMINES (continued)

Amine	B.P.	M.P.	Acetamide	Benzamide	Benzene-sulphonamide	<i>p</i> -Toluenesulphonamide	Benzal Derivative	Picrate	3-Nitrophthalimide	2:4-Dinitrophenyl Derivative	Formyl Derivative	Phenylthiourea
<i>p</i> -Aminodimethylaniline .	262°	41°	132°	228°	—	—	98°	188°	—	168°	108°	—
<i>p</i> -Aminodiethylaniline .	261	—	104	172	—	—	—	—	—	—	—	—
<i>p</i> -Aminoazobenzene .	—	126	145	211	—	—	130	—	—	—	162	—
Methyl anthranilate .	255	24	101	100	—	—	—	106	—	—	58	—
Ethyl anthranilate .	266	13	61	98	93°	112°	—	—	—	—	57	—
Ethyl <i>p</i> -aminobenzoate (11)	—	92	110	148	—	—	—	131	—	—	—	—
<i>m</i> -Aminoacetanilide .	—	88	191	—	—	241	—	—	—	—	—	—
<i>p</i> -Aminoacetanilide .	—	163	304	—	—	—	—	—	—	—	—	—
<i>o</i> -Aminophenol .	—	174	124 (di)	184 (di)	141	139	89	—	—	199	129	146°
<i>m</i> -Aminophenol .	—	123	101 (di)	153 (di)	—	—	—	—	—	—	—	156
<i>p</i> -Aminophenol .	—	186	150 (di)	234 (di)	125	253	182	—	—	190	140	150
Picramic acid (12) .	—	168	201 (N)	229 (N)	—	191 (N)	—	—	—	—	—	—
Phenylhydrazine .	242	23	128	168	—	—	—	—	—	—	145	172
<i>p</i> -Nitrophenylhydrazine .	—	157d	205	193	—	—	—	120	—	—	—	—
2:4-Dinitrophenylhydrazine	—	198d	198	207	—	—	—	—	—	—	—	—
Sulphanilamide .	—	166	219	284	211	—	—	—	—	—	—	—

(1) 2-*m*-Xylidine or 2:6-dimethylaniline.(2) 4-*m*-Xylidine or 2:4-dimethylaniline.(3) 5-*m*-Xylidine or 3:5-dimethylaniline.(4) 2-Amino-*p*-xylene or 2:5-dimethylaniline.

(5) 2:4:6-Trimethylaniline.

(6) *o*-Methoxyaniline.(7) *o*-Ethoxyaniline.(8) *p*-Xenylamine.(9) *m*-Tolylenediamine.

(10) 4:4'-Diamino-3:3'-dimethyldiphenyl.

(11) Benzocaine.

(12) 4:6-Dinitro-2-aminophenol.

TABLE IV, 100B.

SECONDARY AROMATIC AMINES

Amine	B.P.	M.P.	Acetamide	Benzamide	Benzene-sulphonamide	<i>p</i> -Toluenesulphonamide	Picrate	Formyl Derivative	Other Derivatives
Methylaniline	194°	—	103°	63°	79°	95°	145°	—	Phthalamic acid, 194°
Ethylaniline	205	—	55	60	—	88	138	—	Phthalamic acid, 204
<i>n</i> -Propylaniline	222	—	47	—	54	—	—	—	Phthalamic acid, 225
<i>n</i> -Butylaniline	240	—	—	56	—	56	—	—	Phthalamic acid, 204
Benzylaniline	306	38°	58	107	119	140	—	48°	<i>N</i> -Nitroso, 58
<i>N</i> -Methylbenzylamine	181	—	—	—	—	95	—	—	—
<i>N</i> -Ethylbenzylamine	199	—	—	—	—	50	118	—	Urea (with PhNCO), 81
<i>N</i> -Methyl <i>o</i> -toluidine	208	—	56	66	—	120	90	—	—
<i>N</i> -Methyl <i>m</i> -toluidine	206	—	66	—	—	—	—	—	—
<i>N</i> -Methyl <i>p</i> -toluidine	210	—	83	53	—	60	131	—	<i>N</i> -Nitroso, 52
<i>N</i> -Ethyl <i>o</i> -toluidine	214	—	—	72	—	75	—	—	—
<i>N</i> -Ethyl <i>m</i> -toluidine	221	—	—	72	—	—	—	—	—
<i>N</i> -Ethyl <i>p</i> -toluidine	217	—	—	39	—	71	—	—	—
<i>N</i> -Methyl α -naphthylamine	294	—	94	—	—	164	—	—	—
<i>N</i> -Methyl β -naphthylamine	317	—	51	84	—	78	145	—	<i>N</i> -Nitroso, 88
<i>N</i> -Phenyl- α -naphthylamine	335	62	115	152	—	—	—	—	—
<i>N</i> -Phenyl- β -naphthylamine	—	108	93	136	—	—	—	—	—
<i>o</i> -Nitromethylaniline	—	37	70	—	—	—	—	—	<i>N</i> -Nitroso, 36
<i>m</i> -Nitromethylaniline	—	68	95	155	83	—	—	—	<i>N</i> -Nitroso, 76
<i>p</i> -Nitromethylaniline	—	152	152	111	120	—	—	119	<i>N</i> -Nitroso, 104
<i>m</i> -Nitroethylaniline	—	60	89	—	—	—	—	—	—
<i>p</i> -Nitroethylaniline	—	96	119	—	—	—	—	—	<i>N</i> -Nitroso, 120
Diphenylamine	302	54	103	180	123	142	182	74	<i>N</i> -Nitroso, 67
Dibenzylamine	300d	—	—	112	68	—	—	52	—
Pyrrolidine	89	—	—	—	—	123	—	—	—
Piperidine	106	—	—	48	94	96	152	—	—
2-Methylpiperidine	117	—	—	45	—	55	134	—	—
3-Methylpiperidine	125	—	—	—	—	—	137	—	—
Tetrahydroquinoline	250	20	—	76	67	—	—	—	—
Tetrahydro- <i>iso</i> -quinoline	232	—	46	129	154	—	195	—	—
Indole	254	52	—	68	—	—	187	52	<i>N</i> -Nitroso, 171
Carbazole	355	246	69	98	—	137	185	—	—
Piperazine	140	104	—	196	282	—	280	—	<i>N,N</i> -Dinitroso, 158

CRYSTALLINE DERIVATIVES OF TERTIARY AROMATIC AMINES

1'. **Picrates.** Experimental details are given under *Aliphatic Amines*, Section III, 123, 3.

2'. **Methiodides.** Methyl iodide reacts with tertiary amines to form the crystalline quaternary ammonium iodide (methiodide) :

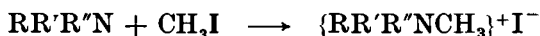

Allow a mixture of 0.5 g. of the tertiary amine and 0.5 ml. of colourless methyl iodide * to stand for 5 minutes. If reaction has not occurred, warm under reflux for 5 minutes on a water bath and then cool in ice water. The mixture will generally set solid : if it does not, "scratch" the sides of the tube with a glass rod. Recrystallise the solid product from absolute alcohol, ethyl acetate, acetone, glacial acetic acid or alcohol-ether.

Alternatively, dissolve 0.5 g. of the tertiary amine and 0.5 ml. of methyl iodide in 5 ml. of dry ether or benzene, and allow the mixture to stand for several hours. The methiodide precipitates, usually in a fairly pure state. Filter, wash with a little of the solvent, and recrystallise as above.

The ethiodide is prepared similarly, using ethyl iodide.

3'. **Metho-*p*-toluenesulphonate.** Methyl *p*-toluenesulphonate combines with many tertiary amines to yield crystalline derivatives :

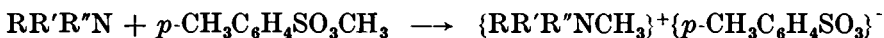

Dissolve 2-3 g. of methyl *p*-toluenesulphonate in 10 ml. of dry benzene, add 1 g. of the amine, and boil the mixture for 20-30 minutes. Cool, and filter the precipitated quaternary salt. Recrystallise by dissolving the solid in the minimum volume of boiling ethyl alcohol and then adding ethyl acetate until crystallisation commences. Filter the cold mixture, dry rapidly on a porous plate, and determine the m.p. immediately.

The benzyl chloride quaternary salts $\{RR'R''NC_6H_5CH_2\}^+Cl^-$ are prepared similarly; 3 g. of redistilled benzyl chloride replaces the methyl *p*-toluenesulphonate.

4'. ***p*-Nitroso Derivatives.** Aromatic tertiary amines, such as dimethylaniline, react with nitrous acid to yield crystalline *p*-nitroso compounds. For further details, see (vii) above.

The melting points of the derivatives of a number of tertiary amines, both aliphatic and aromatic, are collected in Table IV, 100C.

* Keep a coil of copper wire (prepared by winding copper wire round a glass tube) or a little silver powder in the bottle, which should be of brown or amber glass; the methyl iodide will remain colourless indefinitely. Ethyl iodide may sometimes give more satisfactory results.

TABLE IV.100C.

TERTIARY AMINES

Amine	B.P.	M.P.	Methiodide	Picrate	Methyl <i>p</i> -toluene- sulphonate	Other Derivatives
Trimethylamine	3°	—	230°	216°	—	—
Triethylamine	89	—	—	173	—	$d_{4}^{20^{\circ}}$ 0.728; $n_D^{20^{\circ}}$ 1.401
Tri- <i>n</i> -propylamine	156	—	208	117	—	Ethiodide, 238°; $d_{4}^{20^{\circ}}$ 0.756, $n_D^{20^{\circ}}$ 1.417
Tri- <i>n</i> -butylamine	212	—	180	106	—	Benzyl chloride, 185; $d_{4}^{20^{\circ}}$ 0.778, $n_D^{20^{\circ}}$ 1.430
Tri- <i>n</i> -amylamine	257	—	—	—	80°d	$d_{4}^{20^{\circ}}$ 0.791; $n_D^{20^{\circ}}$ 1.437
Tri- <i>iso</i> -amylamine	245	—	—	125	—	$d_{4}^{20^{\circ}}$ 0.785; $n_D^{20^{\circ}}$ 1.433
Dimethylaniline	193	—	228	164	161	<i>p</i> -Nitroso, 87; ethiodide, 136
Diethylaniline	215	—	102	142	—	<i>p</i> -Nitroso, 84; benzyl chloride, 104
Di- <i>n</i> -propylaniline	245	—	156	—	—	—
Di- <i>n</i> -butylaniline	271	—	—	125	180	—
Methylethylaniline	201	—	125	134	—	Ethiodide, 102; <i>p</i> -Nitroso, 66
Benzylmethylaniline	306	—	164	127	—	—
Benzylethylaniline	186°/22	—	161	121	—	—
Dibenzylaniline	300	70°	135	132	—	<i>p</i> -Nitroso, 91
Dimethyl- <i>o</i> -toluidine	185	—	210	122	—	—
Dimethyl- <i>m</i> -toluidine	212	—	177	131	—	—
Dimethyl- <i>p</i> -toluidine	211	—	220	130	85	Benzylchloride, 171
Diethyl- <i>o</i> -toluidine	210	—	224	180	—	—
Diethyl- <i>m</i> -toluidine	231	—	—	97	—	—
Diethyl- <i>p</i> -toluidine	229	—	184	110	—	—
Dimethyl- α -naphthylamine	273	—	—	145	—	—
Dimethyl- β -naphthylamine	305	47	—	206	—	—
<i>p</i> -Nitrosodimethylaniline	—	87	—	140	—	—
<i>p</i> -Nitrodimethylaniline	—	163	—	—	—	—

TABLE IV, 100C.

TERTIARY AMINES (continued)

Amine	B.P.	M.P.	Methiodide	Picrate	Methyl <i>p</i> -toluene- sulphonate	Other Derivatives
<i>p</i> -Bromodimethylaniline	264°	55°	—	—	—	—
<i>p</i> -Hydroxydimethylaniline	—	76	201°	—	—	<i>o</i> -Acetyl, 79°
Triphenylamine	365	127	—	—	—	—
Tribenzylamine	380	92	134	190°	—	Ethiodide, 190
Pyridine	115	—	118	167	139°	Ethiodide, 90
α -Picoline (1)	129	—	227	169	150	Ethiodide, 123 ; picolinic acid, 136
β -Picoline	144	—	92	150	—	Nicotinic acid, 228
γ -Picoline	143	—	152	167	—	<i>iso</i> -Nicotinic acid, 308
2 : 4-Lutidine (2)	157	—	113	183	—	—
2 : 6-Lutidine	142	—	238	163	—	Dipicolinic acid, 226
2 : 4 : 6-Trimethylpyridine (3)	172	—	—	156	—	—
2-Chloropyridine	170	—	—	—	120	—
3-Chloropyridine	149	—	—	135	—	—
2-Bromopyridine	194	—	—	—	127	—
3-Bromopyridine	170	—	165	—	156	—
2 : 6-Dibromopyridine	249	119	—	—	—	—
3 : 5-Dibromopyridine	222	112	274	—	219	—
Quinoline	238	—	72* (133) †	203	126	Ethiodide, 158
<i>iso</i> -Quinoline	242	24	159	223	163	Ethiodide, 148
Quinaldine (4)	247	—	195	195	161	Ethiodide, 234
Lepidine (5)	262	—	174	211	—	—
6-Methylquinoline	258	—	219	229	154	Benzyl chloride, 239
7-Methylquinoline	252	39	—	237	—	—
8-Methylquinoline	248	—	—	200	—	—
6-Hydroxyquinoline	—	193	—	236	—	—
8-Hydroxyquinoline	267	76	143	204	—	—
6-Methoxyquinoline	284	26	236	—	—	—
8-Methoxyquinoline	283	50	160	143	—	—

* Hydrated (1H₂O).

† Anhydrous.

TABLE IV, 100C.

TERTIARY AMINES (continued)

Amine	B.P.	M.P.	Methiodide	Picrate	Methyl <i>p</i> -toluene- sulphonate	Other Derivatives
2-Chloroquinoline . . .	267°	38°	—	122°	—	—
6-Chloroquinoline . . .	262	41	248°	—	143°	Ethiodide, 169°
2-Bromoquinoline . . .	—	49	210	—	—	—
6-Bromoquinoline . . .	278	19	278	217	—	—
6-Nitroquinoline . . .	—	154	245	—	—	—
8-Nitroquinoline . . .	—	92	—	—	—	—
2 : 4-Dimethylquinoline . . .	264	—	264	194	—	Ethiodide, 214
2 : 6-Dimethylquinoline . . .	267	60	237	191	175	Ethiodide, 227
$\alpha\alpha'$ -Dipyridyl . . .	273	70	—	158	—	—
Nicotine . . .	246	—	—	218	—	Nicotinic acid, 228
Methyl nicotinate . . .	204	38	—	—	—	—
Ethyl nicotinate . . .	223	—	—	—	—	—
Acridine . . .	—	111	224	208	—	Trinitrobenzene, 115
Hexamethylenetetramine . . .	—	Sub.	190	179	205	—

(1) 2-Methylpyridine.

(2) 2 : 4-Dimethylpyridine.

(3) γ -Collidine.

(4) 2-Methylquinoline.

(5) 4-Methylquinoline.

PHENOLS

Phenols may be prepared in the laboratory :—

1. By hydrolysis of a diazonium salt, for example :

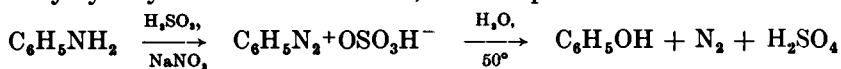

(see Section IV,69).

2. By alkali fusion of a sulphonate, for example :

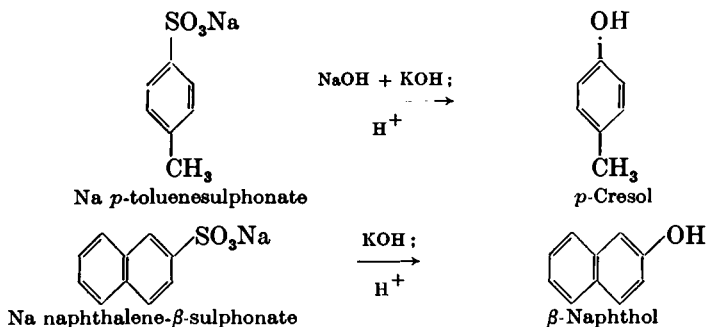

3. By the rearrangement of an ester of a phenol in the presence of aluminium chloride (Fries reaction), phenolic ketones are produced :

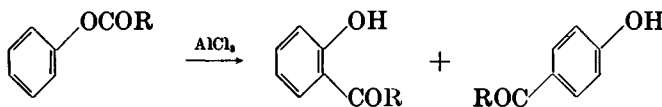

The ester and catalyst are usually employed in equimolecular amounts. With $\text{R} = \text{C}_2\text{H}_5$ (phenyl propionate), the products are *o*- and *p*-propiophenol; with $\text{R} = \text{CH}_3$ (phenyl acetate), *o*- and *p*-hydroxyacetophenone are formed. The nature of the product is influenced by the structure of the ester, by the temperature, the solvent and the amount of aluminium chloride used : generally, low reaction temperatures favour the formation of *p*-hydroxy ketones. It is usually possible to separate the two hydroxy ketones by fractional distillation under diminished pressure through an efficient fractionating column or by steam distillation ; the *ortho* compounds, being chelated, are more volatile in steam. It may be mentioned that Clemmensen reduction (compare Section IV,6) of the hydroxy ketones affords an excellent route to the substituted phenols.

2 : 5-Dihydroxyacetophenone (II) can be prepared in good yield by heating hydroquinone diacetate (I) in the presence of 3.3 mols of aluminium chloride. Hydroquinone cannot be acylated by the Friedel-Crafts method.

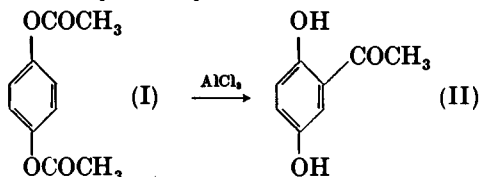

The *mechanism* of the Fries reaction is not known with certainty. One mechanism regards it as a true intramolecular rearrangement in which the acyl group migrates directly from the oxygen atom to the carbon atoms of the ring. Another scheme postulates that the ester is cleaved by the reagent

2 : 4-Dinitrophenol may be readily prepared by taking advantage of the great reactivity of the chlorine atom in 2 : 4-dinitro-1-chlorobenzene :

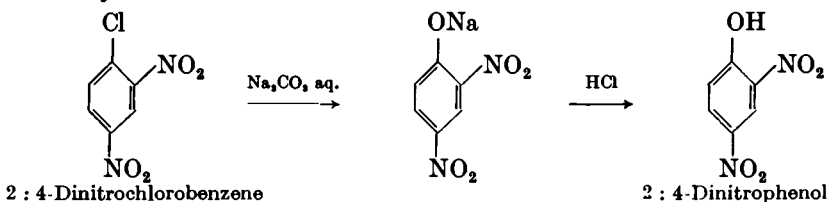

Picric acid, the 2 : 4 : 6-trinitro derivative of phenol, cannot be prepared in good yield by the action of nitric acid upon phenol since much of the latter is destroyed by oxidation and resinous products are also formed. It is more convenient to heat the phenol with concentrated sulphuric acid whereby a mixture of *o*- and *p*-phenolsulphonic acids is obtained ; upon treatment of the mixture with concentrated nitric acid, nitration occurs at the two positions *meta* to the $-SO_3H$ group in each compound, and finally, since sulphonation is reversible, the acid groups are replaced by a third nitro group yielding picric acid in both cases :

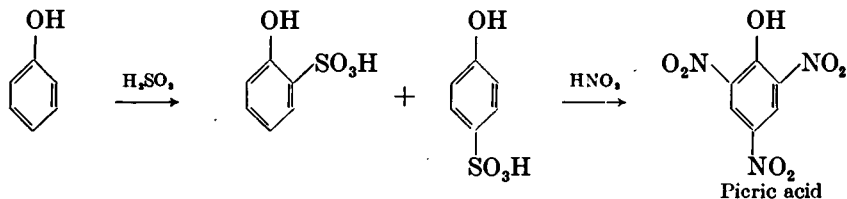

The mono-bromination of phenol at low temperatures in carbon disulphide or carbon tetrachloride solution results in almost exclusive *para* substitution :

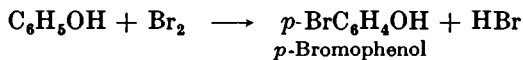

***o*-Bromophenol** is conveniently prepared by first sulphonating with excess of concentrated sulphuric acid to yield phenol-2 : 4-disulphonic acid, neutralising with sodium hydroxide, heating the solution of the sodium salt with 1 mol of bromine, and then eliminating the sulphonate groups with dilute sulphuric acid at 200° :

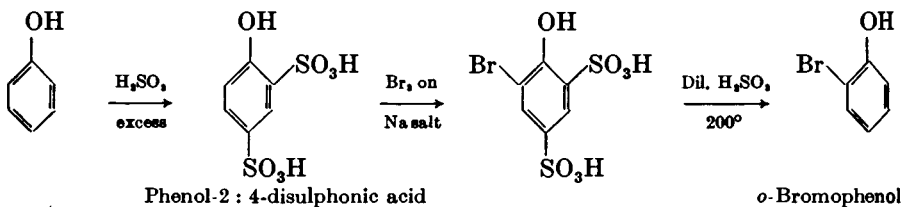

***p*-Iodophenol** is readily obtained by diazotising *p*-aminophenol, and adding potassium iodide solution and a little copper bronze :

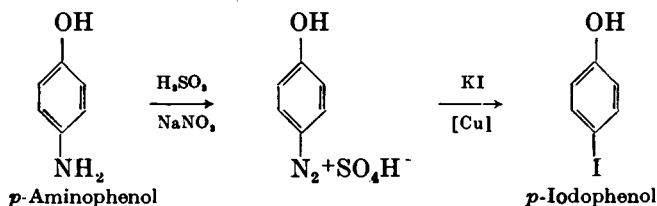

IV,101.

p-CRESOL

Support a 250 ml. nickel or copper (better silver-plated copper) or iron crucible or beaker in a large circular hole in a sheet of asbestos board or uralite resting upon a tripod, and place in it 100 g. of sodium hydroxide pellets or sticks and 40 g. of potassium hydroxide pellets or sticks (1). Prepare a case of nickel or copper to surround the thermometer for about two-thirds of its length; this may be done either by cutting a suitable length of nickel or copper tube already closed at one end, or by hammering down the end of an open tube and folding over the flat part in a vice. Fit a large cork at the top of the tube; this will serve for handling the tube containing the thermometer when used for stirring the fused alkali. Since some spattering of the molten alkali cannot generally be avoided, the student should wear gloves, a well-fitting laboratory coat and, if possible, goggles (2). Heat the crucible, with stirring, until the alkali melts; then allow the temperature to fall to 230°, and stir in 15 g. of sodium *p*-toluenesulphonate (Section IV,30). Raise the temperature slowly so that it is about 270° in about 30 minutes. During this period add slowly 45 g. of sodium *p*-toluenesulphonate; it is best to make the additions whenever the melt becomes sufficiently thin to stir in the solid. Now raise the temperature to about 300° with occasional stirring: at this point there is a layer of froth on the surface of the melt. Stir the froth in, whilst raising the temperature slowly. At about 330°, the foaming (which has previously been considerable) suddenly disappears, the melt becomes dark and hydrogen is evolved. The mixture is now thin and of uniform consistency: do not allow it to solidify, but pour it at once into a shallow iron tray, and allow to cool.

Dissolve the solid in 700 ml. of water in a 1500 ml. round-bottomed flask, and add a solution of 88 ml. of concentrated sulphuric acid in about 200 ml. of water until the liquid has a distinct odour of sulphur dioxide; sufficient heat will be liberated in the neutralisation to cause the solution to boil. Immediately steam distil the liquid (Fig. II, 40, 1; it is better to use the apparatus shown in Fig. II, 41, 3) until a sample of the distillate gives only a slight precipitate with bromine water. About 700 ml. of distillate should be collected. Saturate the steam distillate with salt, extract the oil with ether, dry the extract with a little anhydrous magnesium or calcium sulphate, distil off the ether (compare Fig. II, 13, 4, but with a 50 ml. Claisen flask replacing the distilling flask) and distil the residue under diminished pressure. Collect the *p*-cresol at 95–96°/15 mm.; the colourless liquid solidifies to a white crystalline solid, m.p. 31°. The yield is 24 g.

Notes.

(1) No cresol is obtained if sodium hydroxide alone is used, presumably because the fused sodium hydroxide has no solvent action upon the sodium *p*-toluenesulphonate. Potassium hydroxide alone gives excellent results, as do also mixtures of sodium and potassium hydroxide containing not less than 28 per cent. of potassium hydroxide. The experimental details utilise the minimum amount of potassium hydroxide for the sake of economy.

(2) It is recommended that the preparation be conducted in the fume cupboard (hood) with the window protecting the face.

IV,102.

 β -NAPHTHOL

The apparatus required is similar to that detailed under *p-Cresol* (preceding Section). Place 120 g. of potassium hydroxide sticks or pellets (1) together with 5 ml. of water in the 250 ml. nickel crucible, and heat until it melts. When the temperature reaches about 250°, remove the flame, and quickly add with stirring 50 g. of finely-powdered sodium naphthalene- β -sulphonate (Section IV,31). Replace the flame, stir the stiff pasty mass, and continue the heating so that the temperature rises to 300° in 5-10 minutes. Stir the mixture continuously; there is some frothing at first and at about 300° the mass suddenly becomes a clear, mobile, brown oil of the potassium salt of β -naphthol floating on a pasty mass of alkali. Raise the temperature during 5 minutes to 310°, remove the flame, push down the material from the side of the crucible, and reheat to 310° for about 2 minutes, and then allow the melt to cool. Do not permit the melt to solidify completely. When it becomes pasty, ladle it out in small portions (with a nickel spatula, "spoon" end) into a 1 litre beaker half-filled with crushed ice. Extract the residual material in the crucible with water and add it to the contents of the beaker. Precipitate the β -naphthol by adding concentrated hydrochloric acid slowly and with stirring. (*FUME CUPBOARD*; SO₂); if the β -naphthol separates in a finely-divided form, warm until the particles coagulate. Cool in ice, filter at the pump, make a hole in the filter paper and wash the precipitate into a beaker containing cold water. Add just sufficient 5 per cent. sodium hydroxide solution to dissolve the solid and also 1 g. of sodium hyposulphite Na₂S₂O₄ (to prevent oxidation), and filter from traces of insoluble matter. Precipitate the β -naphthol with acetic acid, warm to produce a more readily filterable form of the precipitate, cool in ice, and filter the product. Dry in the air upon filter paper. The yield is 25 g., m.p. 122°. If the m.p. is unsatisfactory, recrystallise from water, dilute alcohol or carbon tetrachloride.

Note.

(1) Sodium hydroxide may replace potassium hydroxide in this preparation; 150 g., together with 15 ml. of water, are required. The sulphonate is stirred in when the temperature reaches 280° and the reaction is completed at 310-320°.

Conversion of β -naphthol into di- β -naphthol. β -Naphthol is oxidised by aqueous ferric chloride solution into di- β -naphthol or 2 : 2'-dihydroxydinaphthyl :

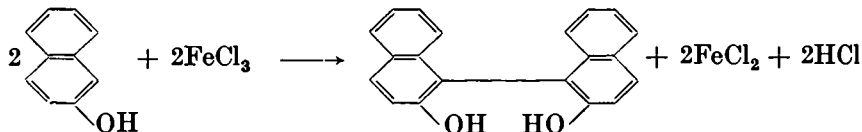

In a 1 litre three-necked flask, provided with a dropping funnel, glycerine-sealed stirrer and reflux condenser, place 14.4 g. of β -naphthol and 600 ml. of water, and heat to the boiling point. To the boiling liquid containing liquid β -naphthol in suspension, add slowly through the dropping funnel and with vigorous stirring a solution of 28 g. of crystal-

lised ferric chloride in 60 ml. of water. The oily drops of β -naphthol will disappear and the di- β -naphthol separates out in flakes. Boil for 5–10 minutes, filter the hot suspension at the pump through a previously-warmed Buchner funnel, wash with boiling water, and dry in the air upon filter paper. The crude product weighs 18 g. Recrystallise from toluene or benzene (about 150 ml.); almost colourless crystals (15 g.), m.p. 218°, are obtained.

IV,103.

PHENYL ACETATE

Dissolve 23.5 g. of phenol in 160 ml. of 10 per cent. sodium hydroxide solution contained in a 500 ml. reagent bottle, and add about 175 g. of crushed ice. Then add 32.5 g. (30 ml.) of acetic anhydride, cork the bottle and shake the contents vigorously for about 5 minutes. The reaction is then complete and an emulsion of phenyl acetate is produced. Pour the mixture into a separatory funnel, add about 10 ml. of carbon tetrachloride to facilitate the separation of the two layers, shake, and allow to stand. Run off the lower solution of phenyl acetate in carbon tetrachloride, and shake this with very dilute sodium carbonate solution or saturated sodium bicarbonate solution until effervescence ceases; release the pressure in the funnel from time to time. Run off the lower layer into a small conical flask, dry over anhydrous magnesium sulphate or calcium chloride, and filter through a small fluted filter paper into a 50 ml. distilling flask. Distil (Fig. II, 13, 2) by *slowly* heating in an air bath (Fig. II, 5, 3) or over an asbestos-centred wire gauze. The boiling point rises slowly to about 170° before all the carbon tetrachloride is removed and then rises rapidly to about 194°. Collect the phenyl acetate (a colourless liquid) at 194–197°. The yield is 42 g.

COGNATE PREPARATION

β -Naphthyl acetate. Dissolve 5.0 g. of β -naphthol in 25 ml. of 10 per cent. sodium hydroxide solution in a 250 ml. reagent bottle, add 60 g. of crushed ice, and 5.7 g. (5.5 ml.) of acetic anhydride. Shake vigorously for 10–15 minutes: the β -naphthyl acetate separates as colourless crystals. Filter with suction, wash with water, drain and dry in the air. Recrystallise from light petroleum (b.p. 60–80°) or from dilute alcohol. The yield of pure product, m.p. 71°, is 6.5 g.

IV,104.

ANISOLE

Equip a 500 ml. three-necked flask with a separatory funnel, a mercury-sealed mechanical stirrer and a reflux condenser. Place a solution of 21 g. of sodium hydroxide in 200 ml. of water and also 47 g. of pure phenol in the flask, and stir the mixture; cool the warm mixture to about 10° by immersing the flask in an ice bath. Place 63 g. (47 ml.) of dimethyl sulphate in the separatory funnel.

CAUTION. Both the vapour and the liquid dimethyl sulphate are highly poisonous. Inhalation of the vapour may lead to giddiness and even to more serious results. The cold liquid is easily absorbed through the skin, with toxic results. If the dimethyl sulphate is accidentally splashed upon the hands, wash immediately

with much concentrated ammonia solution in order to hydrolyse the compound before it can be absorbed through the skin; then rub gently with a wad of cotton wool soaked in ammonia solution. All experiments involving dimethyl sulphate must therefore be carried out in the fume cupboard and under the supervision of the instructor.

Add the dimethyl sulphate dropwise during 1 hour whilst stirring the mixture vigorously. Then reflux for 2 hours, with stirring, in order to complete the methylation. Allow to cool, add water, transfer to a separatory funnel, remove the lower layer, and wash once with water, twice with dilute sulphuric acid, and then with water until the washings are neutral to litmus. Add some sodium chloride to each washing as this will facilitate the separation of the two layers ($d_4^{20^\circ}$ for anisole is 0.996). Dry over anhydrous calcium chloride or magnesium sulphate, and distil from an air bath. Collect the anisole at 151–154°. The yield is 40 g.

COGNATE PREPARATIONS

β -Naphthyl methyl ether (nerolin). Use 36.0 g. of β -naphthol, 10.5 g. of sodium hydroxide in 150 ml. of water, and add 31.5 g. (23.5 ml.) of dimethyl sulphate whilst the mixture is cooled in ice. Warm for 1 hour at 70–80°, and allow to cool. Filter off the naphthyl methyl ether at the pump, wash with 10 per cent. sodium hydroxide solution, then liberally with water, and drain thoroughly. Recrystallise from benzene or methylated spirit. The yield is 33 g., m.p. 72°.

Phenetole. Proceed as for *Anisole* using the following quantities: 21 g. of sodium hydroxide in 200 ml. of water, 47 g. of pure phenol, and 77 g. (65.5 ml.) of diethyl sulphate (1).

CAUTION. Diethyl sulphate is poisonous, but to a less degree than dimethyl sulphate. Similar precautions should, however, be taken (see above).

After all the diethyl sulphate has been introduced, reflux the mixture gently for 2 hours with stirring. Transfer the diluted reaction mixture to a separatory funnel, run off the lower aqueous layer, wash successively with water, dilute sulphuric acid (twice), and with water until the washings are neutral to litmus. Dry over anhydrous calcium chloride or magnesium sulphate, and distil. Collect the phenyl ethyl ether (a colourless liquid) at 168–170°. The yield is 50 g.

Note.

(1) If the diethyl sulphate is dark in colour, it should be washed in the fume cupboard with ice water, then with sodium bicarbonate solution until all free acid is removed, and distilled under reduced pressure.

***o*-n-Butoxynitrobenzene.** Place a mixture of 28 g. of *o*-nitrophenol (Section IV, 108), 28 g. of anhydrous potassium carbonate, 30 g. (23.5 ml.) of *n*-butyl bromide and 200 ml. of dry acetone in a 1-litre round-bottomed flask fitted with an efficient reflux condenser, and reflux on a steam bath for 48 hours. Distil off the acetone, add 200 ml. of water, and extract the product with two 100 ml. portions of benzene. Wash the combined benzene extracts with three 90 ml. portions of 10 per cent. sodium hydroxide solution, remove the benzene by distillation at atmospheric pressure, and distil the residue under reduced pressure. Collect the *o*-n-butoxynitrobenzene at 171–172°/19 mm. (or at 127–129°/2 mm.); the yield is 30 g.

IV,105. PHENYL *n*-BUTYL ETHER

Weigh out 11.5 g. of sodium (for experimental details, see Section III,7, *Note* 1) into a dry 1-litre round-bottomed flask, provided with a 25 cm. double surface condenser, and add 250 ml. of absolute ethyl alcohol. If the reaction becomes so vigorous that the alcohol cannot be held back by the condenser, direct a stream of cold water or place a wet towel on the outside of the flask until it is again under control: do not cool the alcohol unduly otherwise the last traces of sodium will take a considerable time to dissolve. Add a solution of 47 g. of pure phenol in 50 ml. of absolute alcohol and shake. Into a small separatory funnel, supported by a grooved cork in the top of the condenser, place 133 g. (82.5 ml.) of *n*-butyl iodide (Section III,40) or an equivalent quantity of *n*-butyl bromide (Sections III,35 and III,37) and add it, with shaking, during 15 minutes. Boil the solution gently for 3 hours. Fit a still-head ("knee tube") to the flask (Fig. II, 13, 3) and distil off as much as possible of the alcohol on a water bath; this process is facilitated by wrapping the exposed part of the flask in a cloth. Add water to the residue in the flask, separate the organic layer and wash it twice with 25 ml. portions of 10 per cent. sodium hydroxide solution, then successively with water, dilute sulphuric acid and water: dry with anhydrous magnesium sulphate. Distil and collect the phenyl *n*-butyl ether at 207-208°. The yield is 60 g.

IV,106. REACTIONS AND CHARACTERISATION OF AROMATIC ETHERS

Purely aromatic ethers (*e.g.*, diphenyl ether), which are commonly encountered, are very limited in number. Most of the aromatic ethers are of the mixed aliphatic-aromatic type. They are not attacked by sodium nor by dilute acids or alkalis. When liquid, the physical properties (b.p., d_4^{20} and n_D^{20}) are useful constants to assist in their identification. Three important procedures are available for the characterisation of aromatic ethers.

1. **Cleavage with hydriodic acid.** Aromatic ethers undergo fission when heated with constant boiling point hydriodic acid:

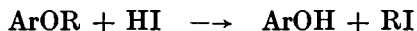

The cleavage products are a phenol and an alkyl iodide, which will serve to characterise the ether.

Experimental details can easily be adapted from those given under *Aliphatic Ethers*, Section III,60, 2.

2. **Sulphonamides of aryl ethers.** Aromatic ethers react smoothly in chloroform solution with chlorosulphonic acid at 0° to give sulphonyl chlorides, for example:

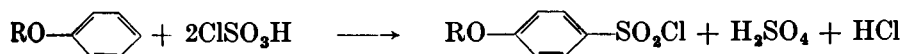

The sulphonyl chlorides are treated with concentrated ammonia solution to produce sulphonamides, which usually possess sharp melting points and are therefore useful as derivatives, for example :

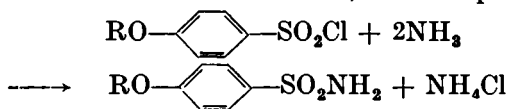

Dissolve 1.0 g. of the compound in 5 ml. of dry chloroform in a dry test-tube, cool to 0°, and add dropwise 5 g. (2.8 ml.) of redistilled chlorosulphonic acid. When the evolution of hydrogen chloride subsides, allow the reaction mixture to stand at room temperature for 20 minutes. Pour the contents of the test-tube cautiously on to 25 g. of crushed ice contained in a small beaker. Separate the chloroform layer and wash it with a little cold water. Add the chloroform layer, with stirring, to 10 ml. of concentrated ammonia solution. After 10 minutes, evaporate the chloroform on a water bath, cool the residue and treat it with 5 ml. of 10 per cent. sodium hydroxide solution; the sulphonamide dissolves as the sodium derivative, $\text{RO.C}_6\text{H}_4.\text{SO}_2\text{NHNa}$. Filter the solution to remove any insoluble matter (sulphone, etc.), acidify the filtrate with dilute hydrochloric acid, and cool in ice water. Collect the sulphonamide and recrystallise it from dilute alcohol.

3. Picrates of aromatic ethers. Most phenolic ethers react with picric acid in chloroform or alcoholic solution to yield crystalline picrates (compare *Aromatic Hydrocarbons*, Section IV,9,I).

Dissolve 0.01 mol of the phenolic ether in 10 ml. of warm chloroform, and also (separately) 0.01 mol of picric acid plus 5 per cent. excess (0.241 g.) in 10 ml. of chloroform. Stir the picric acid solution and pour in the solution of the phenolic ether. Set the mixture aside in a 100 ml. beaker and allow it to crystallise. Recrystallise the picrate from the minimum volume of chloroform. In most cases equally satisfactory results may be obtained by conducting the preparation in rectified spirit (95 per cent. $\text{C}_2\text{H}_5\text{OH}$). The m.p. should be determined immediately after recrystallisation. It must be pointed out, however, that the picrates of aromatic ethers suffer from the disadvantage of being comparatively unstable and may undergo decomposition during recrystallisation.

When aromatic ethers possess an aliphatic side chain, a satisfactory derivative may frequently be obtained by oxidation of the side chain to carboxyl. The general procedure may be illustrated by the oxidation of *p*-cresyl methyl ether $p\text{-CH}_3\text{C}_6\text{H}_4\text{OCH}_3$ to anisic acid $p\text{-HOOC}_6\text{H}_4\text{OCH}_3$. Prepare a solution of 6 g. of potassium permanganate in a mixture of 20 ml. of 5 per cent. sodium hydroxide solution and 150 ml. of water, add 2 g. of *p*-cresyl methyl ether, and heat under reflux for 2-3 hours. If any permanganate remains at the end of this period, destroy it by the addition of a few drops of alcohol. Remove the precipitated manganese dioxide by filtration at the pump, evaporate the filtrate to a volume of 25-30 ml., and acidify it (to Congo red) with dilute sulphuric acid. Anisic acid, m.p. 183-184°, crystallises out on cooling.

Table IV,106 contains data referring to a number of selected aromatic ethers.

TABLE IV,106.

AROMATIC ETHERS

Ether	B.P.	M.P.	d_4^{20}	n_D^{20}	Sulphon- amide	Plerate	Other Derivatives
Anisole	154°	—	0.996	1.518	111°	81°	Dinitro, 87°; 2:4-dibromo, 61°
Phenetole	170	—	0.965	1.507	150	92	<i>p</i> -Nitro, 58
Phenyl <i>n</i> -propyl ether	188	—	0.949	1.501	—	—	—
Phenyl <i>n</i> -butyl ether	208	—	0.934	1.497	—	112	—
<i>o</i> -Cresyl methyl ether (1)	171	—	0.985	1.505	137	119	<i>o</i> -Methoxybenzoic acid, 101
<i>m</i> -Cresyl methyl ether	177	—	0.972	1.513	130	114	<i>m</i> -Methoxybenzoic acid, 110
<i>p</i> -Cresyl methyl ether	175	—	0.970	1.512	182	89	Anisic acid, 184
<i>o</i> -Cresyl ethyl ether	184	—	0.953	1.505	149	118	<i>o</i> -Ethoxybenzoic acid, 25
<i>m</i> -Cresyl ethyl ether	191	—	0.949	1.506	111	115	<i>m</i> -Ethoxybenzoic acid, 137
<i>p</i> -Cresyl ethyl ether	190	—	0.949	1.505	138	111	<i>p</i> -Ethoxybenzoic acid, 196
Benzyl methyl ether	171	—	0.965	1.501	—	116	—
Benzyl ethyl ether	186	—	0.948	1.496	—	—	—
Methyl α -naphthyl ether	265	—	1.092	1.696	157	129	Dibromo, 55
Methyl β -naphthyl ether	274	72°	—	—	151	117	Bromo, 63
Ethyl α -naphthyl ether	280	5	1.060	1.597	165	119	4-Bromo, 48
Ethyl β -naphthyl ether	282	37	—	—	163	100	1-Bromo, 66
Benzyl α -naphthyl ether	—	77	—	—	—	—	—
Benzyl β -naphthyl ether	—	99	—	—	—	—	—
<i>o</i> -Methoxydiphenyl	274	29	—	—	—	—	Nitro, 95
<i>p</i> -Methoxydiphenyl	—	90	—	—	—	—	—
<i>o</i> -Chloroanisole	195	—	1.191	1.545	131	—	Nitro, 95
<i>m</i> -Chloroanisole	194	—	—	—	—	—	—
<i>p</i> -Chloroanisole	198	—	—	—	151	—	Nitro, 98
<i>o</i> -Bromoanisole	210	—	—	—	140	—	Nitro, 106
<i>m</i> -Bromoanisole	211	—	—	—	—	—	—
<i>p</i> -Bromoanisole	215	11	—	—	148	—	Nitro, 88
<i>o</i> -Iodoanisole	242	—	—	—	—	—	—
<i>m</i> -Iodoanisole	244	—	—	—	—	—	—
<i>p</i> -Iodoanisole	240	52	—	—	—	—	—
<i>o</i> -Nitroanisole	272	10	1.254	1.562	—	—	<i>o</i> -Anisidine

TABLE IV,106.

AROMATIC ETHERS (continued)

Ether	B.P.	M.P.	d_{4}^{20}	n_{D}^{20}	Sulphonamide	Picrate	Other Derivatives
<i>m</i> -Nitroanisole	258°	39°	—	—	—	—	<i>m</i> -Anisidine (Table IV,100A)
<i>p</i> -Nitroanisole	259	54	—	—	—	—	<i>p</i> -Anisidine (Table IV,100A)
2 : 4 : Dinitroanisole	—	94	—	—	—	—	—
2 : 4 : 6-Trinitroanisole	—	68	—	—	—	—	—
2 : 4 : 6-Trichloroanisole	—	62	—	—	—	—	Dinitro, 95°
2 : 4 : 6-Tribromoanisole	—	88	—	—	—	—	—
<i>o</i> -Chlorophenetole	208	—	1.134	1.530	133°	—	Nitro, 82
<i>m</i> -Chlorophenetole	205	—	1.171	—	—	—	—
<i>p</i> -Chlorophenetole	212	21	1.121	1.522	134	—	Nitro, 61
<i>o</i> -Bromophenetole	218	—	—	—	135	—	Nitro, 98
<i>p</i> -Bromophenetole	233	4	—	—	145	—	Nitro, 47
<i>o</i> -Iodophenetole	246	—	—	—	—	—	Nitro, 96
<i>m</i> -Iodophenetole	134°/15	—	—	—	—	—	—
<i>p</i> -Iodophenetole	252	29	—	—	—	—	Nitro, 96
<i>o</i> -Nitrophenetole	267	—	—	—	—	—	<i>o</i> -Phenetidine (Table IV,100A)
<i>m</i> -Nitrophenetole	284	34	—	—	—	—	<i>m</i> -Phenetidine (Table IV,100A)
<i>p</i> -Nitrophenetole	283	60	—	—	—	—	<i>p</i> -Phenetidine (Table IV,100A)
2 : 4 : Dinitrophenetole	—	87	—	—	—	—	—
2 : 4 : 6-Trinitrophenetole	—	78	—	—	—	—	—
2 : 4 : 6-Trichlorophenetole	246	44	—	—	—	—	Dinitro, 100
2 : 4 : 6-Tribromophenetole	—	73	—	—	—	—	Nitro, 79
Thymol methyl ether	212	—	—	—	—	—	Trinitro, 92
Safrole (2)	232	11	1.100	1.538	—	105°	Piperonylic acid, 228 ; penta-bromo, 169
<i>iso</i> -Safrole (3)	248	7	1.122	1.578	—	75	Tribromo, 109 ; piperonylic acid, 228
Anethole (4)	235	22	0.989	1.558	—	70	Anisic acid, 184 ; tribromo, 108
Eugenol methyl ether (5)	244	—	1.050	1.532	—	—	Tribromo, 78 ; veratric acid, 179
Guaiacol (6)	205	28	1.129	1.544	—	88	Tribromo, 116

TABLE IV,106.

AROMATIC ETHERS (continued)

Ether	B.P.	M.P.	d_{4}^{20}	n_{D}^{20}	Sulphon- amide	Picrate	Other Derivatives
<i>iso</i> -Eugenol methyl ether (7) .	264°	—	1·053	1·569	—	—	—
Diphenyl ether	259	28°	—	—	159°	110°	Dibromo, 55° ; dinitro, 144°
Dibenzyl ether	296	—	1·043	—	—	78	—
<i>p</i> -Bromodiphenyl ether . . .	168°/15	—	—	—	131	—	—
Veratrole (8)	206	22	—	—	136	57	Dibromo, 93 ; nitro, 95
Resorcinol dimethyl ether . .	217	—	1·050	—	167	58	Dibromo, 140 ; trinitro, 124
Hydroquinone dimethyl ether	212	56	—	—	148	48	Nitro, 72 ; dibromo, 142
Catechol diethyl ether . . .	217	43	—	—	162	71	Trinitro, 122
Resorcinol diethyl ether . . .	235	12	—	—	184	109	—
Hydroquinone diethyl ether . .	—	72	—	—	155	—	Nitro, 49
Pyrogallol trimethyl ether . .	241	47	—	—	124	81	—
Pyrogallol triethyl ether . . .	—	39	—	—	—	—	—

(1) Methyl *o*-tolyl ether ; *o*-Methoxytoluene.

(2) 3 : 4-Methylenedioxy-1-allylbenzene.

(3) 3 : 4-Methylenedioxy-1-propenylbenzene.

(4) *p*-Propenylanisole.

(5) 3 : 4-Dimethoxy-1-allylbenzene.

(6) *o*-Methoxyphenol.

(7) 3 : 4-Dimethoxy-1-propenylbenzene.

(8) Catechol dimethyl ether.

IV,107. o-PROPIOPHENOL AND p-PROPIOPHENOL

Equip a 1 litre three-necked flask with a dropping funnel, a sturdy mechanical stirrer and a reflux condenser, and place 187 g. of anhydrous aluminium chloride and 200 ml. of carbon disulphide in it; attach a gas trap (Fig. II, 8, 1) to the top of the condenser. Stir the suspension and add 188 g. (179 ml.) of phenyl propionate (1) slowly and at such a rate that the solvent boils vigorously (about 90 minutes). Much hydrogen chloride is evolved and is absorbed by the trap. When all the phenyl propionate has been introduced, gently reflux the reaction mixture on a water bath until the evolution of hydrogen chloride ceases (about 2 hours). Turn the reflux condenser downwards (compare Fig. II, 41, 1), and distil off the solvent from the water bath. Then replace the latter by an oil bath maintained at 140–150°, and heat, with stirring, for 3 hours. During this period more hydrogen chloride is evolved, the mixture thickens, and finally becomes a brown resinous mass; continue the stirring as long as possible. Allow the reaction mixture to cool and decompose the aluminium chloride complex by *slowly* adding first 150 ml. of dilute hydrochloric acid (1 : 1) and then 250 ml. of water; much heat is evolved and a dark oil collects on the surface. Allow to stand overnight, when most of the *p*-propiophenol in the upper layer solidifies. Filter this off at the pump, and recrystallise it from 200 ml. of methyl alcohol; 74 g. of *p*-propiophenol (a pale yellow solid), m.p. 147°, are obtained.

Concentrate the mother liquors from this recrystallisation and combine with the oily filtrate: dissolve in 250 ml. of 10 per cent. sodium hydroxide solution, and extract with two 50 ml. portions of ether to remove non-phenolic products. Acidify the alkaline solution with hydrochloric acid, separate the oily layer, dry it over anhydrous magnesium sulphate, and distil under diminished pressure, preferably from a Claisen flask with fractionating side arm (Figs. II, 24, 2–5). Collect the *o*-propiophenol (65 g.) at 110–115°/6 mm. and a further quantity (20 g.) of crude *p*-propiophenol at 140–150°/11 mm.

Note.

(1) The phenyl propionate may be prepared by slowly adding 196 g. (120 ml.) of redistilled thionyl chloride to a mixture of 150 g. of pure phenol and 132 g. (133 ml.) of propionic acid (compare Fig. III, 31, 1), warming to drive all the sulphur dioxide and hydrogen chloride, and distilling; 190 g. of phenyl propionate, b.p. 202–212° (the pure substance boils at 211°) are obtained.

COGNATE PREPARATIONS

***o*- and *p*-hydroxyacetophenone.** Use 187 g. of anhydrous aluminium chloride, 200 ml. of carbon disulphide and 170 g. (158 ml.) of phenyl acetate (Section IV,103). After acidifying and leaving overnight, dilute the partly solidified oil with benzene, and extract the aqueous layer with benzene. Dry the benzene with anhydrous magnesium sulphate, distil off the benzene at atmospheric pressure, and then distil the residue under reduced pressure (15–20 mm.) until the *p*-isomer begins to collect in the condenser. Refractionate the distillate from a Widmer flask (Figs. II, 24, 3–5) and collect the *o*-hydroxyacetophenone at 105–106°/20 mm. (or at 87–88°/7 mm.): the yield is 30 per cent. based on

the phenyl acetate. The *p*-hydroxyacetophenone remaining in the flask may be recrystallised from dilute alcohol or from benzene-light petroleum (b.p. 60–80°); it melts at 109°. Any residual *o*-hydroxyacetophenone may be removed by steam distillation; the *p*-isomer is non-volatile in steam.

2 : 5-Dihydroxyacetophenone. Finely powder a mixture of 40 g. of dry hydroquinone diacetate (1) and 87 g. of anhydrous aluminium chloride in a glass mortar and introduce it into a 500 ml. round-bottomed flask, fitted with an air condenser protected by a calcium chloride tube and connected to a gas absorption trap (Fig. II, 8, 1). Immerse the flask in an oil bath and heat slowly so that the temperature reaches 110–120° at the end of about 30 minutes: the evolution of hydrogen chloride then begins. Raise the temperature slowly to 160–165° and maintain this temperature for 3 hours. Remove the flask from the oil bath and allow to cool. Add 280 g. of crushed ice followed by 20 ml. of concentrated hydrochloric acid in order to decompose the excess of aluminium chloride. Filter the resulting solid with suction and wash it with two 80 ml. portions of cold water. Recrystallise the crude product from 200 ml. of 95 per cent. ethanol. The yield of pure 2 : 5-dihydroxyacetophenone, m.p. 202–203°, is 23 g.

Note.

(1) Hydroquinone diacetate may be prepared as follows. Add 1 drop of concentrated sulphuric acid to a mixture of 55 g. of hydroquinone and 103 g. (95.5 ml.) of A.R. acetic anhydride in a 500 ml. conical flask. Stir the mixture gently by hand; it warms up rapidly and the hydroquinone dissolves. After 5 minutes, pour the clear solution on to 400 ml. of crushed ice, filter with suction and wash with 500 ml. of water. Recrystallise the solid from 50 cent. ethanol by weight (ca. 400 ml. are required). The yield of pure hydroquinone diacetate, m.p. 122°, is 89 g.

IV,108.

o- AND *p*-NITROPHENOLS

Cautiously add 250 g. (136 ml.) of concentrated sulphuric acid in a thin stream and with stirring to 400 ml. of water contained in a 1 litre bolt-head or three-necked flask, and then dissolve 150 g. of sodium nitrate in the diluted acid. Cool in a bath of ice or iced water. Melt 94 g. of phenol with 20 ml. of water, and add this from a separatory funnel to the stirred mixture in the flask at such a rate that the temperature does not rise above 20°. Continue the stirring for a further 2 hours after all the phenol has been added. Pour off the mother liquid from the resinous mixture of nitro compounds. Melt the residue with 500 ml. of water, shake and allow the contents of the flask to settle. Pour off the wash liquor and repeat the washing at least two or three times to ensure the complete removal of any residual acid. Steam distil the mixture (Fig. II, 40, 1 or Fig. II, 41, 1) until no more *o*-nitrophenol passes over; if the latter tends to solidify in the condenser, turn off the cooling water temporarily. Collect the distillate in cold water, filter at the pump, and drain thoroughly. Dry upon filter paper in the air. The yield of *o*-nitrophenol, m.p. 46° (1), is 50 g.

Allow the residue in the flask to cool during 2 hours and then cool in ice for 15–30 minutes. Filter off the crude *p*-nitrophenol and boil it

with one litre of 2 per cent. hydrochloric acid (2) together with about 5 g. of decolourising charcoal for at least 10 minutes. Filter through a hot water funnel (or through a Buchner funnel, preheated by pouring boiling water through it): allow the filtrate to crystallise overnight. Filter off the almost colourless needles and dry them upon filter paper. The yield of *p*-nitrophenol, m.p. 112°, is 35 g. Further small quantities may be obtained by concentrating the mother liquor and also by repeating the extraction of the residue with 2 per cent. hydrochloric acid.

Notes.

(1) If the m.p. is not quite satisfactory, dissolve the *o*-nitrophenol in hot alcohol (or methylated spirit) under reflux, add hot water drop by drop until a cloudiness just appears, and allow to cool spontaneously. Filter off the bright yellow crystals and dry between filter paper.

(2) It is not advisable to treat the crude *p*-nitrophenol with sodium hydroxide solution in order to convert it into the sodium derivative: alkali causes extensive resinification.

IV,109.

2 : 4-DINITROPHENOL

In a 1 litre round-bottomed flask equipped with a reflux condenser place a solution of 62.5 g. of anhydrous sodium carbonate in 500 ml. of water and add 50 g. of commercial 2 : 4-dinitro-1-chlorobenzene. Reflux the mixture for 24 hours or until the oil passes into solution. Acidify the yellow solution with hydrochloric acid and, when cold, filter the crystalline dinitrophenol which has separated. Dry the product upon filter paper in the air. The yield is 46 g. If the m.p. differs appreciably from 114°, recrystallise from alcohol or from water.

IV,110.

PICRIC ACID (2 : 4 : 6-TRINITROPHENOL)

Place 10 g. of phenol in a dry 750 ml. or 1 litre flat-bottomed flask and add 23 g. (12.5 ml.) of concentrated sulphuric acid, shake the mixture (which becomes warm) and heat it on a boiling water bath for 30 minutes to complete the formation of the *o*- and *p*-phenolsulphonic acids, and then cool the flask thoroughly in an ice-water mixture. Place the flask on a non-conducting surface (*e.g.*, a wooden block or an asbestos board) in a fume cupboard, and, *whilst the phenolsulphonic acids are still a viscous syrup*, add 38 ml. of concentrated nitric acid and *immediately* mix the liquids by shaking for a few seconds. Allow the mixture to stand; generally within 1 minute a vigorous but harmless reaction takes place and copious red fumes are evolved. When the reaction subsides, heat the flask in a boiling water bath for 1.5-2 hours with occasional shaking; the heavy oil, initially present, will ultimately form a mass of crystals. Add 100 ml. of cold water, chill thoroughly in ice water, filter the crystals at the pump, wash well with water to remove all the nitric acid, and drain. Recrystallise from dilute alcohol (1 volume of alcohol : 2 volumes of water); about 110 ml. are required. Filter off the recrystallised material and dry between filter paper. The yield of picric acid (yellow crystals), m.p. 122°, is 16 g.

Note.

It is advisable to keep the picric acid in the moist condition (containing about 10 per cent. of water) in a bottle with a cork stopper. Small quantities may be

safely stored whilst dry, but this is not recommended in the interest of safety. Under no circumstances should glass stoppers be employed for potentially explosive substances, since on replacing the stopper some of the material may be ground between the stopper and the neck of the bottle and an explosion may result.

IV,111.

p-BROMOPHENOL

Equip a 500 ml. three-necked flask with a reflux condenser, a mechanical stirrer and a separatory funnel; use rubber stoppers throughout. Attach to the top of the condenser a calcium chloride (or cotton wool) tube leading by means of a glass tube to a funnel just immersed in a beaker holding about 150 ml. of water and crushed ice for the absorption of the hydrogen bromide (compare Fig. II, 13, 8, b) (1). Place 100 g. of phenol dissolved in 100 ml. of dry carbon disulphide in the flask, set the stirrer in motion and cool the flask in a mixture of ice and salt. When the temperature falls below 5°, add slowly (during about 2 hours) from the separatory funnel a solution of 170 g. (54.5 ml.) of bromine in 50 ml. of carbon disulphide. Then arrange the flask for distillation (compare Fig. II, 41, 1), attach a distilling flask as a receiver tightly to the lower end of the condenser and connect the side arm of the distilling flask to a device for absorbing the hydrogen bromide evolved (compare Fig. II, 8, 1) (1). Distil off the carbon disulphide on a water bath (**CAUTION**), transfer the residue to a Claisen flask with fractionating side arm (Figs. II, 24, 2-4) but with the upper side arm fused in as in Fig. II, 1, 3, d so that any bromophenol which may come into contact with rubber is not carried over into the condenser; if this precaution is not taken, a pinkish product will result. Distil under diminished pressure: the first fraction (25-35 g.) contains an inseparable mixture of *o*- and *p*-bromophenols, this is followed by fairly pure *p*-bromophenol at 145-150°/25-30 mm. (150-155 g.), and some high boiling material containing 2:4-dibromophenol. The *p*-bromophenol solidifies on cooling to a solid white mass, which usually contains traces of an oil; this may be removed by spreading on a porous tile or by centrifuging. The dry crystals melt at 63°.

Note.

(1) A considerable quantity of constant boiling point hydrobromic acid may be obtained by distilling these solutions.

IV,112.

o-BROMOPHENOL

In a 1-litre flask, equipped as in the preceding Section, place a mixture of 31 g. of phenol and 116 g. (63 ml.) of concentrated sulphuric acid, and heat in a boiling water bath for 3 hours with mechanical stirring. Cool to room temperature or below by immersing the flask in ice water, and then add slowly a solution of 95 g. of sodium hydroxide in 235 ml. of water: a solid salt may separate, but this will dissolve at a later stage. Replace the separatory funnel by a cork carrying a thermometer, which dips well into the liquid, and support a small dropping funnel by means of a grooved cork in the top of the condenser. Cool the alkaline solution to room temperature, and add 53 g. (17 ml.) of bromine from the dropping

funnel during 20–30 minutes whilst stirring constantly; permit the temperature to rise to 40–50°. Continue the stirring for 30 minutes after the bromine has been introduced: the reaction mixture should still be alkaline and contain only a small amount of suspended matter. The solution must now be evaporated. Arrange the flask assembly so that a rapid stream of air can be passed through the stirred reaction mixture, and heat the flask in an oil bath at 150–155°. After 30–40 minutes, a thick pasty mass remains. Allow to cool and then add 270 ml. of concentrated sulphuric acid (*FUME CUPBOARD*; much hydrogen bromide is evolved). Heat the flask in an oil bath at 195–205° and steam distil the mixture (compare Fig. II, 41, 1); this results in the hydrolysis of the sulphonate groups and the bromophenol passes over as a heavy, colourless (or pale yellow) oil. When the distillate is clear, extract it with ether. Dry the ethereal extract with a little anhydrous magnesium sulphate, remove the ether on a water bath (Fig. II, 13, 4) and distil the residue as rapidly as possible since the bromophenol is somewhat unstable and decomposes appreciably at the high temperature. Collect the fraction b.p. 195–200° (a colourless liquid with a characteristic odour), which is practically pure *o*-bromophenol. The yield is 25 g. The compound is somewhat unstable and decomposes on standing, becoming brown or red in colour.

IV,113.

p-IODOPHENOL

Dissolve 54.5 g. of *p*-aminophenol (Section IV,83) in a mixture of 60 g. (32.5 ml.) of concentrated sulphuric acid, 250 ml. of water and 250 g. of crushed ice in a large beaker or bolt-head flask. Cool the solution in a freezing mixture, stir mechanically, and add during 1 hour a solution of 34.5 g. (1) of sodium nitrite in 75 ml. of water. Stir for a further 20 minutes, and then add 18.5 g. (10 ml.) of concentrated sulphuric acid. Pour the cold diazonium solution into an ice-cold solution of 100 g. of potassium iodide in 100 ml. of water contained in a beaker provided with a mechanical stirrer. After 5 minutes, add 1 g. of copper bronze (which has been washed with ether), with continued stirring, and warm the solution slowly on a water bath. Maintain the temperature at 75–80° until the evolution of nitrogen ceases; the iodophenol separates as a dark heavy oil. Cool to room temperature, extract the reaction mixture with three 80 ml. portions of chloroform, wash the combined extracts with dilute sodium bisulphite solution or sodium thiosulphate solution, and dry with anhydrous magnesium sulphate. Remove the solvent on a water bath (compare Fig. II, 13, 4, but with a Claisen flask replacing the distilling flask) and distil the residue under diminished pressure. Collect the *p*-iodophenol at 138–140°/5 mm.; this solidifies on cooling. Recrystallise from about 1 litre of light petroleum (b.p. 80–100°). The yield of colourless product, m.p. 94°, is 78 g.

Note.

(1) This weight is for sodium nitrite of 100 per cent. purity; it should be adjusted according to the purity of the sodium nitrite employed.

IV,114. REACTIONS AND CHARACTERISATION OF PHENOLS

Most phenols are crystalline solids; notable exceptions are *m*-cresol and *o*-bromophenol. The monohydric phenols generally have characteristic odours. The solubility in water increases with the number of hydroxyl groups in the molecule.

(i) **Ferric chloride solution.** Dissolve about 0.05 g. of the compound in 5 ml. of water; if the compound is sparingly soluble, prepare a hot, saturated aqueous solution, filter and use 1 ml. of the cold filtrate. Place the solution in a 75 × 10 mm. test-tube. Add 1 drop of "neutral" 1 per cent. ferric chloride solution and observe the colour; add another drop after 2–3 seconds. If a transient or permanent colouration (usually purple, blue or green) other than yellow or orange-yellow is observed, the substance is probably a phenol (or an enol). If no colouration is obtained, repeat the test as above but substitute absolute ethanol or methanol for water as solvent.

(ii) **Sodium bicarbonate solution.** Phenols do not usually liberate carbon dioxide from 5 per cent. sodium bicarbonate solution {for details, see under *Aliphatic Carboxylic Acids*, Section III,85,(i)}. They will dissolve, however, in sodium hydroxide solution. Add 0.1 g. of the substance to 1 ml. of 5 per cent. sodium hydroxide solution and shake or stir. Observe whether the material dissolves and/or a colouration is produced (*e.g.*, a brown colouration from *o*- and *p*-polyhydric phenols): if only partial solution takes place or another substance appears to form, dilute with 1 ml. of water and shake. The latter procedure is necessary for sparingly soluble sodium salts (*e.g.*, sodium methyl salicylate).

(iii) **Bromine water.** Many phenols (with the exception of those with strong reducing properties) yield crystalline bromination products; these are often useful for purposes of characterisation. Dissolve or suspend 0.25 g. of the compound in 10 ml. of dilute hydrochloric acid or of water, and add bromine water dropwise until decolourisation is slow: a white precipitate of the bromophenol may form. Recrystallise and determine the m.p.

An alternative procedure, more suitable for the preparation of somewhat larger quantities of the bromo derivative, is the following. Dissolve 1.0 g. of the compound in 10–15 ml. of glacial acetic acid, cautiously add 3–4 ml. of liquid bromine, and allow the mixture to stand for 15–20 minutes. Pour into 50–100 ml. of water, filter off the bromo compound at the pump, and wash with a little cold water. Recrystallise from dilute alcohol.

(iv) **Phthalein test.** Many phenols yield phthaleins, which give characteristic colourations in alkaline solution, when fused with phthalic anhydride and a little concentrated sulphuric acid.

Place in a dry test-tube 0.5 g. of the compound and an equal bulk of pure phthalic anhydride, mix well together, and add 1 drop of concentrated sulphuric acid. Stand the tube for 3–4 minutes in a small beaker of concentrated sulphuric acid or oil previously heated to 160°. Remove from the bath, allow to cool, add 4 ml. of 5 per cent. sodium hydroxide solution and stir until the fused mass has dissolved. Dilute with an equal

volume of water, filter and examine the colour of the filtrate against a white back-ground : if the solution exhibits a fluorescence, observe the colour against a black back-ground.

CRYSTALLINE DERIVATIVES OF PHENOLS

1. Acetates. The acetates of monohydric phenols are usually liquids, but those of di- and tri-hydric phenols and also of many substituted phenols are frequently crystalline solids. They may be prepared with acetic anhydride as detailed under *Amines*, Section IV,100,1.

Acetates may also be prepared by adding acetic anhydride to somewhat dilute solutions of compounds containing hydroxyl (or amino) groups in aqueous caustic alkalis. The amount of alkali used should suffice to leave the liquid slightly basic at the end of the operation, so much ice should be added that a little remains unmelted, and the acetic anhydride should be added quickly.

Dissolve 0.01 mol (or 1 g. if the molecular weight is unknown) of the compound in 5 ml. of 3*N* sodium hydroxide solution, add 10-20 g. of crushed ice followed by 1.5 g. (1.5 ml.) of acetic anhydride. Shake the mixture vigorously for 30-60 seconds. The acetate separates in a practically pure condition either at once or after acidification by the addition of a mineral acid. Collect the acetyl derivative, and recrystallise it from hot water or from dilute alcohol.

2. Benzoates. The benzoates of a few phenols (*e.g.* *o*-cresol) are liquids. Many phenols do, however, yield crystalline benzoyl derivatives : these are useful for purposes of characterisation.

The Schotten - Baumann method of benzylation with benzoyl chloride in the presence of aqueous sodium hydroxide may be used. Full details are given under *Amines* ; Section IV,100,2.

3. *p*-Nitrobenzoates and 3 : 5-dinitrobenzoates. Both *p*-nitrobenzoyl chloride and 3 : 5-dinitrobenzoyl chloride react with phenols, best in pyridine solution, to yield crystalline *p*-nitrobenzoates and 3 : 5-dinitrobenzoates respectively :

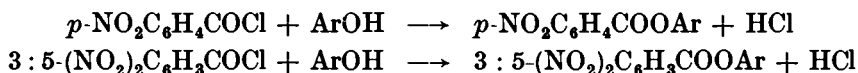

For properties of these reagents and their preparation from the corresponding acids, see under *Aliphatic Alcohols*, Section III,27, 1 and 2.

Dissolve 0.5 g. of the phenol in 4-5 ml. of dry pyridine, add 1.3 g. of 3 : 5-dinitrobenzoyl chloride and reflux for 25-30 minutes. Pour the cold reaction mixture into 40 ml. of *ca.* 2*N* hydrochloric acid. Decant the supernatant aqueous liquid from the precipitated solid or oil and stir it vigorously with about 10 ml. of *N* sodium carbonate solution. Filter off the solid derivative and wash it with water. Recrystallise from alcohol, dilute alcohol, benzene - acetone or benzene - light petroleum (b.p. 60-80°).

4. Aryloxyacetic acids. Phenols, in the presence of alkali, react with chloroacetic acid to give aryloxyacetic acids :



These are crystalline compounds with sharp melting points, and possess the further advantage that their equivalent weights may be determined by dissolving in dilute alcohol and titrating with standard alkali. Nitrophenols, however, give unsatisfactory derivatives.

To a mixture of 1.0 g. of the compound and 3.5 ml. of 33 per cent. sodium hydroxide solution in a test-tube, add 2.5 ml. of 50 per cent. chloroacetic acid solution. If necessary, add a little water to dissolve the sodium salt of the phenol. Stopper the test-tube loosely and heat on a gently-boiling water bath for an hour. After cooling, dilute with 10 ml. of water, acidify to Congo red with dilute hydrochloric acid, and extract with 30 ml. of ether. Wash the ethereal extract with 10 ml. of water, and extract the aryloxyacetic acid by shaking with 25 ml. of 5 per cent. sodium carbonate solution. Acidify the sodium carbonate extract (to Congo red) with dilute hydrochloric acid, collect the aryloxyacetic acid which separates, and recrystallise it from hot water.

5. **Diphenylurethanes.** Phenols react with diphenylcarbonyl chloride to yield diphenylurethanes (or aryl *N,N*-diphenylcarbamates) :

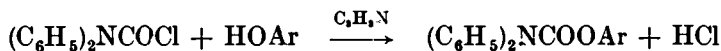

The reagent is unsuitable for a number of phenolic acids.

Dissolve 0.5 g. of the phenol in 2.5 ml. of pyridine, and add one equivalent of diphenylcarbonyl chloride (or 0.4–0.5 g. if the molecular weight is uncertain). Reflux the mixture for 30–60 minutes on a boiling water bath, and then pour into about 25 ml. of water. Filter the derivative, wash with a little sodium bicarbonate solution, and recrystallise from alcohol benzene, light petroleum (b.p. 60–80°) or carbon tetrachloride.

6. **α -Naphthylurethanes (α -naphthylcarbamates).** α -Naphthyl *iso*-cyanate reacts smoothly with monohydric, but not with polyhydric, phenols to give α -naphthylurethanes (or *N*- α -naphthylcarbamates) :



(compare *Aliphatic Alcohols*, Section III, 27, 4). Some phenols, e.g., nitrophenols and halogeno-phenols, react with difficulty with the reagent alone; the addition of a few drops of pyridine or 1 drop of an ethereal solution of trimethylamine or triethylamine generally results in the rapid formation of the urethane.

Place 0.25 g. of the phenol together with an equal weight of α -naphthyl *iso*-cyanate in a *dry* test-tube closed with a stopper carrying a calcium chloride or cotton wool guard tube. If a spontaneous reaction does not occur, boil the mixture gently for 2–3 minutes, and cool; if the reaction mixture does not solidify, rub the walls of the tube vigorously with a glass rod. If no crystalline solid is obtained, add 2 drops of dry pyridine or 1 drop of an ethereal solution of triethylamine, and warm on a water bath for 5 minutes. Extract the contents of the tube with boiling light petroleum (b.p. 80–100° or 100–120°) to separate any insoluble di- α -naphthyl urea. Recrystallise the crystals which separate on cooling from the same solvent.

The following alternative method may be used. Dissolve 0.01 mol of the phenol and 0.01 mol of α -naphthyl *iso*-cyanate in 20 ml. of light petroleum (b.p. 60–80°), add 2 drops of triethylamine (or, less satisfactorily, 2 drops of pyridine), reflux for 5 minutes, and allow to crystallise. Filter off the crystalline solid through a sintered glass funnel.

7. ***p*-Toluenesulphonates.** *p*-Toluenesulphonyl chloride condenses readily with phenols to yield *p*-toluenesulphonates :

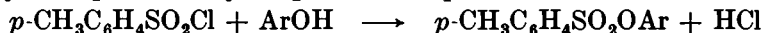

Mix 1.0 g. of the phenol with 2.5 ml. of pyridine, add 2 g. of *p*-toluenesulphonyl chloride, and heat on a water bath for 15 minutes. Pour into 25 ml. of cold water and stir until the oil solidifies. Filter, wash with cold dilute hydrochloric acid (to remove pyridine), with cold dilute sodium hydroxide solution (to remove any phenol present), and then with cold water. Recrystallise from methyl or ethyl alcohol.

8. **2 : 4-Dinitrophenyl ethers.** 2 : 4-Dinitrochlorobenzene reacts with the sodium salts of phenols to yield crystalline 2 : 4-dinitrophenyl ethers :

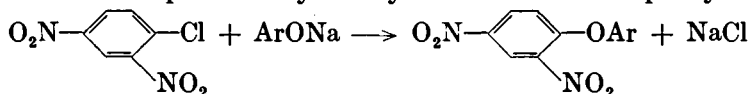

Dissolve 1 g. (or 0.01 mol) of the phenol in a solution of 0.40 g. of sodium hydroxide in 5 ml. of water. Add the resulting solution to 2.0 g. of 2 : 4-dinitrochlorobenzene dissolved in 30 ml. of 95 per cent. ethanol; add more alcohol, if necessary, to effect solution. Heat the solution under reflux on a water bath until the colour (usually red) is discharged and a copious precipitate of sodium chloride appears (30–60 minutes). Dilute the reaction mixture with an equal volume of water, filter off the precipitated 2 : 4-dinitrophenyl ether, wash with water, and recrystallise from alcohol.

Note. The 2 : 4-dinitrochlorobenzene must be handled cautiously : it is a skin irritant. If any touches the skin, wash it immediately with methylated spirit.

9. **Pseudo-saccharin ethers.** When pseudo-saccharin chloride is heated with an excess of a phenol, *O*-aryl derivatives of saccharin are produced (compare Section III, 27, 7).

Heat 0.5 g. of pseudo-saccharin chloride with an excess of the phenol to 125–140° for 15–20 minutes; hydrogen chloride is evolved. Wash the product with dilute sodium hydroxide solution and then with water. Recrystallise the derivative from ethanol.

The melting points of some *O*-aryl saccharin derivatives are : phenol, 182°; *o*-cresol, 163°; *m*-cresol, 146°; *p*-cresol, 172°; *o*-nitrophenol, 236°; *p*-nitrophenol, 192°.

The melting points of the derivatives of a number of selected phenols are collected in Table IV, 114. The physical properties of a number of enols are given in Table IV, 114A.

Heating of β -keto esters or of 1 : 3-diketones with an equivalent amount of phenylhydrazine often yields substituted pyrazolones or pyrazoles respectively. The latter may serve as *derivatives of enols*.

Heat a mixture of 0.5 g. of ethyl acetoacetate and an equivalent amount of phenylhydrazine in an oil bath at 100–110° for 2 hours. Water and alcohol vapours are evolved. Cool and recrystallise the product from alcohol. The resulting phenylmethylpyrazolone has m.p. 127°.

TABLE IV, 114.

PHENOLS

Phenol	B.P.	M.P.	Bromo Compound	Acetate	Benzoate	<i>p</i> -Nitrobenzoate	3:5-Dinitrobenzoate	Aryloxyacetic Acid	<i>NN</i> -Diphenylcarbamate	<i>N</i> - α -Naphthylcarbamate	<i>p</i> -Toluenesulphonate	2:4-Dinitrophenyl Ether
Phenol	182°	43°	95†	Liq.	69°	126°	146°	99°	105°	133°	96°	69°
<i>o</i> -Cresol	191	30	56*	Liq.	Liq.	94	138	152	73	142	55	90
<i>m</i> -Cresol	202	12	84†	Liq.	55	90	165	103	101	128	56	74
<i>p</i> -Cresol	202	36	49*	Liq.	71	98	189	136	94	146	70	94
<i>o</i> -Chlorophenol	176	9	—	Liq.	Liq.	115	143	145	—	120	74	99
<i>m</i> -Chlorophenol	214	33	—	Liq.	71	99	156	110	—	158	—	75
<i>p</i> -Chlorophenol	217	43	—	Liq.	86	168	186	156	97	166	71	126
<i>o</i> -Bromophenol	195	5	95†	Liq.	—	—	—	143	—	129	78	89
<i>m</i> -Bromophenol	236	33	—	Liq.	86	—	—	108	—	108	53	—
<i>p</i> -Bromophenol	235	64	95†	21°	102	180	191	159	99	169	94	141
<i>o</i> -Iodophenol	—	43	—	—	34	—	—	135	—	—	—	95
<i>m</i> -Iodophenol	—	40	—	38	—	133	183	115	—	—	61	—
<i>p</i> -Iodophenol	—	94	—	32	119	—	—	156	127	—	99	156
2:4-Dichlorophenol	210	45	68	—	96	—	—	140	—	—	125	119
2:4-Dibromophenol	239	40	—	36	98	184	—	153	—	—	120	135
2:4-Diiodophenol	—	72	—	71	98	—	—	—	—	—	—	—
2:4:5-Trichlorophenol	249	68	—	—	93	—	—	157	—	—	—	—
2:4:6-Trichlorophenol	246	69	—	—	75	106	136	182	143	188	—	136
2:4:6-Tribromophenol	—	94	120‡	82	81	163	174	200	153	153	113	135
2:4:6-Triiodophenol	—	159	—	156	—	—	181	—	—	—	—	—
<i>o</i> -Nitrophenol	216	45	117*	41	59	141	155	158	114	113	83	142
<i>m</i> -Nitrophenol	—	97	91*	56	95	174	159	156	—	167	113	138
<i>p</i> -Nitrophenol	—	14	142*	83	142	159	186	187	112	151	97	120
2:4-Dinitrophenol	—	113	118	72	132	139	—	—	—	—	121	248
Picric acid	—	122	—	76	—	143	—	—	—	—	—	—
<i>o</i> -Methoxyphenol (1)	205	28	116†	Liq.	58	93	142	119	118	118	85	97
<i>m</i> -Methoxyphenol (2)	244	—	104†	Liq.	—	—	—	114	—	129	—	—
<i>p</i> -Methoxyphenol (3)	243	56	—	32	87	—	—	111	—	—	—	—
2:3-Dimethylphenol (4)	218	75	—	—	—	—	—	187	—	—	—	—
3:4-Dimethylphenol (5)	225	62	171†	—	58	—	181	163	—	142	—	—
2:4-Dimethylphenol (6)	21	28	179†	Liq.	38	105	164	142	—	135	—	—
3:5-Dimethylphenol (7)	219	68	166†	Liq.	24	109	195	86	—	—	—	—

TABLE IV,114.

PHENOLS (continued)

Phenol	B.P.	M.P.	Bromo Compound	Acetate	Benzoate	<i>p</i> -Nitrobenzoate	3 : 5 Dinitrobenzoate	Aryloxyacetic Acid	NN-Diphenylcarbamate	N- α -naphthylcarbamate	<i>p</i> -Toluenesulphonate	2 : 4-Dinitrophenyl Ether
2 : 5-Dimethylphenol (8)	211°	75°	178†	Liq.	61°	87°	137°	118°	—	173°	—	—
2 : 6-Dimethylphenol (9)	203	49	79	—	—	—	159	140	—	—	—	—
<i>o</i> -Ethylphenol	207	—	—	—	39	56	108	141	—	—	—	—
<i>m</i> -Ethylphenol	217	—	—	Liq.	52	68	—	75	—	—	—	—
<i>p</i> -Ethylphenol	219	47	—	Liq.	60	81	132	97	—	128	—	—
<i>o</i> -cycloHexylphenol	—	55	—	—	—	—	—	—	—	—	—	—
<i>p</i> -cycloHexylphenol	—	132	—	—	118	137	168	—	—	—	—	—
<i>p</i> - <i>n</i> -Butylphenol	248	22	—	—	127	68	—	81	—	—	—	—
<i>p</i> - <i>tert</i> -Butylphenol	237	99	—	Liq.	82	—	—	86	—	110	—	—
<i>p</i> - <i>tert</i> -Amylphenol	266	96	—	Liq.	61	—	—	—	—	—	54°	—
Eugenol (10)	254	—	118	30°	70	81	131	80	—	122	85	115°
<i>iso</i> -Eugenol (11)	266	—	—	80	106	109	—	94	—	150	—	130
Thymol (12)	233	51	55	Liq.	33	70	103	148	—	160	71	67
<i>p</i> -Chlorothymol	—	59	—	—	—	—	—	—	—	—	—	—
Vanillin (13)	—	81	160	102	78	—	—	189	—	—	115	131
Carvacrol (14)	238	—	46	Liq.	—	51	77	151	—	116	—	—
Salicylaldehyde (15)	197	—	—	39	—	128	—	132	—	—	64	—
<i>m</i> -Hydroxybenzaldehyde	240	108	—	Liq.	38	—	—	148	—	—	—	—
<i>p</i> -Hydroxybenzaldehyde	—	116	—	Liq.	90	—	—	198	—	—	—	—
Salicylic acid (16)	—	159	—	135	132	205	—	191	—	—	—	—
<i>m</i> -Hydroxybenzoic acid	—	200	—	131	—	—	—	206	—	—	—	—
<i>p</i> -Hydroxybenzoic acid	—	214	—	187	—	—	—	278	—	—	—	—
α -Naphthol	279	94	105*	49	56	143	217	192	—	152	88	128
β -Naphthol	285	123	84	72	107	169	210	154	141*	157	125	95
<i>o</i> -Hydroxydiphenyl (17)	275	58	—	63	76	—	—	—	—	—	65	—
<i>p</i> -Hydroxydiphenol	306	165	—	88	151	—	—	—	—	—	177	118
Catechol	240	105	192†	65	84	169	152	—	—	175	—	—
Resorcinol	280	110	112*	Liq.	117	182	201	195	130	206	81	194
Hydroquinone	286	170	186*	124	199	250	317	250	230	247	159	—
Orcinol (18) (hydrate m.p. 58°)	289	108	104†	25	88	214	190	217	154	160	—	—
Pyrogallol	309	133	158*	173	90	230	205	198	212	—	—	—
Phloroglucino	—	218	151†	104	174	283	162	—	—	—	—	—

TABLE IV,114.

PHENOLS (continued)

Phenol	B.P.	M.P.	Bromo Compound	Acetate	Benzoate	<i>p</i> -Nitrobenzoate	3 : 5 Dinitrobenzoate	Aryloxyacetic Acid	<i>NN</i> -Diphenylcarbamate	<i>N</i> - α -Naphthylcarbamate	<i>p</i> -Toluenesulphonate	2 : 4-Dinitrophenyl Ether
1 : 3-Dihydroxynaphthalene (19)	—	124°	—	56°	—	—	—	—	—	—	—	—
1 : 5-Dihydroxynaphthalene	—	265	—	160	235°	—	—	—	—	—	—	—
1 : 8-Dihydroxynaphthalene	—	142	—	155	175	—	—	—	—	220°	—	—
2 : 7-Dihydroxynaphthalene	—	190	—	136	139	—	—	149°	176°	—	150°	—
2 : 2'-Dihydroxydiphenyl	—	109	—	95	101	—	—	—	—	—	190	—
3 : 4-Dihydroxydiphenyl	—	141	—	—	—	—	—	—	—	—	—	—
4 : 4'-Dihydroxydiphenyl	—	274	—	161	241	—	—	274	—	—	—	—
Methyl salicylate	223°	—	—	49	92	128°	—	—	—	—	—	—
Ethyl salicylate	231	—	—	—	80	108	—	—	—	—	—	—
<i>n</i> -Propyl salicylate	239	—	—	—	—	—	—	—	—	—	—	—
<i>iso</i> -Propyl salicylate	241	—	—	—	—	—	—	—	—	—	—	—
<i>n</i> -Butyl salicylate	260	—	—	—	—	—	—	—	—	—	—	—
Salol (20)	—	43	—	98	81	111	—	—	144	—	—	—
β -Naphthyl salicylate	—	95	—	136	—	—	—	—	—	—	—	—
Methyl <i>p</i> -hydroxybenzoate	—	131	—	85	135	—	—	—	—	—	—	—
Ethyl <i>p</i> -hydroxybenzoate	—	116	—	—	94	—	—	—	—	—	—	—
Chlorohydroquinone	—	106	—	72	—	—	—	—	—	—	—	—
Bromohydroquinone	—	111	—	72	—	—	—	—	—	—	—	—
Hydroxyhydroquinone (21)	—	140	—	97	120	—	—	—	—	—	—	—
<i>n</i> -Hexyl resorcinol	335	69	—	—	—	—	—	—	—	—	—	—
Saligenin (22)	—	87	—	—	51	—	—	120	—	—	—	—

* Dibromo.

† Tribromo.

‡ Tetrabromo.

- (1) Guaiacol.
 (2) Resorcinol monomethyl ether.
 (3) Hydroquinone monomethyl ether.
 (4) 1 : 2 : 3-Xylenol ; *o*-3-Xylenol.
 (5) 1 : 2 : 4-Xylenol ; *o*-4-Xylenol.
 (6) 1 : 3 : 4-Xylenol ; *m*-4-Xylenol.
 (7) 1 : 3 : 5-Xylenol ; *m*-5-Xylenol.
 (8) 1 : 4 : 5-Xylenol ; *p*-2-Xylenol.

- (9) 1 : 3 : 2-Xylenol ; *m*-2-Xylenol.
 (10) 2-Methoxy-4-allylphenol.
 (11) 2-Methoxy-4-propenylphenol (*cis* and *trans*).
 (12) 3-Hydroxy-4-isopropyltoluene.
 (13) 4-Hydroxy-3-methoxybenzaldehyde.
 (14) 2-Hydroxy-1-methyl-4-isopropylbenzene.
 (15) *o*-Hydroxybenzaldehyde.

- (16) *o*-Hydroxybenzoic acid.
 (17) *o*-Phenylphenol.
 (18) 3 : 4-Dihydroxytoluene.
 (19) Naphthoresorcinol.
 (20) Phenyl salicylate.
 (21) 1 : 2 : 4-Trihydroxybenzene.
 (22) *o*-Hydroxybenzyl alcohol.

TABLE IV,114A.

ENOLS

Compound	B.P.	M.P.	d_4^{20}	n_D^{20}	Semicarbazone	Pyrazolone
Acetylacetone	139°	—	0·977	1·452	—	100°*
Methyl acetoacetate	170	—	1·077	1·419	152°	127
Methyl methylacetoacetate	177	—	1·030	1·418	138	120
Ethyl acetoacetate	180	—	1·028	1·419	129d	127
Ethyl methylacetoacetate	181	—	1·006	1·419	86	120
Methyl ethylacetoacetate	189	—	0·989	—	98	108
Acetylacetone	194	—	0·974	1·428	220	92
Ethyl ethylacetoacetate	198	—	0·972	1·422	154d	108
Ethyl acetonedicarboxylate	250d	—	1·113	—	95	85
Ethyl benzoylacetate	265d	—	1·117	—	125	63
Ethyl oxalacetate	131°/24	—	1·131	1·454	162	—
Benzoylacetone	261	61°	—	—	—	63
Dibenzoylmethane	—	78	—	—	—	137

* 1-(*p*-Nitrophenyl)-3:5-dimethylpyrazole: with aqueous solution of *p*-nitrophenylhydrazine hydrochloride. Phenylhydrazine yields a liquid pyrazole, b.p. 273°.

AROMATIC ALDEHYDES

Aromatic aldehydes may be prepared :—

1. By side-chain chlorination of the hydrocarbon (Section IV,23), followed by hydrolysis of the dichloro compound, say, with water at 95–100° in the presence of iron as a catalyst, for example :

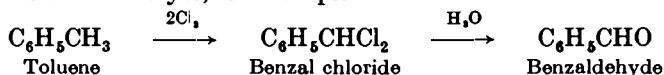

p-Bromobenzaldehyde may be prepared by an analogous method :

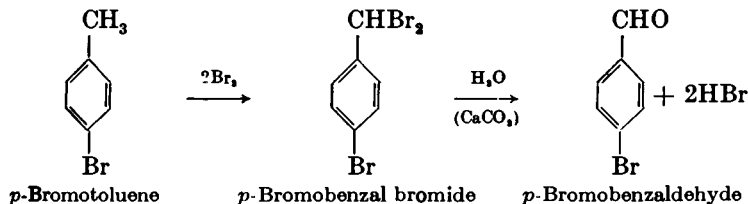

2. By oxidation of the methyl derivative of an aromatic hydrocarbon with a solution of chromic anhydride in acetic anhydride and acetic acid. The aldehyde formed is immediately converted into the *gem*-diacetate, which is stable to oxidation. The diacetate is collected and hydrolysed with sulphuric acid, for example :

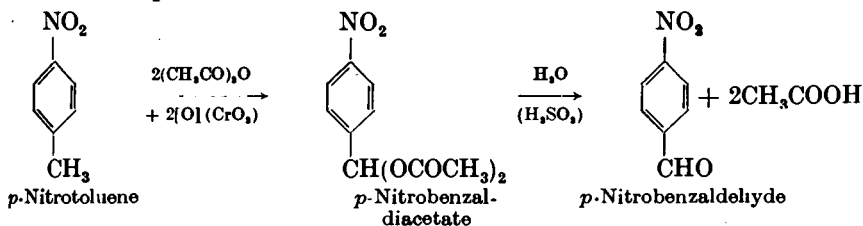

Similarly, *p*- or *o*-bromotoluene \rightarrow *p*- or *o*-bromobenzaldehyde diacetate \rightarrow *p*- or *o*-bromobenzaldehyde.

3. By passing a mixture of carbon monoxide and hydrogen chloride into the aromatic hydrocarbon in the presence of a mixture of cuprous chloride and aluminium chloride which acts as a catalyst (**Gattermann - Koch reaction**). The mixture of gases probably reacts as the equivalent of the unisolated acid chloride of formic acid (formyl chloride) :

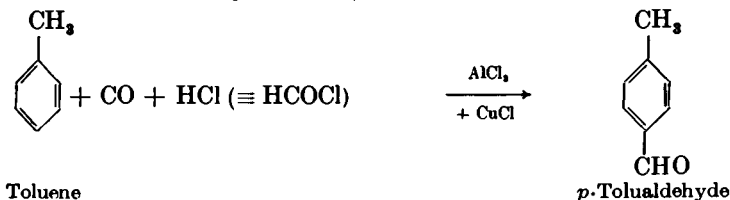

The Gattermann-Koch formylation was found unsuited to the preparation of aldehydes from phenols and phenol ethers : such aldehydes may be obtained by Gattermann's aldehyde reaction.

4. By interaction of hydrogen cyanide and hydrogen chloride with an aromatic compound (hydrocarbon, phenol or phenol ether) in the presence of aluminium chloride (or zinc chloride). This is known as the **Gattermann**

aldehyde reaction. The simplest (but not strictly accurate) formulation of the reaction is :

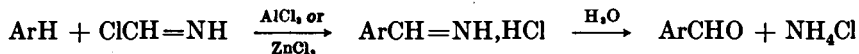
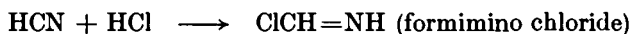

It is more likely that the HCN and HCl react to give chloromethyleneformamidine (I), which is the active intermediate :

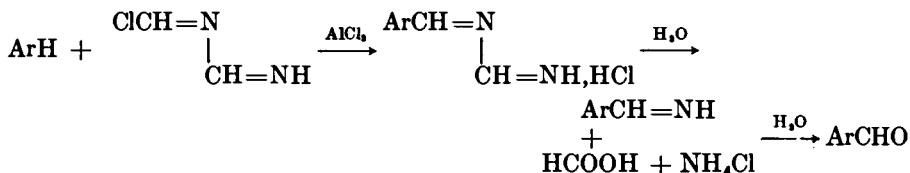

The use of the hazardous hydrogen cyanide may be avoided (R. Adams) by passing dry hydrogen chloride either into a mixture of zinc cyanide, aluminium chloride, the hydrocarbon or phenol ether and a solvent (such as tetrachloroethane or benzene), or into a mixture of zinc cyanide, the phenol and anhydrous ether or benzene. The zinc cyanide is converted by the hydrogen chloride into hydrogen cyanide (which reacts *in situ*) and zinc chloride (which is known to be an effective condensation reagent in this reaction). The following examples are given :

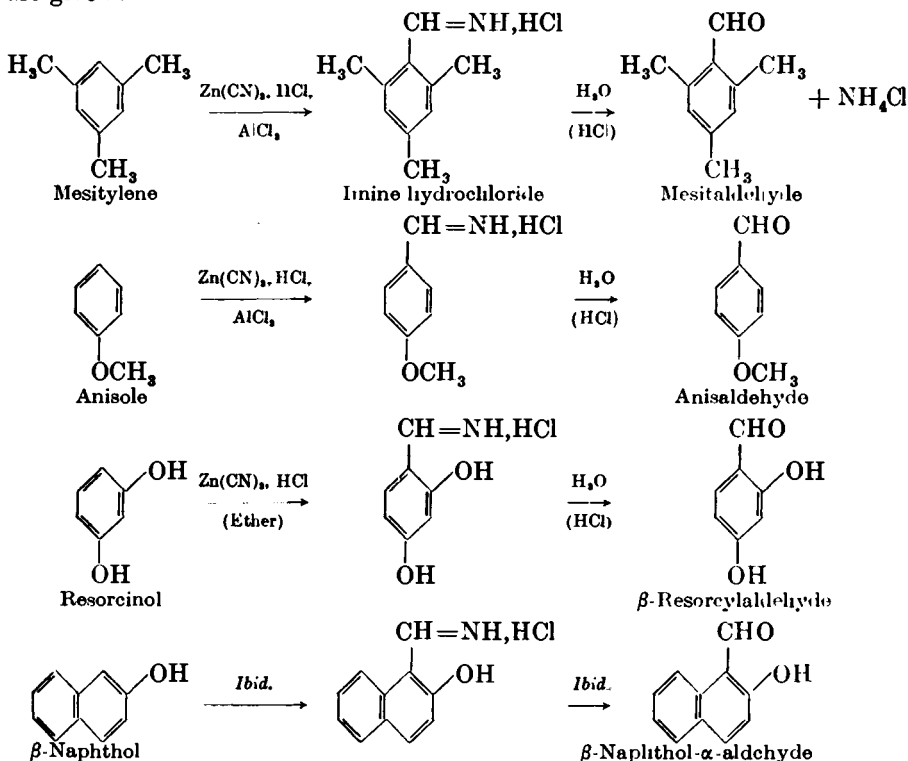

5. From acid chlorides by selective hydrogenation in the presence of a catalyst (palladium deposited upon a carrier, which is usually barium sulphate but is

occasionally charcoal). The reaction is known as the **Rosenmund reduction**, and has been widely applied in the aromatic and heterocyclic series :

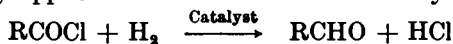

The procedure is to pass purified hydrogen through a hot solution of the pure acid chloride in toluene or xylene in the presence of the catalyst; the exit gases are bubbled through water to absorb the hydrogen chloride, and the solution is titrated with standard alkali from time to time so that the reduction may be stopped when the theoretical quantity of hydrogen chloride has been evolved. Further reduction would lead to the corresponding alcohol and hydrocarbon :

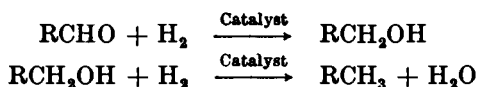

and to products produced by their interaction with acid chlorides. It is generally considered that the reduction of the aldehyde can be prevented by the use of an appropriate catalyst "poison" or "regulator", which inactivates the catalyst towards the reduction of the aldehyde but not to the acid chloride. The "poison" usually contains sulphur, *e.g.*, "quinoline-sulphur" or thiourea. Such a regulator is not always necessary and it has been stated that the decisive factors are to keep the temperature near the lowest point at which hydrogen chloride is liberated and to arrest the reaction as soon as one mol of hydrogen chloride is evolved. The reduction is illustrated by :

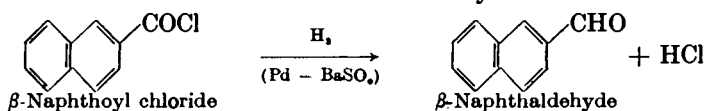

6. From nitriles by **Stephen's reaction** (see under *Aliphatic Aldehydes* and Section III,64), for example :

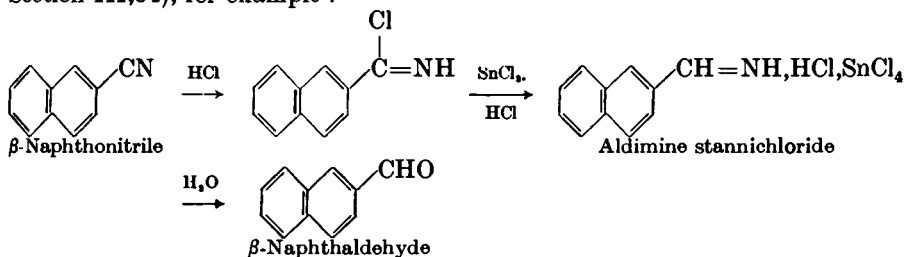

7. From phenols by interaction with chloroform and sodium hydroxide solution (**Reimer - Tiemann reaction**), for example :

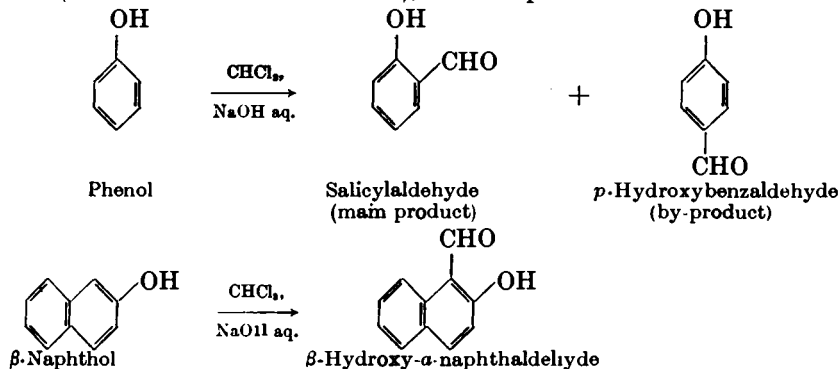

This reaction, applicable only to the preparation of hydroxy-aldehydes, is alternative to the Gattermann aldehyde reaction (or the Adams modification of it) given under 4. The yields are usually smaller, but a large quantity of the phenol may be recovered. The following *mechanism* is consistent with the known facts :

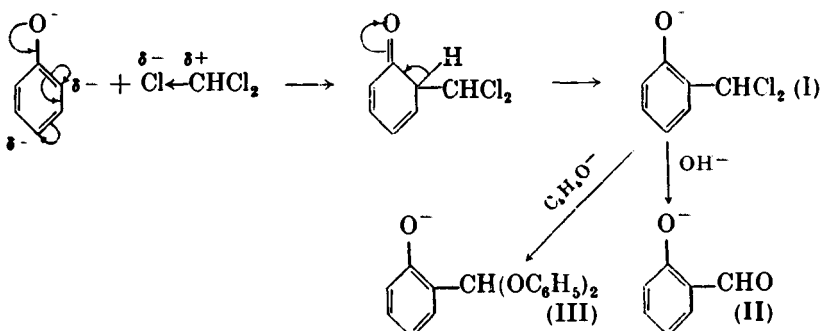

In the strongly basic medium, the reactant is the phenoxide ion ; high nucleophilic activity at the *ortho* and *para* positions is provided through the electro-meric shifts indicated. The above scheme indicates the *ortho* substitution : the *para* substitution is similar. The intermediate *o*-hydroxybenzyl chloride anion (I) may react either with a hydroxide ion or with water to give the anion of salicylaldehyde (II), or with phenoxide ion or with phenol to give the anion of the diphenylacetal of salicylaldehyde (III). Both these anions are stable in basic solution. Upon acidification (III) is hydrolysed to salicylaldehyde and phenol ; this probably accounts for the recovery of much unreacted phenol from the reaction.

8. From chloromethyl or bromomethyl aromatic compounds by heating with hexamethylenetetramine (hexamine) in aqueous alcohol or aqueous acetic acid. A quaternary ammonium compound is formed, which yields the aldehyde upon treatment with water in the presence of hexamine ; for example

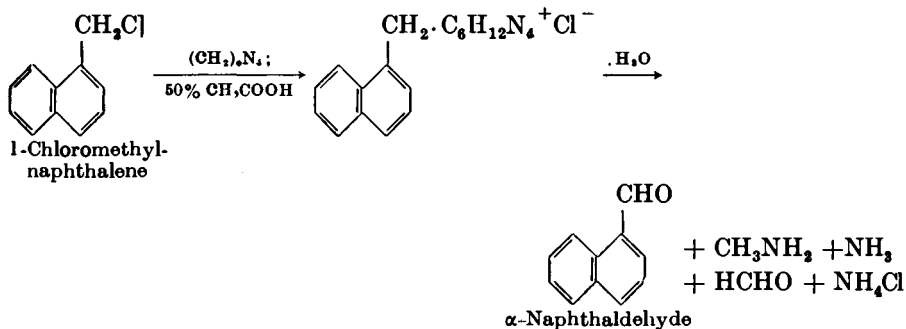

The process whereby aldehydes are produced from arylmethyl (also alkyl and other) halides by the action of hexamine is known as the *Sommelet reaction*. The reaction is essentially the conversion of an amine into an aldehyde ; the hexamine serves the dual role of converting the halide into the amine and the amine into the aldehyde, but its function is different in the two steps. When starting from a halide, the reaction proceeds in three stages :—

(1) The formation of a hexamine salt :

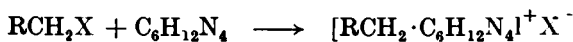

and wash it with a little ether. Immediately transfer the bisulphite compound to a separatory funnel and decompose it with a slight excess of sodium carbonate solution. Extract the liberated benzaldehyde with ether, wash the ethereal extract successively with sodium carbonate solution and water, dry with anhydrous magnesium sulphate or calcium chloride. Remove the ether on a water bath using the apparatus shown in Fig. II, 13, 4, and distil the residue. Collect the benzaldehyde at 178–180°. The yield is 25 g.

Notes.

- (1) A little iron powder or ferric benzoate can be used as a catalyst.
- (2) If the clear filtrate in the flask is strongly acidified with concentrated hydrochloric acid and then allowed to cool, benzoic acid (a by-product of the reaction) separates in glistening plates. Filter at the pump, and recrystallise from hot water; m.p. 121°.

ALTERNATIVE PREPARATION

Purification of commercial benzaldehyde.* Wash 50 g. (48 ml.) of technical benzaldehyde in a separatory funnel with 20 ml. portions of 10 per cent. sodium carbonate solution until no further carbon dioxide is evolved, then with water, and dry over 5 g. of anhydrous magnesium sulphate or calcium chloride. Add 0.5 g. of hydroquinone or catechol (1) during the drying operation. Decant through a small fluted filter paper (or through a *small* plug of cotton wool) into a 100 ml. Claisen flask, and distil under reduced pressure (Fig. II, 19, 1) (2). Collect the benzaldehyde over a 2° range, *i.e.*, 1° on either side of the true b.p. The correct b.p. under the diminished pressure obtained in the apparatus may be interpolated from the following boiling point data : 79°/25 mm. ; 69°/15 mm. ; 62°/10 mm. Place about 0.05 g. of hydroquinone or catechol in the product (1).

Notes.

- (1) Benzaldehyde is easily oxidised by atmospheric oxygen giving, ultimately, benzoic acid. This auto-oxidation is considerably influenced by catalysts ; these are considered to react with the unstable "peroxide" complexes which are the initial products of the oxidation. Catalysts which inhibit or retard auto-oxidation are termed anti-oxidants, and those that accelerate auto-oxidation are called pro-oxidants. Anti-oxidants find important applications in preserving many organic compounds, *e.g.*, acrolein. For benzaldehyde, hydroquinone or catechol (considerably less than 0.1 per cent. is sufficient) are excellent anti-oxidants.
- (2) A very fine capillary tube should be used. It is better to conduct the distillation in a stream of an inert gas, such as hydrogen or nitrogen.

IV,116.

p-BROMOBENZALDEHYDE

Equip a 1 litre three-necked flask with a reflux condenser, a mechanical stirrer, and a cork carrying a dropping funnel and a thermometer which reaches nearly to the bottom of the flask ; connect the upper end of the condenser to an absorption trap (Fig. II, 8, 1). Place 100 g. of *p*-bromotoluene (Section IV,62) in the flask and immerse the latter in an oil bath (colourless oil in a large beaker). Heat the bath until the temperature of the stirred *p*-bromotoluene reaches 105°. Illuminate the liquid with

* This provides an excellent exercise in distillation under diminished pressure.

an unfrosted 150-watt tungsten lamp, and add 197 g. (63 ml.) of bromine slowly from the dropping funnel: do not allow a large excess of bromine to accumulate in the reaction mixture. Add about one half of the bromine during 1 hour while the temperature is kept at 105–110°, and add the remainder during 2 hours while the temperature is slowly raised to 135°. Raise the temperature slowly to 150° when all the bromine has been introduced. Transfer the crude *p*-bromobenzal bromide (1) to a 2-litre flask, mix it intimately with 200 g. of precipitated calcium carbonate, and then add about 300 ml. of water. Attach a reflux condenser to the flask, heat the mixture first on a water bath and then on a wire gauze over a free flame with continuous shaking until the liquid boils (2); reflux the mixture for 15 hours to complete the hydrolysis. Steam distil the reaction mixture rapidly (3); collect the first one litre of distillate separately, filter off the product, and dry in a vacuum desiccator. 60 G. of pure *p*-bromobenzaldehyde, m.p. 56–57°, are thus obtained. Collect a further 2 litres of distillate (4); this yields about 15 g. of a less pure product, m.p. 52–56°. Purify this by trituration with saturated sodium bisulphite solution (2 ml. per gram) and, after about 3 hours, filter off the pasty mixture at the pump, wash it with alcohol, and then with ether. Transfer the bisulphite compound to a flask fitted for steam distillation (Fig. II, 40, 1), add excess of sodium carbonate solution, and isolate the aldehyde by steam distillation; 13 g. of *p*-bromobenzaldehyde, m.p. 56–57°, are thus collected.

Notes.

(1) This compound is a lachrymator and also produces a burning sensation on the skin; the latter is relieved by washing the affected parts with alcohol.

(2) This gradual heating reduces the risk of breaking the flask.

(3) The best results are obtained by conducting the steam distillation in a large three-necked flask (compare Fig. II, 41, 1) provided with a glycerine-sealed mechanical stirrer in the central aperture; the aldehyde distils slowly unless the mixture is well stirred.

(4) If the solution in the flask is acidified with hydrochloric acid, about 8 g. of crude *p*-bromobenzoic acid may be isolated.

IV,117.

p-NITROBENZALDEHYDE

Equip a 1 litre three-necked flask with a mechanical stirrer and a thermometer, and immerse the flask in a bath of ice and salt. Place 306 g. (283 ml.) of acetic anhydride, 300 g. (285 ml.) of glacial acetic acid and 25 g. of *p*-nitrotoluene in the flask, and add slowly, with stirring, 42·5 ml. of concentrated sulphuric acid. When the temperature has fallen to 5°, introduce 50 g. of A.R. chromic anhydride in small portions at such a rate that the temperature does not rise above 10°; continue the stirring for 10 minutes after all the chromium trioxide has been added. Pour the contents of the flask into a 3 litre beaker two-thirds filled with crushed ice and almost fill the beaker with cold water. Filter the solid at the pump and wash it with cold water until the washings are colourless. Suspend the product in 250 ml. of cold 2 per cent. sodium carbonate solution and stir mechanically for 10–15 minutes; filter (1), wash with cold water, and finally with 10 ml. of alcohol. Dry in a vacuum desiccator; the yield of crude *p*-nitrobenzal diacetate is 25 g. (2).

Reflux a mixture of 22.5 g. of crude *p*-nitrobenzal diacetate, 50 ml. of alcohol, 50 ml. of water and 5 ml. of concentrated sulphuric acid for 30 minutes, filter through a fluted paper, and cool the filtrate in ice. Collect the crystals by suction filtration, wash with cold water, and dry in a vacuum desiccator. The yield of *p*-nitrobenzaldehyde, m.p. 106° is 12 g. (3).

Notes.

(1) Upon acidification of the sodium carbonate washings, 4–5 g. of *p*-nitro benzoic acid, m.p. 242–243°, are recovered.

(2) The pure diacetate may be isolated by dissolving in 75 ml. of hot alcohol, filtering from any insoluble impurities and allowing to cool: 23 g., m.p. 125–126°, are obtained.

(3) By diluting the filtrate with 150 ml. of water, a further 1 g. of the aldehyde may be isolated.

COGNATE PREPARATIONS

***o*-Nitrobenzaldehyde.** Use 25 g. of *o*-nitrotoluene and the same quantities of the other reactants as for *p*-nitrobenzaldehyde. During the addition of the chromium trioxide (1–2 hours), do not allow the temperature to rise above 10°: at higher temperatures, the reaction may become violent. Continue the stirring for a further 5 hours; a powerful stirrer should be used since a hard, tarry mass is formed in the oxidation. Pour the reaction mixture into a 3-litre beaker two-thirds full of crushed ice. Add 500 g. of crushed ice and 50 ml. of water to the reaction flask, break up the mass with a spatula, and add the suspension to the contents of the 3-litre beaker. Stir the mixture in the beaker vigorously until all the oily layer has solidified. Filter the somewhat oily solid at the pump, wash well with cold water, suspend the solid in 250 ml. of cold 2 per cent. sodium carbonate solution, and stir mechanically; filter again, wash with cold water, and dry in the air. To remove any unchanged *o*-nitrotoluene, digest the crude substance with 75 ml. of light petroleum (b.p. 60–80°) for 30 minutes, cool and filter. Dry in a vacuum desiccator. The yield of *o*-nitrobenzal diacetate, m.p. 87–88°, is 11 g.

Heat a suspension of 22 g. of the diacetate in a mixture of 120 ml. of concentrated hydrochloric acid, 190 ml. of water and 35 ml. of alcohol under reflux for 45 minutes. Cool the mixture to 0°, filter the solid with suction, and wash with water. Purify the crude aldehyde by rapid steam distillation (Fig. II, 41, 3); collect about 1500 ml. of distillate during 15 minutes, cool, filter, and dry in a vacuum desiccator over calcium chloride. The yield of pure *o*-nitrobenzaldehyde, m.p. 44–45°, is 10 g. The crude solid may also be purified after drying either by distillation under reduced pressure (the distillate of rather wide b.p., e.g., 120–144°/3–6 mm., is quite pure) or by dissolution in toluene (2–2.5 ml. per gram) and precipitation with light petroleum, b.p. 40°–60° (7 ml. per ml. of solution).

***p*-Bromobenzaldehyde.** Use 31 g. of *p*-bromotoluene (Section IV, 62) and proceed exactly as for *p*-nitrobenzaldehyde. The yield of crude *p*-bromobenzal diacetate, m.p. 90–92°, is 30 g.; upon recrystallisation from 75 ml. of hot alcohol, 24.5 g. of the pure diacetate, m.p. 95°, are obtained. Hydrolyse the crude product (22.5 g.) with 75 ml. of alcohol,

50 ml. of water and 5 ml. of concentrated sulphuric acid, filter the hot solution through a fluted filter paper, cool, collect the crystals and dry in a vacuum desiccator. The yield of *p*-bromobenzaldehyde, m.p. 56-57°, is 18 g.

IV,118.

p-TOLUALDEHYDE *

Set up the apparatus depicted in Fig. IV, 118, 1 in a fume cupboard. The narrow wide-mouthed reaction vessel *A* has a capacity of about 250 ml. and is equipped with a rubber stopper carrying a mercury-sealed

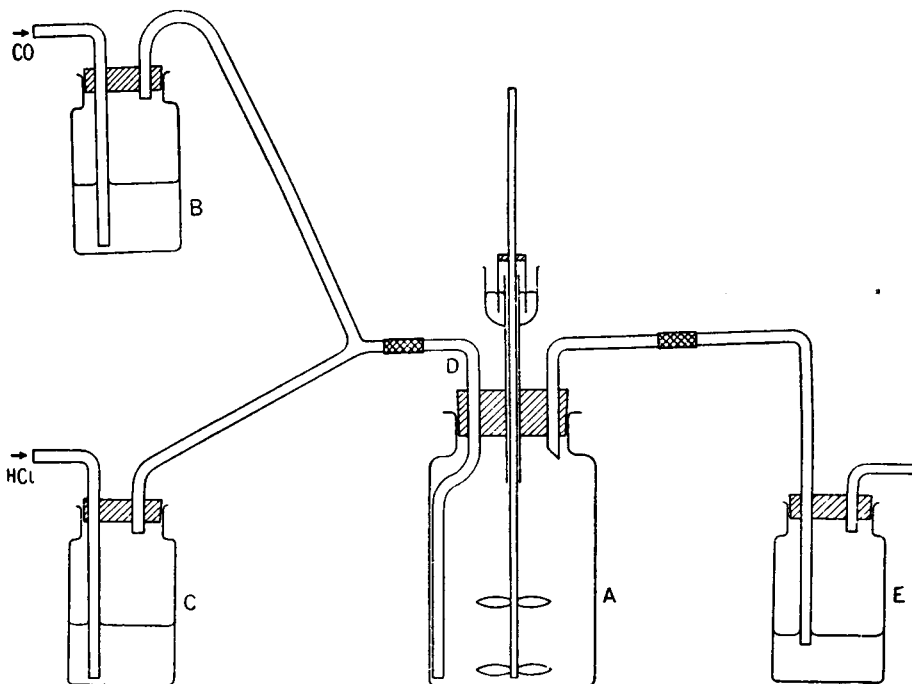

Fig. IV, 118 1.

stirrer, an inlet tube for admitting a mixture of gases, and an outlet tube connected to the wash bottle *E* containing concentrated sulphuric acid. Place 100 g. (115.5 ml.) of pure toluene, 15 g. of dry cuprous chloride (Section II,50,1) and 133.5 g. of finely-powdered anhydrous aluminium chloride in the bottle *A*, and stir the mixture vigorously. Immerse the bottle in a water bath at 20°. Pass a mixture of carbon monoxide (Section II,48,9) and hydrogen chloride (Section II,48,1) into the bottom of the reaction vessel through the tube *D* at a not too rapid but uniform rate (1) during 7 hours: adjust the rates of flow so that the volume of carbon monoxide is about twice that of the hydrogen chloride by observing the bubbling in the wash bottles *B* and *C*. The rate of absorption can be estimated from the bubbling in *E*. The carbon monoxide is absorbed almost quantitatively at the commencement, but as the mixture

* Also termed *p*-tolylaldehyde.

becomes viscous the absorption is less complete. Transfer the very viscous product gradually and with shaking to a 1500 ml. round-bottomed flask containing 750 g. of crushed ice. Steam distil the resulting mixture until all the aldehyde and unchanged toluene have been driven over. Add 25 ml. of ether to the distillate, and separate the two layers; extract the aqueous layer with 75 ml. of ether. Dry the combined extracts over anhydrous magnesium sulphate or calcium chloride, remove the ether slowly (Fig. II, 13, 4, but with a Claisen flask replacing the distilling flask) and then distil the residue from an air bath. Collect the *p*-tolualdehyde (an almost colourless liquid) at 203–205°. The yield is 65 g. Place a few small crystals of hydroquinone in the product to improve its keeping qualities.

Note.

(1) About 1–2 litres of carbon monoxide should be passed in the course of an hour.

IV,119.

β -NAPHTHALDEHYDE

*Method 1—*from β -Naphthonitrile

Fit a 1 litre three-necked flask with a wide inlet tube reaching nearly to the bottom of the flask, a mechanical stirrer, and a reflux condenser carrying a drying tube. Place 38 g. of anhydrous stannous chloride (Section II,50,11) and 200 ml. of sodium-dried ether in the flask. Saturate the mixture with dry hydrogen chloride (Section II,48,1) while it is slowly stirred; this operation requires about 2·5 hours during which time the stannous chloride forms a viscous lower layer. Replace the gas-inlet tube by a dropping funnel, and by means of it add a solution of 15·3 g. of β -naphthonitrile, m.p. 61–62° (1) in 100 ml. of anhydrous ether rapidly. Remove the dropping funnel and again pass hydrogen chloride into the mixture until it is saturated; continue to stir rapidly for 1 hour, and allow to stand overnight.

Decant the ethereal solution from the yellow aldimine stannichloride which has separated, rinse the solid with two 50 ml. portions of ether, and transfer the solid to a 2·5 litre flask fitted for steam distillation and immersed in an oil bath at 110–120°. Pass steam through a trap (compare Fig. II, 40, 1, b) to remove condensed water, then through a superheater heated to 260° (Fig. I, 7, 2), and finally into the mixture (2). Continue the passage of dry steam until the aldehyde is completely removed (4–5 litres; 8–10 hours). Filter the white solid at the pump, and dry in the air. The resulting β -naphthaldehyde, m.p. 53–54°, weighs 12 g. It may be further purified by distillation under diminished pressure (Fig. II, 19, 1); pour the colourless distillate, b.p. 156–158°/15 mm., while hot into a mortar and powder it when cold. The m.p. is 57–58°, and the recovery is over 90 per cent.

Notes.

(1) The substance may be obtained from β -naphthylamine (Section IV,38) by the procedure described under *p*-Tolunitrile (Section IV,66).

(2) The use of dry, superheated steam, although not essential, considerably reduces the time of distillation.

Method 2—from β -Naphthoyl Chloride

Fit a 250 ml. three-necked flask, equipped with ground glass joints (Fig. II, 56, 14), with a reflux condenser, a high-speed mercury-sealed stirrer (1), and a gas inlet tube extending to a point just above the bottom of the stirrer. Place 28.5 g. of β -naphthoyl chloride (2), 100 ml. of sodium-dried xylene, 3 g. of palladium-barium sulphate catalyst (3), and 0.3 ml. of the stock poison solution (4) in the flask. Connect the top of the condenser by a rubber tube to a 6 mm. glass tube extending to the bottom of a 250 ml. conical flask containing 200 ml. of distilled water and a few drops of phenolphthalein indicator; arrange a burette charged with *ca.* *N* sodium hydroxide solution (prepared from the A.R. solid) for delivery into the flask. Place the flask at least 2-3 feet away from any flame for the sake of safety.

Displace the air in the reaction flask with hydrogen, heat the flask in an oil bath at 140-150° and stir the mixture vigorously. Follow the course of the reaction by the rate of hydrogen chloride evolution. The first 25 ml. of alkali should be neutralised in 12-15 minutes, and the reaction should be complete in about 2 hours. About 92 per cent. of the theoretical amount of hydrogen chloride (\equiv 142.5 ml. of *N*-NaOH solution) is recovered; the end of the reaction is indicated by a rather abrupt cessation of hydrogen chloride evolution. Cool the flask, add 1 g. of decolourising carbon with stirring, and filter the solution with suction through a hardened filter paper in order to recover the palladium (5). Distil off the xylene using a 50-75 ml. Claisen flask with fractionating side arm (for general form of apparatus, see Fig. II, 13, 4) and an air bath. (Fig. II, 5, 3). Then distil under reduced pressure (Fig. II, 19, 1) with the aid of an oil bath: a small fraction, consisting largely of naphthalene, passes over first, followed by β -naphthaldehyde at 147-149°/11 mm. (temperature of bath, 170-180°). This (19 g.) solidifies on cooling to a white solid, m.p. 59-60° (compare preceding Section).

Notes.

(1) Rapid stirring is desirable in order to obtain the maximum reaction rate; absorption of hydrogen occurs chiefly at the rapidly agitated surface. The vigorous stirring may cause spraying of fine droplets of mercury from the seal; this can be prevented either by covering the mercury with a layer of paraffin oil or by using the seal shown in Fig II, 7, 9, c.

(2) β -Naphthoyl chloride may be prepared from β -naphthoic acid (Section IV, 164) in the following manner. Warm a mixture of 57.4 g. of acid and 69 g. of phosphorus pentachloride in a 250 ml. Claisen flask with fractionating side arm (Figs. II, 24, 2-3) on a water bath in the fume cupboard. As soon as the vigorous reaction commences, remove the flask from the water bath until the rapid evolution of hydrogen chloride subsides, then heat on a water bath for 30 minutes. Distil under reduced pressure using a water pump to remove the phosphorus oxychloride; an oil pump may then be substituted. Collect the fraction, b.p. 160-162°/11 mm.; this solidifies on cooling to a colourless solid, m.p. 51-52°. The yield of β -naphthoyl chloride is 60 g.

(3) The palladium-barium sulphate catalyst is prepared by treating a suspension of 20 g. of barium sulphate (which has been precipitated in hot solution) in 400 ml. of hot water with a solution of 1.7 g. of palladium chloride (equivalent to 1.0 g. of palladium) in 50 ml. of water and with 1.5 ml. of 40 per cent. formaldehyde solution. The mixture is rendered faintly alkaline to litmus by the addition of sodium hydroxide solution and then boiled for a short time. When the supernatant liquid is clear, the grey precipitate is filtered off, and washed with hot water until the

washings are neutral in reaction. The catalyst is then dried in a vacuum desiccator over solid sodium or potassium hydroxide, then finely ground in a glass mortar, and preserved in a well-stoppered bottle.

(4) The stock solution of quinoline-sulphur poison is prepared by refluxing 1 g. of sulphur with 6 g. of quinoline for 5 hours and diluting the resulting brown liquid to 70 ml. with xylene which has been purified by distilling over anhydrous aluminium chloride. The addition of the quinoline-sulphur poison ensures that the reduction does not proceed beyond the aldehyde stage; it merely slows up the reaction and has no harmful effects.

It has been stated that thiourea (about 20 per cent. of the weight of the palladium-barium sulphate) may also be used as a catalyst poison.

(5) The palladium may be recovered by heating the spent catalyst to redness in order to remove organic impurities; this treatment may reduce some of the barium sulphate to barium sulphide, which acts as a catalytic poison. The palladium is then dissolved out with *aqua regia* and the solution evaporated; the residue is dissolved in hot water and hydrochloric acid to form palladium chloride.

IV,120 α -NAPHTHALDEHYDE (*Sommelet Reaction*)

In a 500 ml. flask, fitted with a reflux condenser, place 53 g. of 1-chloromethylnaphthalene (Section IV,23), 84 g. of hexamethylenetetramine and 250 ml. of 1 : 1 acetic acid [*CAUTION*: 1-Chloromethylnaphthalene and, to a lesser degree, α -naphthaldehyde have lachrymatory and vesicant properties; adequate precautions should therefore be taken to avoid contact with these substances.] Heat the mixture under reflux for 2 hours; it becomes homogeneous after about 15 minutes and then an oil commences to separate. Add 100 ml. of concentrated hydrochloric acid and reflux for a further 15 minutes; this will hydrolyse any Schiff's bases which may be formed from amine and aldehyde present and will also convert any amines into the ether-insoluble hydrochlorides. Cool, and extract the mixture with 150 ml. of ether. Wash the ether layer with three 50 ml. portions of water, then cautiously with 50 ml. of 10 per cent. sodium carbonate solution, followed by 50 ml. of water. Dry the ethereal solution with anhydrous magnesium sulphate, remove the ether by distillation on a steam bath, and distil the residue under reduced pressure. Collect the α -naphthaldehyde at 160–162°/18 mm.; the yield is 38 g.

COGNATE PREPARATIONS

***p*-Nitrobenzaldehyde.** This preparation is an example of the *Sommelet* reaction in which the hexaminium salt is isolated. Dissolve 11 g. of hexamine in 70 ml. of chloroform and add 11.4 g. of *p*-nitrobenzyl chloride or 14.4 g. of *p*-nitrobenzyl bromide (Section VII,13). Heat the mixture under reflux on a steam bath for 4 hours; a precipitate gradually separates. Replace the reflux condenser by a condenser set for distillation and distil off about 35 ml. of solvent. Add 35 ml. of acetone, cool in ice, collect the precipitate by suction filtration, and dry it in the air. Heat the hexaminium salt thus obtained under reflux for 1 hour with 100 ml. of 50 per cent. acetic acid; then add 100 ml. of water and 25 ml. of concentrated hydrochloric acid and continue the refluxing for 5–10 minutes. Cool the solution in ice, collect, the crystals of *p*-nitrobenzaldehyde and dry them in a vacuum desiccator. The yield is 6.4 g., m.p. 106°.

β -Naphthaldehyde. This preparation illustrates the use of *N*-bromosuccinimide (Section VI,26) in the conversion of the readily available β -methylnaphthalene into 2-bromomethylnaphthalene and of the latter into β -naphthaldehyde by the Sommelet reaction.

Dissolve 71 g. of β -methylnaphthalene in 450 g. (283 ml.) of A.R. carbon tetrachloride and place the solution in a 1-litre three-necked flask equipped with a mechanical stirrer and reflux condenser. Introduce 89 g. of *N*-bromosuccinimide through the third neck, close the latter with a stopper, and reflux the mixture with stirring for 16 hours. Filter off the succinimide and remove the solvent under reduced pressure on a water bath. Dissolve the residual brown oil (largely 2-bromomethylnaphthalene) in 300 ml. of A.R. chloroform, and add it to a rapidly stirred solution of 84 g. of hexamine in 150 ml. of A.R. chloroform contained in a 2-litre three-necked flask, fitted with a reflux condenser, mechanical stirrer and dropping funnel: maintain the rate of addition so that the mixture refluxes vigorously. A white solid separates almost immediately. Heat the mixture to reflux for 30 minutes, cool and filter. Wash the crystalline hexaminium bromide with two 100 ml. portions of light petroleum, b.p. 40–60°, and dry; the yield of solid, m.p. 175–176°, is 147 g. Reflux the hexaminium salt for 2 hours with 750 ml. of 50 per cent. acetic acid, add 150 ml. of concentrated hydrochloric acid, continue the refluxing for 5 minutes more, and cool. Extract the aldehyde from the solution with ether, evaporate the ether, and recrystallise the residue from hot *n*-hexane. The yield of β -naphthaldehyde, m.p. 59–60°, is 50 g.

IV,121.

MESITALDEHYDE

Equip a 500 ml. three-necked flask with a reflux condenser, an efficient stirrer, and a gas-inlet tube and a thermometer. The last-named is fitted into one neck of the flask by a device similar to that shown in Fig. II, 7, 12, *b*; the thermometer in the gas-inlet tube should have the bulb well immersed in the liquid, but the inlet tube need extend only just below the surface. Set up the apparatus in the fume cupboard because both hydrogen cyanide and tetrachloroethane are toxic. Place 51 g. (59 ml.) of redistilled mesitylene (b.p. 163–166°), 73.5 g. of zinc cyanide (1) and 200 ml. of tetrachloroethane in the flask, and stir the mixture while a rapid stream of dry hydrogen chloride (Section II,48,1) is passed through it until the zinc cyanide is decomposed (about 3 hours). Immerse the flask in a bath of crushed ice, remove the inlet tube and replace it by means of the arrangement depicted in Fig. II, 7, 12, *c* (or *d*), having previously charged the conical flask with 197 g. of finely-ground, anhydrous aluminium chloride. Stir the mixture *very vigorously* and add the aluminium chloride over a period of 10 minutes. Remove the ice bath, and resume the passage of hydrogen chloride gas for 3.5 hours; the heat of reaction will raise the temperature to about 70° at the end of an hour. Maintain the temperature at 67–72° for the remainder of the reaction period. Cool, and pour the reaction mixture, with hand stirring, into a 2 litre beaker about half-full of crushed ice to which 50 ml. of concentrated hydrochloric acid has been added. Allow to stand overnight, transfer to a 1.5 litre round-bottomed flask, fit a condenser and

reflux for 3 hours. Allow to cool, separate the organic layer, and extract the aqueous layer once with 25 ml. of tetrachloroethane. Wash the combined tetrachloroethane solutions with 75 ml. of 10 per cent. sodium carbonate solution, and steam distil (Fig. II, 40, 1). Set the first 400-450 ml. of distillate aside for the recovery of the solvent (2), and collect the second portion (about 4.5 litres) as long as oily drops pass over. Extract the distillate with 250 ml. of benzene, dry the extract with a little anhydrous magnesium sulphate, and remove the solvent on a water bath. Distil the residue from a 150 ml. Claisen flask with fractionating side arm (Fig. II, 24, 2-5), and collect the mesitaldehyde at 118-121°/16 mm.; the yield is 50 g. (3).

Notes.

(1) Commercial zinc cyanide is quite satisfactory. It may be prepared as described in Section II, 50, 18. If the zinc cyanide is too highly purified, it does not react well.

(2) The first portion of the steam distillate consists almost entirely of tetrachloroethane and water. The solvent is recovered by separating the organic layer, drying with anhydrous calcium chloride or magnesium sulphate and distilling.

(3) The following procedure is more convenient and less time-consuming, but the yield is lower (about 40 g.). Mix the powdered aluminium chloride and zinc cyanide by shaking, add the mesitylene, and immerse the flask in an oil bath at 100°. Stir the mixture and pass in a fairly rapid stream of dry hydrogen chloride for 4 hours; continue the heating and stirring for a further 2 hours, but discontinue the passage of the gas. Decompose the reaction mixture, and complete the preparation as above.

COGNATE PREPARATIONS

β -Resorcylaldehyde (2 : 4-dihydroxybenzaldehyde). Equip a 500 ml. three-necked flask (or wide-mouthed bottle) with a reflux condenser, a mercury-sealed stirrer, and a wide inlet tube (to prevent clogging by the precipitate) extending nearly to the bottom of the vessel. Attach the inlet tube to an empty (safety) wash bottle and to this a generator producing hydrogen chloride (Section II, 48, 1); connect the top of the condenser by means of a tube to a wash bottle containing concentrated sulphuric acid, then to an empty bottle, and finally to the surface of sodium hydroxide solution (Fig. II, 8, 1, a). Place 20 g. of resorcinol, 175 ml. of sodium-dried ether, and 40 g. of powdered anhydrous zinc cyanide (Section II, 50, 18) in the flask, start the stirrer and pass in a rapid stream of hydrogen chloride. The zinc cyanide gradually disappears with the formation of a cloudy solution; further passage of hydrogen chloride results in the separation of the imide hydrochloride condensation product as a thick oil which solidifies after 10-30 minutes. When the ether is saturated with hydrogen chloride (after about 1.5 hours), pass the gas more slowly and continue the stirring for a further half an hour to ensure the completeness of the reaction. Decant the ether from the solid material, add 100 ml. of water to the latter, heat to the boiling point, filter the hot solution through a hot water funnel, and allow the filtrate to cool. Filter the resorcylaldehyde (12 g.) which separates as soon as the mixture is cold; allow the filtrate to stand for 15 hours when a further 11.5 g. of the aldehyde is obtained. The β -resorcylaldehyde, after drying, has m.p. 135-136° and is very faintly coloured. The colour may be removed by recrystallisation from hot water with the addition of a little decolourising carbon.

β -Naphthol- α -aldehyde (β -hydroxy- α -naphthaldehyde). Proceed as for β -resorcyaldehyde except that 20 g. of β -naphthol replaces the resorcinol. Recrystallise the crude product (20 g.) from water with the addition of a little decolourising carbon; the pure aldehyde has m.p. 80–81°.

Anisaldehyde (*p*-methoxybenzaldehyde). Use the apparatus described for β -resorcyaldehyde. Place 30 g. (27 ml.) of anisole (Section IV,104), 75 ml. of sodium-dried A.R. benzene, and 52 g. of powdered zinc cyanide in the flask. Cool the mixture in a bath of cold water, start the stirrer, and pass in a rapid stream of hydrogen chloride for 1 hour. Remove the condenser, and without stopping the stirrer, add 45 g. of finely-powdered anhydrous aluminium chloride slowly, replace the condenser, etc. Pass in a slow steam of hydrogen chloride whilst heating the mixture at 40–45° for 3–4 hours. Allow to cool somewhat and pour the reaction mixture with stirring into excess of dilute hydrochloric acid; the imide hydrochloride separates as a heavy precipitate. Reflux the mixture for half an hour in order to decompose the imide hydrochloride and steam distil. Separate the organic layer in the distillate, dry with a little anhydrous magnesium sulphate, and distil off the benzene. Treat the residue, which consists of anisaldehyde together with traces of anisole, with excess of sodium bisulphite solution and extract any unchanged anisole with ether. Decompose the bisulphite compound with sodium hydroxide solution (compare cycloHexanone, Section III,74,A), extract the anisaldehyde with ether, dry and distil. Collect the anisaldehyde at 246–248°; the b.p. under diminished pressure is 134–135°/12 mm. The yield is 35 g.

IV,122.

SALICYLALDEHYDE

Equip a 1 litre three-necked flask with an efficient (double surface) reflux condenser, a mechanical stirrer, and a thermometer, the bulb of which is within 2 cm. of the bottom of the flask. Place a warm solution of 80 g. of sodium hydroxide in 80 ml. of water in the flask, add a solution of 25 g. of phenol in 25 ml. of water, and stir. Adjust the temperature inside the flask to 60–65° (by warming on a water bath or by cooling, as may be found necessary); do not allow the crystalline sodium phenoxide to separate out. Introduce 60 g. (40.5 ml.) of chloroform in three portions at intervals of 15 minutes by means of a dropping funnel fitted into the top of the condenser with a grooved cork (1). Maintain the temperature of the well-stirred mixture at 65–70° during the addition by immersing the flask in hot or cold water as may be required. Finally heat on a boiling water bath for 1 hour to complete the reaction. Remove the excess of chloroform from the alkaline solution by steam distillation (Fig. II, 41, 1). Allow to cool, acidify the orange-coloured liquid cautiously with dilute sulphuric acid, and again steam distil the almost colourless liquid until no more oily drops are collected. Set aside the residue in the flask for the isolation of *p*-hydroxybenzaldehyde. Extract the distillate at once with ether, remove most of the ether from the extract on a water bath (compare Fig. II, 13, 4). Transfer the residue, which contains phenol as well as salicylaldehyde, to a separatory funnel

or small glass-stoppered bottle, add about twice the volume of saturated sodium bisulphite solution, and shake vigorously (preferably mechanically) for at least half an hour, and allow to stand for 1 hour. Filter the paste of bisulphite compound at the pump, wash it with a little alcohol, and finally with a little ether (to remove the phenol). Decompose the bisulphite compound by warming in a round-bottomed flask on a water bath with dilute sulphuric acid, allow to cool, extract the salicylaldehyde with ether, and dry the extract with anhydrous magnesium sulphate. Remove the ether (Fig. II, 13, 4) and distil the residue from an air bath. Collect the salicylaldehyde (a colourless liquid) at 195-197°. The yield is 12 g.

To isolate the *p*-hydroxybenzaldehyde, filter the residue from the steam distillation while hot through a fluted filter paper in order to remove resinous matter, and extract the cold filtrate with ether. Distil off the ether, and recrystallise the yellow solid from hot water to which some aqueous sulphurous acid is added. The yield of *p*-hydroxybenzaldehyde (colourless crystals), m.p. 116°, is 2-3 g.

Note.

(1) If preferred, the chloroform may be added slowly during 30-40 minutes whilst the mixture is stirred and the temperature is maintained at 65-70°.

Purification of commercial salicylaldehyde. When comparatively large quantities of salicylaldehyde are required, it is more economical to purify the relatively inexpensive commercial product. This may be done either through the bisulphite compound (compare Section III, 74, A) or by the following method. Add the commercial salicylaldehyde to a large excess of a luke-warm solution of copper acetate (previously saturated near the boiling point), shake well, and allow to stand several hours in ice. Filter, wash the precipitate thoroughly first with alcohol and then with ether. Decompose the solid with dilute (10 per cent.) sulphuric acid, extract the aldehyde with ether, dry (anhydrous magnesium sulphate), and distil. The yield from a good commercial sample may be as high as 80 per cent.

COGNATE PREPARATION

β -Hydroxy- α -naphthaldehyde. Equip a 1 litre three-necked flask with a separatory funnel, a mercury-sealed mechanical stirrer, and a long (double surface) reflux condenser. Place 50 g. of β -naphthol and 150 ml. of rectified spirit in the flask, start the stirrer, and rapidly add a solution of 100 g. of sodium hydroxide in 210 ml. of water. Heat the resulting solution to 70-80° on a water bath, and place 62 g. (42 ml.) of pure chloroform in the separatory funnel. Introduce the chloroform dropwise until reaction commences (indicated by the formation of a deep blue colour), remove the water bath, and continue the addition of the chloroform at such a rate that the mixture refluxes gently (about 1.5 hours). The sodium salt of the phenolic aldehyde separates near the end of the addition. Continue the stirring for a further 1 hour. Distil off the excess of chloroform and alcohol on a water bath; use the apparatus shown in Fig. II, 41, 1, but retain the stirrer in the central aperture. Treat the residue, with stirring, dropwise with concentrated hydrochloric acid until

the contents of the flask are acid to Congo red paper (about 88 ml. are required); a dark oil, accompanied by a considerable amount of sodium chloride, separates. Add sufficient water to dissolve the salt, extract the oil with ether, wash the ethereal solution with water, dry with anhydrous magnesium sulphate, and remove the solvent. Distil the residue under reduced pressure and collect the slightly coloured aldehyde at 163-166°/8 mm. (or at 177-180°/20 mm.); it solidifies on cooling. Recrystallise the solid from 38 ml. of alcohol. The yield of β -hydroxy- α -naphthaldehyde, m.p. 80°, is 28 g.

CONDENSATION REACTIONS OF AROMATIC ALDEHYDES

1. **Cannizzaro reaction.** Aromatic aldehydes (and other aldehydes in which α -hydrogen atoms are absent, *e.g.*, formaldehyde, trimethylacetaldehyde, and α -hydroxy-*iso*-butyraldehyde) under the influence of strong aqueous or alcoholic alkali undergo simultaneous oxidation and reduction yielding the alcohol and corresponding acid. Thus :—

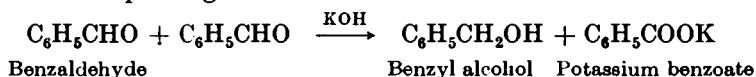

This dismutation or disproportionation reaction is known as the **Cannizzaro reaction**.

The *mechanism* of the reaction probably involves the production, by interaction of the aldehyde with hydroxide ions, of two reducing anions, the first (I) more easily than the second (II). Either of these anions may transfer a hydride ion to a carbonyl carbon atom in another aldehyde molecule :

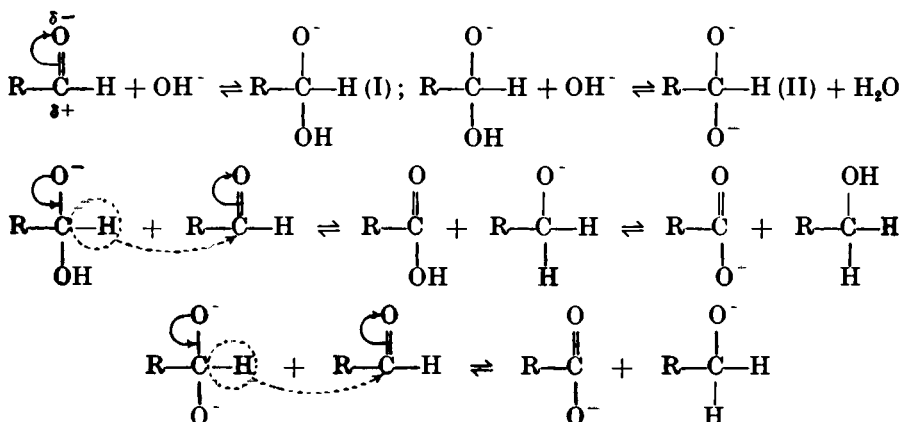

The production of benzyl benzoate from benzaldehyde, which may be isolated under special conditions (low temperature and absence of excess of alkali), is explained by assuming that when some benzyloxy ions ($\text{C}_6\text{H}_5\text{-CH}_2\text{O}^- \equiv \text{RCH}_2\text{O}^-$) are formed in the alkaline solution, these can replace hydroxide ions thus :

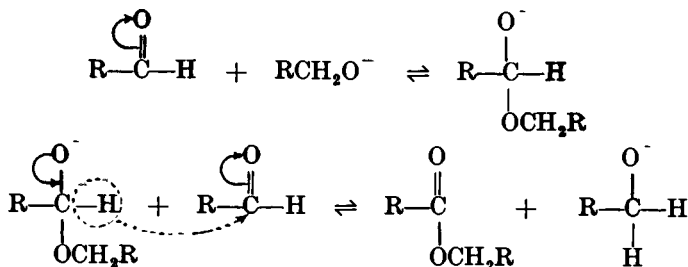

The analogous dismutation of furfural is described in Section V,8. For "crossed Cannizzaro reaction", see discussion following Section IV,199.

2. **Perkin reaction.** The condensation of an aromatic aldehyde with an acid anhydride in the presence of the sodium or potassium salt of the acid

corresponding to the anhydride to yield an $\alpha\beta$ -unsaturated acid is known as the **Perkin reaction**. Thus benzaldehyde when heated with a mixture of acetic anhydride and potassium acetate gives rise to cinnamic acid :

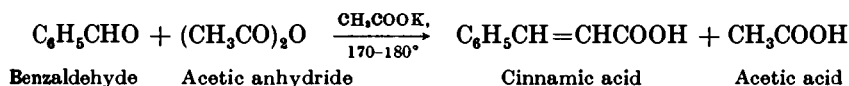

It is interesting to note that although *cis-trans* isomerism about the double bond is theoretically possible in cinnamic acid, the Perkin reaction gives rise only to the *trans* form, m.p. 133° , the *cis* form, m.p. 68° (termed *allo-cinnamic acid*) being unstable and easily converted into the *trans* acid.



Basic catalysts other than alkali acetates have been employed in the Perkin reaction : thus salicylaldehyde condenses with acetic anhydride in the presence of triethylamine to yield coumarin (the lactone of the *cis* form of *o*-hydroxycinnamic acid) together with some of the acetyl derivative of the *trans* form (*o*-acetylcoumaric acid) :

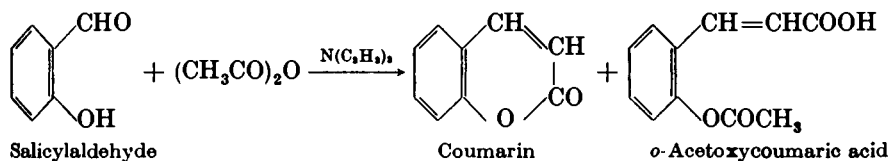

The *mechanism* of the reaction, which is of the aldol type, involves the carbonyl group of the aldehyde and an active methylene group of the anhydride : the function of the basic catalyst B (acetate ion CH_3COO^- or triethylamine $\text{N}(\text{C}_2\text{H}_5)_3$) is to form the anion of the active hydrogen component, *i.e.*, by the extraction of a proton from the anhydride :

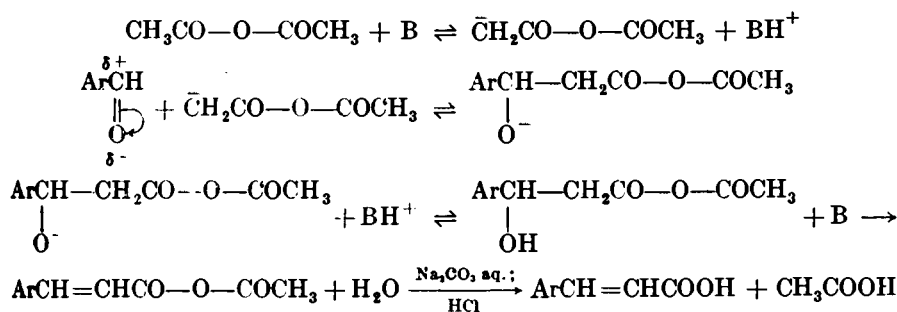

The production of α -phenylcinnamic acid by heating benzaldehyde with acetic anhydride and sodium phenylacetate :

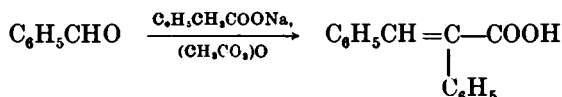

at first sight suggests that condensation occurs between the aldehyde and the sodium salt. The correct interpretation is, however, that at temperatures

above 100° there is a mobile equilibrium between the anhydride and the sodium salt derived from the other acid as follows :

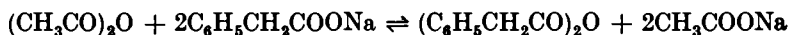

Here the phenylacetic anhydride, possessing more reactive α -hydrogen atoms, condenses with benzaldehyde to give α -phenylcinnamic acid. The preparation of the latter is an example of the **Oglialoro modification** of the Perkin reaction.

The preparation of α -phenylcinnamic acid from benzaldehyde, phenylacetic acid, acetic anhydride and triethylamine is described. Presumably equilibria are set up between phenylacetic acid and acetic anhydride to form phenylacetic anhydride, a mixed anhydride or both :

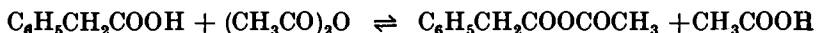

The α -carbon atom of the phenylacetyl group is more susceptible to attack by the basic catalyst (triethylamine) than the acetyl group ; hence α -phenylcinnamic acid, but no cinnamic acid, is obtained.

Phthalic anhydride may be used as the carbonyl compound in the Perkin reaction : see the preparation of phthalylacetic acid under *Ninhydrin* (Section VIII,14).

3. Benzoin condensation. Aromatic aldehydes when treated with an alkali cyanide, usually in aqueous solution, undergo condensation to the α -hydroxyketone or benzoin. The best known example is the conversion of benzaldehyde to benzoin :

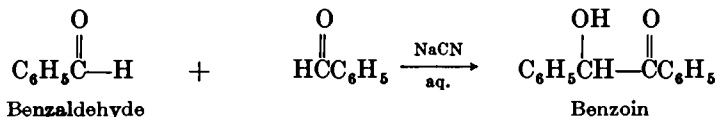

By the use of 1 mol each of two different aldehydes, an unsymmetrical or mixed benzoin is obtained, for example :

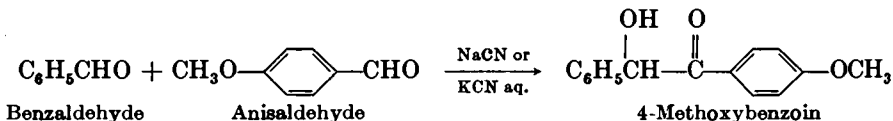

The reaction depends upon the catalytic influence of the cyanide ion, the *mechanism* being probably as follows :

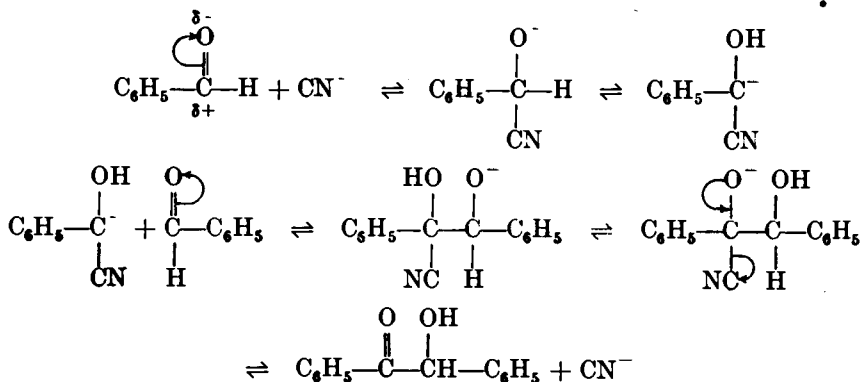

Oxidation of benzoin with concentrated nitric acid or by catalytic amounts of cupric salts in acetic acid solution, which are regenerated continuously by ammonium nitrate, yields the diketone benzil :

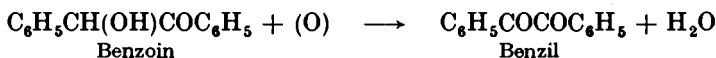

The latter procedure gives a purer product ; it is difficult to remove the last traces of benzoin from the benzil obtained by the nitric acid method.

Benzil (and other α -diketones $\text{Ar}-\text{CO}-\text{CO}-\text{Ar}$) upon refluxing with aqueous-alcoholic potassium hydroxide undergo the **benzilic acid rearrangement**. Thus benzil is converted into a salt of benzilic acid :

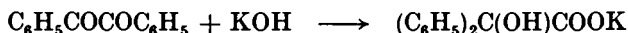

A probable *mechanism* for this rearrangement postulates the intermediate formation of a hydroxide-ion addition complex, followed by the migration of a phenyl group as an anion :

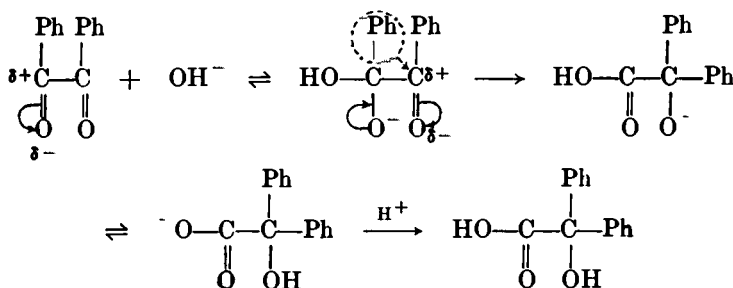

Benzilic acid may be obtained in a high state of purity by the action of an alkaline bromate solution upon benzoin at 85–90° :

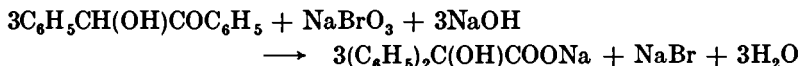

4. Claisen-Schmidt reaction. Aromatic aldehydes condense with aliphatic or mixed alkyl-aryl ketones in the presence of aqueous alkali to form $\alpha\beta$ -unsaturated ketones :

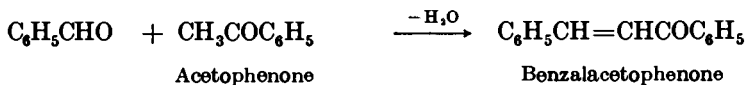
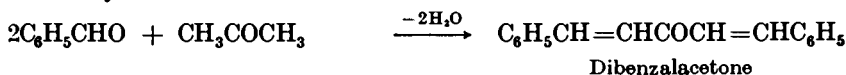
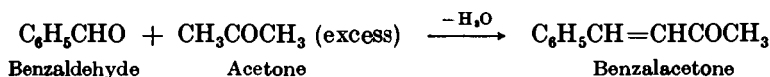

The above are examples of the Claisen - Schmidt reaction. The formation of β -nitrostyrenes by reaction of nitroalkanes with aromatic aldehydes in the presence of aqueous alkali may be included under the Claisen-Schmidt condensation :

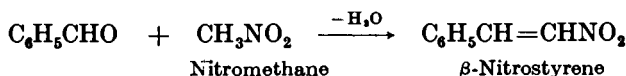

It is of interest to note that reduction of β -nitrostyrene with lithium aluminium hydride (compare Section VI,10) gives β -phenylethylamine $\text{C}_6\text{H}_5\text{CH}_2\text{CH}_2\text{NH}_2$.

The *mechanism* of this base-catalysed reaction probably involves the intermediate formation of an aldol :

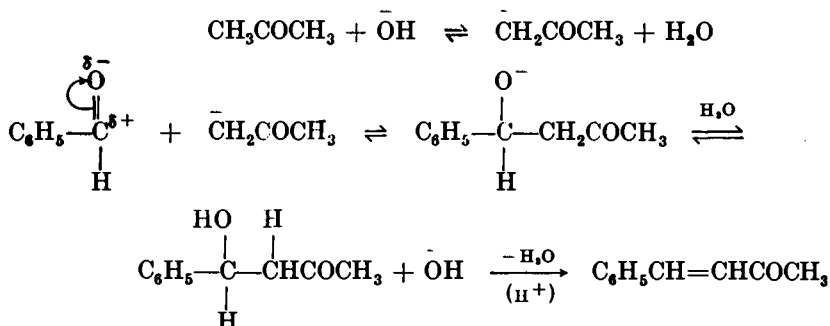

5. **Claisen aldol condensation.** This consists in the condensation of an aromatic aldehyde and an ester $\text{R}-\text{CH}_2\text{COOC}_2\text{H}_5$ in the presence of finely divided sodium and a trace of alcohol at a low temperature. The catalyst is the alkoxide ion; aqueous alkalis cannot be employed since they will hydrolyse the resulting ester. The product is an $\alpha\beta$ -unsaturated ester, for example :

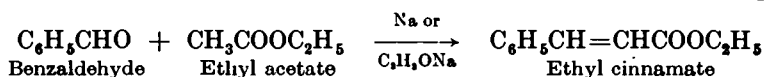

The *mechanism* of the reaction between aromatic aldehydes and esters probably involves the intermediate formation of an aldol (hence the name—Claisen aldol condensation) :

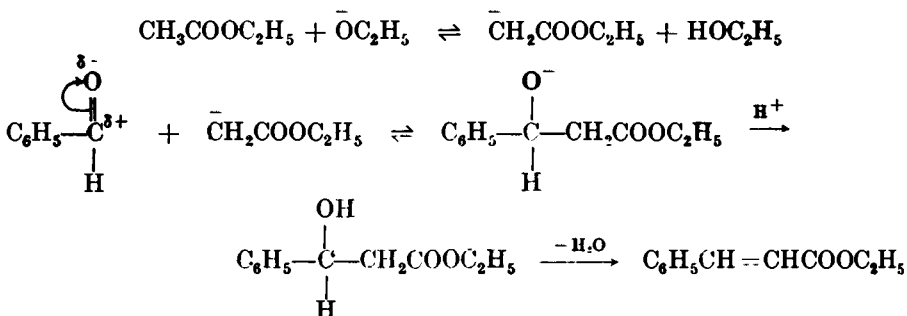

This reaction must be distinguished from the Claisen condensation, which is an acylation process (see discussion before Section III, 151).

6. **Knoevenagel reaction.** The condensation of an aldehyde with an active methylene compound (usually malonic acid or its derivatives) in the presence of a base is generally called the **Knoevenagel reaction**. Knoevenagel found that condensations between aldehydes and malonic acid are effectively catalysed by ammonia and by primary and secondary amines in alcoholic solution; of the organic amines piperidine was regarded as the best catalyst.

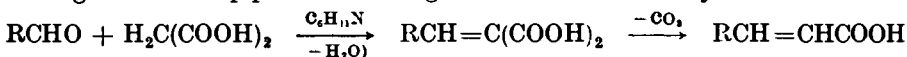

The **Doebner condensation** (or reaction)* is a slight modification of the Knoevenagel reaction and consists in warming a solution of the aldehyde and

* Priority for the use of pyridine as a catalyst should be assigned to Verley; Doebner subsequently extended its use.

malonic acid in pyridine (sometimes in the presence of a little piperidine) on a steam bath for a few hours. The modification is very convenient, gives excellent results, and is particularly useful when the Perkin reaction gives poor yields, for example :

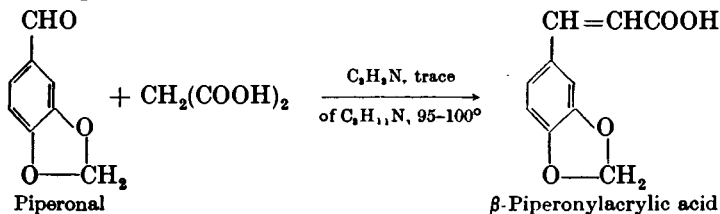

Examples of the Knoevenagel reaction with aldehydes are given under crotonic acid (III,145), β -*n*-hexylacrylic acid (III,144), sorbic acid (III,145) and furylacrylic acid (V,10).

A probable *mechanism* of these base-catalysed aldol reactions may be written in general terms as follows :

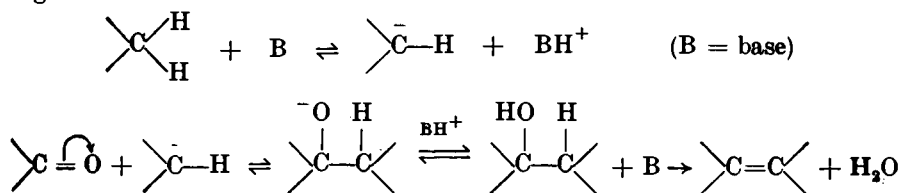

Benzaldehyde reacts with hydroxylamine in the presence of excess of sodium hydroxide to yield an oxime of low m.p. (α - or *syn*-benzaloxime) which is stable to alkali, but is rapidly rearranged by acids to give an isomeric oxime of higher m.p. (β - or *anti*-benzaloxime) :

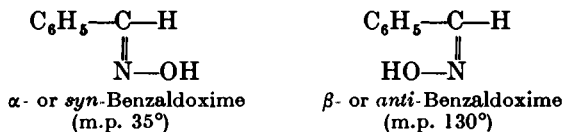

Unlike aliphatic aldehydes (with the exception of formaldehyde which yields hexamethylenetetramine, Section III,67) benzaldehyde yields hydrobenzamide (and not an aldehyde ammonia) with ammonia :

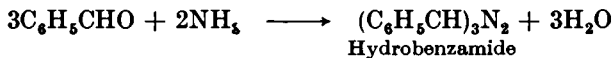

IV,123. BENZYL ALCOHOL AND BENZOIC ACID (Cannizzaro Reaction)

Dissolve 27 g. of potassium hydroxide in 25 ml. of water contained in a beaker or conical flask, and cool the solution to about 20° in ice water. Pour the solution into a 250 ml. reagent bottle, and add 30 g. (29 ml.) of pure benzaldehyde (1) ; cork the bottle securely and shake the mixture vigorously until it has been converted into a thick emulsion. Allow the mixture to stand overnight or for 24 hours in the stoppered bottle. Add *just sufficient water* (about 105 ml.) to dissolve the potassium benzoate. Pour the liquid into a separatory funnel, rinse out the bottle with about 30 ml. of ether and add this ether to the solution in the funnel. Shake the

solution in order to thoroughly extract the benzyl alcohol with the ether, separate the lower aqueous solution, and carry out two further extractions each with about 25 ml. of ether. *Save the aqueous solution.* Combine the ether extracts and distil the ether from a water bath (*CAUTION*: see Section II,14) until the volume is about 25 ml. Cool and shake the ether solution twice with 5 ml. portions of saturated sodium bisulphite solution in order to remove any benzaldehyde which may be present. Separate the ethereal solution, wash it with 10 ml. of 10 per cent. sodium carbonate solution (to ensure complete removal of the bisulphite), then with 10 ml. of water, and dry with anhydrous magnesium sulphate or anhydrous potassium carbonate. Remove the ether (Fig. II, 13, 4; 50 ml. distilling flask) on a water bath, and distil the residual liquid over a wire gauze or, better, from an air bath (Fig. II, 5, 3); replace the water condenser by an air condenser or empty the water completely from the condenser jacket. Collect the benzyl alcohol at 204–207° (the pure compound boils at 205·5°). The yield is 13 g.

Pour the aqueous solution remaining from the ether extraction with stirring into a mixture of 80 ml. of concentrated hydrochloric acid, 80 ml. of water and about 100 g. of crushed ice. Filter the precipitated benzoic acid at the pump, wash it with a little cold water, drain, and recrystallise from boiling water. The yield of benzoic acid (colourless crystals), m.p. 121°, is 18 g.

Note.

(1) The benzaldehyde should be free from benzoic acid; it may be purified as described in Section IV,115.

IV,124.

CINNAMIC ACID

Place 21 g. (20 ml.) of pure benzaldehyde (1), 30 g. (28 ml.) of acetic anhydride and 12 g. of freshly fused and finely-powdered potassium acetate (2) in a dry, 250 ml. round-bottomed flask fitted with an air condenser carrying a calcium chloride (or cotton wool) guard tube. Mix well and heat the reaction mixture in an oil bath at 160° for 1 hour and at 170–180° for 3 hours. Pour the mixture while still hot (80–100°) into about 100 ml. of water contained in a 1-litre round-bottomed flask which has previously been fitted for steam distillation (Fig. II, 40, 1); rinse the reaction flask with a little hot water. Now add with vigorous shaking a saturated aqueous solution of sodium carbonate (3) until a drop of the liquid withdrawn on the end of a glass rod turns red litmus a distinct blue. Steam distil the solution until all the unchanged benzaldehyde is removed and the distillate is clear. Cool the residual solution and filter at the pump from resinous by-products. Acidify the filtrate by adding concentrated hydrochloric acid slowly and with vigorous stirring until the evolution of carbon dioxide ceases. When cold, filter the cinnamic acid at the pump, wash with cold water, and drain well. Recrystallise either from hot water or from a mixture of 3 volumes of water and 1 volume of alcohol (or methylated spirit). The yield of dry cinnamic acid (colourless crystals), m.p. 133°, is 18 g.

Notes.

(1) The benzaldehyde must be free from benzoic acid; it may be purified as detailed in Section IV,115.

(2) An equivalent quantity of freshly fused sodium acetate (Section II,50,9) may also be used, but the reaction is slower and a further 3–4 hours heating is necessary. Fused potassium acetate is prepared by melting the potassium acetate of commerce in a porcelain dish and heating gently, with occasional stirring, until no more vapour is evolved and the salt is completely fluid. When cold, the solid is finely ground in a mortar and preserved in a tightly-stoppered bottle until required.

(3) Sodium hydroxide solution cannot be used at this stage since it may produce benzoic acid by the Cannizzaro reaction (Section IV,123) from any unchanged benzaldehyde. If, however, the reaction mixture is diluted with 3–4 volumes of water, steam distilled to remove the unreacted benzaldehyde, the residue may then be rendered alkaline with sodium hydroxide solution. A few grams of decolourising carbon are added, the mixture boiled for several minutes, and filtered through a fluted filter paper. Upon acidifying carefully with concentrated hydrochloric acid, cinnamic acid is precipitated. This is collected, washed and purified as above.

COGNATE PREPARATIONS

Coumarin. In a 250 ml. round-bottomed flask, provided with a small reflux condenser and a calcium chloride drying tube at the top, place 2·1 g. of salicylaldehyde, 2·0 ml. of anhydrous triethylamine and 5·0 ml. of acetic anhydride, and reflux the mixture gently for 12 hours. Steam distil the mixture from the reaction flask and discard the distillate. Render the residue in the flask basic to litmus with solid sodium bicarbonate, cool, filter the precipitated crude coumarin at the pump and wash it with a little cold water. Acidify the filtrate to Congo red with 1:1-hydrochloric acid, collect the precipitated *o*-acetoxy coumaric acid and recrystallise it from 70 per cent. isopropyl alcohol; the yield is 0·40 g., m.p. 153–154°.

Boil the crude coumarin with 200 ml. of water to which 0·2 g. of decolourising carbon is added, filter the hot solution, and concentrate it to a volume of 80 ml. Cool, collect the coumarin which separates, and recrystallise it from 40 per cent. aqueous methanol. The yield of coumarin, m.p. 68–69°, is 1·0 g.

α -Phenylcinnamic acid. Place 42·5 g. (40·5 ml.) of purified benzaldehyde (Section IV,115), 54·5 g. of phenylacetic acid, 80 ml. of redistilled A.R. acetic anhydride and 40 ml. of anhydrous triethylamine in a 500 ml. round-bottomed flask fitted with a reflux condenser and drying tube. Boil the mixture gently for 5 hours. Steam distil the mixture directly from the reaction flask until the distillate passing over is no longer cloudy, and collect a further 50 ml. of distillate: discard the distillate. Cool the residue in the flask and decant the solution from the solid; make up the volume of the solution to 500 ml. with water (*A*). Dissolve the solid in 500 ml. of hot 95 per cent. ethanol, add the solution (*A*) followed by 2 g. of decolourising carbon; heat the mixture to boiling, filter and acidify the filtrate immediately to Congo red with 1:1-hydrochloric acid. Cool. Collect the separated crystals by suction filtration and recrystallise from 60 per cent. ethanol. The yield of α -phenylcinnamic acid (1), m.p. 172–173°, is 55 g.

Note.

(1) The product is the isomer with the two phenyl groups *cis* to each other, since decarboxylation with quinoline-copper chromium oxide at 210–220° yields *cis*-stilbene.

IV,125.

BENZOIN

In a 500 ml. round-bottomed flask place 65 ml. of rectified spirit, 50 g. (47.5 ml.) of pure benzaldehyde (1) and a solution of 5 g. of sodium cyanide (96–98 per cent.) (*CAUTION*) in 50 ml. of water. Attach a reflux condenser (preferably of the double surface type) and boil the mixture gently for half an hour (2). Cool the contents of the flask (preferably in an ice bath). Filter the crude benzoin, wash it with cold water, drain well (3) and dry. The yield of crude benzoin, which is white or pale yellow in colour, is 45 g.

Recrystallise 5.0 g. from about 40 ml. of hot rectified (or methylated) spirit; upon cooling, 4.5 g. of pure benzoin (a white, crystalline solid, m.p. 137°) separate. Reserve the remainder of the preparation for benzil and benzoic acid (Sections IV,126 and IV,127 respectively).

Notes.

(1) For the purification of commercial benzaldehyde, see Section IV,115.

(2) The reaction sometimes takes place with considerable violence and material may be lost through the condenser unless a large flask (*e.g.*, at least of the size given) is employed.

(3) The filtrate contains sodium cyanide, and should be washed down the sink with a liberal quantity of water.

COGNATE PREPARATION

4-Methoxybenzoin. Dissolve 25 g. of potassium cyanide in 175 ml. of water in a 1500 ml. round-bottomed flask, and add 136 g. (121.5 ml.) of redistilled 4-methoxybenzaldehyde (anisaldehyde), 108 g. (103 ml.) of redistilled benzaldehyde and 350 ml. of 95 per cent. ethanol. Reflux the mixture (which becomes homogeneous at the boiling temperature) for 90 minutes. Remove all the unreacted aldehydes and the ethanol by steam distillation. Decant the water from the residue and set it aside to crystallise. Press the product as free as possible from oily material on a suction funnel and wash it with a little ethanol. Recrystallise the crude product (*ca.* 125 g.) by dissolving it in hot ethyl alcohol and allowing to crystallise slowly. The *p*-methoxybenzoin separates out first in large clumps of long needles, whilst the little benzoin present crystallises in small compact balls of needles. With a little experience it is possible to filter off a good yield of the former before the appearance of the benzoin. The yield of 4-methoxybenzoin is about 55 g. Recrystallise it again until the m.p. is 105–106°.

IV,126.

BENZIL

Method 1. Place 20 g. of crude benzoin (preceding Section) and 100 ml. of concentrated nitric acid in a 250 ml. round-bottomed flask. Heat on a boiling water bath (in the fume cupboard) with occasional shaking until the evolution of oxides of nitrogen has ceased (about 1.5 hours). Pour the reaction mixture into 300–400 ml. of cold water contained in a beaker, stir well until the oil crystallises completely as a yellow solid. Filter the crude benzil at the pump, and wash it thoroughly with water to remove the nitric acid. Recrystallise from alcohol or methylated spirit (about 2.5 ml. per gram). The yield of pure benzil, m.p. 94–96°, is 19 g.

Method 2. Place 0.2 g. of cupric acetate, 10 g. of ammonium nitrate, 21.2 g. of benzoin and 70 ml. of an 80 per cent. by volume acetic acid-water solution in a 250 ml. flask fitted with a reflux condenser. Heat the mixture with occasional shaking (1). When solution occurs, a vigorous evolution of nitrogen is observed. Reflux for 90 minutes, cool the solution, seed the solution with a crystal of benzil (2), and allow to stand for 1 hour. Filter at the pump and keep the mother liquor (3): wash well with water and dry (preferably in an oven at 60°). The resulting benzil has m.p. 94–95° and the m.p. is unaffected by recrystallisation from alcohol or from carbon tetrachloride (2 ml. per gram). Dilution of the mother liquor with the aqueous washings gives a further 1.0 g. of benzil (4).

Notes.

(1) For large scale preparations use a three-necked flask equipped with two reflux condensers and an oil-sealed stirrer.

(2) Stirring or vigorous shaking also induces crystallisation.

(3) The mother liquor should not be concentrated as an explosion may result.

(4) The above appears to be a general reaction for converting α -hydroxy ketones into diketones in excellent yield: thus furoin and anisoïn give furil and anisil respectively. The reaction is probably:

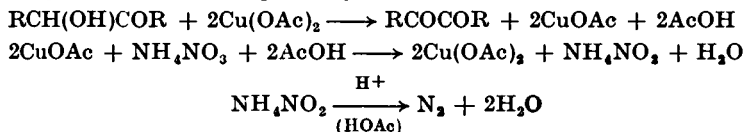

IV,127.

BENZILIC ACID

Method 1. In a 500 ml. round-bottomed flask, place a solution of 35 g. of potassium hydroxide in 70 ml. of water, then add 70 g. (87 ml.) of rectified spirit and 35 g. of recrystallised benzil (preceding Section). A deep bluish-black solution is produced. Fit a reflux condenser to the flask and boil the mixture on a water bath for 10–15 minutes. Pour the contents of the flask into a porcelain dish and allow to cool, preferably overnight. The potassium salt of benzilic acid crystallises out. Filter off the crystals at the pump and wash with a little ice-cold alcohol. Dissolve the potassium salt in about 350 ml. of water, and add 1 ml. of concentrated hydrochloric acid from a burette slowly and with stirring. The precipitate thus produced is coloured red-brown and is somewhat sticky. Filter this off; the filtrate should be nearly colourless. Continue the addition of hydrochloric acid with stirring until the solution is acid to Congo red paper. Filter off the benzilic acid with suction, wash it thoroughly with cold water until free from chlorides, and allow to dry. The yield of crude benzilic acid, which is usually light pink or yellow in colour, is 30 g. Purify the product either by recrystallisation from hot benzene (about 6 ml. per gram) or from hot water with the use of a little decolourising carbon. The coloured and sticky material obtained by the first precipitation may be recrystallised from hot water with the addition of a little decolourising carbon, and a further 1–2 g. obtained. Pure benzilic acid has m.p. 150°.

Method 2. Prepare a solution of 50 g. of sodium hydroxide and 11.5 g. of sodium bromate (or 12.5 g. of potassium bromate) in 90 ml. of water

in an evaporating dish or casserole. Add 44 g. of benzil (1) in portions to this solution whilst stirring (preferably with a mechanical stirrer) and heating on a water bath at 85–90° (2). Add small quantities of water from time to time to prevent the mixture becoming too thick; about 80 ml. of water are required. Continue the heating and stirring until a test portion is completely or almost completely soluble in water; this usually requires 3–4 hours. Dilute the mixture with 400 ml. of water and allow to stand, preferably overnight. Filter off the solid or oily impurity (benzhydrol). Set aside 5 ml. of the filtrate (3) and add dilute sulphuric acid (1 : 3 by volume) slowly and with stirring to a point just short of the liberation of bromine; about 130 ml. are required. If the end point is overstepped, add the 5 ml. of the filtrate which was set aside and then sufficient sulphuric acid to the end point. Filter off the product at the pump, wash it well with water and dry. The benzilic acid weighs 46 g. and has a m.p. of 149–150°, *i.e.*, is practically pure. If desired, it may be recrystallised from benzene.

Notes.

- (1) Moist and/or crude benzil (see Section IV, 126) gives equally satisfactory results.
- (2) The reaction mixture should not be heated to boiling since this leads to the formation of much benzhydrol. The temperature attained by heating on a boiling water bath is 85–90°.
- (3) This precaution is generally unnecessary if the addition of sulphuric acid is made carefully.

IV, 128.

BENZALACETONE

Place 42 g. (40 ml.) of pure benzaldehyde (Section IV, 115) and 63·5 g. (80 ml.) of pure acetone in a 250 ml. wide-mouthed bottle or bolt-head flask equipped with a mechanical stirrer. Immerse the reaction vessel in a bath of cold water and add slowly (during about 30 minutes) from a dropping funnel 10 ml. of 10 per cent. sodium hydroxide solution; adjust the rate of addition so that the temperature remains between 25° and 30°. Stir the mixture at room temperature for a further 2 hours; alternatively, securely stopper the bottle and shake mechanically for the same period. Render the mixture just acid to litmus paper by the addition of dilute hydrochloric acid. Transfer to a separatory funnel. Remove the upper organic layer, extract the lower aqueous layer with 20 ml. of benzene and add the extract to the yellow upper layer. Wash the latter with 20 ml. of water, and dry with a little anhydrous magnesium sulphate. Remove the benzene on a water bath with the aid of the apparatus illustrated in Fig. II, 13, 4 but with the distilling flask replaced either by a Claisen flask or, better, a Claisen flask with fractionating side arm (Figs. II, 24, 2–5), and distil the residue under diminished pressure (Fig. II, 20, 1). The benzalacetone distils at 133–143°/16 mm. (or at 120–130°/7 mm. or at 150–160°/25 mm.), and solidifies to a crystalline mass on standing, m.p. 38–39°; the yield is 45 g. This is pure enough for most practical purposes, but may be further purified by redistillation (b.p. 137–142°/16 mm.) or by recrystallisation from light petroleum (b.p. 40–60°): the pure benzalacetone melts at 42°. The residue in the distilling flask contains some dibenzalacetone, which may be prepared in the pure state by employing the theoretical quantities of benzaldehyde and acetone.

DIBENZALACETONE

In a 500 ml. wide-mouthed reagent bottle place a cold solution of 25 g. of sodium hydroxide in 250 ml. of water and 200 ml. of alcohol (1); equip the bottle with a mechanical stirrer and surround it with a bath of water. Maintain the temperature of the solution at 20–25°, stir vigorously and add one-half of a previously prepared mixture of 26.5 g. (25.5 ml.) of pure benzaldehyde (Section IV,115) and 7.3 g. (9.3 ml.) of A.R. acetone. A flocculent precipitate forms in 2–3 minutes. After 15 minutes add the remainder of the benzaldehyde-acetone mixture. Continue the stirring for a further 30 minutes. Filter at the pump and wash with cold water to eliminate the alkali as completely as possible. Dry the solid at room temperature upon filter paper to constant weight; 27 g. of crude dibenzalacetone, m.p. 105–107°, are obtained. Recrystallise from hot ethyl acetate (2.5 ml. per gram) or from hot rectified spirit. The recovery of pure dibenzalacetone, m.p. 112°, is about 80 per cent.

Note.

(1) Sufficient alcohol is employed to dissolve the benzaldehyde and to retain the initially-formed benzalacetone in solution until it has had time to react with the second molecule of benzaldehyde.

IV,129

β-NITROSTYRENE

Equip a 1500 ml. three-necked flask with a thermometer, mechanical stirrer and a dropping funnel. Place 61 g. (54 ml.) of nitromethane (Section III,55), 106 g (101 ml.) of purified benzaldehyde (Section IV,115) and 200 ml. of methanol in the flask and cool it with a mixture of ice and salt to about –10°. Dissolve 42 g. of sodium hydroxide in 40–50 ml. of water, cool and dilute to 100 ml. with ice and water; place this cold solution in the dropping funnel. Add the sodium hydroxide solution, with vigorous stirring, to the nitromethane mixture at such a rate that the temperature is held at 10–15°. Introduce the first few ml. cautiously since, after a short induction period, the temperature may rise to 30° or higher; check the rise in temperature, if necessary, by adding a little crushed ice to the reaction mixture. A bulky white precipitate forms; if the mixture becomes so thick that stirring is difficult, add about 10 ml. of methanol. After standing for about 15 minutes, add 700 ml. of ice water containing crushed ice; the temperature should be below 5°. Run the resulting cold solution immediately from a dropping funnel and with stirring into 500 ml. of 2:3-hydrochloric acid contained in a 3-litre flask or jar; adjust the rate of addition so that the stream just fails to break into drops. A pale yellow crystalline precipitate separates almost as soon as the alkaline solution mixes with the acid. The solid settles to the bottom of the vessel when the stirrer is stopped. Decant most of the cloudy liquid layer, filter the residue by suction and wash it with water until free from chlorides. Transfer the solid to a beaker immersed in hot water; two layers form and on cooling again, the lower layer of nitrostyrene solidifies; pour off the upper water layer. Dissolve the crude nitrostyrene in 85 ml. of hot ethanol (*FUME CUPBOARD*: nitrostyrene vapours are irritating to the nose and eyes, and the skin of the face is sensitive to the solid), filter through a hot water funnel and cool until

crystallisation is complete. The yield of pure β -nitrostyrene, m.p. 57–58° is 125 g.

IV,130. BENZALACETOPHENONE (CHALCONE)

Place a solution of 22 g. of sodium hydroxide in 200 ml. of water and 100 g. (122.5 ml.) of rectified spirit in a 500 ml. bolt-head flask provided with a mechanical stirrer. Immerse the flask in a bath of crushed ice, pour in 52 g. of freshly-distilled acetophenone (Section IV,136), start the stirrer, and then add 46 g. (44 ml.) of pure benzaldehyde (Section IV,115). Keep the temperature of the mixture at about 25° (the limits are 15–30°) and stir vigorously until the mixture is so thick that stirring is no longer effective (2–3 hours). Remove the stirrer and leave the reaction mixture in an ice chest or refrigerator overnight. Filter the product with suction on a Buchner funnel or a sintered glass funnel, wash with cold water until the washings are neutral to litmus, and then with 20 ml. of ice-cold rectified spirit. The crude chalcone, after drying in the air, weighs 88 g. and melts at 50–54°. Recrystallise from rectified spirit warmed to 50° (about 5 ml. per gram). The yield of pure benzalacetophenone (a pale yellow solid), m.p. 56–57°, is 77 g. This substance should be handled with great care since it acts as a skin irritant.

IV,131

ETHYL CINNAMATE

Prepare powdered (or "molecular") sodium from 14.5 g. of clean sodium and 150–200 ml. of sodium-dried xylene contained in a 1-litre three-necked flask (Section II,50,6) fitted with a mechanical stirrer and a reflux condenser. When cold, pour off the xylene as completely as possible, and then add 230 ml. of absolute ethyl acetate (Section II,47,19) containing 2 ml. of absolute ethyl alcohol (1). Cool the flask rapidly to 0°, and add 53 g. (51 ml.) of pure benzaldehyde (Section IV,115) slowly (during 90 minutes) from a dropping funnel whilst the mixture is stirred. Keep the temperature between 0° and 5°; do not allow it to rise above 10° otherwise a poor yield will be obtained. The reaction commences as soon as the benzaldehyde is added, as is indicated by the production of a reddish substance on the particles of sodium. Continue the stirring until practically all the sodium has reacted (about 1 hour after all the benzaldehyde has been introduced). Then add 45 ml. of glacial acetic acid, followed by an equal volume of water (*CAUTION*: some sodium may be present). Separate the layer of ester, extract the aqueous layer with 25 ml. of ethyl acetate, wash the combined organic layers with 150 ml. of 1:1 hydrochloric acid, and dry with anhydrous magnesium or sodium sulphate. Distil off the ethyl acetate on a water bath (Fig. II, 13, 4 but with a Claisen flask replacing the distilling flask). Distil the residue under diminished pressure (Fig. II, 20, 1). Collect the ethyl cinnamate (a colourless liquid) at 126–131°/6 mm.; the yield is 65 g. (2).

Notes.

(1) A little alcohol (*ca.* 1 per cent.) is required to start the reaction; the yield is consistently lower in its absence.

(2) Ethyl cinnamate may also be prepared by the esterification of cinnamic acid. The pure compound boils at 127°/6 mm.

IV,132. β -PIPERONYLACRYLIC ACID (3 : 4-METHYLENE-DIOXYCINNAMIC ACID)

Dissolve 50 g. of piperonal and 75 g. of malonic acid in a mixture of 150 ml. of pyridine and 2.5 ml. of piperidine contained in a 500 ml. round-bottomed flask, and heat under reflux for 1 hour on a water bath. A rapid evolution of carbon dioxide takes place. Complete the reaction by boiling the solution for 5 minutes. Cool, pour into excess of water containing enough hydrochloric acid to combine with the pyridine, filter off the piperonylacrylic acid, wash with a little water, and dry. The yield is almost quantitative and the acid is practically pure. It may be recrystallised from glacial acetic acid ; m.p. 238°.

COGNATE PREPARATIONS

***p*-Methylcinnamic acid.** From *p*-tolualdehyde ; heat for 6 hours. Recrystallise from glacial acetic acid ; m.p. 198°. Yield : 87 per cent.

***m*-Nitrocinnamic acid.** From *m*-nitrobenzaldehyde. Recrystallise from alcohol ; m.p. 197°. Yield : 80 per cent.

***p*-Methoxycinnamic acid.** From anisaldehyde. Recrystallise from alcohol ; m.p. 172°. Yield : 80 per cent.

IV,133. α - AND β -BENZALDOXIMES

In a 250 ml. conical flask mix a solution of 14 g. of sodium hydroxide in 40 ml. of water and 21 g. (20 ml.) of pure benzaldehyde (Section IV,115). Add 15 g. of hydroxylamine hydrochloride in small portions, and shake the mixture continually (mechanical stirring may be employed with advantage). Some heat is developed and the benzaldehyde eventually disappears. Upon cooling, a crystalline mass of the sodium derivative separates out. Add sufficient water to form a clear solution, and pass carbon dioxide into the solution until saturated. A colourless emulsion of the α - or *syn*-aldoxime separates. Extract the oxime with ether, dry the extract over anhydrous magnesium or sodium sulphate, and remove the ether on a water bath. Distil the residue under diminished pressure (Fig. II, 20, 1). Collect the pure *syn*-benzaloxime (α -benzaloxime) at 122-124°/12 mm. ; this gradually solidifies on cooling in ice and melts at 35°. The yield is 12 g.

To prepare the β -benzaloxime, dissolve 10 g. of α -benzaloxime in 50 ml. of pure anhydrous ether and pass dry hydrogen chloride (Section II,48,1) through a *wide* delivery tube into the solution with constant shaking. Colourless crystals of the hydrochloride of the β -aldoxime separate. Filter these at the pump through a sintered glass funnel, wash with dry ether, transfer to a separatory funnel and cover with a layer of ether. Add a concentrated solution of sodium carbonate gradually and with constant shaking until effervescence ceases. Separate the ethereal layer, which contains the β -oxime, dry over anhydrous magnesium or sodium sulphate, and remove the ether by evaporation in a vacuum desiccator. The residue crystallises ; remove the small amount of oily matter by pressing on a porous tile. Recrystallise by dissolving it in the minimum volume of ether and then adding light petroleum (b.p. 60-80°). The yield of β -benzaloxime (*anti*-benzaloxime), m.p. 130°, is 7-8 g.

COGNATE PREPARATION

α -Benzilmonoxime. Grind 43 g. of pure benzil (Section IV,126) to a thin paste with a little alcohol, and add a concentrated aqueous solution of 17.5 g. of hydroxylamine hydrochloride. Cool to -5° (e.g., with crushed ice and concentrated hydrochloric acid) and add 30 g. of sodium hydroxide in 20 per cent. aqueous solution dropwise with rapid mechanical stirring: do not allow the temperature to rise above 0° . After 90 minutes dilute the mixture with water and filter off the small quantity of unchanged benzil on a sintered glass funnel. Just acidify the filtrate with glacial acetic acid, allow to stand for 30 minutes, filter off the crude pinkish α -monoxime, and recrystallise it from aqueous alcohol (60 vol. % alcohol); the resulting oxime weighs 37 g. and melts at 137° . To obtain the pure α -benzilmonoxime, recrystallise twice from benzene; the final yield is 28 g. of the pure product, m.p. 140° . Animal charcoal must not be used in the recrystallisation (see below).

β -Benzilmonoxime. Boil 10 g. of the pure α -monoxime for 15 minutes with 1 g. of dried animal charcoal in a quantity of pure benzene just sufficient to dissolve the α -monoxime at the boiling point. Filter off the charcoal and allow the filtrate to stand. The β -monoxime + $0.5 \text{ C}_6\text{H}_6$ crystallises slowly on cooling: a further crop can be obtained by evaporation of the mother liquid. An excellent yield of the β -monoxime, m.p. 112° , is obtained. The pure β -oxime causes no colour change with aqueous - alcoholic copper acetate solution; if it is contaminated with the α -oxime, a greenish colour is produced.

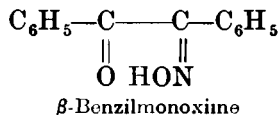
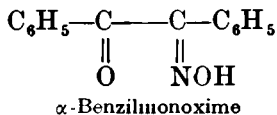

IV,134.

HYDROBENZAMIDE

Place 10 ml. of pure benzaldehyde (Section IV,115) and 100 ml. of concentrated ammonia solution (sp. gr. 0.88) in a 250 ml. wide-mouthed reagent bottle. Cork the bottle securely, shake vigorously for 10 minutes and allow to stand with occasional shaking for 24 hours. By this time the benzaldehyde should be converted into a hard mass of hydrobenzamide. Break up the solid mass with a spatula or a thick glass rod, filter with suction, wash with water, and drain thoroughly. Recrystallise from absolute alcohol (or absolute methylated spirit). The yield of hydrobenzamide (colourless crystals), m.p. 101° , is 7 g. It is easily hydrolysed by cold dilute acids.

IV,135.

REACTIONS AND CHARACTERISATION
OF AROMATIC ALDEHYDES

Aromatic aldehydes usually have relatively high boiling points, but distil with little or no decomposition. The vapours burn with a smoky flame. They are easily oxidised on standing in the air into the corresponding acids; the odours are often pleasant and characteristic. Aromatic aldehydes, by virtue of their high molecular weight, yield

crystalline derivatives with phenylhydrazine and hydroxylamine—these reagents are not generally recommended for aliphatic aldehydes since they give derivatives which are either liquids or solids of low m.p.

Aromatic aldehydes react with the dimedone reagent (Section III,70,2). All aromatic aldehydes (i) reduce ammoniacal silver nitrate solution and (ii) restore the colour of Schiff's reagent; many react with sodium bisulphite solution. They do not, in general, reduce Fehling's solution or Benedict's solution. Unlike aliphatic aldehydes, they usually undergo the Cannizzaro reaction (see Section IV,123) under the influence of sodium hydroxide solution. For full experimental details of the above tests, see under *Aliphatic Aldehydes*, Section III,70. They are easily oxidised by dilute alkaline permanganate solution at the ordinary temperature: after removal of the manganese dioxide by sulphur dioxide or by sodium bisulphite, the acid can be obtained by acidification of the solution.

CRYSTALLINE DERIVATIVES

1. **Dimedone derivatives.** For experimental details, see under *Aliphatic Aldehydes*, Section III,70,2.

2. **2:4-Dinitrophenylhydrazones.** For experimental details, see under *Aliphatic ketones*, Section III,74,1.

3. **Semicarbazones.** See Section III,74,2.

4. **Oximes** (compare Section III,74,B). The following procedure has wide application. Dissolve 0.5 g. of hydroxylamine hydrochloride in 2 ml. of water, add 2 ml. of 10 per cent. sodium hydroxide solution and 0.2 g. of the aldehyde (or ketone). If the latter is insoluble, add just sufficient alcohol to the mixture to give a clear solution. Heat the mixture under reflux for 10–15 minutes, and then cool in ice. If crystals separate, filter these off, and recrystallise from alcohol, dilute alcohol, benzene or light petroleum (b.p. 60–80°). If no solid separates on cooling, dilute with 2–3 volumes of water, filter the precipitated solid, and recrystallise.

5. **Phenylhydrazones** (compare Section III,74,C). Dissolve 0.5 g. of colourless phenylhydrazine hydrochloride and 0.8 g. of sodium acetate in 5 ml. of water, and add a solution of 0.2–0.4 g. of the aldehyde (or ketone) in a little alcohol (free from aldehydes and ketones). Shake the mixture until a clear solution is obtained and add a little more alcohol, if necessary. Warm on a water bath for 10–15 minutes and cool. Filter off the crystalline derivative, and recrystallise it from dilute alcohol or water; sometimes benzene or light petroleum (b.p. 60–80°) may be used.

The use of liquid phenylhydrazine in the preparation of phenylhydrazones is not recommended for beginners because of the highly poisonous character of the liquid (see Section IV,89). A phenylhydrazine reagent may, however, be used.

The phenylhydrazine reagent may be prepared by either of two methods.

Method A. Dissolve 25 ml. of light-coloured phenylhydrazine (redistil, if necessary) in 250 ml. of 10 per cent. acetic acid, add 0.5 g. of decolourising carbon, shake and filter into a dark bottle.

Method B. Dissolve 25 g. of colourless phenylhydrazine hydrochloride (recrystallise, if necessary) in 250 ml. of water; warming may be required. Add 45 g. of crystallised sodium acetate to the cold solution and shake until dissolved. Add 0.5 g. of decolourising carbon, shake, and filter into a dark bottle. The reagent should not be kept for longer than 1 month.

6. ***p*-Nitrophenylhydrazones** (compare Section III,74,1). Reflux a mixture of 0.5 g. of *p*-nitrophenylhydrazine, 0.5 g. of the aldehyde (or ketone), 10–15 ml. of alcohol and 2 drops of glacial acetic acid for 10 minutes. Add more alcohol if the boiling solution is not homogeneous. Cool the clear solution, filter off the *p*-nitrophenylhydrazone, and recrystallise it from alcohol or acetic acid.

Alternatively, dissolve approximately equivalent amounts of the aldehyde (or ketone) and the solid reagent in the minimum volume of cold glacial acetic acid, and reflux for 15 minutes. The *p*-nitrophenylhydrazone separates on cooling or upon careful dilution with water.

Note.

All aldehydes, and also those ketones which have two different groups attached to the carbonyl grouping, are capable of yielding two stereoisomeric oximes, hydrazones or semicarbazones. As a general rule, however, one of the stereoisomerides is formed in much greater amount than the other, and no doubt therefore arises as to the purity of the ketonic compound under investigation; occasionally a mixture of stereoisomerides is obtained, which may be difficult to separate by recrystallisation. The formation, therefore, of one of the above derivatives of indefinite melting point and obvious heterogeneity does not necessarily imply the presence of an impure ketonic substance.

7. **2 : 4-Dinitrophenylhydrazones.** The following procedure for the preparation of 2 : 4-dinitrophenylhydrazones is alternative to those given in Section III,74,1.

To the clear solution obtained by warming 0.5 g. of 2 : 4-dinitrophenylhydrazine, 1 ml. of concentrated hydrochloric acid and 8–10 ml. of ethanol, add 0.25 g. of the aldehyde and heat just to boiling. Allow to cool to room temperature, filter off the 2 : 4-dinitrophenylhydrazone and recrystallise it from ethanol or glacial acetic acid.

8. **Azines.** Aldehydes react with hydrazine to yield azines: the reaction cannot usually be arrested at the hydrazone stage. This reaction may be illustrated by the preparation of *benzalazine* from benzaldehyde :

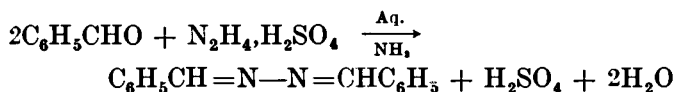

Stir a mixture of 2.4 g. of powdered hydrazine sulphate, 18 ml. of water and 2.4 ml. of concentrated aqueous ammonia (sp. gr. 0.88), and add 4.6 g. (4.4 ml.) of benzaldehyde (free from benzoic acid) dropwise, with stirring, over a period of 30–60 minutes. Stir the mixture for a further hour, collect the solid by suction filtration and wash it with water. Recrystallise from 8 ml. of rectified spirit. The yield of benzalazine (yellow needles), m.p. 92–93°, is 3.6 g.

The melting points of the various derivatives of a number of typical aromatic aldehydes are collected in Table IV,135.

TABLE IV,135.

AROMATIC ALDEHYDES

Aldehyde	B.P.	M.P.	Dimedone	"Anhydride" of Dimedone	2:4-Dinitrophenylhydrazone	Semicarbazone	Oxime	Phenylhydrazone	p-Nitrophenylhydrazone
Benzaldehyde	179°	—	195°	200°	237°	224°	35°d	158°	192°
<i>o</i> -Chlorobenzaldehyde	213	11°	205	225	209	229 (146)	76d	86	249
<i>m</i> -Chlorobenzaldehyde	214	18	—	—	248	229	71d	134	216
<i>p</i> -Chlorobenzaldehyde	214	47	—	—	265	232	107 (140)	127	220
<i>o</i> -Bromobenzaldehyde	230	22	—	—	—	214	102	—	240
<i>m</i> -Bromobenzaldehyde	234	—	—	—	—	205	72d	141	220
<i>p</i> -Bromobenzaldehyde	—	67	—	—	—	228	111	113	208
<i>o</i> -Iodobenzaldehyde	—	37	—	—	—	206	108	79	—
<i>m</i> -Iodobenzaldehyde	—	57	—	—	—	226	62	155	212
<i>p</i> -Iodobenzaldehyde	—	78	—	—	—	224	—	121	201
Salicylaldehyde (1)	197	—	—	208	252	231	63	143	228
<i>m</i> -Hydroxybenzaldehyde	240	108	—	—	259	198	90	130	222
<i>p</i> -Hydroxybenzaldehyde	—	116	189	246	280	224	72	178	266
<i>o</i> -Methoxybenzaldehyde	236	38	—	—	253	215	92	—	205
<i>m</i> -Methoxybenzaldehyde	230	—	—	—	—	—	40	—	171
Anisaldehyde (2)	248	2	145	243	254	209	132 (165)	121	161
<i>o</i> -Nitrobenzaldehyde	—	44	—	—	265	256	103	156	263
<i>m</i> -Nitrobenzaldehyde	—	58	—	—	292	246	122	121	247
<i>p</i> -Nitrobenzaldehyde	—	106	—	—	320	221	133	159	249
<i>o</i> -Aminobenzaldehyde	—	40	—	—	—	247	135	221	220
<i>m</i> -Aminobenzaldehyde	—	Amorphous	—	—	—	280d	195	162	226
<i>p</i> -Aminobenzaldehyde	—	72	—	—	—	173	124	156	—
<i>o</i> -Tolualdehyde	200	—	167	215	194	212	49	106	222
<i>m</i> -Tolualdehyde	199	—	172	206	194	223	60	91	157
<i>p</i> -Tolualdehyde	204	—	—	—	233	234	80	112	201
Protocatechuicaldehyde (3)	—	153	—	145	275	230	157	176	—
Resorcyllaldehyde (4)	—	136	—	—	286	260	192	158	—
2:3-Dimethoxybenzaldehyde	—	54	—	—	—	231	99	138	—

TABLE IV,135.

AROMATIC ALDEHYDES (*continued*)

Aldehyde	B.P.	M.P.	Dimedone	"Anhydride" of Dimedone	2:4-Dinitrophenylhydrazone	Semi-carbazone	Oxime	Phenylhydrazone	<i>p</i> -Nitrophenylhydrazone
2 : 4-Dimethoxybenzaldehyde	—	69°	—	—	—	—	106°	—	—
Veratraldehyde (5) . . .	285°	58	—	—	264°	177°	95	121°	—
<i>p</i> -Dimethylaminobenzaldehyde	—	74	—	—	325	222	185	148	182°
Phenylacetaldehyde . . .	194	34	165°	126°	121	156	99	63	151
Cinnamaldehyde	252	—	213	175	225d	215	139	168	195
Hydrocinnamaldehyde . . .	224	—	—	—	149	127	94	—	123
Cuminaldehyde (6)	235	—	171	173	241	211	52	129	190
Piperonal (7)	263	37	178	220	265	234	110	106	200
Vanillin (8)	—	81	197	228	269	239	117	105	228
Hexahydrobenzaldehyde . . .	162	—	—	—	—	173	91	—	—
α -Naphthaldehyde	292	34	—	—	—	221	98	80	234
β -Naphthaldehyde	—	61	—	—	270	245	156	206	230
2 : 4-Dichlorobenzaldehyde	—	72	—	—	—	—	—	—	—
2 : 6-Dichlorobenzaldehyde	—	71	—	—	—	—	150	—	—
3 : 4-Dichlorobenzaldehyde	248	44	—	—	—	—	119	—	277

(1) *o*-Hydroxybenzaldehyde.(2) *p*-Methoxybenzaldehyde.

(3) 3 : 4-Dihydroxybenzaldehyde.

(4) 2 : 4-Dihydroxybenzaldehyde.

(5) 3 : 4-Dimethoxybenzaldehyde.

(6) *p*-*iso*Propylbenzaldehyde.

(7) 3 : 4-Methylenedioxybenzaldehyde.

(8) 4-Hydroxy-3-methoxybenzaldehyde.

AROMATIC KETONES

Aromatic ketones may be prepared :—

1. By the **Friedel and Crafts reaction**. The condensation of an acid chloride or an acid anhydride with an aromatic hydrocarbon in the presence of anhydrous aluminium chloride generally gives a good yield of the aromatic ketone :

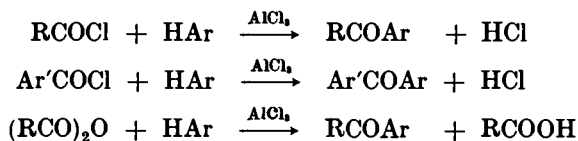

It should be noted that the Friedel-Crafts acylation differs from the Friedel-Crafts alkylation (compare Sections IV,3-4 and discussion preceding Section IV,1) in one important respect. The alkylation requires catalytic quantities of aluminium chloride, but for acylation a molecular equivalent of aluminium chloride is necessary for each carbonyl group present in the acylating agent. This is because aluminium chloride is capable of forming rather stable complexes with the carbonyl group; these complexes probably possess an oxonium structure $\text{>C=O}^+, \text{AlCl}_3^-$. Complex formation thus requires an equivalent quantity of metal halide and a slight excess over the molecular amount is employed in order to ensure that the free reagent may be present to act as a catalyst : thus 1·1 and 2·2 molecular equivalents of aluminium chloride are generally employed for acid chlorides and acid anhydrides respectively. Excess of benzene or of toluene may be used as a solvent (when either of these substances constitutes one of the reactants), otherwise carbon disulphide or nitrobenzene is usually used. Friedel-Crafts acylation is free of two features which complicate the alkylation reaction, namely, (i) polysubstitution and (ii) rearrangement of groups. There is usually no difficulty in arresting the acylation with the introduction of a single acyl group into the aromatic nucleus. Preliminary mixing of the acyl and aluminium halides often gives good results ; this procedure reduces any tendency of the benzene homologue to isomerise or disproportionate (where this is possible).

The use of aliphatic acid anhydrides in place of acid chlorides offers many advantages ; these include :

(a) The greater ease of obtaining the anhydrides in a state of purity and their availability as commercial products (acetic, propionic, *n*-butyric and succinic anhydrides).

(b) The handling of disagreeable acid chlorides is avoided.

(c) The absence of any appreciable quantities of by-products and of resinous substances.

(d) The resulting ketones are almost pure after one distillation. The reaction is smooth and the yield is generally good.

The examples of the Friedel and Crafts reaction described include the following :—

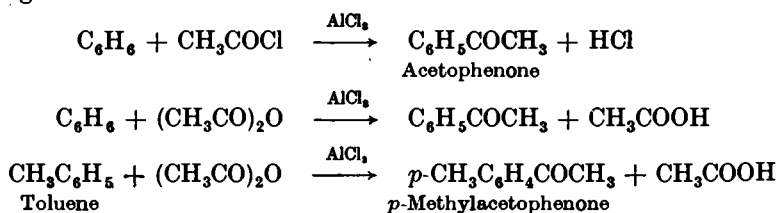

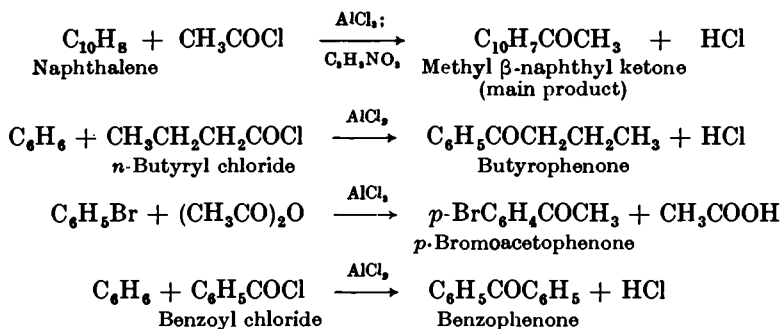

A further example is given below illustrating the use of a dibasic anhydride (succinic anhydride): the succinoylation reaction is a valuable one since it leads to aroyl carboxylic acids and ultimately to polynuclear hydrocarbons. This general scheme of synthesis of substituted hydrocarbons through the use of succinic anhydride is sometimes called the **Haworth reaction**. Thus α -tetralone (see below) may be reduced by the Clemmensen method to tetralin (tetrahydronaphthalene) and the latter converted into naphthalene either catalytically or by means of sulphur or selenium (compare Section, VI,33).

The *mechanism* of acylation with acyl halides is usually regarded as involving the acyl cation (acyl carbonium or acylium ion):

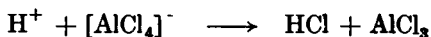
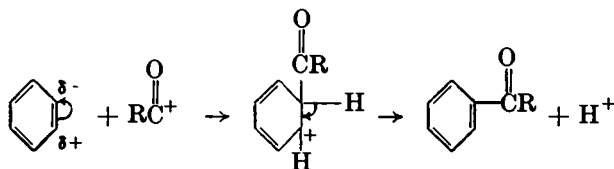
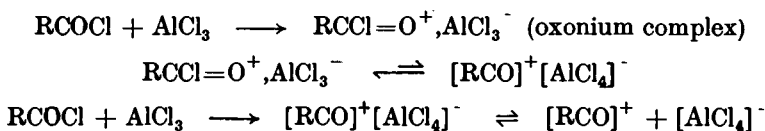

It is probable that, in general, acylation also occurs by the oxonium complex:

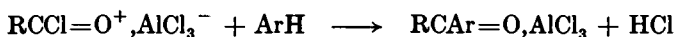

With acid anhydrides, an acyl chloride is probably formed first:



Benzophenone is more conveniently prepared from benzene and excess of carbon tetrachloride:

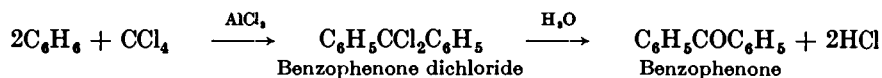

2. By catalytic reduction of $\alpha\beta$ -unsaturated ketones, prepared from aldehydes by the Claisen-Schmidt reaction (see under *Aromatic Aldehydes*), for example:

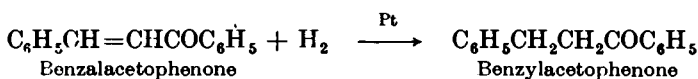

3. By dropping an aromatic acid either alone or mixed with an aliphatic acid into a tube containing a thoria catalyst deposited on pumice and heated to 400–450°. This method is generally employed for the preparation of mixed aromatic-aliphatic ketones. Excess of the aliphatic acid is usually present since this leads to by-products which are easily separated and also tends to increase the yield of the desired ketone at the expense of the symmetrical ketone of the aromatic acid. Thus :—

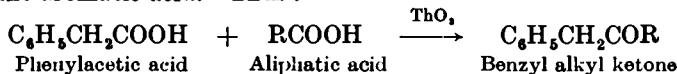

The by-products are formed in accordance with the following schemes :—

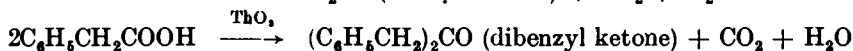
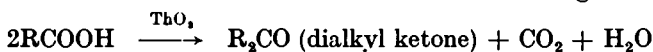

The dibenzyl ketone has a very high b.p. (ca. 200°/21 mm.) and this remains in the flask when the unsymmetrical ketone has been removed by distillation. The dialkyl ketone has a comparatively low b.p. and is therefore easily removed by fractionation under normal pressure; acetone is most simply separated by washing with water. In this way methyl benzyl ketone (R = CH₃), ethyl benzyl ketone (R = CH₃CH₂) and *n*-propyl benzyl ketone (R = CH₃CH₂CH₂) are prepared. By using hydrocinnamic acid in place of phenylacetic acid :

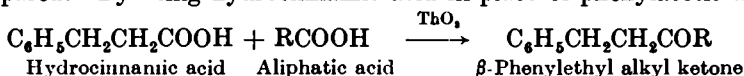

methyl β -phenyl ethyl ketone (R = CH₃), ethyl β -phenylethyl ketone (R = CH₃CH₂) and *n*-propyl β -phenylethyl ketone (R = CH₃CH₂CH₂) are obtained.

4. By the condensation of a nitrile with a phenol or phenol ether in the presence of zinc chloride and hydrogen chloride : a hydroxyaryl- or alkoxyaryl-ketone is produced. The procedure is termed the Hoesch reaction and is clearly an extension of the Gattermann aldehyde reaction (Section IV, 121). The reaction gives the best results with polyhydric phenols and their ethers : with simple monohydric phenols the imino ester hydrochloride is frequently the sole product for example :

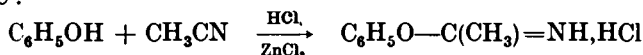

The reaction is illustrated by the following example :

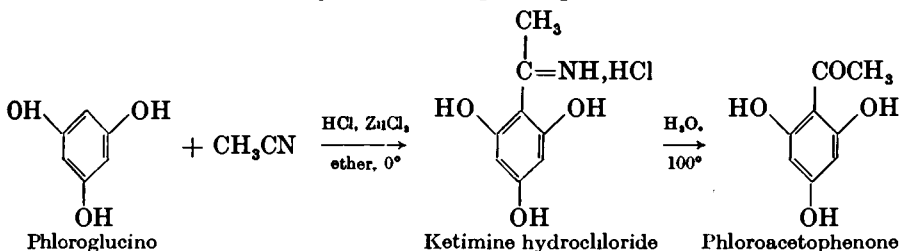

5. By the Fries reaction. This is a variant of the Friedel-Craft reaction; it consists in the conversion of an ester of a phenol to the corresponding *o*- and *p*-hydroxyketone, or a mixture of both, by treatment with anhydrous aluminium chloride :



For further details, see Section IV, 107 and discussion preceding Section IV, 101.

The preparation of the cyclic ketone α -tetralone possesses a number of interesting features. Succinic anhydride is condensed with pure benzene in the presence of anhydrous aluminium chloride (slightly over two equivalents; see I above) to yield β -benzoylpropionic acid :

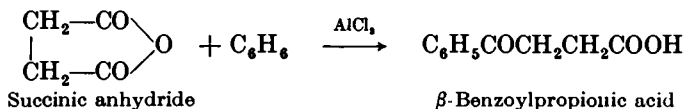

The latter is reduced by *Clemmensen's method* in the presence of a solvent immiscible with the hydrochloric acid (toluene);

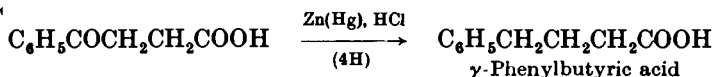

The γ -phenylbutyric acid is cyclised to α -tetralone by converting it into the acid chloride with thionyl chloride or phosphorus pentachloride and then an intramolecular Friedel and Crafts reaction is carried out :

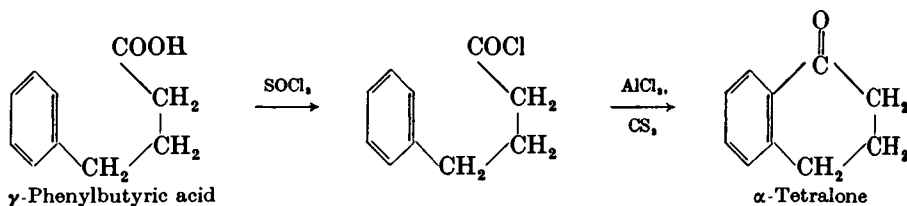

The synthesis of anthraquinone is instructive. Phthalic anhydride condenses with benzene in the presence of aluminium chloride (slightly more than two equivalents, see I above) to yield *o*-benzoylbenzoic acid, and the latter is heated with concentrated sulphuric acid :

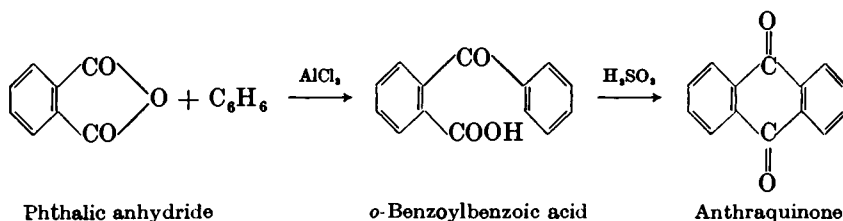

Toluene similarly yields β -methylanthraquinone :

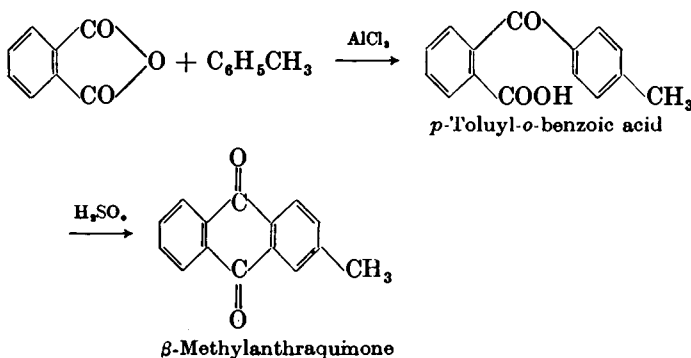

Anthraquinone may also be prepared by the oxidation of pure anthracene with a solution of chromium trioxide in glacial acetic acid :

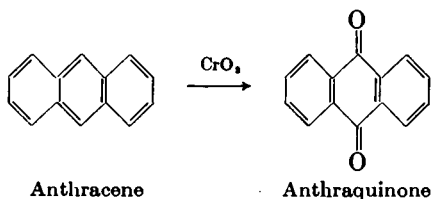

Reduction of anthraquinone with tin and concentrated hydrochloric acid in the presence of boiling glacial acetic acid gives anthrone; this substance (keto form) under certain conditions passes into the enol form, anthranol :

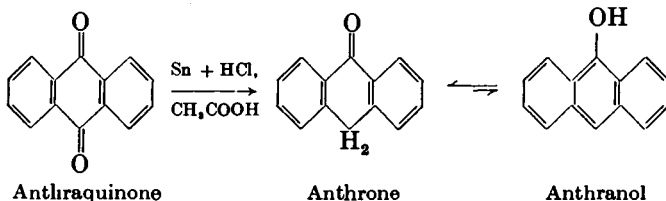

Benzophenone condenses with hydroxylamine hydrochloride in the presence of excess of sodium hydroxide solution to yield benzophenone oxime, m.p. 142° :

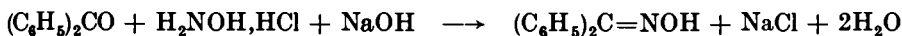

By treatment of this oxime with phosphorus pentachloride or thionyl chloride in ether solution, smooth conversion into benzanilide, m.p. 163°, results. The change of any oxime into a substituted amide under the conditions mentioned is usually termed the Beckmann rearrangement. The above example may be represented :

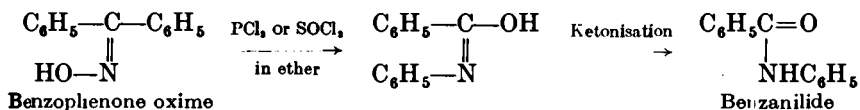

IV,136.

ACETOPHENONE

Method 1 (with acetyl chloride). Equip a dry 500 ml. round-bottomed or bolt-head flask with a reflux condenser, and fit the top of the condenser with a two-hole cork, one opening for a separatory funnel and the other for a delivery tube connected to an inverted funnel which dips *just* below the surface of about 200 ml. of water in a beaker (compare Fig. II, 13, 8). Place 40 g. of anhydrous, finely-powdered aluminium chloride (see Section IV,2) and 88 g. (100 ml.) of dry A.R. benzene in the flask and cool the latter in a bath of *cold* water (*not* ice water since benzene may crystallise). Through the separatory funnel at the top of the condenser add 29 g. (27 ml.) of redistilled acetyl chloride slowly during half an hour and shake the flask frequently to ensure thorough mixing of the

contents. When all the acetyl chloride has been introduced, heat the flask on a water bath at 50° for 1 hour in order to complete the reaction; much hydrogen chloride is evolved, which is absorbed by the water. Cool and pour the reaction mixture into about 250 ml. of water and a little crushed ice contained in a 750 ml. flask; decomposition occurs with the evolution of heat and a dark oil (largely a solution of acetophenone in benzene) separates on the surface. Cork the flask and shake to complete the decomposition; if any solid remains undissolved, add a little concentrated hydrochloric acid to dissolve it. Pour the mixture into a separatory funnel, run off and discard the lower layer, wash the benzene layer with dilute sodium hydroxide solution (to remove the hydrogen chloride), then with water, and dry over anhydrous magnesium sulphate or calcium chloride. Recover the solvent by distillation from a boiling water bath; use the apparatus shown in Fig. II, 13, 4 (100 ml. distilling flask). When most of the benzene has been removed, replace the dropping funnel by a 360° thermometer and the water condenser by short air condenser (Fig. II, 13, 2). Continue the distillation by careful heating over a gauze or, better, in an air bath (Fig. II, 5, 3)—**CAUTION**: there may be some benzene in the residual oil—and collect the acetophenone at 195–202° (pure acetophenone boils at 201°); the colourless oil crystallises on cooling in ice and has m.p. 20°. The yield is 27 g.

Method 2 (with acetic anhydride). Proceed exactly as in *Method 1*, but use 80 g. of powdered, anhydrous aluminium chloride, 108 g. (123 ml.) of dry A.R. benzene, and 26 g. (24 ml.) of redistilled acetic anhydride (1). Add the acetic anhydride during half an hour whilst the contents of the flask are thoroughly shaken; much heat is evolved in the reaction. Heat on a boiling water bath for 30 minutes (or until the evolution of hydrogen chloride almost ceases) to complete the reaction, cool, and pour the contents of the flask into a mixture of 150 g. of crushed ice and 150 ml. of concentrated hydrochloric acid contained in a beaker or flask. Stir or shake until all the aluminium salts are dissolved. Transfer the mixture to a separatory funnel, add 25–30 ml. of ether, shake and separate the upper (largely benzene) layer. Extract the aqueous layer with 25 ml. of ether and add this to the benzene solution. Wash the combined benzene and ether extracts with 50 ml. of 10 per cent. sodium hydroxide solution (or until the washings remain alkaline), then with water, separate the organic layer and dry it with anhydrous magnesium sulphate or calcium chloride. Remove the ether and benzene and isolate the acetophenone, b.p. 199–202° (2), as in *Method 1*. The yield is 25 g.

Notes.

(1) An alternative apparatus for conducting the preparation by both methods utilises a two-way adapter as in Fig. II, 13, 9. The preparation may be carried out more conveniently in a three-necked flask provided with a mechanical stirrer; full details are given below under *p*-methylacetophenone.

(2) The b.p. under reduced pressure is 88–89°/16 mm. It solidifies on cooling: m.p. 20°.

COGNATE PREPARATIONS

***p*-Methylacetophenone.** In a 1 litre three-necked flask, equipped with a separatory funnel carrying a calcium chloride (or cotton wool)

guard tube, a mercury-sealed mechanical stirrer, and a double surface reflux condenser attached to a gas absorption device (Fig. II, 8, 1, c), place 150 g. of finely-powdered, anhydrous aluminium chloride and 253 ml. of sodium-dried toluene (free from sulphur compounds; see Section II, 47, 16). Set the stirrer in motion and add 51 g. (47.5 ml.) of redistilled acetic anhydride slowly through the separatory funnel; the addition requires 15 minutes, during which time the temperature rises to about 90° and much hydrogen chloride is evolved. Heat the mixture on a water bath, with stirring, for 30 minutes or until there is practically no evolution of gas. Cool the reaction mixture to room temperature and pour it into a mixture of 300 g. of crushed ice and 300 ml. of concentrated hydrochloric acid: stir until the aluminium salts dissolve completely. Separate the toluene layer, wash it with water, then with 10 per cent. sodium hydroxide solution until the washings remain alkaline, and finally with water: dry over a little anhydrous magnesium sulphate. Distil the residue from a Claisen flask with fractionating side arm (Figs. II, 24, 2-5) at atmospheric pressure until the temperature rises to about 125°, then allow to cool and distil under reduced pressure. Collect the *p*-methylacetophenone at 93-94°/7 mm. (the b.p. under atmospheric pressure is 225°); the yield is 58 g.

Methyl β -naphthyl ketone (β -Acetonaphthalene).* Equip a 1 litre three-necked flask with a mercury-sealed mechanical stirrer and a dropping funnel. Place 64 g. of resublimed naphthalene and 350 g. (291 ml.) of pure nitrobenzene in the flask and stir until dissolved. To the homogeneous solution add 43.5 g. (38.5 ml.) of redistilled acetyl chloride. Cool to - 5° in a freezing mixture of ice and salt and introduce, whilst stirring vigorously, 73.5 g. of finely-powdered, anhydrous aluminium chloride in small portions during 90 minutes; do not allow the temperature to rise above 0°. The aluminium chloride dissolves and a deep green solution results. Remove the stirrer from the central aperture and replace it by a solid rubber stopper: into the side necks of the flask fit respectively a drawn-out capillary tube and a tube leading through a filter flask trap and a manometer to a water filter pump. Reduce the pressure to 15-20 mm. (take adequate precautions against collapse of the flask); hydrogen chloride is copiously evolved and a vigorous ebullition occurs in the mixture. When no more gas is evolved, add an excess of crushed ice and separate the nitrobenzene layer. Wash the latter successively with two 100 ml. portions of dilute hydrochloric acid and 100 ml. of 5 per cent. sodium carbonate solution. Use either of the following methods for isolating the pure β -acetonaphthalene from the accompanying α -isomer (about 10 per cent.)

1. Steam distil from a 1.5 litre three-necked flask until the odour of nitrobenzene is no longer perceptible in the distillate (6-12 hours). Extract the cold residue with three 100 ml. portions of ether, dry the combined extracts with anhydrous magnesium sulphate, and distil off the ether. The residue solidifies and consists of almost pure methyl β -naphthyl ketone, m.p. 52°; the yield is 30 g. Upon recrystallisation from glacial acetic acid, the m.p. is raised to 54°.

* For a more detailed discussion of this reaction, see Section IV, 164, Note 1.

2. Distil the dry (anhydrous magnesium sulphate) nitrobenzene solution under reduced pressure. Nitrobenzene passes over at 95–100°/16 mm. and the temperature then rises rapidly to 170°/15 mm.; collect the fraction of b.p. 170–180°/15 mm. Transfer whilst still liquid to a porcelain basin; it solidifies on cooling. Spread it on a porous tile to absorb the small proportion of liquid α -ketone which is present: the resulting yield of crude methyl β -naphthyl ketone, m.p. 40–42°, is 50 g. Two recrystallisations from glacial acetic acid (or from glacial acetic acid - water) give the almost pure β -ketone, m.p. 53°.

IV,137.

BUTYROPHENONE

Equip a 1500 ml. three-necked flask with an efficient mercury-sealed stirrer, a separatory funnel protected by a calcium chloride (or cotton wool) tube, and a double surface reflux condenser attached to a gas absorption device (Fig. II, 8, 1, c). Weigh out 140 g. of finely-powdered, anhydrous aluminium chloride under sodium-dried A.R. benzene, and transfer the solid to the flask already containing 231 g. (263 ml.) of anhydrous A.R. benzene. Place 105 g. (102 ml.) of *n*-butyryl chloride, b.p. 100–102° (Section III,87) in the separatory funnel, run in 3–4 ml. into the flask and stir vigorously. Warm the flask gently to start the reaction (*i.e.*, until hydrogen chloride is evolved), remove the source of heat, and continue the addition during 2 hours. The reaction mixture darkens considerably. Reflux for 30 minutes to complete the reaction and allow to cool. Transfer the reaction mixture to a large separatory funnel and allow it to "drip" into about 2 litres of cold water in a 4-litre beaker, cooled externally in an ice bath, and vigorously agitated with an efficient mechanical stirrer. Separate the upper oily layer, wash it with 10 per cent. sodium hydroxide solution, then with water, and dry over anhydrous magnesium sulphate. Remove the benzene (Fig. II, 13, 4, but use a 150 ml. Claisen flask), and distil the residue through an air condenser from an air bath. Collect the butyrophenone (a colourless liquid) at 227–230°. The yield is 75 g.

COGNATE PREPARATION

Propiophenone $C_6H_5COCH_2CH_3$. Use 231 g. (263 ml.) of sodium-dried A. R. benzene, 140 g. of anhydrous aluminium chloride and 90 g. (84.5 ml.) of propionyl chloride (prepared from propionic acid; compare Section III,87). The yield of propiophenone, b.p. 214–217°, is 78 g.

An improved yield is obtained by the following process. Add a mixture of 75 g. (70.5 ml.) of propionyl chloride and 90 g. (103 ml.) of sodium-dried A.R. benzene to a vigorously stirred suspension of 75 g. of finely-powdered anhydrous aluminium chloride in 100 ml. of dry carbon disulphide. Then introduce more of the aluminium chloride (about 15 g.) until no further evolution of hydrogen chloride occurs. The yield of propiophenone, b.p. 123°/25 mm., is about 90 g.

IV,138.

p-BROMOACETOPHENONE

In a 1-litre three-necked flask, equipped as in Section IV,137, place 78.5 g. (52.5 ml.) of dry bromobenzene (Section IV,18), 200 ml. of dry

carbon disulphide (*CAUTION* : see Section II,14) and 150 g. of finely powdered, anhydrous aluminium chloride. Stir the mixture and heat on a water bath until gentle refluxing commences ; add 51 g. (47.5 ml.) of redistilled acetic anhydride slowly through the dropping funnel (30-60 minutes). Maintain gentle refluxing during the addition of the acetic anhydride and for 1 hour afterwards. Distil off most of the carbon disulphide on a water bath (Fig. II, 41, 1 but with stirrer in position in the central aperture), allow the reaction mixture to cool somewhat and *while still warm* pour it slowly with stirring into a mixture of 500 g. of crushed ice and 300 ml. of concentrated hydrochloric acid. Decompose any residue in the flask and add it to the main product. Extract with 150 ml. and 100 ml. portions of benzene or ether, wash the combined extracts twice with water, once with 10 per cent. sodium hydroxide solution and twice with water. Dry the extract with anhydrous magnesium sulphate or calcium chloride, remove the solvent (Fig. II, 13, 4 but replace the distilling flask by a Claisen flask with fractionating side arm, Figs. II, 24, 2-5), and distil the residue under reduced pressure. The *p*-bromoacetophenone boils at 130°/15 mm. or at 117°/7 mm. and a 3° fraction should be collected ; it crystallises to a white solid, m.p. 50°. The yield is 75 g.

The b.p. under atmospheric pressure has been given as 255.5°/736 mm.

COGNATE PREPARATIONS

These are all prepared in the same manner, viz., 0.5 mol of the derivative of the aromatic hydrocarbon, 150 g. of finely-powdered anhydrous aluminium chloride and 0.5 mol of the acid anhydride. Thus :—

***p*-Chloroacetophenone.** From 56 g. (51 ml.) of chlorobenzene (Section IV,17). The yield of product, b.p. 124–126°/24 mm., m.p. 20–21°, is 60 g. The b.p. under atmospheric pressure is 237°.

***p*-Methoxyacetophenone.** From 54 g. (54.5 ml.) of anisole (Section IV,104). The yield of *p*-methoxyacetophenone, b.p. 139°/15 mm., is 70 g. The b.p. under atmospheric pressure is 265°.

IV,139.

BENZOPHENONE

Method 1. Into the three necks of a 1 litre three-necked flask fit respectively a double surface reflux condenser, an efficient mechanical stirrer, and through a two-hole cork, a separatory funnel and a thermometer. Attach a trap (Fig. II, 8, 1, c) to the top of the condenser for absorbing the hydrogen chloride evolved. Place 91 g. of powdered anhydrous aluminium chloride and 200 ml. of dry carbon tetrachloride (1) in the flask, surround the latter with an ice bath, and, when the temperature has fallen to 10–15°, introduce 10 ml. of sodium-dried A.R. benzene. The reaction commences immediately (hydrogen chloride is evolved and the temperature rises) ; add salt to the ice bath in order to get more efficient cooling. When the temperature commences to fall after the reaction has once started, add a mixture of 110 ml. of dry A.R. benzene and 110 ml. of dry carbon tetrachloride at such a rate that the temperature is maintained between 5° and 10° (2). The addition usually requires 1-2 hours ; continue the stirring for a further 3 hours while maintaining the temperature at 10°, and then allow to stand overnight.

Immerse the flask in ice, start the stirrer, and add about 500 ml. of water through the separatory funnel; the excess of carbon tetrachloride usually refluxes during the addition. Distil off as much as possible of the carbon tetrachloride on a water bath, and then distil the mixture with steam (Fig. II, 41, 1) during 30 minutes to remove the residual carbon tetrachloride (3) and to hydrolyse the benzophenone dichloride to benzophenone. Separate the upper benzophenone layer and extract the aqueous layer with 40 ml. of benzene. Dry the combined benzene extract and benzophenone with anhydrous magnesium sulphate. Remove the benzene with the aid of an air bath (Fig. II, 13, 4 but replace the distilling flask by a 200 ml. Claisen flask with fractionating side arm, Figs. II, 24, 2-5) until the temperature rises to about 90°, allow to cool somewhat, and distil under diminished pressure. Collect the benzophenone at 187-190°/15 mm.; it solidifies to a white solid, m.p. 47-48°, on cooling. The yield is 105 g.

Notes.

(1) The carbon tetrachloride may be dried by distilling the commercial product and rejecting the first 10 per cent. of the distillate.

(2) Below 5°, the reaction is too slow; above 10°, appreciable amounts of tarry matter are formed.

(3) About 220 ml. of carbon tetrachloride are recovered; this contains a little benzene, but may be used, after drying and distilling, in another run.

Method 2. Into a 500 ml. round-bottomed flask place 120 ml. of dry A.R. benzene, and 35 g. (29 ml.) of redistilled benzoyl chloride. Weigh out 30 g. of finely-powdered, anhydrous aluminium chloride into a dry corked test-tube, and add the solid, with frequent shaking, during 10 minutes to the contents of the flask. Fit a reflux condenser to the flask, and heat on a water bath for 3 hours or until hydrogen chloride is no longer evolved. Pour the contents of the flask while still warm into a mixture of 200 g. of crushed ice and 100 ml. of concentrated hydrochloric acid. Separate the upper benzene layer (filter first, if necessary), wash it with 50 ml. of 5 per cent. sodium hydroxide solution, then with water, and dry with anhydrous magnesium sulphate. Isolate the benzophenone as in *Method 1*. The yield is 30 g.

IV,140. BENZYLACETOPHENONE

Place a solution of 10.4 g. of benzalacetophenone, m.p. 57° (Section IV,130) in 75 ml. of pure ethyl acetate (Section II,47,19) in the reaction bottle of the catalytic hydrogenation apparatus and add 0.2 g. of Adams' platinum oxide catalyst (for full experimental details, see Section III,150). Displace the air with hydrogen, and shake the mixture with hydrogen until 0.05 mol is absorbed (10-25 minutes). Filter off the platinum, and remove the ethyl acetate by distillation. Recrystallise the residual benzylacetophenone from about 12 ml. of alcohol. The yield of pure product, m.p. 73°, is 9 g.

IV,141. METHYL BENZYL KETONE

Use the apparatus described in Section III,72 and adjust the furnace for a working temperature of 400-450°. Although a manganous oxide catalyst gives satisfactory results, thoria is more convenient in practice.

Preparation of thoria catalyst. Dissolve 276 g. of commercially pure thorium nitrate in the minimum volume of water (*ca.* 450 ml.) in a large beaker, and add slowly a solution of 106 g. of A.R. anhydrous sodium carbonate in 400 ml. of water with mechanical stirring. Allow the thorium carbonate to settle, decant as much as possible of the mother liquor, and wash it once by decantation with 500 ml. of water. Make the resulting moist precipitate into a thick paste with distilled water and stir in pumice (4–8 mesh) until most of the suspension appears to be absorbed. Dry the impregnated pumice in quantities of approximately 200 g. Heat in a large evaporating dish upon an electric hot plate and stir constantly with a thick glass rod; stop the heating when the fragments of pumice no longer stick one to another. Sieve the resulting pumice; 250 g. of a white powder (largely thorium carbonate but containing some oxide) are recovered, and can be used for impregnating more pumice. The total weight of pumice catalyst thus prepared is about 1400 g.; the exact weight will, of course, depend upon the grade of the pumice.

Preparation of the ketone. Fill the tube with thoria catalyst, but insert small loose plugs of glass wool after each approximately 15 cm. column of catalyst; the latter device will reduce the danger of carbonisation blocking the tube. Set up the apparatus as in Fig. III, 72, 1 and heat the tube to 400–450° in a slow stream of nitrogen when carbon dioxide (and generally oxides of nitrogen) are evolved; 6–12 hours are usually required for the complete decomposition of the thorium salt deposited upon the pumice. Place a solution of 170 g. of pure phenylacetic acid (m.p. 77°) in 225 g. of glacial acetic acid in the funnel, and adjust its rate of flow into the catalyst tube to 1 drop every 2 or 3 seconds. Also pass a slow stream of carbon dioxide or nitrogen (1 bubble per second) through the side tap in order to keep the gases in motion; the rate of flow is estimated by passing the inert gas through a concentrated sulphuric acid wash bottle or "bubbler" before it enters the furnace. When all the acid mixture has passed through the catalyst tube, separate the lower aqueous layer of the product and treat the organic layer with 10–20 per cent. sodium hydroxide solution until the washings are alkaline to litmus and then twice with water. Extract the aqueous layer twice with 50 ml. portions of benzene, wash the extracts successively with sodium hydroxide solution (until alkaline) and water, and add the resulting benzene solution to the main product. Dry with anhydrous magnesium sulphate, remove the benzene under atmospheric pressure, and distil the residue under reduced pressure preferably from a Claisen flask with fractionating side arm (Figs. II, 24, 2–5). Collect the methyl benzyl ketone at 102–102.5°/20 mm.; the yield is 85 g. The residue in the flask is dibenzyl ketone; it may be purified by transferring to a smaller flask and redistilling (b.p. 200°/21 mm.; m.p. 34–35°).

COGNATE PREPARATIONS

Ethyl benzyl ketone. Use 204 g. of phenylacetic acid (m.p. 77°) and 333 g. (335.5 ml.) of propionic acid (b.p. 139–141°), but omit the extraction with benzene when working up the distillate. Distil the dried

product from a 500 ml. round-bottomed flask through an efficient fractionating column {e.g., a Widmer column (Fig. II, 17, 1) or a well-lagged Hempel column filled with $\frac{3}{8}$ " or $\frac{1}{4}$ " glass rings (Fig. II, 15, 3) or a modified Hempel column (Fig. II, 15, 5)}. Collect the diethyl ketone at 99.5–102.5° (160 g.), and when the temperature rises to 130° (b.p. 103–130° : 7 g.) transfer the residue to a 250 ml. Claisen flask and distil under reduced pressure. The ethyl benzyl ketone passes over mainly at 118–123°/22 mm. (105 g.); the residue of high boiling point (34 g.) consists largely of dibenzyl ketone. Pure ethyl benzyl ketone may be obtained by redistilling the fraction b.p. 118–123°/22 mm. and collecting the fraction of b.p. 113–115°/17 mm.

***n*-Propyl benzyl ketone.** Use 204 g. of pure phenylacetic acid and 396 g. (414 ml.) of *n*-butyric acid (b.p. 161–164°). Upon working up as for ethyl benzyl ketone 180 g. of di-*n*-propyl ketone, b.p. 140–145° (mainly 143–145°), 108 g. of crude *n*-propyl benzyl ketone, b.p. 240–260°, and 49 g. of crude dibenzyl ketone (residue in flask) are obtained. Redistil the fraction of b.p. 240–260° and collect the *n*-propyl benzyl ketone at 243–247° (the pure ketone boils at 244°).

Methyl β -phenylethyl ketone. Use 100 g. of hydrocinnamic acid (m.p. 49–50°) (Section IV,163) and 160 g. of glacial acetic acid. The yield of methyl β -phenylethyl ketone, b.p. 230–235°, is 70 g. (the pure ketone boils at 234°).

Ethyl β -phenylethyl ketone. Use 100 g. of pure hydrocinnamic acid and 200 g. (201.5 ml.) of pure propionic acid. Fractionation of the distillate yields 70 g. of diethyl ketone (b.p. 100–102°), 72 g. of ethyl β -phenylethyl ketone (b.p. 245–249°; the pure ketone boils at 248°), and 18 g. of crude di- β -phenylethyl ketone (high b.p. residue).

***n*-Propyl β -phenylethyl ketone.** Use 100 g. of pure hydrocinnamic acid and 235 g. (245.5 ml.) of pure *n*-butyric acid. Upon working up as for ethyl benzyl ketone the following yields are obtained : 98 g. of di-*n*-propyl ketone, b.p. 140–144°; 65 g. of *n*-propyl β -phenylethyl ketone, b.p. 139–143°/17 mm.; and 22 g. of crude di- β -phenylethyl ketone (high b.p. residue). The required ketone, upon redistillation, boils almost completely at 138–139°/16 mm.

IV,142.

PHLOROACETOPHENONE

Place 25.2 g. of dry phloroglucinol (1), 16.4 g. (20.9 ml.) of anhydrous acetonitrile (Section III,111) (2), 100 ml. of sodium-dried ether and 5 g. of finely-powdered, fused zinc chloride in a 300 ml. bolt-head flask carrying a two-hole rubber stopper into which are fitted a wide gas delivery tube (an inverted thistle funnel is satisfactory) and a calcium chloride (or cotton wool) guard tube. Cool the flask in an ice-salt mixture and pass a rapid stream of dry hydrogen chloride (Section II,48,1) through the solution for 2 hours with occasional shaking. Allow the flask to stand in an ice chest for 24 hours, and again pass dry hydrogen chloride into the pale orange mixture for a further 2 hours. Stopper the flask and leave it in an ice chest (or refrigerator) for 3 days. A bulky orange-yellow precipitate of the ketimine hydrochloride is formed. Decant the ether

and wash the solid with two 25 ml. portions of anhydrous ether. Transfer the solid with the aid of about 1 litre of hot water to a 2 litre round-bottomed flask provided with a reflux condenser. Boil the yellow solution vigorously over a wire gauze for 2 hours, allow to cool somewhat, add 4–5 g. of decolourising carbon, boil the solution for 5 minutes longer, and filter the hot solution with suction through a preheated Buchner funnel. Extract the decolourising carbon with two 100 ml. portions of boiling water and add the filtrate to the main product. Allow to stand overnight, and filter the pale yellow or colourless needles of phloroacetophenone at the pump, dry at 120° to remove the molecule of water of crystallisation, and preserve in a tightly-stoppered bottle. The yield is 29 g., m.p. 217–219°. This product is pure enough for many purposes, but may be obtained absolutely pure by recrystallisation from hot water (35 ml. per gram) ; m.p. 218–219°.

Notes.

(1) Phloroglucinol contains two molecules of water of crystallisation ; these are removed by heating for 12 hours at 120°.

(2) The acetonitrile may be dried over anhydrous calcium sulphate or by distilling from phosphoric oxide.

IV,143.

α -TETRALONE

β -Benzoylpropionic acid. Equip a 1 litre three-necked flask with a mechanical stirrer and two efficient reflux condensers, and place in it 175 g. of sodium-dried A.R. benzene and 34 g. of succinic anhydride (Section III,92). Stir the mixture and add 100 g. of powdered, anhydrous aluminium chloride all at once. The reaction usually starts immediately—hydrogen chloride is evolved and the mixture becomes hot ; if there is no apparent reaction, warm gently. Heat in an oil bath to gentle refluxing, with continued stirring, for half an hour. Allow to cool, immerse the flask in a bath of cold water, and slowly add 150 ml. of water from a separatory funnel inserted into the top of one of the condensers. Introduce 50 ml. of concentrated hydrochloric acid and separate the benzene by steam distillation (Fig. II, 41, 1). Transfer the hot mixture to a 600 ml. beaker ; the β -benzoylpropionic acid separates as a colourless oil, which soon solidifies. Cool in ice, filter off the acid at the pump, and wash with 100 ml. of cold dilute hydrochloric acid (1 : 3 by volume) and then with 100 ml. of cold water. Dissolve the crude acid in a solution of 40 g. of anhydrous sodium carbonate in 250 ml. of water by boiling for 10–15 minutes ; filter the solution with suction to remove the small amount of aluminium hydroxide and wash with two 25 ml. portions of hot water. Treat the *hot* filtrate with 2 g. of decolourising carbon, stir for 5 minutes and filter at the pump through a preheated Buchner funnel. Transfer the hot filtrate to a 1 litre beaker, cool to about 50°, and cautiously acidify with 65–70 ml. of concentrated hydrochloric acid. Cool to 0° in a freezing mixture of ice and salt, filter, wash thoroughly with cold water, dry for 12 hours upon filter papers, and then to constant weight at 45–50°. The yield of practically pure β -benzoylpropionic acid, m.p. 115°, is 57 g.

γ -Phenylbutyric acid. Prepare amalgamated zinc from 120 g. of zinc wool contained in a 1-litre round-bottomed flask (Section III,50, 13), decant the liquid as completely as possible, and add in the following order 75 ml. of water, 180 ml. of concentrated hydrochloric acid, 100 ml. of pure toluene (1) and 50 g. of β -benzoylpropionic acid. Fit the flask with a reflux condenser connected to a gas absorption device (Fig. II, 8, 1, c), and boil the reaction mixture vigorously for 30 hours; add three or four 50 ml. portions of concentrated hydrochloric acid at approximately six hour intervals during the refluxing period in order to maintain the concentration of the acid. Allow to cool to room temperature and separate the two layers. Dilute the aqueous portion with about 200 ml. of water and extract with three 75 ml. portions of ether. Combine the toluene layer with the ether extracts, wash with water, and dry over anhydrous magnesium or calcium sulphate. Remove the solvents by distillation under diminished pressure on a water bath (compare Fig. II, 37, 1), transfer the residue to a Claisen flask, and distil under reduced pressure (Fig. II, 19, 1). Collect the γ -phenylbutyric acid at 178–181°/19 mm.; this solidifies on cooling to a colourless solid (40 g.) and melts at 47–48°.

Note.

(1) The procedure for the Clemmensen reduction is somewhat different from that previously described (Sections III,9, and IV,6); the chief modification of moment is the use of toluene. The concentration of organic material in the aqueous layer is considerably reduced; this results in less high b.p. products being formed, thus leading to a better yield of a purer product.

α -Tetralone. Place 32 g. of γ -phenylbutyric acid and 32 g. (20 ml.) of pure thionyl chloride (Section II,49,6) in a 500 ml. round-bottomed flask, fitted with a reflux condenser connected at its upper end by a tube leading to a gas absorption trap (Fig. II, 8, 1, c). Heat the mixture cautiously on a water bath until the acid melts, remove from the water bath, and allow the reaction to proceed. After about 30 minutes hydrogen chloride is no longer evolved: complete the reaction by warming on a water bath for 10 minutes. Connect the flask to a water pump (through an intermediate empty wash bottle to act as a trap), and remove the excess of thionyl chloride *completely* by first heating on a water bath for 10 minutes and then for 2–3 minutes over a small flame. The resulting γ -phenylbutyryl chloride (a nearly colourless liquid) requires no further purification.

To the cold acid chloride add 175 ml. of pure carbon disulphide, cool in ice, add 30 g. of powdered anhydrous aluminium chloride in one lot, and immediately attach a reflux condenser. When the evolution of hydrogen chloride ceases (about 5 minutes), slowly warm the mixture to the boiling point on a water bath. Reflux for 10 minutes with frequent shaking; the reaction is then complete. Cool the reaction mixture to 0°, and decompose the aluminium complex by the cautious addition, with shaking, of 100 g. of crushed ice. Then add 25 ml. of concentrated hydrochloric acid, transfer to a 2-litre round-bottomed flask and steam distil, preferably in the apparatus, depicted in Fig. II, 41, 3 since the α -tetralone is only moderately volatile in steam. The carbon disulphide passes over first, then there is a definite break in the distillation, after which the α -tetralone distils completely in about 2 litres of distillate.

Separate the oil, and extract the aqueous layer with three 100 ml. portions of benzene. Combine the oil and benzene extracts, dry with anhydrous magnesium sulphate, remove the solvent, and distil the residue under diminished pressure. Collect the α -tetralone at 105–107°/2 mm. (or at 135–137°/15 mm.). The yield is 23 g.

IV,144.

***o*-BENZOYLBENZOIC ACID**

Equip a 750 ml. three-necked flask with a mercury-sealed mechanical stirrer and a reflux condenser connected with a gas absorption trap (Fig. II, 8, 1, c); insert a rubber stopper in the third neck. Place 25 g. of pure phthalic anhydride (see Section III,170, Note 1) and 100 ml. of sodium-dried A.R. (or thiophene-free) benzene in the flask; start the stirrer and add 50 g. of powdered anhydrous aluminium chloride from a stoppered test-tube in four portions or, alternatively, use the device shown in Fig. II, 7, 12, c or d. If the reaction does not commence after the addition of the first 12 g. of aluminium chloride, warm for a few seconds on a water bath. Have an ice bath or wet towel in readiness should the reaction become too vigorous. When all the aluminium chloride has been added and the evolution of hydrogen chloride slackens, warm very cautiously on a water bath and ultimately reflux the mixture until the evolution of gas practically ceases. Cool the flask, add crushed ice slowly until the dark mass is completely decomposed, and then run in concentrated hydrochloric acid (35–40 ml.) until the solution clears. Steam distil (Fig. II, 41, 1) to remove the excess of benzene; the residue in the flask, when cooled in ice, largely solidifies and consists of crude *o*-benzoylbenzoic acid. Decant the aqueous solution through a Buchner funnel, wash the residue by decantation with a little cold water, and return the solid, collected on the filter, to the flask. Add a warm solution of 13.0 g. of anhydrous sodium carbonate in 200 ml. of water, and pass steam into the mixture until all the solid material, except particles of aluminium hydroxide and a little tarry material, dissolves; allow to cool slightly and add a few grams of decolourising carbon. Warm and filter the hot solution with suction. Place the filtrate in a 1 litre beaker, cool in ice, and cautiously acidify with concentrated hydrochloric acid while stirring well (16–17 ml. are required). The acid separates as an oil but it soon crystallises on stirring and cooling. Filter when ice cold, and wash with a little water. Dry in the air upon filter paper; the product, which is somewhat efflorescent, consists largely of the monohydrate, m.p. 94°.

To prepare pure anhydrous *o*-benzoylbenzoic acid, dissolve the air-dried (or the moist) product in about 175 ml. of benzene contained in a 500 ml. round-bottomed flask fitted with a reflux condenser and heat on a water bath. Transfer the benzene solution to a separatory funnel, run off any water present, and dry with anhydrous magnesium sulphate. Concentrate the benzene solution to about 75 ml. and add light petroleum. (b.p. 60–80°) to the hot solution until a slight turbidity is produced. Allow to cool spontaneously to room temperature, then cool in ice to about 5°, collect the crystals and dry. The yield of pure, anhydrous *o*-benzoylbenzoic acid, m.p. 128°, is 32 g.

COGNATE PREPARATION

***p*-Toluy-*o*-benzoic acid.** Use 25 g. of pure phthalic anhydride, 100 g. (115.5 ml.) of thiophene-free toluene and 50 g. of anhydrous aluminium chloride. The air-dried product consists largely of the monohydrate; this becomes anhydrous upon drying at 100° and melts at 138–139°. The yield of anhydrous *p*-toluy-*o*-benzoic acid is 39 g. It may be recrystallised from toluene.

IV,145.

ANTHRAQUINONE

Method 1. Mix 10 g. of *o*-benzoylbenzoic acid (preceding Section) with 90 g. (46 ml.) of fuming sulphuric acid (20 per cent. SO₃) in a 250 ml. round-bottomed flask protected by a calcium chloride (or cotton wool) guard tube. Heat upon a water bath with occasional shaking for 2 hours. Cool, and pour the reaction mixture into crushed ice contained in a 600 ml. beaker; heat the mixture to the boiling point for a few minutes in order to obtain a more granular product. Filter off the crude anthraquinone at the pump, wash it with hot water, then with a little dilute ammonia solution to remove any unchanged acid, and drain well. Recrystallise the product from boiling glacial acetic acid; filter off the purified crystals, wash with a little alcohol and dry at 100–120°. The yield of pure anthraquinone, m.p. 286°, is 7 g.

COGNATE PREPARATION

β -Methylantraquinone. Use 10.5 g. of *p*-toluy-*o*-benzoic acid (preceding Section) and 90 g. (46 ml.) of fuming sulphuric acid (20 per cent. SO₃). Recrystallise the product from alcohol in the presence of a little decolourising carbon. The yield of pure β -methylantraquinone, m.p. 176°, is 7.5 g.

Method 2. Dissolve 10 g. of finely-powdered, pure anthracene in 110–120 ml. of boiling glacial acetic acid contained in a 500 ml. round-bottomed flask provided with a reflux condenser. Prepare a solution of 20 g. of chromium trioxide in 15 ml. of water and then add 50–75 ml. of glacial acetic acid. Add the chromium trioxide solution slowly (during 1 hour) to the boiling anthracene solution by means of a separatory funnel fitted into the top of the condenser with a grooved cork; boil for a further 15 minutes. Allow the deep green solution to cool and pour it into 500 ml. of cold water. Filter the crude anthraquinone by *gentle* suction, wash with a little hot water, then with a hot *dilute* solution of sodium hydroxide and finally with cold water until the washings are colourless, and drain well. Recrystallise from glacial acetic acid as in *Method 1*. The yield is 11 g., m.p. 286°. Alternatively, dry the crude product in the steam oven, and sublime it from a small evaporating dish (compare Fig. II, 45, 1): beautiful yellow needles are obtained.

IV,146.

ANTHRONE

Place 52 g. of anthraquinone, 50 g. of granulated tin and 375 ml. of glacial acetic acid in a 1 litre round-bottomed flask fitted with a reflux condenser. Heat the contents of the flask to boiling and add 125 ml. of

concentrated hydrochloric acid in 10 ml. portions during 2 hours. By this time all the anthraquinone should have passed into solution; if not, add more tin and hydrochloric acid. Filter the liquid with suction through a sintered glass funnel, and add 50 ml. of water. Cool the solution to about 10° when the anthrone will crystallise out. Filter the crystals at the pump on a Buchner funnel and wash with water. Dry upon filter paper or upon a porous tile: the yield of crude anthrone, m.p. about 153°, is 40 g. Recrystallise from a 3 : 1 mixture of benzene and light petroleum, b.p. 60–80° (10–12 ml. per gram); this gives 30 g. of pure anthrone, m.p. 155°.

IV,147. BENZOPHENONE OXIME AND BECKMANN REARRANGEMENT

Place a mixture of 25 g. of benzophenone (Section IV,139), 15 g. of hydroxylamine hydrochloride, 50 ml. of rectified spirit and 10 ml. of water in a 500 ml. round-bottomed flask. Add 28 g. of sodium hydroxide (pellet form) in portions with shaking; if the reaction becomes too vigorous, cool the flask with running tap water. When all the sodium hydroxide has been added, attach a reflux condenser to the flask, heat to boiling and reflux for 5 minutes. Cool, and pour the contents of the flask into a solution of 75 ml. of concentrated hydrochloric acid in 500 ml. of water contained in a 1 litre beaker. Filter the precipitate at the pump, wash thoroughly with cold water, and dry in an electric oven at 40° or in a vacuum desiccator. The yield of benzophenone oxime, m.p. 142°, is 26.5 g. It may be recrystallised from methyl alcohol (4 ml. per gram) but the m.p. is unaffected. The oxime is gradually decomposed by oxygen and traces of moisture into benzophenone and nitric acid; it should be preserved in a vacuum desiccator filled with pure dry carbon dioxide.

Beckmann rearrangement of benzophenone oxime to benzanilide. Dissolve 2 g. of benzophenone oxime in 20 ml. of anhydrous ether in a small conical flask and add 3 g. of powdered phosphorus pentachloride (or 3 ml. of pure thionyl chloride). Distil off the solvent and other volatile products on a water bath (*CAUTION*: ether), add 25 ml. of water, boil for several minutes and break up any lumps which may be formed. Decant the supernatant liquid, and recrystallise, in the same vessel, from boiling alcohol. The product is benzanilide, m.p. 163°; confirm this by a mixed m.p. determination with an authentic specimen.

IV,148. REACTIONS AND CHARACTERISATION OF AROMATIC KETONES

Aromatic ketones usually have relatively high boiling points, but distil with little or no decomposition. Many are solids. The vapours generally burn with a smoky flame. They react with the 2 : 4-dinitrophenyl hydrazine reagent (Section III,74,1) or with the phenylhydrazine reagent

(Section IV,135,5), but are unaffected by the dimedone reagent (Section III,70, 2). The general reactions are similar to those already given under *Aliphatic Ketones* (Section III,74). Owing to their higher molecular weight, such derivatives as oximes and phenylhydrazones are frequently quite satisfactory.

The preparation of crystalline derivatives, including 2:4-dinitrophenyl hydrazones, semicarbazones, oximes, phenylhydrazones and *p*-nitrophenylhydrazones can be carried out as described under *Aromatic Aldehydes*, Section IV,135.

The melting points of various derivatives of a number of typical aromatic ketones are collected in Table IV,148.

TABLE IV,148.

AROMATIC KETONES

Ketone	B.P.	M.P.	2 : 4-Dinitrophenylhydrazones	Semicarbazone	Oxime	Phenylhydrazones	<i>p</i> -Nitrophenylhydrazones	Other Derivatives
Acetophenone	202°	20°	250°(237)	199°	59°	105°	185°	Benzal, 58°
<i>o</i> -Chloroacetophenone	229	—	206	160 (179)	113	—	215	—
<i>m</i> -Chloroacetophenone	228	—	—	232	88	—	176	—
<i>p</i> -Chloroacetophenone	236	20	231	201	95	114	239	—
<i>o</i> -Bromoacetophenone	112°/10	—	—	177	—	—	—	—
<i>m</i> -Bromoacetophenone	131°/16	8	—	238	—	—	—	—
<i>p</i> -Bromoacetophenone	256	51	230	208	129	126	—	—
<i>p</i> -Iodoacetophenone	—	85	—	—	—	—	—	—
<i>o</i> -Methylacetophenone (1)	216	—	159	203	61	—	—	—
<i>m</i> -Methylacetophenone	220	—	207	198	55	—	—	—
<i>p</i> -Methylacetophenone	224	28	258	205	88	96	198	—
<i>o</i> -Hydroxyacetophenone	215	—	—	210	117	110	—	—
<i>m</i> -Hydroxyacetophenone	—	96	—	195	—	—	—	—
<i>p</i> -Hydroxyacetophenone	—	109	261	199	145	151	—	—
<i>o</i> -Methoxyacetophenone	245	—	—	183	83	114	—	—
<i>m</i> -Methoxyacetophenone	240	—	—	196	—	—	—	—
<i>p</i> -Methoxyacetophenone	258	39	220	198	87	142	—	—
<i>o</i> -Nitroacetophenone	159°/16	—	—	—	—	—	—	—
<i>m</i> -Nitroacetophenone	—	81	228	257	132	135	—	—
<i>p</i> -Nitroacetophenone	—	81	—	—	—	132	—	—
<i>o</i> -Aminoacetophenone	251	20	—	290	109	108	—	—
<i>m</i> -Aminoacetophenone	—	99	—	196	148	—	—	—
<i>p</i> -Aminoacetophenone	294	106	—	250	—	—	—	—
Resacetophenone (2)	—	147	—	218	199	159	—	Dibenzoyl, 81 ; diacetyl, 38
Phloracetophenone (3)	—	219	—	—	—	—	—	Tribenzoyl, 118 ; triacetyl, 103
Propiophenone (4)	218	19	191	174	53	147	—	—
<i>n</i> -Butyrophenone (5)	230	12	190	188	50	—	—	—
<i>iso</i> -Butyrophenone (6)	222	—	163	181	94	73	—	—
<i>n</i> -Valerophenone (7)	242	—	166	166	52	162	—	—
Benzyl methyl ketone	216	27	156	198	69	87	145	—
Benzyl ethyl ketone	226	—	—	136	—	—	—	—

TABLE IV,148.

AROMATIC KETONES (*continued*)

Ketone	B.P.	M.P.	2 : 4-Dinitrophenyl-hydrazone	Semi-carbazone	Oxime	Phenyl-hydrazone	<i>p</i> -Nitrophenyl-hydrazone	Other Derivatives
Benzophenone	306°	49°	238°	165°	144°	137°	155°	—
<i>p</i> -Chlorobenzophenone	323	78	185	—	156 (95)	106	—	—
<i>p</i> -Bromobenzophenone	350	82	230	—	169	126	—	—
Desoxybenzoin (8)	320	60	204	148	98	116	163	Benzal, 102°
Dibenzyl ketone	331	35	100	146	125	129	—	Benzal, 162
Phenyl <i>p</i> -tolyl ketone	326	60	200	122	154	109	—	—
Di- <i>p</i> -tolyl ketone	335	95	229	—	163	100	—	—
Methyl α -naphthyl ketone	302	34	—	229	139	146	—	Picrate, 116 ; benzal, 126
Methyl β -naphthyl ketone	301	54	262	236	145	177	—	Picrate, 85
Benzoin	344	137	245	206	151 (99)	159	—	Benzoyl, 125 ; acetyl, 83
Benzil	347d	95	189	244Di	237	235Di	290	Quinoxaline, 126
Benzalacetone	262	42	227	186	116	157	166	Benzal, 112
Dibenzalacetone (9)	—	112	180	189	143	153	173	Picrate, 114
Benzalacetophenone (10)	347	58	245	168	115	119	—	Picrate, 97
Phenacyl alcohol (11)	—	86	—	146	70	112	—	Benzoyl, 118 ; acetyl, 49
Phenacyl bromide (12)	—	51	—	146	89	—	—	—
<i>p</i> -Bromophenacyl bromide	—	109	—	—	115	—	—	—
α -Hydrindone	242	42	258	233	146	128	235	Benzal, 113
α -Tetralone	129°/12	—	257	217	89 (103)	84	231	Benzal, 105
Fluorenone (13)	341	83	284	—	195	152	269	—
Acenaphthenone	—	121	—	—	175	90	—	Picrate, 113
<i>p</i> -Benzoquinone	—	116	186	243Di	140	—	—	Picrate, 79
1 : 2-Naphthaquinone	—	146	—	184	162	138	235	—
1 : 4-Naphthaquinone	—	125	—	247	198	—	278	—
Anthraquinone	—	285	—	—	224	183	—	—
9 : 10-Phenanthraquinone	—	207	313	—	158	165	245	—

(1) Methyl *o*-tolyl ketone.

(2) 2 : 4-Dihydroxyacetophenone.

(3) 2 : 4 : 6-Trihydroxyacetophenone.

(4) Ethyl phenyl ketone.

(5) *n*-Propyl phenyl ketone.(6) *iso*-Propyl phenyl ketone.(7) *n*-Butyl phenyl ketone.

(8) Phenyl benzyl ketone.

(9) Distyryl ketone.

(10) Chalkone.

(11) ω -Hydroxyacetophenone.(12) ω -Bromoacetophenone.

(13) Diphenylene ketone.

QUINONES

p-Benzoquinone ("quinone") is obtained as the end product of the oxidation of aniline by acid dichromate solution. Industrially, the crude product is reduced with sulphur dioxide to hydroquinone, and the latter is oxidised either with dichromate mixture or in very dilute sulphuric acid solution with sodium chlorate in the presence of a little vanadium pentoxide as catalyst. For the preparation in the laboratory, it is best to oxidise the inexpensive hydroquinone with chromic acid or with sodium chlorate in the presence of vanadium pentoxide. Naphthalene may be converted into 1:4-naphthoquinone by oxidation with chromic acid.

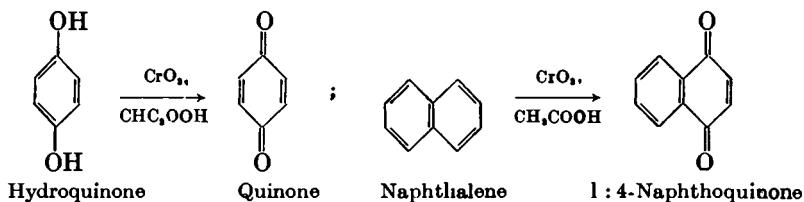

A fairly general procedure consists in coupling a phenol or naphthol with a diazotised amine, reducing the product to an aminophenol or aminonaphthol, and oxidising the hydroxy compound with acid ferric chloride solution. This method is illustrated by the preparation of β (or 1:2)-naphthoquinone:

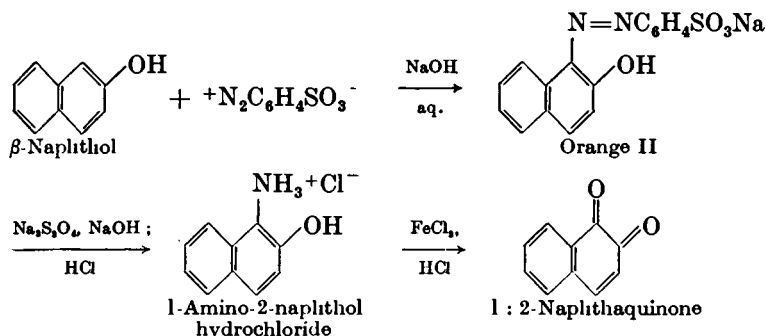

When a solution of, say, 1 g. of hydroquinone in 4 ml. of rectified spirit is poured into a solution of 1 g. of quinone in 30 ml. of water, quinhydrone $\text{C}_6\text{H}_4\text{O}_2 \cdot \text{C}_6\text{H}_4(\text{OH})_2$, a complex of equimolecular amounts of the two components, is formed as dark green crystals having a glistening metallic lustre, m.p. 172° . In solution, it is largely dissociated into quinone and hydroquinone. Quinhydrone is more conveniently prepared by the partial oxidation of hydroquinone with a solution of iron alum.

The preparation of anthraquinone and of β -methylanthraquinone is described in Section IV, 145.

IV, 149. *p*-BENZOQUINONE ("QUINONE")

Method 1. Cool a solution of 33 g. of hydroquinone in 150 ml. of 60 per cent. acetic acid contained in a 600 ml. beaker to below 5° in an ice bath. Dissolve 42 g. of chromic anhydride in 70 ml. of water, and add 30 ml. of glacial acetic acid. By means of a separatory funnel with bent stem and supported over the beaker, add the chromic anhydride solution

to the mechanically-stirred hydroquinone solution at such a rate that the temperature does not rise above 10° ; the addition takes about 2 hours. Filter the mixture at once and wash the quinone several times with 10 ml. portions of ice cold water. Spread the material upon filter paper until dry, but no longer or the quinone will be lost through sublimation. The yield of quinone (a bright yellow crystalline solid), m.p. 115° , is 21 g.; it darkens when exposed to light.

Impure quinone may be purified by placing it in a distilling flask attached to a condenser and passing a rapid current of steam into the flask: the quinone sublimes and collects in the receiver. It is separated from the water by filtration and dried; the m.p. is 116° . The vapour has a penetrating odour and attacks the eyes.

Method 2. In a 1 litre round-bottomed flask, provided with a mechanical stirrer, place 0.5 g. of vanadium pentoxide (catalyst), 500 ml. of 2 per cent. sulphuric acid, 55 g. of hydroquinone and 30 g. of sodium chlorate. Stir the mixture vigorously for about 4 hours. Greenish-black quinhydrone is first formed and this is converted into yellow quinone; the temperature of the mixture rises to about 40° (do not allow it to exceed this temperature). Cool the flask in running water, filter the mixture at the pump, and wash it with 50 ml. of cold water. Dry the quinone upon filter paper in the air (see *Method 1*) or in a desiccator over anhydrous calcium chloride. The yield is 45 g., m.p. $111-112^{\circ}$. The crude quinone may be purified by steam distillation as in *Method 1*, or by recrystallisation from boiling light petroleum, b.p. $100-120^{\circ}$ (12 ml. per gram): the resulting pure, bright yellow quinone has m.p. 115° and the recovery is about 95 per cent.

COGNATE PREPARATION

1 : 4-Naphthoquinone. Place a solution of 120 g. of pure chromium trioxide in 150 ml. of 80 per cent. aqueous acetic acid in a 2-litre three-necked flask, fitted with a thermometer, mechanical stirrer and 1-litre dropping funnel. Surround the flask by a mixture of ice and salt and, when the temperature has fallen to 0° , add a solution of 64 g. of pure naphthalene in 600 ml. of glacial acetic acid, with constant stirring, over a period of 2-3 hours whilst maintaining the internal temperature at $10-15^{\circ}$. Continue the stirring overnight, during which time the reaction mixture and bath attain room temperature. Allow the dark green solution to stand for 3 days and stir occasionally. Pour the reaction mixture into 5-6 litres of water, collect the crude naphthoquinone by suction filtration, wash with 200 ml. of water and dry in a desiccator. Recrystallise from 500 ml. of petroleum ether (b.p. $80-100^{\circ}$). The yield of pure 1 : 4-naphthoquinone, m.p. $124-125^{\circ}$, is 17 g.

IV,150.

1 : 2-NAPHTHOQUINONE

Place 20 g. of Orange II (Section IV,79) in a 600 ml. beaker and dissolve it in 250 ml. of water at $40-50^{\circ}$. Add, with stirring, 24-25 g. of sodium hyposulphite ($\text{Na}_2\text{S}_2\text{O}_4$); this discharges the colour and yields a pink or cream-coloured, finely-divided precipitate of α -amino- β -naphthol (compare Section IV,76). Heat the mixture nearly to boiling until it commences to froth considerably, then cool to 25° in ice, filter on a

Buchner funnel and wash with a little cold water. Transfer the precipitate to a beaker containing a solution of 0.25 g. of stannous chloride in 5 ml. of concentrated hydrochloric acid diluted with 100 ml. of water; upon stirring the aminonaphthol dissolves and a small amount of insoluble matter remains. The function of the stannous chloride is as an anti-oxidant, preventing the readily oxidisable aminonaphthol hydrochloride from undergoing appreciable change. Stir the solution for 5 minutes with 2 g. of decolourising carbon, and filter at the pump. If crystalline material should separate at any stage, dissolve it by warming and by the addition of a little water if necessary. Transfer the clear solution to a beaker, add 25 ml. of concentrated hydrochloric acid and warm until the solid dissolves. Cool to 0°, filter the almost colourless crystals of the aminonaphthol hydrochloride with suction, and wash with 25 ml. of dilute hydrochloric acid (1 : 4 by volume). *From this point all operations must be carried out rapidly.* In the meantime, prepare the oxidising solution by dissolving 30 g. of crystallised ferric chloride in a mixture of 10 ml. of concentrated hydrochloric acid and 25 ml. of water by heating, cool to room temperature by adding *ca.* 30 g. of crushed ice, and filter the solution at the pump. Wash the crystalline 1 : 2-aminonaphthol hydrochloride into a 600 ml. beaker with water, add 150 ml. of water and a few drops of concentrated hydrochloric acid, and dissolve the precipitated solid by stirring and warming to about 35°. If necessary, filter rapidly by suction from a trace of residue, transfer to a 500 ml. round-bottomed flask, add the ferric chloride solution all at once whilst shaking the flask vigorously. The quinone separates rapidly as a voluminous micro-crystalline yellow precipitate. Filter on a Buchner funnel and wash it thoroughly with water at 30° to remove all traces of acid. Dry the product upon filter paper in an atmosphere free from acid fumes. The yield of β -naphthoquinone, which melts with decomposition at 145–147°, is 7 g. It should not be powdered, for it becomes highly electrified.

IV,151.

QUINHYDRONE

Dissolve 100 g. of iron alum (ferric ammonium sulphate) in 300 ml. of water at 65°. Pour the solution, with stirring, into a solution of 25 g. of hydroquinone in 100 ml. of water contained in a 600 ml. beaker. The quinhydrone is precipitated in fine needles. Cool the mixture in ice, filter with suction, and wash three or four times with cold water. Dry in the air between filter paper. The yield of quinhydrone, m.p. 172°, is 15 g. It contains a trace of iron, but this has no influence upon the e.m.f. of the quinhydrone electrode provided that the washing of the crude material has been thorough. The quinhydrone should be stored in a tightly-stoppered bottle.

IV,152.

REACTIONS AND CHARACTERISATION
OF QUINONES

The number of quinones normally encountered in routine qualitative organic analysis is very limited; the following notes will be found useful for their detection and characterisation.

(i) **General properties.** All quinones are coloured (generally yellow) crystalline solids. They are usually insoluble in water, soluble in ether, and sublime on heating. Frequently the vapour has a penetrating odour and attacks the eyes. The carbonyl groups of quinones often do not react in a normal manner with carbonyl group reagents, because of their oxidising properties: thus quinones are reduced by sodium bisulphite. Crystalline products are usually formed with one molecule of phenylhydrazine and of 2 : 4-dinitrophenylhydrazine, but these are not always of normal structure. Thus *p*-benzoquinone reacts with 2 : 4-dinitrophenylhydrazine hydrochloride in hot alcoholic solution to give 2' : 4'-dinitrobenzene-azophenol-4, m.p. 185-186° :

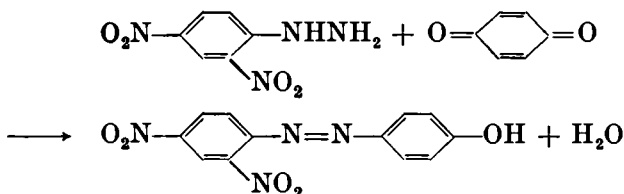

(ii) **Sodium hydroxide solution.** Dark solutions are formed on warming owing to decomposition. Upon acidification, an amorphous solid may be precipitated.

(iii) **Hydriodic acid.** Compounds of the *p*-benzoquinone type liberate iodine from hydriodic acid.

Dissolve 0.1 g. of the quinone in a little rectified spirit. Add 10 ml. of 10 per cent. aqueous potassium iodide solution to a mixture of 5 ml. of alcohol and 5 ml. of concentrated hydrochloric acid, and then introduce the quinone solution. Iodine is liberated immediately. This test is also given by other oxidising agents.

(iv) **Reduction with zinc powder and acid.** Simple *p*-quinones are reduced to hydroquinones in the following manner. Dissolve or suspend 0.5 g. of the quinone in dilute hydrochloric acid (1 : 5) and add a little zinc powder. When the solution is colourless, filter, neutralise with sodium bicarbonate, extract the dihydric phenol with ether, remove the solvent, and identify (Section IV,114).

Sulphurous acid produces a similar result, but some hydroquinone sulphonic acid is simultaneously produced.

(v) **Reduction with zinc powder and caustic alkali.** Compounds of the anthraquinone type are reduced to oxanthrols (compare Section IV,146).

Treat 0.1 g. of the quinone with dilute sodium hydroxide and zinc powder. Upon boiling the mixture a red colour is produced : this disappears when the solution is shaken owing to aerial oxidation to the original quinone.

(vi) **Distillation with zinc powder.** Quinones derived from polycyclic hydrocarbons may be reduced to the parent hydrocarbon as follows. Grind 0.5 of the compound with 3-4 g. of zinc powder, pour the mixture into a Pyrex test-tube and cover it with an equal volume of zinc powder. Clamp the tube horizontally at the open end. Heat the zinc powder first, then the mixture of zinc powder and the compound to a dull red heat : the hydrocarbon sublimes into the cooler part of the tube. Remove the sublimate ; determine the m.p. and identify it by the preparation of the picrate (Section IV,9).

(vii) **Reaction with semicarbazide hydrochloride.** Many simple quinones yield crystalline mono-semicarbazones by the following procedure. Dissolve 0.2 g. of semicarbazide hydrochloride in a little water, add 0.2 g. of the quinone and warm. The mono-semicarbazone is immediately formed as a yellow precipitate. Filter and recrystallise from hot water ; any di- (or *bis*-) semicarbazone will remain undissolved.

Ortho quinones (and also aromatic α -diketones, e.g., benzil) react with *o*-phenylenediamine to yield quinoxalines as follows. Dissolve the substance

in alcohol or in glacial acetic acid, add an equivalent amount of *o*-phenylenediamine in alcoholic solution and warm for 15 minutes on a water bath. Cool, dilute with water, filter and recrystallise from dilute alcohol. The quinoxaline from phenanthraquinone has m.p. 217°; from benzil, 124°.

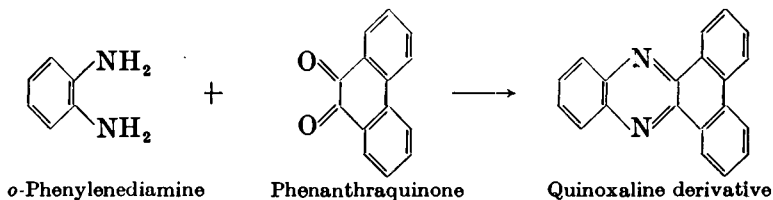

CHARACTERISATION

1. Reduction to hydroquinone. Dissolve, or suspend, 0.5 g. of the quinone in 5 ml. of ether or benzene and shake vigorously with a solution of 1.0 g. of sodium hydrosulphite ($\text{Na}_2\text{S}_2\text{O}_4$) in 10 ml. of *N* sodium hydroxide until the colour of the quinone has disappeared. Separate the alkaline solution of the hydroquinone, cool it in ice, and acidify with concentrated hydrochloric acid. Collect the product (extract with ether, if necessary) and recrystallise it from alcohol or water.

2. Reductive acetylation. Suspend 0.5 g. of the quinone in 2.5 ml. of pure acetic anhydride, and add 0.5 g. of zinc powder and 0.1 g. of powdered, anhydrous sodium acetate. Warm the mixture gently until the colour of the quinone has largely disappeared and then boil for 1 minute. Add 2 ml. of glacial acetic acid and boil again to dissolve the product and part of the precipitated zinc acetate. Decant the hot solution from the zinc acetate and zinc, and wash the residue with 3–4 ml. of hot glacial acetic acid. Combine the solutions, heat to boiling, carefully add sufficient water to hydrolyse the acetic anhydride and to produce a turbidity. Cool the mixture in ice, filter off the diacetate of the hydroquinone, and recrystallise it from dilute alcohol or from light petroleum.

3. Thiele acetylation. Quinones, when treated with acetic anhydride in the presence of perchloric acid or of concentrated sulphuric acid, undergo simultaneous reductive acetylation and substitution to yield triacetoxy derivatives, *e.g.*, benzoquinone gives 1 : 2 : 4-triacetoxybenzene.

Add 0.1 ml. of concentrated sulphuric acid or of 72 per cent. perchloric acid cautiously to a cold solution of 0.01 mol (or 1.0 g.) of the quinone in 3–5 ml. of acetic anhydride. Do not permit the temperature to rise above 50°. Allow to stand for 15–30 minutes and pour into 15 ml. of water. Collect the precipitated solid and recrystallise it from alcohol.

The properties of a number of quinones are summarised in Table IV, 152.

TABLE IV,152.

QUINONES

Quinone	M.P.	Semi-carbazone	Oxime	Hydro-quinone	Diacetate of hydro-quinone	Thiele acetylation product	Other Derivatives
Thymoquinone	45°	204°	162°	143°	74°	—	—
<i>p</i> -Toluquinone	69	179	135	124	52	114°	—
2-Methylnaphthoquinone (1 : 4)	106	247	167	—	—	113	—
Duroquinone	112	—	—	239	207	—	—
<i>p</i> -Benzoquinone	116	243d	240d	171	123	97	Picrate, 179°
α -Naphthoquinone (1 : 4)	125	247	198	176	128	135	—
β -Naphthoquinone (1 : 2)	146d	184	162	103	105	135	—
β -Methylantraquinone	177	—	—	—	217	—	—
<i>o</i> -Toluquinone	195	—	140	—	—	—	—
Camphorquinone	199	236	170	—	—	—	Quinoxaline, 78
Quinizarin	201	—	—	—	—	207	—
9 : 10-Phenanthraquinone	206	220d	158	148	202	—	Quinoxaline, 220
Acenaphthenequinone	261	192	222 Di	—	—	—	Quinoxaline, 241
Antraquinone	286	—	224	180	260	—	—
Chloranil (1)	290*	—	—	232	251	—	—
Alizarin	290	—	—	—	182	—	—

(1) Tetrachloro-*p*-benzoquinone.

* Sealed tube.

AROMATIC CARBOXYLIC ACIDS

Aromatic carboxylic acids may be prepared :—

1. By the oxidation of a side chain, provided the molecule contains no other groups (*e.g.*, amino NH_2 and hydroxyl OH) which are affected by oxidising agents, for example :

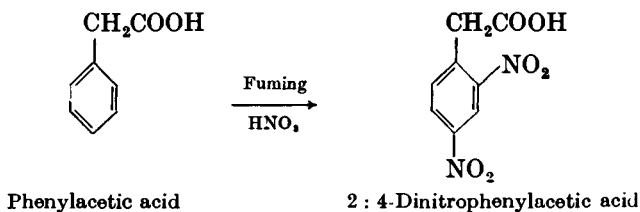
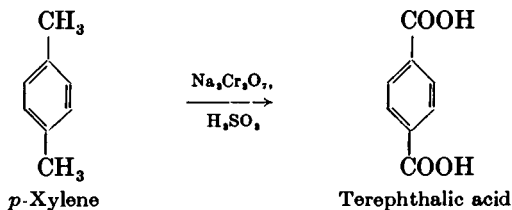
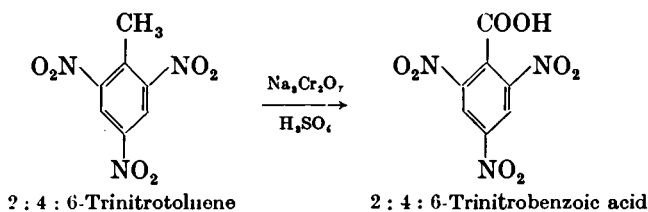
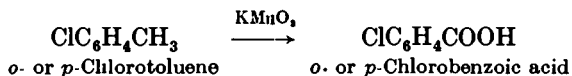
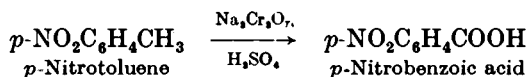
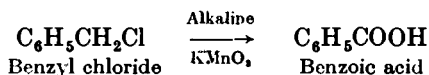

The last example illustrates nitration by means of fuming nitric acid with retention of the side chain.

2. By the hydrolysis of nitriles. The nitriles may be easily prepared either from amines by the Sandmeyer reaction (Section IV,66) or by the action of cuprous cyanide upon aryl halides (compare Section IV,163). Benzyl cyanide

is conveniently obtained by the action of aqueous-alcoholic sodium cyanide upon benzyl chloride. The following examples are given :—

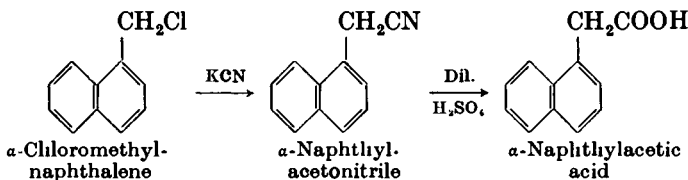
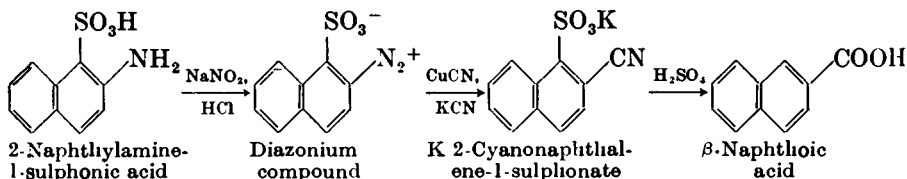
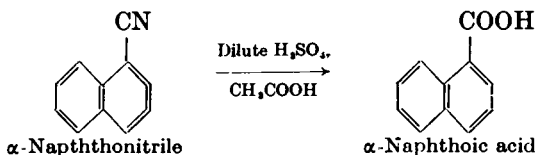
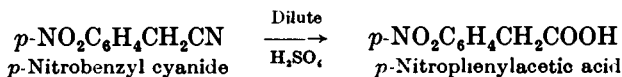
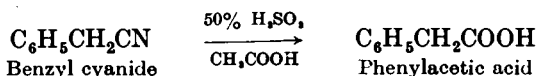
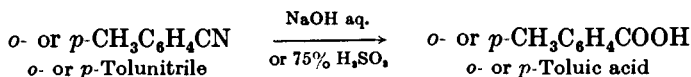

α -Naphthylacetic acid is an important growth promoting plant hormone.

The hydrolysis of arylacetonitriles may be arrested at the arylacetamide stage by treatment with concentrated hydrochloric acid at about 40°; thus benzyl cyanide yields phenylacetamide :

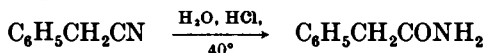

3. By carbonation of Grignard reagents, for example :

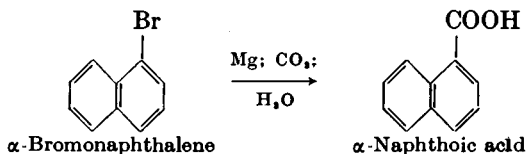
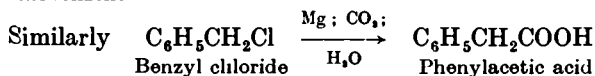
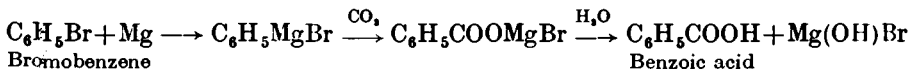

4. By the hypohalite oxidation of aceto compounds, for example :

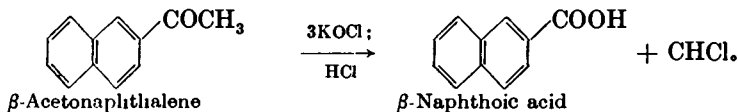

5. By the malonic ester synthesis (compare Section III,165), for example :

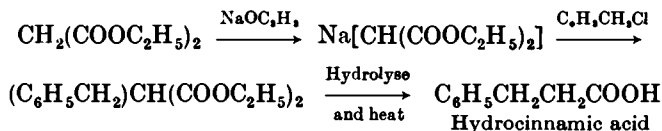

Hydrocinnamic acid may also be prepared by the reduction of cinnamic acid with sodium and alcohol or with sodium amalgam or with hydrogen in the presence of Adams' platinum oxide catalyst (Section III,150) :

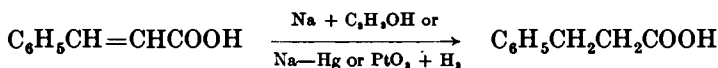

The preparation of a number of miscellaneous acids is described.

***m*-Nitrobenzoic acid.** Although *m*-nitrobenzoic acid is the main product of the direct nitration of benzoic acid with potassium nitrate and concentrated sulphuric acid, the complete separation of the small quantity of the attendant *para* isomer is a laborious process. It is preferable to nitrate methyl benzoate and hydrolyse the resulting methyl *m*-nitrobenzoate, which is easily obtained in a pure condition :

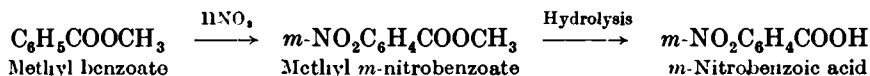

3:5-Dinitrobenzoic acid. This acid may be prepared by the nitration of benzoic acid with a mixture of concentrated sulphuric acid and fuming nitric acid under special conditions (see also Section VII,22) :

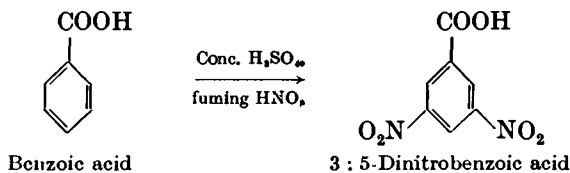

Homophthalic acid. This is a four-stage preparation with phthalic anhydride as the starting material :

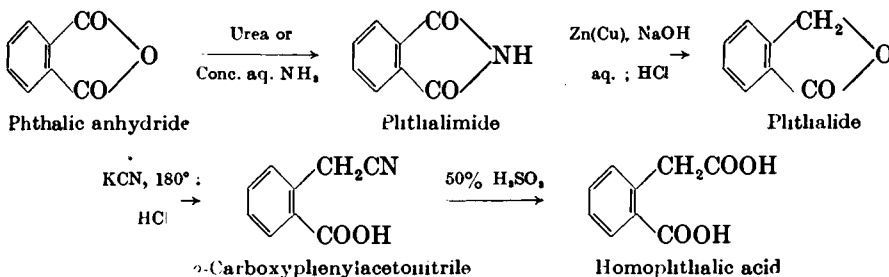

Anthranilic acid. This substance, the *ortho* amino derivative of benzoic acid, may be conveniently prepared by the action of sodium hypobromite (or sodium hypochlorite) solution upon phthalimide in alkaline solution at 80°. The ring in phthalimide is opened by hydrolysis to phthalamidic acid and the latter undergoes the Hofmann reaction (compare Section III, 116) :

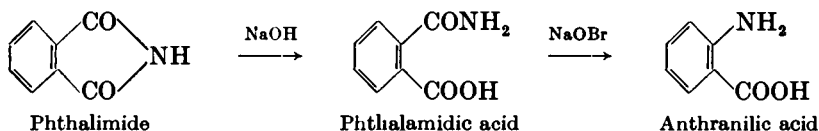

Diphenylacetic acid. The reduction of benzilic acid with red phosphorus and a little iodine in 98 per cent. acetic acid solution yields diphenylacetic acid :

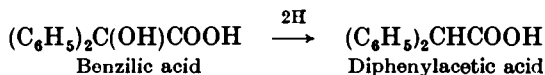

It is believed that the red phosphorus is the true reducing agent and the iodine (or iodide) functions as a hydrogen carrier. This procedure replaces the obsolete method of heating with red phosphorus and concentrated hydriodic acid in a sealed tube.

Mandelic acid. This preparation is an example of the synthesis of an α -hydroxy acid by the cyanohydrin method. To avoid the use of the very volatile and extremely poisonous liquid hydrogen cyanide, the cyanohydrin (mandelonitrile) is prepared by treatment of the sodium bisulphite addition compound of benzaldehyde (not isolated) with sodium cyanide :

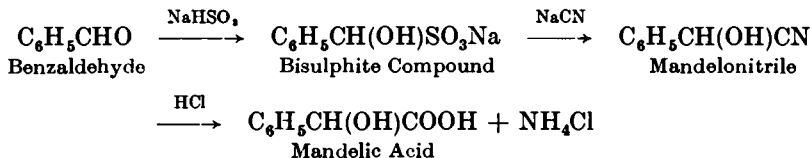

Salicylic acid. The preparation of salicylic acid by passing carbon dioxide into dry sodium phenoxide at 170-190° is the classical example of the Kolbe-Schmitt reaction. The latter is a method for introducing a carboxyl group directly into a phenol nucleus.

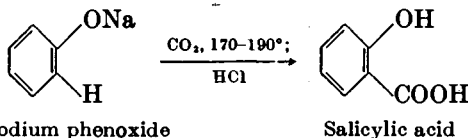

The reaction is particularly facile with di- and tri-hydric phenols. Thus β -resorcylic acid is readily obtained by passing carbon dioxide through a boiling aqueous solution of the potassium or sodium salt of resorcinol :

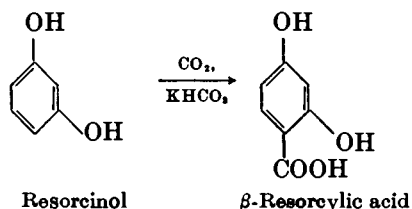

The *mechanism* of the reaction appears to involve the attack by an activated carbon dioxide molecule at the activated *ortho* position in the phenoxide ion :

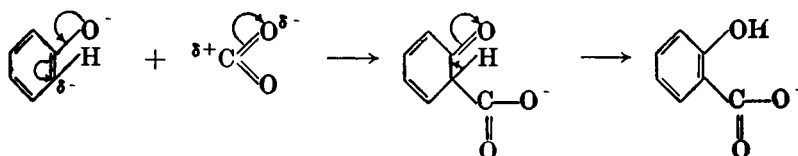

It is of interest to record that *p*-hydroxybenzoic acid may be prepared by the thermal rearrangement of potassium salicylate at 230° ;

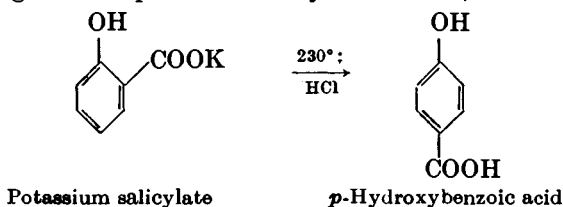

Phenylpropionic acid. This is an example of an aromatic acetylenic acid, and is made by adding bromine to the ethylenic linkage in ethyl cinnamate, and treating the resulting dibromide with alcoholic potassium hydroxide which eliminates two molecules of hydrogen bromide :

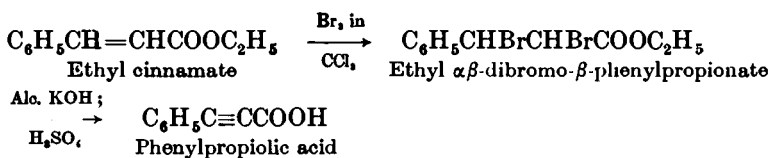

Diphenic acid. Phenanthrene upon oxidation in acetic acid solution at 85° with 30 per cent. hydrogen peroxide gives diphenic acid (diphenyl-2 : 2'-dicarboxylic acid) : no phenanthraquinone is formed under these experimental conditions. The reaction is essentially an oxidation of phenanthrene with *peracetic acid*. (For another method of preparation, see Section IV,74.)

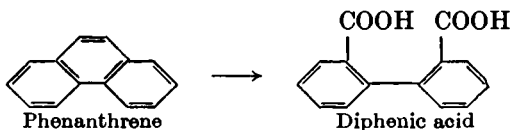

IV,153.

BENZOIC ACID

From Benzyl Chloride

Method 1. Into a 500 ml. bolt-head flask equipped with a reflux condenser, place 4 g. of anhydrous sodium carbonate, 200 ml. of water, 9 g. of potassium permanganate, 5 g. (4.5 ml.) of benzyl chloride (Section IV, 22) and a few chips of porous porcelain. Boil the mixture gently until the reaction is complete (60–90 minutes), *i.e.*, until the liquid running down from the condenser contains no oily drops of unchanged benzyl chloride. Manganese dioxide is precipitated. Allow to cool, acidify with concentrated hydrochloric acid (about 40 ml.), and add a 20 per cent. aqueous solution of crystallised sodium sulphite ($Na_2SO_3 \cdot 7H_2O$) with shaking until the manganese dioxide is completely dissolved and only the white

precipitate of benzoic acid remains. When the mixture is cold, filter off the benzoic acid at the pump and wash it with cold water. Recrystallise from boiling water. The benzoic acid is obtained as colourless needles, m.p. 121.5° . The yield is 4 g.

Method 2. Into a 250 ml. bolt-head flask provided with a reflux condenser, place 10 g. (9 ml.) of benzyl chloride, 50 ml. of water, 20 ml. of concentrated nitric acid and a few fragments of porous porcelain. Boil vigorously for 5-6 hours, by the end of which time oxidation should be complete. Cool the flask under the tap, shaking vigorously to prevent the formation of lumps. Filter the solid at the pump on a Buchner funnel and wash with cold water. Transfer the solid to a beaker containing 1-2 g. of decolourising carbon and about 400 ml. of water; heat to boiling until the acid dissolves. Filter through a hot water funnel or through a preheated Buchner funnel and filter flask, and allow the filtrate to cool. When cold, filter the benzoic acid with suction on a clean Buchner funnel, press well with a large glass stopper, wash with small quantities of cold water, and drain as dry as possible. Dry upon filter paper in the air. The yield is 8 g., m.p. 121.5° .

By Carbonation of the Grignard Reagent

Equip a 500 ml. round-bottomed flask with a reflux condenser (preferably of the double surface type) and a calcium chloride (or cotton wool) guard tube; it is important that the apparatus be thoroughly dry. Place 8.0 g. of dry magnesium turnings, a small crystal of iodine, 15 g. (10 ml.) of dry bromobenzene (Section IV,18) and 20 ml. of sodium-dried ether in the flask. If the magnesium does not react within a few minutes, warm the flask on a water bath so that the ether refluxes gently and then remove the bath. This will generally start the reaction. The formation of the Grignard reagent will be indicated by the disappearance of the iodine colour, the production of a cloudiness, and the gentle boiling of the ether. Replace the guard tube by a separatory funnel containing a solution of 38 g. (25.5 ml.) of dry bromobenzene in 140 ml. of anhydrous ether and carrying a calcium chloride (or cotton wool) guard tube in its mouth; fit the separatory funnel into the top of the condenser by a grooved cork. Run this solution slowly into the flask at such a rate that the ether boils gently from the heat of reaction alone without the application of external heating. This operation occupies about 30 minutes. Replace the separatory funnel by the guard tube and reflux the mixture gently on a water bath (*CAUTION*: ether) for 30 minutes in order to complete the reaction. The solution will now be either cloudy or slightly dark in colour; the magnesium will have disintegrated and only a little will remain unattacked.

Place 80 g. (roughly weighed) of Dry Ice in the form of small lumps in a dry 1 or 1.5 litre beaker (for method of handling, see Section III,84). Pour the solution of the Grignard reagent slowly and steadily on to the solid carbon dioxide with stirring, taking care to retain any unreacted magnesium in the flask. There is a vigorous reaction and the Grignard reagent addition compound sets to a stiff mass. Continue the stirring until all the Dry Ice has evaporated. Add 200 g. of crushed ice and then 60 ml. of dilute hydrochloric acid (1 : 1 by volume); stir until most

of the solid has decomposed. Transfer the mixture to a separatory funnel, wash the beaker with 50 ml. of technical ether, and add the extract to the mixture in the separatory funnel. Withdraw the aqueous layer. Wash the ether layer twice with 30 ml. portions of water. Extract the ether solution with two 100 ml. portions of 5 per cent. sodium hydroxide solution, and run the aqueous layer into a clean beaker. [Place the ether in the *ETHER RESIDUES* bottle.] Treat the combined aqueous layers with 1-2 g. decolourising carbon and a Whatman ashless tablet, and filter by suction. Acidify the filtrate with dilute hydrochloric acid, cool and collect the precipitate of benzoic acid on a Buchner funnel. Recrystallise from hot water and dry upon filter paper in the air (see Section IV,153). The yield of pure benzoic acid, m.p. 121° , is 20 g.

COGNATE PREPARATION

Phenylacetic acid. Use 5.0 g. of magnesium, 25 g. (23 ml.) of redistilled benzyl chloride (Section IV,22) and 75 ml. of sodium-dried ether. Allow the reaction mixture to warm to 15° and then decompose it with dilute hydrochloric or sulphuric acid. Filter off the crude acid and recrystallize it from water. The yield of pure phenylacetic acid, m.p. $76-77^{\circ}$, is 11 g.

Note.

Phenylacetic acid is appreciably soluble in water, so that the yield is poor; it may be improved by evaporating the filtrates to a small volume and extracting with ether.

IV,154.

p-NITROBENZOIC ACID

Place 46 g. of *p*-nitrotoluene, 136 g. of crystallised sodium dichromate ($\text{Na}_2\text{Cr}_2\text{O}_7 \cdot 2\text{H}_2\text{O}$) and 300 ml. of water in a 1-litre round-bottomed flask fitted with a mechanical stirrer. By means of a dropping funnel supported above the flask, add 340 g. (185 ml.) of concentrated sulphuric acid during about 30 minutes to the well-stirred mixture. The heat of dilution of the acid causes the *p*-nitrotoluene to melt and oxidation takes place; if the reaction shows signs of becoming vigorous, the rate of addition must be reduced. When all the sulphuric acid has been introduced and the temperature of the mixture commences to fall, attach a reflux condenser to the flask, and heat to gentle boiling for half an hour. Cool and pour the reaction mixture into 400-500 ml. of water. Filter the crude *p*-nitrobenzoic acid at the pump and wash it with about 200 ml. of water. Transfer the solid to a 1-litre beaker, add about 200 ml. of 5 per cent. sulphuric acid (11 g. or 6 ml. of concentrated sulphuric acid added to 200 ml. of water) and digest on a water bath, with agitation, in order to remove the chromium salts as completely as possible; allow to cool and filter again. Transfer the acid to a beaker, break up any lumps of material, and treat it with 5 per cent. sodium hydroxide solution until the liquid remains alkaline (360-400 ml.). The *p*-nitrobenzoic acid passes into solution, any unchanged *p*-nitrotoluene remains undissolved and chromium salts are converted into chromic hydroxide and/or sodium chromite. Add about 5 g. of decolourising carbon, warm to about 50° with stirring for 5 minutes, and filter with suction. Run the alkaline solution of sodium *p*-nitrobenzoate into about 450 ml. of well-stirred

15 per cent. sulphuric acid (74 g. or 40 ml. of concentrated sulphuric acid in 400 ml. of water). Do not add the acid to the alkaline solution, for in this way the acid is liable to be contaminated by the sodium salt. Filter the purified acid at the pump, wash it thoroughly with cold water, and dry it in the steam oven. The yield of *p*-nitrobenzoic acid, m.p. 237°, is 48 g. : this is sufficiently pure for most purposes. Upon recrystallisation from benzene or from glacial acetic acid, the m.p. is raised to 239°.

IV,155. 2 : 4 : 6-TRINITROBENZOIC ACID

In a 1 litre bolt-head flask, mounted in an empty water bath, place 720 g. (392 ml.) of concentrated sulphuric acid and add 72 g. of commercial trinitrotoluene. Stir the mixture mechanically with a powerful stirrer and introduce powdered crystallised sodium dichromate ($\text{Na}_2\text{Cr}_2\text{O}_7 \cdot 2\text{H}_2\text{O}$) in small quantities until the temperature of the mixture reaches 40° : now fill the empty water bath with cold water and add the sodium dichromate at such a rate that the temperature is maintained at 45–55°. The total weight of sodium dichromate required is 110 g. Stir the mixture for a further 2 hours at 45–55°, and pour into a beaker containing 800 g. of crushed ice. Filter off the trinitrobenzoic acid and wash it carefully with cold water until free from chromium salts (the acid is appreciably soluble in water). Transfer the solid to a 1-litre bolt-head flask, provided with a stirrer and containing 400 ml. of water. Add 15 per cent. sodium hydroxide solution from a separatory funnel, with vigorous stirring, until a *faint* red colour persists for 5 minutes ; discharge the colour with a few drops of acetic acid. Filter off the unattacked trinitrotoluene and wash it with a little water. Precipitate the trinitrobenzoic acid from the filtrate by the addition of a slight excess of 50 per cent. sulphuric acid. Cool in ice, filter the acid at the pump and wash it free from salts with ice-cold water. Dry the 2 : 4 : 6-trinitrobenzoic acid in the air : it melts at 228° (decomp.) and the yield is 55 g.

IV,156. 2 : 4-DINITROPHENYLACETIC ACID

Place 25 g. of phenylacetic acid (Section IV,160) in a 500 ml. round-bottomed flask, cool the latter in running water and add 250 ml. of fuming nitric acid, rather slowly at first and then more rapidly. The addition occupies about 15 minutes. Attach a condenser to the flask, reflux the solution for 1 hour, and pour into about 500 ml. of cold water. When cold, filter the crude 2 : 4-dinitrophenylacetic acid at the pump and wash it with cold water : the resulting acid, after drying at 100°, is almost pure (m.p. 181°) and weighs 31 g. Recrystallise it from 300 ml. of 20 per cent. alcohol. Collect the first main crop (25 g.), and allow the mother liquor to stand overnight when a further 2 g. of pure acid is obtained ; dry at 100°. The yield of pure 2 : 4-dinitrophenylacetic acid, m.p. 183°, is 27 g.

IV,157. *o*-CHLOROBENZOIC ACID

Method 1. Place 1250 ml. of water, 75 g. of pure potassium permanganate and 50 g. of *o*-chlorotoluene (Section IV,61) in a 2.5-litre three-necked flask equipped with a mechanical stirrer and reflux condenser.

Stir the mixture and reflux gently until practically all the permanganate colour has disappeared (about 2 hours). At this point add 37.5 g. more of potassium permanganate and reflux the mixture again until the permanganate colour disappears (about 2 hours); the colour of the solution can easily be seen by removing the flame and stopping the refluxing. Finally, add a second 37.5 g. of potassium permanganate and continue refluxing until the permanganate colour has disappeared (about 2-4 hours) (1). Steam distil the mixture (Fig. II, 41, 1) to remove unreacted *o*-chlorotoluene (about 12 g.). Filter the hot contents of the flask from the manganese dioxide with suction (2) and wash with two 125 ml. portions of hot water. Concentrate the filtrate to about 800 ml. (Fig. II, 37, 1) (3), and precipitate the *o*-chlorobenzoic acid by cautiously adding 75 ml. of concentrated hydrochloric acid with continual stirring. When cold, filter with suction, wash the acid with cold water, and dry at 100°. The yield of *o*-chlorobenzoic acid, m.p. 138-139°, is 42 g. Upon recrystallisation from hot water or from toluene (*ca.* 4 ml. per gram), the m.p. is raised to 139-140°.



Notes.

(1) A somewhat lower yield is obtained if all the potassium permanganate (150 g.) is added all at once and, furthermore, the reaction may become violent. Addition in three portions results in a more controllable reaction.

(2) The addition of a Whatman filter tablet or of a little diatomaceous earth (Super Cel, etc.) assists in the filtration of the finely divided manganese dioxide.

(3) If the acid is precipitated before the solution is concentrated, the yield is considerably reduced (*ca.* 25 g.). If the concentrated solution is not clear, it may be clarified by the addition of 1 g. of decolourising carbon.

Method 2. Dissolve 14 g. of anthranilic acid (Section IV,170) in a solution of 20 ml. of concentrated hydrochloric acid and 100 ml. of water. Cool to about 5°, and diazotise by the gradual addition of a cold solution of 7 g. of sodium nitrite in 25 ml. of water to an end point with starch-potassium iodide paper (compare Section IV,60). In the meantime prepare a solution of cuprous chloride as follows. Dissolve 26 g. of crystallised copper sulphate and 12 g. of sodium chloride in 50 ml. of water in a 750 ml. round-bottomed flask. Heat the solution to boiling, then add 80 ml. of concentrated hydrochloric acid and 14 g. of copper turnings, and continue the heating under reflux until the solution is practically colourless. (Alternatively, prepare the cuprous chloride by the method given in Section II,50,1.) Cool in ice, and then add the cold diazonium solution slowly and with shaking. The reaction proceeds rapidly and with frothing: allow the mixture to stand for 2-3 hours with frequent shaking. Filter the precipitated *o*-chlorobenzoic acid and wash it with a little cold water. Recrystallise the crude acid from hot water containing a little alcohol to which a little decolourising carbon has been added. The yield of pure *o*-chlorobenzoic acid, m.p. 138-139°, is 14 g.



COGNATE PREPARATIONS

***p*-Chlorobenzoic acid.** Proceed exactly as for *o*-chlorobenzoic acid. Use 1250 ml. of water, 50 g. of *p*-chlorotoluene (Section IV,61), and 75 g., 37.5 g. and 37.5 g. of potassium permanganate. When the oxidation is complete, steam distil the mixture to recover any unreacted *p*-chlorotoluene (3-4 g.). Filter the reaction mixture from hydrated manganese dioxide and wash the precipitate with two 100 ml. portions of water. Precipitate the *p*-chlorobenzoic acid in the filtrate (1) by the addition of 75 ml. of concentrated hydrochloric acid. Filter the cold solution with suction, wash with cold water, and dry in an oven at 100°. The yield of *p*-chlorobenzoic acid, m.p. 234–235°, is 55 g. Recrystallisation from hot water raises the m.p. to 238–239°.

Note.

(1) If the filtrate has a faint permanganate colour, add a few drops of sodium bisulphite solution until the solution is colourless. In this case (compare *o*-chlorobenzoic acid) concentration of the solution before precipitation only increases the yield by about 1 g. and may cause occlusion of inorganic salts.

***o*-Iodobenzoic acid.** Dissolve 14 g. of anthranilic acid in dilute sulphuric acid and diazotise it as described in *Method 2*. Introduce into the resulting clear solution, with stirring, a solution of 26 g. of potassium iodide in dilute sulphuric acid, heat the mixture to boiling for 10 minutes and then cool. Collect the *o*-iodobenzoic acid by suction filtration, and recrystallise from hot water. The yield is almost quantitative; m.p. 162°.

IV,158.**TEREPHTHALIC ACID**

Place 25 g. (29 ml.) of pure *p*-xylene, 140 g. of crystallised sodium dichromate ($\text{Na}_2\text{Cr}_2\text{O}_7 \cdot 2\text{H}_2\text{O}$) and 300 ml. of water in a 1 litre three-necked flask equipped with a reflux condenser, a mercury-sealed mechanical stirrer and a separatory funnel. Add through the separatory funnel 340 g. (185 ml.) of concentrated sulphuric acid to the well-stirred mixture at such a rate that the reaction is under control; this usually occupies 60–90 minutes. When all the acid has been introduced and the temperature begins to fall, reflux the mixture gently for half an hour. Cool and pour the reaction mixture (which contains some solid matter) into about 500 ml. of ice water and allow to stand for 1 hour. Filter the crude terephthalic acid with suction, and wash it with 50 ml. of cold water followed by 25 ml. of ether. Purify the acid by dissolving it in 5 per cent. sodium hydroxide solution (about 120 ml. are required), filter from any chromic hydroxide, and run the alkaline solution into about 450 ml. of well-stirred 15 per cent. sulphuric acid (74 g. or 40 ml. of concentrated sulphuric acid in 400 ml. of water). Filter the purified acid at the pump, wash it thoroughly with cold water, and dry at 100°. The yield of colourless terephthalic acid is 17 g.; it sublimes without melting at 300° and is almost insoluble in water and alcohol.

IV,159.***o*-TOLUIC ACID**

Prepare *o*-tolunitrile, b.p. 94–96°/20 mm., from *o*-toluidine following the method given in Section IV,66 under *p*-Toluidine. Also prepare 600 g. of 75 per cent. sulphuric acid by adding 450 g. (245 ml.) of con-

concentrated sulphuric acid cautiously, with stirring and cooling, to 150 ml. of water. Place the latter in a 1 litre three-necked flask, equipped with a separatory funnel, a mechanical stirrer and reflux condenser. Heat the solution in an oil bath to about 150°, stir, and add 220 g. of *o*-tolunitrile during 2 hours. Continue the stirring for a further 2 hours while the temperature is maintained at 150–160°; finally raise the temperature to 190° and stir for another hour. Some crystalline solid will appear in the condenser at this stage. Allow the reaction mixture to cool, pour into ice water, and filter off the precipitated acid. Dissolve the crude acid in an excess of 10 per cent. sodium hydroxide solution, filter off any insoluble material (probably *o*-toluamide, m.p. 141°) through a sintered glass funnel while still hot, and acidify the filtrate with dilute sulphuric acid. Collect the *o*-toluic acid on a Buchner funnel, dry in the air and recrystallise from benzene (about 500 ml.). The yield of pure *o*-toluic acid, m.p. 102–103°, is 200 g.

p-Toluic acid may be similarly prepared, if required in quantity, from *p*-tolunitrile (Section IV,66).

IV,160. PHENYLACETIC ACID (from Benzyl Cyanide)

Preparation of benzyl cyanide. Place 100 g. of powdered, technical sodium cyanide (97–98 per cent. NaCN) (*CAUTION*) and 90 ml. of water in a 1 litre round-bottomed flask provided with a reflux condenser. Warm on a water bath until the sodium cyanide dissolves. Add, by means of a separatory funnel fitted into the top of the condenser with a grooved cork, a solution of 200 g. (181.5 ml.) of benzyl chloride (Section IV,22) in 200 g. of rectified spirit during 30–45 minutes. Heat the mixture in a water bath for 4 hours, cool, and filter off the precipitated sodium chloride with suction; wash with a little alcohol. Distil off as much as possible of the alcohol on a water bath (wrap the flask in a cloth) (Fig. II, 13, 3). Cool the residual liquid, filter if necessary, and separate the layer of crude benzyl cyanide. (Sometimes it is advantageous to extract the nitrile with ether or benzene.) Dry over a little anhydrous magnesium sulphate, and distil under diminished pressure from a Claisen flask, preferably with a fractionating side arm (Figs. II, 24, 2–5). Collect the benzyl cyanide at 102–103°/10 mm. The yield is 160 g.

This product is sufficiently pure for the preparation of phenylacetic acid and its ethyl ester, but it contains some benzyl *iso*-cyanide and usually develops an appreciable colour on standing. The following procedure removes the *iso*-cyanide and gives a stable water-white compound. Shake the once-distilled benzyl cyanide vigorously for 5 minutes with an equal volume of warm (60°) 50 per cent. sulphuric acid (prepared by adding 55 ml. of concentrated sulphuric acid to 100 ml. of water). Separate the benzyl cyanide, wash it with an equal volume of saturated sodium bicarbonate solution and then with an equal volume of half-saturated sodium chloride solution. Dry with anhydrous magnesium sulphate and distil under reduced pressure. The loss in washing is very small (compare *n*-Butyl Cyanide, Section III,113, in which concentrated hydrochloric acid is employed).

Hydrolysis of benzyl cyanide to phenylacetic acid. Into a 500 ml. round-bottomed flask, provided with a reflux condenser, place 100 ml.

of water, 100 ml. of concentrated sulphuric acid and 100 ml. of glacial acetic acid : add 100 g. (98 ml.) of benzyl cyanide. Heat under reflux for 45–60 minutes ; hydrolysis is then complete. Pour the mixture into 2–3 volumes of water with stirring. Filter the crude acid at the pump. Melt the crude material under water, and wash it two or three times with small volumes of hot water ; the acid solidifies on cooling (1). Test a small portion for the presence of phenylacetamide (m.p. 155°) by dissolving in sodium carbonate solution. If a clear solution results, phenylacetamide is absent : if the solution is not clear, shake the whole of the crude product with excess of sodium carbonate solution, filter, and precipitate the phenylacetic acid from the clear filtrate by the addition of dilute sulphuric acid. Filter off the phenylacetic acid and recrystallise it from hot water or, better, light petroleum (b.p. 40–60°). The yield of pure acid, m.p. 77°, is 50 g. Small quantities of acid may be recovered from the mother liquors by extraction with ether, but this is rarely worth while.

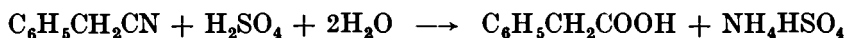

Note.

(1) Another method of purification consists in distillation under reduced pressure. The fraction of b.p. 140–150°/20 mm. is collected separately ; it solidifies on standing, melts at 76–76·5°, and is practically pure.

Hydrolysis of benzyl cyanide to phenylacetamide. In a 1500 ml. three-necked flask, provided with a thermometer, reflux condenser and *efficient* mechanical stirrer, place 100 g. (98 ml.) of benzyl cyanide and 400 ml. of concentrated hydrochloric acid. Immerse the flask in a water bath at 40° and stir the mixture vigorously : the benzyl cyanide passes into solution within 20–40 minutes and the temperature of the reaction mixture rises to about 50°. Continue the stirring for an additional 20–30 minutes after the mixture is homogeneous. Replace the warm water in the bath by tap water at 15°, replace the thermometer by a dropping funnel charged with 400 ml. of cold distilled water, and add the latter with stirring : crystals commence to separate after about 50–75 ml. have been introduced. When all the water has been run in, cool the mixture externally with ice water for 30 minutes (1), and collect the crude phenylacetamide by filtration at the pump. Remove traces of phenylacetic acid by stirring the wet solid for about 30 minutes with two 50 ml. portions of cold water ; dry the crystals at 50–80°. The yield of phenylacetamide, m.p. 154–155°, is 95 g. Recrystallisation from benzene or rectified spirit raises the m.p. to 156°.

Note.

(1) The suspension of phenylacetamide may be further hydrolysed to phenylacetic acid by refluxing with stirring until the solid dissolves. The mixture becomes turbid after 30 minutes and the product begins to separate as an oil : refluxing is continued for 6 hours, the mixture is cooled first with tap water and then by an ice-water bath for about 4 hours. The crude phenylacetic acid is filtered at the pump, washed with two 50 ml. portions of cold water, and dried in a desiccator. The resulting crude acid melts at 69–70° ; it may be purified by recrystallisation from light petroleum (b.p. 40–60°) or, better, by vacuum distillation.

COGNATE PREPARATIONS

α -Naphthylacetonitrile. Place a mixture of 56 g. of α -chloromethylnaphthalene (Section IV,23), 29 g. of potassium cyanide, 125 ml. of ethanol and 50 ml. of water in a 500 ml. round-bottomed flask fitted with a double-surface reflux condenser, and reflux for 1 hour. Distil off the alcohol, transfer the residue to a separatory funnel, wash it with water, filter from a small amount of solid, transfer to a dish and dry under reduced pressure (vacuum desiccator charged with anhydrous calcium chloride). Distil under diminished pressure and collect the α -naphthylacetonitrile at 155–160°/9 mm. (1) : the yield is 38 g.

Note.

(1) A little naphthalene may pass over first owing to impurities in the original α -chloromethylnaphthalene.

α -Naphthylacetic acid. Heat a mixture of 36 g. of the acetonitrile, 45 ml. of concentrated sulphuric acid, 45 ml. of glacial acetic acid and 45 ml. of water under reflux for 45 minutes. Pour the hot reaction mixture slowly and with good stirring into about 800 ml. of ice-cold water. Collect the precipitated solid by suction filtration and dry it at 100°; the yield of crude acid, m.p. 116–118°, is 42 g. Purify the acid by dissolving it in about 180 ml. of 50 per cent. ethanol, treating the boiling solution with a little decolourising carbon, filtering, and precipitating the acid by dilution with cold water. (Occasionally, a little oily matter, soluble in alcohol, is present; this is readily removed by placing the filtered solution in a separatory funnel and adding a little water; the oil separates first and is run off from the bottom of the funnel.) The recovery of pure acid, m.p. 130°, is about 75 per cent.

IV,161.

***p*-NITROPHENYLACETIC ACID**

***p*-Nitrobenzyl cyanide.** Place a mixture of 275 ml. of concentrated nitric acid with an equal volume of concentrated sulphuric acid in a 2-litre three-necked flask, fitted with a thermometer, a mechanical stirrer and a dropping funnel. Cool the mixture to 10° in an ice bath, and run in 100 g. (98 ml.) of benzyl cyanide (Section IV,160) at such a rate (about 1 hour) that the temperature remains at about 10° and does not rise above 20°. Remove the ice bath, stir the mixture for 1 hour and pour it on to 1200 g. of crushed ice. A pasty mass slowly separates; more than half of this is *p*-nitrobenzyl cyanide, the other components being the *ortho* isomeride and a variable amount of an oil. Filter the mass on a sintered glass funnel, press well to remove as much oil as possible, and then dissolve in 500 ml. of boiling rectified spirit. The *p*-nitrobenzyl cyanide crystallises on cooling. Filter this off at the pump and recrystallise from 80 per cent. alcohol. The yield of *p*-nitrobenzyl cyanide, m.p. 115–116°, is 75 g. Another recrystallisation raises the m.p. to 116–117°.

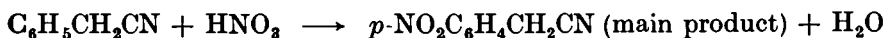

***p*-Nitrophenylacetic acid.** Prepare a diluted sulphuric acid by adding 150 ml. of concentrated sulphuric acid cautiously to 140 ml. of water. Place 50 g. of *p*-nitrobenzyl cyanide in a 500 ml. round-bottomed

flask, pour in about two-thirds of the sulphuric acid and shake well until all the solid is moistened with the acid. Wash down any nitrile adhering to the walls of the flask into the liquid with the remainder of the acid. Attach a reflux condenser to the flask and support it in a 10 cm. hole in a large sheet of asbestos board resting on a tripod. Heat to the boiling point and boil for 15 minutes. Dilute the rather dark reaction mixture with an equal volume of cold water and cool to 0°. Filter with suction, and wash several times with ice water. Dissolve the solid in 800 ml. of boiling water (add decolourising carbon, if necessary) and filter rapidly through a hot water funnel supporting a fluted filter paper. If any solid remains on the filter, dissolve it in the minimum volume of boiling water and filter into the main filtrate. Collect the pale yellow needles of *p*-nitrophenylacetic acid which separates on cooling, and dry at 100°. The yield of acid, m.p. 151–152°, is 53 g.

IV,162. *p*-AMINOPHENYLACETIC ACID

The acid is conveniently prepared by the reduction of *p*-nitrophenylacetic acid with ammonium sulphide (hydrogen sulphide in ammoniacal solution).

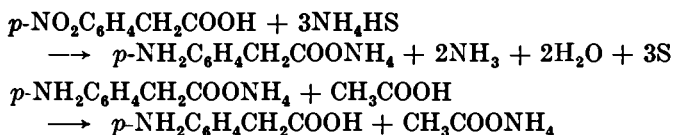

Fit a 750 ml. flask with a two-holed rubber stopper carrying a wide delivery tube (which ends well below the middle of the flask) and a glass stopcock. Place 250 ml. of approximately 6*N* ammonia solution (sp. gr. ca. 0.95) in the flask and add, slowly and with shaking, 50 g. of *p*-nitrophenylacetic acid (Section IV,161). Immerse the flask in an ice bath and saturate the mixture with hydrogen sulphide: keep the temperature below 50° and open the stopcock from time to time in order to expel the hydrogen which has accumulated, due to free iron in commercial ferrous sulphide. Remove the stopper from the flask and gently boil the solution of ammonium *p*-aminophenylacetate in the fume cupboard until nearly all of the excess of hydrogen sulphide and of ammonia have been expelled: the colour of the solution changes from a dark orange-red to a pale yellow. Filter off the sulphur at the pump, and add 20 ml. of glacial acetic acid with stirring to the hot filtrate. Filter off the *p*-aminophenylacetic acid when cold. It is contaminated with a little sulphur, which can be removed by recrystallisation from 2 litres of hot water. The yield of pure acid, m.p. 199–200°, is 32 g.

IV,163. α -NAPHTHOIC ACID

Method 1. α -Naphthonitrile. Place 80 g. (54 ml.) of redistilled α -bromonaphthalene (Section IV,20), 43 g. of dry powdered cuprous cyanide (Section II,50,3) and 36 g. (37 ml.) of dry pure pyridine (1) (Section II,47,22) in a 250 ml. round-bottomed flask fitted with a ground-in reflux condenser carrying a calcium chloride (or cotton wool) guard tube, and heat the mixture in a metal bath at 215–225° for

15 hours (2). Pour the resulting dark brown solution while still hot (*ca.* 100°) into a litre flask containing 180 ml. of concentrated ammonia solution, sp. gr. 0.88, and 180 ml. of water. Add 170 ml. of benzene, stopper the flask and shake until all the lumps have disintegrated. When cold, add 100 ml. of ether and filter through a sintered glass funnel (3). Add a further 50 ml. of ether, transfer to a separatory funnel, separate the ether-benzene layer and wash it successively with (i) four 125 ml. portions of dilute ammonia solution (or until the organic layer is colourless), (ii) two 125 ml. portions of dilute hydrochloric acid (1 : 1) (any precipitate which separates should be filtered off), (iii) two 125 ml. portions of water, and (iv) two 125 ml. portions of saturated sodium chloride solution. Finally dry with anhydrous magnesium sulphate, remove the ether and benzene by distillation from a water bath (Fig. II, 13, 4 but with a Claisen flask with fractionating side arm as in Figs. II, 24, 2-5), and distil under reduced pressure. Collect the α -naphthonitrile at 166-169°/18 mm. as a colourless liquid. The yield is 50 g.

Notes.

- (1) Much heat is liberated when pyridine is added to the mixture.
- (2) The metal bath may be replaced by a bath of hydrogenated cotton seed oil or Silicone oil.
- (3) The cuprammonium solution attacks filter paper.

α -Naphthoic acid. In a 750 ml. or 1 litre flask equipped with a reflux condenser, place 50 g. of α -naphthonitrile, 100 ml. of glacial acetic acid, 100 ml. of water and 100 ml. of concentrated sulphuric acid. Heat in an oil bath at 115-120° for 1.5 hours: do not allow the temperature to rise above 120° as the α -naphthoic acid formed tends to lose carbon dioxide at higher temperatures and the yield will be reduced. Dilute the cold reaction mixture, which contains much crystalline solid, with an equal volume of water and filter at the pump; if the product consists of large lumps, transfer it first to a glass mortar and thoroughly grind it to a fine paste. Wash with water until free from mineral acid. Dissolve the crude acid in dilute aqueous sodium carbonate solution, heat for a short time to separate the resinous impurities, and filter the hot solution. Acidify the clear filtrate with a slight excess of dilute sulphuric acid (compare order of addition under *p-Nitrobenzoic Acid*, Section IV, 154), collect the voluminous precipitate of almost pure α -naphthoic acid, wash until free from inorganic salts, and dry at 100°. Recrystallise from toluene or from light petroleum (b.p. 80-100°). The yield of pure α -naphthoic acid, m.p. 160-161°, is 55 g.

Method 2. Equip a 1 litre three-necked flask with a double surface reflux condenser, a mechanical stirrer and a separatory funnel, and place 12.2 g. of dry magnesium turnings, a crystal of iodine, 50 ml. of sodium-dried ether and 7.5 g. (5 ml.) of α -bromonaphthalene (Section IV, 20) in the flask. If the reaction does not start immediately, reflux gently on a water bath until it does; remove the water bath. Stir the mixture, and add a solution of 96 g. (65 ml.) of α -bromonaphthalene in 250 ml. of anhydrous ether from the separatory funnel at such a rate that the reaction is under control (1.5-2 hours). Place a water bath under the flask and continue the stirring and refluxing for a further 30 minutes. The Grignard reagent collects as a heavy oil in the bottom of the flask:

add 270 ml. of anhydrous benzene to the warm liquid in order to dissolve it completely. Cool the flask in a freezing mixture of ice and salt. In the meantime, replace the reflux condenser by a wide lead-in tube, 10 mm. in diameter and adjusted so that the end is about 5 cm. above the reaction mixture; this is necessary in order to prevent clogging in the subsequent reaction. Also replace the separatory funnel by a two-holed rubber stopper supporting a thermometer (with the bulb immersed in the reaction mixture) and a glass tube drawn out to fine capillary: the latter will permit the carbon dioxide which does not react to escape slowly and thus prevent the pressure in the flask becoming too great. When the temperature has fallen to -7° , pass dry carbon dioxide into the well-stirred mixture through the wide gas-inlet tube (1). Adjust the rate of flow of the gas so that the temperature does not rise above -2° . The reaction is complete (*ca.* 1.5 hours) when the temperature falls below -7° and does not rise on increasing the current of gas. Cool the flask in ice and add 25 per cent. sulphuric acid, with stirring, until no further reaction takes place and all the magnesium has disappeared. Separate the upper layer, and extract the aqueous layer with two 50 ml. portions of ether. Extract the clear ether-benzene extracts with three 50 ml. portions of 25 per cent. sodium hydroxide solution. Acidify the alkaline extracts with 50 per cent. sulphuric acid, filter off the crude α -naphthoic acid at the pump, wash with cold water until free from sulphate and dry at 100° . Dissolve the crude acid (67 g.) in 200 ml. of hot toluene, add a small amount of Filter-Cel (a diatomaceous earth), and filter the solution through a preheated Buchner funnel. Cool the filtrate in ice, filter and wash with cold toluene until the filtrate is nearly colourless. The yield of slightly coloured α -naphthoic acid, m.p. $160-161^{\circ}$, is 60 g.

Note.

(1) Alternatively, the solution of the Grignard reagent may be poured on to solid carbon dioxide (Dry Ice)—for experimental details, see under *n-Valeric Acid*, Section III,84.

IV,164.

β -NAPHTHOIC ACID

Method 1

Prepare a solution containing about 100 g. of potassium hypochlorite from commercial calcium hypochlorite ("H.T.H.") as detailed under $\beta\beta$ -*Dimethylacrylic Acid*, Section III,142, *Note 1*, and place it in a 1500 ml. three-necked flask provided with a thermometer, a mechanical stirrer and a reflux condenser. Warm the solution to 55° and add through the condenser 85 g. of β -acetonaphthalene (methyl β -naphthyl ketone) (1). Stir the mixture vigorously and, after the exothermic reaction commences, maintain the temperature at $60-70^{\circ}$ by frequent cooling in an ice bath until the temperature no longer tends to rise (*ca.* 30 minutes). Stir the mixture for a further 30 minutes, and destroy the excess of hypochlorite *completely* by adding a solution of 25 g. of sodium bisulphite in 100 ml. of water: make sure that no hypochlorite remains by testing the solution with acidified potassium iodide solution. Cool the solution, transfer the reaction mixture to a 2-litre beaker and cautiously acidify with 100 ml. of concentrated hydrochloric acid. Filter the crude acid at the pump,

wash with water, and drain as completely as possible. Dry at 100° and recrystallise the dry acid (85 g.; m.p. 181–183°) from rectified spirit (about 300 ml.). The yield of pure, colourless β -naphthoic acid, m.p. 184–185°, is 75 g.

Note.

(1) The commercial product, m.p. 53–55°, may be used. Alternatively the methyl β -naphthyl ketone may be prepared from naphthalene as described in Section IV,136. The Friedel-Crafts reaction in nitrobenzene solution yields about 90 per cent. of the β -ketone and 10 per cent. of the α -ketone; in carbon disulphide solution at –15°, the proportions are 65 per cent. of the α - and 35 per cent. of the β -isomer. With chlorobenzene as the reaction medium, a high proportion of the α -ketone is also formed. Separation of the liquid α -isomer from the solid β -isomer in such mixtures (which remain liquid at the ordinary temperature) is readily effected through the picrates; the picrate of the liquid α -aceto compound is less soluble and the higher melting.

The reaction in chlorobenzene solution may be carried out as follows. Dissolve 1500 g. of pure naphthalene in 1500 g. (1355 ml.) of chlorobenzene, add 120 g. of finely-powdered, anhydrous aluminium chloride and 100 g. (90.5 ml.) of pure acetyl chloride, following the method given under *p-Bromoacetophenone* (Section IV,138), during 1 hour. Allow the reaction mixture to stand overnight, pour it upon crushed ice, separate the organic layer, wash it well with water, and dry with anhydrous magnesium sulphate. Distil off the chlorobenzene at normal pressure (*i.e.*, until the temperature rises to 140°) and then distil the residue under reduced pressure. A low b.p. fraction containing about 30 g. of naphthalene passes over first, followed by the mixed methyl naphthyl ketones at 138–145°/3 mm. (71 g.). Dissolve the ketone fraction in 100 ml. of rectified spirit and add a warm solution of 95 g. of picric acid in 900 ml. of rectified spirit. Cool, separate the almost pure picrate of methyl α -naphthyl ketone, m.p. 115–116° (71 g.); upon recrystallisation the m.p. rises to 119°. Concentrate the mother liquor successively to 500 ml. and 250 ml., and collect the crystals which separate after each concentration and cooling; 80 g. of the picrate of methyl β -naphthyl ketone, m.p. 82°, are obtained. Decompose the β -picrate, m.p. 82°, with sodium carbonate or dilute ammonia solution, separate the ketone, dry and distil under reduced pressure: pure methyl β -naphthyl ketone, b.p. 170–171°/11 mm., m.p. 55°, is thus isolated. Decomposition of the α -picrate, m.p. 119°, similarly yields pure methyl α -naphthyl ketone, b.p. 166–167°/12 mm.

Method 2

Diazotise 223 g. of 2-naphthylamine-1-sulphonic acid as detailed under *β -Bromonaphthalene* in Section IV,62. Prepare cuprous cyanide from 125 g. of cupric sulphate pentahydrate (Section IV,66) and dissolve it in a solution of 65 g. of potassium cyanide in 500 ml. of water contained in a 1-litre three-necked flask. Cool the potassium cuprocyanide solution in ice, stir mechanically, and add the damp cake of the diazonium compound in small portions whilst maintaining the temperature at 5–8°. Nitrogen is soon evolved and a red precipitate forms gradually. Continue the stirring for about 10 hours in the cold, heat slowly to the boiling point, add 250 g. of potassium chloride, stir, and allow to stand. Collect the orange crystals which separate by suction filtration; recrystallise first from water and then from alcohol; dry at 100°. The product is almost pure potassium 2-cyanonaphthalene-1-sulphonate. Transfer the product to a 2-litre round-bottomed flask, add a solution prepared from 400 ml. of concentrated sulphuric acid and 400 g. of crushed ice, and heat the mixture under reflux for 12 hours. Collect the β -naphthoic acid formed (some of which sublimes from the reaction mixture) by suction filtration

on a sintered glass funnel, wash well with water, and dry at 100°; recrystallise from rectified spirit. The yield of β -naphthoic acid, m.p. 184–185°, is 130 g.

IV,165 DIPHENIC ACID (*from Phenanthrene*)

Equip a 2.5 litre three-necked flask with a mechanical stirrer, a reflux condenser and a thermometer. Dissolve 89 g. (0.5 mol) of pure phenanthrene (1) in 1 litre of glacial acetic acid in the flask and warm to 85° on a water bath. Introduce 345 ml. of 30 per cent. hydrogen peroxide solution (2.75 mols) during 40 minutes; the temperature falls to about 80° and some phenanthrene may precipitate. After the addition is complete, heat the mixture with stirring on a water bath for a further 3–4 hours. Reduce the volume of the solution to about half by distillation under reduced pressure and allow to cool. Filter off the considerable amount of diphenic acid which crystallises out on cooling. Keep the filtrate and evaporate it almost to dryness under reduced pressure: extract the residue with 375 ml. of 10 per cent. sodium carbonate solution by warming on a water bath, boil the extract with a little decolourising carbon, filter and add dilute hydrochloric acid until the pH is 4.5 (use narrow-range indicator paper). Stir the solution with a further small amount of active charcoal and filter off the tarry material; cool the clear solution to 0° and acidify with dilute hydrochloric acid. Collect the precipitate by suction filtration, wash with water and dry at 110°. The total yield of crude diphenic acid, m.p. 228°, is 83 g. Recrystallisation from glacial acetic acid raises the m.p. to 230°.

Note.

(1) Technical phenanthrene may be purified as follows. Dissolve 500 g. of technical 90 per cent. phenanthrene in 3 litres of ethanol in a 4-litre flask on a steam bath and decant the hot solution from any insoluble material: collect the solid which crystallises upon cooling the solution. Dissolve 250 g. of the crystallised product in 550 ml. of hot glacial acetic acid in a 1-litre three-necked flask provided with an efficient reflux condenser and a dropping funnel. To the boiling solution add gradually 18 ml. of an aqueous solution containing 15 g. of chromic anhydride; then add slowly 7.5 ml. of concentrated sulphuric acid from the dropping funnel. Reflux the solution for 15 minutes, and then pour it with vigorous stirring into 1125 ml. of water in a 3-litre round-bottomed flask. Filter when cold, wash with water, and dry in the air. Distil the product under reduced pressure (oil pump) and collect the phenanthrene at 148–149°/1 mm. Use a 500 ml. Claisen flask attached directly with a 10–14 mm. glass tube to a 500 ml. round-bottomed flask (compare Fig. II, 19, 3): an all-glass apparatus is necessary since the m.p. of the phenanthrene is relatively close to its boiling point under the pressure of the distillation. Recrystallise the distillate from ethanol: 200–225 g. of nearly white phenanthrene, m.p. 99°, are obtained.

IV,166. HYDROCINNAMIC ACID

Method 1. Place 11.5 g. of clean metallic sodium (compare Section III, 7, Note 1), cut into small pieces, into a dry 1 litre round-bottomed flask fitted with a 25 cm. double surface reflux condenser. Introduce 250 ml. of absolute, but preferably "super-dry" (see Section II, 47, 5) ethyl alcohol all at once. A vigorous reaction ensues: if the condenser tends to become flooded with alcohol, cool the flask either by surrounding it with a wet towel or by directing the waste water from the condenser upon

it. When all the sodium has reacted, add with frequent shaking 80 g. (75 ml.) of diethyl malonate (Section III,153). Then add slowly, through a separatory funnel supported in the top of the condenser by means of a grooved cork, 64 g. (58 ml.) of freshly distilled benzyl chloride (Section IV,22). Remove the separatory funnel, introduce a calcium chloride (or cotton wool) guard tube into the top of the condenser and reflux the mixture, with occasional shaking, for 4 hours or until neutral to moist litmus. Rearrange the condenser for ordinary distillation (compare Fig. II, 13, 3) and distil as much of the remaining ethyl alcohol as possible on a water bath: this process is assisted by wrapping the exposed part of the flask in a cloth. Add 250 ml. of water to the residue and separate the upper oily layer of crude ethyl benzylmalonate. Transfer the ester to a 500 ml. round-bottomed flask, provided with a reflux condenser, containing a solution of 75 g. of potassium hydroxide in 75 ml. of water. Reflux the mixture until hydrolysis is complete (no oily layer visible: about 2 hours) and remove the residual alcohol by distillation. Allow to cool and extract the resulting aqueous solution of potassium benzylmalonate with a little ether to remove any unhydrolysed oily matter; if any solid salts separate, add just sufficient water to dissolve them. Heat the clear potassium benzylmalonate solution in a 750 ml. round-bottomed flask on a water bath to about 80° to remove the dissolved ether, fit a reflux condenser, and add 180 ml. of 10*N* sulphuric acid. When foaming has ceased, reflux the mixture for 3 hours. Cool, add water to dissolve any inorganic salt which has separated, and extract the oil with ether. Dry the ethereal solution over anhydrous magnesium sulphate, remove the ether (Fig. II, 13, 4 but with a Claisen flask replacing the distilling flask) and distil the residue under diminished pressure. Collect the fraction, b.p. 164–172°/25 mm., separately; this solidifies at room temperature. Recrystallise from hot water containing a little hydrochloric acid or, better, from light petroleum, b.p. 40–60°. The yield of hydrocinnamic acid, m.p. 47–48°, is 20 g.

Method 2. Dissolve 20 g. of cinnamic acid (Section IV,124) in 145 ml. of approximately *N* sodium hydroxide solution contained in a 500 ml. glass bottle, equipped with a mechanical stirrer. Add 350 g. of 2·5 per cent. sodium amalgam (Section II,50,7) gradually during 1 hour whilst the mixture is well-stirred. When hydrogen is no longer evolved, separate the mercury and wash it with water: add the washings to the solution and acidify the whole with dilute hydrochloric acid (1:1). Hydrocinnamic acid is precipitated, at first in the form of an oil, which solidifies on cooling and rubbing with a glass rod. Filter at the pump and recrystallise as in *Method 1*. The yield of hydrocinnamic acid, m.p. 47–48°, is 17 g.

IV,167.

m-NITROBENZOIC ACID

Methyl *m*-nitrobenzoate. In a 1 litre round-bottomed or bolt-head flask, fitted with a mechanical stirrer, place 102 g. (94 ml.) of pure methyl benzoate (Section IV,176): support a separatory funnel containing a mixture of 62·5 ml. of concentrated sulphuric acid and 62·5 ml. of concentrated nitric acid over the mouth of the flask. Cool the flask in an ice bath to 0–10°, and then run in the nitrating mixture, with stirring,

whilst maintaining the temperature of the reaction mixture between 5° and 15°; the addition requires about 1 hour. Continue the stirring for 15 minutes longer, and pour the mixture upon 700 g. of crushed ice. Filter off the crude methyl *m*-nitrobenzoate at the pump and wash it with cold water. Transfer the solid to a 500 ml. bolt-head flask and stir it with 100 ml. of ice-cold methyl alcohol in order to remove a small amount of the *ortho* isomeride and other impurities. Filter the cooled mixture with suction, wash it with 50 ml. of ice-cold methyl alcohol, and dry in the air. The practically colourless methyl *m*-nitrobenzoate weighs 115 g. and melts at 75–76°; it is sufficiently pure for conversion into *m*-nitrobenzoic acid. The pure ester, m.p. 78°, may be obtained by recrystallisation from an equal weight of methyl alcohol.

Hydrolysis of methyl *m*-nitrobenzoate to *m*-nitrobenzoic acid. Place 90·5 g. of methyl *m*-nitrobenzoate and a solution of 40 g. of sodium hydroxide in 160 ml. of water in a 1-litre round-bottomed flask equipped with a reflux condenser. Heat the mixture to boiling during 5–10 minutes or until the ester has disappeared. Dilute the reaction mixture with an equal volume of water. When cold pour the diluted reaction product, with vigorous stirring, into 125 ml. of concentrated hydrochloric acid. Allow to cool to room temperature, filter the crude acid at the pump and wash it with a little water. Upon drying at 100°, the crude *m*-nitrobenzoic acid, which has a pale brownish colour, weighs 80 g. and melts at 140°. Recrystallisation from 1 per cent. hydrochloric acid affords the pure acid, m.p. 141°, as a pale cream solid; the loss of material is about 5 per cent.

IV,168.

3 : 5-DINITROBENZOIC ACID

Method 1. Dissolve 50 g. of pure benzoic acid in 230 ml. of concentrated sulphuric acid in a litre flask equipped with a ground-in condenser. Add 73 ml. of fuming nitric acid (sp. gr. 1·5) a few ml. at a time. Shake the flask well and cool in ice water during the addition; much heat is evolved and a clear yellow solution results. Add a few fragments of porous porcelain and heat the mixture gradually on a water bath to 100° during 45 minutes. At 70–80° the reaction may (and usually does) become vigorous; moderate, when necessary, by cooling the flask in cold water. Maintain the mixture at 100° for 15 minutes with occasional shaking, and then transfer it to an oil bath at 100°; raise the temperature to 130° over 30 minutes and keep it at 130–140° for 1 hour. Allow the flask to cool: crystals commence to separate at about 90°. When cold, pour the reaction mixture into 3–4 litres of ice water, filter the separated crystals, wash with water, and dry. The yield of 3 : 5-dinitrobenzoic acid, m.p. 204°, is 50 g.: this acid is pure enough for most purposes. Upon recrystallisation from 50 per cent. alcohol (4·5 ml. per gram), the m.p. is raised to 207°.

Method 2. This preparation should be carried out in the fume cupboard since nitrous fumes are evolved. Place 62 g. of benzoic acid and 300 ml. of concentrated sulphuric acid in a 2-litre round-bottomed flask, warm on a water bath with shaking until the benzoic acid dissolves, and cool to 20°. Add 100 ml. of fuming nitric acid (sp. gr. 1·54) in portions

of 2-3 ml. Keep the temperature between 70° and 90° by means of external cooling with cold water ; avoid the evolution, in other than small quantities, of brown fumes. Cover the flask with a watch glass, and allow to stand for 1 hour or overnight. Heat the flask on a water bath for 4 hours ; considerable quantities of nitrous fumes are liberated. Allow to cool to room temperature, preferably with mechanical stirring, when yellow crystals will separate from the solution. Add a further 75 ml. of fuming nitric acid ; heat the mixture on a water bath for 3 hours, then in an oil bath at 135–145° for 3 hours. Allow the reaction mixture to cool and pour it into a mixture of 800 g. of finely-crushed ice and 800 ml. of water. Allow to stand for 30–60 minutes, filter off the crude 3 : 5-dinitrobenzoic acid at the pump, and wash it with water until free from sulphates. Recrystallise the crude acid (66 g. ; m.p. 201–202°) from 280 ml. of hot 50 per cent. alcohol. Collect the recrystallised material and dry in the steam oven. The yield of 3 : 5-dinitrobenzoic acid, m.p. 207°, is 62 g.

IV,169.

HOMOPHTHALIC ACID

Phthalimide. *Method 1.* Place 100 g. of phthalic anhydride and 105 ml. of concentrated ammonia solution (sp. gr. 0·88) in a 1-litre round-bottomed flask fitted with a wide air condenser (\lt 10 mm. in diameter). Heat first over a wire gauze and then over a free flame until the mixture is in a state of quiet fusion and forms a homogeneous melt (the temperature reaches 300° in about 1·5–2 hours ; all the water is evaporated during the first hour). Shake the flask occasionally during the heating and push down any material which sublimes into the condenser with a glass rod. Pour the contents of the flask whilst still hot into a porcelain basin or casserole, allow to cool, and grind to a fine powder in a mortar. The phthalimide (95 g.) is practically pure and melts at 233–234°. It may be recrystallised from alcohol, but the solubility is only slight (about 5 per cent.).

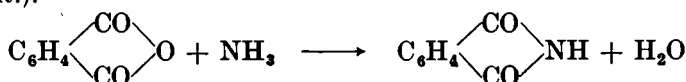

Method 2. Intimately mix 99 g. of pure phthalic anhydride and 20 g. of urea, and place the mixture in a 1 litre long-necked, round-bottomed flask. Heat the flask in an oil bath at 130–135°. When the contents have melted, effervescence commences and gradually increases in vigour : after 10–20 minutes, the mixture suddenly froths up to about three times the original volume (this is accompanied by a rise in temperature to 150–160°) and becomes almost solid. Remove the flame from beneath the bath and allow to cool. Add about 80 ml. of water to disintegrate the solid in the flask, filter at the pump, wash with a little water, and then dry at 100°. The yield of phthalimide, m.p. 233° (*i.e.*, it is practically pure) is 86 g. If desired, the phthalimide may be recrystallised from 1200 ml. of methylated spirit ; the first crop consists of 34 g. of m.p. 234°, but further quantities may be recovered from the mother liquor.

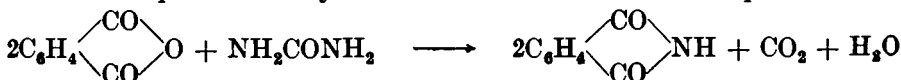

Phthalide. In a 1 litre bolt-head flask stir 90 g. of a high quality zinc powder to a thick paste with a solution of 0.5 g. of crystallised copper sulphate in 20 ml. of water (this serves to activate the zinc), and then add 165 ml. of 20 per cent. sodium hydroxide solution. Cool the flask in an ice bath to 5°, stir the contents mechanically, and add 73.5 g. of phthalimide in small portions at such a rate that the temperature does not rise above 8° (about 30 minutes are required for the addition). Continue the stirring for half an hour, dilute with 200 ml. of water, warm on a water bath until the evolution of ammonia ceases (about 3 hours), and concentrate to a volume of about 200 ml. by distillation under reduced pressure (Fig. II, 37, 1). Filter, and render the filtrate acid to Congo red paper with concentrated hydrochloric acid (about 75 ml. are required). Much of the phthalide separates as an oil, but, in order to complete the lactonisation of the hydroxymethylbenzoic acid, boil for an hour: transfer while hot to a beaker. The oil solidifies on cooling to a hard red-brown cake. Leave overnight in an ice chest or refrigerator, and then filter at the pump. The crude phthalide contains much sodium chloride. Recrystallise it in 10 g. portions from 750 ml. of water: use the mother liquor from the first crop for the recrystallisation of the subsequent portion. Filter each portion while hot, cool in ice below 5°, filter and wash with small quantities of ice-cold water. Dry in the air upon filter paper. The yield of phthalide (transparent plates), m.p. 72–73°, is 47 g.

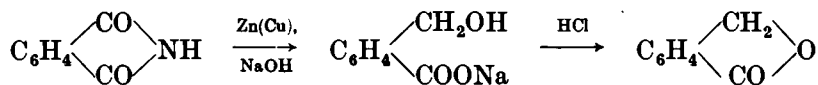

***o*-Carboxyphenylacetonitrile.** Into a 1 litre bolt-head flask, provided with a mechanical stirrer and a thermometer, place 40 g. of phthalide and 40 g. of powdered potassium cyanide. Heat the stirred mixture to 180–190° (internal temperature) in an oil bath for 4–5 hours. Allow to cool, add 400 ml. of distilled water and stir the mixture until all the solids are dissolved (about 1 hour). Filter off any unreacted phthalide. Add dilute hydrochloric acid (1:1) to the dark aqueous solution* until it becomes turbid (about 20 ml. are required), and continue the addition until the solution is slightly acid: filter off any dark impurities which may separate. Neutralise the solution carefully with sodium bicarbonate, add a few grams of decolourising carbon, stir the mixture for several minutes and filter. Acidify the nearly colourless filtrate with about 20 ml. of concentrated hydrochloric acid, cool in ice, and filter at the pump. The resulting *o*-carboxyphenylacetonitrile (40 g.) melts at 114–115° and is satisfactory for most purposes. It may be crystallised from benzene or glacial acetic acid, but with considerable loss.

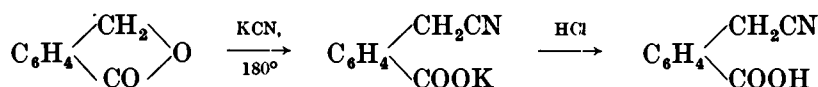

Homophthalic acid. Place a mixture of 25 g. of *o*-carboxyphenylacetonitrile and 25 g. of 50 per cent. sulphuric acid in a 100 ml. flask, heat

* This operation should be conducted in a fume cupboard (hood) as hydrogen cyanide may be evolved.

the mixture on a water bath for 10–12 hours and then pour it into twice its volume of ice and water. Filter the precipitate at the pump and dry in the air. The yield of crude homophthalic acid is 21 g. Recrystallise by dissolving it in 500 ml. of boiling water, add decolourising carbon, filter the hot solution through a hot water funnel, and cool the filtrate in an ice bath : collect the acid and dry at 100°. The yield of practically colourless acid, m.p. 181°, is 17 g. The melting point depends upon the rate of heating ; immersion of the capillary in a bath at 170° gives a m.p. of 182–183°.

IV,170.**ANTHRANILIC ACID**

Prepare a solution of 30 g. of sodium hydroxide in 120 ml. of water in a 350 ml. conical flask and cool to 0° or below in a bath of ice and salt. Add 26·2 g. (8·4 ml.) of bromine in one portion and shake (or stir) until all the bromine has reacted. The temperature will rise somewhat ; cool again to 0° or below. Meanwhile, prepare a solution of 22 g. of sodium hydroxide in 80 ml. of water. Add 24 g. of finely-powdered phthalimide (Section IV,169) in one portion to the cold sodium hypobromite solution ; stir vigorously while swirling the contents of the flask and add the prepared sodium hydroxide solution rapidly. The solid will dissolve and the temperature will rise to about 70°. Warm the mixture to 80° for about 2 minutes. Filter, if necessary. Cool in ice and add concentrated hydrochloric acid slowly and with stirring until the solution is *just* neutral (about 60 ml. are required). [It is recommended that a little of the alkaline solution be set aside in case too much acid is added.] Precipitate the anthranilic acid completely by the gradual addition of glacial acetic acid (20–25 ml. are required) : it is advisable to transfer the mixture to a 1 litre beaker as some foaming occurs. Filter off the acid at the pump and wash with a little cold water. Recrystallise from hot water with the addition of a little decolourising carbon ; collect the acid on a Buchner funnel and dry at 100°. The yield of pure anthranilic acid, m.p. 145°, is 14 g.

IV,171.**DIPHENYLACETIC ACID**

Place 125 ml. of glacial acetic acid, 7·5 g. of purified red phosphorus (Section II,50,5) and 2·5 g. of iodine in a 500 ml. round-bottomed flask fitted with a reflux condenser. Allow the mixture to stand for 15–20 minutes with occasional shaking until all the iodine has reacted, then add 2·5 ml. of water and 50 g. of benzilic acid (Section IV,127). Boil the mixture under reflux for 3 hours, and filter the hot mixture at the pump through a sintered glass funnel to remove the excess of red phosphorus. Pour the hot filtrate into a cold, well-stirred solution of 12 g. of sodium bisulphite in 500 ml. of water ; the latter should be acid to litmus, produced, if necessary, by passing sulphur dioxide through the solution. This procedure removes the excess of iodine and precipitates the diphenylacetic acid as a fine white or pale yellow powder. Filter the solid with suction and dry in the air upon filter paper. The yield is 45 g., m.p.

142–144°. Upon recrystallisation from about 250 ml. of 50 per cent. alcohol, crystalline diphenylacetic acid, m.p. 144–145° (1), is obtained.

Note.

(1) Benzilic acid melts at 149–150°, *i.e.*, very close to that of diphenylacetic acid. The completeness of the reduction can easily be tested by treating a little of the product with concentrated sulphuric acid; if even a trace of benzilic acid remains, the sulphuric acid will have a red colour.

IV,172.

MANDELIC ACID

Into a 750 ml. wide-mouthed bottle, provided with a mechanical stirrer, place a solution of 25 g. of technical sodium cyanide (97–98 per cent. NaCN) in 100 ml. of water and 53 g. (51 ml.) of purified benzaldehyde (Section IV,115). Prepare a saturated solution of sodium bisulphite by stirring 250 g. of finely-powdered technical sodium bisulphite with 335 ml. of water and filtering to remove the excess of the salt. Stir the mixture in the bottle and add the sodium bisulphite solution slowly at first and then more rapidly (the addition occupies 10–15 minutes). During the addition of the first half of the solution, add 150 g. of crushed ice to the reaction mixture in several portions. Transfer the product to a separatory funnel and remove the layer of crude mandelonitrile (1). Place the latter at once (2) in a large evaporating dish, add 75 ml. of concentrated hydrochloric acid, cover with a clock glass, and allow the hydrolysis to proceed in the cold for 12 hours; finally evaporate to dryness on a water bath. Grind the residue of slightly discoloured mandelic acid and inorganic salts to a fine powder in a mortar and wash it twice with 125 ml. portions of cold benzene: this process will remove most of the colouring matter and a negligible quantity of mandelic acid. To separate inorganic salts from the mandelic acid, extract the residue in a Soxhlet apparatus (Figs. II,44, 4–6) with about 200 ml. of benzene on a water bath. Allow the hot benzene extract to crystallise, collect the crystals on a Buchner funnel and dry in the air. The yield of pure *dl*-mandelic acid, m.p. 118°, is 35 g.

Notes.

(1) A small quantity of mandelonitrile may be obtained by extracting the aqueous layer with 25 ml. of benzene, evaporating the benzene, and adding the residue to the main portion. This extraction is hardly worth while except for large scale preparations.

(2) It is important to mix the mandelonitrile with hydrochloric acid immediately it has been separated from the water. Standing results in rapid conversion to the acetal of benzaldehyde and mandelonitrile $C_6H_5CH[OCH(CN)C_6H_5]_2$, and/or the *iso*-nitrile; the yield of mandelic acid will, in consequence, be reduced.

IV,173.

SALICYLIC ACID

Place 10 g. of clean sodium (cut into small pieces) in a 500 ml. round-bottomed flask fitted with a double surface reflux condenser. Introduce 100 g. (127 ml.) of absolute ethyl alcohol and allow the reaction to proceed as vigorously as possible; if the alcohol tends to flood the condenser, cool the flask momentarily with a wet towel or by a stream of cold water. When all the sodium has reacted, add 40 g. of pure phenol. Distil off the

alcohol using a free flame : shake the flask frequently during the process until a powdery mass is produced. Transfer the solid rapidly to a dry mortar, powder rapidly, and transfer the powder to a 250 ml. distilling flask. Immerse the bulb of the flask in an oil bath, and insert a gas inlet tube in the mouth so that it terminates about 1 cm. above the sodium phenoxide. Heat the oil bath to 110° and pass dry carbon dioxide into the flask for 1 hour. Raise the temperature gradually during 4 hours to 190° (20° an hour) and finally maintain the temperature at 200° for 1.5 hours. Pass a fairly rapid stream of carbon dioxide into the flask during the whole of the heating period ; stir the contents of the flask frequently with a glass rod (this will necessitate removing the gas inlet tube momentarily) in order to expose a fresh portion of the solid to the action of the gas. Allow the reaction product to cool, transfer it to a large beaker and rinse the distilling flask several times with water. Precipitate the salicylic acid by the addition of excess of concentrated hydrochloric acid. Cool in ice, filter at the pump, and wash with a little cold water. Recrystallise the crude acid from hot water with the addition of a little decolourising carbon. The yield of air-dried salicylic acid, m.p. 159°, is 16 g.

COGNATE PREPARATIONS

β -Resorcylic acid. Place a solution containing 40 g. of resorcinol, 200 g. of potassium bicarbonate and 400 ml. of water in a litre flask fitted with a reflux condenser and gas inlet tube. Heat gently on a steam bath for 4 hours ; then reflux vigorously over a flame for 30 minutes whilst passing a rapid stream of carbon dioxide through the solution. Acidify the solution whilst still hot by adding 180 ml. of concentrated hydrochloric acid from a separatory funnel with a long tube delivering acid to the bottom of the flask. Allow to cool to room temperature, chill in an ice bath, and collect the crude β -resorcylic acid by filtration with suction. Recrystallise by boiling the crude acid with 180–200 ml. of water in the presence of a little decolourising carbon, filter through a hot water funnel, and cool in an ice-salt mixture with stirring. Collect and dry the pure β -resorcylic acid ; the yield is 36 g., m.p. 216–217°.

***p*-Hydroxybenzoic acid.** Place 100 g. of A.R. salicylic acid and 150 ml. of water in an 8" porcelain dish and slowly stir in 60 g. of potassium carbonate. Evaporate the solution on a steam bath to a thick, pasty solid ; break this up into small pieces and dry at 105–110° for 2 hours. Finely grind the solid, dry for a further 2 hours at 105–110°, and grind again to a fine powder. Transfer the powder (a mixture of potassium salicylate and potassium carbonate) to a 500 ml. bolt-head flask immersed in an oil bath (*FUME CUPBOARD* !) so that only a small portion of the neck protrudes from the flask ; in this way, the phenol formed in the subsequent reaction distils out of the mixture. Heat the oil bath to 240° and maintain this temperature for 90 minutes ; stir the solid occasionally with a glass rod. When the reaction is complete (1), transfer the product while hot to a 2-litre flask containing 1 litre of hot water ; rinse the reaction flask with several portions of the hot solution. Acidify with concentrated hydrochloric acid (*ca.* 75 ml. are required), heat nearly to boiling, add 5 g. of decolourising carbon, filter, cool, and collect the brown

solid by suction filtration. Concentrate the filtrate to about 300 ml., cool and collect a second crop of the acid. Dissolve the crude acid in 300 ml. of hot water, boil for a few minutes with 5 g. of decolourising carbon, and filter. Cool the filtrate under the tap, filter the solid with suction, wash with 15 ml. of cold water and dry. The yield of *p*-hydroxybenzoic acid, m.p. 211–212°, is 40 g.

Note.

(1) This may be determined roughly by treating a small test portion with 3–4 ml. of hot water and acidifying with concentrated hydrochloric acid; the absence of a precipitate in the warm solution indicates the essential completeness of the reaction. Salicylic acid is sparingly soluble and *p*-hydroxybenzoic acid is relatively soluble under these conditions.

IV,174. PHENYLPROPIOLIC ACID

Place a solution of 88 g. (84 ml.) of ethyl cinnamate (Section IV,131) in 50 ml. of carbon tetrachloride in a 500 ml. round-bottomed flask and fit it with a two-holed stopper. Immerse the flask in ice and insert a separatory funnel charged with 80 g. (25.5 ml.) of bromine in one hole of the stopper. Add the bromine slowly with frequent shaking. The halogen will disappear rapidly at first, but more slowly towards the end of the reaction; no hydrogen bromide is evolved and the time of the addition is about 20–25 minutes. Allow the mixture to stand for 1 hour, pour the solution into a large evaporating dish and permit the excess of bromine and the carbon tetrachloride to evaporate spontaneously in the fume cupboard. The crude ethyl $\alpha\beta$ -dibromo- β -phenylpropionate will remain as a solid cake; this can be dried by pressing between large filter papers. The yield of crude ester, m.p. 66–71°, is 140 g. (1).

Dissolve 85 g. of potassium hydroxide in 400 ml. of rectified spirit by heating in a 1500 ml. round-bottomed flask, provided with a reflux condenser, on a water bath. Cool to 40–50°, and add 112 g. of the crude dibromo ester; when the initial exothermic reaction has subsided, heat the mixture on a water bath for 5–6 hours. Pour the contents of the flask into a large beaker and, when cold, add concentrated hydrochloric acid with stirring until neutral to litmus. Cool, filter the precipitated solids at the pump, and wash with a little alcohol. Set the solids (A) aside. Transfer the filtrate to the original flask and distil the liquid (Fig. II, 13, 3) from a wire gauze or from an air bath until the temperature of the vapour reaches 95°. Combine the residue in the flask with the precipitated solids (A), dissolve in 270 ml. of water, add about 300 g. of crushed ice, and cool the flask in an ice bath. Stir the mixture mechanically, and add 20 per cent. sulphuric acid slowly until the solution is strongly acid to Congo red. Allow to stand for 20 minutes, filter off the dark-coloured crude phenylpropionic acid at the pump and wash it with three 15 ml. portions of 2 per cent. sulphuric acid. Dissolve the solid in about 300 ml. of 5 per cent. sodium carbonate solution, add 6 g. of decolourising carbon, and heat on a water bath for 30 minutes with occasional shaking. Filter through a fluted filter paper, cool the filtrate in ice, and then add 70 g. of crushed ice. Stir the solution mechanically and add 20 per cent. sulphuric acid slowly until acid to Congo red. After 20 minutes, filter

the precipitated acid by suction, wash with 15 ml. of 2 per cent. sulphuric acid, then with a little water, and dry in the air. The yield of pure phenylpropionic acid, m.p. 134–135°, is 23 g.

Note.

(1) To obtain the pure dibromo ester, recrystallise from light petroleum, b.p. (60–80°); the recovery of the pure ester, m.p. 75°, is 85 per cent.

IV,175. REACTIONS AND CHARACTERISATION OF AROMATIC CARBOXYLIC ACIDS

Aromatic carboxylic acids are usually crystalline solids, burn with a smoky flame, and are generally sparingly soluble in water. They may be detected and characterised as already described under *Aliphatic Carboxylic Acids* (Section III,85).

An additional useful test is to distil the acid or its sodium salt with soda lime. Heat 0.5 g. of the acid or its sodium salt with 0.2 g. of soda lime in an ignition tube to make certain that there is no explosion. Then grind together 0.5 g. of the acid with 3 g. of soda lime, place the mixture in a Pyrex test-tube and cover it with an equal bulk of soda lime. Fit a wide delivery tube dipping into an empty test-tube. Clamp the tube near the mouth. Heat the soda lime first and then the mixture gradually to a dull-red heat. Examine the product: this may consist of aromatic hydrocarbons or derivatives, e.g., phenol from salicylic acid, anisole from anisic acid, toluene from toluic acid, etc.

The melting points of the derivatives of a number of selected aromatic carboxylic acids are collected in Table IV,175.

TABLE IV.175.

AROMATIC CARBOXYLIC ACIDS

Acid	B.P.	M.P.	Anilide	<i>p</i> -Toluidide	Amide	<i>p</i> -Bromophenacyl Ester	<i>p</i> -Nitrophenyl Ester	<i>p</i> -Phenylphenacyl Ester	<i>S</i> -Benzyl- <i>iso</i> -thiuronium Salt	Other Derivatives
Benzoic	249°	121°	162°	158°	129°	119°	89°	167°	167°	Hydrazide, 112°
<i>o</i> -Toluic	259	105	125	144	143	57	91	95	146	Hydrazide, 124
<i>m</i> -Toluic	263	111	126	118	95	108	87	136	140	Hydrazide, 97
<i>p</i> -Toluic	274	178	148	160	159	153	104	165	190	Hydrazide, 117
Phenylacetic	265	76	118	136	157	89	65	88	165	—
<i>o</i> -Chlorobenzoic	—	141	118	131	141	107	106	123	—	Hydrazide, 110
<i>m</i> -Chlorobenzoic	—	158	124	—	134	117	107	154	155	Hydrazide, 158
<i>p</i> -Chlorobenzoic	—	243	194	—	179	126	130	160	—	Hydrazide, 163
<i>o</i> -Bromobenzoic	—	150	141	—	155	102	110	98	171	—
<i>m</i> -Bromobenzoic	—	155	146	—	155	126	105	155	168	—
<i>p</i> -Bromobenzoic	—	252	197	—	189	134	141	160	—	Hydrazide, 164
<i>o</i> -Iodobenzoic	—	162	141	—	184	110	111	143	—	—
<i>m</i> -Iodobenzoic	—	187	—	—	186	128	121	—	—	—
<i>p</i> -Iodobenzoic	—	270	210	—	218	146	141	171	—	—
<i>o</i> -Nitrobenzoic	—	147	155	—	175	107	112	140	159	—
<i>m</i> -Nitrobenzoic	—	141	154	162	142	132	142	153	163	—
<i>p</i> -Nitrobenzoic	—	239	211	203	200	136	169	182	182	—
2 : 4-Dinitrobenzoic	—	183	—	—	204	158	142	—	—	—
3 : 5-Dinitrobenzoic	—	207	234	—	183	159	157	154	—	—
2 : 4 : 6-Trinitrobenzoic	—	228	—	—	264	—	—	—	—	—
Salicylic	—	158	135	156	139	140	98	148	148	Benzoyl, 132; <i>p</i> -nitrobenzoyl, 205
<i>m</i> -Hydroxybenzoic	—	201	157	163	167	176	108	—	—	Acetyl, 131
<i>p</i> -Hydroxybenzoic	—	213	197	204	162	191	192	240	145	Acetyl, 187
Resorcylic (1)	—	213	127	—	221	—	189	—	—	—
Protocatechuic (2)	—	199	167	—	212	—	188	—	—	—
Piperonylic (3)	—	229	—	—	169	—	—	—	—	—
<i>o</i> -Methoxybenzoic	—	101	131	—	129	—	113	131	—	—
<i>m</i> -Methoxybenzoic	—	110	—	—	—	—	—	—	—	—
Anisic (4)	—	184	171	186	163	152	132	160	185	—
Anthranilic	—	146	131	151	109	—	205	—	149	<i>N</i> -Benzoyl, 81; <i>N</i> - <i>p</i> -toluenesulphonyl, 217
<i>m</i> -Aminobenzoic	—	174	140	—	111	—	201	—	—	<i>N</i> -Acetyl, 248
<i>p</i> -Aminobenzoic	—	188	—	—	114	—	—	—	—	<i>N</i> -Acetyl, 250; <i>N</i> -benzoyl, 278
<i>o</i> -Ethoxybenzoic	—	25	—	—	132	—	—	—	—	—
<i>m</i> -Ethoxybenzoic	—	137	—	—	139	—	—	—	—	—
<i>p</i> -Ethoxybenzoic	—	198	170	—	202	—	110	—	—	—

TABLE IV,175

AROMATIC CARBOXYLIC ACIDS (continued)

Acid	B.P.	M.P.	Anilide	<i>p</i> -Toluidide	l Amide	<i>p</i> -Bromophenacyl Ester	<i>p</i> -Nitrobenzyl Ester	<i>p</i> -Phenylphenacyl Ester	S-Benzyl- <i>iso</i> -thiuronium Salt	Other Derivatives
Phenoxyacetic	—	99°	101°	—	101°	148°	—	—	—	—
<i>o</i> -Chlorophenoxyacetic	—	146	121	—	150	—	—	—	—	—
<i>m</i> -Chlorophenoxyacetic	—	110	—	—	—	—	—	—	—	—
<i>p</i> -Chlorophenoxyacetic	—	157	125	—	133	136	—	—	—	—
α -Naphthoic	—	162	163	—	202	—	—	—	—	—
β -Naphthoic	—	185	170	191°	192	—	—	—	—	—
3-Hydroxy-2-naphthoic	—	223	244	222	218	—	—	—	—	—
Phthalic	—	ca.208d	251	—	220	153	155°	167°	158°	—
<i>iso</i> -Phthalic	—	347	—	—	280	179	203	280	216	Hydrazide, 220°
Terephthalic	—	subl. 300	337	—	—	225	264	—	204	—
3-Nitrophthalic	—	219	234	223	201	—	190	149	—	—
4-Nitrophthalic	—	165	—	—	200	—	—	120	—	—
Cinnamic	300°	133	153	168	147	146	117	182	183	—
<i>o</i> -Nitrocinnamic	—	240	—	—	185	142	132	146	—	—
<i>m</i> -Nitrocinnamic	—	205	—	—	196	178	174	—	—	—
<i>p</i> -Nitrocinnamic	—	287	—	—	217	191	187	192	—	—
Hydrocinnamic (5)	—	48	98	135	105	104	36	95	—	—
Benzylmalonic	—	120d	217	—	225	—	120	—	—	—
Phenylpropionic	—	135	126	142	109	—	83	—	—	—
Hippuric	—	187	208	—	183	151	136	163	—	Hydrazide, 162
β -Phenylalanine (6)	—	273	—	—	140	—	222	—	—	<i>N</i> -Benzoyl, 188
<i>dl</i> -Mandelic	—	118	152	172	134	—	123	—	166	—
Benzilic	—	150	175	190	155	152	100	122	—	Acetyl, 98
Gallic	—	ca.240d	207	—	245	—	—	198d	—	Triacetyl, 172; tri-benzoyl, 192
Vanillic (7)	—	210	—	—	—	—	141	—	—	Acetyl, 146; benzoyl, 173
<i>o</i> -Benzoylbenzoic	—	128	195	—	165	—	100	—	—	—
Acetylsalicylic	—	135	136	—	138	—	90	—	144	—
Hexahydrobenzoic (8)	233	31	144	—	186	—	—	—	—	—
Trimesic (9)	—	380	—	—	365	197	—	—	—	Tri-Me-ester, 144; tri-Et-ester, 135
Diphenic	—	229	230	—	212	—	186	—	—	—
Diphenylacetic	—	148	180	173	168	—	—	111	—	—

- (1) 2:4-Dihydroxybenzoic acid.
 (2) 3:4-Dihydroxybenzoic acid.
 (3) 3:4-Methylenedioxybenzoic acid.

- (4) *p*-Methoxybenzoic acid.
 (5) β -Phenylpropionic acid.
 (6) α -Amino- β -phenylpropionic acid.

- (7) 4-Hydroxy-3-methoxybenzoic acid.
 (8) *cyclo*Hexanecarboxylic acid.
 (9) Benzene-1:3:5-tricarboxylic acid.

AROMATIC ESTERS

Aromatic esters may be prepared by methods similar to those already described for aliphatic esters (see discussion preceding Section III,95). These include :—

1. **From the acid.** By refluxing an aromatic acid (1 mol) with an excess (up to about 10 mols) of methyl or ethyl alcohol in the presence of a small proportion of concentrated sulphuric acid or hydrogen chloride (catalyst), the ester may be obtained in good yield. The excess of methyl or ethyl alcohol may be largely removed by distillation from a water bath or, less conveniently, by pouring into a large excess of water. For higher alcohols, *e.g.*, *n*-propyl or *n*-butyl alcohols, the proportion of alcohol may be considerably reduced (say, 1 mol of monobasic acid to 2 mols of alcohol) if a volume of pure dry benzene approximately equal to that of the alcohol is added. The following examples are given :

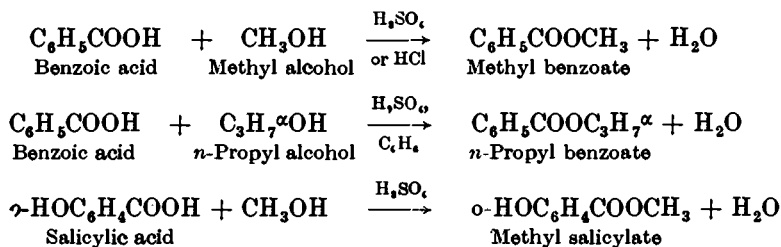

Esterification with an aromatic alcohol may be readily achieved by using an excess of the acid. The latter is readily removed by washing with water and/or treatment with sodium bicarbonate solution, for example :

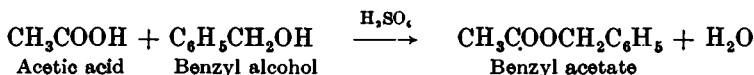

2. **From the nitrile.** By refluxing a mixture of the aromatic nitrile (with —CN group in side chain) with alcohol and concentrated sulphuric acid simultaneous hydrolysis and esterification occurs, for example :

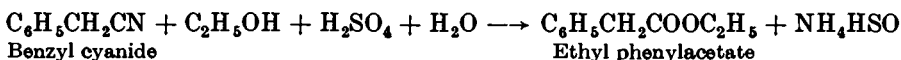

3. **From the acid chloride.** The interaction of the acid chloride of an aromatic acid with the calculated quantity of an alcohol or a phenol affords a good yield of the ester, for example :

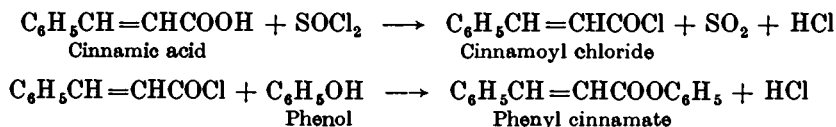

4. **By the Schotten-Baumann reaction.** Under the usual Schotten-Baumann conditions (compare discussion preceding Section IV,52, also Section IV,100, 2 and Section IV,114, 2), esters are readily formed, for example :

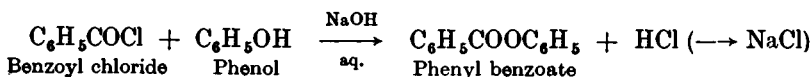

The esters formed with *p*-nitrobenzoyl chloride and 3:5-dinitrobenzoyl chloride (see Section III,27,1 and 2 and Section IV,205) must be included under this heading.

5. From the mono-halogenated hydrocarbon. The halogenated hydrocarbon is converted into the Grignard reagent and the latter allowed to react with diethyl carbonate, for example :

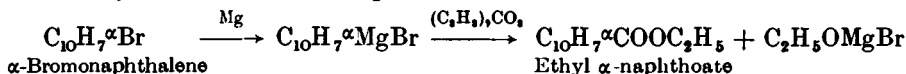

IV,176.

METHYL BENZOATE

In a 500 ml. round-bottomed flask place a mixture of 30 g. of benzoic acid, 80 g. (101 ml.) of absolute methyl alcohol and 5 g. (2.7 ml.) of concentrated sulphuric acid. Add a few small chips of porous porcelain, attach a reflux condenser and boil the mixture gently for 4 hours (1). Distil off the excess of alcohol on a water bath (see Fig. II, 13, 3) and allow to cool. Pour the residue into about 250 ml. of water contained in a separatory funnel and rinse the flask with a few ml. of water which are also poured into the separatory funnel. If, owing to the comparatively slight difference between the density of the ester and of water, difficulty is experienced in obtaining a sharp separation of the lower ester layer and water, add 10–15 ml. of carbon tetrachloride (2) and shake the mixture in the funnel vigorously; upon standing, the heavy solution of methyl benzoate in the carbon tetrachloride separates sharply and rapidly at the bottom of the separatory funnel. Run off the lower layer carefully, reject the upper aqueous layer, return the methyl benzoate to the funnel and shake it with a strong solution of sodium bicarbonate until all free acid is removed and no further evolution of carbon dioxide occurs. Wash once with water, and dry by pouring into a small dry conical flask containing about 5 g. of anhydrous magnesium sulphate. Cork the flask, shake for about 5 minutes, and allow to stand for at least half an hour with occasional shaking. Filter the methyl benzoate solution through a small fluted filter paper directly into a small distilling flask containing a few chips of unglazed porcelain ("porous pot"). Fit the flask with a 360° thermometer and a condenser (a simple air condenser may be used, but a small Liebig's condenser with an empty water jacket is quite satisfactory). Distil from an air bath (Fig. II, 5, 3); raise the temperature *slowly* at first (3) until all carbon tetrachloride has passed over and then heat more strongly. Collect the methyl benzoate (a colourless liquid) at 198–200°. The yield is 31 g.

Notes.

(1) Slightly improved results may be obtained by increasing the time of heating.

(2) Alternatively, the ester may be extracted with two 50 ml. portions of ether. The ethereal solution is washed with concentrated sodium bicarbonate solution (handle the separatory funnel cautiously as carbon dioxide is evolved) until effervescence ceases, then with water, and dried over anhydrous magnesium sulphate. The ether is removed with the aid of the apparatus depicted in Fig. II, 13, 4, and the residual ester distilled.

(3) In view of the small quantity of carbon tetrachloride present, the use of a water condenser during the early stages of the distillation, although desirable for complete recovery of the solvent, is not essential.

COGNATE PREPARATIONS

Ethyl benzoate (*sulphuric acid as a catalyst*). Use 30 g. of benzoic acid, 115 g. (145 ml.) of absolute ethyl alcohol and 5 g. (2.7 ml.) of concentrated sulphuric acid. Reflux the mixture for 4 hours and work up as for *Methyl Benzoate*. The yield of ethyl benzoate, b.p. 212–214°, is 32 g.

Ethyl benzoate (*hydrogen chloride as a catalyst*). Pass dry hydrogen chloride (Section II, 48, 1) into a 500 ml. round-bottomed flask containing 115 g. (145 ml.) of absolute ethyl alcohol, cooled in an ice bath, until the increase in weight is 6 g. Add 30 g. of benzoic acid and reflux the mixture for 4 hours. Isolate the pure ester, b.p. 212–214°, as described for *Methyl Benzoate*. The yield is 32 g.

n-Propyl benzoate. Into a 500 ml. round-bottomed flask place 30 g. of benzoic acid, 30 g. (37.5 ml.) of *n*-propyl alcohol, 50 ml. of sodium-dried A.R. benzene and 10 g. (5.4 ml.) of concentrated sulphuric acid. Reflux the mixture for 10 hours. Pour the reaction product into about 250 ml. of water, and extract with ether. Wash the ethereal extract with saturated sodium bicarbonate solution and then with water: dry over anhydrous magnesium sulphate. Distil off the ether and some of the benzene through a fractionating column, and distil the residue from a Claisen flask. Collect the *n*-propyl benzoate at 229–230°. The yield is 37 g.

n-Butyl benzoate. Use 30 g. of benzoic acid, 37 g. (46 ml.) of *n*-butyl alcohol, 50 ml. of sodium-dried A.R. benzene and 10 g. (5.4 ml.) of concentrated sulphuric acid, and reflux the mixture for 12 hours. Work up the product as for *n-Propyl Benzoate*; after the ether and benzene have been removed under atmospheric pressure, distil the residue under reduced pressure. The yield of *n*-butyl benzoate, b.p. 119–120°/11 mm. is 35 g.

IV,177.

METHYL SALICYLATE

In a 500 ml. round-bottomed flask place 28 g. of salicylic acid (Section IV, 173) and 64 g. (81 ml.) of absolute methyl alcohol, and add cautiously, with shaking, 8 ml. of concentrated sulphuric acid, followed by a few fragments of porous porcelain. Fit the flask with a reflux condenser and reflux on a water bath for at least 5 hours. Distil off the excess of methyl alcohol on a water bath (see Fig. II, 13, 3) and allow to cool. Pour the residue into about 250 ml. of water in a separatory funnel, shake the mixture and allow to stand. Run off the lower layer of ester (1) and discard the aqueous layer. Wash the ester successively with 25 ml. of water, concentrated sodium bicarbonate solution until all the free acid is removed, and water; dry over about 5 g. of anhydrous magnesium sulphate in a small conical flask for at least 30 minutes. Filter the ester through a fluted filter paper into a small distilling flask, and distil using an air condenser (compare Fig. II, 13, 2) and an air bath (Fig. II, 5, 3). Collect the pure methyl salicylate (a colourless oil of delightful fragrance, "oil of winter green") at 221–224°; the yield is 25 g. The ester may also be distilled under reduced pressure (see Fig. II, 20, 1); the b.p. is 115°/20 mm. and a 2° fraction should be collected.

Note.

(1) If an emulsion should form during the washing process, add about 10 ml. of carbon tetrachloride (for details, see under *Methyl Benzoate*, Section IV,176).

COGNATE PREPARATION

Ethyl salicylate. Use 28 g. of salicylic acid, 84 g. (106 ml.) of absolute ethyl alcohol and 8 ml. of concentrated sulphuric acid. Reflux the mixture for at least 5 hours. The yield of ethyl salicylate (a colourless liquid), b.p. 231–234°, is 26 g. It is more convenient in practice to distill the liquid under reduced pressure: the boiling points under various pressures are given in Table II, 19.

IV,178.**BENZYL ACETATE**

Mix 31 g. (29.5 ml.) of benzyl alcohol (Section IV, 123 and Section IV,200) and 45 g. (43 ml.) of glacial acetic acid in a 500 ml. round-bottomed flask; introduce 1 ml. of concentrated sulphuric acid and a few fragments of "porous pot." Attach a reflux condenser to the flask and boil the mixture gently for 9 hours. Pour the reaction mixture into about 200 ml. of water contained in a separatory funnel, add 10 ml. of carbon tetrachloride (to eliminate emulsion formation owing to the slight difference in density of the ester and water, compare *Methyl Benzoate*, Section IV,176) and shake. Separate the lower layer (solution of benzyl acetate in carbon tetrachloride) and discard the upper aqueous layer. Return the lower layer to the funnel, and wash it successively with water, concentrated sodium bicarbonate solution (until effervescence ceases) and water. Dry over 5 g. of anhydrous magnesium sulphate, and distil under normal pressure (Fig. II, 13, 2) with the aid of an air bath (Fig. II, 5, 3). Collect the benzyl acetate a (colourless liquid) at 213–215°. The yield is 16 g.

IV,179.**ETHYL PHENYLACETATE**

Place 75 g. (74 ml.) of benzyl cyanide (Section IV,160), 125 g. (153 ml.) of rectified spirit and 150 g. (68 ml.) of concentrated sulphuric acid in a 750 ml. round-bottomed flask, fitted with an efficient reflux condenser. Reflux the mixture, which soon separates into two layers, gently for 8 hours, cool and pour into 350 ml. of water. Separate the upper layer. Dissolve it in about 75 ml. of ether (1) in order to facilitate the separation of the layers in the subsequent washing process. Wash the ethereal solution carefully with concentrated sodium bicarbonate solution until effervescence ceases and then with water. Dry over 10 g. of anhydrous magnesium sulphate for at least 30 minutes. Remove the solvent with the aid of the apparatus shown in Fig. II, 13, 4 and distil from an air bath (Fig. II, 5, 3). The ethyl phenylacetate passes over at 225–229° (mainly 228°) as a colourless liquid; the yield is 90 g. Alternatively, the residue after removal of the ether may be distilled in a Claisen flask under diminished pressure (Fig. II, 20, 1); collect the ester at 116–118°/20 mm.

Note.

(1) The use of ether may be avoided by mixing the ester, after its isolation from the water layer, with about 20 ml. of carbon tetrachloride. The carbon tetrachloride solution then forms the lower layer in all washing operations (compare *Methyl Benzoate*, Section IV,176).

IV,180. PHENYL CINNAMATE

Into a 250 ml. Claisen flask placé 72 g. of cinnamic acid (Section IV,124) and 60 g. (37 ml.) of redistilled thionyl chloride. Stopper the side arm, fit the flask with a reflux condenser the top of which is connected to a gas absorption device (Fig. II,8, 1, *c* or *d*), and mount the entire apparatus at an angle so that the condensate will not run into the side arm (compare Fig. III, 31, 1 or III, 28, 1). Heat the mixture on a water bath, cautiously at first, until hydrogen chloride ceases to be evolved (about 1 hour), allow to cool, and add 47 g. of pure (*e.g.*, A.R.) phenol. Heat the mixture on a water bath until no further evolution of hydrogen chloride is observed (about 1 hour). Then place the apparatus on an asbestos-centred wire gauze and heat the flask until the contents are brought just to the reflux temperature in order to complete the reaction: do not heat unduly long as prolonged heating leads to loss of product due to decomposition and polymerisation. Allow the reaction mixture to cool and distil under diminished pressure; collect the fraction of b.p. 190–210°/15 mm. This solidifies to a pale yellow solid, m.p. 66–69°, weighing 98 g. Grind it to a powder in a glass mortar and wash the powder with 250 ml. of cold 2 per cent. sodium bicarbonate solution. Recrystallise from rectified spirit (150 ml.): 81 g. of pure phenyl cinnamate (white crystals) of m.p. 75–76° are obtained.

IV,181. PHENYL BENZOATE

Dissolve 5 g. of phenol in 75 ml. of 10 per cent. sodium hydroxide solution contained in a wide-mouthed reagent bottle or conical flask of about 200 ml. capacity. Add 11 g. (9 ml.) of redistilled benzoyl chloride, cork the vessel securely, and shake the mixture vigorously for 15–20 minutes. At the end of this period the reaction is usually practically complete and a solid product is obtained. Filter off the solid ester with suction, break up any lumps on the filter, wash thoroughly with water and drain well. Recrystallise the crude ester from rectified (or methylated) spirit; use a quantity of hot solvent approximately twice the minimum volume required for complete solution in order to ensure that the ester does not separate until the temperature of the solution has fallen below the melting point of phenyl benzoate. Filter the hot solution, if necessary, through a hot water funnel or through a Buchner funnel preheated by the filtration of some boiling solvent. Colourless crystals of phenyl benzoate, m.p. 69°, are thus obtained. The yield is 8 g.

COGNATE PREPARATION

β-Naphthyl benzoate. Dissolve 7.2 g. of β-naphthol in 40 ml. of 5 per cent. sodium hydroxide solution in the cold; add a little more water if necessary. If the solution is highly coloured, add 1.5 g. of decolourising

carbon and filter the cold solution through a hardened filter paper. Pour the solution into a 100 ml. conical flask and run in 7.0 g. (5.8 ml.) of benzoyl chloride. Stopper the flask and shake vigorously until the odour of benzoyl chloride has disappeared (10–15 minutes). Filter off the solid product on a Buchner funnel and wash it with a little cold water. Recrystallise it from about 60 ml. of methylated spirit (use the apparatus of Fig. II, 13, 7) but without guard tube. Filter off the crystals which separate and dry them upon filter paper in the air. The yield of pure β -naphthyl benzoate, m.p. 110°, is 11 g.

IV,182. ETHYL α -NAPHTHOATE

In a 1.5-litre three-necked flask prepare a solution of α -naphthyl magnesium bromide from 12.2 g. of magnesium turnings as detailed under *α -Naphthoic Acid*, Section IV,163, *Method 2*; add just sufficient sodium-dried benzene to form a homogeneous solution. Transfer the Grignard reagent to a separatory funnel and place 88.5 g. (91 ml.) of pure diethyl carbonate (1) and 50 ml. of sodium-dried ether in the three-necked flask. Stir and add the α -naphthyl magnesium bromide as rapidly as the refluxing of the solution will permit. Continue the stirring for a further 30 minutes and allow the reaction mixture to stand overnight. Then pour the reaction mixture, with frequent shaking, into a 2.5 litre flask containing 750 g. of crushed ice. Dissolve the basic magnesium bromide by adding gradually 72.5 ml. of cold 30 per cent. sulphuric acid (15 ml. of concentrated sulphuric acid and 60 ml. of water). Separate the upper layer and extract the aqueous layer with 50 ml. of ether. Concentrate the extracts to about 200 ml. by distilling the solvent from a water bath. Wash the residue with two 20 ml. portions of 5 per cent. sodium carbonate solution (2), and dry with 10 g. of anhydrous magnesium sulphate or calcium sulphate. Remove the solvent (Fig. II, 13, 4) and distil the residual liquid: collect the fraction b.p. 290–310° as crude ethyl α -naphthoate. Redistil from a Claisen flask with fractionating side arm (Figs. II, 24, 2–5) and collect the pure ester at 143–145°/3 mm. The yield is 70 g.

Notes.

(1) To purify commercial diethyl carbonate wash 100 ml. of the compound with 20 ml. of 10 per cent. sodium carbonate solution, then with 20 ml. of saturated calcium chloride solution, and finally with 30 ml. of water. Dry the ester by allowing it to stand for 2 hours over 5 g. of anhydrous calcium chloride (prolonged contact results in combination of the ester with the salt), distil and collect pure diethyl carbonate at 125–126°.

(2) Upon acidifying the alkaline washings, about 1 g. of α -naphthoic acid may be isolated.

IV,183. REACTIONS AND CHARACTERISATION OF AROMATIC ESTERS

Aromatic esters usually burn with a smoky flame, possess reasonably high boiling points, and are (particularly esters of phenols) sometimes crystalline solids. Phenyl esters usually give phenol upon distillation with soda lime (see Section IV,175 for general details).

The experimental details already given for the detection and characterisation of aliphatic esters (determination of saponification equivalents ; hydrolysis : Section III,106) apply equally to aromatic esters. A slight modification in the procedure for isolating the products of hydrolysis is necessary for phenolic (or phenyl) esters since the alkaline solution will contain both the alkali phenate and the alkali salt of the organic acid : upon acidification, both the phenol and the acid will be liberated. Two methods may be used for separating the phenol and the acid :

1. Acidify the cold alkaline reaction mixture with dilute sulphuric acid (use litmus or Congo red paper) and extract both the acid and the phenol with ether. Remove the acid by washing the ethereal extract with saturated sodium bicarbonate solution until effervescence ceases ; retain the aqueous washings. Upon evaporating the ether, the phenol remains ; it may be identified (a) by its action upon ferric chloride solution, (b) the formation of a crystalline derivative with bromine water, and (c) by any of the methods given in Section IV,114. Acidify the aqueous washings with dilute sulphuric acid whilst stirring steadily, and investigate the organic acid (Sections III,85 and IV,175).

2. Add dilute sulphuric acid, with stirring, to the cold alkaline solution until the solution is acid to litmus or Congo red paper and the acid, if a solid, commences to separate as a faint permanent precipitate. Now add dilute sodium carbonate solution until the solution is alkaline (litmus paper) and any precipitate has completely redissolved. Extract the clear solution twice with ether : evaporate or distil the ether from the ethereal solution on a water bath (*CAUTION* : no flames may be near) and identify the residual phenol as under 1. Remove the dissolved ether from the aqueous solution by boiling, acidify with dilute sulphuric acid and identify the organic acid present (see Sections III,85 and IV,175).

The student is recommended to carry out the hydrolysis of phenyl benzoate. Place a mixture of 2 g. of phenyl benzoate (Section IV,181) and 25 ml. of 10 per cent. aqueous sodium hydroxide solution in a 100 ml. flask fitted with a reflux condenser. Boil until the ester has completely disappeared (about 1 hour). If any unchanged ester volatilises in the steam and crystallises in the condenser, pour about 5 ml. of 10 per cent. sodium hydroxide solution down the condenser in order to return the ester to the flask. Cool the clear solution in ice and, when cold, add dilute sulphuric acid with stirring until a faint but permanent precipitate is formed : test with litmus or Congo red paper to ensure that the solution is acidic. Then add dilute sodium carbonate solution with vigorous stirring until the precipitate just redissolves and the solution is alkaline to litmus paper. Extract the solution twice with ether, dry the combined ethereal extracts with anhydrous magnesium sulphate or potassium carbonate and distil off most of the ether. Pour the remainder while still hot into an evaporating or crystallising dish ; the phenol will crystallise when all the ether has evaporated. Prepare a crystalline derivative of the phenol. Acidify the aqueous solution from the ether extraction with dilute sulphuric acid, filter off the benzoic acid with suction, wash with water, and recrystallise from boiling water. Confirm the identity of the acid by a mixed m.p. determination.

Table IV,183 summarises the physical properties of a few selected aromatic esters.

TABLE IV, 183.

AROMATIC ESTERS

	B.P.	M.P.	d_4^{20}	n_D^{20}
Methyl benzoate	199°	—	1.089	1.517
Ethyl benzoate	212	—	1.047	1.505
<i>n</i> -Propyl benzoate	230	—	1.023	1.500
<i>iso</i> -Propyl benzoate	218	—	1.015	1.491
<i>n</i> -Butyl benzoate	248	—	1.005	1.497
<i>iso</i> -Butyl benzoate	242	—	0.997	—
<i>n</i> -Amyl benzoate	137°/15	—	—	—
<i>iso</i> -Amyl benzoate	262	—	0.986	1.495
Methyl phenylacetate	215	—	1.068	1.507
Ethyl phenylacetate	228	—	1.033	1.497
<i>n</i> -Propyl phenylacetate	241	—	1.010	1.493
<i>n</i> -Butyl phenylacetate	256	—	0.994	1.489
Methyl <i>o</i> -toluate	213	—	1.068	—
Ethyl <i>o</i> -toluate	227	—	1.034	1.508
Methyl <i>m</i> -toluate	215	—	1.061	—
Ethyl <i>m</i> -toluate	227	—	1.028	1.506
Methyl <i>p</i> -toluate	217	34°	—	—
Ethyl <i>p</i> -toluate	228	—	1.025	1.507
Methyl salicylate	223	—	1.184	1.537
Ethyl salicylate	234	—	1.125	1.522
<i>n</i> -Propyl salicylate	240	—	1.098	1.516
<i>n</i> -Butyl salicylate	260	—	1.073	1.512
Methyl <i>m</i> -hydroxybenzoate	—	70	—	—
Ethyl <i>m</i> -hydroxybenzoate	295	73	—	—
Methyl <i>p</i> -hydroxybenzoate	—	131	—	—
Ethyl <i>p</i> -hydroxybenzoate	297	116	—	—
Methyl <i>o</i> -methoxybenzoate	248	—	1.156	1.534
Ethyl <i>o</i> -methoxybenzoate	261	—	1.104	1.525
Methyl <i>m</i> -methoxybenzoate	237	—	1.131	1.522
Ethyl <i>m</i> -methoxybenzoate	251	—	1.100	1.515
Methyl anisate	255	49	—	—
Ethyl anisate	269	7	1.103	1.524
Methyl <i>o</i> -chlorobenzoate	234	—	—	1.536
Ethyl <i>o</i> -chlorobenzoate	243	—	1.190	1.522
Methyl <i>m</i> -chlorobenzoate	231	20	—	1.492
Ethyl <i>m</i> -chlorobenzoate	242	—	1.182	1.520
Methyl <i>p</i> -chlorobenzoate	—	44	—	—
Ethyl <i>p</i> -chlorobenzoate	238	—	1.181	1.524
Methyl <i>o</i> -bromobenzoate	246	—	—	—
Ethyl <i>o</i> -bromobenzoate	255	—	—	—
Methyl <i>m</i> -bromobenzoate	—	32	—	—
Ethyl <i>m</i> -bromobenzoate	259	—	—	—
Methyl <i>p</i> -bromobenzoate	—	81	—	—
Ethyl <i>p</i> -bromobenzoate	263	—	—	—
Methyl <i>o</i> -iodobenzoate	278	—	—	—
Ethyl <i>o</i> -iodobenzoate	275	—	—	—
Methyl <i>m</i> -iodobenzoate	277	54	—	—

TABLE IV,183. AROMATIC ESTERS (*continued*)

	B.P.	M.P.	d_{4}^{20}	n_D^{20}
Ethyl <i>m</i> -iodobenzoate . . .	150°/15	—	—	—
Methyl <i>p</i> -iodobenzoate . . .	—	114°	—	—
Ethyl <i>p</i> -iodobenzoate . . .	153°/14	—	—	—
Methyl <i>o</i> -nitrobenzoate . . .	275	—	1.286	—
Ethyl <i>o</i> -nitrobenzoate . . .	—	30	—	—
Methyl <i>m</i> -nitrobenzoate . . .	279	79	—	—
Ethyl <i>m</i> -nitrobenzoate . . .	297	47	—	—
Methyl <i>p</i> -nitrobenzoate . . .	—	96	—	—
Ethyl <i>p</i> -nitrobenzoate . . .	—	57	—	—
Methyl 3 : 5-dinitrobenzoate . . .	—	108	—	—
Ethyl 3 : 5-dinitrobenzoate . . .	—	94	—	—
Methyl 2 : 4-dinitrobenzoate . . .	—	70	—	—
Ethyl 2 : 4-dinitrobenzoate . . .	—	41	—	—
Methyl anthranilate . . .	—	24	—	—
Ethyl anthranilate . . .	267	13	1.117	1.565
Methyl <i>m</i> -aminobenzoate . . .	—	38	—	—
Ethyl <i>m</i> -aminobenzoate . . .	294	—	—	—
Methyl <i>p</i> -aminobenzoate . . .	—	112	—	—
Ethyl <i>p</i> -aminobenzoate . . .	—	92	—	—
Methyl cinnamate . . .	261	36	—	—
Ethyl cinnamate . . .	273	—	1.049	1.560
<i>n</i> -Propyl cinnamate . . .	284	—	1.028	1.551
<i>n</i> -Butyl cinnamate . . .	162°/12	—	1.013	1.544
Methyl dihydrocinnamate . . .	232	—	1.043	1.503
Ethyl dihydrocinnamate . . .	248	—	1.016	1.495
<i>n</i> -Propyl dihydrocinnamate . . .	262	—	0.998	1.491
<i>n</i> -Butyl dihydrocinnamate . . .	123°/11	—	0.984	1.489
Methyl <i>o</i> -nitrocinnamate . . .	—	73	—	—
Ethyl <i>o</i> -nitrocinnamate . . .	—	44	—	—
Methyl <i>m</i> -nitrocinnamate . . .	—	124	—	—
Ethyl <i>m</i> -nitrocinnamate . . .	—	79	—	—
Methyl <i>p</i> -nitrocinnamate . . .	—	161	—	—
Ethyl <i>p</i> -nitrocinnamate . . .	—	142	—	—
Methyl <i>o</i> -aminocinnamate . . .	—	65	—	—
Ethyl <i>o</i> -aminocinnamate . . .	—	78	—	—
Methyl <i>m</i> -aminocinnamate . . .	—	84	—	—
Ethyl <i>m</i> -aminocinnamate . . .	—	64	—	—
Methyl <i>p</i> -aminocinnamate . . .	—	129	—	—
Ethyl <i>p</i> -aminocinnamate . . .	—	69	—	—
Methyl phenoxyacetate . . .	245	—	1.147	—
Ethyl phenoxyacetate . . .	251	—	1.101	—
Methyl <i>dl</i> -mandelate . . .	—	58	—	—
Ethyl <i>dl</i> -mandelate . . .	255	37	—	—
Methyl <i>o</i> -benzoylbenzoate . . .	352	52	—	—
Ethyl <i>o</i> -benzoylbenzoate . . .	—	58	—	—

TABLE IV, 183. AROMATIC ESTERS (*continued*)

	B.P.	M.P.	d_{4}^{20}	n_D^{20}
Methyl diphenylacetate . . .	—	60°	—	—
Ethyl diphenylacetate . . .	—	58	—	—
Methyl phthalate	282°	—	1.191	1.516
Ethyl phthalate	298	—	1.118	1.502
<i>n</i> -Propyl phthalate	130°/1	—	—	—
<i>iso</i> -Propyl phthalate	154°/10	—	—	—
<i>n</i> -Butyl phthalate	205°/20	—	—	—
Methyl <i>iso</i> -phthalate	—	68	—	—
Ethyl <i>iso</i> -phthalate	285	11	1.121	1.507
Methyl terephthalate	—	142	—	—
Ethyl terephthalate	302	44	—	—
Methyl 3-nitrophthalate	—	69	—	—
Ethyl 3-nitrophthalate	—	45	—	—
Methyl 4-nitrophthalate	—	66	—	—
Ethyl 4-nitrophthalate	—	34	—	—
Methyl α -naphthoate	—	—	—	—
Ethyl α -naphthoate	309	—	1.122	—
Methyl β -naphthoate	290	77	—	—
Ethyl β -naphthoate	304	32	—	—
Methyl diphenate	—	74	—	—
Ethyl diphenate	—	42	—	—
Methyl hexahydrobenzoate	183	—	0.990	1.451
Ethyl hexahydrobenzoate	196	—	0.962	1.448
Phenyl acetate	196	—	1.078	1.503
Phenyl propionate	211	20	1.050	—
Phenyl <i>n</i> -butyrate	228	—	1.023	—
Phenyl oxalate	190°/15	—	—	—
Phenyl succinate	330	121	—	—
Phenyl benzoate	299	68	—	—
Phenyl cinnamate	—	73	—	—
Phenyl salicylate (salol)	—	43	—	—
<i>o</i> -Cresyl acetate	208	—	1.045	—
<i>o</i> -Cresyl benzoate	307	—	—	—
<i>m</i> -Cresyl acetate	212	12	1.043	1.498
<i>m</i> -Cresyl benzoate	—	54	—	—
<i>p</i> -Cresyl acetate	212	—	1.050	1.500
<i>p</i> -Cresyl benzoate	316	72	—	—
α -Naphthyl acetate	—	49	—	—
α -Naphthyl benzoate	—	56	—	—
β -Naphthyl acetate	—	70	—	—
β -Naphthyl benzoate	—	107	—	—
Thymyl acetate	243	—	—	—
Thymyl benzoate	—	33	—	—
Catechol diacetate	—	63	—	—
Catechol dibenzoate	—	84	—	—
Resorcinol diacetate	278	—	—	—
Resorcinol dibenzoate	—	117	—	—
Hydroquinone diacetate	—	124	—	—
Hydroquinone dibenzoate	—	199	—	—

TABLE IV,183. AROMATIC ESTERS (*continued*)

	B.P.	M.P.	d_4^{20}	n_D^{20}
Phloroglucinol triacetate . . .	—	104°	—	—
Phloroglucinol tribenzoate . . .	—	185	—	—
Pyrogallol triacetate . . .	—	165	—	—
Pyrogallol tribenzoate . . .	—	90	—	—
Benzoin acetate	—	83	—	—
Guaiacol acetate	240°	—	1.133	1.512
Carvacryl acetate	245	—	0.994	—
Eugenol acetate	282	30	—	—
Phenyl carbonate	—	80	—	—
<i>o</i> -Cresyl carbonate	—	60	—	—
<i>m</i> -Cresyl carbonate	—	111	—	—
<i>p</i> -Cresyl carbonate	—	115	—	—
Guaiacol carbonate	—	87	—	—
Benzyl formate	203	—	1.082	—
Benzyl acetate	214	—	1.057	1.523
Benzyl benzoate	323	21	—	—
Benzyl succinate	—	45	—	—
Benzyl salicylate	186°/10	—	1.180	1.581
α -Phenylethyl acetate	222	—	—	—
β -Phenylethyl acetate	224	—	1.059	1.512

AROMATIC ACID CHLORIDES

The chlorides of aromatic acids are prepared :—

1. By the action of phosphorus pentachloride upon the aromatic acid, for example :

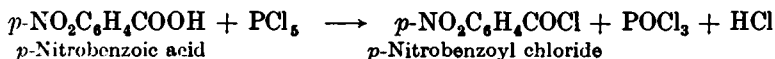

The liquid phosphorus oxychloride, b.p. 107°, is a by-product and is removed by fractional distillation under normal pressure. Unless the b.p. of the acid chloride differs very considerably (say, $\leq 100^\circ$) from that of the phosphorus oxychloride, the acyl halide is liable to contain traces of the latter. In such circumstances it is preferable to use thionyl chloride for the preparation of the acid chloride.

2. By the action of thionyl chloride upon the acid (see discussion preceding Section III,86), for example :

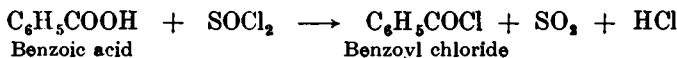

It will be noted that the by-products are both gaseous. In practice, a slight excess over the theoretical quantity (20–75 per cent.) of thionyl chloride is used ; some of this is volatilised with the gaseous by-products and the remainder is easily removed by fractional distillation (thionyl chloride has b.p. 77°).

The preparation of 3 : 5-dinitrobenzoyl chloride by both the PCl_5 and SOCl_2 methods is described in Section III,27,1 ; see also Section VII,22.

IV,184.

***p*-NITROBENZOYL CHLORIDE**

Phosphorus pentachloride method. Mix 100 g. of pure *p*-nitrobenzoic acid (Section IV,154) and 126 g. of pure phosphorus pentachloride in a 500 ml. round-bottomed flask. Fit the flask with a calcium chloride (or cotton wool) guard tube and connect the latter to a gas absorption device (*e.g.*, Fig. II, 8, 1, c). Heat the flask on a water bath, with occasional shaking, until the reaction commences and then for a further 30 minutes or until the vigorous evolution of hydrogen chloride has almost ceased : a pale yellow homogeneous liquid is formed. Transfer the reaction mixture to a Claisen flask connected with a water-cooled condenser, and remove the phosphorus oxychloride (b.p. 107°) at ordinary pressure either by heating in an oil bath gradually to 200–220° or by heating in an air bath (Fig. II, 5, 3) until the boiling point is about 150°. Allow to cool, replace the water condenser by a *short* air-cooled condenser and use a distilling flask as receiver (compare Fig. II, 19, 1) ; place a bottle containing water between the receiver and the manometer (or the absorption arrangement shown in Fig. II, 22, 1) in order to avoid the passage of vapours of phosphorus oxychloride or acid chloride into the pump. Distil the residual liquid under reduced pressure (1) : a small quantity of phosphorus oxychloride passes over first and the temperature rises rapidly to about 150°/20 mm. Change the receiver and collect the *p*-nitrobenzoyl chloride at 155°/20 mm. Pour the product whilst still fluid into a small wide-mouthed bottle and allow it to solidify : this prevents any moisture in the air from decomposing more than the surface

layer of acid chloride. The yield of *p*-nitrobenzoyl chloride (a yellow crystalline solid, m.p. 71°) is 105 g. and is pure enough for most purposes. A perfectly pure product, m.p. 73°, is obtained by recrystallising from carbon tetrachloride.

Note.

(1) Either an oil bath (maintained at 210–215° for a pressure of 20 mm.) or an air bath must be used. If the flask is heated with a free flame, superheating will occur leading to decomposition (sometimes violent) of the *p*-nitrobenzoyl chloride.

Thionyl chloride method. Mix 100 g. of pure *p*-nitrobenzoic acid and 125 g. (77 ml.) (1) of redistilled thionyl chloride in a 500 ml. round-bottomed flask. Fit the flask with a double surface reflux condenser carrying a calcium chloride (or cotton wool) guard tube and connect the latter to an absorption device (e.g., Fig. II, 8, 1, c). Heat the flask on a water bath with occasional shaking for 1 hour or until the evolution of hydrogen chloride and sulphur dioxide almost ceases. Allow the reaction mixture to cool, transfer it cautiously to a Claisen flask connected with a water-cooled condenser and a receiver (compare Fig. II, 13, 1). Distil off the excess of thionyl chloride (b.p. 77°) slowly and continue the distillation until the temperature rises rapidly to about 120°; this will ensure that all the thionyl chloride is removed. Allow to cool, and distil the residual *p*-nitrobenzoyl chloride under diminished pressure as detailed in the *Phosphorus Pentachloride Method*. The resulting *p*-nitrobenzoyl chloride (a yellow crystalline solid) weighs 107 g. and melts at 72–73°.

Note.

(1) A large excess of thionyl chloride is recommended in order to avoid the formation of *p*-nitrobenzoic anhydride (see *Note 1* to Section IV, 185).

CAUTION. The preparation of *o*-nitrobenzoyl chloride, *o*-nitrophenacetyl chloride and all *o*-nitroacid chlorides should not be attempted by the above methods: a violent explosion may occur upon distilling the product or when the last traces of thionyl chloride are removed "in vacuo" at 100°. Perhaps the safest method is to treat the pure acid in benzene solution with 1.1 mols of thionyl chloride and to reflux until evolution of sulphur dioxide and hydrogen chloride has ceased; the solution of the acid chloride in benzene may then be employed for most reactions.

IV, 185.

BENZOYL CHLORIDE

This preparation must be conducted in the fume cupboard. Fit up the apparatus shown in Fig. III, 23, 1, but replace the absorption device at the top of the condenser by a calcium chloride (or cotton wool) guard tube; if it is desired to absorb the gases evolved, the guard tube may be attached to the device depicted in Fig. II, 8, 1. Place 30 g. of dry powdered benzoic acid in the 150 ml. distilling (or Claisen) flask and add 36 g. (22 ml.) of redistilled thionyl chloride. Heat the flask on a boiling water bath with occasional shaking for 1 hour or until the evolution of hydrogen chloride ceases. Cool the flask, detach the condenser and fit it to the side arm for distillation: attach to the lower end of the condenser by means of a cork either a filter flask receiver (as in Fig. II, 13, 1) or a small distilling flask carrying a calcium chloride (or cotton wool)

guard tube in the side arm. Have a duplicate receiver available. Distil the contents of the flask by heating carefully over a wire gauze or, better, in an air bath (Fig. II, 5, 3). A small initial fraction boiling at 70–80°, consisting of unchanged thionyl chloride, passes over first, and the temperature then rises rapidly to 194°. Immediately this temperature is reached, stop the distillation, allow the condenser to drain thoroughly and remove the receiver containing the initial distillate; introduce the duplicate receiver and continue the distillation. Collect the benzoyl chloride at 194–198° (1). The yield is 32 g. Benzoyl chloride is a colourless, highly refractive liquid with a pungent odour; it fumes in the air and its vapour causes copious watering of the eyes.

Note.

(1) If desired, the benzoyl chloride may be distilled under reduced pressure (Fig. II, 20, 1); the approximate b.p. may be obtained from Table II, 19.

A very small high-boiling fraction may remain in the flask: this consists largely of benzoic anhydride (b.p. 360°; m.p. 42°) produced by the dehydrating action of the thionyl chloride upon the benzoic acid:



AROMATIC ACID ANHYDRIDES

The anhydrides of aromatic acids are prepared :—

1. By interaction of the acid chloride (1 mol) and acid (1 mol) in the presence of pyridine (2 mols) :

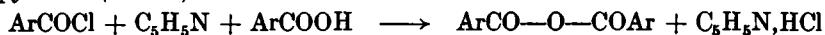

Thus benzoic anhydride and *o*-chlorobenzoic anhydride (m.p. 79°) can be readily prepared by this method (compare *n*-Heptoic anhydride, Section III, 91). It is sometimes convenient to use pyridine as the reaction medium.

In a modification the acid chloride is treated with excess of dry pyridine whereby the addition complex $\text{ArCOCl} \cdot \text{C}_5\text{H}_5\text{N}$ is formed ; decomposition of the latter with water affords the acid anhydride :

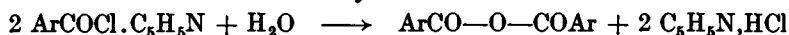

This modification is illustrated by the preparation of *p*-chlorobenzoic anhydride from *p*-chlorobenzoyl chloride.

2. By the slow distillation of an aromatic carboxylic acid and acetic anhydride in the presence of a little phosphoric acid :

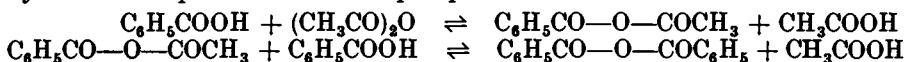

The equilibria are established comparatively slowly, hence slow distillation is essential.

IV, 186. *p*-CHLOROBENZOIC ANHYDRIDE

Place a mixture of 17.5 g. *p*-chlorobenzoyl chloride (1) and 50 ml. of dry pyridine (Section II, 47, 22) in a loosely-stoppered 250 ml. flask and warm on a steam bath for 5 minutes. Pour the reaction mixture upon 100 g. of crushed ice and 50 ml. of concentrated hydrochloric acid. The anhydride separates out at once. When the ice has melted sufficiently, filter the mixture by suction. Wash the solid with 15 ml. of methanol and then with 15 ml. of dry benzene. The yield of crude *p*-chlorobenzoic anhydride is 14.5 g. Recrystallise from 250 ml. of dry benzene : 13 g. of the pure anhydride, m.p. 192–193°, are obtained.

(1) Prepare *p*-chlorobenzoyl chloride by refluxing and stirring 78 g. of *p*-chlorobenzoic acid (Section IV, 157) and 100 g. of redistilled thionyl chloride until solution is complete. Distil off the excess of thionyl chloride at atmospheric pressure and then the acid chloride under reduced pressure : 70 g. of product, b.p. 119–120°/22 mm., m.p. 14–15°. are obtained.

COGNATE PREPARATION

Benzoic anhydride (*carboxylic acid - acetic anhydride method*).

Place 150 g. of benzoic acid, 150 g. (139 ml.) of acetic anhydride and 0.2 ml. of syrupy phosphoric acid in a 500 ml. bolt-head flask. Fit the latter with a two-holed stopper carrying a dropping funnel and an efficient fractionating column (compare Fig. III, 61, 1) ; it is advisable to lag the latter with asbestos cloth. Set up the flask in an oil bath or in a fusible metal bath. Distil the mixture very slowly and at such a rate that the temperature of the vapour at the head of the column does

not exceed 120° (the boiling point of acetic acid is 118°). When about 25 ml. of distillate has been collected, add 25 g. (23 ml.) of acetic anhydride from the dropping funnel and continue the distillation until a further 25 ml. of liquid has been obtained. Introduce another 25 g. of acetic anhydride and continue the slow fractional distillation with the object of removing all the acetic acid and acetic anhydride (b.p. 140°); finally continue the heating until the temperature of the bath is $250\text{--}270^{\circ}$. Fractionally distil the residue under reduced pressure (compare Fig. II, 20, 1) and collect the crude benzoic anhydride (120 g.) at $210\text{--}220^{\circ}/20$ mm. Dissolve this in benzene (5 ml. per 10 g.) and add just sufficient light petroleum (b.p. $40\text{--}60^{\circ}$) to cause a cloudiness; cool in ice, when pure benzoic anhydride, m.p. 43° , separates in colourless and odourless crystals. The first crop amounts to about one-half of the crude material taken. Remove the solvent from the mother liquor on a water bath and distil the residue; collect the fraction boiling at $210\text{--}220^{\circ}/20$ mm. and recrystallise as before. The total yield of pure benzoic anhydride is 95 g.

IV,187. REACTIONS AND CHARACTERISATION OF ACID CHLORIDES OF AROMATIC ACIDS

Most aromatic acid chlorides impart a strongly acid reaction when shaken with water (compare Section III,88). All are completely hydrolysed by boiling with solutions of caustic alkalis and yield no product volatile from the alkaline solution (compare *Esters*, Sections III,106 and IV,183). They may be distinguished from acids by their facile reactions with alcohols (compare Section III,27), phenols (compare Section IV,114), and amines (compare Sections III,123 and IV,100).

Acyl halides may be identified by:—hydrolysis to the corresponding acids (the latter may be further characterised as in Section IV,175); conversion into amides (Section IV,191), anilides or *p*-toluidides (Section IV,100); and conversion into solid esters (Section IV,183).

The physical properties of a few typical acid chlorides of aromatic acids are collected in Table IV,187). Some acid anhydrides are also included in this Table (compare Section III,94).

**TABLE IV,187. ACID CHLORIDES AND ACID ANHYDRIDES
OF AROMATIC ACIDS**

Acid Chloride	B.P.	M.P.
Benzoyl	197°	—
<i>o</i> -Toluyll	212	—
<i>m</i> -Toluyll	219	—
<i>p</i> -Toluyll	227	—
<i>o</i> -Nitrobenzoyl	148°/9 mm.	20°
<i>m</i> -Nitrobenzoyl	—	35
<i>p</i> -Nitrobenzoyl	—	75
3 : 5-Dinitrobenzoyl	196°/11 mm.	70
2 : 4-Dinitrobenzoyl	—	46
<i>o</i> -Chlorobenzoyl	236	—
<i>m</i> -Chlorobenzoyl	225	—
<i>p</i> -Chlorobenzoyl	222	16
<i>o</i> -Methoxybenzoyl	254	—
<i>m</i> -Methoxybenzoyl	244	—
Anisoyl	145°/14 mm.	22
Phenylacetyl	210	—
Cinnamoyl	131°/11 mm.	36
Diphenylcarbonyl	—	85
<i>s</i> -Phthaloyl	281	14
3-Nitrophthaloyl	—	77
α -Naphthoyl	163°/10	26
β -Naphthoyl	305	53
Anhydride	B.P.	M.P.
Benzoic	360°	42°
<i>o</i> -Toluic	—	39
<i>m</i> -Toluic	—	71
<i>p</i> -Toluic	—	95
<i>o</i> -Nitrobenzoic	—	135
<i>m</i> -Nitrobenzoic	—	163
<i>p</i> -Nitrobenzoic	—	190
3 : 5-Dinitrobenzoic	—	109
2 : 4-Dinitrobenzoic	—	160
<i>o</i> -Chlorobenzoic	—	79
<i>m</i> -Chlorobenzoic	—	95
<i>p</i> -Chlorobenzoic	—	194
Anisic	—	99
Phenylacetic	—	72
Cinnamic	—	136
Phthalic	—	132
3-Nitrophthalic	—	164
4-Nitrophthalic	—	119
Tetrachlorophthalic	—	255
Tetrabromophthalic	—	280
1 : 8-Naphthalic	—	274
Diphenic	—	217
<i>d</i> -Camphoric	270	220

AROMATIC ACID AMIDES

Aromatic acid amides may be prepared :—

1. By the action of concentrated ammonia solution upon the appropriate acid chloride, for example :



2. By the action of an alkaline solution of hydrogen peroxide upon the corresponding nitrile, for example :

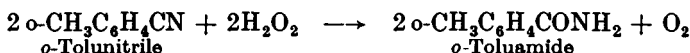

Acid amides possess weakly amphoteric properties ; salts such as



are formed at low temperatures (to avoid hydrolysis), but are difficult to isolate. The mercury derivatives can, however, usually be readily prepared because they crystallise well and mercuric oxide is too weakly basic to cause hydrolysis of the amide, for example :

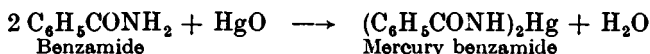

3. By the action of concentrated hydrochloric acid at about 40° upon arylacetonitriles ; hydrolysis is arrested at the arylacetamide stage (see Section IV,160 for the preparation of phenylacetamide by this method) :

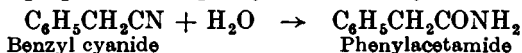

IV,188.

BENZAMIDE

Place 50 ml. of concentrated ammonia solution (sp. gr. 0·88) in a 200 ml. conical flask (1) and cool in ice. Add 12·1 g. (10·0 ml.) of redistilled benzoyl chloride (Section IV,185) drop by drop from a separatory funnel whilst shaking the flask frequently. Filter off the precipitated benzamide, wash with a little cold water, and recrystallise from hot water (about 50 ml.) ; dry upon filter paper in the air (2). The yield of pure benzamide, m.p. 129°, is 9 g.

Notes.

(1) An alternative procedure, which does not require ice cooling, is to add all the 10 ml. of benzoyl chloride rapidly to a mixture of 50 ml. of concentrated ammonia solution and 50 ml. of water contained in a 200 ml. conical flask, stopper securely and shake vigorously for about 15 minutes. Heat is evolved so that the stopper should be held down tightly. After 30 minutes the benzamide is filtered off and worked up as above.

(2) The benzamide should not be dried in the steam oven, since it will undergo partial decomposition at 100° into benzonitrile and thus give an impure product of low m.p.

IV,189.

MERCURY BENZAMIDE

To 100 ml. of rectified spirit in a 250 ml. round-bottomed flask add 8 g. of benzamide and 10 g. of finely-powdered mercuric oxide. Boil under reflux for 30 minutes and filter the hot solution through a fluted filter paper to remove unreacted mercuric oxide. If the first portion of

the filtrate is somewhat turbid, return it to the filter ; the remainder will pass through as a clear filtrate. Cool the latter in ice ; colourless crystals of mercury benzamide separate. Filter at the pump, wash with a little cold alcohol, drain and dry in the air. The yield of mercury benzamide, m.p. 222–223°, is 3.5 g. It may be recrystallised from hot rectified spirit.

IV,190.

o-TOLUAMIDE

Place 44 g. of *o*-tolunitrile (Section IV,66), 150 ml. of "100-volume" (30 per cent.) hydrogen peroxide (1), 200 ml. of rectified spirit (2) and 15 ml. of 25 per cent. sodium hydroxide solution in a 1 litre round-bottomed flask. Oxygen is soon evolved and the mixture becomes warm. Maintain the temperature inside the flask at 40–50° by external cooling ; if the temperature is permitted to rise much above 50°, the evolution of oxygen may become so rapid as to cause the mixture to foam out of the flask. The exothermic reaction is complete after about 1 hour. Maintain the temperature of the mixture at 50° by external heating for a further 3 hours. While still warm, add 5 per cent. sulphuric acid until exactly neutral to litmus and distil in steam (Fig. II, 40, 1) until 500 ml. of distillate are collected : heat the flask with a small flame after most of the alcohol has passed over. Pour the residue, which should have a volume of about 300 ml., into a 600 ml. beaker, and cool to about 20°. Filter off the crystals at the pump, transfer them to a glass mortar, and grind to a paste with 50 ml. of cold water, filter with suction and wash on the filter with a further 50 ml. of cold water. Dry in the air upon filter paper. The yield of *o*-toluamide (white crystals), m.p. 141°, is 46 g. It may be recrystallised from hot water (1 g. per 10 ml.), but the m.p. is unchanged.

Notes.

(1) Difficultly hydrolysable nitriles, such as *o*-tolunitrile, require 30 per cent hydrogen peroxide. For most nitriles, however, both aromatic and aliphatic, an equivalent amount of 6–12 per cent. hydrogen peroxide gives more satisfactory results ; the above procedure must, however, be modified, according to the solubility of the nitriles and amides.

(2) This volume of rectified spirit is required to produce a homogeneous solution.

IV,191. REACTIONS AND CHARACTERISATION
OF PRIMARY AROMATIC AMIDES

Primary aromatic amides are crystalline solids with definite melting points. Upon boiling with 10–20 per cent. sodium or potassium hydroxide solution, they are hydrolysed with the evolution of ammonia (vapour turns red litmus paper blue and mercurous nitrate paper black) and the formation of the alkali metal salt of the acid :

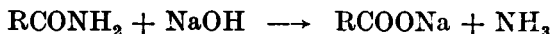

The acid is liberated upon acidification. Hydrolysis may also be effected (but less readily and usually not quite so satisfactorily) by boiling with dilute hydrochloric acid (1 : 1) or 20 per cent. sulphuric acid :

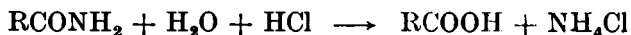

The hydrolysis by alkali is illustrated by the following experimental details for benzamide. Place 3 g. of benzamide and 50 ml. of 10 per cent. sodium hydroxide solution in a 150 ml. conical or round-bottomed flask equipped with a reflux condenser. Boil the mixture gently for 30 minutes; ammonia is freely evolved. Detach the condenser and continue the boiling in the open flask for 3-4 minutes to expel the residual ammonia. Cool the solution in ice, and add concentrated hydrochloric acid until the mixture is strongly acidic; benzoic acid separates immediately. Leave the mixture in ice until cold, filter at the pump, wash with a little cold water and drain well. Recrystallise the benzoic acid from hot water. Determine the m.p., and confirm its identity by a mixed m.p. test.

The characterisation of a primary aromatic amide is based upon its own m.p. and the identification of the acid (see Section IV,175) produced on hydrolysis. A crystalline derivative may be prepared directly with xanthhydrol (for experimental details, see Section III,110, 1).

The melting points of a few selected primary aromatic amides (together with those of the xanthylamides, where known) are collected in Table IV,191. A more detailed list will be found in the column headed *Amides* in Table IV,175 (*Aromatic Carboxylic Acids*).

TABLE IV,191. PRIMARY AROMATIC AMIDES

Amide	M.P.	Xanthylamide
Benzamide	129°	224°
<i>o</i> -Nitrobenzamide	175	—
<i>m</i> -Nitrobenzamide	142	—
<i>p</i> -Nitrobenzamide	201	232
<i>o</i> -Toluamide	143	200
<i>m</i> -Toluamide	95	—
<i>p</i> -Toluamide	159	225
Phenylacetamide	157	196
Salicylamide	139	—
<i>m</i> -Hydroxybenzamide	167	—
<i>p</i> -Hydroxybenzamide	162	—
Phenylurea	147	225
<i>o</i> -Tolylurea	191	228
<i>m</i> -Tolylurea	142	—
<i>p</i> -Tolylurea	183	—
<i>asym.</i> -Diphenylurea	189	180
α -Phenylpropionamide	92	158
β -Phenylpropionamide	105	189
Benzylurea	149	—
<i>p</i> -Phenetylurea (Dulcin)	173	—
Phthalimide	235	177
Hydrobenzamide	110	—

IV,192. REACTIONS AND CHARACTERISATION OF SUBSTITUTED AROMATIC AMIDES (AROMATIC ACYLATED BASES)

This group comprises substances of the type RCONHR' and RCONR'R", i.e., substituted amides of the aromatic series. They are all well-defined crystalline solids, sparingly soluble in cold but, often, appreciably soluble in hot water and moderately soluble in ether; they are generally neutral or feebly basic in reaction.

Upon warming with 10-20 per cent. sodium or potassium hydroxide solution, no ammonia is evolved (distinction from primary amides). The base, however, is usually liberated upon fusion with soda lime (see experimental details in Section IV,175) and at the same time the acyl group yields a hydrocarbon. Thus benz-*p*-toluidide affords *p*-toluidine and benzene.

Carry out a preliminary soda lime fusion test to determine whether the base is liberated under these conditions; if it is, repeat the experiment with 1 g. of the substance. Identify the base (amine) by its m.p. (if a solid) and the preparation of a solid derivative (Section IV,100).

Hydrolysis of the original compound will confirm its identity. Boil 0.5-1.0 g. of the original substance with 10-20 ml. of concentrated hydrochloric acid under reflux for 2 hours:

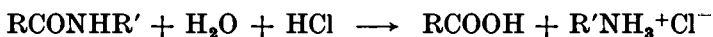

The solution will then contain the free acid and the hydrochloride of the base; either of these may separate if sparingly soluble. If a solid crystallises from the cold solution, filter, test with sodium bicarbonate solution {compare Section III,85, (i)} and compare the m.p. with that of the original compound. If it is a hydrolysis product, examine it separately. Otherwise, render the filtrate alkaline with sodium hydroxide solution and extract the base with ether; if the presence of the unchanged acyl compound is suspected, extract the base with weak acid. Identify the base in the usual manner (see Section IV,100). The acid will be present as the sodium salt in the alkaline extract and may be identified as described in Section IV,175.

Benzanilide and similar compounds are very slowly hydrolysed by concentrated hydrochloric acid; hydrolysis is quite rapid with 60-70 per cent. sulphuric acid (for experimental details, see Section IV,52). In the preliminary experiment boil 0.5-1.0 g. of the compound with 10-20 ml. of dilute sulphuric acid (1:1 by volume) under reflux for 20-30 minutes. Dilute with 10 ml. of water and filter off any acid which may be precipitated; if the carboxylic acid is liquid and volatile, distil it directly from the reaction mixture. Render the residue alkaline and isolate the base as above.

The melting points of some typical substituted aromatic amides are collected in Table IV,192. Other examples will be found in the appropriate columns of Tables IV,100A and B (*Primary and Secondary Aromatic Amines*) and of Table IV,175 (*Aromatic Carboxylic Acids*).

TABLE IV,192. SUBSTITUTED AROMATIC AMIDES

Amide	M.P.	Amide	M.P.
Formanilide	50°	<i>m</i> -Methoxyacetanilide	80°
Acetanilide	114	<i>p</i> -Methoxyacetanilide	130
Propionanilide	106	2 : 4-Dimethylacetanilide	133
<i>n</i> -Butyranilide	96	2 - 5-Dimethylacetanilide	142
<i>iso</i> -Butyranilide	105	<i>N</i> -Ethyl- <i>p</i> -nitroacetanilide	118
<i>n</i> -Valerianilide	63		
<i>iso</i> -Valerianilide	110	Acetyl- <i>o</i> -toluidine	112
<i>n</i> -Caproanilide	95	Acetyl- <i>m</i> -toluidine	66
Oenanthoanilide	71	Acetyl- <i>p</i> -toluidine	154
Caprylanilide	57		
Pelargoanilide	57	Acetyl- <i>o</i> -anisidine	88
Caprianiilide	70	Acetyl- <i>m</i> -anisidine	80
Lauranilide	78	Acetyl- <i>p</i> -anisidine	130
Palmitanilide	91	Acetyl- <i>o</i> -phenetidine	79
Stearanilide	94	Acetyl- <i>m</i> -phenetidine	96
Lactanilide	59	Acetyl- <i>p</i> -phenetidine (or phenacetin)	137
Furoanilide	124	Acetyl- α -naphthylamine	160
Acetoacetanilide	85	Acetyl- β -naphthylamine	134
Oxanilide	246		
Malonanilide	225	<i>NN'</i> -Diacetyl- <i>o</i> -phenylenediamine	186
Succinanilide	230	<i>NN'</i> -Diacetyl- <i>m</i> -phenylenediamine	191
Adipanilide	239	<i>NN'</i> -Diacetyl- <i>p</i> -phenylenediamine	304
Sebacanilide	202		
		Benzoyl- <i>o</i> -toluidine	144
Cinnamanilide	153	Benzoyl- <i>m</i> -toluidine	125
Benzanilide	162	Benzoyl- <i>p</i> -toluidine	158
<i>o</i> -Nitrobenzanilide	155	Benzoyl- <i>o</i> -anisidine	60
<i>m</i> -Nitrobenzanilide	154	Benzoyl- <i>m</i> -anisidine	—
<i>p</i> -Nitrobenzanilide	211	Benzoyl- <i>p</i> -anisidine	154
<i>o</i> -Toluanilide	125	Benzoyl- <i>o</i> -phenetidine	104
<i>m</i> -Toluanilide	126	Benzoyl- <i>m</i> -phenetidine	103
<i>p</i> -Toluanilide	148	Benzoyl- <i>p</i> -phenetidine	173
Anisanilide	169	Benzoyl- α -naphthylamine	161
		Benzoyl- β -naphthylamine	162
α -Naphthanilide	163		
β -Naphthanilide	171	<i>NN'</i> -Dibenzoyl- <i>o</i> -phenylenediamine	301
		<i>NN'</i> -Dibenzoyl- <i>m</i> -phenylenediamine	240
Acetanilide	114	<i>NN'</i> -Dibenzoyl- <i>p</i> -phenylenediamine	>300
<i>N</i> -Methylacetanilide	103		
<i>N</i> -Ethylacetanilide	54	Acetyl- <i>N</i> -methyl- <i>o</i> -toluidine	56
<i>N-n</i> -Propylacetanilide	50	Acetyl- <i>N</i> -methyl- <i>m</i> -toluidine	66
<i>o</i> -Chloroacetanilide	88	Acetyl- <i>N</i> -methyl- <i>p</i> -toluidine	83
<i>m</i> -Chloroacetanilide	79	Acetyl- <i>N</i> -methyl- α -naphthylamine	94
<i>p</i> -Chloroacetanilide	179	Acetyl- <i>N</i> -methyl- β -naphthylamine	51
<i>o</i> -Bromoacetanilide	99		
<i>m</i> -Bromoacetanilide	88	<i>N</i> -Formyldiphenylamine	74
<i>p</i> -Bromoacetanilide	167	<i>N</i> -Acetyldiphenylamine	101
<i>o</i> -Iodoacetanilide	110		
<i>m</i> -Iodoacetanilide	119	Saccharin	220
<i>p</i> -Iodoacetanilide	184	Phthalimide	235
<i>o</i> -Aminoacetanilide	132	Carbanilide	238
<i>m</i> -Aminoacetanilide	88	Diphenylguanidine	147
<i>p</i> -Aminoacetanilide	163	Benzoylpiperidine	48
<i>o</i> -Nitroacetanilide	94		
<i>m</i> -Nitroacetanilide	155	<i>N</i> -Phenylurethane	
<i>p</i> -Nitroacetanilide	216	(or Ethyl <i>N</i> -phenylcarbamate)	53
<i>o</i> -Hydroxyacetanilide	209	Ethyl oxanilate	67
<i>m</i> -Hydroxyacetanilide	149		
<i>p</i> -Hydroxyacetanilide	168	Ethyl oxamate	114
<i>o</i> -Methoxyacetanilide	88		

AROMATIC NITRILES

Aromatic nitriles may be prepared :—

1. From amines by the diazo reaction (see discussion preceding Section IV,59 : *p*-tolunitrile and benzonitrile from *p*-toluidine and aniline respectively, Section IV,66).

2. By dehydration of aromatic amides with phosphorus pentoxide, for example :

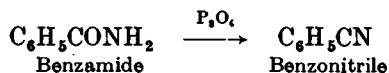

3. By heating halogenated benzenes or naphthalenes with cuprous cyanide, for example, α -naphthonitrile from α -bromonaphthalene and cuprous cyanide (Section IV,163).

4. From aldehydes by conversion into the oximes, followed by removal of the elements of water by the action of acetic anhydride, for example :

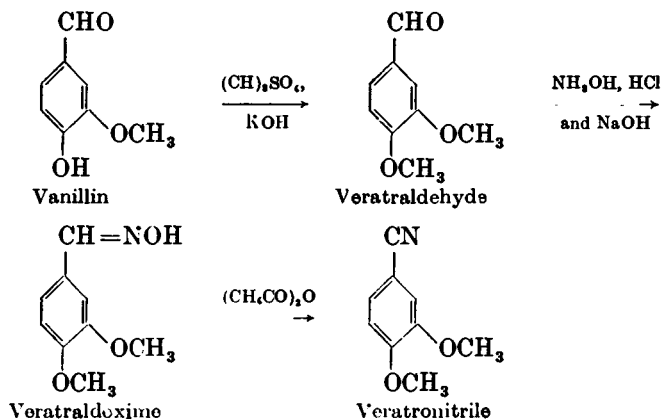

The readily-available vanillin is employed in the starting material in this preparation.

IV,193.

BENZONITRILE

Place 45 g. of benzamide (Section IV,188) and 80 g. of phosphorus pentoxide in a 250 ml. Claisen flask (for exact experimental details on the handling and weighing out of phosphoric oxide, see under *Acetamide*, Section III,111). Mix well. Arrange for distillation (Fig. II, 19, 1 or Fig. II, 20, 1) under reduced pressure ; use a water pump with an air leak in the system so that a pressure of about 100 mm. is attained. Heat the flask with a free flame until no more liquid distills : the nitrile will pass over at 126–130°/100 mm. Wash the distillate with a little sodium carbonate solution, then with water, and dry over anhydrous calcium chloride or magnesium sulphate. Distil under normal pressure (Fig. II, 13, 2 or II, 13, 6) from a 50 ml. flask : the benzonitrile passes over as a colourless liquid at 188–189° (compare Section IV,66). The yield is 28 g.

IV,194.

VERATRONITRILE

Veratraldehyde (methyl vanillin). Place 152 g. of a good sample of commercial vanillin, m.p. 81–82°, in a 1 litre three-necked flask (or Pyrex wide-mouthed bottle), equipped with a reflux condenser, a mechanical stirrer, and two separatory funnels (one of these may be supported in the top of the reflux condenser by means of a grooved cork). Melt the vanillin by warming on a water bath and stir vigorously. Charge one funnel with a solution of 82 g. of pure potassium hydroxide in 120 ml. of water and the other funnel with 160 g. (120 ml.) of purified dimethyl sulphate (1) (*CAUTION*: conduct all operations with dimethyl sulphate in the fume cupboard). Run in the potassium hydroxide solution at the rate of two drops a second, and 20 seconds after this has started add the dimethyl sulphate at the same rate. Stop the external heating after a few minutes; the mixture continues to reflux gently from the heat of the reaction. The reaction mixture should be pale reddish-brown since this colour indicates that it is alkaline; should the colour change to green, an acid reaction is indicated and this condition should be corrected by slightly increasing the rate of addition of the alkali. When half to three-quarters of the reagents have been added, the reaction mixture becomes turbid and separates into two layers. As soon as all the reagents have been run in (about 20 minutes), pour the yellow reaction mixture into a large porcelain basin and allow to cool without disturbance, preferably overnight. Filter the hard crystalline mass of veratraldehyde, grind it in a glass mortar with 300 ml. of ice-cold water, filter at the pump and dry in a vacuum desiccator. The yield of veratraldehyde, m.p. 43–44°, is 160 g. This product is sufficiently pure for most purposes; it can be purified without appreciable loss by distillation under reduced pressure, b.p. 158°/8 mm.; m.p. 46°. The aldehyde is easily oxidised in the air and should therefore be kept in a tightly stoppered bottle.

Note.

(1) Dimethyl sulphate may be purified (*a*) by allowing it to stand over anhydrous potassium carbonate until it is neutral to Congo red paper, or (*b*) by washing, just before use, with an equal volume of ice water, followed by one-third of its volume of cold, saturated sodium bicarbonate solution.

Veratronitrile. Dissolve 83 g. of veratraldehyde in 200 ml. of warm rectified spirit in a 1 litre bolt-head flask, and add a warm solution of 42 g. of hydroxylamine hydrochloride in 50 ml. of water. Mix thoroughly and run in a solution of 30 g. of sodium hydroxide in 40 ml. of water. Allow the mixture to stand for 2·5 hours, add 250 g. of crushed ice, and saturate the solution with carbon dioxide. The aldoxime separates as an oil: allow the mixture to stand for 12–24 hours in an ice chest or refrigerator when the oil will solidify. Filter off the crystalline aldoxime at the pump, wash well with cold water, and dry in the air upon filter paper. The yield of veratraldoxime is 88 g.

Into a 250 ml. Pyrex round-bottomed flask, provided with a ground-in glass air condenser, place 88 g. of veratraldoxime and 100 g. (92·5 ml.) of redistilled acetic anhydride. Heat cautiously. Immediately the vigorous reaction commences, remove the flame. When the reaction

subsides, boil the solution gently for 20 minutes, and then pour it carefully with stirring into 300 ml. of cold water. Continue the stirring and cool in ice. Filter off the almost colourless crystals of veratronitrile and dry in the air. The resulting nitrile (60 g.) is quite pure and melts at 67°.

IV,195. REACTIONS AND CHARACTERISATION OF AROMATIC NITRILES

Aromatic nitriles are generally liquids or low melting point solids, and usually have characteristic odours. They give no ammonia with aqueous sodium hydroxide solution in the cold, are hydrolysed by boiling aqueous alkali but more slowly than primary amides :

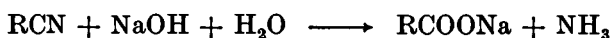

When distilled with soda lime (Section IV,175), nitriles yield some ammonia, but pass over, in part, unchanged. They are identified by the b.p. and by hydrolysis to, and characterisation of, the corresponding acid.

Hydrolysis may be effected with 10–20 per cent. sodium hydroxide solution (see *p-Tolunitrile* and *Benzonitrile* in Section IV,66) or with 10 per cent. methyl alcoholic sodium hydroxide. For difficult cases, e.g., *α-Naphthonitrile* (Section IV,163), a mixture of 50 per cent. sulphuric acid and glacial acetic acid may be used. In alkaline hydrolysis the boiling is continued until no more ammonia is evolved. In acid hydrolysis 2–3 hours boiling is usually sufficient : the reaction product is poured into water, and the organic acid is separated from any unchanged nitrile or from amide by means of sodium carbonate solution. The resulting acid is identified as detailed in Section IV,175.

Nitriles may often be hydrolysed (hydrated) to the amides ($\text{RCN} \longrightarrow \text{RCONH}_2$) by concentrated sulphuric acid or by concentrated hydrochloric acid, usually in the cold or at 40° (see Sections III,115 and IV,160). The resulting amide is, of course, a useful derivative.

The physical properties of some typical aromatic nitriles are collected in Table IV,195.

TABLE IV,195. AROMATIC NITRILES

Nitrile	B.P.	M.P.
Benzonitrile	191°	—
<i>o</i> -Tolunitrile	205	—
<i>m</i> -Tolunitrile	212	—
<i>p</i> -Tolunitrile	218	29°
<i>o</i> -Chlorobenzonitrile	232	43
<i>m</i> -Chlorobenzonitrile	—	41
<i>p</i> -Chlorobenzonitrile	223	96
<i>o</i> -Bromobenzonitrile	252	53
<i>m</i> -Bromobenzonitrile	225	38
<i>p</i> -Bromobenzonitrile	236	113
<i>o</i> -Iodobenzonitrile	—	55
<i>o</i> -Nitrobenzonitrile	—	111
<i>m</i> -Nitrobenzonitrile	—	118
<i>p</i> -Nitrobenzonitrile	—	149
Phenylacetoneitrile	234	—
<i>p</i> -Nitrophenylacetoneitrile	—	116
α -Phenylpropionitrile	232	—
β -Phenylpropionitrile	261	—
<i>dl</i> -Mandelonitrile	170d	—
α -Naphthonitrile	299	36
β -Naphthonitrile	306	66
Cinnamonitrile	255	20
Phthalonitrile	—	141

SOME AROMATIC PEROXIDES AND PER-ACIDS

Organic peroxides may be prepared :—

1. By the interaction of an acyl chloride with hydrogen peroxide in the presence of alkali ($H_2O_2 + 2NaOH \equiv Na_2O_2$), for example :



2. By the reaction between a solution of an acyl halide in a dry organic solvent, such as toluene, with a cold solution of sodium peroxide, for example :

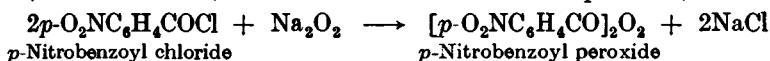

The preparation of organic per-acids is illustrated by :—

Perbenzoic acid. Treatment of a cold sodium methoxide solution with a solution of pure benzoyl peroxide in chloroform affords methyl benzoate and a solution of the sodium salt of perbenzoic acid :



The methyl benzoate is removed by extraction with chloroform, and upon cautious acidification of the aqueous layer perbenzoic acid is liberated ; the latter is extracted with chloroform and is usually preserved as a solution in this solvent :

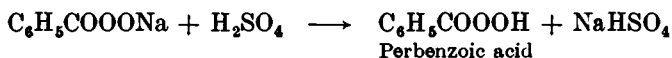

Monoperphthalic acid. This is obtained by adding finely-powdered phthalic anhydride to a well-stirred solution of 30 per cent. hydrogen peroxide in alkali at -10° ; the solution is acidified and the per-acid is extracted with ether :

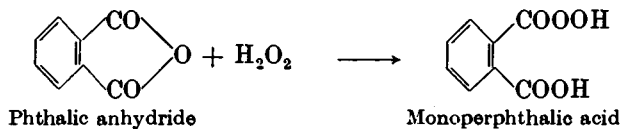

IV,196.

BENZOYL PEROXIDE

Immerse a 600 ml. beaker, containing 50 ml. of "40-volume" hydrogen peroxide and equipped with a mechanical stirrer, in an ice bath. Support two dropping funnels, containing respectively 30 ml. of 4*N* sodium hydroxide solution and 30 g. (25 ml.) of redistilled benzoyl chloride (Section IV,185), with their stems inside the beaker. Add the two reagents alternately a few drops at a time, taking care that the temperature does not rise above $5-8^\circ$ and that the solution is maintained faintly alkaline throughout. When all the reagents have been added, stir the solution for a further half an hour ; by this time the odour of the benzoyl chloride should have disappeared. Filter off the flocculent precipitate at the pump, wash it with a little cold water, and dry upon filter paper. The yield of benzoyl peroxide is 12 g. It may be purified by dissolving in chloroform at room temperature and adding twice the volume of methyl alcohol. It should *not* be recrystallised from hot chloroform as serious explosion may result. The compound melts at 106° with decomposition. Like all organic peroxides, benzoyl peroxide should be handled with care.

To determine the exact peroxide content of benzoyl peroxide (and of other organic peroxides) the following procedure may be employed. Place about 0.05 g. of the sample of peroxide in a glass-stoppered conical flask: add 5–10 ml. of acetic anhydride (A.R. or other pure grade) and 1 g. of powdered sodium iodide. Swirl the mixture to dissolve the sodium iodide and allow the solution to stand for 5–20 minutes. Add 50–75 ml. of water, shake the mixture vigorously for about 30 seconds, and titrate the liberated iodine with standard sodium thiosulphate solution using starch as indicator.

When polymers or other water-soluble substances are present in the sample, it is advantageous to add a small amount of chloroform to the initial reaction mixture; after the subsequent addition of water, a two-phase system results which may be titrated in the usual way to a starch end point or by observing the disappearance of the iodine colour in the chloroform layer.

IV,197. *p*-NITROBENZOYL PEROXIDE

Immerse a 600 ml. beaker containing 100 ml. of water in a bath of crushed ice. Provide an efficient mechanical stirrer and a thermometer for recording the temperature of the solution. When the temperature of the water has fallen to 0–5°, add 10 g. of sodium peroxide (*CAUTION*). Support a dropping funnel, charged with a solution of 37 g. of *p*-nitrobenzoyl chloride (Section IV,184) in 100 ml. of dry toluene, over the beaker. Add this solution dropwise over a period of about 30 minutes whilst stirring vigorously. Continue the stirring for a further 90 minutes, then filter off the precipitate at the pump, and wash it with 200 ml. of cold water. Dry in the air. The yields of *p*-nitrobenzoyl peroxide, m.p. 155–156° (decomp.), is 28 g. Purify by dissolving *as rapidly as possible* in 500 ml. of dry toluene which has been preheated to 80–85°; immediately the solid is completely dissolved (about 2 minutes stirring is required), filter through a preheated Buchner funnel and cool the filtrate at once in a bath of crushed ice; 25 g. of very pale yellow needles, m.p. 156° (decomp.) are obtained.

IV,198. PERBENZOIC ACID (BENZOYL HYDROGEN PEROXIDE)

Place 5.2 g. of sodium in a 500 ml. dry conical flask provided with a reflux condenser, and add 100 ml. of absolute methyl alcohol; slight cooling may be necessary to moderate the vigour of the reaction. Cool the resulting solution of sodium methoxide to –5° in a freezing mixture of ice and salt: remove the condenser. Add a solution of 50 g. of freshly recrystallised benzoyl peroxide (Section IV,196) (1) in 200 ml. of chloroform, with shaking and cooling, at such a rate that the temperature does not rise above 0°. Keep the mixture in the ice-salt bath for 5 minutes with continuous shaking; it turns milky but no precipitate appears. Transfer the reaction mixture to a 1 litre separatory funnel and extract the sodium perbenzoate with 500 ml. of water containing much crushed ice. [It is essential that the preparation be carried out as rapidly as possible and the temperature kept as near 0° as feasible, especially before the free acid is liberated from the sodium salt.] Separate the chloroform layer, and extract the aqueous layer twice with 100 ml.

portions of cold chloroform to remove the methyl benzoate. Liberate the perbenzoic acid from the aqueous solution by the addition of 225 ml. of ice-cold *N* sulphuric acid and extract it from solution with three 100 ml. portions of cold chloroform. Dry the moist chloroform solution (about 308 ml.) with a little anhydrous sodium or magnesium sulphate, and keep it in an ice box or a refrigerator until required (2); it contains about 24 g. of perbenzoic acid.

To determine the exact perbenzoic acid content of the solution, proceed as follows. Dissolve 1.5 g. of sodium iodide in 50 ml. of water in a 250 ml. reagent bottle and add about 5 ml. of glacial acetic acid and 5 ml. of chloroform. Introduce a known weight or volume of the chloroform solution of perbenzoic acid and shake vigorously. Titrate the liberated iodine with standard 0.1*N* sodium thiosulphate solution in the usual manner.

1 ml. of 0.1*N* Na₂S₂O₃ ≡ 0.0069 g. of perbenzoic acid

To obtain crystalline perbenzoic acid, dry the moist chloroform solution with a little anhydrous sodium or magnesium sulphate for an hour, filter, and wash the desiccant with a little dry chloroform. Remove the chloroform under reduced pressure at the ordinary temperature whilst carbon dioxide is introduced through a capillary tube. Dry the white or pale yellow residue for several hours at 30–35° under 10 mm. pressure. The yield of crystalline perbenzoic acid, m.p. about 42°, which is contaminated with a little benzoic acid, is 22 g. It is moderately stable when kept in the dark in a cold place; it is very soluble in chloroform, ethyl acetate and ether, but only slightly soluble in cold water and in cold light petroleum.

Notes.

(1) It is essential to use freshly recrystallised benzoyl peroxide. The commercial material usually gives poor results. Commercial benzoyl peroxide may be recrystallised from a small amount of hot chloroform, or by dissolving in chloroform and precipitating with absolute methyl alcohol.

The m.p. is not always a safe criterion of purity. Benzoyl peroxide may be analysed as follows: Dissolve about 0.5 g., accurately weighed, of benzoyl peroxide in 15 ml. of chloroform in a 350 ml. conical flask. Cool to –5°, and add 25 ml. of 0.1*N* sodium methoxide solution at once with cooling and shaking. After 5 minutes at –5°, add 100 ml. of iced water, 5 ml. of 10 per cent. sulphuric acid, and 2 g. of potassium iodide in 20 ml. of 10 per cent. sulphuric acid in the order mentioned with vigorous stirring. Titrate the liberated iodine with standard 0.1*N* sodium thiosulphate solution.

1 ml. of 0.1*N* Na₂S₂O₃ ≡ 0.0121 g. of benzoyl peroxide.

(2) Perbenzoic acid is used for the conversion of ethylenic compounds into oxides:

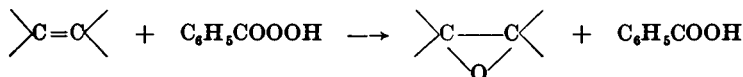

The number of ethylenic linkages in a given compound can be established with accuracy by quantitative titration with perbenzoic acid. A solution of the substance and excess of perbenzoic acid in chloroform is allowed to stand for several hours at a low temperature and the amount of unreacted perbenzoic acid in solution is determined: a blank experiment is run simultaneously.

Owing to the greater stability and the easier preparation, monopero-phthalic acid is generally preferred to benzoic acid.

IV,199. MONOPERPHTHALIC ACID

Cool a 500 ml. round-bottomed flask containing 125 ml. of 15 per cent. sodium hydroxide solution, and equipped with a mechanical stirrer, in a bath of ice and salt. When the temperature has fallen to -10° , add in one portion 57.5 g. (52.5 ml.) of "100 volume" (or 30 per cent.) hydrogen peroxide which has previously been cooled to -10° . The temperature rises owing to the heat of the reaction. When the temperature has again dropped to -10° , add, whilst stirring *vigorously*, 37.5 g. of pure phthalic anhydride (1) (finely-powdered to pass a 40-mesh sieve) as quickly as possible. Immediately the anhydride has dissolved (2), add 125 ml. of 20 per cent. sulphuric acid which has previously been cooled to -10° . Filter the solution through a plug of glass wool in a funnel into a 1-litre separatory funnel: extract with ether (once with 250 ml., then three times with 125 ml. portions). Shake the combined ether extracts with three 75 ml. portions of 40 per cent. ammonium sulphate solution and dry for 24 hours, preferably in an ice chest or refrigerator, over 25 g. of anhydrous sodium or magnesium sulphate. The ether solution, which contains 30 g. of monoperphthalic acid (3), may be used for the conversion of unsaturated compounds into oxides (see under *Perbenzoic Acid*, Section IV,198, Note 2). If ether is not a suitable solvent for the oxidation reactions in which the per-acid is to be used, the monoperphthalic acid may be dissolved in dry chloroform or in peroxide-free dioxan after the removal of the ether (see below).

To prepare crystalline monoperphthalic acid, place the thoroughly dry ethereal solution (4) in a distilling flask equipped with a capillary tube connected with a calcium chloride or cotton wool drying tube, and attach the flask to a water pump. Evaporate the ether without the application of heat (ice will form on the flask) to a thin syrup (about 150 ml.). Transfer the syrup to an evaporating dish, rinse the flask with a little anhydrous ether, and add the rinsings to the syrup. Evaporate the remainder of the ether in a vacuum desiccator over concentrated sulphuric acid: about 30 g. of monoperphthalic acid, m.p. 110° (decomp.), is obtained.

Notes.

(1) If it is suspected that phthalic acid is present in the phthalic anhydride, the latter may be dissolved in chloroform; the phthalic acid is insoluble in this solvent.

(2) The whole success of the preparation depends upon reducing the time interval between the addition of the phthalic anhydride and the acidification of the reaction mixture to a minimum; vigorous stirring will assist the initial dissolution, but prolonged stirring leads to excessive evolution of oxygen. The more rapidly the anhydride dissolves, the smaller the oxygen evolution, and the better the yield of monoperphthalic acid.

(3) To determine the per-acid content, add 30 ml. of 20 per cent. potassium iodide solution to 2.0 ml. of the solution and, after 10 minutes, titrate the liberated iodine with standard 0.05N sodium thiosulphate solution (compare *Perbenzoic Acid*, Section IV,198, Note 1).

(4) The results are unsatisfactory unless the drying is very thorough; only 1 per cent. of water in the ether solution will destroy all the per-acid.

AROMATIC ALCOHOLS

Aromatic alcohols (derivatives of carbinol HCH_2OH) may be prepared (compare *Aliphatic Alcohols*, discussion preceding Section III,14) :

1. By the Cannizzaro reaction. This consists in the action of a concentrated aqueous solution of sodium or potassium hydroxide upon an aldehyde (see detailed discussion before Section IV,123), for example :

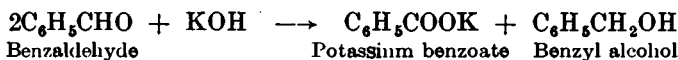

Only half of the aldehyde is reduced to the alcohol, the other half being oxidised to the acid. By using a slight excess (say, 1.3 mols) of aqueous formaldehyde, practically the whole of the aromatic aldehyde is converted into the alcohol : the formaldehyde is simultaneously oxidised to formic acid. This is sometimes termed a *crossed Cannizzaro reaction*. The example given is :

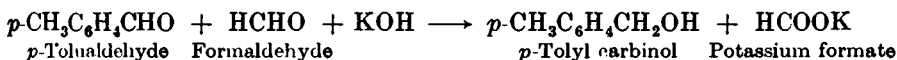

Benzaldehyde and veratraldehyde (Section IV,194) may be similarly converted into the corresponding alcohols.

Aromatic primary alcohols differ from aliphatic primary alcohols in that they react with concentrated hydrochloric acid in the cold to yield the corresponding chlorides, for example :

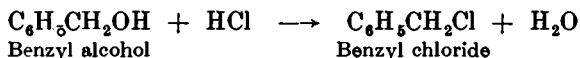

2. Reduction of ketones, *e.g.*, with zinc powder and alcoholic sodium hydroxide leads to secondary alcohols, for example :

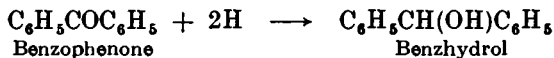

3. By the action of a Grignard reagent upon an ester or a ketone, for example :

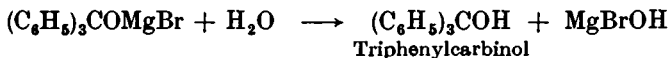
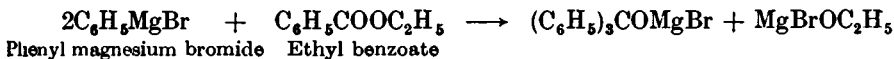

A little diphenyl is formed as a by-product in the reaction :

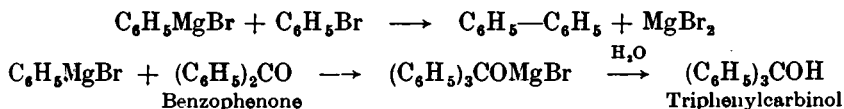

Triphenylchloromethane $(\text{C}_6\text{H}_5)_3\text{CCl}$ is readily hydrolysed by warm water to triphenylcarbinol, thus providing an alternative method for the preparation of the latter. The former is conveniently obtained by the reaction between carbon tetrachloride and benzene in the presence of anhydrous aluminium chloride :

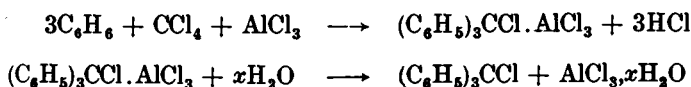

the mixture ; the temperature slowly rises to about 70°. After 3 hours, when the temperature has commenced to fall, filter the reaction mixture with suction and wash the residue twice with 25 ml. portions of hot alcohol. Do not allow the residual zinc powder to become dry as it is inflammable. Pour the filtrate into 2 litres of ice water acidified with 100 ml. of concentrated hydrochloric acid. The benzhydrol separates as a white crystalline mass. Filter at the pump and dry in the air. The yield of crude benzhydrol, m.p. 65°, is 49 g. Recrystallise from 50 ml. of hot alcohol and cool in a freezing mixture of ice and salt. Collect the colourless crystals and dry in the air ; 36 g. of pure diphenylcarbinol, m.p. 68°, are obtained. Precipitate the mother liquor with water to recover the residual benzhydrol, and recrystallise this from a small quantity of hot alcohol.

IV,202.

TRIPHENYLCARBINOL

Procedure for advanced students. Place 15.5 g. of dry magnesium turnings in a 1 litre three-necked flask fitted with a dropping funnel, mercury-sealed mechanical stirrer and a double surface reflux condenser. Place a solution of 15 g. (10 ml.) of dry bromobenzene (Section IV,18) in 35 ml. of sodium dried ether (Section II,47, 1) in the dropping funnel. Provide both the latter and the reflux condenser with calcium chloride (or cotton wool) guard tubes in order to prevent the entrance of moisture into the reaction mixture. Run in the bromobenzene solution on to the magnesium and warm gently on a water bath until the reaction becomes vigorous. If no reaction ensues, add a small crystal of iodine to start the reaction ; the use of iodine is generally unnecessary if the reagents and the apparatus are thoroughly dry. As soon as the reaction is moderately vigorous, immerse the flask in a bath of cold water. Start the stirrer and add a solution of 75.5 g. (50.5 ml.) of dry bromobenzene in 200 ml. of sodium-dried ether at such a rate as to cause vigorous refluxing (during about 1 hour) ; when all the bromobenzene solution has been introduced, stir the mixture for 20–30 minutes, *i.e.*, until most (or all) of the magnesium has dissolved.

To the resulting Grignard reagent (phenyl magnesium bromide) cooled in a cold water bath, add a solution of 37.5 g. (36 ml.) of dry ethyl benzoate (Section IV,176) in 100 ml. of dry benzene (either sodium-dried or dried with anhydrous magnesium or calcium sulphate) at such a rate that the mixture refluxes gently (about 1 hour). Then reflux the mixture for 1 hour on a water bath. Cool in a freezing mixture of ice and salt and pour it slowly, with constant stirring, into a mixture of 750 g. of crushed ice and 25 ml. of concentrated sulphuric acid. Continue the stirring until all the solid dissolves ; it may be necessary to add 25 g. of solid ammonium chloride to facilitate the decomposition of the magnesium complex, and also a little more benzene to dissolve all the product. When all the solids have passed into solution, separate the benzene layer and wash it successively with 100 ml. of water, 100 ml. of 5 per cent. sodium bicarbonate solution and 100 ml. of water. Remove the benzene as completely as possible from a 1 litre round-bottomed flask : steam distil the residue (Fig. II, 40, 1) in order to separate unchanged bromo-

benzene and diphenyl (by-product). Filter the cold residue in the flask at the pump, wash it with water and dry. The resulting crude triphenylcarbinol weighs 62 g. Recrystallise it from carbon tetrachloride (4 ml. per gram of solid): the first crop of crystals, after drying in air to remove the solvent of crystallisation, weighs 56 g. and melts at 162°. Treat the mother liquid with 1 g. of decolourising carbon, concentrate to one-quarter of the original volume and cool in ice: a further 3 g. of pure triphenylcarbinol is obtained.

In an alternative method of preparation, benzophenone is used. Prepare the Grignard reagent from 13.5 g. of magnesium turnings as above, cool in cold water, and add a solution of 91 g. of benzophenone (Section IV,139) in 200 ml. of dry benzene at such a rate that the mixture refluxes gently. Reflux the mixture for 60 minutes, and isolate the triphenylcarbinol in the manner described above. The yield is of the same order.

Procedure for elementary students. Fit a 500 ml. round-bottomed or bolt-head flask with a two-way adapter carrying a separatory funnel and a reflux (preferably double surface) condenser (Fig. II, 13, 9). If an adapter is not available, fit the reflux condenser directly into the flask and mount the separatory funnel into the top of the condenser by means of a grooved cork. Make certain that all the apparatus, including the corks, is perfectly dry before the preparation is attempted. Place 2.7 g. of dry magnesium turnings, 15 ml. of sodium-dried ether (Section II,47, I) and a minute crystal of iodine in the flask. Prepare a solution of 18 g. of dry bromobenzene (Section IV,18) in 50 ml. of anhydrous ether in a small corked conical flask. Pour about 10 ml. of this solution into the separatory funnel and add it to the contents of the flask. Await the beginning of the reaction (slight boiling of the ether). If no reaction commences within 3 minutes, warm the flask gently in a bath of warm water until the reaction starts; remove the water bath. When the reaction has started (*but not before*), add the remainder of the bromobenzene solution from the separatory funnel in small portions, *i.e.*, at such a rate that the ether refluxes gently without external heating. After all the halide has been added, replace the separatory funnel by a calcium chloride or cotton wool guard tube (1) and reflux the mixture *gently* on a water bath for 30–40 minutes in order to complete the reaction: most of the magnesium should then have disappeared.

Remove the flask containing the Grignard reagent and cool it to room temperature or below by immersion in a bath of cold water or ice water. Replace the guard tube by a separatory funnel (1) containing a solution of 7.5 g. (7.2 ml.) of dry ethyl benzoate (Section IV,163) in 20 ml. of anhydrous ether. Run this solution dropwise into the Grignard reagent and thoroughly mix the solutions by shaking from time to time; cool the flask occasionally if the boiling is very vigorous. Finally reflux gently on a water bath for 15–30 minutes. Cool the contents of the flask and pour cautiously into a mixture of 150 g. of crushed ice and 5 ml. of concentrated sulphuric acid contained in a large flask or beaker. Stir so that the magnesium compound is completely decomposed and the triphenylcarbinol, etc., dissolves in the ether: the addition of a further small quantity of technical ether may be necessary to effect the solution

of the solid. Transfer to a separatory funnel, run off the lower layer, and shake the ethereal solution twice with 30 ml. portions of 10 per cent. sulphuric acid (to remove magnesium salts completely), once with water, and finally with 25 ml. of water containing 0.5 g. of sodium bisulphite (to remove the iodine used to start the reaction). Return the ether to the (washed) 500 ml. flask and distil off the ether on a water bath; take the customary precautions against fire. Add 50–75 ml. of water to the residue and fit the flask for steam distillation (Fig. II, 40, 1). Steam distil until no further oil (unchanged reactants and diphenyl) passes over. Upon cooling the flask, the residue solidifies. Filter the solid at the pump and dry it between several layers of filter papers. Recrystallise the crude but colourless triphenylcarbinol (12 g.) from rectified (or methylated) spirit or from carbon tetrachloride (4 ml. per gram of solid); dry the recrystallised product in the air. The yield of pure triphenylcarbinol, m.p. 162°, is 10 g.

Note.

(1) If the apparatus of Fig. II, 13, 9 is used, there is, of course, no need to remove the guard tube from the top of the condenser.

IV.203. TRIPHENYLCHLOROMETHANE *

Place 200 g. (228 ml.) of sodium-dried A.R. benzene and 80 g. (47 ml.) of dry, pure carbon tetrachloride in a 500 ml. three-necked flask, equipped with a reflux condenser attached to a trap (Fig. II, 8, 1, c) for the absorption of the hydrogen chloride, a mercury-sealed mechanical stirrer, and a device for the addition of a solid (see Figs. II, 7, 12, c or d); charge the last-named with 60 g. of finely-powdered, anhydrous aluminium chloride. Cool the flask in an ice bath, and add the aluminium chloride in small portions to the contents of the flask at such a rate that the reaction mixture does not reflux during the addition (about 1.5 hours). Remove the ice bath 15 minutes after all the solid has been introduced, and allow the reaction to proceed without further cooling. When heat is no longer evolved, reflux the mixture until the evolution of hydrogen chloride subsides (ca. 2 hours); then allow to cool to room temperature. Pour the cold reaction product in a thin stream on to a mixture of 300 g. of crushed ice and 300 ml. of concentrated hydrochloric acid; stir vigorously. Separate the benzene layer and extract the aqueous layer with a little benzene; wash the combined extracts once with 200 ml. of cold concentrated hydrochloric acid. Dry the benzene solution by leaving for at least two hours over 25 g. of anhydrous calcium chloride (or anhydrous magnesium sulphate). Distil off the benzene (Fig. II, 13, 4 but with Claisen flask fitted with a thermometer) until the temperature reaches about 100°. Transfer the warm residue, with the aid of a little dry benzene, to a 200 ml. conical flask, cool to about 40°, add 3–4 ml. of acetyl chloride (1) and heat the mixture nearly to the boiling point. Shake the solution vigorously whilst cooling rapidly to room temperature and then cool in ice for 2 hours. Filter the solid triphenylchloromethane on a sintered glass funnel with suction, crush the crystals with a large glass stopper, wash with three 30 ml. portions of light petroleum, b.p. 60–80°

* Sometimes termed *Triptyl chloride*.

(free from aromatic hydrocarbons). Dry in a vacuum desiccator over paraffin wax shavings or silica gel to remove the solvent. The resulting pale greenish-yellow crystals of triphenylchloromethane melt at 111–112° and weigh 90 g. Store the product in a well-stoppered (or in a “screw-topped”) bottle sealed with paraffin wax; this is necessary since triphenylchloromethane is slowly hydrolysed to triphenylcarbinol by the moisture of the air (2).

Notes.

(1) The acetyl chloride converts any triphenylcarbinol which may be present into triphenylchloromethane :

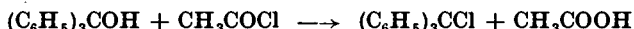

(2) The partially hydrolysed product may be purified by recrystallisation from one-third its weight of pure benzene containing 10–20 per cent. of acetyl chloride, and washing the crystals with light petroleum (b.p. 60–80°) to which a little acetyl chloride has been added.

To prepare triphenylcarbinol from triphenylchloromethane, boil the latter with excess of water for 10 minutes. Filter off the resulting triphenylcarbinol, dry between filter papers, and recrystallise from carbon tetrachloride or alcohol; m.p. 162°. The yield is almost quantitative.

IV,204.

β-PHENYLETHYL ALCOHOL

Equip a 3 litre three-necked flask with a separatory funnel, a mercury-sealed mechanical stirrer and a long reflux condenser with an inner tube 2–2.5 cm. in diameter : use a short length of wide-bore rubber “pressure tubing” for fitting the condenser into the flask. Place 42 g. of clean sodium and 120 ml. of sodium-dried toluene in the flask and heat the latter in an oil bath until the sodium has melted. Start the stirrer; when the sodium is finely divided, remove the oil bath and allow the mixture to cool. Continue the stirring during the cooling in order to keep the sodium in the finely divided form. When the mixture has cooled to about 60°, add a solution of 50 g. of ethyl phenylacetate (Section IV,179) in 150 g. (190 ml.) of “super-dry” ethyl alcohol (Section II,47,5) as rapidly as possible without allowing the reaction to get out of control. Then add a further 200 g. (253 ml.) of “super-dry” alcohol. When the reaction has subsided, heat the flask in a water bath until the sodium is completely dissolved. Distil off the alcohol and toluene under reduced pressure (compare Fig. II, 37, 1). Dilute the residue with water and extract the phenylethyl alcohol with ether or benzene, dry the extract with anhydrous magnesium sulphate, remove the solvent, and distil the residual oil under reduced pressure. Collect the β-phenylethyl alcohol at 116–118°/25 mm. The yield is 25 g.

The alcohol may be purified by conversion into the calcium chloride addition compound. Treat it with anhydrous calcium chloride; much heat is evolved and the addition compound is formed. After several hours, remove any oil which has not reacted by washing with petroleum ether (b.p. 60–80°). Decompose the solid with ice water, separate the alcohol, dry and distil.

IV,205. REACTIONS AND CHARACTERISATION OF AROMATIC ALCOHOLS

Aromatic alcohols are insoluble in water and usually burn with a smoky flame. Their boiling points are comparatively high ; some are solids at the ordinary temperature. Many may be oxidised by cautious addition of dilute nitric acid to the corresponding aldehyde ; upon neutralisation of the excess of acid, the aldehyde may be isolated by ether extraction or steam distillation, and then identified as detailed under *Aromatic Aldehydes*, Section IV,135.

Most aromatic alcohols exhibit the majority of the reactions given under *Aliphatic Alcohols*, Section III,27, and may be converted into crystalline derivatives as there described.

Table IV,205, contains the melting points of the derivatives of a number of commonly-occurring aromatic alcohols.

TABLE IV, 205.

AROMATIC ALCOHOLS

Alcohol	B.P.	M.P.	3 : 5-Dinitrobenzoate	<i>p</i> -Nitrobenzoate	Phenylurethane	α -Naphthylurethane	Hydrogen 3-nitrophthalate	Other Derivatives
Benzyl	205°	—	113°	86°	76°	134°	176°	—
β -Phenylethyl	220	—	108	63	80	119	123	—
Methylphenyl carbinol (1)	203	20°	94	43	92	106	—	—
Ethylphenyl carbinol (2)	219	—	—	60	—	102	—	—
<i>n</i> -Propylphenyl carbinol (3)	118°/18	16	—	58	—	99	—	—
<i>n</i> -Butylphenyl carbinol (4)	137°/21	—	—	—	75	—	—	—
Diphenyl carbinol (5)	298	69	142	—	140	136	—	Acetyl, 42°
γ -Phenyl- <i>n</i> -propyl (6)	237	—	92	46	48	—	117	—
Triphenyl carbinol	380	165	—	—	—	—	—	Acetyl, 88 ; triphenylmethane, 92
<i>o</i> -Nitrobenzyl	270	74	—	—	—	—	—	Benzoyl, 102
<i>m</i> -Nitrobenzyl	—	27	—	—	—	—	—	Benzoyl, 72
<i>p</i> -Nitrobenzyl	185°/12	93	—	—	—	—	—	Benzoyl, 95 ; acetyl, 78
<i>o</i> -Aminobenzyl	—	82	—	—	—	—	—	<i>N</i> -Acetyl, 114 ; picrate, 110
<i>m</i> -Aminobenzyl	—	97	—	—	—	—	—	<i>N</i> -Acetyl, 107 ; dibenzoyl, 114
<i>p</i> -Aminobenzyl	—	65	—	—	—	—	—	Diacetyl, 188
<i>o</i> -Chlorobenzyl	230	74	—	94	—	—	—	—
<i>m</i> -Chlorobenzyl	234	—	—	—	—	—	—	—
<i>p</i> -Chlorobenzyl	235	75	—	—	—	—	—	—
<i>o</i> -Bromobenzyl	—	80	—	—	—	—	—	<i>o</i> -Bromobenzoic acid, 150 (KMnO ₄)
<i>m</i> -Bromobenzyl	254	—	—	—	—	—	—	—
<i>p</i> -Bromobenzyl	—	77	—	—	—	—	—	Acetyl, 23
<i>o</i> -Iodobenzyl	—	90	—	—	—	—	—	—
<i>m</i> -Iodobenzyl	165°/16	—	—	—	—	—	—	—
<i>p</i> -Iodobenzyl	—	72	—	—	—	—	—	—
<i>o</i> -Hydroxybenzyl (7)	—	87	—	—	—	—	—	Benzoyl, 60
<i>m</i> -Hydroxybenzyl	—	73	—	—	—	—	—	Acetyl, 84 ; diacetyl, 75

TABLE IV, 205.

AROMATIC ALCOHOLS (continued)

Alcohol	B.P.	M.P.	3 : 5-Dinitro- benzoate	<i>p</i> -Nitro- benzoate	Phenyl- urethane	α -Naph- thyl- urethane	Hydrogen 3-nitro- phthalate	Other Derivatives
<i>p</i> -Hydroxybenzyl	—	125°	—	—	—	—	—	—
<i>o</i> -Methoxybenzyl	249°	—	—	—	—	136°	—	Benzoyl, 59°
<i>m</i> -Methoxybenzyl	252	—	—	—	—	—	—	—
<i>p</i> -Methoxybenzyl (8)	259	25	—	—	93°	—	—	Benzoyl, 38; anisic acid, 184
<i>o</i> -Tolyl carbinol (9)	219	36	—	—	79	—	—	<i>o</i> -Toluic acid, 104
<i>m</i> -Tolyl carbinol	217	—	—	—	—	116	—	—
<i>p</i> -Tolyl carbinol	217	60	—	—	79	—	—	—
Cinnamyl	257	33	121°	78°	91	114	—	—
Piperonyl (10)	—	58	—	—	102	—	—	Benzoyl, 66
Benzoin	—	137	—	123	165	140	—	Acetyl, 83; benzoyl, 125; semicarbazone, 206d; 2 : 4-dinitrophenylhydra- zone, 234

- (1) α -Phenylethyl alcohol or α -Methylbenzyl alcohol.
- (2) α -Ethylbenzyl alcohol.
- (3) α -Phenyl-*n*-butyl alcohol or α -Propylbenzyl alcohol.
- (4) α -Phenyl-*n*-amyl alcohol.
- (5) Benzhydrol.

- (6) Hydrocinnamyl alcohol.
- (7) Saligenin.
- (8) Anisyl alcohol.
- (9) 2-Methylbenzyl alcohol.
- (10) 3 : 4-Methylenedioxybenzyl alcohol.

COMPOUNDS DERIVED FROM AROMATIC SULPHONIC ACIDS

Aryl sulphonic acids, either free or in the form of their sodium or potassium salts, are converted into the acid chlorides by reaction with phosphorus pentachloride or phosphorus oxychloride, for example :

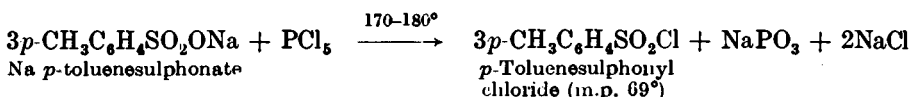
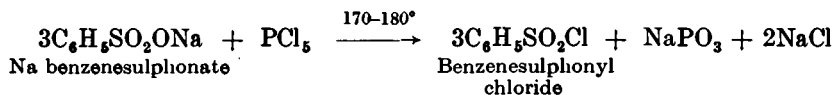

The aryl sulphonyl chlorides may also be obtained from the aromatic hydrocarbon and chlorosulphonic acid, for example :

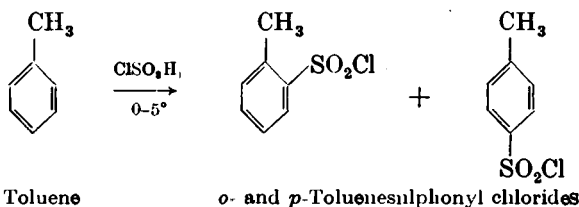
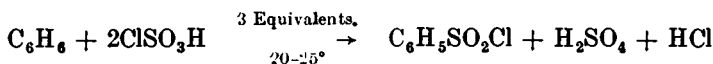

The mixture of *o*- and *p*-toluenesulphonyl chlorides produced from toluene may be separated by cooling to -10° to -20° when most of the *p*-isomer, which is a solid, m.p. 69° , separates out. Both isomers may be easily converted (*e.g.*, by treatment with solid ammonium carbonate or with concentrated ammonia solution) into the corresponding highly crystalline sulphonamides which may be employed for interesting syntheses.

Dichloramine-T and chloramine-T. When *p*-toluenesulphonamide is dissolved in *excess* of sodium (or calcium) hypochlorite solution, it is converted into the soluble salt of the *N*-monochloro derivative :

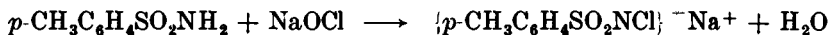

Upon the addition of a weak acid (*e.g.*, acetic acid), it reacts with the liberated hypochlorous acid giving *NN*-dichloro-*p*-toluenesulphonamide (dichloramine-T) which, being insoluble in water, crystallises rapidly :

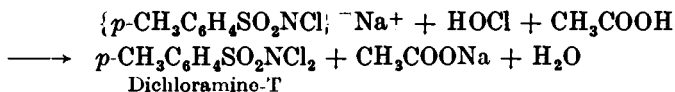

When the dichloramine-T is heated with sodium hydroxide solution, the reverse change occurs and sodium *N*-chloro-*p*-toluenesulphonamide (chloramine-T) crystallises out on cooling at a suitable concentration :

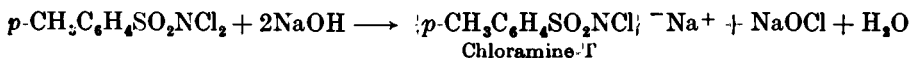

Both chloramine-T and dichloramine-T slowly liberate hypochlorous acid in contact with water and are therefore employed as antiseptics: the former is employed in the form of a dilute (*e.g.*, 0.2 per cent.) aqueous solution, and the latter (which is insoluble in water) as a solution in an organic solvent, such as a chlorinated paraffin.

Saccharin (imide of *o*-sulphobenzoic acid). Upon oxidising *o*-toluenesulphonamide with potassium permanganate in alkaline solution, the sodium salt of *o*-sulphonamidobenzoic acid is formed, which upon acidifying with concentrated hydrochloric acid or warming passes spontaneously into the cyclic imide of *o*-sulphobenzoic acid or saccharin:

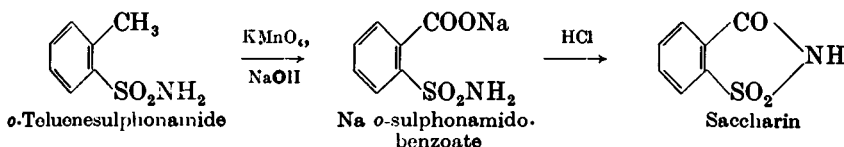

Saccharin itself is sparingly soluble in cold water, but the imino hydrogen is acidic and the compound forms a water-soluble sodium salt. The latter is about 500 times as sweet as cane sugar.

The use of benzenesulphonyl chloride or of *p*-toluenesulphonyl chloride in the separation and identification of amines is described in Section IV,100.

Esters of *p*-toluenesulphonic acid, which are of great value as alkylating agents, may be prepared by interaction of *p*-toluenesulphonyl chloride and the alcohol in the presence of sodium hydroxide solution or of pyridine, for example:

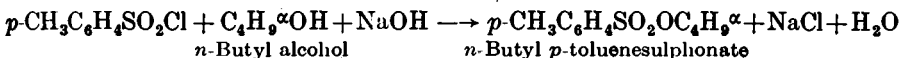

One method of preparing sulphinic acids has already been described (diazo reaction, Section IV,65). Reduction of a sulphonyl chloride with zinc powder and water affords the zinc salt of the sulphinic acid, converted by sodium carbonate to the sodium salt (in which form it is conveniently isolated), and by hydrochloric acid into the somewhat unstable sulphinic acid, for example:

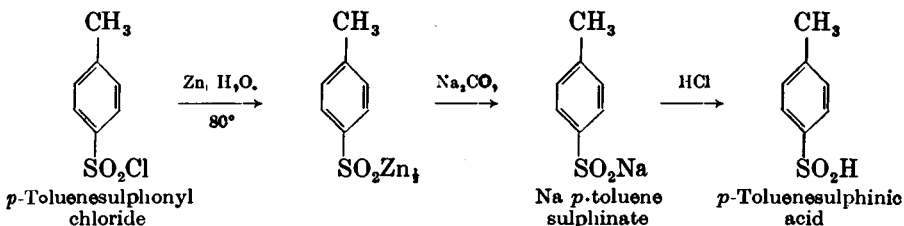

Thiophenols (or aryl mercaptans) are obtained by more vigorous reduction of sulphonyl chlorides (or of sulphinic acids), for example with zinc and dilute sulphuric acid, and are isolated by steam distillation:

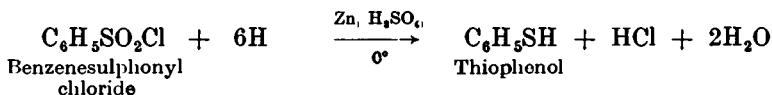

IV,206. BENZENESULPHONYL CHLORIDE

Method 1. Equip a 1 litre three-necked flask (or bolt-head flask) with a separatory funnel, a mechanical stirrer (Fig. II, 7, 10), a thermometer (with bulb within 2 cm. of the bottom) and an exit tube leading to a gas absorption device (Fig. II, 8, 1, c). Place 700 g. (400 ml.) of chlorosulphonic acid in the flask and add slowly, with stirring, 156 g. (176 ml.) of pure benzene (1); maintain the temperature between 20° and 25° by immersing the flask in cold water, if necessary. After the addition is complete (about 2.5 hours), stir the mixture for 1 hour, and then pour it on to 1500 g. of crushed ice. Add 200 ml. of carbon tetrachloride, stir, and separate the oil as soon as possible (otherwise appreciable hydrolysis occurs); extract the aqueous layer with 100 ml. of carbon tetrachloride. Wash the combined extracts with dilute sodium carbonate solution, distil off most of the solvent under atmospheric pressure (2), and distil the residue under reduced pressure. Collect the benzenesulphonyl chloride at 118–120°/15 mm.; it solidifies to a colourless solid, m.p. 13–14°, when cooled in ice. The yield is 270 g. A small amount (10–20 g.) of diphenylsulphone, b.p. 225°/10 mm., m.p. 128°, remains in the flask.

Notes.

(1) A 50 per cent. excess of chlorosulphonic acid is used; a smaller excess leads to increased formation of diphenylsulphone ($C_6H_5SO_2C_6H_5$) at the expense of the sulphonyl chloride.

(2) Any water present will distil with the carbon tetrachloride; the hydrolysis of the chloride is thus avoided.

Method 2. Place 90 g. of sodium benzenesulphonate (Section IV,29) (previously dried at 130–140° for 3 hours) and 50 g. of powdered phosphorus pentachloride (1) in a 500 ml. round-bottomed flask furnished with a reflux condenser; heat the mixture in an oil bath at 170–180° for 12–15 hours. Every 3 hours remove the flask from the oil bath, allow to cool for 15–20 minutes, stopper and shake thoroughly until the mass becomes pasty. At the end of the heating period, allow the reaction mixture to cool. Pour on to 1 kilo of crushed ice. Extract the crude benzenesulphonyl chloride with 150 ml. of carbon tetrachloride and the aqueous layer with 75 ml. of the same solvent. Remove the solvent under atmospheric pressure and proceed as in *Method 1*. The yield is about 170 g., but depends upon the purity of the original sodium benzenesulphonate.

Note.

(1) Alternatively a mixture of 90 g. of sodium benzenesulphonate and 60 g. (36 ml.) of phosphorus oxychloride may be used. The experimental procedure is identical with that for phosphorus pentachloride, but the yield is slightly better.

IV,207. *p*-TOLUENESULPHONYL CHLORIDE

Method 1. In a 750 ml. three-necked flask or wide-mouthed glass bottle, equipped with a dropping funnel, a mechanical stirrer (Fig. II, 7, 10) a thermometer (with bulb within 2 cm. of the bottom) and an outlet tube leading to a gas absorption device (Fig. II, 8, 1, c), place 400 g. (228 ml.) of chlorosulphonic acid and cool to 0° in a freezing mixture of ice and

salt. Introduce 100 g. (115 ml.) of pure dry toluene from the dropping funnel dropwise at such a rate that the temperature of the well-stirred mixture does not rise above 5°. When all the toluene has been added (about 3 hours), stir the reaction mixture for 4 hours, and then allow to stand overnight in the freezing mixture. Pour the liquid on to 1 kilo of crushed ice, separate the aqueous solution from the oily layer (mixture of *o*- and *p*-toluenesulphonyl chlorides) and wash the latter several times by decantation with cold water. To separate the *ortho* and *para* isomers, cool the oil at - 10° to - 20° (e.g., with ice and calcium chloride) for several hours; the almost pure *p*-toluenesulphonyl chloride will crystallise out. Filter at the pump upon a sintered glass funnel. The crude *p*-toluenesulphonyl chloride (30 g.) may be purified by recrystallisation from light petroleum (b.p. 40-60°) and then melts at 69°. The filtrate consists largely of *o*-toluenesulphonyl chloride: it may be obtained pure by dissolving it in carbon tetrachloride, removing the solvent and fractionating under reduced pressure; it is an oil, b.p. 126°/10 mm. The yield is about 120 g.

Method 2. The procedure described under *Benzenesulphonyl Chloride, Method 2* (Section IV,206) may be used with suitable adjustment for the difference in molecular weights between sodium *p*-toluenesulphonate (Section IV,30) and sodium benzenesulphonate. When the reaction product is poured on to ice, the *p*-toluenesulphonyl chloride separates as a solid. This is filtered with suction; it may be recrystallised from light petroleum (b.p. 40-60°) and then melts at 69°.

IV,208. DICHLORAMINE-T AND CHLORAMINE-T

p-Toluenesulphonamide. Grind together 10 g. of *p*-toluenesulphonyl chloride (Section IV,207) and 20 g. of ammonium carbonate in a mortar until a fine uniform powder is obtained. Heat the mixture in an evaporating dish on a water bath for 1-2 hours and stir the mixture frequently with a glass rod. Allow to cool and extract with a little cold water to remove the excess of ammonium salts. Recrystallise the crude *p*-toluenesulphonamide from boiling water (200-250 ml.), and dry the colourless crystals at 100°. The yield of pure product, m.p. 138°, is 9 g.

Alternatively, grind 10 g. of *p*-toluenesulphonyl chloride to a fine powder and add it to 30 ml. of concentrated ammonia solution (sp. gr. 0.88). Heat the mixture to boiling (*FUME CUPBOARD*) and cool. Filter and recrystallise the *p*-toluenesulphonamide from boiling water (add 1 g. of decolourising carbon, if necessary). The yield of pure product, m.p. 138°, is almost theoretical.

Dichloramine-T (p-toluenesulphondichloramide). Prepare about 200 ml. of a saturated solution of calcium hypochlorite by grinding a fresh sample of bleaching powder with water and filtering with slight suction. Dissolve 5 g. of *p*-toluenesulphonamide in as small a volume of the calcium hypochlorite solution as possible (about 150 ml.) and filter the solution if necessary. Cool in ice, and add about 50 ml. of a mixture of equal volumes of glacial acetic acid and water *slowly* and with stirring until precipitation is complete. The dichloramine-T separates out first as a fine emulsion, which rapidly forms colourless crystals. Filter the latter

at the pump, wash with a little cold water, drain and dry immediately either between pads of filter paper or upon a porous tile. The yield is 6.5 g., m.p. 81°. Upon recrystallisation from light petroleum (b.p. 60–80°) or from chloroform-light petroleum, perfectly pure dichloramine-T, m.p. 83°, is obtained with negligible loss.

Chloramine-T (sodium *N*-chloro-*p*-toluenesulphonamide). For this preparation use dichloramine-T which has been prepared as above and thoroughly drained but not necessarily dried. Heat 45 ml. of 10 per cent. sodium hydroxide solution in a beaker over a wire gauze to a temperature of about 80°, and add the dichloramine-T in small quantities, stirring the mixture gently after each addition until a clear solution is obtained. When the addition is complete, filter the hot solution if turbid, and then allow it to cool spontaneously. Filter the crystals with suction, wash with a little brine solution, and dry upon filter paper or in a desiccator over anhydrous calcium chloride. The resulting chloramine-T weighs 8 g. and is almost pure. It may be recrystallised, if desired, from twice its weight of hot water.

Chloramine-T is a salt and has no definite m.p. : upon heating it loses water of crystallisation and decomposes violently at 175–180°.

IV,209.

SACCHARIN

***o*-Toluenesulphonamide.** Place 20 g. of *o*-toluenesulphonyl chloride (Section IV,207) in a large evaporating dish mounted on a water bath. Add powdered ammonium carbonate cautiously with stirring until the mass is quite hard and solid and the unpleasant odour of the sulphonyl chloride has disappeared. Allow to cool, and extract with cold water to remove the excess of ammonium carbonate. Recrystallise the crude *o*-toluenesulphonamide first from hot water (add a little decolourising carbon if it is dark in colour) and then from alcohol. The yield of pure product, m.p. 154°, is 16 g.

Oxidation of *o*-toluenesulphonamide to saccharin. In a 600 ml. beaker, mounted on a wire gauze and provided with a mechanical stirrer, place 12 g. of *o*-toluenesulphonamide, 200 ml. of water and 3 g. of pure sodium hydroxide. Stir the mixture and warm to 34–40° until nearly all has passed into solution (about 30 minutes). Introduce 19 g. of finely-powdered potassium permanganate in small portions at intervals of 10–15 minutes into the well-stirred liquid. At first the permanganate is rapidly reduced, but towards the end of the reaction complete reduction of the permanganate is not attained. The addition occupies 4 hours. Continue the stirring for a further 2–3 hours, and then allow the mixture to stand overnight. Filter off the precipitated manganese dioxide at the pump and decolourise the filtrate by the addition of a little sodium bisulphite solution. Exactly neutralise the solution with dilute hydrochloric acid (use methyl orange or methyl red as external indicator). Filter off any *o*-sulphonamidobenzoic acid (and/or *o*-toluenesulphonamide) which separates at this point. Treat the filtrate with concentrated hydrochloric acid until the precipitation of the saccharin is complete. Cool, filter at the pump and wash with a little cold water. Recrystallise from hot water. The yield of pure saccharin, m.p. 228°, is 7.5 g.

IV,210. *n*-BUTYL *p*-TOLUENESULPHONATE

Equip a 1 litre three-necked flask with a separatory funnel, a mechanical stirrer and a thermometer, the bulb of which reaches within 2 cm. of the bottom. Place 72 g. (89 ml.) of *n*-butyl alcohol and 105 g. of *p*-toluenesulphonyl chloride (Section IV,207) (1) in the flask and 160 ml. of 20 per cent. (5*N*) sodium hydroxide solution in the separatory funnel; immerse the flask in a bath of cold water. Run in the sodium hydroxide solution, with stirring, at such a rate that the temperature does not rise above 15° (3–4 hours). Now add another portion of 105 g. of *p*-toluenesulphonyl chloride, and introduce 160 ml. of 5*N* sodium hydroxide solution slowly, keeping the temperature below 15°. Continue the stirring for 4 hours longer. Separate the oily layer and treat it with enough benzene or light petroleum (b.p. 60–80°) to cause it to float on water; then wash it well with 25 ml. of 10 per cent. sodium hydroxide solution, and dry by allowing it to stand over 10 g. of anhydrous potassium carbonate. Filter and distil off the solvent using a 250 ml. Claisen flask (compare Fig. II, 13, 4). Distil the residual ester under reduced pressure (2) (oil pump) and collect the *n*-butyl *p*-toluenesulphonate at 132–133°/3 mm. The yield is 130 g.

Notes.

(1) Commercial *p*-toluenesulphonyl chloride may be purified by dissolving it in benzene, washing with 5 per cent. sodium hydroxide solution, drying by shaking with anhydrous potassium carbonate or magnesium sulphate, and distilling under reduced pressure: b.p. 146°/15 mm.; m.p. 69°. The distillation should be completed without interruption.

(2) It is best to distil under greatly reduced pressure; slight decomposition occurs even at 10 mm. pressure (b.p. 170–171°/10 mm.).

COGNATE PREPARATIONS

Methyl *p*-toluenesulphonate. This, and other alkyl esters, may be prepared in a somewhat similar manner to the *n*-butyl ester with good results. Use 500 g. (632 ml.) of methyl alcohol contained in a 1 litre three-necked or bolt-head flask. Add 500 g. of powdered pure *p*-toluenesulphonyl chloride with mechanical stirring. Add from a separatory funnel 420 g. of 25 per cent. sodium hydroxide solution drop by drop: maintain the temperature of the mixture at 23–27°. When all the alkali has been introduced, test the mixture with litmus; if it is not alkaline, add more alkali until the mixture is neutral. Allow to stand for several hours: the lower layer is the ester and the upper one consists of alcohol. Separate the ester, wash it with water, then with 4 per cent. sodium carbonate solution and finally with water. Dry over a little anhydrous magnesium sulphate, and distil under reduced pressure. Collect the methyl *p*-toluenesulphonate at 161°/10 mm.; this solidifies on cooling and melts at 28°. The yield is 440 g.

***n*-Dodecyl-*p*-toluenesulphonate (pyridine method).** In a 500 ml. three-necked flask, equipped with a stirrer and thermometer, place 46.5 g. of *n*-dodecyl alcohol (lauryl alcohol), m.p. 22–23°, and 79 g. (81 ml.) of dry pyridine. Surround the flask by a bath sufficiently cold to lower the temperature of the mixture to 10°. Add 52.5 g. of *p*-toluenesulphonyl

chloride in portions during 20 minutes, or at such a rate that the temperature does not rise above 20°. Stir the mixture for 3 hours at a temperature below 20°, then dilute with 150 ml. of concentrated hydrochloric acid in 500 ml. of ice water. Collect the ester on a chilled Buchner funnel and suck as dry as possible. Transfer the solid to a 400 ml. beaker, add 150 ml. of methyl alcohol, and warm the mixture on a steam bath until the ester melts. Cool in a freezing mixture whilst stirring vigorously; the ester separates in a finely divided state. Collect it on a chilled funnel and allow to dry in the air, preferably below 20°. The yield of ester, m.p. 24–25°, is 78 g. Recrystallise by dissolving in 100 ml. of light petroleum, b.p. 40–60°, drying the solution over anhydrous magnesium sulphate to remove traces of water, and cool to 0°. Collect the pure *n*-dodecyl-*p*-toluenesulphonate, m.p. 29–30°, in a chilled funnel.

The pyridine procedure may be applied to the preparation of other esters; they are isolated by ether extraction. The yields are generally better than by the sodium hydroxide method.

IV,211. SODIUM *p*-TOLUENESULPHINATE

In a 3 litre wide-mouthed glass jar place 600 ml. of water: provide a stainless steel mechanical stirrer (compare Fig. II, 7, 6) and a wide tube for passing steam directly into the liquid. Pass dry steam into the water until the temperature reaches 70°; shut off the steam, and add 80 g. of zinc powder (90–100 per cent. pure). Stir the mixture and add 100 g. of finely-powdered *p*-toluenesulphonyl chloride by means of a porcelain spoon during about 10 minutes; the temperature rises to about 80°. Stir for a further 10 minutes and then pass steam into the mixture until the temperature is 90°. Shut off the steam, and add 50 ml. of 12*N* sodium hydroxide solution, followed by finely-powdered sodium carbonate in 10 g. portions until the mixture is strongly alkaline. Considerable frothing occurs. Filter at the pump; the filtrate has a volume of about 900 ml. Transfer the residue to a 1 litre battery jar (or glass jar), add 150 ml. of water and stir with the metal stirrer. Pass in steam until the mixture commences to froth excessively, shut off the steam and continue the stirring for 10 minutes. Filter with suction, and add the filtrate to the main solution in a large evaporating dish. Evaporate the solution to a volume of about 200 ml. or until a considerable crust forms on the edges; cool in ice water. Filter at the pump and dry the crystals upon filter or drying paper until efflorescence just commences, then place in a tightly stoppered bottle. The yield of sodium *p*-toluenesulphinat ($p\text{-CH}_3\text{C}_6\text{H}_4\text{SO}_2\text{Na}\cdot 2\text{H}_2\text{O}$) is 70 g.

To prepare the free sulphinic acid, dissolve some of the sodium salt in cold water and cautiously acidify with hydrochloric acid; avoid an excess of mineral acid since it dissolves the sulphinic acid to a certain extent. The resulting *p*-toluenesulphinic acid is difficult to dry without partial conversion into the sulphonic acid and thioisulphonic ester ($3\text{RSO}_2\text{H} \xrightarrow{\text{H}_2\text{O}} \text{RSO}_3\text{H} + \text{RSO}_2\text{SR}$); fairly satisfactory results may be obtained by placing the sheets of filter paper in an office ledger press and exerting pressure. The m.p. is 85°.

IV,212.

THIOPHENOL

This preparation must be carried out in the fume cupboard since thiophenol has an extremely unpleasant and repulsive odour; the substance should not be allowed to come into contact with the hands or clothing since the odour clings for days.

Place 720 g. of crushed ice and 240 g. (130 ml.) of concentrated sulphuric acid in a 1500 ml. round-bottomed or bolt-head flask equipped with a mechanical stirrer. Immerse the flask in a freezing mixture of ice and salt and maintain the temperature at -5° to 0° throughout the preparation. Start the stirrer and add 60 g. of benzenesulphonyl chloride (Section IV,206) in small portions over a period of half an hour. (Benzenesulphonyl chloride melts at 14° and hence it must be added slowly and with vigorous stirring in order that it may be as finely-divided as possible for maximum reactivity in the subsequent reduction.) Then add 120 g. of zinc powder (90–100 per cent. pure) as rapidly as possible without the temperature rising above 0° (about 30 minutes). Stir the mixture for a further 1.5 hours. Fit a two-holed stopper through which the mechanical stirrer (Fig. II, 7, 10) and a double surface reflux condenser are passed; remove the ice-salt bath and allow the reaction mixture to warm up spontaneously, whilst continuing the stirring. Within 5 minutes or so, a rather violent reaction with the evolution of much hydrogen sets in; it may be necessary to cool the flask momentarily in a stream of water. When the energetic reaction has subsided, warm the mixture, with vigorous stirring, over a ring burner until the solution becomes clear (4–6 hours). Steam distil the thiophenol until organic material ceases to pass over. Separate the organic layer from the distillate, dry it with anhydrous calcium chloride or magnesium sulphate, and distil. Collect the thiophenol at $166-169^{\circ}$; the yield is 34 g.

COGNATE PREPARATION

Thio-*p*-cresol (*p*-tolyl mercaptan), $p\text{-CH}_3\text{C}_6\text{H}_4\text{SH}$. This compound may be similarly prepared from *p*-toluenesulphonyl chloride (Section IV,207). The thio-*p*-cresol crystallises in the steam distillate and is collected and dried; m.p. 43° . The b.p. under normal pressure is $194-195^{\circ}$.

CHAPTER V

SOME HETEROCYCLIC AND ALICYCLIC COMPOUNDS

V.1.

QUINOLINE

Quinoline may be prepared by heating a mixture of aniline, anhydrous glycerol and concentrated sulphuric acid with an oxidising agent, such as nitrobenzene. The reaction with nitrobenzene alone may proceed with extreme violence, but by the addition of ferrous sulphate, which appears to function as an oxygen carrier, the reaction is extended over a longer period of time and is under complete control.

The formation of quinoline probably takes place through the following stages :—

(i) The glycerol and sulphuric acid react together to give acrolein :

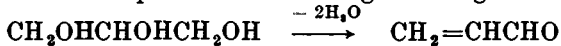

(ii) Addition of aniline to acrolein to form β -phenylaminopropionic aldehyde (I).

(iii) Ring closure of I, followed by dehydration, to produce 1 : 2-dihydroquinoline (II).

(iv) Oxidation of the dihydroquinoline by the nitrobenzene to quinoline (III); the nitrobenzene is reduced to aniline, which can react as before.

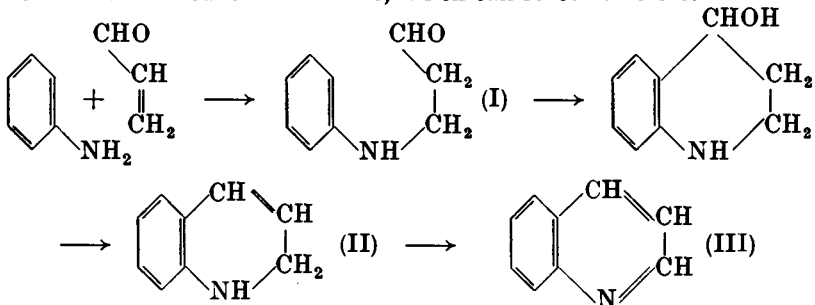

The synthesis can be carried out with most aromatic amines and is usually termed the Skraup reaction. The nitrobenzene is frequently replaced by arsenic acid, as in the preparation of 8-nitroquinoline from *o*-nitroaniline :

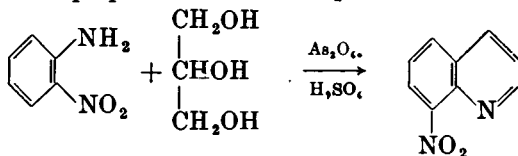

In a 2 litre round-bottomed flask, fitted with an efficient reflux condenser, place, in the following order, 16 g. of powdered crystallised ferrous sulphate, 173 g. (137.5 ml.) of anhydrous glycerol (1), 43 g. (42 ml.) of aniline and 34 g. (28 ml.) of nitrobenzene. Mix thoroughly and add slowly, and with shaking, 80 ml. of concentrated sulphuric acid. With the reflux condenser in place, heat the mixture cautiously either with a free flame or over a wire gauze until the mixture just begins to boil, and then remove the flame at once. The heat evolved in the reaction will suffice to keep the mixture boiling for about 20 minutes. (If the reaction is too vigorous at the outset, the action of the reflux condenser

may be assisted by placing a wet towel or cloth upon the upper part of the flask.) When boiling ceases, replace the burner, and boil the mixture for 5 hours longer. Allow the mixture to cool, add 100 ml. of water and steam distil from the same flask (Fig. II, 40, 1) in order to remove the excess of nitrobenzene. Change the receiver and allow the contents of the flask to cool: add a solution of 150 g. of sodium hydroxide in 300 ml. of water cautiously and with shaking to the flask and again steam distil until no further oil passes over with the water (collect 1500–2000 ml. of distillate). The distillate contains the quinoline and some aniline. Extract the oil with ether and distil off the ether.

To remove the aniline present in the residual crude quinoline, advantage is taken of the fact that quinoline chlorozincate $[(C_9H_7N)_2ZnCl_4]H_2$ is almost insoluble in water and crystallises out, whilst, under the same experimental conditions, aniline chlorozincate $[(C_6H_7N)_2ZnCl_4]H_2$ remains in solution (2). Dissolve the crude quinoline in 600 ml. of dilute hydrochloric acid (1 : 4 by volume), warm the solution to 60°, and add a solution of 70 g. of zinc chloride in 120 ml. of dilute hydrochloric acid. The quinoline chlorozincate soon commences to crystallise. Cool the well-stirred mixture thoroughly in ice water, and, when crystallisation is complete, filter with suction, wash well with dilute hydrochloric acid, and drain thoroughly. Transfer the solid to a beaker, add a little water, then 10 per cent. sodium hydroxide solution until the initial precipitate of zinc hydroxide completely redissolves. Extract the quinoline with two 100 ml. portions of ether, and dry the combined extracts with about 5 g. of anhydrous magnesium sulphate. Distil off the ether from a 100 ml. distilling (better, Claisen) flask (Fig. II, 13, 4); replace the water condenser by an air condenser and distil the quinoline, using an air bath (Fig. II, 5, 3). Collect the fraction b.p. 235–238° (mainly 235°). The yield of quinoline (a very pale yellow liquid) is 52 g. To obtain a colourless product, the quinoline should be distilled under reduced pressure: b.p. 118–120°/20 mm.

Notes.

(1) Anhydrous glycerol may be prepared by heating commercial glycerol in a porcelain evaporating dish carefully over a wire gauze (preferably in a fume cupboard), stirring it steadily with a thermometer until the temperature rises to 180°, allowing it to cool to about 100°, pouring it into a Pyrex beaker and transferring the beaker to a large desiccator containing concentrated sulphuric acid. It must be remembered that glycerol is a very hygroscopic substance.

If the approximate water content of commercial glycerol is known, the above dehydration may be avoided by adding sufficient SO_3 in the form of oleum to the concentrated sulphuric acid employed in the Skraup reaction to combine with all the water present.

(2) *An alternative method of removing the aniline* is to add 30 ml. of concentrated sulphuric acid carefully to the steam distillate, cool the solution to 0–5°, and add a concentrated solution of sodium nitrite until a drop of the reaction mixture colours potassium iodide-starch paper a deep blue instantly. As the diazotisation approaches completion, the reaction becomes slow; it will therefore be necessary to test for excess of nitrous acid after an interval of 5 minutes, stirring all the while. About 12 g. of sodium nitrite are usually required. The diazotised solution is then heated on a boiling water bath for an hour (or until active evolution of nitrogen ceases), treated with a solution of 60 g. of sodium hydroxide in 200 ml. of water, the mixture steam-distilled, and the quinoline isolated from the distillate by extraction with ether as above.

COGNATE PREPARATIONS

8-Nitroquinoline. Place a mixture of 69 g. of *o*-nitroaniline, 86 g. of arsenic pentoxide and 184 g. of *anhydrous* glycerol in a 500 ml. three-necked flask, fitted with a glycerine-sealed stirrer, a thermometer, and a reflux condenser. Set the stirrer in motion, heat to 100° (oil bath), and add 220 g. (120 ml.) of concentrated sulphuric acid gradually through the condenser at such a rate that the temperature does not rise above 120° (about 20 minutes). Insert a cotton wool (or calcium chloride) guard tube into the top of the condenser, gradually raise the temperature to 130–135° and maintain this temperature for 7–8 hours. Watch the reaction during the first hour of heating: should the reaction become very vigorous, lower the oil bath momentarily. Allow the contents of the flask to cool and pour into 1500 ml. of water contained in a 2-litre beaker. Add 15 g. of decolourising carbon, stir mechanically, heat at 90° for 1 hour, and filter. Neutralise the cold filtrate slowly with dilute ammonium hydroxide solution (1 : 1), filter off the crude nitro compound at the pump, and wash with a little water. Recrystallise from hot water or from methyl alcohol. The yield of 8-nitroquinoline, m.p. 92°, is 45 g.

8-Hydroxyquinoline ("oxine"). The technique adopted in this preparation is based upon the fact that, in general, the reactants glycerol, amine, nitro compound and sulphuric acid can be mixed with temperature control, and then maintained at any convenient temperature below 120° without any appreciable chemical reaction taking place. A pre-mix of the amine, glycerol and sulphuric acid, maintained at a temperature which keeps it fluid (60–90°), is added in portions to a reaction vessel containing the nitro compound and warmed with stirring to 140–170° at which temperature the Skraup reaction takes place.

Place 170 ml. of concentrated sulphuric acid in a 1-litre three-necked flask provided with a stirrer, and add 112.5 g. of *o*-aminophenol, followed by 287 g. of glycerol: maintain the temperature below 80° by cooling, if necessary. Keep the mixture in a fluid state by placing the flask on a steam bath.

In a 3-litre three-necked flask, fitted with a thermometer, stirrer and reflux condenser, place 72.5 g. of *o*-nitrophenol and 10 g. of crystallised ferrous sulphate, and heat to 100–120°. Add the liquid amine-glycerol-sulphuric acid pre-mix in about 10 portions over 2 hours: allow the reaction to proceed at 135–150° before adding the subsequent portions. Reflux the mixture for a further 4 hours, during which time the temperature drops to about 130°. Neutralise the cooled reaction mixture with sodium hydroxide (250 g. in 50 per cent. solution) with rapid stirring and addition of ice so that the temperature does not rise above 40°. The pH of the resulting solution is about 7, and the 8-hydroxyquinoline together with tarry by-products precipitate. Filter the precipitate at the pump, dry at 50–60°, and then distil under reduced pressure from a Claisen flask with fractionating side arm. A little water passes over first and this is followed by 8-hydroxyquinoline at 100–110°/5 mm. It crystallises on cooling to a white solid, m.p. 74–75°. The yield of "oxine" is 140 g.

V.2.

QUINALDINE

Quinoline derivatives may be synthesised by heating an aromatic amine with an aldehyde or a mixture of aldehydes in the presence of concentrated hydrochloric or sulphuric acid: this synthesis is known as the Doebner - Miller reaction. Thus aniline and paraldehyde afford 2-methylquinoline or quinaldine.

The reaction probably proceeds as follows. Crotonaldehyde is first formed by condensation of the depolymerised acetaldehyde in the presence of acid:



The aniline then reacts with the $\alpha\beta$ -unsaturated aldehyde by 1:4-addition; the addition product, under the influence of strong acid, cyclises to form 1:2-dihydroquinaldine.* The latter is dehydrogenated by the condensation products of aniline with acetaldehyde and with crotonaldehyde simultaneously produced (i.e., ethylideneaniline and crotonylideneaniline): these anils act as hydrogen acceptors and are thereby converted into ethylaniline and *n*-butylaniline respectively.

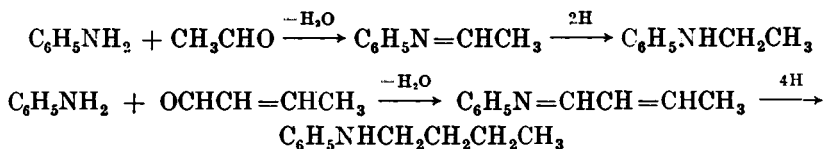
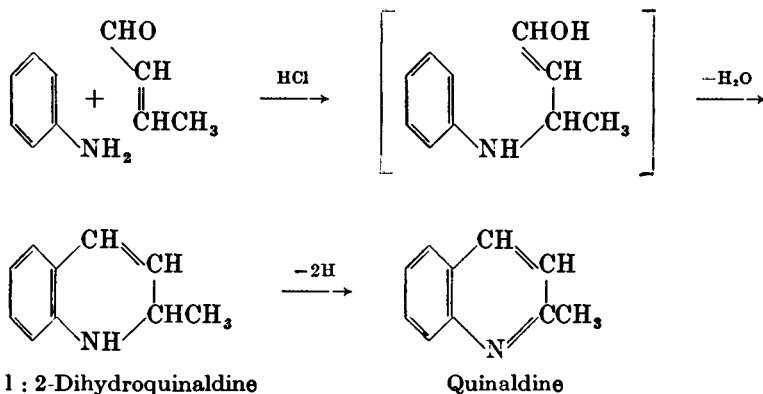

The quinaldine is separated from any unreacted aniline and from the alkylanilines by treatment with acetic anhydride, basified with sodium carbonate and steam distilled. Only the primary and secondary amines are acetylated; the acetylated amines are now much less volatile so that separation from the steam-volatile quinaldine (a tertiary amine) is facile.

In a 1-litre round-bottomed flask, fitted with a condenser and trap (compare Fig. II, 13, 8), place 62 g. (61 ml.) of aniline. Cool the flask in an ice bath, add 120 ml. of concentrated hydrochloric acid slowly, followed by 90 g. of paraldehyde: swirl the contents of the flask to ensure thorough mixing. Remove the flask from the ice bath and shake it frequently at

* The anil of the addition product may be the intermediate just prior to cyclisation which then takes place with the elimination of aniline.

room temperature during 1–2 hours. Heat cautiously to the boiling point : keep an ice-water bath at hand in case the reaction mixture should become unduly vigorous and require moderating. Reflux the mixture for 3 hours and allow to cool. Render alkaline with about 100 ml. of 12*N* sodium hydroxide solution and steam distil the mixture : collect about 2·4 litres of distillate. Separate the upper oily layer and extract the dissolved bases with a little chloroform (or with ether or benzene) and combine the extract with the crude oil. Dry the combined oil and extract with anhydrous magnesium sulphate, remove the solvent, and heat the residue under reflux for 20 minutes with 20 ml. of acetic anhydride. After cooling, render alkaline with sodium carbonate solution and steam distil ; collect about 2·4 litres of distillate. Extract the latter with two 50 ml. portions of benzene. Distil off the benzene from the combined benzene extracts (Fig. II, 13, 4) and distil the residue with the aid of an air bath (Fig. II, 5, 3). Collect the pure quinaldine at 245–248° : the yield is 40 g. Alternatively, distil the quinaldine under reduced pressure ; b.p. 116–118°/12 mm. Keep the colourless liquid in a well-stoppered bottle since it darkens on exposure to air.

V.3. FURFURYL ALCOHOL AND FUROIC ACID

Furfural undergoes the Cannizzaro reaction (compare *Benzaldehyde* Section IV, 123) when treated with sodium hydroxide solution :

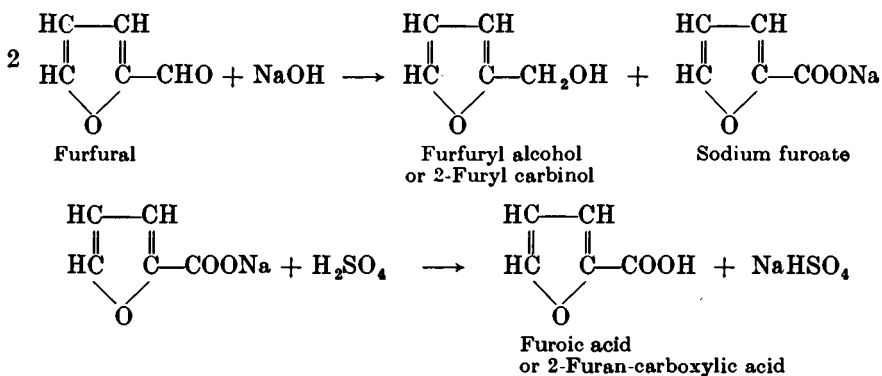

Place 200 g. (172·5 ml.) of redistilled furfural (1) in a 1 litre beaker, provided with a mechanical stirrer and surrounded by an ice bath. Start the stirrer and, when the temperature has fallen to 5–8°, add a solution of 50 g. of sodium hydroxide in 100 ml. of water from a separatory funnel at such a rate that the temperature of the reaction mixture does not rise above 20° (20–25 minutes) ; continue the stirring for a further 1 hour. Much sodium furoate separates during the reaction. Allow to cool to room temperature, and add just enough water to dissolve the precipitate (about 65 ml.). Extract the solution at least five times with 60 ml. portions of ether in order to remove the furfuryl alcohol : the best results are obtained by the use of the continuous extraction apparatus (charged with 350 ml. of ether) depicted in Fig. II, 44, 2. Keep the aqueous layer. Dry the ethereal extract with a little anhydrous

magnesium sulphate, and distil the solution until the temperature of the liquid reaches 95°. Distil the residue under reduced pressure (Fig. II, 20, 1) and collect the furfuryl alcohol (a very pale yellow liquid) at 75–77°/15 mm.; the yield is 65 g. Because of the tendency to undergo polymerisation, add about 1 per cent. of its weight of urea as stabiliser if the furfuryl alcohol is to be stored.

Treat the aqueous solution, containing the sodium furoate, with 40 per cent. sulphuric acid until it is acid to Congo red paper, and cool. Filter off the furoic acid, contaminated with a little sodium hydrogen sulphate, at the pump. Dissolve it in 240 ml. of boiling water, add 12 g. of decolourising carbon, boil the solution for about 45 minutes, filter hot, and cool the filtrate with stirring to 16–20°; below 16°, sodium hydrogen sulphate also separates. Filter off the furoic acid with suction, and dry. The yield is 65 g., m.p. 123–124°. It may be further purified either by recrystallisation from carbon tetrachloride to which a little decolourising carbon is added or by distillation under reduced pressure, b.p. 142–144°/20 mm.; the resulting pure acid softens at 125° and is completely melted at 132°.

Note.

(1) Furfural is best purified by distillation under reduced pressure: b.p. 54–55°/17 mm.

V,4.

2-FURFURALACETONE

Furfural condenses with acetone in the presence of sodium hydroxide solution to yield 2-furfuralacetone (compare *Benzalacetone*, Section IV, 128):

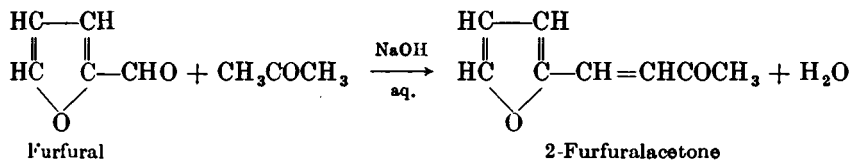

In a 1 litre bolt-head flask, equipped with a mechanical stirrer, mix 75 g. (65 ml.) of redistilled furfural (see *Note 1* to Section V, 3) and 600 ml. of water. Add 100 g. (126 ml.) of A.R. acetone. Stir the mixture, cool to 10°, and add a solution of 5 g. of sodium hydroxide in 10 ml. of water; some heat is generated. Continue the stirring, without cooling, for 4 hours. Then add 10 per cent. sulphuric acid (about 70 ml.) until the mixture is acid to litmus, whereupon the milkiness disappears and the liquid separates out into layers. Separate the lower organic layer, dry it with a little anhydrous magnesium sulphate, and distil under reduced pressure from a Claisen flask with fractionating side arm (Figs. II, 24, 2–5). Collect the furfuralacetone at 114–118°/10 mm.; it solidifies on cooling (m.p. 38–39°) and weighs 65 g. The residue of high boiling point material in the flask contains much difurfuralacetone (compare *Dibenzalacetone*, Section IV, 128).

V.5.

FURYLACRYLIC ACID

Furfural condenses with acetic anhydride and potassium acetate to give furylacrylic acid (compare Perkin reaction, *Cinnamic Acid*, Section IV, 124) :

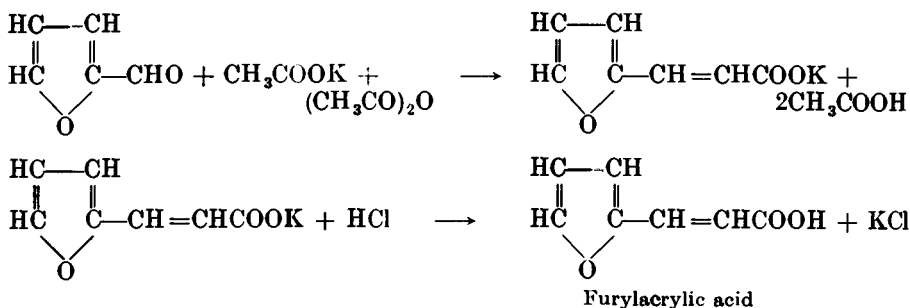

The acid may also be prepared by the condensation of furfural with malonic acid in the presence of pyridine; furylmalonic acid is intermediately formed, which is decomposed upon heating in the presence of the base :

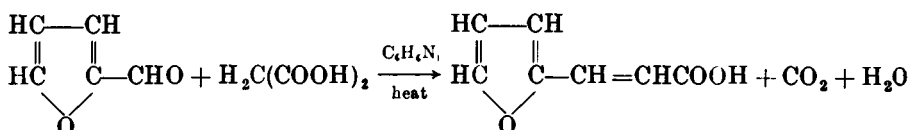

Method 1. Place 48 g. (41.5 ml.) of freshly distilled furfural (see Note 1 to Section V,3), 77 g. (71 ml.) of pure acetic anhydride and 49 g. of dry, powdered, freshly fused potassium acetate in a 500 ml. two- or three-necked flask, provided with a mechanical stirrer and a long air condenser. Heat the flask, with stirring, in an oil bath at 150° (bath temperature) for 4 hours: when the temperature approaches 145–150°, a vigorous exothermic reaction sets in and must be controlled by the application of cold wet towels (or cloths) to the flask in order to avoid too vigorous boiling. Allow to cool slightly, transfer the reaction mixture to a 1 litre round-bottomed flask and add 600 ml. of water: use part of this to rinse out the reaction flask. Boil the mixture with 6 g. of decolourising charcoal for 10 minutes, and filter hot through a pre-heated Buchner funnel into a pre-heated filter flask. Transfer the hot filtrate to a beaker, add dilute hydrochloric acid (1 : 1) until it is acid to Congo red paper, and cool to about 10° with stirring. Allow to stand for at least one hour, filter at the pump, and wash with a little ice water. The yield of crude furylacrylic acid (a light tan solid), m.p. 138–139°, is 41 g. A perfectly pure acid (white solid), m.p. 140°, is obtained by recrystallisation from benzene or light petroleum, b.p. 80–100°, with the addition of a little decolourising carbon; the loss is about 20 per cent.

Method 2. Place 48 g. (41.5 ml.) of freshly-distilled furfural, 52 g. of dry malonic acid (1), and 24 ml. of dry pyridine (2) in a 500 ml. round-bottomed flask, fitted with a reflux condenser. Heat the flask on a boiling water bath for 2 hours, cool the reaction mixture and dilute with 50 ml. of water. Dissolve the acid by the addition of concentrated ammonia solution, filter the solution and wash the filter paper with a

little water. Add dilute hydrochloric acid (1 : 1), with stirring, to the combined filtrate and washings until acid to Congo red paper, and cool in an ice bath for at least one hour. Filter the furylacrylic acid and wash it with a little ice water ; it weighs 63 g. after drying and melts at 139–140°. A purer acid may be obtained by recrystallisation as in *Method 1*.

Notes.

(1) Commercial malonic acid is dried at 90–100° for 2 hours.

(2) The pyridine is dried by allowing it to stand, with frequent shaking, over potassium hydroxide pellets and then filtering.

V.6.

FUROIN

Furfural undergoes condensation to furoin under the catalytic influence of cyanide ions in aqueous alcohol solution (compare *Benzoin*, Section IV,125) :

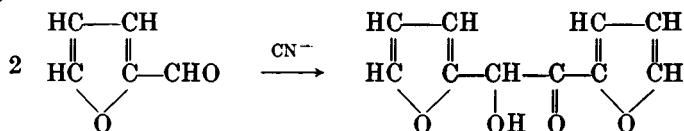

In a 1 litre three-necked flask, equipped with a mechanical stirrer, a reflux condenser and a separatory funnel, place 400 ml. of water, 200 g. (172.5 ml.) of freshly distilled furfural (see Section V,3, *Note 1*) and 150 ml. of rectified spirit. Heat the reaction mixture to boiling, remove the flame and, when the liquid has just ceased to boil, add with stirring a solution of 10 g. of potassium cyanide in 30 ml. of water from the separatory funnel as rapidly as the vigour of the reaction permits. When the ebullition subsides (exothermic reaction), heat to boiling for a further 5 minutes. Acidify the reaction mixture with glacial acetic acid (use litmus paper) and allow to cool overnight, preferably in an ice chest or a refrigerator. Filter off the dark crystals at the pump, wash with cold water, and then with cold methyl alcohol to remove as much of the tar (colouring matter) as possible. Recrystallise from methyl alcohol with the addition of about 10 g. of decolourising carbon. The yield of furoin, m.p. 135–136°, is 75 g. If the m.p. is slightly low, another recrystallisation from toluene - ethyl alcohol will give satisfactory results.

V.7.

FURIL

Furoin is conveniently oxidised by a copper sulphate - pyridine mixture to furil.

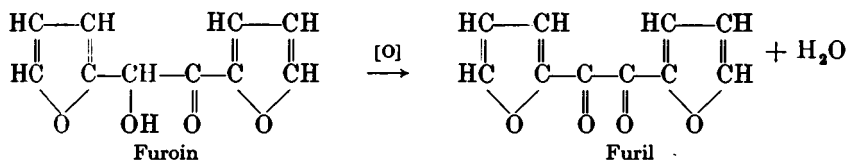

Mount a 1 litre bolt-head flask, fitted with a mechanical stirrer, on a water bath. Place 158 g. of powdered copper sulphate pentahydrate, 210 g. (214 ml.) of pyridine and 90 ml. of water in the flask, start the

stirrer, and heat the mixture on the water bath until it is homogeneous. Add 57.5 g. of powdered fuoin (Section V,6). Stir and heat the mixture for 2 hours: the colour changes from a deep blue to a deep green with a brownish tinge after a short time. Pour the reaction mixture into 1 litre of water (1), filter the solid with suction, and wash it with water until the washings are colourless. Wash the black residue with 500 ml. of cold methyl alcohol, and recrystallise from methyl alcohol to which 25 g. of decolourising carbon has been added (2). The yield of furil (yellow needles), m.p. 165–166°, is 36 g.

Notes.

(1) If preferred, the reaction mixture may be cooled, and the crude furil filtered through a sintered glass funnel. The filtrate (containing the copper sulphate-pyridine mixture) is re-oxidised by passing oxygen through it for about 15 hours. An excellent alternative method of preparation is provided by suitable adaptation of Section IV,126, *Method 2*.

(2) Benzene is an alternative solvent.

V,8. 2-METHYLTHIOPHENE

Dry distillation of sodium laevulinate (I) with phosphorus sulphide gives 2-methylthiophene (II) as the main product:

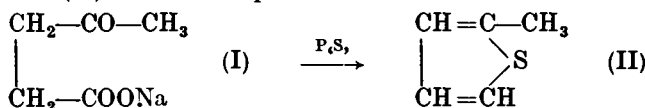

Mix intimately in a mortar 100 g. of sodium laevulinate, 250 g. of phosphorus sulphide (1) and 50 g. of clean dry sand. Place the mixture in a flask fitted with a condenser for distillation and a receiver (2). Heat the flask with a free flame until the reaction commences, and then remove the flame. When the reaction subsides, continue the heating until distillation ceases. Wash the distillate with 10 per cent. sodium hydroxide solution to remove acidic by-products and steam distil. Separate the crude 2-methylthiophene from the steam distillate, dry over anhydrous calcium sulphate, and distil from a little sodium. Collect the pure compound at 113°; the yield is 30 g.

Notes.

(1) Commercial "phosphorus trisulphide" is largely P_4S_7 . Phosphorus heptasulphide is available *inter alia* from the Oldbury Electrochemical Company.

(2) A slightly improved yield is obtained by conducting the dry distillation in a stream of carbon dioxide.

V,9. 2 : 5-DIMETHYLTHIOPHENE

2 : 5-Dimethylthiophene (II) is readily prepared by interaction of phosphorus sulphide and acetylacetone (I):

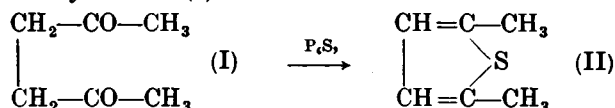

To 125 g. of finely powdered phosphorus sulphide (1) contained in a 500 ml. round-bottomed flask fitted with a reflux condenser, add 60 g. (62 ml.) of redistilled acetylacetone (2). Heat cautiously at first until

a spontaneous reaction sets in: when the reaction is over, heat under reflux for 15 minutes. Arrange the condenser for distillation and distil until crystals commence to form in the condenser. Wash the distillate successively with 10 per cent. sodium hydroxide solution and water, dry over anhydrous calcium sulphate, and distil. Collect the 2:5-dimethylthiophene at 135–136°. The yield is 42 g.

Notes.

(1) See Note 1 in Section V,8.

(2) Acetylacetone is available commercially as a by-product of the manufacture of acetic acid from acetylene. It may be prepared by condensation of chloroacetone with ethyl sodioacetoacetate; the resulting ethyl acetylacetoacetate when heated with water under pressure at 160° undergoes ketonic scission to give acetylacetone.

V,10.

2-ACETYLTHIOPHENE

2-Acetylthiophene is prepared by the acetylation of thiophene with acetic anhydride in the presence of orthophosphoric acid:

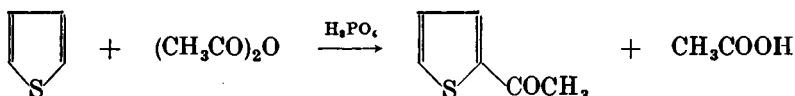

Place 84 g. (79 ml.) of thiophene and 58 g. (54 ml.) of acetic anhydride in a 500 ml. three-necked flask, fitted with a thermometer, mechanical stirrer and reflux condenser. Heat the stirred solution to 70–75°, remove the source of heat, and add 5 g. (6 ml.) of 85–89 per cent. orthophosphoric acid. An exothermic reaction occurs after 2–3 minutes and the temperature may rise to 90°; immerse the flask in a bath of cold water to control the reaction. When the boiling subsides (*ca.* 5 minutes), reflux the mixture for 2 hours. Add 125 ml. of water, stir for 5 minutes, transfer the cold reaction mixture to a separatory funnel, remove the water layer, wash with two 50 ml. portions of 5 per cent. sodium carbonate solution, and dry over anhydrous magnesium sulphate. Distil the orange-red liquid through a short fractionating column (or from a Claisen flask with fractionating side arm, Figs. II, 24, 3–5) at atmospheric pressure and thus recover 38 g. of unchanged thiophene at 83–84°. Distil the residue under reduced pressure and collect the 2-acetylthiophene at 89–90°/10 mm.; this solidifies on cooling in ice, m.p. 10°. The yield is 50 g.

V,11.

PYRROLE

Pyrrrole is obtained by distilling the ammonium salt of mucic acid, preferably in the presence of glycerol which leads to an improved yield:

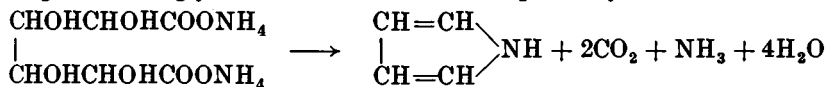

Pyrolysis of the methylamine salt (produced by neutralising mucic acid with aqueous methylamine) in the presence of glycerol yields *N*-methylpyrrole:

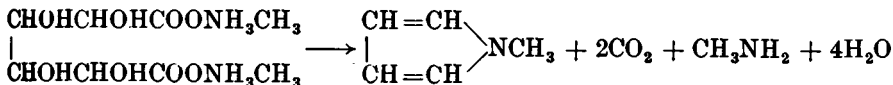

Place 210 g. of mucic acid (Section III,138) and 300 ml. of concentrated ammonia solution (sp. gr. 0.88) in a large evaporating dish and rapidly stir the mixture to a smooth paste (*FUME CUPBOARD!*). Evaporate the paste to dryness on a water bath, powder the resulting ammonium mucate and mix it with 120 ml. of glycerol in a 2-litre round-bottomed Pyrex flask. Allow to stand overnight. Arrange for distillation with a filter or distilling flask as receiver; connect the latter to a gas trap (Fig. II, 8, 1, c). Distil the mixture carefully with a free flame. Apply the heat initially to one side of the flask so that only a portion of the mass is heated to the reaction temperature: considerable frothing ensues and this must be controlled by removing the flame from below the flask and heating the upper portion of the vessel above the surface of the boiling mixture. Extend the heating as rapidly as possible throughout the mass with due regard to the control of the foaming. Continue the distillation until a sample of the distillate no longer gives oily drops when treated with solid potassium hydroxide; the total volume of distillate is 300–350 ml. Redistil the distillate until no further oil separates in the liquid which passes over. Separate the oil, dry it *rapidly* with potassium hydroxide pellets, and distil. Collect the pyrrole (a colourless liquid) at 127–131°: the yield is 25 g. The pyrrole should be stored in a sealed vessel; it darkens upon exposure to light.

COGNATE PREPARATION

N-Methylpyrrole. Prepare the methylamine salt of mucic acid by adding slowly and with vigorous stirring 260 ml. of 10*N* aqueous methylamine to 210 g. of mucic acid; if difficulty is experienced in stirring the mixture, add up to 100 ml. of water. Complete the preparation following the experimental conditions given above for *Pyrrole*. The yield of *N*-methylpyrrole, b.p. 110–113°, is 32 g. The compound is very hygroscopic and darkens on standing; keep it in a tightly-stoppered, brown bottle.

V,12

2 : 5-DIMETHYLPYRROLE

2 : 5-Dimethylpyrrole (II) is obtained by heating acetylacetone (I) with ammonium carbonate at 100°:

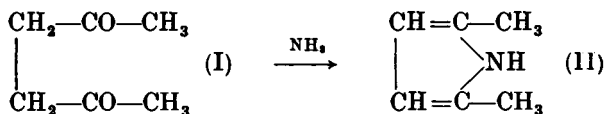

In a 250 ml. conical flask, fitted with an air condenser of wide bore, place 50 g. (51.5 ml.) of acetylacetone (see Section V,9, *Note 2*) and 100 g. of ammonium carbonate (lump form). Heat the mixture in an oil bath at 100° until effervescence stops (60–90 minutes); some ammonium carbonate (or carbamate) sublimes into the condenser and this must be pushed back into the reaction mixture by means of a stout glass rod. Replace the air condenser by a Liebig's condenser with wide bore inner tube and reflux the mixture gently (bath temperature, 115°) for a further 30 minutes; dissolve the solid which has sublimed into the condenser in about 5 ml. of hot water and return the solution to the reaction mixture.

V,14.

SUCCINIMIDE

The thermal decomposition of ammonium succinate gives a good yield of succinimide :

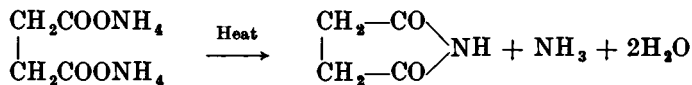

In a 250 ml. distilling flask, fitted with an air condenser 40 cm. long and 10 mm. in diameter, place 59 g. of succinic acid, and add slowly, with cooling and shaking, 70 ml. of concentrated ammonia solution, sp. gr. 0.88. Most of the acid dissolves forming a clear solution ; insert a thermometer into the mouth of the flask. Attach a 150 ml. distilling flask to the lower end of the air condenser and support it in a large funnel so that it may be water-cooled ; attach the side arm of the distilling flask receiver to a device for the absorption of ammonia (*e.g.*, Fig. II, 8, 1, c). Heat the mixture gently with a free flame ; the temperature soon rises to 100° and remains at this point until about 50 ml. of water has passed over. Then heat more strongly : the ammonium succinate commences to decompose with evolution of ammonia and the temperature falls to about 97° during the distillation of the next 7 ml. When the temperature rises to 102°, change the receiver and collect an intermediate fraction from 102° to 275°. Change the receiver again and collect the succinimide at 275–290° (largely 285–289°) ; stop the distillation when the tarry residue begins to decompose with the evolution of yellow fumes. The crude succinimide solidifies completely and weighs 42 g. Recrystallise from rectified spirit (1 ml. per gram of solid), cool the solution to 0° for some hours, filter the crystals at the pump, and wash them with 6 ml. of ice-cold alcohol. The yield of pure succinimide, m.p. 124–125°, is 39 g.

V,15.

2-AMINOTHIAZOLE

2-Aminothiazole (III) is prepared by the condensation of chloroacetaldehyde (II) with thiourea (I). The reaction may be represented as follows :

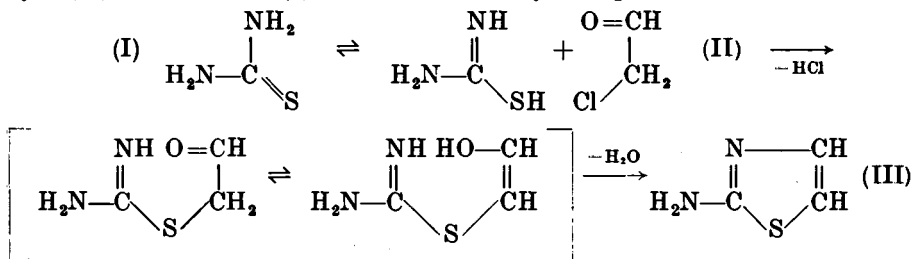

Chloroacetaldehyde is unstable and lachrymatory : it is therefore usually generated *in situ* by the action of water upon $\alpha\beta$ -dichloroethyl ether :

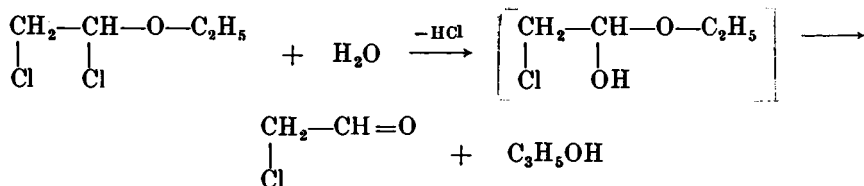

$\alpha\beta$ -Dichloroethyl ethyl ether is obtained commercially by the chlorination of diethyl ether.

Monochloroacetone and thiourea yield 2-amino-5-methylthiazole.

Place a solution of 76 g. of thiourea in 200 ml. of warm water in a 500 ml. three-necked flask equipped with a dropping funnel, sealed mechanical stirrer and reflux condenser. Add 143 g. (122 ml.) of $\alpha\beta$ -dichloroethyl ethyl ether and heat the mixture under gentle reflux with stirring for 2 hours. As the reaction proceeds, the two layers gradually merge. To the cold solution add sufficient solid sodium hydroxide to liberate the 2-aminothiazole from its salt. Add ether to dissolve the product, dry the ethereal extract with anhydrous magnesium sulphate, and evaporate the ether. Recrystallise the crude 2-aminothiazole from ethanol; the resulting yellow crystalline solid has m.p. 90°. The yield is 80 g.

COGNATE PREPARATION

2-Amino-5-methylthiazole. Suspend 76 g. of thiourea in 200 ml. of water in a 500 ml. three-necked flask equipped as in the preceding preparation. Stir and add 92.5 g. (80 ml.) of monochloroacetone (1) over a period of 30 minutes. The thiourea dissolves as the reaction proceeds and the temperature rises. Reflux the yellow solution for 2 hours. To the cold solution immersed in an ice bath add, with stirring, 200 g. of solid sodium hydroxide. Transfer to a separatory funnel, add a little ice water, separate the upper oil layer and extract the aqueous layer with three 100 ml. portions of ether. Dry the combined oil and ether extracts with anhydrous magnesium sulphate, remove the ether by distillation from a steam bath, and distil the residual oil under diminished pressure. Collect the 2-amino-5-methylthiazole at 130–133°/18 mm.; it solidifies on cooling in ice to a solid, m.p. 44–45°. The yield is 84 g.

Note.

(1) Redistilled commercial chloroacetone, b.p. 118–120°, is used. The compound is lachrymatory. It is prepared *inter alia* by the chlorination of acetone in the cold.

V,16.

2:4-DIMETHYLTHIAZOLE

2:4-Dimethylthiazole (III) may be prepared from thioacetamide (I) and monochloroacetone (II). The thioacetamide is conveniently formed in the reaction mixture from acetamide and phosphorus pentasulphide.

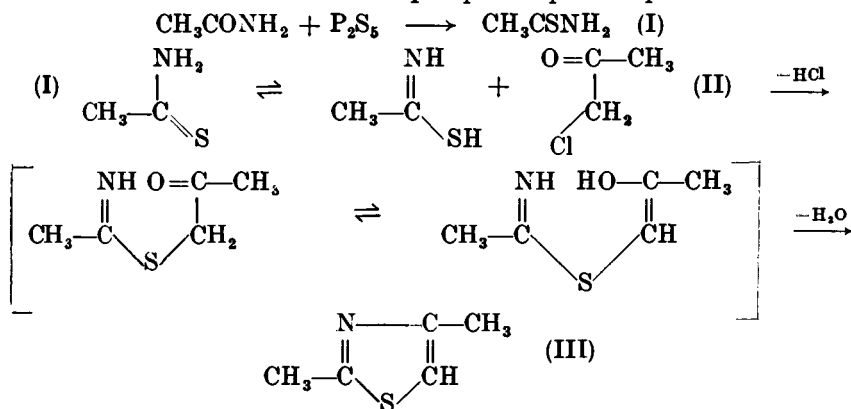

Equip a 1-litre round-bottomed flask with a reflux condenser and a dropping funnel (compare Figs. II, 13, 9 and III, 71, 1). Prepare a mixture of 150 g. of finely powdered acetamide and 100 g. of powdered phosphorus pentasulphide quickly, transfer it rapidly into the flask and immediately add 100 ml. of dry benzene. Set up the apparatus in a fume cupboard. Prepare a mixture of chloroacetone (b.p. 118–120°: *CAUTION*—the compound is lachrymatory) and 75 ml. of dry benzene; place it in the dropping funnel and insert a calcium chloride drying tube in the mouth. Add about 10 ml. of the chloroacetone-benzene mixture to the contents of the flask and warm gently on a water bath: remove the water bath immediately the exothermic reaction commences. Introduce the remainder of the chloroacetone in *ca.* 10 ml. portions at such intervals that the reaction is under control. When all the chloroacetone has been added, reflux the mixture on a water bath for 30 minutes. Then add 400 ml. of water to the reaction mixture with shaking; after 20 minutes, transfer the contents of the flask to a separatory funnel, run off the lower layer into a beaker and discard the reddish upper layer containing the benzene. Make the lower layer alkaline by the addition of 20 per cent. sodium hydroxide solution: test the highly coloured aqueous solution (and not the dark dimethylthiazole floating on top of the liquid) with phenolphthalein paper. Separate the black upper layer of crude dimethylthiazole with 50 ml. of ether, and extract the aqueous layer with five 60 ml. portions of ether. Dry the combined ethereal extracts over anhydrous magnesium sulphate, and filter through glass wool. Remove the ether by distillation from a steam bath using a Claisen flask with fractionating side arm (compare Fig. II, 13, 4; insert a calcium chloride drying tube into the dropping funnel since the thiazole is hygroscopic) and fractionate the residue. Collect the fraction boiling at 140–150° and redistil it. The yield of 2:4-dimethylthiazole, b.p. 143–145°, is 115 g.

V,17

3:5-DIMETHYLPYRAZOLE

3:5-Dimethylpyrazole (III) may be prepared from acetylacetone (I) and hydrazine (II) (produced from hydrazine sulphate and aqueous alkali). The reaction may be represented as:

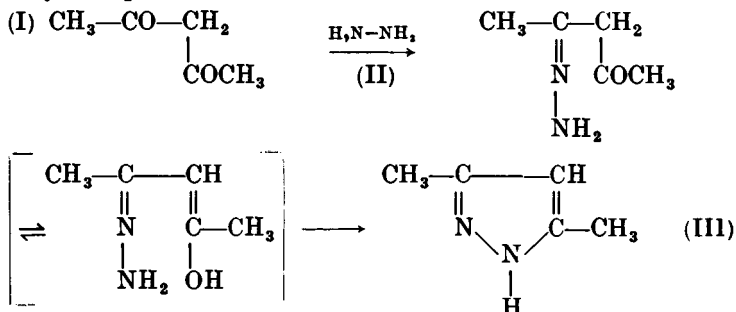

Dissolve 65 g. of hydrazine sulphate in 400 ml. of 2.5*N* sodium hydroxide solution contained in a 1-litre three-necked flask, equipped with a thermometer, mechanical stirrer and dropping funnel. Immerse the flask in an ice bath and when the temperature reaches 15° (some sodium sulphate

may separate at this point), add 50 g. (51.5 ml.) of acetylacetone (Section VI,1) dropwise, with stirring, whilst maintaining the temperature at 15°. When the addition is complete (after about 30 minutes), stir for 1 hour at 15°; the dimethylpyrazole separates during this period. Add 200 ml. of water, stir to dissolve inorganic salts, transfer the contents of the flask to a separatory funnel and shake with 100 ml. of ether. Separate the layers and extract the aqueous layer with four 40 ml. portions of ether. Wash the combined ethereal extracts with saturated sodium chloride solution, dry over anhydrous potassium carbonate, remove the ether by distillation from a steam bath, and dry the residual pale yellow, crystalline 3 : 5-dimethylpyrazole under reduced pressure (*ca.* 20 mm.). The yield of solid, m.p. 107–108°, is 38 g. Recrystallise from about 250 ml. of light petroleum, b.p. 80–100°, and dry in a vacuum desiccator containing paraffin wax shavings: the yield of 3 : 5-dimethylpyrazole, of unchanged m.p., is 36 g.

V,18.

5 : 5-DIMETHYLHYDANTOIN

Hydantoin with one or two substituents in the 5-position may be obtained by heating cyanohydrins with ammonium carbonate or with urea. Thus:

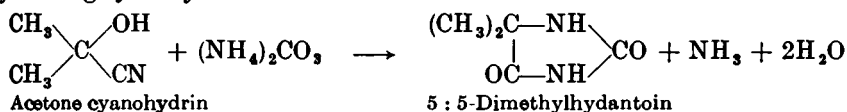

The above reaction is an example of Bucherer's hydantoin synthesis. The following *mechanism* has been proposed:

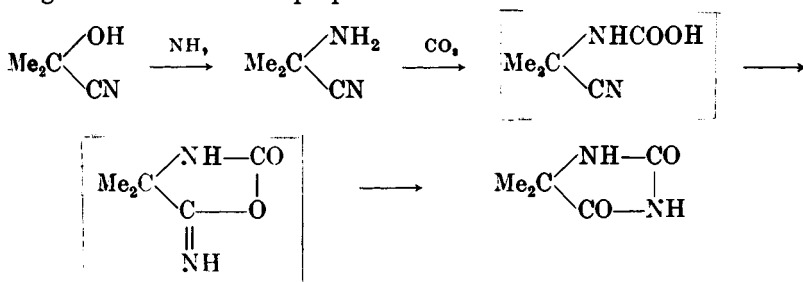

Mix 42.5 g. of acetone cyanohydrin (Section III,75) and 75 g. of freshly powdered ammonium carbonate in a small beaker, warm the mixture on a water bath (*FUME CUPBOARD*) and stir with a thermometer. Gentle action commences at 50° and continues during about 3 hours at 70–80°. To complete the reaction, raise the temperature to 90° and maintain it at this point until the mixture is quiescent (*ca.* 30 minutes). The colourless (or pale yellow) residue solidifies on cooling. Dissolve it in 50 ml. of hot water, digest with a little decolourising carbon, and filter rapidly through a pre-heated Buchner funnel. Evaporate the filtrate on a hot plate until crystals appear on the surface of the liquid, and then cool in ice. Filter off the white crystals with suction, drain well, and then wash twice with 4 ml. portions of ether; this crop of crystals of dimethylhydantoin is almost pure and melts at 176°. Concentrate the mother liquor to the crystallisation point, cool in ice, and collect the

second crop of crystals (m.p. *ca.* 167°) as before. Dissolve the dimethylhydantoin (35 g.) in the minimum volume of boiling water (about 32 ml.), digest with a little decolourising carbon, and filter the hot solution through a pre-heated Buchner funnel. Cool the filtrate in ice, filter the separated crystals at the pump and wash sparingly with cold water. The yield of pure product, m.p. 178°, is 29 g.

V,19. 4-ETHYLPYRIDINE (from Pyridine)

When pyridine is treated with zinc dust and acetic anhydride, a type of reductive coupling occurs and the product is diacetyltetrahydrodipyridyl (I); this undergoes a curious change on heating yielding pyridine and a new diacetyl compound, 1 : 4-diacetyl-1 : 4-dihydropyridine (II). The latter is reduced by zinc and acetic acid to 4-ethylpyridine (III).

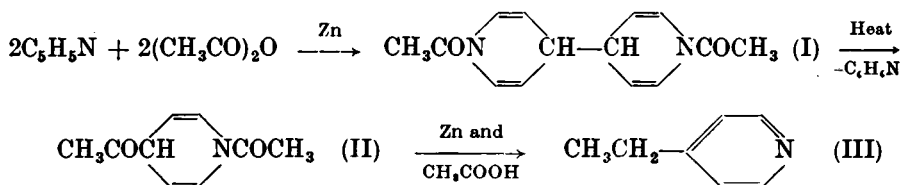

Other 4-alkylated pyridines may be prepared by the use of the appropriate anhydride.

Place a mixture of 500 ml. of acetic anhydride and 100 g. (102 ml.) of dry pyridine (Section II,47,22) in a 2-litre three-necked flask fitted with a reflux condenser, mercury-sealed stirrer and thermometer. Introduce, with stirring, 100 g. of activated zinc powder (1) in 5 g. portions over a period of 1.5–2 hours; remove the thermometer or reflux condenser momentarily as required. The temperature rises almost immediately: maintain it at 25–30° by means of a bath of cold water. The reaction mixture acquires a green colour after 20 minutes and a yellow solid separates gradually. When the addition of the 100 g. of zinc powder is complete, stir for a further 15 minutes, and run in 100 ml. of glacial acetic acid through the condenser. Add a further 40 g. of zinc powder in 5–10 g. portions at intervals so timed that the vigorous reaction is under control and the mixture refluxes gently. Then reflux the reaction mixture, with stirring, for 30 minutes: add a further 60 g. of zinc powder all at once and continue the refluxing for 30 minutes more.

Neutralise the cold contents of the flask with 500–600 ml. of 40 per cent. aqueous sodium hydroxide solution, equip the flask for steam distillation and steam distil until about 1 litre of distillate is collected. The steam distillate separates into two layers. Add solid sodium hydroxide (< 100 g.) to complete the separation of the two layers as far as possible. Remove the upper (organic) layer and extract the aqueous layer with three 50 ml. portions of chloroform. Dry the combined organic layer and chloroform extracts with anhydrous potassium carbonate and distil the mixture through a short fractionating column (*e.g.*, an 8" Dufton column): after a fore-run of chloroform, followed by pyridine, collect the crude 4-ethylpyridine at 150–166° (49 g.). Redistil through a Fenske

type column, 15 mm. in diameter and packed with glass helices for a length of 20 cm. (compare Fig. II, 24, 5): collect the pure base at 163–165°/760 mm. (44 g.).

Note.

(1) Activate the zinc by stirring 400 g. of zinc powder with 150 ml. of 10 per cent. hydrochloric acid for 2 minutes, filter and wash with 300 ml. of water, followed by 100 ml. of acetone.

V,20. *n*-AMYL PYRIDINES (from Picolines)

The three picolines react with alkyl halides in liquid ammonia solution in the presence of sodamide to yield the corresponding monoalkylpyridines. α -Picoline also reacts with alkyl chlorides in the presence of sodamide either alone or in the presence of xylene to give a fair yield of monoalkylpyridine $C_5H_4N \cdot CH_2R$. With γ -picoline under similar experimental conditions disubstitution of the alkyl group ($C_5H_4N \cdot CHR_2$) occurs to an appreciable extent. The preparation of the three *n*-amylpyridines is described: the 3- and 4-compounds by the liquid ammonia-sodamide method and the 2-compound by the sodamide-xylene procedure.

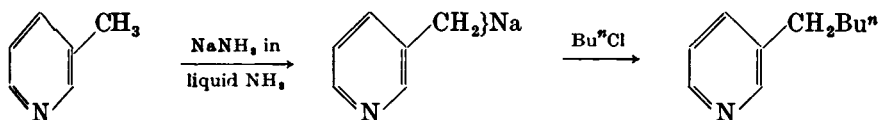

2-*n*-Amylpyridine. Into a 500 ml. three-necked flask (fitted with a dropping funnel, mercury-sealed stirrer and reflux condenser protected by a drying tube) place a finely divided suspension (1) of 40 g. of recently prepared sodamide* in about 150 ml. of anhydrous xylene. Introduce 37.5 g. (40 ml.) of α -picoline (Section II, 47, 28) through the dropping funnel and rinse the latter with a few ml. of dry xylene. Set the stirrer in motion and add 44.5 g. (50.5 ml.) of *n*-butyl chloride over a period of 1 hour: reflux the mixture with stirring for 2–3 hours. When cold, destroy the excess of sodamide by the cautious addition of 100 ml. of water. Transfer the contents of the flask to a separatory funnel and discard the lower aqueous layer. Extract the xylene solution with four 50 ml. portions of 1:1-hydrochloric acid. Steam distil the acid extracts to remove traces of xylene, cool the aqueous solution and render strongly alkaline by the addition of solid sodium hydroxide: a brown oil appears. Steam distil again and collect about 700 ml. of distillate. Separate the upper layer in the steam distillate, extract the aqueous layer with ether, and dry the combined upper layer and ether extract with anhydrous potassium carbonate. After removing the ether, distil through a Fenske-type column (15 cm. diameter and packed with glass helices for a length of 12–15 cm.; compare Fig. II, 24, 5) at a pressure of 50 mm. (see Fig. II, 23, 7), and collect the 2-*n*-amylpyridine (42 g.) at 122.5–124.5°/50 mm. Upon redistillation, the product boils almost entirely at 105°/17 mm.

* See Section II.50,3. The commercial product, obtained soon after its preparation from the manufacturers, is satisfactory.

Note.

(1) The finely divided sodamide may be prepared with xylene as the medium in an improvised *ball mill*. The latter is constructed from a pair of rubber rollers, suitably mounted on a board and driven by a geared-down electric motor which is controlled by a Variac transformer. The 40 g. of recently prepared sodamide is placed with 60–100 ml. of dry xylene and 12–16 porcelain spheres of $\frac{1}{4}$ " diameter in a 500 ml. bottle: the bottle is closed by a cork covered with tin foil and carrying a soda-lime guard tube. Three rubber bands are placed round the bottle to prevent slipping between the bottle and the rubber rollers. The rollers are rotated at a rate of about 1 revolution per second for about 90 minutes by which time the sodamide is almost colloidal. The liquid is then poured through a slit sieve glass funnel directly into the 500 ml. three-necked flask; the bottle is rinsed with two 25 ml. portions of dry xylene and the rinsings transferred to the flask.

4-*n*-Amylpyridine. Charge a 1-litre three-necked flask (equipped with a mercury-sealed stirrer, a dropping funnel and a short air condenser) with 600 ml. of liquid ammonia: support the flask inside a 5-litre beaker (*FUME CUPBOARD* with efficient draught!). Stir vigorously, add 0.5 g. of powdered ferric nitrate followed, after 1 minute, by 11.9 g. of clean sodium in small pieces through the short air condenser over a period of half an hour (1). Continue the stirring until the initial blue colour is replaced by a colourless or pale grey suspension of sodamide (2). Now introduce 42.0 g. (44.0 ml.) of pure γ -picoline (Section II,47,30) through the air condenser; a green colour develops immediately. Stir for 15–20 minutes and add 46.3 g. (52.6 ml.) of *n*-butyl chloride (or an equivalent amount of *n*-butyl bromide) from the dropping funnel at such a rate that the reaction does not become unduly vigorous (*ca.* 10 minutes): upon completion of the addition the green colour will have been discharged. Stir for a further 10–15 minutes, pour the reaction mixture into a 2-litre beaker: allow the liquid ammonia to evaporate overnight. Rinse the reaction flask with 100 ml. of water and add the rinsings to the residue in the beaker; two layers form. Separate them and keep the upper layer of base: extract the lower layer with a little xylene and wash the xylene extract with 25 ml. of 1:1-hydrochloric acid. Dissolve the base in 1:1-hydrochloric acid, combine it with the acid washings of the xylene extract and steam distil to remove traces of xylene; cool, add solid sodium hydroxide until strongly alkaline and steam distil again. Isolate the 4-*n*-amylpyridine as described above for the 2-*n*-amyl compound. The yield of the pure base, b.p. 95°/6 mm., is 46 g.

Notes.

(1) If the sodium is added too rapidly, the ammonia will boil vigorously and considerable loss of solvent may result.

(2) It is recommended that the outside of the flask be sprayed occasionally with alcohol in order to prevent "misting": if a small lamp is placed behind the apparatus, the colour of the liquid in the flask may be seen easily.

If much liquid ammonia is lost during the preparation of the sodamide, the volume should be made up to 500–600 ml. before adding the γ -picoline.

3-*n*-Amylpyridine. Proceed exactly as described for 4-*n*-Amylpyridine using 11.9 g. of sodium, 42 g. of β -picoline (Section II,47,29) and 46.3 g. of *n*-butyl chloride. The yield of pure 3-*n*-amylpyridine, b.p. 100.5°/9 mm., is 46 g.

V.21.

PICOLINIC ACID

Picolinic acid is readily prepared by the oxidation of α -picoline with potassium permanganate :

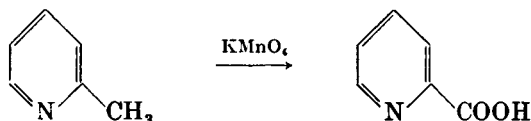

Equip a 3-litre three-necked flask with a thermometer, mercury-sealed stirrer and a reflux condenser (Liebig pattern with a wide inner tube). Place a solution of 100 g. (106 ml.) of α -picoline (1) in 1 litre of water in the flask and heat to 70° on a water bath. Add 450 g. of potassium permanganate in 10 equal portions through the condenser over a period of 3–4 hours ; maintain the temperature at 70° for the first five additions and at 85 – 90° for the last five. Make each successive addition of potassium permanganate only after the preceding amount is decolourised and wash it down with 20–25 ml. of water. After the last charge of potassium permanganate is decolourised, raise the temperature to 95° , filter the hot reaction mixture with suction and wash the manganese dioxide cake on the filter with four 200 ml. portions of hot water : allow each portion to soak into the cake without application of vacuum and finally suck dry before adding fresh wash water. Evaporate down the combined filtrate and washings to a volume of about 400 ml. : allow to cool and adjust to a pH of 3.2 (the isoelectric point) using B.D.H. narrow-range indicator paper (about 125 ml. of concentrated hydrochloric acid are required). Picolinic acid is very soluble in water (90 g. in 100 ml. of water at 9°) and therefore does not separate at this stage. The water is best removed by azeotropic distillation with benzene, a solvent which simultaneously extracts the picolinic acid.

Fit the 3-litre three-necked flask used in the original oxidation with a thermometer, a glycerine-sealed stirrer (Fig. II, 7, 10), and a large automatic water separator (ca. 200 ml. capacity ; see Fig. III, 126, 1) surmounted by a double surface reflux condenser. Support a small funnel upon three indentations immediately above the side tube of the water-separator ; its stem should be well below the side tube so that liquid falling from the condenser cannot splash over into the flask. Transfer the solution to the flask and add 1500 ml. of benzene : heat on a water bath at 90° and stir vigorously. Continue the refluxing and stirring until no more water collects in the trap (about 12 hours). Filter the hot benzene solution through a hot water funnel and evaporate to dryness on a boiling water bath. Evaporation is best carried out under reduced pressure (water pump) since this leads to an almost colourless acid and most of the benzene is recovered ; the apparatus may consist of a 2-litre bolt-head flask, still head, double surface condenser and receiver. Return the recovered benzene to the extraction flask, stir and extract the residual solid at the temperature of a boiling water bath for a further 2 hours : evaporate the benzene extract under reduced pressure and thus obtain a second crop of picolinic acid. Carry out a third extraction with the benzene recovered

from the second extraction and thus isolate a further quantity of acid. The yields of picolinic acid, m.p. 138°, from the three extractions are 49 g., 32 g., and 3 g. respectively, *i.e.*, a total yield of 84 g. The m.p. is unaffected by recrystallisation from ethanol.

Note.

(1) Carefully fractionate the commercially "pure" α -picoline (purity > 95 per cent.) and collect the fraction of b.p. 129–130°. If time permits, this should be purified as described in Section II,47,28; a pure acid is thus assured.

V,22.

NICOTINIC ACID

Nicotinic acid is prepared in good yield by the oxidation of β -picoline with potassium permanganate:

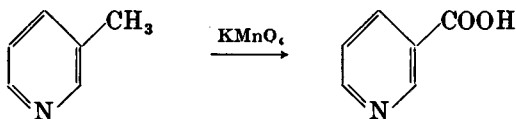

Dissolve 100 g. (104.5 ml.) of purified β -picoline (Section II,47,29) in 1 litre of water and oxidise it with 450 g. of potassium permanganate: follow the experimental details given under *Picolinic Acid* (preceding Section). Wash the manganese dioxide cake with four 500 ml. portions of water; evaporate the combined filtrate and washings to about 1250 ml. Adjust the pH to 3.4 (the isoelectric point) with the aid of B.D.H. narrow-range indicator paper; 120–130 ml. of concentrated hydrochloric acid are required. Allow to cool overnight, collect the voluminous precipitate of nicotinic acid by suction filtration, wash with three 50 ml. portions of cold water, and dry at 90–100°. Concentrate the filtrate to about 650 ml. and cool *slowly* to 5° and so obtain a second crop of nicotinic acid: the purpose of the slow cooling is to reduce the contamination by potassium chloride. The first crop of acid weighs 90 g. and has a purity of about 90 per cent. (1); the second crop weighs 10 g. and the purity is about 80 per cent. Recrystallise from hot water (2) and dry at 100°; the yield of pure nicotinic acid, m.p. 235°, from 90 g. of the crude acid is 67 g. A further quantity may be obtained by concentrating the mother liquor.

Notes.

(1) The impurity is potassium chloride. The approximate acid content is determined by heating a weighed sample of the acid in a crucible gently at first and finally at a red heat until no trace of black residue remains, and weighing the white residual potassium chloride.

(2) The solubility of pure nicotinic acid in 1000 ml. of water at 0°, 40°, 80° and 100° is 1.0, 2.6, 8.2 and 12.7 g. respectively.

COGNATE PREPARATION

*iso*Nicotinic acid (*pyridine-4-carboxylic acid*). This acid is prepared by oxidation of γ -picoline by potassium permanganate. Use 100 g. (104.5 ml.) of purified γ -picoline (Section II,47,30) and oxidise it with 450 g. of potassium permanganate: follow the experimental details given for *Nicotinic Acid*. Evaporate the combined filtrate and washings to about 1500 ml., and add concentrated hydrochloric acid until the pH is 3.6; *isonicotinic*

acid precipitates. Heat to 90–95° (not all the acid dissolves) and allow the mixture to crystallise slowly. Collect the crude *isonicotinic* acid by suction filtration, wash well with water and dry at 100°. Concentrate the mother liquor to about half the original volume and so obtain a second crop of acid. The first crop of acid weighs 85 g. (99 per cent. pure) and the second crop weighs 7 g. (80 per cent. pure). Recrystallise from hot water: the resulting *isonicotinic* acid is pure and has a m.p. of 311° (sealed tube).

The solubility of *isonicotinic* acid in 1000 ml. of water at 0°, 40°, 80° and 100° is 3, 9, 24 and 34 g. respectively. The solubility is appreciably less in the presence of potassium chloride.

V,23.

ETHYL NICOTINATE

Ethyl nicotinate may be prepared *either* by direct esterification of the acid with ethanol and sulphuric acid, followed by pouring into water and rendering ammoniacal or by interaction of the acid with thionyl chloride, followed by reaction of nicotiny chloride hydrochloride with ethanol and subsequent neutralisation.

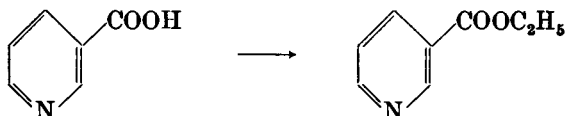

Method 1. Reflux a mixture of pure nicotinic acid (Section V,22), 84 g. (105 ml.) of absolute ethanol and 90 g. (50 ml.) of concentrated sulphuric acid in a flask for 4 hours on a steam bath. Cool the solution and pour it slowly and with stirring on to 200 g. of crushed ice. Add sufficient ammonia solution to render the resulting solution strongly alkaline: generally, some ester separates as an oil but most of it remains dissolved in the alkaline solution. Extract the solution with five 25 ml. portions of ether, dry the combined ethereal extracts with anhydrous magnesium sulphate, remove the ether and distil under reduced pressure. The ethyl nicotinate passes over at 117–118°/16 mm.: the yield is 34 g. The b.p. under normal pressure is 222–224°.

Method 2. In a 250 ml. three-necked flask, fitted with a reflux condenser, mercury-sealed stirrer and dropping funnel, place 20·5 g. of pure nicotinic acid. Cool the flask in a bath of cold water and add 90 g. (55 ml.) of redistilled thionyl chloride by means of the dropping funnel; the initial reaction is vigorous but soon subsides. Reflux the mixture on a water bath for 2 hours. Replace the reflux condenser by a condenser arranged for downward distillation and distil off the excess of thionyl chloride under reduced pressure (water pump; water bath). An almost white solid, nicotiny chloride hydrochloride, remains. Now restore the reflux condenser to the third neck of the flask. Introduce 70 ml. of sodium-dried benzene, stir, and immerse the flask in a bath of ice water. Add 20 ml. of absolute ethanol from the dropping funnel, with stirring, during a period of 30 minutes; then reflux for 2 hours. After cooling, add 200 ml. of 20 per cent. sodium carbonate solution and continue the stirring for 10 minutes: transfer the contents of the flask to a separatory funnel, separate the benzene layer and extract the aqueous layer with two 25 ml. portions

of ether. Dry the combined benzene and ether extracts (anhydrous magnesium sulphate), distil off the solvents under atmospheric pressure from a water bath, and the residue under reduced pressure. Collect the ethyl nicotinate at 117–118°/16 mm. ; the yield is 20 g.

V,24

β-CYANOPYRIDINE

Ethyl nicotinate upon treatment with concentrated ammonia solution yields nicotinamide, which gives β-cyanopyridine upon heating with phosphoric oxide:

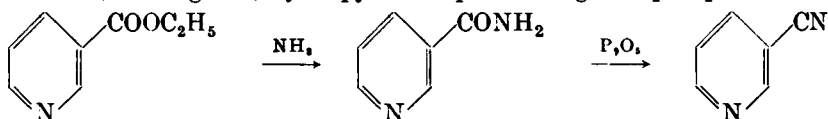

Nicotinamide. Place 50 g. of pure ethyl nicotinate (Section V,23) in a 350 ml. bolt-head flask and add 75 ml. of concentrated aqueous ammonia saturated at 0°. Keep the flask loosely stoppered for 18 hours, after which time the lower layer generally dissolves on shaking. Saturate the solution with ammonia and allow it to stand for a further 4 hours. Repeat the saturation with ammonia ; crystals of the amide commence to appear in the solution. Evaporate to dryness in a dish on the steam bath and dry at 120°. The yield of nicotinamide, m.p. 130°, is usually quantitative.

β-Cyanopyridine. Mix 25 g. of powdered nicotinamide with 30 g. of phosphoric oxide in a 150 ml. distilling flask by shaking. Immerse the flask in an oil bath and arrange for distillation under a pressure of about 30 mm. Raise the temperature of the oil bath rapidly to 300°, then remove the oil bath and continue the heating with a free flame as long as a distillate is obtained. The nitrile crystallises on cooling to a snow-white solid. Redistil the solid at atmospheric pressure ; practically all of it passes over at 201° and crystallises completely on cooling. The yield of β-cyanopyridine, m.p. 49°, is 20 g.

V,25.

URAMIL

Uramil (aminobarbituric acid) (III) may be prepared by the oxidation of barbituric acid (I) to nitrobarbituric acid (II), followed by reduction of the latter :

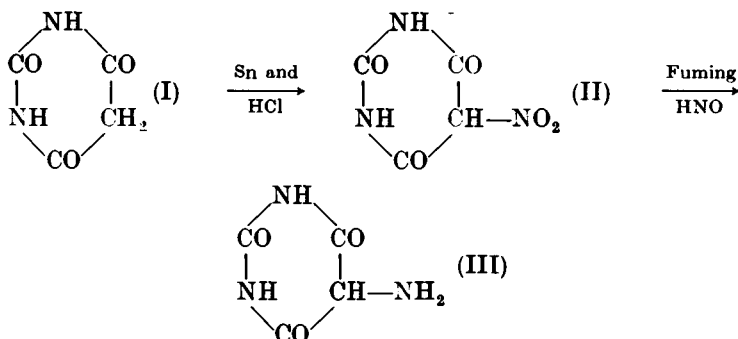

Nitrobarbituric acid. Place 72 ml. of fuming nitric acid, sp. gr. 1.52, in a 1-litre flask equipped with a mechanical stirrer and surrounded by an

ice bath. Add 50 g. of barbituric acid (Section IX,6), with stirring, over a period of 2 hours; keep the temperature below 40° during the addition. Stir for a further 1 hour, and continue the stirring while 215 ml. of water is added and the solution is cooled to 10°. Filter with suction through a sintered glass funnel, wash with cold water, and dry on a clock glass at 60–80°. Dissolve the crude nitrobarbituric acid in 450 ml. of boiling water, filter, and allow to stand overnight. Collect the crystals by suction filtration, wash well with cold water, and dry at 90–95° for 2–3 hours. The product is the trihydrate, m.p. 181–183° (decomp.; rapid heating) and weighs 70 g. Drying at 110–115° for 2–3 hours gives 47 g. of anhydrous nitrobarbituric acid, m.p. 176° (decomp.).

Uramil. In a 3-litre flask place 38 g. of anhydrous nitrobarbituric acid and 300 ml. of concentrated hydrochloric acid; heat the mixture on a boiling water bath. Add 125 g. of granulated tin and 200 ml. of concentrated hydrochloric acid over a period of about 30 minutes; continue the heating until the yellow colour, due to the nitro compound, in the liquid is no longer visible. Introduce 1500 ml. more of concentrated hydrochloric acid and heat until all the white solid dissolves; add a little decolourising charcoal, and filter the hot mixture through a sintered glass funnel. Keep the filtrate at 0° overnight, collect the uramil by filtration with suction, wash well with dilute hydrochloric acid and finally with water. Concentrate the filtrate under reduced pressure (water pump) to about 500 ml. and cool overnight. Collect the second crop of uramil, wash it as before, and combine it with the first product. Dry in a vacuum desiccator over concentrated sulphuric acid. The resulting uramil (23 g.) is a fine white powder; it does not melt below 400°, and becomes pink to red on standing, particularly if ammonia is present in the air.

V,26.

2-PHENYLINDOLE

An important general method of preparing indoles, known as the Fischer indole synthesis, consists in heating the phenylhydrazone of an aldehyde, ketone or keto-acid in the presence of a catalyst such as zinc chloride, hydrochloric acid or glacial acetic acid. Thus acetophenone phenylhydrazone (I) gives 2-phenylindole (IV). The synthesis involves an intramolecular condensation with the elimination of ammonia. The following is a plausible *mechanism* of the reaction:

(i) The tautomer (II) of the hydrazone (I) rearranges to a substituted *o*-amino-phenylethylene-amine (III) by a type of ortho-benzidine rearrangement.

(ii) The resulting diamine (III) undergoes ring closure with elimination of ammonia (as ammonium salt); this is analogous to the formation of a cyclic imine from the dihydrochloride of a 1:4-diamine.

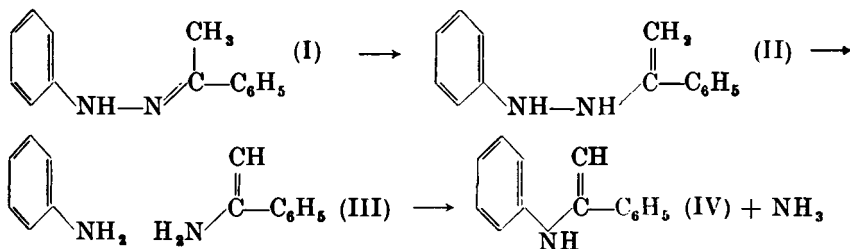

An interesting application is the preparation of 1 : 2 : 3 : 4-tetrahydrocarbazole (VI), which is formed when phenylhydrazine is added to a boiling solution of *cyclohexanone* in acetic acid ; the phenylhydrazone (V) intermediately produced undergoes ring closure directly :

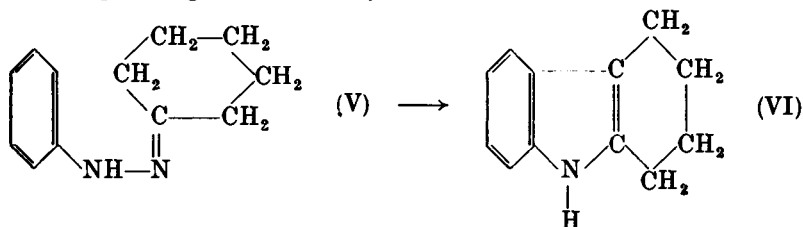

Prepare acetophenonephenylhydrazone by warming a mixture of 20 g. of acetophenone (Section IV, 136) and 18 g. of phenylhydrazine on a water bath for 1 hour. Dissolve the hot mixture in 40 ml. of rectified spirit, and shake or stir to induce crystallisation. Cool the mixture in ice, filter and wash with 12 ml. of rectified spirit. Dry in a vacuum desiccator over anhydrous calcium chloride for at least half an hour. The yield of phenylhydrazone, m.p. 105–106°, is 28 g.

Place an intimate mixture of 125 g. of powdered, anhydrous zinc chloride and 26.5 g. of acetophenonephenylhydrazone in a tall 500 ml. beaker in an oil bath at 170°. Stir the mixture vigorously by hand. After 3–4 minutes the mass becomes liquid and evolution of white fumes commences. Remove the beaker from the bath and stir the mixture for 5 minutes. Then stir in 100 g. of clean, white sand in order to prevent solidification to a hard mass. Digest the mixture for 12–16 hours on a water bath with 400 ml. of water and 12 ml. of concentrated hydrochloric acid in order to dissolve the zinc chloride. Filter off the sand and the crude 2-phenylindole, and boil the solids with 300 ml. of rectified spirit. Treat the hot mixture with a little decolourising carbon and filter through a pre-heated Buchner funnel ; wash the residue with 40 ml. of hot rectified spirit. Cool the combined filtrates to room temperature, filter off the 2-phenylindole and wash it three times with 10 ml. portions of cold alcohol. Dry in a vacuum desiccator over anhydrous calcium chloride. The yield of pure 2-phenylindole, m.p. 188–189°, is 16 g.

COGNATE PREPARATION

1 : 2 : 3 : 4-Tetrahydrocarbazole. In a 500 ml. three-necked flask fitted with a dropping funnel, glycerine-sealed stirrer (Fig. II, 7, 10) and reflux condenser, place a mixture of 49 g. of pure *cyclohexanone* (or 55 g. of the commercial ketone ; assumed purity 90 per cent.) and 180 g. of glacial acetic acid. Heat under reflux with stirring and add 54 g. (49 ml.) of redistilled phenylhydrazine during 1 hour ; continue the stirring for a further hour. Pour the reaction mixture into a 1-litre beaker and stir vigorously while it solidifies. Cool to 5° and filter at the pump through a Buchner funnel ; cool the filtrate in ice and refilter through the same Buchner funnel. Wash the solid on the filter with 50 ml. of water, suck almost dry, and then wash with 50 ml. of 75 per cent. ethanol. Spread the crude solid upon absorbent paper and dry in the air overnight. Recrystallise the slightly damp solid from 350 ml. of methanol : add a

little decolourising carbon and filter through a hot water funnel. The yield of 1:2:3:4-tetrahydrocarbazole, m.p. 116–117°, is 65 g. A further 5 g. of product may be obtained by concentrating the mother liquor to one quarter of the original volume.

V,27. BENZIMIDAZOLE

o-Phenylenediamine (I) condenses with formic acid to yield benzimidazole (II):

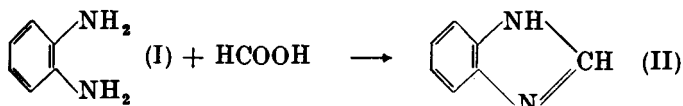

With acetic acid, 2-methylbenzimidazole, m.p. 173–174°, is formed: indeed the conversion of aliphatic acids into 2-alkylbenzimidazoles has been proposed as a method for preparing solid derivatives for the identification of monobasic aliphatic acids.

Place 27 g. of *o*-phenylenediamine (Section IV,92) in a 250 ml. round-bottomed flask and add 17.5 g. (16 ml.) of 90 per cent. formic acid (1). Heat the mixture on a water bath at 100° for 2 hours. Cool, add 10 per cent sodium hydroxide solution slowly, with constant rotation of the flask, until the mixture is just alkaline to litmus. Filter off the crude benzimidazole at the pump, wash with ice-cold water, drain well and wash again with 25 ml. of cold water. Dissolve the crude product in 400 ml. of boiling water, add 2 g. of decolourising carbon, and digest for 15 minutes. Filter rapidly at the pump through a pre-heated Buchner funnel and flask. Cool the filtrate to about 10°, filter off the benzimidazole, wash with 25 ml. of cold water, and dry at 100°. The yield of pure benzimidazole, m.p. 171–172°, is 25 g.

Note.

(1) Satisfactory results can also be obtained with more dilute acid, *e.g.*, of 40 per cent. concentration.

V,28. 4-METHYLCOUMARIN

The preparation of 4-methylcoumarin is an example of the **Pechmann reaction**, which consists in the interaction of a phenol with a β -keto ester in the presence of a condensing agent (sulphuric acid, aluminium chloride, phosphorus oxychloride or phosphoric oxide):

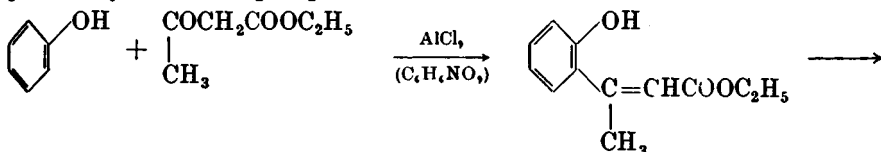

Phenol

Et acetoacetate

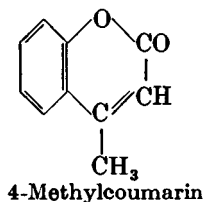

Resorcinol condenses similarly with ethyl acetoacetate in the presence of concentrated sulphuric acid to give 4-methyl-7-hydroxycoumarin.

Place 94 g. of phenol and 134 g. (130.5 ml.) of ethyl acetoacetate in 150 ml. of redistilled nitrobenzene in a 3-litre three-necked flask, fitted with a dropping funnel, sealed stirrer and an air condenser, the open end of which is connected to a gas absorption trap (Figs. II, 8, 1-2). Heat the mixture to 100° in an oil bath, stir, and add a solution of 266 g. of anhydrous aluminium chloride in 1 litre of nitrobenzene (1) from the dropping funnel over a period of 45 minutes. Replace the dropping funnel by a thermometer, raise the temperature of the solution to 130° and maintain this temperature, with stirring, for 3 hours, by which time evolution of hydrogen chloride will have almost ceased. Cool the reaction mixture to room temperature and add 250 ml. of 1 : 1-hydrochloric acid with stirring in order to decompose the excess of aluminium chloride. Equip the flask for steam distillation, warm it and pass steam into the reaction mixture : this will remove any unchanged keto-ester and some of the nitrobenzene : collect about 100 ml. of distillate. Transfer the residue in the flask whilst hot to a large separatory funnel ; separate and discard the aqueous layer. Filter the organic layer (with the addition of a filter aid, if necessary) through a Buchner or slit-sieve funnel to remove tarry matter. Distil under reduced pressure from a 1-litre Claisen flask ; the nitrobenzene passes over first, followed by crude 4-methylcoumarin at 180–195°/15 mm. (75 g.) as a red-yellow oil which solidifies on cooling. Dissolve the crude product in ether, shake the ether solution with small volumes of 5 per cent. sodium hydroxide solution until the aqueous layer is colourless, dry, evaporate the ether and recrystallise the residue from a 4 : 1 mixture of light petroleum (b.p. 60–80°) and benzene. The resulting 4-methylcoumarin (62 g.) is almost colourless and melts at 83–84°.

Note.

(1) Add the aluminium chloride in 25 g. portions to the 1-litre of dry nitrobenzene contained in a 2.5-litre round-bottomed flask ; stir after each addition. The temperature may rise to about 80° during the addition : cool the flask occasionally under running water. When all the aluminium chloride has been added, cool the solution to room temperature : a little solid may settle to the bottom.

COGNATE PREPARATION

4-Methyl-7-hydroxycoumarin. Place 1 litre of concentrated sulphuric acid in a 3-litre three-necked flask fitted with a thermometer, mechanical stirrer and a dropping funnel. Immerse the flask in an ice bath. When the temperature falls below 10°, add a solution of 100 g. of resorcinol in 134 g. (130.5 ml.) of redistilled ethyl acetoacetate dropwise and with stirring. Maintain the temperature below 10° by means of an ice-salt bath during the addition (*ca.* 2 hours). Keep the reaction mixture at room temperature for about 18 hours, then pour it with vigorous stirring into a mixture of 2 kg. of crushed ice and 3 litres of water. Collect the precipitate by suction filtration and wash it with three 25 ml. portions of cold water. Dissolve the solid in 1500 ml. of 5 per cent. sodium hydroxide solution, filter, and add dilute (1 : 10) sulphuric acid (about 550 ml.) with vigorous stirring until the solution is acid to litmus. Collect the crude 4-methyl-7-hydroxycoumarin by filtration at the pump, wash it

with four 25 ml. portions of cold water, and dry at 100° : the yield is 155 g. Recrystallise from 95 per cent. ethanol : the pure compound separates in colourless needles, m.p. 185°.

A simplified procedure is possible by using polyphosphoric acid as the condensing agent. Add 160 g. of polyphosphoric acid* to a solution of 11 g. of resorcinol in 13 g. of ethyl acetoacetate. Stir the mixture and heat at 75–80° for 20 minutes, and then pour into ice-water. Collect the pale yellow solid by suction filtration, wash with a little cold water, and dry at 60°. The yield of crude 4-methyl-7-hydroxycoumarin, m.p. 178–181°, is 17 g. Recrystallisation from dilute ethanol yields the pure, colourless compound, m.p. 185°.

V,29 2-HYDROXYLEPIDINE (4-METHYLCARBOSTYRIL)

2-Hydroxylepidine (II) is readily prepared by cyclisation of acetoacetanilide (I) with concentrated sulphuric acid :

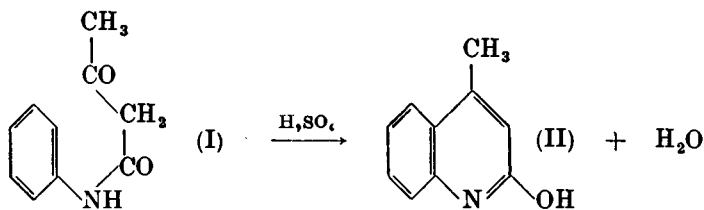

Place 95 ml. of concentrated sulphuric acid in a 500 ml. three-necked flask equipped with a mechanical stirrer and a thermometer ; the thermometer must dip in the liquid. Have a bath of cold water at hand so that the reaction flask can be cooled rapidly, if required. Heat the acid to 75°, remove the source of heat, stir and add 89 g. of acetoacetanilide (1) in portions by means of a spatula. Maintain the temperature of the reaction mixture at 70–75° by intermittent cooling until nearly all the acetoacetanilide has been introduced : add the last 7–10 g. without cooling. The duration of the addition is 25–30 minutes. During the last addition without external cooling, the temperature will rise to about 95° and the heat of the reaction will maintain this temperature for about 15 minutes. Keep the reaction mixture at 95° for a further 15 minutes by external heating. When the solution has cooled to 60–65°, pour it into 2.5 litres of water with vigorous stirring. Cool, collect the product by suction filtration, wash with four 250 ml. portions of water, two 125 ml. portions of methanol, and dry in the air. The crude 2-hydroxylepidine, m.p. 219–221°, weighs 70 g. Recrystallise from 95 per cent. ethanol (*ca.* 16 ml. per gram) : the pure product melts at 223–224° and the recovery is about 85 per cent.

Note.

(1) Acetoacetanilide is an inexpensive commercial product. If necessary, it may be recrystallised from 50 per cent. ethanol ; m.p. 84–85°.

* Supplied, for example, by Albright & Wilson Limited, 49 Park Lane, London, W.1.

V,30. PHENYLBENZOYLDIAZOMETHANE

Phenylbenzoyldiazomethane may be prepared by the oxidation of benzil-monohydrazone with mercuric oxide in the presence of dry ether as a solvent. The addition of a little alcoholic potassium hydroxide serves to catalyse the reaction :

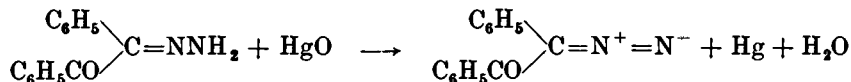

Benzil monohydrazone. *Method 1.* Boil a mixture of 26 g. of hydrazine sulphate, 55 g. of crystallised sodium acetate and 125 ml. of water for 5 minutes, cool to about 50°, and add 115 ml. of methyl alcohol. Filter off the precipitated sodium sulphate and wash with a little alcohol. Dissolve 25 g. of benzil (Section IV,126) in 40 ml. of hot methyl alcohol and add the above hydrazine solution, heated to 60°. Most of the benzil hydrazone separates immediately, but reflux for 30 minutes in order to increase the yield. Allow to cool, filter the hydrazone and wash it with a little ether to remove the yellow colour. The yield is 25 g., m.p. 149-151° (decomp.).

Method 2. Drop 10 g. of hydrazine hydrate (85 per cent. aqueous solution : see Section II,49,10) into a hot solution of 35 g. of benzil (Section IV,126) in 70 ml. of alcohol with stirring. When about three-fourths of the hydrazine hydrate has been introduced, the product begins to separate. After all the reagent has been added, heat the solution under reflux for 5 minutes, cool to 0°, filter at the pump, and wash twice with 20 ml. portions of alcohol. The yield of benzil monohydrazone, m.p. 149-151° (decomp.), is almost quantitative.

Phenylbenzoyldiazomethane. Grind together in a mortar 15 g. of benzil monohydrazone, 30 g. of yellow mercuric oxide and 8 g. of anhydrous sodium sulphate (the last-named to absorb the water formed in the subsequent reaction). Introduce the mixture into a 250 ml. glass-stoppered bottle, add 100 ml. of sodium-dried ether and 2 ml. of a cold saturated solution of potassium hydroxide in alcohol : shake the mixture for 10-15 minutes. Filter the solution by gravity through a fine filter paper, and wash the residue several times with anhydrous ether until the filtrate is only slightly coloured. Evaporate the combined ethereal extracts under reduced pressure (water pump) by heating the flask on a water bath at 30-35° but no higher : if evaporation is carried out at atmospheric pressure on a water bath, the product may explode. Spread the yellow, crystalline material on a porous plate, and recrystallise it from anhydrous ether. The yield of "azibenzil," m.p. 79° (decomp.), is 13.5 g.

V,31. 2-CARBETHOXYCYCLOPENTANONE

Esters of dicarboxylic acids having hydrogen on the δ or ϵ carbon atoms undergo intramolecular cyclisation when heated with sodium or with sodium ethoxide. This cyclisation is known as the Dieckmann reaction. It is essentially an application of the Claisen (or acetoacetic ester) condensation to the formation of a ring system ; the condensation occurs internally to produce a

cyclic β -keto ester. The only useful practical application is to the formation of five and six membered rings. A typical example is :

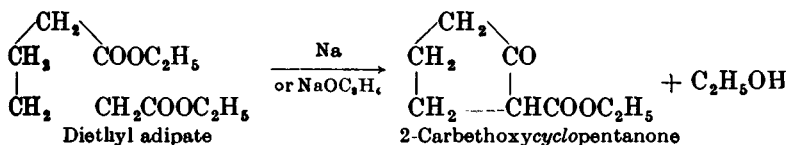

Prepare 25 g. of "molecular" sodium in a 1500 ml. round-bottomed flask (Section II, 50, 6, Method 1). Cover the sodium with 625 ml. of sodium-dried A.R. benzene; fit the flask with an efficient reflux condenser protected from the air by means of a calcium chloride (or cotton wool) guard tube. Add 151.5 g. of diethyl adipate (Sections III, 99 and III, 100) in one lot, followed by 1.5 ml. of absolute ethyl alcohol. Warm the flask on a water bath until, after a few minutes, a vigorous reaction sets in and a cake of the sodio compound commences to separate. Keep the flask well shaken by hand during the whole of the initial reaction. After the spontaneous reaction has subsided, reflux the mixture on a water bath overnight, and then cool in ice. Decompose the product with ice and dilute hydrochloric acid (1 : 1); add the acid until Congo red paper is turned blue. Separate the benzene layer, and extract the aqueous layer with 100 ml. of benzene. Wash the combined extracts with 100 ml. of 5 per cent. sodium carbonate solution and 150 ml. of water; dry over a little anhydrous magnesium sulphate. Remove the benzene under atmospheric pressure (Fig. II, 13, 4, but with modified Claisen flask), and fractionate the residue under reduced pressure. Collect the 2-carboethoxycyclopentanone at 108–111°/15 mm. (95 g.). Upon redistillation, the product boils at 102°/11 mm.

V.32. CYCLOBUTANE-1 : 1-DICARBOXYLIC ACID AND CYCLOBUTANECARBOXYLIC ACID

Trimethylene dibromide (1 mol) condenses with ethyl malonate (1 mol) in the presence of sodium ethoxide (2 mols) to form ethyl cyclobutane-1 : 1-dicarboxylate (I). Upon hydrolysis of the latter with alcoholic potassium hydroxide, followed by acidification cyclobutane-1 : 1-dicarboxylic acid (II) is obtained.

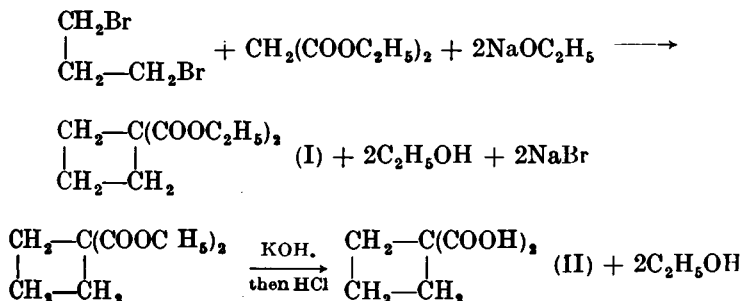

When *cyclobutane-1 : 1*-dicarboxylic acid is heated above its melting point until the evolution of carbon dioxide ceases, *cyclobutanecarboxylic acid* (III) is formed in good yield :

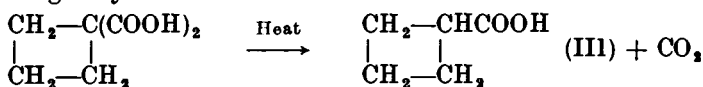

Equip a 3 litre three-necked flask with a thermometer, a mercury-sealed mechanical stirrer and a double-surface reflux condenser. It is important that all the apparatus be thoroughly dry. Place 212 g. of trimethylene dibromide (Section III,35) and 160 g. of ethyl malonate (Section III,153) (dried over anhydrous calcium sulphate) in the flask. By means of a separatory funnel, supported in a retort ring and fitted into the top of the condenser with a grooved cork, add with stirring a solution of 46 g. of sodium in 800 ml. of "super-dry" ethyl alcohol (Section II,47,5) (1) at such a rate that the temperature of the reaction mixture is maintained at 60–65° (50–60 minutes). When the addition is complete, allow the mixture to stand until the temperature falls to 50–55°, and then heat on a water bath until a few drops of the liquid when added to water are no longer alkaline to phenolphthalein (about 2 hours). Add sufficient water to dissolve the precipitate of sodium bromide, and remove the alcohol by distillation from a water bath. Arrange the flask for steam distillation (Fig. II,41,1 : this merely involves replacing the stirrer from the previous distillation by a steam-delivery tube). Steam distil until all the ethyl *cyclobutane-1 : 1*-dicarboxylate and unchanged ethyl malonate are removed ; collect about 4 litres of distillate during 9–10 hours. Extract the entire steam distillate with three 350 ml. portions of ether ; remove the ether from the combined extracts on a water bath. Reflux the residual liquid with a solution of 112 g. of potassium hydroxide in 200 ml. of alcohol for 2 hours. Distil off most of the alcohol and then evaporate the residue to dryness on a water bath. Dissolve the solid residue in 100 ml. of hot water, and add concentrated hydrochloric acid (ca. 80 ml.) cautiously until the solution is just acid to litmus. Boil for a few minutes to remove carbon dioxide, render slightly alkaline with dilute ammonia solution, and add a slight excess of aqueous barium chloride to the boiling solution. Filter the hot solution to remove the barium malonate, cool the filtrate and render it strongly acid with concentrated hydrochloric acid (90–100 ml. of acid : use Congo red paper). Extract the solution with four 250 ml. portions of ether. Dry the combined extracts with anhydrous calcium chloride and remove the ether on a water bath ; complete the evaporation in a beaker or crystallisation dish. Place the beaker or dish in a vacuum desiccator for a few minutes to remove the last traces of ether, spread the solid on a porous tile and allow to stand overnight. The beautifully crystalline product (55 g.) consists of pure *cyclobutane-1 : 1*-dicarboxylic acid, m.p. 158°. It may be recrystallised from hot ethyl acetate, but the m.p. is unchanged.

Place 30 g. of *cyclobutane-1 : 1*-dicarboxylic acid in a 100 ml. distilling flask, fitted with a thermometer, and connect the side arm to a 50 ml. Claisen flask supported in a funnel so that it can be cooled externally by running water. Heat the distilling flask in a metal bath at 160–170°

until all effervescence ceases. Then raise the temperature of the bath to 210°; the *cyclobutanecarboxylic acid* passes over at 191–197°. Redistill the acid from the Claisen flask, using an air bath (Fig. II, 5, 3): the pure acid distils at 195–196°. The yield of *cyclobutanecarboxylic acid* (a colourless liquid) is 18 g.

Note.

(1) The sodium ethoxide solution is conveniently prepared as follows. Place 46 g. of clean sodium (Section III, 7, Note 1) in a 2 litre round-bottomed flask provided with a 25 cm. double surface condenser. The apparatus must be perfectly dry. Cool the flask in a bath of crushed ice. Add 800 ml. of "super-dry" ethyl alcohol in one operation. A vigorous reaction will ensue, but it will remain under control. When the initial reaction is over, remove the ice bath and allow the residual sodium to react. If small quantities of sodium remain, warm the flask on a water bath until solution is complete.

If commercial absolute ethyl alcohol is used, the yield of *cyclobutane-1:1-dicarboxylic acid* is reduced to 34 g.

V,33. CYCLOPROPANECARBOXYLIC ACID

The procedure (with ethylene dibromide replacing trimethylene dibromide) described for *cyclobutanecarboxylic acid* (previous Section) does not give satisfactory results when applied to the *cyclopropane* analogue; the yield of the *cyclopropane-1:1-dicarboxylic acid* is considerably lower and, furthermore, the decarboxylation of the latter gives a considerable proportion (about 30 per cent.) of butyrolactone:

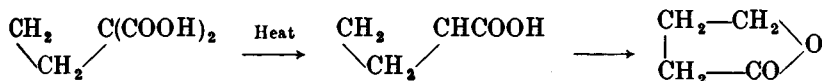

Good results are obtained by the oxidation of the commercially available *cyclopropyl methyl ketone* with sodium hypobromite solution, and the preparation may be regarded as an excellent example of the oxidation of the $-\text{COCH}_3$ group to $-\text{COOH}$:

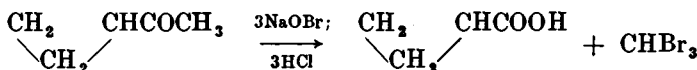

Equip a 3 litre three-necked flask with a dropping funnel, a mechanical stirrer and a thermometer. Place a solution of 165 g. of sodium hydroxide in 1400 ml. of water in the flask and cool in a freezing mixture to 0°. Add from the dropping funnel 240 g. (77 ml.) of bromine slowly so that the temperature of the stirred solution does not rise above 10°. Cool the resulting sodium hypobromite solution to 0°, add 42 g. (47 ml.) of *cyclopropyl methyl ketone* (1) slowly and at such a rate that the temperature is kept below 10°. When the addition is complete, the solution should be colourless indicating that all the sodium hypobromite has reacted: remove the freezing mixture and continue the stirring for 1.5 hours at the laboratory temperature. Transfer the mixture to a large separatory funnel, remove the lower layer of crude bromoform (114 g.), and then steam distil (Fig. II, 41, 1) the aqueous solution for 30 minutes: a further 2 g. of bromoform is recovered (2). Cool and acidify cautiously to Congo red with 250 ml. of concentrated hydrochloric acid. The solution acquires

a very pale yellow colour ; add a little sodium bisulphite solution until it is colourless. Saturate the solution with salt and extract with four 300 ml. portions of ether : dry the combined extracts with anhydrous magnesium sulphate, and distil off the ether on a water bath through a short column. Distil the residue under reduced pressure and collect the pure *cyclopropanecarboxylic acid* (a colourless liquid) at $92^{\circ}/22$ mm. (3). The yield is 33 g.

Notes.

(1) Commercial *cyclopropyl methyl ketone* (Matheson Company) is redistilled through a Widmer column : over 95 per cent. passes over at $110.8-111.8^{\circ}/757$ mm. It is quite pure since it yields a semicarbazone, m.p. 117° : the m.p. is unaffected by recrystallisation from aqueous alcohol. The ketone may be prepared from ethylene dibromide, ethyl acetoacetate and an excess of sodium ethoxide.

(2) It is better not to remove the lower bromoform layer in a separatory funnel, but to do so entirely by steam distillation ; complete oxidation of the ketone is thus ensured. The weight of recovered bromoform may be somewhat smaller (100-105 g.), but the yield of pure acid is increased to 36 g. The steam distillation must be carefully watched as a solid (carbon tetrabromide) may crystallise in the condenser ; this can easily be removed by turning off the water supply when the solid will soon melt and pass on into the distillate.

(3) Appreciable decomposition occurs upon distillation at atmospheric pressure.

The *mechanism* of the base-catalysed acylation of ketones by esters probably involves several steps (compare acetoacetic ester condensation ; see discussion prior to Section III,151) :—

(1) Removal of an α -hydrogen atom of the ketone as a proton to form a carbanion (acetone anion) :

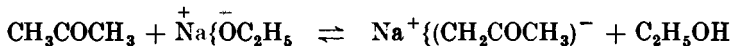

(2) Reaction of the carbanion (acetone anion) with the carbonyl carbon of ethyl acetate, accompanied by the release of an ethoxide ion, to form acetylacetone :

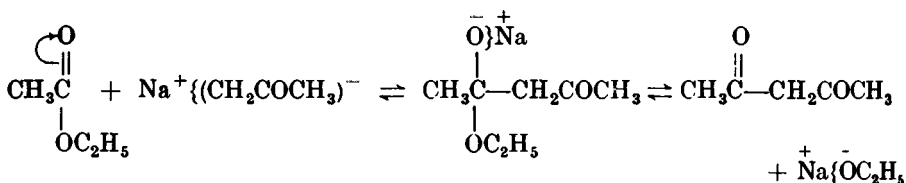

(3) Removal of a methylene hydrogen of the acetylacetone to form acetylacetone anion :

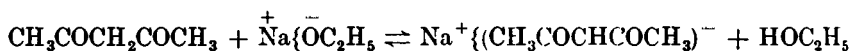

The acetylacetone anion is a resonance hybrid :

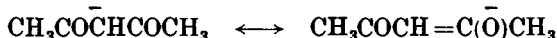

The equilibrium of the overall reaction is shifted in the direction of the condensation product by the precipitation of the β -diketone as its sodium salt.

It may be mentioned that the condensation in the presence of metallic sodium appears to be partly effected by the metal which displaces atomic hydrogen from the ketone :

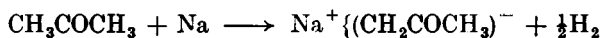

and partly by the ethoxide ion produced in the reaction mixture (compare Ethyl Acetoacetate).

Methylene ketones, such as *cyclopentanone* and *cyclohexanone*, are also readily acylated by boron trifluoride ; thus *cyclohexanone* (I) affords *2-acetylcyclohexanone* (II) :

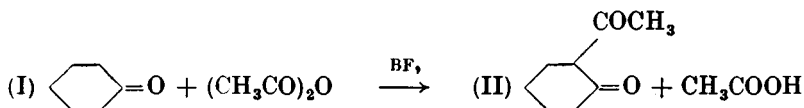

Acylation may also be effected with the acetic acid - boron trifluoride complexes $\text{BF}_3 \cdot \text{CH}_3\text{COOH}$ and $\text{BF}_3 \cdot 2\text{CH}_3\text{COOH}$.

Boron trifluoride method. Fit a 1 litre three-necked flask with a gas inlet tube, a gas outlet leading to an alkali trap (compare Fig. II, 8, 1a or b ; for the unabsorbed boron trifluoride), and stopper the third neck. Place 58 g. (73 ml.) of pure, anhydrous acetone (1) and 255 g. (236 ml.) of A.R. acetic anhydride in the flask and cool in a freezing mixture of ice and salt. Connect the gas inlet tube through an empty wash bottle to a cylinder of commercial boron trifluoride (2), and bubble the gas through the reaction mixture at such a rate that 250 g. is absorbed in about 5 hours (2 bubbles per second). Pour the reaction mixture into a solution

of 400 g. of crystallised sodium acetate in 800 ml. of water contained in a 2.5 litre round-bottomed flask. Steam distil the mixture (Fig. II, 40, 1), and collect the distillate in the following portions: 500 ml., 250 ml., 250 ml., and 250 ml. In the meantime prepare a solution of 120 g. of A.R. crystallised cupric acetate in 1500 ml. of water at about 85°; if the solution is not clear, filter from any basic acetate. Precipitate the copper salt of acetylacetone by adding 700 ml. of the hot copper acetate solution to the first portion of the steam distillate, 350 ml. to the second, 250 ml. to the third, and 200 ml. to the fourth portion. Allow to stand for 3 hours, or better overnight, in the ice chest. Filter off the salt at the pump, wash once with water, and suck as dry as possible. Transfer the copper salt to a separatory funnel, add 400 ml. of 20 per cent. sulphuric acid and 400 ml. of ether, and shake. Remove the ether layer. Extract the aqueous layer with two 150 ml. portions of ether. Dry the combined extracts with 125 g. of anhydrous sodium sulphate (or the equivalent quantity of anhydrous magnesium sulphate), and distil off the ether. Distil the residue from a Claisen flask with fractionating side arm (Figs. II, 24, 4-5) and collect the acetylacetone at 134-136°. The yield is 80 g.

Sodium ethoxide method. Prepare "molecular" sodium from 46 g. of clean sodium and 250 ml. of sodium-dried xylene contained in a 1 litre round-bottomed flask (Section II, 50, 6). Transfer the contents of the flask to a 2 litre three-necked flask and decant the xylene. Wash the sodium by decantation with two 75 ml. portions of sodium-dried ether. Cover the granulated sodium with 700 ml. of anhydrous ether, place the flask on a water bath, and fit the flask with a dropping funnel, a Hershberg stirrer (Fig. II, 7, 8) and a reflux condenser; insert guard tubes, containing absorbent cotton wool or anhydrous calcium chloride, into the funnel and the condenser. Place 117 ml. (92 g.) of absolute ethyl alcohol in the dropping funnel, start the stirrer, and introduce the alcohol over a period of 2 hours with gentle refluxing. Reflux the mixture with stirring for a further 6 hours; by this time most, if not all, of the sodium should have reacted (a little residual sodium does no harm). Stop the stirrer, turn the condenser downward (compare Fig. II, 41, 1), and distil off the ether as completely as possible on a water bath. The residual sodium ethoxide should be white and finely-divided. All moisture must be excluded during the preparation in order to avoid the formation of sodium hydroxide, which markedly lowers the yield. Return the condenser to the reflux position and add 800 ml. of pure, dry ethyl acetate (3) through the dropping funnel to the warm solid sodium ethoxide as rapidly as possible. Start the stirrer immediately and add *once* 116 g. (147 ml.) of pure dry acetone during about 15 minutes; if the mixture does not reflux, warm gently on a water bath. After about half of the acetone has been introduced, the mixture generally sets to a solid mass and mechanical stirring is impossible; turn the stirrer by hand and continue the addition of the acetone. In a few minutes the mass can again be stirred mechanically. During the addition of the acetone, the solution acquires a red colour and eventually the mixture turns brown. Reflux the mixture for 1 hour: stop the stirrer and allow to stand for 12 hours, during which time crystals of the sodium salt separate.

Decant the liquid layer into a 2.5 litre flask, and dissolve the sodium derivative of acetylacetone in 1600 ml. of ice water; transfer the solution to the flask. Separate the impure ethyl acetate layer as rapidly as possible; extract the aqueous layer with two 200 ml. portions of ether and discard the ethereal extracts. Treat the aqueous layer with ice-cold dilute sulphuric acid (100 g. of concentrated sulphuric acid and 270 g. of crushed ice) until it is just acid to litmus. Extract the diketone from the solution with four 200 ml. portions of ether. Leave the combined ether extracts standing over 40 g. of anhydrous sodium sulphate (or the equivalent quantity of anhydrous magnesium sulphate) for 24 hours in the ice chest. Decant the ether solution into a 1500 ml. round-bottomed flask, shake the desiccant with 100 ml. of sodium-dried ether and add the extract to the ether solution. Distil off the ether on a water bath. Transfer the residue from a Claisen flask with fractionating side arm (Figs. II, 24, 4-5): collect the fraction boiling between 130° and 139°. Dry this over 5 g. of anhydrous potassium carbonate, remove the desiccant, and redistil from the same flask. Collect the pure acetylacetone at 134-136°. The yield is 85 g.

Notes.

(1) A.R. acetone may be dried over anhydrous potassium carbonate or anhydrous calcium sulphate.

(2) Boron trifluoride is available commercially in cylinders, *e.g.*, from the Imperial Smelting Corporation Ltd., 37 Dover Street, London, W. 1, and from Matheson Company Inc., East Rutherford, N.J., U.S.A. It is advantageous to bubble the gas through 95 per cent. sulphuric acid. Boron trifluoride-acetic acid complex, largely $\text{BF}_3 \cdot 2\text{CH}_3\text{COOH}$, containing about 40 per cent. BF_3 is obtainable from Imperial Smelting Corporation Ltd.

(3) Pure commercial ethyl acetate is allowed to stand for 2 days over anhydrous calcium chloride, the desiccant removed by filtration, and the ester is then finally dried over anhydrous calcium sulphate for several hours.

COGNATE PREPARATION

2-Acetylcyclohexanone. *Method A.* Place a mixture of 24.5 g. of cyclohexanone (regenerated from the bisulphite compound) and 51 g. (47.5 ml.) of A.R. acetic anhydride in a 500 ml. three-necked flask, fitted with an efficient sealed stirrer, a gas inlet tube reaching to within 1-2 cm. of the surface of the liquid combined with a thermometer immersed in the liquid (compare Fig. II, 7, 12, *b*), and (in the third neck) a gas outlet tube leading to an alkali or water trap (Fig. II, 8, 1). Immerse the flask in a bath of Dry Ice-acetone, stir the mixture vigorously and pass commercial boron trifluoride (via an empty wash bottle and then through 95 per cent. sulphuric acid) as fast as possible (10-20 minutes) until the mixture, kept at 0-10°, is saturated (copious evolution of white fumes when the outlet tube is disconnected from the trap). Replace the Dry Ice-acetone bath by an ice bath and pass the gas in at a slower rate to ensure maximum absorption. Stir for 3.5 hours whilst allowing the ice bath to attain room temperature slowly. Pour the reaction mixture into a solution of 136 g. of hydrated sodium acetate in 250 ml. of water, reflux for 60 minutes (or until the boron fluoride complexes are hydrolysed), cool in ice and extract with three 50 ml. portions of petroleum ether, b.p. 40-60° (1), wash the combined extracts free of acid with sodium bicarbonate solution, dry over anhydrous calcium sulphate, remove the solvent by

flash distillation, and distil the residue under reduced pressure. Collect the 2-acetylcyclohexanone at 95–97°/10 mm. The yield is 27 g.

Method B. Place 60 g. of glacial acetic acid in a 500 ml. three-necked flask equipped with a gas inlet tube, an efficient sealed stirrer, and an outlet tube leading to an alkali or water trap. Immerse the flask in an ice bath, stir vigorously and pass boron trifluoride in as rapidly as possible. Continue the passage of the gas (at a reduced rate as saturation is approached) until the contents of the flask become a powdery solid (2). Substitute a dropping funnel for the gas inlet tube, cool in an ice bath, and add a mixture of 24.5 g. of pure cyclohexanone and 51 g. (47.5 ml.) of A.R. acetic anhydride during 3–5 minutes whilst stirring vigorously. Remove the ice bath after stirring for 30 minutes, allow to stand for 4 hours, and then work up as in *Method A*. The yield of 2-acetylcyclohexanone, b.p. 95–97°/10 mm., is 30 g.

Notes.

(1) Petroleum ether is preferable to diethyl ether because it removes very little acetic acid from the aqueous phase.

(2) To prevent the solid complex from caking (which occurs if the stirring is not sufficiently rapid) about 75 ml. of dry ethylene dichloride may be added.

The solid appears to be a mixture of the complexes $\text{CH}_3\text{COOH}\cdot\text{BF}_3$ and $2\text{CH}_3\text{COOH}\cdot\text{BF}_3$. The latter appears to be a liquid and is alone soluble in ethylene dichloride; the former is a solid. The solid monoacetic acid complex is obtained by saturating an ethylene dichloride solution of acetic acid with boron trifluoride, filtering and washing the precipitate with the solvent; it is hygroscopic and should be protected from moisture. It may be used as required; 0.75 mol is employed with 0.25 mol of ketone and 0.5 mol of anhydride.

VI.2.

BENZOYLACETONE

The preparation of benzoylacetone is another example of the acylation of a ketone (acetophenone) by ethyl acetate to a β -diketone (Claisen condensation; compare preceding Section):

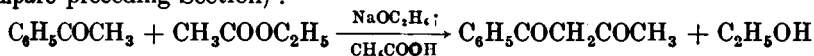

Prepare 34 g. of anhydrous sodium ethoxide in a 1 litre three-necked flask (Section VI,1, but use one-quarter of the quantities). Fit the flask with a dropping funnel, a mechanical stirrer and a reflux condenser: protect the dropping funnel and the condenser with absorbent cotton wool guard tubes. Surround the flask with ice and introduce 200 ml. of pure, dry ethyl acetate. Start the stirrer and add 60 g. (58 ml.) of acetophenone (Section IV,136) from the dropping funnel; the reaction commences (evolution of heat) after 10–20 g. of the ketone has been introduced, and the remainder is added at such a rate that gentle refluxing takes place. Continue the stirring for 2 hours, and then allow to stand in an ice box overnight. Pour the reaction mixture, with stirring, into ice water. The sodium salt of benzoylacetone separates. Filter this at the pump, wash with benzene or ether, and dry in the air. Dissolve the solid in cold water, and acidify the solution with acetic acid. Filter off the crude benzoylacetone, and dry in the air. Purify by distillation under reduced pressure; collect the benzoylacetone at 128–130°/10 mm. It solidifies on cooling to a colourless crystalline solid, m.p. 61°. The yield is 50 g.

VI.3.

PHENYLGLYOXAL

Oxidation of acetophenone with selenium dioxide in the presence of dioxan or ethyl alcohol as solvent affords phenylglyoxal :

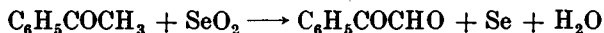

This is one example of the oxidation by selenium dioxide of compounds containing a methylene group adjacent to a carbonyl group to the corresponding α -ketoaldehyde or α -diketone (see also Section VII,23).

Fit a 500 ml. three-necked flask with a liquid-sealed stirrer, a reflux condenser and a thermometer. Place 300 ml. of dioxan (1), 55.5 g. of selenium dioxide and 10 ml. of water in the flask, heat the mixture to 50–55° and stir until the solid has dissolved. Remove the thermometer momentarily and add 60 g. of acetophenone (Section IV,136) in one lot; replace the thermometer. Reflux the mixture, with stirring, for 4 hours; after about 2 hours the solution becomes clear and little further precipitation of selenium is observable. Decant the hot solution from the precipitated selenium through a fluted filter paper, and remove the dioxan and water by distillation through a short column. Distil the residual phenylglyoxal under reduced pressure from a 150 ml. Claisen flask and collect the fraction boiling at 95–97°/25 mm. The yield of pure phenylglyoxal (a yellow liquid) is 48 g.; this sets to a stiff gel on standing, probably as a result of polymerisation, but may be recovered without appreciable loss by distillation. The aldehyde is best preserved in the form of the hydrate, which is prepared by dissolving the yellow liquid in 3.5–4 volumes of hot water and allowing to crystallise. Phenylglyoxal hydrate also crystallises from chloroform, alcohol or ether-light petroleum (b.p. 60–80°); upon distillation under diminished pressure, the free aldehyde is obtained.

Note.

(1) Rectified spirit can also be used as solvent. The dioxan can, however, be recovered and used in a subsequent run (*cf.* Section II,47,27).

VI.4. APPARATUS FOR REACTIONS UNDER PRESSURE

The following account refers primarily to commercial apparatus suitable for conducting hydrogenations under pressure; the apparatus can, of course, be employed for other reactions under high pressures, but slight modifications of experimental procedure will probably be necessary.

The apparatus shown in Fig. VI, 4, 1, *a* and *b** is suitable for use at working pressures up to 80–100 lb. per square inch (glass reaction bottle, capacity 470 ml.) or up to 500 lb. per square inch (steel reaction bottle, capacity 650 ml.). The glass or steel reaction bottle fits into a special bronze rocking frame of great strength and rigidly fixed to a solid cast iron base. Connexion between the reaction vessel and the storage tank is made by means of seamless, corrosion-resisting metal tubing coiled in such a manner as to prevent fatigue of the tubing. The frame carrying the reaction vessel may be rocked with a variable amplitude by means of a variable speed motor with a rheostat. The storage tank (40 cubic feet,

* Supplied by W. Edwards and Co. (London) Ltd. A similar apparatus is manufactured by C. W. Cock and Sons Ltd., 97, Walsall Road, Birmingham, 22B.

nominal) for hydrogen is a weldless forging capable of withstanding any pressure up to 2,000 lb. per square inch and is provided with a suitable pressure gauge. The steel reaction cylinder is fitted with a three-range heating coil giving a maximum temperature of about 450°. Four high pressure valves control the gas flow and provide for : (a) charging the

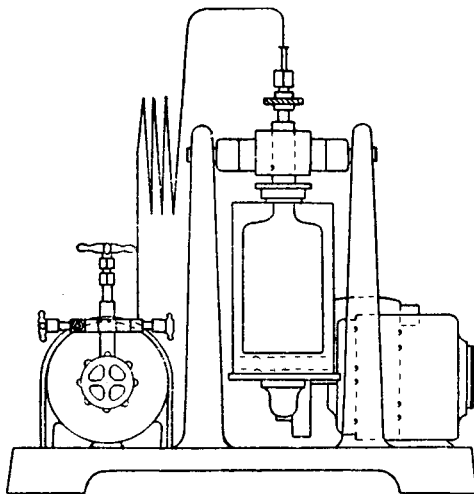

(a)

Fig. VI, 4, 1.

storage tank to the required pressure ; (b) admission of gas to the reaction chamber ; (c) release of pressure in the reaction vessel to permit the removal of containers without loss of gas from the storage tank ; and (d) cutting off the high pressure cylinder. The weight of hydrogen

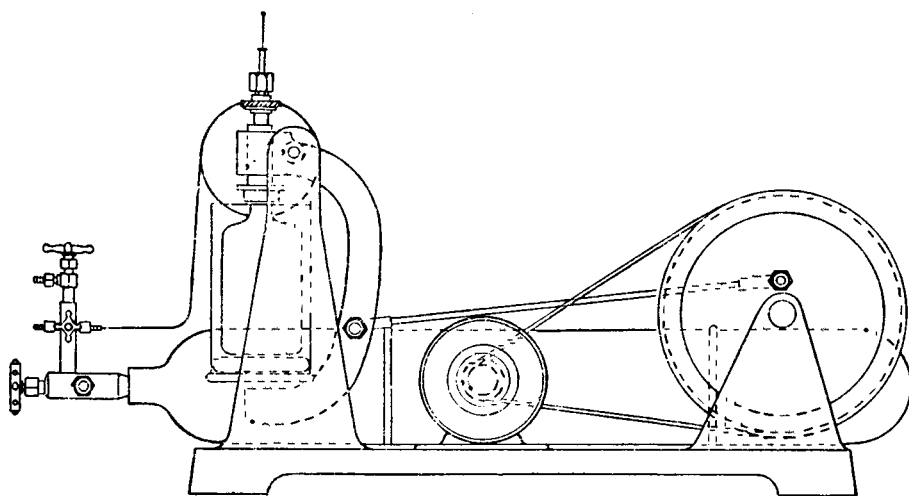

(b)

Fig. VI. 4 1.

absorbed may be computed from the change of pressure observed on the gauge. It should be mentioned that a perforated guard screen surrounds the glass bottle as a guard for flying glass in case of accidental explosion.

An excellent high pressure autoclave is illustrated in Fig. VI, 4, 2.* The special feature of this apparatus, constructed almost entirely of

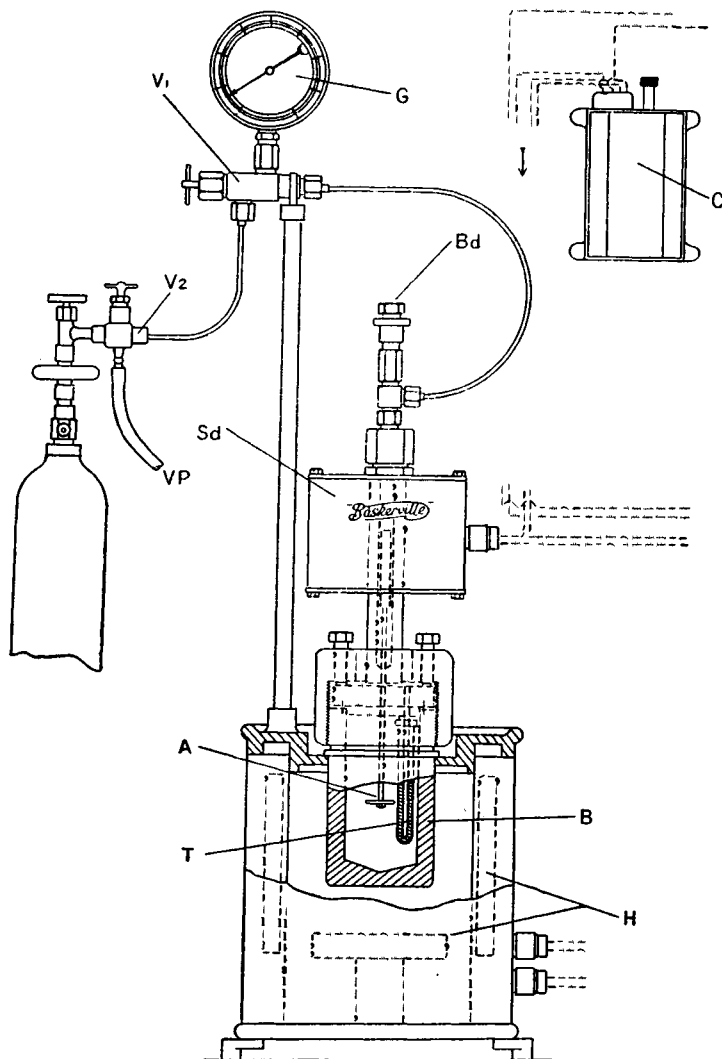

Fig. VI, 4, 2.

stainless steel, is the incorporation of a totally-enclosed agitator in the form of a plunger which is operated electro-magnetically; agitation efficiency is at least as high as is achieved with "shaking" autoclaves and is very effective for hydrogenation purposes. The apparatus is

* Manufactured by Baskerville and Lindsay, 322c Barlow Moor Road, Chorlton-cum-Hardy, Manchester 21, England.

stationary, has no external moving parts, and can be made compact and convenient to use. The reaction vessel *B* is made of F.M.B. stainless steel machined out of the solid and is provided with a cover fitted respectively with a thermometer or thermo-couple pocket *T*, a central vertical tube, and an outer vessel nut with compression screws for making the pressure joint between the cover and the vessel. *Sd* is a solenoid operated through the contactor *C*, *Bd* is a bursting disc, *G* is a pressure gauge, *V*₁ is a control valve, *V*₂ is an evacuation valve (the last-named is connected through *VP* to a vacuum pump for complete evacuation of the apparatus). The agitator *A* consists of a stainless steel rod at the lower end of which is secured a circular stainless steel plate; at the upper

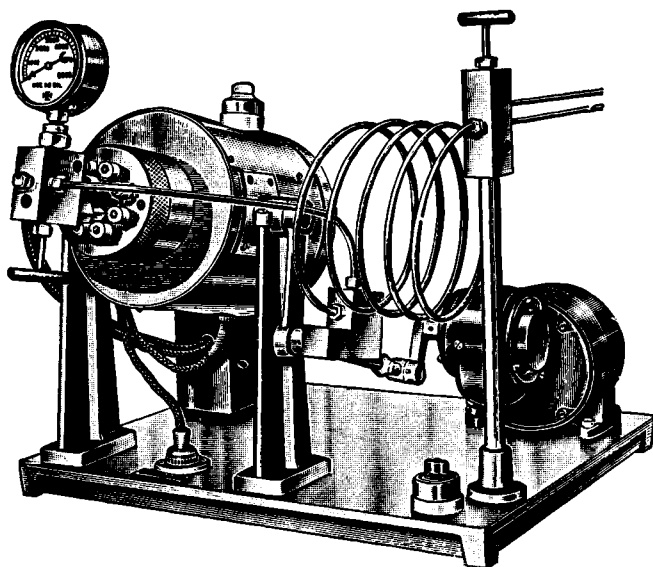

Fig. VI, 4, 3.

end of the rod passing through the centre of the vertical tube is a stainless steel sheathed armature which, in its lowest position, just enters the lower end of the solenoid coil surrounding the central tube. The solenoid *Sd* through the contactor *C* operates at a rate between 20 and 90 cycles per minute controlled by an adjustable screw on the contactor, resulting in a vertical reciprocating movement of the agitator rod. The whole autoclave is placed in an electrically-heated air bath *H*. Autoclaves are available in capacities ranging from 200 ml. to 2 litres for use with pressures up to 350 atmospheres and to temperatures as high as 300°: special liners of Pyrex glass are supplied for use with substances which attack stainless steel or are affected by it.

A somewhat different type of high pressure reaction vessel* is illustrated in Figs. VI, 4, 3-5. This is designed for hydrogenation reactions at working pressures from 1 to 300 atmospheres (4,500 lb. per square inch) and at temperatures from atmospheric up to 400°. Fig. VI, 4, 3

* Obtainable from Parr Instrument Co., Moline, Illinois, U.S.A. An equivalent apparatus is manufactured by American Instrument Co., Silver Springs, Maryland, U.S.A., and by C. W. Cook and Sons Ltd., 97, Walsall Road, Birmingham, 22B, England.

depicts the complete apparatus. The stainless steel bomb (approximately 480 ml. capacity) is shown in Fig. VI, 4, 4, and the bomb with heating shell in Fig. VI, 4, 5. The heater is mounted on trunnions connected to a gear-head electric motor, which oscillates the bomb through an arc of 45° to "up-end the contents at the rate of 36 cycles per minute." Hydrogen may be admitted to the bomb while it is being shaken through a supply tube made of $\frac{1}{4}$ inch diameter by $\frac{1}{16}$ inch bore high pressure steel tubing, wound in a 9 inch helix. A safety plug is fitted into the

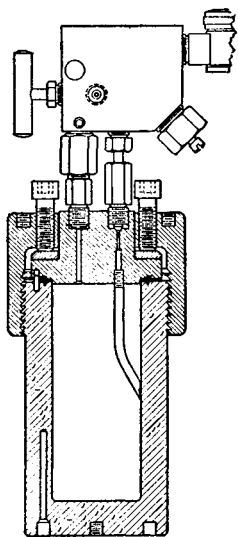

Fig. VI, 4, 4.

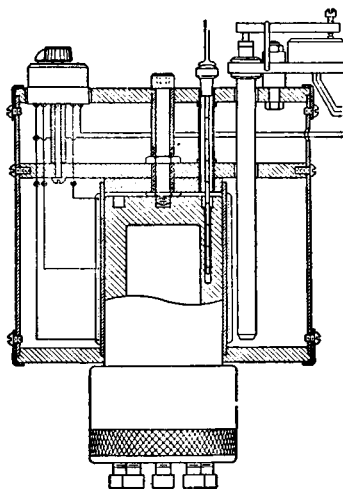

Fig. VI, 4, 5.

bomb head containing a rupturable disc which will burst at approximately 6,000 lb. per square inch. The temperature of the bomb and its contents is observed by means of a copper - constantan thermo-couple inserted in a copper cup in the bottom of the bomb. The electric heater is controlled by a variable - voltage transformer mounted on the base of the apparatus.

VI.5.

RANEY NICKEL (CATALYST)

One great advantage of hydrogenation with a platinum catalyst (compare Section III,150) is that the reaction can be controlled by the uptake of hydrogen. The introduction by Raney (1927) of a new form of nickel catalyst with enhanced activity at low pressures and temperatures in comparison with the usual form of nickel catalyst as employed by Sabatier and Senderens opened up a new field of controlled catalytic hydrogenation. A special alloy, prepared essentially by the fusion of approximately equal parts of aluminium and nickel at $1200\text{--}1500^\circ$, is treated with alkali, which dissolves the aluminium and leaves the nickel as a finely-divided black suspension. The catalyst is thoroughly washed to free it from alkali, is stored under absolute ethyl alcohol in an air-free container and is measured in the form of the suspension; it must be handled under a solvent at all times as it is highly pyrophoric. The outstanding characteristic of Raney nickel is its activity at low temperatures and low to moderate pressures: thus both acetone and styrene can be hydrogenated at 23° and 2-5 atmospheres pressures. Raney nickel is conveniently

employed for the following hydrogenations (low temperatures, and pressures usually not greater than 100 lb. per square inch) :—

- (a) olefines ;
- (b) $>C=O \longrightarrow >CHOH$;
- (c) $-CN \longrightarrow -CH_2NH_2$;
- (d) aromatic and heterocyclic rings ;
- (e) $CR_2=NOH$ (oximes) $\longrightarrow CHR_2NH_2 + H_2O$;
- (f) nitroso compounds to amines ; and
- (g) $RNO_2 \longrightarrow RNH_2$.

The advantages of this catalyst are that it is cheaper and less delicate than platinum, fairly large quantities can be hydrogenated, and the process is reasonably rapid.

It has been stated that the activity of the catalyst in low pressure hydrogenations is enhanced by the addition of small quantities of platonic chloride.

Place a solution of 190 g. of sodium hydroxide in 750 ml. of water in a 2 litre beaker equipped with an efficient stirrer (1), cool in an ice bath to 10° , and add 150 g. of nickel - aluminium alloy in small portions, with stirring, at such a rate that the temperature does not rise above 25° . If excessive foaming is encountered, add 1 ml. of *n*-octyl alcohol. When all the alloy has been introduced (about 2 hours), stop the stirrer, remove the beaker from the ice bath, and allow the contents to attain room temperature. When the evolution of hydrogen becomes slow, heat the reaction mixture gradually (2) on a water bath until the evolution again becomes slow (about 8-12 hours) ; add distilled water to restore the original volume, stir the mixture, allow to settle, and decant the supernatant liquid. Transfer the nickel to a stoppered graduated cylinder with the aid of distilled water, and decant the water again. Add a solution of 25 g. of sodium hydroxide in 250 ml. of water, shake to disperse the catalyst thoroughly, allow to settle, and decant the alkali solution. Wash the nickel by suspension in distilled water and decantation until the washings are neutral to litmus, then 10 times more to remove the alkali completely (25-40 washings are required) (3). Repeat the washing process three times with 100 ml. of rectified spirit (95 per cent. C_2H_5OH) and three times with absolute alcohol. Store the catalyst in bottles which are completely filled with absolute alcohol and tightly stoppered ; the product is highly pyrophoric and must be kept under liquid at all times. The Raney nickel contained in this suspension weighs about 75 g.

In the practical applications of Raney nickel it is more convenient to measure the catalyst than to weigh it. The product, prepared as above, contains about 0.6 g. of the catalyst per millilitre of settled material : a level teaspoonful is about 3 g. of nickel.

Notes.

(1) The stirrer should be provided with a motor which will not ignite the hydrogen—an induction motor or an air stirrer is suitable. The stirrer itself may be of glass, Monel metal or stainless steel (*cf.* Fig. II, 7, 6).

(2) The heating should not be too rapid initially or the solution may froth over.

(3) The number of washings may be reduced to about twenty, if time is allowed for diffusion of the alkali from the surface of the catalyst into the surrounding wash water. Use 750 ml. of water in each washing, allow diffusion to proceed for 3-10 minutes, stir again, and decant the supernatant liquid as soon as the catalyst settles to the bottom.

An example of the application of the Raney nickel catalyst is given in Section IV,35 (β -phenylethylamine from benzyl cyanide).

VI,6. COPPER-CHROMIUM OXIDE CATALYST

This catalyst is prepared by the decomposition of basic copper ammonium chromate; the main reactions may be written as :

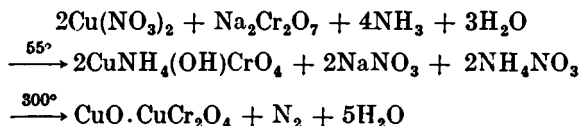

The most active varieties contain barium chromite, which is incorporated by adding barium nitrate in the preparation of the basic copper ammonium chromate: this is sometimes referred to as barium-promoted copper-chromium oxide. The barium in the catalyst gives protection against sulphate poisoning and is said to confer stabilisation against reduction. Copper-chromium oxide is an approximately equimolecular combination of cupric chromite and cupric oxide $\text{CuCr}_2\text{O}_4 \cdot \text{CuO}$; the barium-promoted catalyst contains some barium chromite. It is not a mechanical mixture of cupric chromite and cupric oxide nor is it a simple copper chromite; the catalytic activity is not due to copper chromite alone since removal of the cupric oxide with an acid leaves cupric chromite which is inactive as a catalyst for the hydrogenation of esters. Reduction of the black cupric oxide to red copper results in deactivation, as does also excessive heating which leads to cuprous chromite $\text{Cu}_2\text{Cr}_2\text{O}_4$ and oxygen. For these reasons the name "copper chromite catalyst", which is sometimes used, is misleading.

Hydrogenations with copper-chromium oxide catalyst are usually carried out in the liquid phase in stainless steel autoclaves at pressures up to 5000-6000 lb. per square inch. A solvent is not usually necessary for hydrogenation of an ester at 250° since the original ester and the alcohol or glycol produced serve as the reaction medium. However, when dealing with small quantities and also at temperatures below 200° a solvent is desirable: this may be methyl alcohol, ethyl alcohol, dioxan or methylcyclohexane.

The catalyst, which may be regarded as complementary to Raney nickel (Section VI,5) is largely used for the hydrogenation of esters (esters of mono-basic and of dibasic acids to alcohols and glycols respectively):

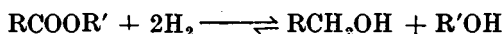

Two mechanisms have been given:—(i) hydrogenation—

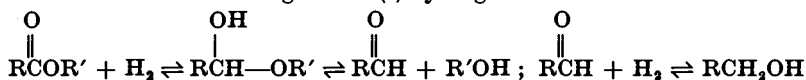

(ii) hydrogenolysis—



Other applications include :

- reduction of aldehydes and ketones to alcohols ;
- reduction of amides to amines ($\text{RCONH}_2 + 2\text{H}_2 \longrightarrow \text{RCH}_2\text{NH}_2 + \text{H}_2\text{O}$; some side reactions occur: dioxan is the best medium);
- reduction of lactones to glycols.

The catalyst is inactive for the hydrogenation of the (isolated) benzene nucleus and so may be used for the hydrogenation of aromatic compounds containing aldehyde, keto, carbalkoxy or amide groups to the corresponding alcohols, amines, etc., *e.g.*, ethyl benzoate to benzyl alcohol; methyl *p*-toluate to *p*-methylbenzyl alcohol; ethyl cinnamate to 3-phenyl-1-propanol.

Dissolve 15.5 g. of A.R. barium nitrate and 130 g. of A.R. cupric nitrate trihydrate in 450 ml. of water at 80°. Prepare a solution of sodium chromate by dissolving 89 g. of recrystallised sodium dichromate dihydrate in 200 ml. of water and adding 112.5 ml. of conc. ammonia solution (sp. gr. 0.90). Add the warm solution (80°) of nitrates in a thin stream, with stirring, to the sodium chromate solution (at 25°). Collect the orange precipitate by suction filtration, wash it with two 50 ml. portions of water, drain well, and dry at 75–80° for 12 hours; powder finely.

Equip a 500 ml. three-necked flask with a funnel for introducing a solid, a wide air condenser and a stainless steel stirrer with crescent blade, 1 cm. long and 8 cm. wide, so shaped that it conforms to the bottom of the flask. Immerse the flask in a metal bath at 350°. Add the powder through the funnel, with rapid stirring, during a period of 15 minutes. Heat with stirring at a bath temperature of 350° for 20 minutes after all the solid has been added. Leach the product by stirring for 30 minutes with 300 ml. of 10 per cent. acetic acid at room temperature. Allow to settle, decant the solution, and wash the residue with six 50–60 ml. portions of water. Filter with suction on a Buchner funnel, dry at 125° for 12 hours, and grind finely in a mortar. The yield of catalyst (a brownish-black powder) is 85 g. No special precautions are necessary in handling or storing the catalyst since it is unaffected by exposure to air or moisture.

VI.7. HEXAMETHYLENE GLYCOL (1 : 6-HEXANEDIOL)

This preparation illustrates the use of the copper-chromium oxide catalyst in the reduction of esters of dibasic acids to glycols :

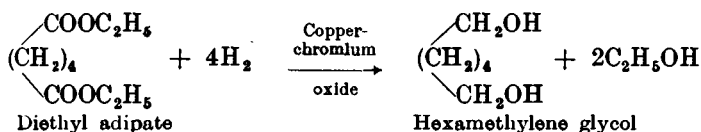

In a stainless steel autoclave (or high pressure reaction vessel *with an adequate safety factor*) (see Section VI,4; Figs. VI, 4, 2 and VI, 4, 3) and possessing a capacity of at least 250 ml., place 126 g. of diethyl adipate (Sections III,99 and III,100) and 10 g. of copper-chromium oxide catalyst. Close the reaction vessel, make it gas tight, remove the air, and introduce hydrogen until the pressure is about 2,000 lb. per square inch (1). Start the agitation, and heat as rapidly as possible to 255° and maintain this temperature. Continue the hydrogenation until hydrogen absorption is complete. As the hydrogenation proceeds, the pressure drops as indicated on the gauge: the progress of the reaction may be followed by the change in pressure readings, and the reaction is complete (after 6–12 hours) when

the pressure is constant (2). Stop the agitation, allow to cool, and release the pressure. Transfer the reaction mixture to a 400 ml. beaker with the aid of four 12 ml. portions of rectified spirit. Add 25 ml. of 40 per cent. sodium hydroxide solution to the combined alcoholic solutions, and reflux the mixture for 2 hours in order to hydrolyse any unchanged ester. Transfer the reaction mixture to a 500 ml. distilling flask and distil until the temperature of the vapour reaches 95° : this will remove the alcohol. Transfer the hot residue with the aid of 25 ml. of water to a continuous extraction apparatus (Fig. II, 44, 2) and exhaustively extract the solution with ether (36–48 hours). Remove the ether and alcohol, and distil the residue under reduced pressure. Collect the hexamethyleneglycol at $146\text{--}149^{\circ}/17$ mm.; it solidifies on cooling (m.p. $41\text{--}42^{\circ}$). The yield is 65 g. (compare Section III, 15).

Notes.

(1) The original pressure should not be more than 2,000 lb. per sq. in. if the maximum working pressure for the autoclave is 5,000 lb. The full operating pressure is not applied at the beginning because the pressure will rise as the bomb is heated: thus at 255° , the pressure will be 1.8 times that at 20° .

(2) Unless a high pressure of hydrogen is used initially or the reaction vessel is large (about 1 litre), it will be necessary to introduce more hydrogen into the reaction vessel; the pressure should not be allowed to fall below 1400–1500 lb. per sq. in. if the reaction is to run smoothly to completion.

VI.8. ETHYL β -PHENYL- β -HYDROXYPROPIONATE

(Reformatsky Reaction)

This preparation illustrates the Reformatsky reaction, which consists in the interaction of a carbonyl compound, an α -halogen ester (e.g., ethyl bromoacetate) and zinc in the presence of ether or benzene, followed by hydrolysis.

Thus :

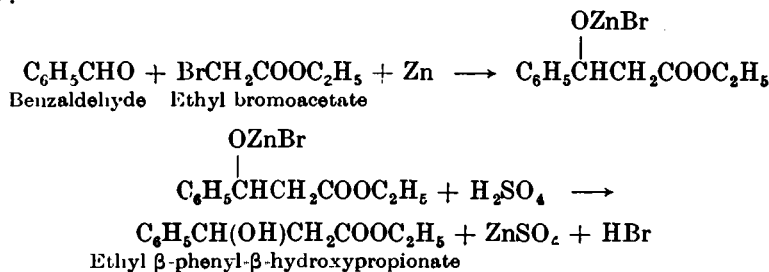

It may be pointed out that dehydration of β -hydroxy esters with fused potassium hydrogen sulphate, acetic anhydride, phosphoric oxide or with thionyl chloride in benzene solution leads to $\alpha\beta$ -unsaturated esters containing some $\beta\gamma$ -unsaturated ester; the proportion of the latter depends not only upon the structure of the ester but also upon the dehydrating agent used. Dehydration occasionally occurs during the reaction itself or upon attempted distillation.

It is probable that the reaction proceeds through an organic zinc derivative, analogous to a Grignard reagent, formed by interaction of the α -halogen ester

with the zinc ; this organic zinc compound then adds to the aldehyde or ketone exactly as does a Grignard reagent.

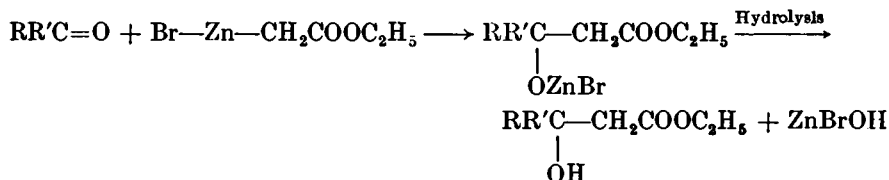

It is essential that all the apparatus and the reagents be scrupulously dry for successful results (compare Grignard reaction). Equip a 500 ml. three-necked flask with a 250 ml. separatory funnel, a mechanical stirrer, and a double surface condenser ; insert calcium chloride (or absorbent cotton wool) guard tubes in the funnel and condenser respectively. Place 40 g. of zinc wool (previously dried at 100°) in the flask, and a solution of 83.5 g. (55.5 ml.) of ethyl bromoacetate (Section III, 126 ; *CAUTION*—lachrymatory) (1) and 65 g. (62 ml.) of purified benzaldehyde (Section IV, 115) in 80 ml. of sodium-dried benzene and 20 ml. of sodium-dried ether in the separatory funnel. Add about 10 ml. of the solution to the zinc and warm the flask gently until the reaction starts. When the reaction has commenced, but not before, stir the mixture and add the remainder of the solution at such a rate that moderate refluxing occurs (about 1 hour). Reflux the reaction mixture on a water bath for a further 30 minutes. Cool the flask in an ice bath, and add 200 ml. of cold 10 per cent. sulphuric acid with vigorous stirring. Transfer to a separatory funnel, remove the aqueous layer, wash the benzene layer twice with 50 ml. portions of 5 per cent. sulphuric acid, once with 25 ml. of 10 per cent. sodium carbonate solution, and finally with two 25 ml. portions of water. Extract the combined acid solutions with 100 ml. of ether, and dry the combined benzene and ether solution with 5 g. of anhydrous magnesium or calcium sulphate. Filter from the desiccant, remove the solvent by distillation under atmospheric pressure from a water bath (Fig. II, 13, 4 but with Claisen flask) and distil the residue under reduced pressure. Collect the ethyl β -phenyl- β -hydroxypropionate at 152–154°/12 mm. The yield is 60 g.

Note.

(1) Great care must be exercised in handling ethyl bromoacetate. Keep a 10 per cent. aqueous ammonia solution available to react with any bromoester which may be spilled.

COGNATE PREPARATION

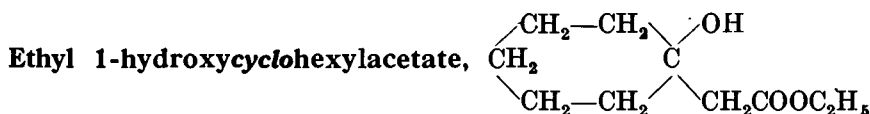

Place 65 g. of clean dry zinc wool and a few crystals of iodine in a 2.5 litre three-necked flask, equipped with an efficient reflux condenser with drying tube, a mechanical stirrer, and a dropping funnel. Prepare a mixture

of 400 ml. of sodium-dried benzene and 350 ml. of sodium-dried toluene with 167 g. (111 ml.) of ethyl bromoacetate and 98 g. (103.5 ml.) of pure *cyclohexanone* (compare Section III, 74, A). Transfer 150 ml. of this mixture to the flask, start the stirrer and heat the flask in a boiling water bath. A vigorous reaction soon sets in. Add the remainder of the mixture through the dropping funnel at such a rate that gentle refluxing is maintained. Continue the stirring for an additional 2 hours: practically all the zinc dissolves. Cool the mixture, add sufficient 10 per cent. sulphuric acid with stirring to dissolve all the zinc hydroxide. Separate the benzene-toluene layer, dry it with anhydrous sodium or magnesium sulphate, and distil under low pressure. Collect the ethyl 1-hydroxy-*cyclohexylacetate* at 86–89°/2 mm. The yield is 125 g.

VI.9. $\beta\beta$ -DIMETHYLGLUTARIC ACID (*Guareschi Reaction*)

When acetone is condensed with ethyl cyanoacetate in the presence of a solution of anhydrous ammonia in absolute alcohol at -5° , the ammonium salt of the dicyano-imide (I) is precipitated. Upon dissolving this salt in water and adding excess of concentrated hydrochloric acid, the crystalline dicyano-imide (II) is obtained. Hydrolysis of the last-named with strong sulphuric acid affords $\beta\beta$ -dimethylglutaric acid (III).

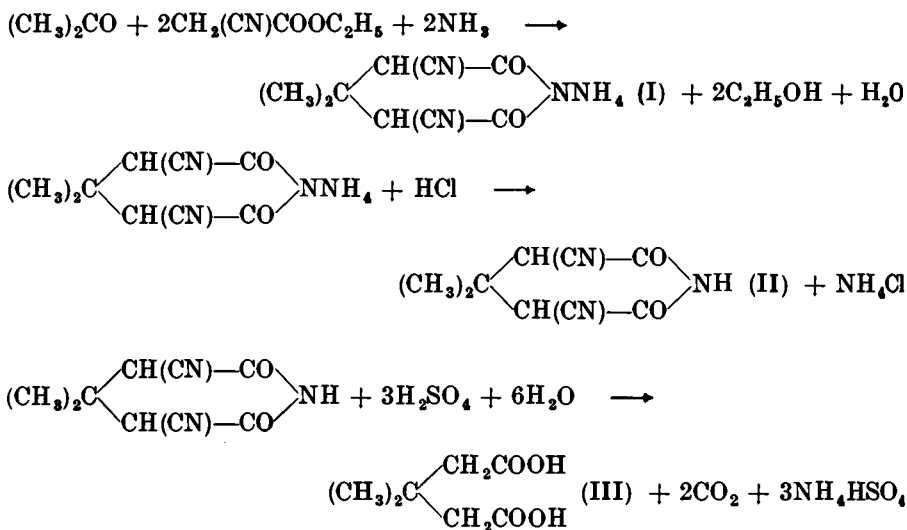

The above is an example of the *Guareschi reaction*. It is applicable to most dialkyl ketones and to alicyclic ketones (*e.g.*, *cyclohexanone*, *cyclopentanone*, etc.). The condensation product (I) is probably formed by a simple Knoevenagel reaction of the ketone and ethyl cyanoacetate to yield ethyl α -cyano- $\beta\beta$ -dimethylacrylate $(\text{CH}_3)_2\text{C}=\text{C}(\text{CN})\text{COOC}_2\text{H}_5$, followed by a Michael addition of a second molecule of ethyl cyanoacetate; finally, the carbethoxyl groups are converted to the cyclic imide structure by the action of ammonia.

Place 200 ml. of absolute ethyl alcohol in a 500 ml. all-glass wash bottle, and cool to -5° by immersion in a bath of ice and salt. Pass a slow stream of ammonia, derived from a cylinder and dried by passage through a tower filled with small pieces of quicklime, into the alcohol until the

latter is saturated (about 4–5 hours); when necessary, siphon off the water formed in the freezing mixture and add more crushed ice. The volume of the alcohol will increase to about 250 ml. and about 17 g. of ammonia is absorbed. Meanwhile weigh out 113 g. of ethyl cyanoacetate (Section III,131) and 29 g. of pure dry acetone into a 500 or 750 ml. wide-mouthed, ground-stoppered bottle and cool it by immersion in a bath of ice and salt for about 2 hours. Add the alcoholic ammonia solution to the cold contents of the bottle, replace the stopper and transfer the bottle and bath to a ice chest; place a brick or some other heavy weight on the stopper of the bottle to hold it firmly in position. After three days, when a considerable amount of white solid (the ammonium salt of the "Guareschi imide") has separated, filter at the pump and rinse the bottle with the filtrate until all the solid has been transferred to the filter. Drain well by pressing the solid with a large glass stopper, and then stir it with several small volumes of dry ether (sucking dry after each addition) in order to remove the excess of ketone and ethyl cyanoacetate. Dry the solid in the air for several hours in order to remove the ether completely, then dissolve it in the minimum volume of boiling water (350–400 ml.), and add concentrated hydrochloric acid (*FUME CUPBOARD!*) until the mixture is acid to Congo red paper and then add a further 50 ml. Allow to cool, filter off the dicyano-imide, wash with a little water, and dry upon clock glasses in the steam oven or at 100°. The yield of the dicyano-imide is 65 g.

Dissolve 64 g. ($\frac{1}{3}$ g. mol) of the *finely-powdered* dicyano-imide in 160 ml. of concentrated sulphuric acid in a 1-litre round-bottomed flask; *gentle* warming may be necessary and a clear reddish-brown solution is obtained. Keep the solution overnight and then add 150 ml. of water slowly and with frequent shaking. Attach a reflux condenser to the flask and heat very gently at first owing to the attendant frothing, which subsides after 2–3 hours. Heat the mixture under reflux for a total period of 18–24 hours and shake well at intervals of 3 hours. The acid separates upon cooling: collect it on a sintered glass funnel. It may be dried at about 90°; the yield of crude acid is nearly quantitative. To remove small quantities of imides which may be present, treat the crude acid with excess of saturated sodium bicarbonate solution, filter from any imide, strongly acidify with concentrated hydrochloric acid, saturate the solution with ammonium sulphate, and extract the acid with three or four 200 ml. portions of ether. Dry the ethereal extract with anhydrous sodium or magnesium sulphate and distil off the ether. Recrystallise the residual acid from concentrated hydrochloric acid, and dry at 70°. Pure $\beta\beta$ -dimethylglutaric acid, m.p. 101°, is obtained.

VI.10. REDUCTIONS WITH LITHIUM ALUMINIUM HYDRIDE

Lithium aluminium hydride LiAlH_4 is a useful and convenient reagent for the selective reduction of the carbonyl group and of various other polar functional groups. It is obtained by treatment of finely powdered lithium hydride with an ethereal solution of anhydrous aluminium chloride:

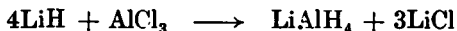

The compound is generally employed in solution in dry ether; this solution is conducting and the reduction may be due to the transfer of a hydride ion:

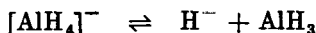

The purpose of the ether may be to coordinate with the aluminium hydride and to facilitate the forward reaction in the first instance: subsequently coordination may occur with other anions available in the solution.

Some of the functional groups which are reduced by lithium aluminium hydride, the reduction product together with the theoretical mols of reducing agent required (in parenthesis) are listed below:—

aldehyde \longrightarrow primary alcohol (0.25); ketone \longrightarrow secondary alcohol (0.25); epoxide \longrightarrow alcohol (0.25); ester \longrightarrow primary alcohol (0.5); lactone \longrightarrow diol (0.5); carboxylic acid \longrightarrow primary alcohol (0.75); anhydride \longrightarrow primary alcohol (1.0); amide (CONH_2) \longrightarrow primary amine (1.0); nitrile \longrightarrow primary amine (1.0); acid chloride \longrightarrow primary alcohol (0.5); and alkyl chloride \longrightarrow hydrocarbon (0.25). Its most frequent use is for the reduction of esters, acids, aldehydes and ketones to the corresponding alcohols. It is of value for the reduction of unsaturated carbonyl compounds to unsaturated alcohols (*e.g.*, crotonaldehyde to crotyl alcohol—compare Section VI,12); also for the reduction of sensitive ketones (*e.g.*, acetyl*cyclo*propane) and hindered ketones (*e.g.*, acetomesitylene).

The following intermediate compounds in some reductions with lithium aluminium hydride have been formulated:

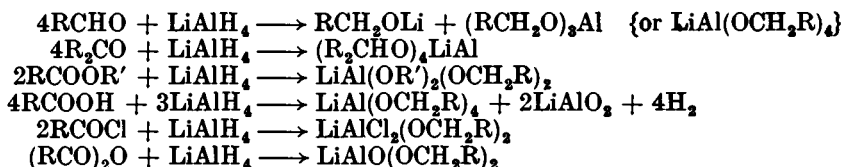

Experimental details for the following reductions are given below:

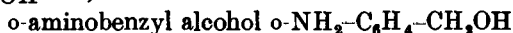
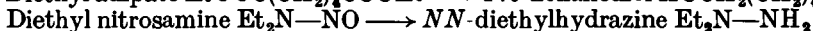
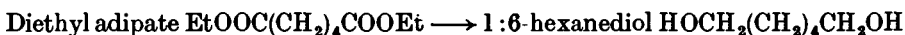

The experimental conditions for the reduction are similar to those for the Grignard reaction. For compounds which are readily soluble in ether, a solution of the compound in dry ether is added to an ethereal solution of lithium aluminium hydride (excess) at such a rate that the reaction mixture boils gently. When the reduction is complete, the excess of the reagent is decomposed by the cautious addition of moist ether, an ethanol-ether mixture or by the dropwise addition of cold water with vigorous stirring: when water is used, it is desirable to employ a large flask because of the foaming which takes place. On the whole it is best to employ ethyl acetate, as its reduction product (ethanol) does not interfere in the subsequent isolation and no hydrogen is evolved. The reaction mixture is then poured gradually into excess of ice-cold dilute sulphuric acid to decompose the complex aluminium compounds and to dissolve the precipitated aluminium hydroxide; the product is usually in the ethereal layer but, if it is water-soluble, must be isolated from the aqueous solution. For bases, after extraction of any neutral or acidic products, the solution is rendered alkaline with 10*N* sodium hydroxide and the whole (including the precipitated aluminium hydroxide) is extracted with ether. For compounds which are slightly or sparingly soluble in ether, a Soxhlet apparatus is inserted between the flask and the reflux condenser and the compound is placed in the Soxhlet

thimble. In addition to ether, tetrahydrofuran has been used as a solvent for lithium aluminium hydride. The approximate solubilities in diethyl ether, tetrahydrofuran and di-*n*-butyl ether are 25–30 g., 13 g. and 2 g. respectively per 100 g. of solvent at 25°.

Lithium aluminium hydride reacts violently with water and *must be treated as a dangerous chemical* :

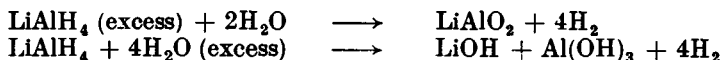

Operations with it must be conducted in a dry apparatus and with dry solvents. Owing to the toxic properties of the finely powdered solid, it must be weighed out in the fume cupboard. Adequate provision should be made to discharge hydrogen gas from the reaction mixture to the atmosphere or fume cupboard exhaust without risk from nearby flames, hot plates, etc. The solid reacts superficially with atmospheric moisture and carbon dioxide; in ether solution, it reacts slowly with atmospheric oxygen, liberating hydrogen. The finely powdered reagent is available commercially and is kept under nitrogen; it should all be used once the tin is opened. Only dry sand may be used to extinguish solid lithium aluminium hydride which has caught fire.

Hexamethylene glycol (1:6-hexanediol). All the apparatus and reagents must be thoroughly dry. Set up in a dry vessel (to serve later as a water bath) in the fume cupboard a 1500 ml. three-necked flask with a mercury-sealed stirrer, a 250 ml. dropping funnel and a double surface condenser (compare Fig. II, 7, 11, *a*): attach guard tubes (containing anhydrous calcium chloride or cotton wool) to the open ends of the condenser and dropping funnel. The mechanical stirrer should be a powerful one. It must be emphasised that all operations, including weighing, with solid lithium aluminium hydride must be conducted in the fume cupboard; during weighing, etc., the front of the fume chamber is pulled down so that there is a narrow opening to allow the student's hands to enter.

Weigh out 10.5 g. of lithium aluminium hydride into a clean, dry mortar and powder it finely, if necessary, with a glass pestle. Remove the dropping funnel and replace it by a funnel with a very short wide stem; introduce the solid into the flask through this funnel and use about 300 ml. of sodium-dried ether to transfer the last traces of lithium aluminium hydride; replace the dropping funnel and guard tube. Destroy any residual solid on the pestle or in the mortar (1). Set the stirrer in motion and place a solution of 50 g. of freshly distilled diethyl adipate, b.p. 133–135°/14 mm. (Sections III, 99–100) in 150 ml. of anhydrous ether in the dropping funnel. After stirring for 10 minutes (some lithium aluminium hydride may remain undissolved), add the diethyl adipate solution at such a rate that the ether refluxes gently; the reaction mixture rapidly becomes viscous and four 50 ml. portions of anhydrous ether must be added during the reduction to facilitate stirring. Continue the stirring for 10 minutes after the diethyl adipate has been added. Decompose the excess of lithium aluminium hydride by the dropwise addition, with stirring, either of 75 ml. of water (2) or, preferably, by the more rapid addition of 22 g. (24.5 ml.) of ethyl acetate. Filter the reaction product from the sludge through a sintered glass funnel; dry the ethereal solution with anhydrous magnesium sulphate and distil off the ether on a water bath; the colourless viscous residue (18.5 g.) solidifies completely on cooling and has m.p.

41–42°, *i.e.*, is pure hexamethylene glycol. Dissolve the sludge remaining in the filter funnel in 20 per cent. sulphuric acid; extract the resulting solution with six 100 ml. portions of ether or use a continuous ether extractor (Fig. II, 44, 2). Distil off the ether on a water bath; the residue (6 g.) crystallises completely upon cooling, m.p. 41–42°. The total yield of hexamethylene glycol is therefore 24.5 g.; it boils sharply at 136–137°/10 mm.

Notes.

(1) The residual reagent must be carefully destroyed. That remaining in the mortar is slowly dropped into about 2 litres of water in a large beaker. The solid adhering to the pestle should be scraped off and added gradually to excess of water.

(2) Before adding water, remove the calcium chloride guard tubes and fit the reflux condenser with a long tube extending to the duct at the top of the fume cupboard (hood); this will carry the escaping hydrogen above the motor of the stirrer. A spark-proof stirring motor is recommended and should be used, if available. The dropwise addition of water must be conducted whilst the mixture is stirred vigorously; foaming may occur and the reaction may be moderated by filling the bath surrounding the reaction vessel with cold water.

NN-Diethylhydrazine. Fit a 1-litre three-necked flask with a double surface reflux condenser, a mercury-sealed stirrer and a dropping funnel, and insert calcium chloride guard tubes into the openings of the reflux condenser and dropping funnel. The apparatus must be dry. Place 10.0 g. of finely powdered lithium aluminium hydride and 500 ml. of sodium-dried ether in the flask, stir for 10 minutes, and add a solution of 23.5 g. of diethyl nitrosamine (Section III, 124) in 135 ml. of anhydrous ether at the rate of 2–3 drops per second. After about 20 minutes, the ether refluxes gently and a white solid separates: henceforth adjust the rate of addition to maintain the reaction under control. After the addition of the nitrosamine is complete (about 1 hour), continue the vigorous stirring for 10 minutes, and then add an excess of ethyl acetate to decompose the residual lithium aluminium hydride. Now introduce 50 ml. of 10*N* sodium hydroxide solution, stir for 10 minutes, filter with suction, and wash the residue with two 50 ml. portions of ether. Dry the combined filtrate and washings first over potassium hydroxide pellets and then over anhydrous calcium sulphate, distil through an efficient fractionating column (*e.g.*, a 10" vacuum-jacketed Widmer column) and collect the *as*-diethylhydrazine at 98–99.5°. The yield is 10 g.

***o*-Aminobenzyl alcohol.** This preparation illustrates the reduction of a compound of low solubility in ether. Equip a 2-litre three-necked flask with a mercury-sealed stirrer and a Soxhlet extractor surmounted by an efficient reflux condenser; stopper the third neck. Attach a wide-bore drying tube to the opening of the reflux condenser. The apparatus must be dry. Place 9.1 g. of finely powdered lithium aluminium hydride and 600 ml. of anhydrous ether in the flask and 13.7 g. of pure anthranilic acid in the extraction thimble. Maintain the ether at a moderate rate of boiling by means of an electric heating mantle until the acid in the thimble dissolves completely. Allow the flask to cool, remove the Soxhlet extractor and insert the reflux condenser directly into the flask; place a dropping funnel in the opening previously stoppered. Add sufficient ethyl acetate cautiously, with vigorous stirring, to decompose the excess of lithium aluminium hydride. Then introduce 250 ml. of 2.5*N* sodium hydroxide

solution. Separate the ether layer, extract the aqueous layer with two 200 ml. portions of ether, and dry the combined ethereal solutions with anhydrous magnesium sulphate. Distil off the ether and dry the residue in a vacuum desiccator. The resulting *o*-aminobenzyl alcohol has m.p. 82° and weighs 12.0 g.

VI.11. REDUCTIONS WITH POTASSIUM (OR SODIUM) BOROXYDRIDE

Potassium and sodium borohydride show greater selectivity in action than lithium aluminium hydride: thus ketones or aldehydes may be reduced to alcohols whilst the cyano, nitro, amido and carbalkoxy groups remain unaffected. Furthermore, the reagent may be used in aqueous or aqueous-alcoholic solution. One simple application of its use will be described, *viz.*, the reduction of *m*-nitrobenzaldehyde to *m*-nitrobenzyl alcohol:

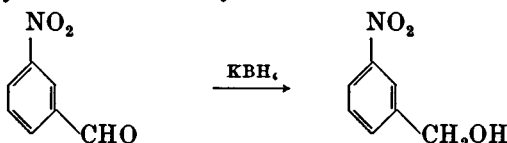

m*-Nitrobenzyl alcohol. Clamp a 500 ml. three-necked flask, equipped with a mechanical stirrer, a thermometer and a burette, above the bench so that an ice bath can be placed beneath it. Place a solution of 15.1 g. of *m*-nitrobenzaldehyde (1) in 100 ml. of methanol in the flask and, whilst stirring, add a solution of potassium borohydride (2.0 g. of KBH_4 in 2 ml. of 2*N* sodium hydroxide diluted with 18 ml. of water) at the rate of 0.5 ml. per minute, with occasional cooling to keep the reaction at 18–25°. When about three-quarters of the solution has been added, there is no further tendency for the temperature to rise, and the addition is stopped. Treat a small portion of the reaction mixture with dilute sulphuric acid: hydrogen should be evolved.

Remove most of the methanol by distillation on a steam bath, and dilute the residue with 100 ml. of water. Extract the mixture with ether, wash the upper layer with water, and dry it rapidly with a little anhydrous magnesium sulphate. Remove the ether by "flash distillation", and distil the residual pale yellow oil under diminished pressure. Collect the *m*-nitrobenzyl alcohol at 183–185°/17 mm.; it solidifies to a pale yellow solid, m.p. 30°, when cooled in ice. The yield is 13 g.

Note.

(1) *m*-Nitrobenzaldehyde may be prepared as follows. Place 250 ml. of concentrated sulphuric acid and 21.5 ml. of fuming nitric acid, sp. gr. 1.5, in a 500 ml. three-necked flask fitted with a mechanical stirrer (unsealed) and a dropping funnel. Stir and cool to 0° in a bath of ice and salt. Add 62.5 g. (60 ml.) of purified benzaldehyde dropwise from the dropping funnel; do not allow the temperature to rise above 5°. Then warm the mixture gradually to 40°, cool to room temperature, and pour in a thin stream with vigorous stirring on to finely crushed ice. Filter through a sintered glass funnel, wash with a little water, press out the oil with a wide glass stopper, and dry in the air upon absorbent paper. The resulting crude *m*-nitrobenzaldehyde weighs 55 g. and melts at 48–50°. Melt the crude solid under excess of 10 per cent. sodium carbonate solution, stir, cool, filter and dry in the air: the

* The experimental details were kindly provided by the Chemical Research Laboratories of May and Baker Ltd., Dagenham.

product has m.p. 51–52°. Dissolve the solid in 120 ml. of hot benzene under reflux, decant from any solid present, and add light petroleum, b.p. 40–60°, until a slight turbidity results and cool. Collect the pure *m*-nitrobenzaldehyde and dry in the air; the yield is 45 g., m.p. 58°. A further quantity may be obtained by concentrating the mother liquor.

VI.12. REDUCTIONS WITH ALUMINIUM ALKOXIDES

Aldehydes and ketones can be reduced smoothly to the corresponding alcohols by aluminium alkoxides. The most satisfactory alkoxide for general use is aluminium *isopropoxide* :

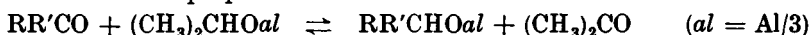

The carbonyl compound to be reduced is heated with aluminium *isopropoxide* in excess of *isopropyl alcohol* under a simple fractionating column with provision for slow distillation until no more acetone is detected in the distillate; the alcoholic reduction product is recovered from the reaction mixture after acidification. The process is usually termed the **Meerwein - Ponndorf - Verley reduction**. This mild and speedy method of reducing carbonyl compounds in good yield is particularly valuable since other groups, *e.g.*, an $\alpha\beta$ -double bond, a nitro group or a halogen atom, are unaffected. Experimental details for the following preparations are given :

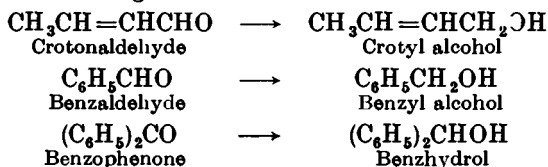

The undermentioned reductions may be carried out by simple adaptations to the procedures: chloral to trichloroethyl alcohol; *m*-nitroacetophenone of α -methyl-3-nitrobenzyl alcohol; and *o*-nitrobenzaldehyde to *o*-nitrobenzyl alcohol.

The above reversible equation indicates that one mol of aluminium *isopropoxide* will reduce directly three mols of the carbonyl compound. It is generally desirable to use excess of the reductant except for aromatic aldehydes; for the latter side reactions (*e.g.*, $2RCHO \longrightarrow RCOOCH_2R$; Tischenko reaction) tend to occur with excess of the reagent.

The following *mechanism* of the reaction has been suggested; it includes the coordination of the carbonyl compound with the aluminium atom in aluminium *isopropoxide* and the transfer of a hydride ion :

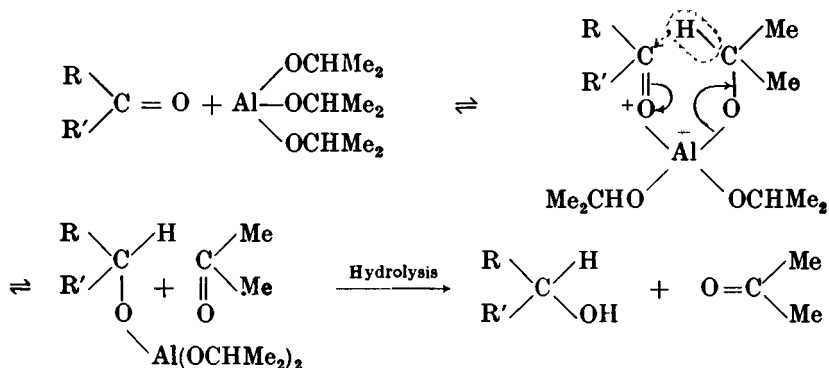

Preparation of aluminium isopropoxide. Place 27.5 g. of clean aluminium foil in a 1 litre round-bottomed flask containing 300 ml. of anhydrous isopropyl alcohol (*e.g.*, refluxed with and distilled from lime) and 0.5 g. of mercuric chloride. Attach an efficient (for example, double surface) reflux condenser carrying a calcium chloride (or cotton wool) guard tube. Heat the mixture on a water bath or upon a hot plate. When the liquid is boiling, add 2 ml. of carbon tetrachloride (a catalyst for the reaction between aluminium and dry alcohols) through the condenser, and continue the heating. The mixture turns grey and, within a few minutes, a vigorous evolution of hydrogen commences. Discontinue the heating: it may be necessary to moderate the reaction by cooling the flask in ice water or in running tap water. After the reaction has slowed down, reflux the mixture until all the metal has reacted (6–12 hours). The mixture becomes dark because of the presence of suspended particles.* Pour the hot solution into a 500 ml. Claisen flask attached to a water condenser with a 250 ml. filter flask or distilling flask as receiver. Add a few fragments of porous porcelain and heat the flask in an oil bath at 90° under slightly diminished pressure (water pump). When nearly all the isopropyl alcohol has distilled over, raise the temperature of the bath to 170° and lower the pressure gradually to the full vacuum of the water pump. Immediately the temperature of the distillate rises above 90°, stop the distillation and remove the condenser. Attach a 500 ml. distilling flask directly to the Claisen flask, add a few fresh boiling chips and distil: use either an oil bath at 180–190° or an air bath (Fig. II, 5, 3). The aluminium isopropoxide passes over as a colourless viscid liquid at 140–150°/12 mm.; the yield is 190 g. Pour the molten aluminium isopropoxide into a wide-mouthed, glass-stoppered bottle and seal the bottle with paraffin wax (or with cellophane tape) to exclude moisture. Generally the alkoxide (m.p. 118°) crystallises out, but the substance exhibits a great tendency to supercool and it may be necessary to cool to 0° for 1–2 days before solidification occurs.

The reagent is conveniently stored as a solution in isopropyl alcohol. The molten (or solid) alkoxide is weighed out after distillation into a glass-stoppered bottle or flask and is dissolved in sufficient dry isopropyl alcohol to give a one molar solution. This solution may be kept without appreciable deterioration provided the glass stopper is sealed with paraffin wax or cellophane tape. Crystals of aluminium isopropoxide separate on standing, but these may be redissolved by warming the mixture to 65–70°.

For many reductions it is not necessary to distil the reagent. Dilute the dark solution, prepared as above to the point marked with an asterisk, to 1 litre with dry isopropyl alcohol; this gives an approximately one molar solution. Alternatively, prepare the quantity necessary for the reduction, using the appropriate proportions of the reagents.

CROTYL ALCOHOL

This preparation illustrates the method to be adopted for aldehydes of boiling point below about 150°.

Prepare a solution of aluminium isopropoxide from 23.5 g. of aluminium, 0.5 g. of mercuric chloride and 250 ml. of dry isopropyl alcohol;

* These, in general, have no influence on the subsequent preparation.

add 105 g. of redistilled crotonaldehyde, b.p. 102–103° (Section III,141) and 500 ml. of dry *isopropyl* alcohol. Attach an efficient fractionating column (*e.g.*, Fig. II, 15, 2; II, 15, 3; II, 15, 5; or II, 17, 1) to the flask and arrange for distillation from an oil bath (*cf.* Fig. II, 16, 1) so that the acetone distils as it is formed. Maintain the temperature of the bath at about 110° and the temperature at the top of the column at 60–70°. When the distillate no longer gives a test for acetone (8–9 hours) (1), distil off most of the remaining *isopropyl* alcohol, preferably under reduced pressure. Cool the residue to 40° and add 450 ml. of cold 6*N* sulphuric acid (from 72.5 ml. of concentrated sulphuric acid and 395 ml. of water); cooling is necessary. Separate the upper oily layer, wash it once with water, and distil at 60–70° whilst lowering the pressure slowly from about 275 mm. to 60 mm.; then continue the distillation to 100° and 20 mm. In this way the crotyl alcohol (*A*) is separated from the higher boiling polymerisation products. Combine the aqueous layers and distil until the distillate no longer gives a test for unsaturation with a dilute solution of bromine in carbon tetrachloride. Saturate the aqueous distillate with potassium carbonate, separate the oily layer and add it to (*A*). Dry with 5 g. of anhydrous potassium carbonate, decant the oil and distil through an efficient fractionating column. Collect the crotyl alcohol at 119–121°. The yield is 65 g.

Note.

(1) The acetone test reagent consists of a 0.1 per cent. solution of 2 : 4-dinitrophenylhydrazine and is prepared as follows : Dissolve 0.25 g. of 2 : 4-dinitrophenylhydrazine in 50 ml. of water and 42 ml. of concentrated hydrochloric acid by warming on a water bath; cool the clear yellow solution and dilute to 250 ml. with water. The acetone test is considered negative when 5 ml. of the reagent and 4–5 drops of the distillate give no cloudiness or precipitate of acetone 2 : 4-dinitrophenylhydrazone within 30 seconds. After a negative test is obtained, it is strongly recommended that the mixture in the flask be refluxed for 5–10 minutes with complete condensation and then to collect a few drops of distillate for another test. If no acetone is now detected, the reduction is complete.

The above test will detect 1 part of acetone in 500–1000 parts of *isopropyl* alcohol. The reagent should not be kept for more than 1–2 months since it deteriorates upon keeping.

BENZYL ALCOHOL

This preparation illustrates the reduction of an aromatic aldehyde.

Place 35 ml. of a 1*M* solution of aluminium *isopropoxide* or 7 g. of solid aluminium *isopropoxide*, 450 ml. of dry *isopropyl* alcohol and 21 g. of purified benzaldehyde (Section IV,115) in a 1 litre round-bottomed flask. Fit a short reflux condenser (no water in the cooling jacket) or better a Hahn condenser (2) (containing a 1 cm. layer of ethyl alcohol in the inner tube) to the flask and arrange for slow distillation from a water bath at the rate of 3–6 drops per minute. Continue the heating until a negative test for acetone is obtained after 5 minutes of total reflux (6–9 hours); if the volume of the mixture falls below 200 ml. during the reduction, add more *isopropyl* alcohol. Remove the reflux or Hahn condenser and distil off (Fig. II, 13, 3) most of the *isopropyl* alcohol under atmospheric pressure from a suitable oil bath. Hydrolyse the

add cold dilute hydrochloric acid (from 35 ml. of the concentrated acid and 175 ml. of water) slowly and with frequent shaking. Extract the benzhydrol which separates with ether or with benzene, wash the extract with cold dilute hydrochloric acid, then with water, and dry. Remove the solvent; the residual benzhydrol weighs 18 g. Recrystallise it from 20 ml. of hot alcohol or from 50 ml. of light petroleum (b.p. 60–80°) containing a little benzene, and cool in ice: 17.5 g. of pure benzhydrol, m.p. 68°, are obtained.

Recovery of the isopropyl alcohol. It is not usually economical to recover the isopropyl alcohol because of its low cost. However, if the alcohol is to be recovered, great care must be exercised particularly if it has been allowed to stand for several days: peroxides are readily formed in the impure acetone-isopropyl alcohol mixtures. Test first for peroxides by adding 0.5 ml. of the isopropyl alcohol to 1 ml. of 10 per cent. potassium iodide solution acidified with 0.5 ml. of dilute (1:5) hydrochloric acid and mixed with a few drops of starch solution: if a blue (or blue-black) coloration appears in one minute, the test is positive. One convenient method of removing the peroxides is to reflux each one litre of recovered isopropyl alcohol with 10–15 g. of solid stannous chloride for half an hour. Test for peroxides with a portion of the cooled solution: if iodine is liberated, add further 5 g. portions of stannous chloride followed by refluxing for half-hour periods until the test is negative. Then add about 200 g. of quicklime, reflux for 4 hours, and distil (Fig. 11, 47, 2); discard the first portion of the distillate until the test for acetone is negative (*Crotyl Alcohol, Note 1*). Peroxides generally redevelop in this purified isopropyl alcohol in several days.

VI.13 THE OPPENAUER OXIDATION

Secondary alcohols may be oxidised to the corresponding ketones with aluminium *tert.*-butoxide (or isopropoxide) in the presence of a large excess of acetone. This reaction is known as the Oppenauer oxidation and is the reverse of the Meerwein-Ponndorf-Verley reduction (previous Section); it may be expressed:

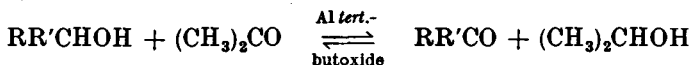

Acetone in conjunction with benzene as a solvent is widely employed. With cyclohexanone as the hydrogen acceptor, coupled with toluene or xylene as solvent, the use of higher reaction temperatures is possible and consequently the reaction time is considerably reduced; furthermore, the excess of cyclohexanone can be easily separated from the reaction product by steam distillation. At least 0.25 mol of alkoxide per mol of alcohol is used: however, since an excess of alkoxide has no detrimental effect 1 to 3 mols of aluminium alkoxide is recommended, particularly as water, either present in the reagents or formed during secondary reactions, will remove an equivalent quantity of the reagent. In the oxidation of steroids 50–200 mols of acetone or 10–20 mols of cyclohexanone are generally employed.

The Oppenauer oxidation has found wide application in investigations on steroids and related natural products. Its great advantage is that very mild conditions are utilised which are applicable to a variety of sensitive compounds: thus when other oxidisable groups, *e.g.*, olefinic bonds, are present in the molecule, they are usually unaffected. Among non-steroidal alcohols, both *cis* and *trans* decalols are converted in excellent yield to the corresponding decalones. The reaction has been extended to the conversion of unsaturated primary alcohols to the corresponding aldehydes by using quinone as the acceptor.

traces under reduced pressure (water pump). Allow the flask to cool with drying tube attached, crush the product with a spatula, and transfer it to a small bottle : seal the latter against moisture. The yield of white or pale gray aluminium *tert.*-butoxide is 105 g.

Cholestenone. Place a mixture of 20 g. of purified cholesterol (m.p. 149°–150° ; dried to constant weight at 80–100°), 150 ml. of A.R. acetone and 200 ml. of sodium-dried benzene in a dry 1-litre round-bottomed flask fitted with a reflux condenser and calcium chloride guard tube. Introduce a "boiling tube" (Fig. I, 3, 1) to prevent bumping. Heat the mixture to boiling in an oil bath at 75–85°, add a solution of 16 g. of aluminium *tert.*-butoxide in 100 ml. of anhydrous benzene in one portion to the boiling solution. The mixture becomes cloudy and develops a yellow colour in 10 to 15 minutes. Continue gentle boiling at a bath temperature of 75–85° for 8 hours. Treat the cold mixture with 40 ml. of water, then with 100 ml. of 10 per cent. sulphuric acid, shake vigorously and transfer to a 1-litre separatory funnel. Dilute the mixture with 300 ml. of water, shake for 5 minutes (filter, if necessary), then run off the yellow aqueous layer into a second separatory funnel and extract the latter with 25 ml. of benzene. Wash the combined benzene extracts thoroughly with water, dry with anhydrous magnesium sulphate and remove the solvent (steam bath ; final traces at 60° under vacuum of water pump). The yellow oily residue solidifies when it is cooled in an ice-salt bath and scratched with a glass rod ; keep a small portion for "seeding" in the subsequent crystallisation. Dissolve the solid in a warm mixture of 14 ml. of acetone and 20 ml. of methanol, allow the solution to cool very slowly and seed, if necessary. When the bulk of the solid has crystallised, keep the mixture at 0° for 24 hours, filter with suction, wash with 20 ml. of ice-cold methanol, and dry in a vacuum desiccator. The yield of almost colourless cholestenone, m.p. 79–80°, is 17 g.

VI,14. OXIDATION OF UNSATURATED COMPOUNDS WITH OZONISED OXYGEN (OZONOLYSIS)

For the determination of the structure of unsaturated compounds, oxidation with ozone (as ozonised oxygen) possesses many advantages. Ozonolysis, unlike oxidation with excess of permanganate or chromic acid which, for example, will also oxidise primary and secondary alcohols, is a highly specific process. By passing ozonised oxygen through a solution of an ethylenic compound in an inert solvent, preferably at a low temperature, ozone adds on readily and quantitatively to the double bond to give an ozonide (I) :

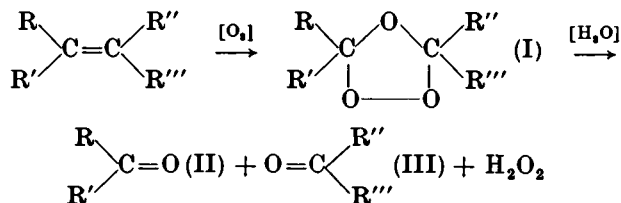

(Excess of ozone should be avoided since further oxidation may occur to "oxozonides" or "perozonides.") The ozonides are usually not isolated since they are generally viscid oils or glasses, sometimes with violently explosive properties particularly on warming. They can, however, be completely

characterised by identifying the products of decomposition (II and III) by water or, preferably, by catalytic reduction. The decomposition with water produces some hydrogen peroxide, so that if an aldehyde is expected, this will be partially oxidised to the corresponding acid. The equation given for the hydrolytic decomposition of ozonides is certainly an over-simplification: other products, such as aldehyde and ketone peroxides are sometimes obtained as well as carboxylic acids, and these may arise by the rearrangement of the ozonide itself or of the hemiacetal compound

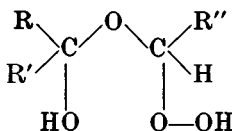

produced by the addition of water to (I) ($\text{R}''' = \text{H}$). The formation of the more highly oxidised products is prevented and the yields of aldehydes and ketones increased by subjecting the ozonide to catalytic reduction, *e.g.*, with palladium-calcium carbonate or with Adams' platinum oxide catalyst (Section III, 150); hydrogenation is easily arrested with the formation of aldehyde and/or ketonic products.

The general method of ozonisation consists in passing dry ozonised oxygen through a dilute solution of the ethylenic compound in a solvent such as ethyl acetate, glacial acetic acid, chloroform, carbon tetrachloride, hexane or ethyl chloride, cooled in a freezing mixture (preferably at -20° to -30°). A wash bottle charged with potassium iodide solution and boric acid is attached to the outlet tube of the bottle containing the solution of the substance; the completion of the ozonisation is indicated by a sudden extensive separation of iodine. The following procedures may be used for decomposing the resulting ozonides:—

(i) The solvent is *cautiously* evaporated under reduced pressure (precautions against explosion should be taken). The crude ozonide is treated with cold water; if it is not decomposed, the mixture is heated under reflux until all the ozonide has disappeared. It is advisable to pass any volatile products into 2:4-dinitrophenylhydrazine reagent (Section VI, 12, *Note 1*): this is most simply done by attaching a tube to the top of the condenser leading to a test-tube containing the reagent. When the decomposition is complete, the product is examined for volatile aldehydes, ketones or acids. The non-volatile products are first tested for their behaviour with Schiff's reagent and 2:4-dinitrophenylhydrazine. The main product is then extracted with ether, the acidic portion is removed from the ether by washing with aqueous sodium bicarbonate, and the neutral and acidic portions worked up separately.

(ii) It is preferable to conduct the ozonisation in dry ethyl acetate solution if the ozonide is to be reduced catalytically, since sparingly soluble polymeric ozonides are not formed in this medium and the reduction may be carried out in this solvent. If another solvent is employed, this must be removed first under reduced pressure and the ozonide dissolved in methanol, etc. Either palladinised calcium carbonate or Adams' platinum catalyst may be used. It is advisable to avoid a rise of the temperature during the hydrogenation, which is exothermic: the hydrogenation vessel is either cooled in ice, or a hydrogenation vessel containing an internal sealed-in glass cooling coil is used. If the temperature is allowed to rise during the reduction, acids are formed at the expense of the aldehyde, probably by the following reaction:

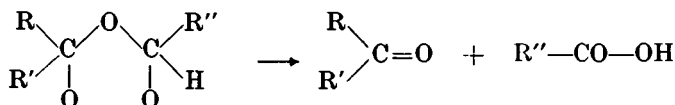

A commercial form of ozoniser is illustrated in Fig. VI, 14, 1*; this produces about 170 ml. of ozonised oxygen, containing 6-7 per cent. of ozone, per minute. The apparatus consists of ten ozone tubes, each with its own effective annular space, bridged in parallel across an inlet and outlet manifold. The units are suspended in a lead-lined, hardwood tank fitted with a terminal: a ten-rod multiple high tension electrode, also fitted with a terminal, dips into the ozone tubes. The two terminals are connected by ozone-proof high tension leads to a transformer at 7,500 volts. The ozone tubes and tank are partially filled with 0.2 per cent. copper sulphate solution. Upon passing the silent high tension discharge across the annular space in the ozone tubes through which oxygen is flowing at a suitable rate†, ozone is formed in 6-7 per cent. yield.

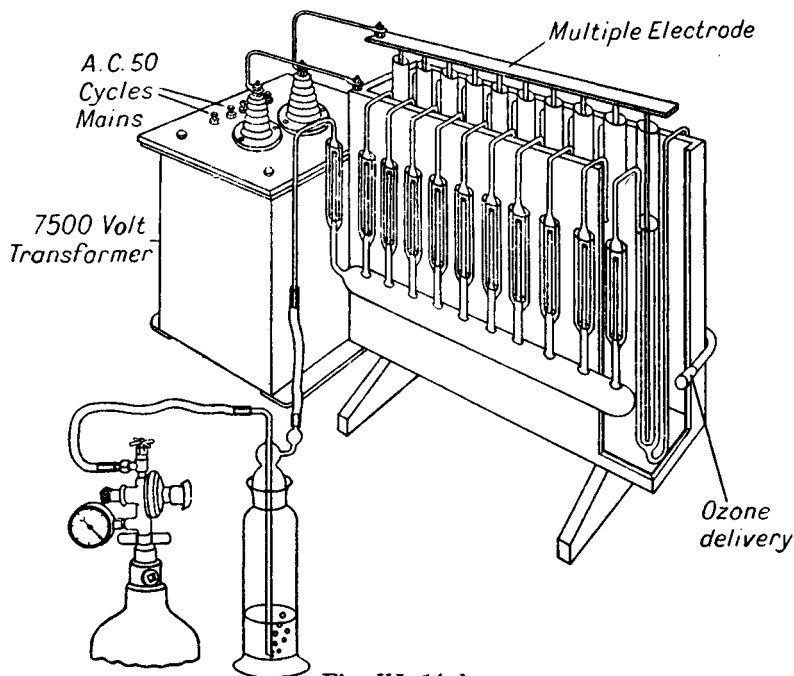

Fig. VI, 14, 1.

It must be emphasised that on the outlet side of the ozoniser, the use of grease and/or rubber at any joint must be avoided. Unlubricated ground glass joints should be used: PVC tubing may be employed for connexions. The ozonolysis is conducted in a wash-bottle of suitable size provided with a ground glass head; it should be surrounded by a freezing mixture, preferably solid carbon dioxide and ether, contained in a Dewar vessel. This bottle should be connected to a similar, but smaller, wash bottle charged with acidified potassium iodide solution to indicate when the reaction is complete.

A simple semimicro laboratory ozoniser is illustrated in Fig. VI, 14, 2: this gives reasonably satisfactory results for small quantities of organic

* Supplied by J. W. Towers and Co. Ltd.

† It is recommended that a flowmeter, charged with dibutyl phthalate, to be inserted between the ozoniser and wash bottle.

compounds. It consists of a wash bottle or small bubbler *A* to indicate the rate of flow of the oxygen, a Berthelot tube *B* for the generation of ozone, a vessel *C* to hold the solution of the compound to be ozonised, and a flask *D* containing 5 per cent. potassium iodide solution. The Berthelot tube is charged with dilute copper sulphate solution and is connected by a copper or stainless steel wire (2–4 mm. in diameter) to the high voltage terminal of a transformer (7,500–10,000 volts). The second electrode is the earthed aluminium foil covering most of the exterior of the Berthelot tube and is bound with insulating tape. As a precaution all high-voltage connexions are heavily insulated with rubber tape and the lead to the top of the electrode is covered with PVC, Tygon or equivalent tubing. The main dimensions are shown in the Figure. The ozoniser should be con-

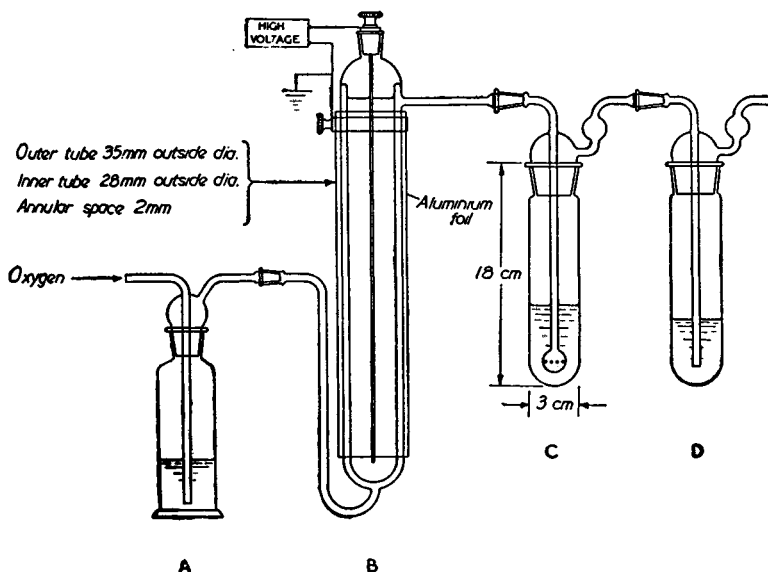

Fig. VI, 14, 2.

structed of soft soda-glass tubing (Pyrex glass is unsatisfactory): the glass should be thoroughly cleaned and the annular space through which the oxygen passes should be as uniform as possible. The complete apparatus should be placed in a fume cupboard (hood) behind a shatter-proof screen of laminated safety glass.

Organic peroxides are *highly explosive*, hence it is best to carry out the ozonisation in a solvent which dissolves both the original compound and the ozonide.

Preparation of palladium - calcium carbonate catalyst. Prepare 50 g. of precipitated calcium carbonate by mixing hot solutions of the appropriate quantities of A.R. calcium chloride and A.R. sodium carbonate. Suspend the calcium carbonate in water and add a solution containing 1 g. of palladium chloride. Warm the suspension until all the palladium is precipitated as the hydroxide upon the calcium carbonate, *i.e.*, until the supernatant liquid is colourless. Wash several times with

distilled water by decantation, filter with suction and wash sparingly until the washings are chloride-free, and dry. Keep the dry palladium-calcium carbonate in a tightly-stoppered bottle.

ADIPIC DIALDEHYDE FROM CYCLOHEXENE

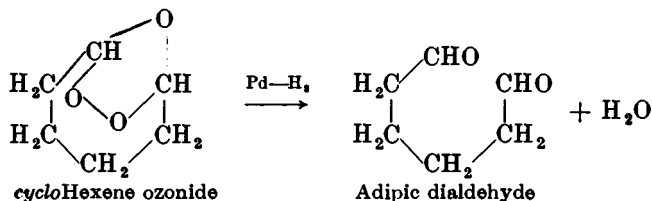

Dissolve 8.2 g. of *cyclohexene* (Section III,12) in 200 ml. of pure dry ethyl acetate (Section II,47,19) contained in a 500 ml. glass-stoppered wash bottle, cool the solution to -20° to -30° or below (e.g., with solid carbon dioxide - acetone) and attach the wash bottle through a calcium chloride or cotton wool drying tube to another containing acidified potassium iodide solution. Pass ozonised oxygen until the reaction is complete, i.e., until iodine is abundantly liberated. Then add 0.5 g. of palladium-calcium carbonate catalyst, and hydrogenate the cold solution of the ozonide in the usual manner (compare Fig. III, 150, 1); cool the hydrogenation vessel in ice. Filter off the catalyst, remove the solvent (Fig. II, 13, 4 but with a Claisen flask provided with a fractionating side arm) at normal pressure. Distil the residue under reduced pressure and collect the adipic dialdehyde at $92-94^\circ/12$ mm. The yield is 7 g. This aldehyde oxidises readily and should be kept in a sealed tube in an atmosphere of nitrogen or carbon dioxide. It may be converted into the dioxime by warming with aqueous hydroxylamine acetate solution: after recrystallisation from water, the dioxime has m.p. 172° .

n-NONYLALDEHYDE AND AZELAIC HEMIALDEHYDE FROM OLEIC ACID

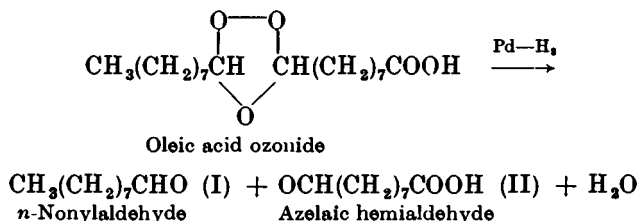

Dissolve 7 g. of pure oleic acid in 30 ml. of dry ethyl chloride (chloroform may be used but is less satisfactory), and ozonise at about -30° . Remove the solvent under reduced pressure, dissolve the residue in 50 ml. of dry methyl alcohol and hydrogenate as for adipic dialdehyde in the presence of 0.5 g. of palladium-calcium carbonate. Warm the resulting solution for 30 minutes with a slight excess of semicarbazide acetate and pour into water. Collect the precipitated semicarbazones and dry: the

yield is 8.5 g. Separate the mixture of semicarbazones by either of the following methods:—(a) Treat with dilute sodium bicarbonate solution to extract the semicarbazone of (II); upon acidifying the extract with dilute sulphuric acid, the semicarbazone of azelaic hemialdehyde is obtained (4.4 g., m.p. 162° after recrystallisation from methyl alcohol). The residue from the sodium bicarbonate extraction consists of the semicarbazone of *n*-nonylaldehyde, and melts at 101° after recrystallisation from methanol: yield, 3.8 g.

(b) Extract the dry mixture of semicarbazones with ether: only the semicarbazone of (I) dissolves easily.

Note.

The Adams platinum oxide catalyst gives satisfactory results in the reduction of ozonides.

VI.15. EPOXIDATION AND HYDROXYLATION OF ETHYLENIC COMPOUNDS

Ethylenic compounds when oxidised with perbenzoic acid or perphthalic acid in chloroform solution yield epoxides (or oxiranes). This is sometimes known as the Prileschajew epoxidation reaction. Thus styrene affords styrene oxide (or 2-phenyloxirane):

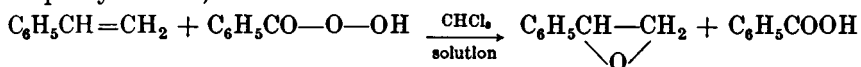

Styrene

Perbenzoic acid

Styrene oxide

It is usually assumed that the epoxidation reaction proceeds initially by *cis* addition to the double bond.

The epoxides may be converted into 1:2-glycols by hydrolysis. In some cases the 1:2-glycol may be produced directly by carrying out the epoxidation in the presence of water. If the 1:2-glycol is desired, it is usually better to employ performic acid or peracetic acid, the latter best in the presence of a trace of sulphuric acid. An epoxide is first formed, followed by the hydroxy-formate or hydroxy-acetate, and ultimately the 1:2-glycol:

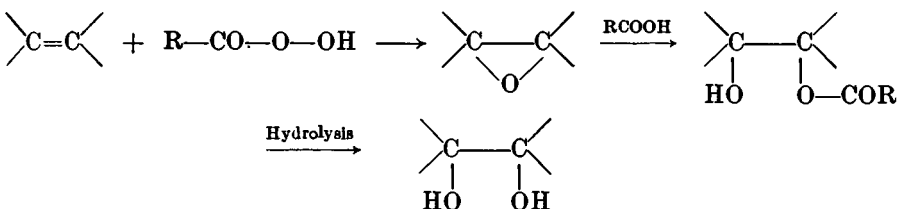

The opening of the oxirane ring is accompanied by inversion except when the oxirane ring is in the terminal position of an aliphatic chain: the *ultimate* result is equivalent to *trans* addition to the double bond. Thus cyclohexene yields *trans*-1:2-cyclohexanediol:

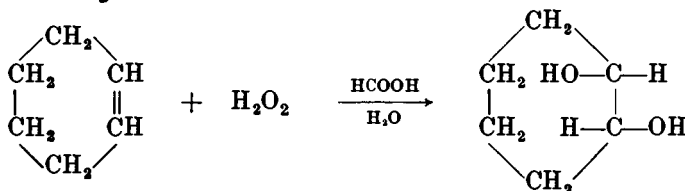

Another method for the hydroxylation of the ethylenic linkage consists in treatment of the alkene with osmium tetroxide in an inert solvent (ether or dioxan) at room temperature for several days: an osmic ester is formed which either precipitates from the reaction mixture or may be isolated by evaporation of the solvent. Hydrolysis of the osmic ester in a reducing medium (in the presence of alkaline formaldehyde or of aqueous-alcoholic sodium sulphite) gives the 1:2-glycol and osmium. The glycol has the *cis* structure; it is probably derived from the cyclic osmic ester:

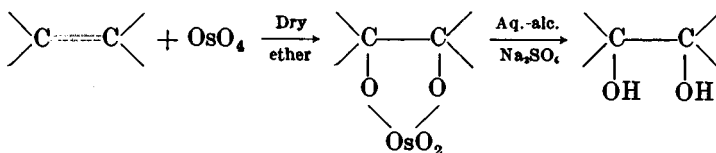

The reagent is expensive and poisonous, consequently the hydroxylation procedure is employed only for the conversion of rare or expensive alkenes (*e.g.*, in the steroid field) into the glycols. Another method for hydroxylation utilises catalytic amounts of osmium tetroxide rather than the stoichiometric quantity: the reagent is hydrogen peroxide in *tert.*-butyl alcohol. This reagent converts, for example, *cyclohexene* into *cis* 1:2-*cyclohexanediol*.

Styrene oxide (1:2-epoxyethylbenzene). Add 30 g. of styrene, b.p. 42–43°/18 mm. (cf. Section X,6), to a solution of 42 g. of perbenzoic acid (Section IV,198) in 450 ml. of chloroform (see *CAUTION* below). Keep the solution at 0° for 24 hours and shake frequently during the first hour. At the end of 24 hours only a slight excess of perbenzoic acid remains; confirm this by mixing an aliquot portion with excess of acidified potassium iodide solution and titrating with standard sodium thio-sulphate solution (Section IV,198). Separate the benzoic acid from the chloroform solution by shaking with an excess of 10 per cent. sodium hydroxide solution, remove the residual alkali by washing with water, and dry the chloroform solution with anhydrous magnesium sulphate. Distil with the aid of an efficient fractionating column. After the chloroform has been removed, the styrene oxide passes over at 189–192° (or at 101°/40 mm.) as a colourless liquid. The yield is 25 g.

***trans*-1:2-*cyclohexanediol*.** *CAUTION.* All preparations and reactions with organic per-acids must be conducted behind a safety screen, because a reaction sometimes proceeds with uncontrollable violence.

In a 500 ml. three-necked flask, equipped with a mechanical stirrer, thermometer and dropping funnel, place 300 ml. of 88–90 per cent. formic acid and add 70 ml. of 30 per cent. hydrogen peroxide.* Then introduce slowly 41 g. (51 ml.) of freshly distilled *cyclohexene* (Section III,12) over a period of 20–30 minutes; maintain the temperature of the reaction mixture between 40° and 45° by cooling with an ice bath and controlling the rate of addition. Keep the reaction mixture at 40° for 1 hour after all the *cyclohexene* has been added and then allow to stand overnight at room temperature. Remove most of the formic acid and water by distillation from a water bath under reduced pressure. Add an ice-cold solution of 40 g. of sodium hydroxide in 75 ml. of water in small portions to the residual mixture of the diol and its formate: take care that the tempera-

* A number of per-acids and organic derivatives of hydrogen peroxides are manufactured by Laporte Chemicals Ltd., Luton, England.

ture does not rise above 45°. Warm the alkaline solution to 45° and add an equal volume (*ca.* 200 ml.) of ethyl acetate. Extract thoroughly, separate the lower layer and extract at 45° six times with equal volumes of ethyl acetate. Combine the seven ethyl acetate solutions (total volume about 1 litre), distil off the solvent from a water bath until the residual volume is about 150 ml. and solid commences to crystallise. Cool to 0° and separate the crude product (*ca.* 45 g.) by suction filtration. Concentrate the mother liquor on a steam bath to 30–40 ml., when more solid crystallises (*ca.* 8 g.). Cool and filter the mixture as before. Distil the combined crude products using an oil bath and a flask such as is shown in Fig. II, 19, 3. The pure *trans*-1 : 2-*cyclohexanediol* passes over at 128–132°/15 mm. (or at 120–124°/4 mm.), and solidifies immediately; m.p. 102–103°. The yield is 40 g. It may be crystallised from acetone or from ethyl acetate.

***cis*-1 : 2-*cyclohexanediol*.** Prepare the *reagent* as follows. To a mixture of 100 ml. of pure *tert.*-butyl alcohol and 25 ml. of 30 per cent. (100 vol.) hydrogen peroxide add anhydrous sodium sulphate (or, better, anhydrous magnesium sulphate) in small portions; two layers separate out. Remove the alcohol layer, which contains most of the hydrogen peroxide, and dry it with anhydrous magnesium sulphate, followed by anhydrous calcium sulphate. The resulting liquid is a solution of 6·3 per cent. hydrogen peroxide in *tert.*-butyl alcohol.

Free *cyclohexene* from peroxides by treating it with a saturated solution of sodium bisulphite, separate, dry and distil: collect the fraction, b.p. 81–83°. Mix 8·2 g. of *cyclohexene* with 55 ml. of the reagent, add a solution of 15 mg. of osmium tetroxide in anhydrous *tert.*-butyl alcohol and cool the mixture to 0°. Allow to stand overnight, by which time the initial orange colouration will have disappeared. Remove the solvent and unused *cyclohexene* by distillation at atmospheric pressure and fractionate the residue under reduced pressure. Collect the fraction of b.p. 120–140°/15 mm.; this solidifies almost immediately. Recrystallise from ethyl acetate. The yield of pure *cis*-1 : 2-*cyclohexanediol*, m.p. 96°, is 5·0 g.

VI,16. REACTIONS IN LIQUID AMMONIA. SOME ACETYLENIC COMPOUNDS *

CONDENSATIONS WITH SODAMIDE IN LIQUID AMMONIA

Acetylenic compounds are conveniently prepared with the aid of liquid ammonia as a solvent. The preparation of a simple acetylenic hydrocarbon (*n*-butylacetylene or 1-hexyne) and also of phenylacetylene is described. Experimental details are also given for two acetylenic carbinols, *viz.*, 1-ethynyl-*cyclohexanol* and 4-pentyn-1-ol. It will be noted that the scale is somewhat large; smaller quantities can readily be prepared by obvious modifications of the directions.

Sodamide is first prepared *in situ* by the reaction of sodium with liquid ammonia in the presence of a catalyst:

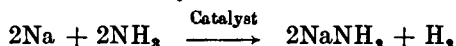

* The experimental details for 1-hexyne, phenylacetylene and 1-ethynyl-*cyclohexanol* were kindly supplied by Professor E. R. H. Jones, F.R.S., Dr. H. B. Henbest and Dr. M. C. Whiting.

The catalyst is finely-divided iron and is produced by adding a little crystallised ferric nitrate and a slight excess of sodium to liquid ammonia; the reaction is probably :

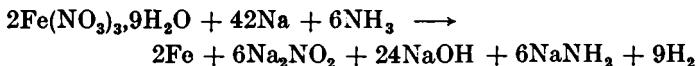

A solution of mono-sodium acetylide in liquid ammonia is formed by passing excess of acetylene gas into the suspension of sodamide :

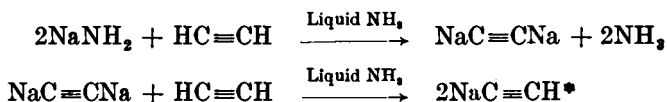

Addition of *n*-butyl bromide then gives *n*-butylacetylene (1-hexyne) :

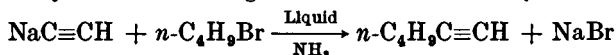

Phenylacetylene is readily prepared by the dehydrohalogenation of styrene dibromide with a solution of sodamide in liquid ammonia :

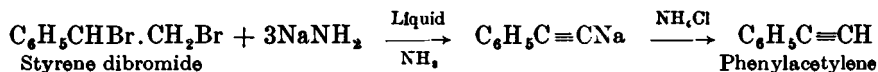

The reaction between sodium acetylide in liquid ammonia solution and carbonyl compounds gives α -acetylenyl carbinols (compare Section III, 148), for example :

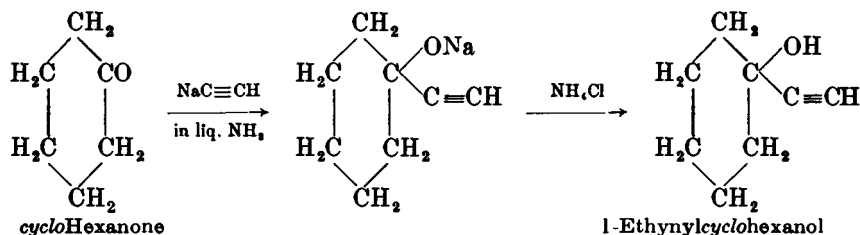

The acetylenic alcohol 4-pentyn-1-ol is conveniently prepared by treatment of tetrahydrofurfuryl chloride with sodamide in liquid ammonia :

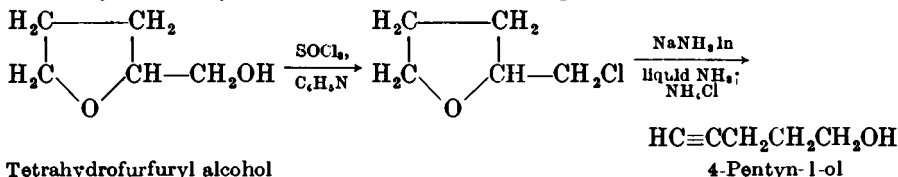

* Monosodium acetylide may also be prepared by the reaction of acetylene with sodium in liquid ammonia :

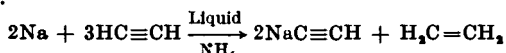

Some unreacted sodium may be left on the walls of the flask in this method and this may partly reduce some product, such as an alkylacetylene, derived from the sodium acetylide. The preparation of sodamide is not attended by much splashing and little (if any) unreacted sodium remains on the walls of the flask. Although more manipulation and a somewhat longer time is required for the sodamide method, the latter is generally preferred as it is more adaptable and somewhat less troublesome.

A solution of sodamide in liquid ammonia (essentially the amide NH_2^- ion) is a very powerful alkylation catalyst, enabling condensations to be carried out with ease and in good yield which are otherwise either impossible or proceed with difficulty and are accompanied by considerable by-products. Thus 3-alkylpyridines, otherwise inaccessible, are easily prepared from 3-picoline (see 3-*n*-amylpyridine in Section V,20). Also benzyl cyanide (I) and *cyclohexyl* bromide give α -*cyclohexylphenyl*acetonitrile (II) :

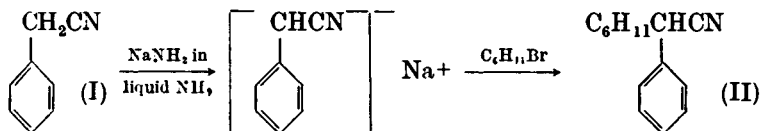

It is of interest to note that by substituting alkyl bromides for *cyclohexyl* bromide the corresponding α -phenyl- α -alkyl-acetonitriles are obtained, which may be hydrolysed to the α -phenylaliphatic acids: thus with ethyl iodide α -phenylbutyronitrile is produced, hydrolysed by ethanolic potassium hydroxide to α -phenylbutyric acid.

n-BUTYLACETYLENE (1-HEXYNE)

Apparatus. It is advisable to have all the apparatus required in the various operations ready before commencing the actual preparation. Apart from the cylinder of acetylene, all the apparatus must be assembled in a spacious fume cupboard provided with an efficient exhaust system. Support a 5-litre, three-necked, bolt-headed flask on a cork ("suberite") ring inside a large crock or bath, subsequently to be used as a cooling bath. Fit the central neck with a powerful stirrer, preferably driven by a flexible driving shaft between the motor and the stirrer (1); support the stirrer head in a metal framework attached to two heavy retort stands. Attach the stirrer by means of two short lengths of rubber "pressure" tubing in order to reduce the danger of breakage in the subsequent stirring (Fig. VI, 16, 1, a; this is a schematic diagram, *not* drawn to scale): the blade of the stirrer may be a glass loop or a Hershberg wire stirrer (Fig. II, 7, 7) of stout, corrosion resistant wire such as tantalum (or "Nichrome"). The glass sleeve bearing may be lubricated with a little silicone grease or with vaseline. The liquid ammonia is introduced by the device shown in Fig. VI, 16, 1, b. Attach a rubber stopper carrying a length of glass tubing bent at right angles securely to the outlet of the cylinder by means of a stout wire.* Mount the ammonia cylinder above the level of the flask at an angle of about 60° from the vertical; upon opening the screw valve any desired volume of liquid ammonia may be run into the reaction flask. It is helpful to mark a ring on the outside of the flask at volumes of 3 and 4 litres.

Acetylene is obtained from a cylinder (at ground level outside the fumé chamber) and is freed from acetone by passing through two 500 ml. wash bottles, half-filled with concentrated sulphuric acid, at the rate of 2-3 litres per minute: when the acid in the second wash bottle becomes discoloured, the wash bottles should be recharged with fresh acid. The

* Alternatively a special gas reducing valve attached to the wide screw thread of the ammonia cylinder may be used.

gas passes via a mercury-filled safety trap (Fig. VI, 16, 1, c) into the reaction vessel, which it enters through a wide tube (at least 0.5" in diameter) reaching almost to the bottom of the flask; the device depicted in Fig. II, 7, 12, b is recommended since any solid formed inside the tube may be readily removed.

Sodamide. Assemble the apparatus shown in Fig. VI, 16, 1, a. Fill the bath to a point about half-way up the side of the flask with methyl alcohol (or methylated spirit) and add solid carbon dioxide (Dry Ice or Drikold) in lump form until a white frost commences to form on the outside of the bath (2): the bath temperature should be about -35° .

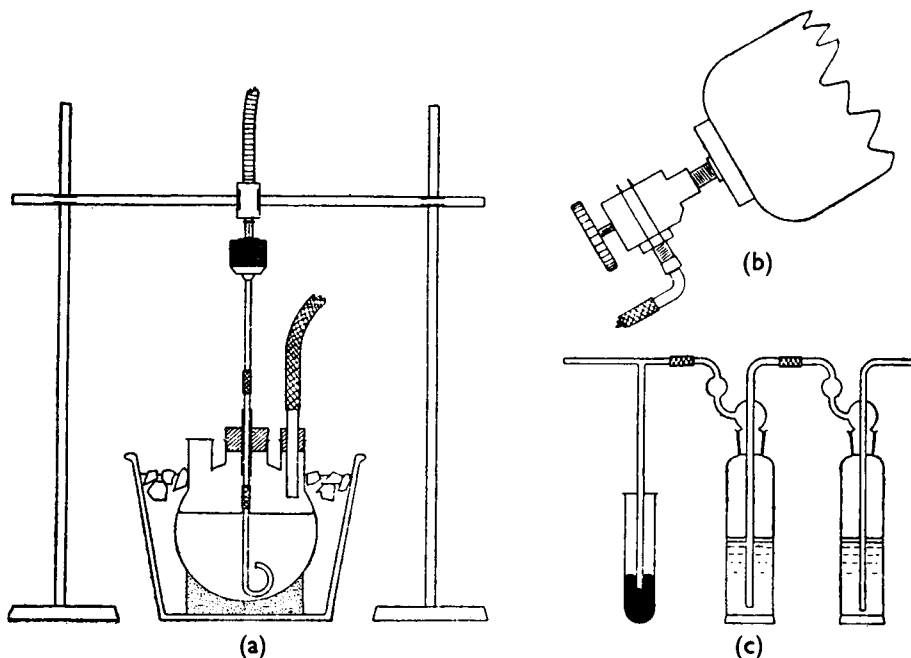

Fig. VI, 16, 1.

Run liquid ammonia into the cooled flask from an inclined cylinder (Fig. VI, 16, 1, b) until the flask is about two-thirds full (*ca.* 3.5 litres) (3). Stir vigorously and add 0.5 g. of finely-powdered crystallised ferric nitrate; continue the stirring for 5 to 10 minutes to disperse the ammonolysis products of the ferric nitrate as finely as possible. Then add 1.5 g. of clean sodium (cut into small pieces) and continue the stirring until the blue colour has disappeared (about 10 minutes) (4). During the subsequent addition of sodium maintain the temperature of the cooling bath between -30° and -35° by the addition of dry ice when necessary. Introduce 138 g. of clean sodium (5) in 3 g. lumps during 1 hour; stir slowly during the reaction. The solution at first acquires a deep blue colour: at the end of the reaction the fine suspension of sodamide is colourless or pale grey (6). Continue the stirring after all the sodium has been added until the blue colour just disappears. It is essential to ensure

that the blue colour should have disappeared before proceeding to the next stage: this is most easily detected with the aid of a "dip stick" (4). If the volume of liquid has appreciably decreased during the reaction, add liquid ammonia to restore the original volume (ca. 3.5 litres).

Sodium acetylide. Replace the ammonia - addition tube by a wide tube reaching almost to the bottom of the flask (or use the device depicted in Fig. II, 7, 12, b) and pass acetylene (Fig. VI, 16, 1, c) into the suspension of sodamide in liquid ammonia: maintain the bath temperature at about -35° so that little ammonia is lost. Continue the passage of acetylene until a uniformly black liquid is formed (usually 4-5 hours) (7). Carefully watch the wide gas entry tube; if much solid collects inside this tube, remove it before the tube is completely blocked. Add liquid ammonia, if necessary, to restore the original volume (ca. 3.5 litres).

***n*-Butylacetylene (1-hexyne).** Add Dry Ice to the cooling bath until the methanol becomes viscous (ca. -50°). Introduce, with stirring, 685 g. (538 ml.) of redistilled *n*-butyl bromide, contained in a dropping funnel, during 1.5-2 hours whilst a slow stream of acetylene (ca. 500 ml. per minute) is passed through the reaction mixture. The reaction is an exothermic one: maintain the temperature of the cooling bath at about -50° . When all the alkyl bromide has been added, discontinue the supply of acetylene, close one neck of the flask with a cork and leave the other open to allow the ammonia to escape. Continue the stirring. Add more solid carbon dioxide to the bath until it is well above the level of the liquid in the flask. Allow the reaction mixture to stand overnight (about 15 hours), and then add with continued stirring 60 g. of ammonium chloride to decompose the excess of sodium acetylide (or sodamide, if present). Allow the residual ammonia to evaporate and then introduce 500 g. of crushed ice cautiously, followed by about 1.5 litres of distilled water. Subject the contents of the flask to steam distillation. The 1-hexyne passes over rapidly. Separate the hydrocarbon layer, dry it with anhydrous magnesium sulphate and fractionate (preferably through a Widmer or Fenske column). Collect the *n*-butylacetylene at $71-72^{\circ}$. The yield is 280 g.

Notes.

(1) The stirrer shown in Fig. II, 7, 3 is suitable. Corrosion of the motor by the ammonia fumes is thus reduced to a minimum. A powerful stirrer is essential since much solid is formed in the subsequent reaction.

(2) For precautions to be observed in handling Dry Ice, see Section III, 84.

(3) The liquid ammonia may be slightly cloudy, due to the presence of a little water: this has no appreciable effect upon the yield.

(4) The absence of a colour can be readily ascertained by dipping a glass rod into the solution and withdrawing it rapidly: when the solution is colourless, all the sodium has been converted into sodamide by the catalyst present.

(5) It is advisable to use dry, clean sodium; it may be kept in dry ether or naphtha prior to the addition.

(6) This procedure may be used for the preparation of finely-divided sodamide. If the sodamide is to be used in any other solvent than liquid ammonia, the ammonia is allowed to evaporate whilst the new solvent is slowly added from a dropping funnel; alternatively, the new solvent may be added before the ammonia evaporates. If dry sodamide is required, the product may be freed from the last traces of ammonia by evacuation at 100° . The sodamide prepared by this method must be used immediately: if allowed to stand, it rapidly changes into explosive substances.

(7) Occasionally the reaction mixture does not become completely black nor free from suspended solid; here the acetylide is in an insoluble (or sparingly soluble) form, but it gives satisfactory results in the preparation of hex-1-yne. The saturated solution of the soluble form of mono-sodium acetylide in liquid ammonia at -34° is about 4.1M.

PHENYLACETYLENE

Styrene dibromide ($\alpha\beta$ -dibromoethylbenzene). Place a solution of 204 g. (224 ml.) of freshly distilled styrene (Section X,6) in 200 ml. of dry chloroform in a litre beaker, cooled in an ice bath, and provided with a mechanical stirrer. Support a dropping funnel over the beaker and charge the former with a solution of 340 g. (107 ml.) of dry bromine in 200 ml. of chloroform. Add the bromine solution with stirring at a rate to conform with the discharge of colour from red to pale yellow. This preparation is advantageously carried out in bright sunlight. When all the bromine has been added, continue the stirring until the reaction is complete. Evaporate the chloroform on a water bath; the residual crude styrene dibromide weighs 510 g. This may be used directly for the preparation of phenylacetylene. It may be purified by recrystallisation from dilute alcohol; m.p. $73-74^{\circ}$.

CAUTION. Styrene dibromide is a skin irritant and all contact with it should be avoided. Rubber gloves should be used in its preparation.

Phenylacetylene. Support a 5-litre glass Dewar flask in a wooden case. Equip the flask with a lid of clear Perspex, provided with suitable apertures for a mechanical stirrer, introducing solids (*e.g.*, sodium) or liquids, a calibrated dip stick for measuring the volume of liquid in the Dewar vessel, a gas inlet tube and an ammonia inlet: arrange for an electric light to shine downwards into the flask.

Charge the Dewar flask with 3 litres of liquid ammonia, set the stirrer into operation, and introduce 1.5 g. of powdered ferric nitrate followed by 5 g. of clean sodium. After 2 minutes, introduce 160 g. of clean sodium in 3 g. lumps during 30 minutes. Allow to stand until the initially deep blue reaction mixture assumes a light grey colour (about 20 minutes). Add a solution of 510 g. of styrene dibromide in 1500 ml. of dry ether slowly during 2 hours: a vigorous reaction ensues, accompanied by the loss of some ammonia by evaporation. Allow to stand for 4 hours, add 180 g. of finely-powdered ammonium chloride to the pasty mass (to decompose the sodio derivative), followed by 500 ml. of ether and continue the stirring for several minutes. Pour the contents of the Dewar flask with the aid of a purpose-made plastic spout into a cold beaker. Allow the ammonia to evaporate overnight. Add ether, filter off the inorganic salts and wash well with ether; keep the filtrate (*A*). Dissolve the inorganic salts in water, extract the solution with ether, and combine the ethereal extracts with the filtrate (*A*). Wash with dilute sulphuric acid until acid to Congo red paper, then with water, dry with anhydrous magnesium sulphate, distil off the ether on a water bath with the aid of a short but efficient column, and fractionate the residue through a well-lagged Widmer (or other efficient fractionating) column. Collect the phenylacetylene at

142–143°; the yield is 156 g. Alternatively, distil the residue under reduced pressure and collect the phenylacetylene at 82°/80 mm. (1).

Note.

(1) This pressure is readily attained by placing an air leak between the water pump and the apparatus or, better, with the aid of a manostat, Figs. II, 23, 4–7.

1-ETHYNYLCYCLOHEXANOL

Use the same technique as detailed for 1-hexyne, but with a 3-litre three-necked flask. Charge the flask with 1.5 litres of liquid ammonia. Prepare the sodamide using 0.7 g. of ferric nitrate and 2 g. of sodium, followed by 46 g. of sodium, and convert it into a solution of sodium acetylide as before. Add, with stirring, a solution of 196 g. (206 ml.) of dry, redistilled *cyclohexanone* (1) in 256 ml. of dry ether during 1 hour and continue the stirring for a further 2 hours. Decompose the sodium derivative of the product by the gradual addition of a slight excess (118 g.) of powdered ammonium chloride. Allow to stand overnight, preferably with stirring, by which time all the ammonia will have evaporated. Extract the residue repeatedly with ether, *i.e.*, until all the carbinol has been separated from the inorganic material (2). Wash the ethereal extract successively with water, dilute sulphuric acid and potassium bicarbonate solution, dry with anhydrous magnesium sulphate and distil. Collect the 1-ethynyl*cyclohexanol* at 83°/20 mm. (3); the yield is 210 g.

Notes.

(1) Dry the *cyclohexanone* over excess of anhydrous calcium chloride before distillation.

(2) A continuous ether extractor (Fig. II, 44, 2) is recommended.

(3) The product has m.p. *ca.* 25°, but the m.p. depends upon the purity of the *cyclohexanone* and the efficiency of the distillation. Pure 1-ethynyl*cyclohexanol* has m.p. 32°.

4-PENTYN-1-OL

Tetrahydrofurfuryl chloride. Place 204 g. (194 ml.) of freshly distilled tetrahydrofurfuryl alcohol (b.p. 177°) and 174 g. (178 ml.) of dry pyridine in a 1-litre three-necked flask, fitted with a dropping funnel, mechanical stirrer and thermometer. Cool in an ice bath, stir vigorously and add 250 g. (153 ml.) of freshly distilled thionyl chloride at the rate of 3–5 drops per second. A pasty crystalline mass begins to separate and the temperature commences to rise rapidly when one-third to one-half of the thionyl chloride has been added; subsequently the mass largely redissolves and a dark brown liquid forms. Remove the ice bath when the addition is complete and stir the mixture for 3–4 hours. Pour the reaction product into a large separatory funnel and extract with seven 250 ml. portions of ether: break up any lumps that may form with a glass rod. Remove the ether from the combined extracts by distillation, wash the residue with three 50 ml. portions of water, dry with anhydrous magnesium sulphate and distil under reduced pressure. The yield of tetrahydrofurfuryl chloride, b.p. 47–48°/15 mm., is 180 g.

4-Pentyn-1-ol. Prepare a solution of sodamide in liquid ammonia as detailed for *n-Butylacetylene*. Use a 3-litre three-necked flask, equipped with a Dewar type of reflux condenser (Fig. II, 1, 4, *h*) cooled with Dry Ice

and attached through a soda-lime guard tube to a gas-absorption trap (Fig. II, 8, 1, *c* or *d* or Fig. II, 8, 2), a mercury-sealed stirrer, and an inlet tube. Introduce 1-litre of anhydrous ammonia through the inlet tube, add 1 g. of hydrated ferric nitrate, followed by 80.5 g. of clean, freshly cut sodium; add more liquid ammonia through the inlet tube if vaporisation reduces the volume below 750 ml. Replace the inlet tube by a 250 ml. dropping funnel, stir the mixture until all the sodium is converted into sodamide, and then add 120.5 g. (108.5 ml.) of tetrahydrofurfuryl chloride over a period of 25–30 minutes. Stir the mixture for a further hour, after which introduce 177 g. of solid ammonium chloride in portions at a rate that permits control of the exothermic reaction. Allow the flask to stand in the fume cupboard (hood), preferably overnight, while the ammonia evaporates. Extract the residue thoroughly with ten 250 ml. portions of ether and decant them through a Buchner funnel. Distil off the ether, and fractionate the residue through a column packed with glass helices (compare Fig. II, 17, 2) at a reflux ratio of about 5 to 1. Collect the 4-pentyn-1-ol at 70–71°/29 mm. The yield is 70 g.

The b.p. at atmospheric pressure has been given as 154–155°.

α -CYCLOHEXYLPHENYLACETONITRILE

In a 1-litre three-necked flask prepare a solution of sodamide in liquid ammonia, using 200 ml. of anhydrous ammonia, 0.2 g. of crystallised ferric nitrate and 8.1 g. of sodium: follow the experimental details given under *n-Butylacetylene*. Whilst cooling in a Dry Ice-trichloroethylene bath, add 41 g. (40 ml.) of benzyl cyanide (Section IV,160) during 10 minutes by means of a dropping funnel inserted into a neck of the flask. Remove the Dry Ice bath, stir the clear solution for 15 minutes, add 200 ml. of sodium-dried, sulphur-free toluene and 25 ml. of anhydrous ether dropwise through the funnel while the ammonia evaporates. Allow the solution to stand, or warm in a water bath, until all the ammonia has evaporated. At this stage, fit a reflux condenser to the flask already equipped with a mechanical stirrer and dropping funnel. Add 65.2 g. (49.1 ml.) of cyclohexyl bromide (Section III,34) to the warm solution over a period of about 20 minutes; the reaction is vigorous and may require cooling. Reflux the mixture (oil bath) for 2 hours. Cool the reaction mixture and wash it with 250 ml. of water; keep the toluene solution. Extract the aqueous layer with two 50 ml. portions of benzene; wash the combined toluene and benzene solutions with two 50 ml. portions of water, and dry with anhydrous magnesium sulphate. Distil from a 500 ml. Claisen flask with fractionating side arm (Figs. II, 24, 3–5) and collect the α -cyclohexylphenylacetone nitrile at 174–176°/13 mm.; it crystallises on cooling, m.p. 51–53° and the yield is 50 g. It may be recrystallised from commercial pentane; m.p. 57–58°.

VI,17.

THE ARNDT-EISSERT REACTION

The Arndt-Eistert reaction is a comparatively simple method for converting an acid into its next higher homologue or to a derivative of the homologous acid, such as an amide or an ester. The overall yield is generally good. The reaction

is applicable to aliphatic, aromatic, alicyclic and heterocyclic carboxylic acids. It involves three operations :

1. Formation of the acid chloride, *e.g.*, with thionyl chloride or with phosphorus pentachloride :



2. Reaction of the acid chloride with a cold solution of excess of diazomethane to yield a diazo ketone :

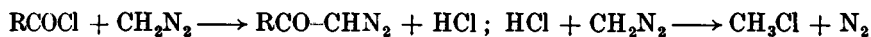

(If excess of acid chloride is employed, *e.g.*, by adding the diazomethane solution slowly to the acid chloride, some halomethyl ketone is produced :

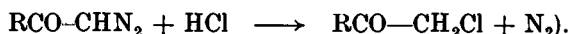

3. Rearrangement of the diazo ketone, with loss of nitrogen, in the presence of suitable reagents and a catalyst (colloidal silver, silver oxide, or silver nitrate in the presence of ammonia solution). An acid is formed in the presence of water, an amide results when ammonia or an amine is used, and an ester is produced in the presence of an alcohol :

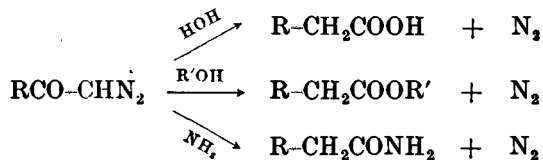

The third operation, involving the conversion of the diazo ketone into an acid or a simple derivative thereof, is known as the **Wolff rearrangement**.

In order to prepare an acid, a dioxan solution of the diazo ketone is added slowly to a suspension of silver oxide in a dilute solution of sodium thiosulphate. If the conversion to the acid yields unsatisfactory results, it is usually advisable to prepare the ester or amide, which are generally obtained in good yields; hydrolysis of the derivative gives the free acid.

Esters of the homologous acids are prepared by adding silver oxide in portions rather than in one lot to a hot solution or suspension of the diazo ketone in an anhydrous alcohol (methyl, ethyl or *n*-propyl alcohol) : methanol is generally used and the silver oxide is reduced to metallic silver, which usually deposits as a mirror on the sides of the flask. The production of the ester may frequently be carried out in a homogeneous medium by treating a solution of the diazo ketone in the alcohol with a solution of silver benzoate in triethylamine.

The conversion of a diazo ketone to an acid amide may be accomplished by treating a warm solution in dioxan with 10–28 per cent. aqueous ammonia solution containing a small amount of silver nitrate solution, after which the mixture is heated at 60°–70° for some time. Precautions should be taken (by use of a safety glass shield) when heating mixtures containing ammoniacal silver nitrate.

The reaction is illustrated by the following examples :

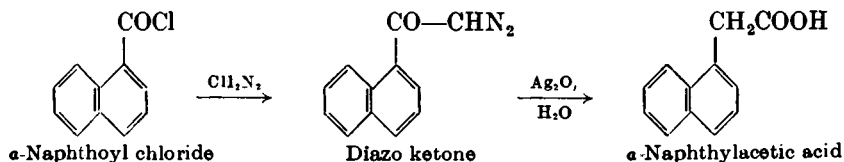

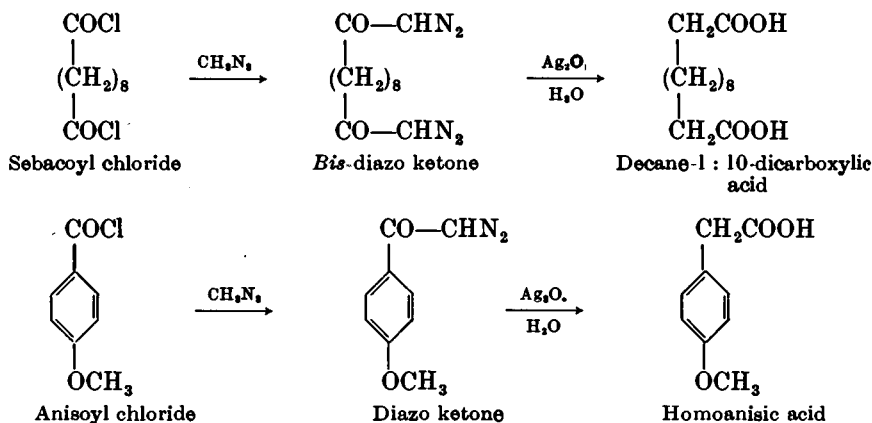

The *mechanism* of the reaction probably involves the production of bivalent carbon during the initial loss of nitrogen: the group R shifts from an adjacent position to this carbon leading to the production of a keten; the latter then reacts with the solvent to give an acid, an amide or an ester.

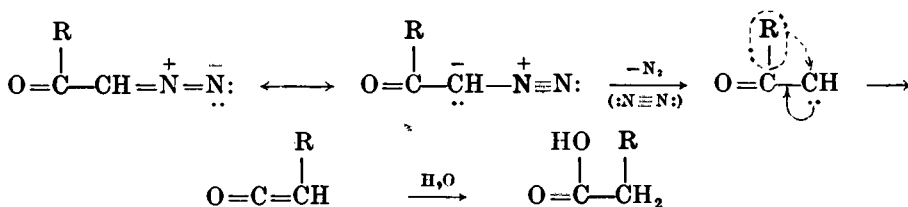

α -Naphthylacetic acid from α -naphthoic acid. Prepare α -naphthoyl chloride, b.p. $168^\circ/10$ mm., from α -naphthoic acid and phosphorus pentachloride following the procedure described for β -naphthoyl chloride (Section IV, 120, Note 2). Add a solution of 19 g. of α -naphthoyl chloride in anhydrous ether at $5-10^\circ$ to a solution of diazomethane prepared from 35 g. of nitrosomethylurea (Section VII, 20) and 500 ml. of anhydrous ether. Keep the reaction mixture at $20-25^\circ$ for 3-4 hours, then remove the ether under reduced pressure and finally at 30° . The yellow crystalline residue of α -naphthoyldiazomethane weighs 18 g.; it melts at 56° after recrystallisation from benzene-petroleum ether (b.p. $40-60^\circ$).

Introduce a solution of 15 g. of the diazo ketone in 100 ml. of dioxan dropwise and with stirring into a mixture of 2 g. of silver oxide (1), 3 g. of sodium thiosulphate and 5 g. of anhydrous sodium carbonate in 200 ml. of water at $50-60^\circ$. When the addition is complete, continue the stirring for 1 hour and raise the temperature of the mixture gradually to $90-100^\circ$. Cool the reaction mixture, dilute with water and acidify with dilute nitric acid. Filter off the α -naphthylacetic acid which separates and recrystallise it from water. The yield is 12 g., m.p. 130° .

Note.

(1) Prepare the silver oxide by adding a dilute solution of sodium hydroxide to 10 per cent. silver nitrate solution until precipitation is just complete, avoiding an excess of alkali. Wash the precipitate several times by decantation: finally, filter at the pump and wash well with water.

Ethyl α -naphthylacetate is prepared as follows. To a solution of 10 g. of the diazo ketone in 150 ml. of ethanol at 55–60°, add a small amount of a slurry of silver oxide, prepared from 10 ml. of 10 per cent. aqueous silver nitrate and stirred with 25 ml. of ethanol. As soon as the evolution of nitrogen subsides, introduce more of the silver oxide and continue the process until all the slurry has been added. Reflux the mixture for 15 minutes, add 2–3 g. of decolourising carbon, filter and evaporate the alcohol on a water bath. Distil the residue and collect the ethyl α -naphthylacetate at 176–178°/11 mm.; the yield is 9 g.

Decane-1 : 10-dicarboxylic acid from sebacic acid. Convert sebacic acid into the acid chloride by treatment with phosphorus pentachloride (2 mols) and purify by distillation; b.p. 140–143°/2 mm.: the yield is almost quantitative. Dissolve the resulting sebacyl chloride in anhydrous ether and add the solution slowly to an ethereal solution of excess of diazomethane (prepared from 50 g. of nitrosomethylurea): allow the mixture to stand overnight. Remove the ether and excess of diazomethane under reduced pressure: the residual crystalline 1 : 8-bis-diazoacetyloctane weighs 19.3 g. and melts at 91° after crystallisation from benzene.

Add, with stirring, a solution of 6.8 g. of the *bis*-diazo ketone in 100 ml. of warm dioxan to a suspension of 7.0 g. of freshly precipitated silver oxide in 250 ml. of water containing 11 g. of sodium thiosulphate at 75°. A brisk evolution of nitrogen occurs; after 1.5 hours at 75°, filter the liquid from the black silver residue. Acidify the almost colourless filtrate with nitric acid and extract the gelatinous precipitate with ether. Evaporate the dried ethereal extract: the residue of crude decane-1 : 10-dicarboxylic acid weighs 4.5 g. and melts at 116–117°. Recrystallisation from 20 per cent. aqueous acetic acid raises the m.p. to 127–128°.

Alternatively, treat a solution of 3.9 g. of the *bis*-diazo ketone in 50 ml. of warm dioxan with 15 ml. of 20 per cent. aqueous ammonia and 3 ml. of 10 per cent. aqueous silver nitrate under reflux in a 250 or 500 ml. flask on a water bath. Nitrogen is gently evolved for a few minutes, followed by a violent reaction and the production of a dark brown and opaque mixture. Continue the heating for 30 minutes on the water bath and filter hot: the diamide of decane-1 : 10-dicarboxylic acid is deposited on cooling. Filter this off and dry: the yield is 3.1 g., m.p. 182–184°, raised to 184–185° after recrystallisation from 25 per cent. aqueous acetic acid. Hydrolyse the diamide (1 mol) by refluxing for 2–5 hours with 3*N* potassium hydroxide (4 mols): acidify and recrystallise the acid from 20 per cent. acetic acid. The yield of decane-1 : 10-dicarboxylic acid, m.p. 127–128°, is almost quantitative.

***p*-Methoxyphenylacetic acid (homoanistic acid) from anisic acid.** Prepare anisoyl chloride, m.p. 24°, b.p. 262–263° (decomp.), by treating anisic acid (1 mol) with thionyl chloride (1.5 mols). Add 30 g. of anisoyl chloride to an ethereal solution of diazomethane prepared from 38 g. of nitrosomethylurea: allow the solution to stand overnight. Distil off the ether (fume cupboard!) and recrystallise the solid residue from benzene-petroleum ether: the yield of diazo ketone (*p*-methoxy- α -diazoacetophenone), m.p. 90–91°, is 22 g.

Dissolve 20 g. of the diazo ketone in 100 ml. of warm dioxan and treat

it with 150 ml. of concentrated ammonia solution and 30 ml. of 10 per cent. aqueous silver nitrate solution at 60–70°. Boil the mixture under reflux for 2 hours, cool and precipitate the *p*-homoanisamide by the addition of water. Collect the solid and recrystallise it from ethanol. The yield of the pure amide, m.p. 188–189°, is 15 g. -

Reflux a mixture of 15 g. of homoanisamide, 30 g. of potassium hydroxide and 300 ml. of ethanol on a water bath for 5 hours. Dilute with 750 ml. of water, evaporate to 75 ml. and acidify to Congo red. Collect the acid and recrystallise it from ethyl alcohol. The yield of *p*-methoxyphenylacetic acid, m.p. 86–87°, is 13 g.

VI,18. THE DARZENS GLYCIDIC ESTER CONDENSATION

This reaction involves the condensation of an aldehyde or ketone with an α -halo ester in the presence of a basic condensing agent (sodium ethoxide, sodamide, finely divided sodium or potassium *tert.*-butoxide) to give a glycidic (or $\alpha\beta$ -epoxy) ester. Thus acetophenone and ethyl chloroacetate yield phenylmethylglycidic ester (I) :

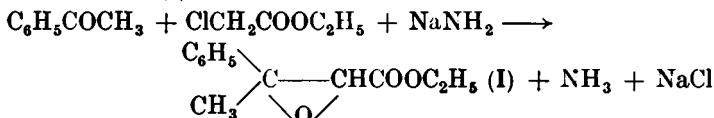

The glycidic esters are of interest primarily because upon hydrolysis and decarboxylation they afford aldehydes (if $\text{ClCH}_2\text{COOEt}$ is used) or ketones (if substituted chloroacetic esters ClCHRCOOEt are employed) having a higher carbon content than the original aldehyde or ketone. Thus (I) gives α -phenylpropionaldehyde or hydratropaldehyde (II) :

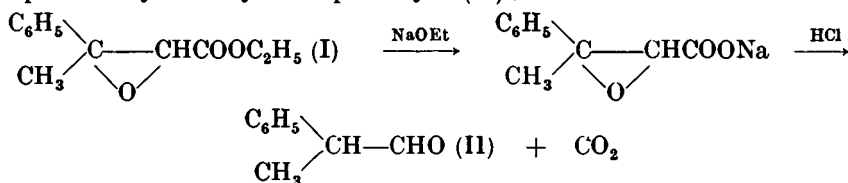

A possible *mechanism* of the Darzens condensation may be written as :

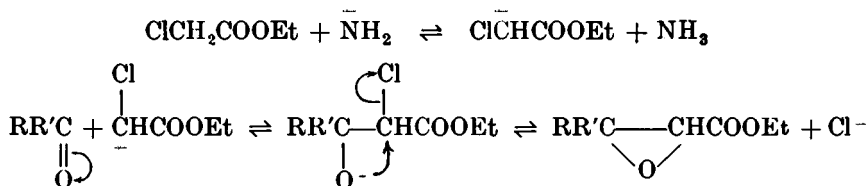

The decomposition of a glycidic ester to an aldehyde and carbon dioxide may involve the formation of a *quasi* six-membered ring, followed by the shift of three electron pairs :

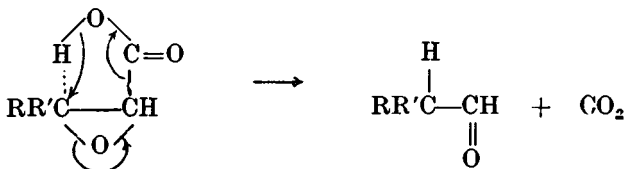

Phenylmethylglycidic ester. In a 500 ml. three-necked flask, fitted with a mechanical stirrer and a low temperature thermometer, place a mixture of 60 g. (59.5 ml.) of acetophenone, 61.5 g. (54.5 ml.) of ethyl chloroacetate (b.p. 142–143°) and 100 ml. of anhydrous benzene. Add, with stirring, 23.6 g. of finely powdered sodamide (recently prepared) over a period of 2 hours; maintain the temperature at 15–20° with the aid of external cooling. Anionia is evolved. Stir for 2 hours at room temperature and pour the reddish mixture upon 350 g. of crushed ice with hand stirring. Separate the organic layer and extract the aqueous layer with 100 ml. of benzene. Wash the combined benzene solutions with three 150 ml. portions of water, the last one containing 5 ml. of acetic acid, and then dry with anhydrous magnesium sulphate. After removal of the benzene by "flash distillation", distil the residue under reduced pressure from a Claisen flask with fractionating side arm (Figs. II, 24, 3–5). Collect the fraction of b.p. 111–114°/3 mm. as pure phenylmethylglycidic ester; the yield is 67 g.

α -Phenylpropionaldehyde (hydratropaldehyde). Prepare a solution of sodium ethoxide in a 500 ml. round-bottomed flask from 7.75 g. of clean sodium and 150 ml. of absolute ethanol (Section III, 152). Add 66.5 g. of phenylmethylglycidic ester slowly and with shaking. Cool the flask externally to 15° and add 8 ml. of water slowly; much heat is evolved and the sodium salt soon separates. Keep the reaction mixture overnight. Collect the salt by suction filtration, wash it with 25 ml. of ethanol followed by 25 ml. of ether.

Add the salt to dilute hydrochloric acid (prepared from 28 ml. of the concentrated acid and 150 ml. of water) contained in a 500 ml. flask fitted with a reflux condenser. Warm the mixture gently; carbon dioxide is evolved and an oil separates. Heat on a steam bath for 90 minutes, cool, and extract the oil with 75 ml. of benzene. Wash the extract with 100 ml. of water, and distil the benzene solution under reduced pressure from a Claisen flask. Collect the α -phenylpropionaldehyde at 90–93°/10 mm.; the yield is 30 g.

COGNATE PREPARATION

Ethyl α -1-epoxycyclohexylacetate. Add a mixture of 55 g. (48 ml.) of ethyl chloroacetate and 43 g. of cyclohexanone dropwise to a suspension of finely divided sodium (11 g.) in anhydrous xylene (165 ml.) with stirring and cooling in an ice-salt bath. Regulate the rate of addition so that the temperature of the reaction mixture does not exceed 8°. Pour the resulting dark-red clear solution into water, wash the organic layer repeatedly with water, dry with anhydrous magnesium sulphate, and distil. Collect the glycidic ester at 81–83°/0.04 mm. or at 115–117°/10 mm. The yield is 37 g.

VI,19. THE ERLLENMEYER AZLACTONE REACTION

Azactones (anhydrides of α -acylamino acids) are formed by the condensation of aromatic aldehydes with acyl derivatives of glycine in the presence of acetic anhydride and anhydrous sodium acetate. Thus benzaldehyde and acetyl-

(or benzoyl-)glycine (I) yields the azlactone of α -acetamino- (or α -benzylamino-) cinnamic acid (II)

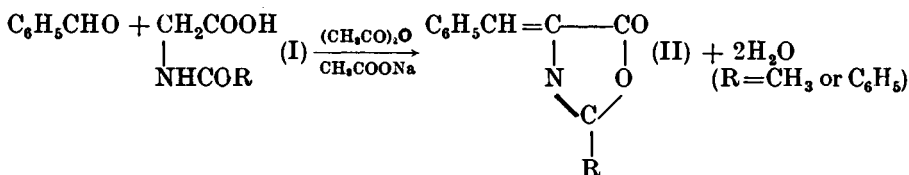

The reaction probably proceeds by an initial cyclisation of the acylaminoacetic acid, followed by a Perkin type of condensation of the aldehyde with the active methylene unit :

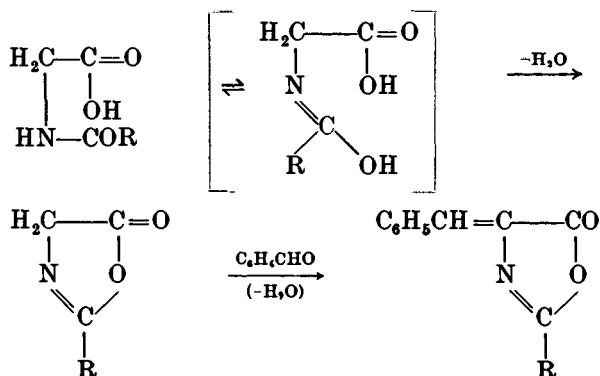

Hydrolysis of the azlactone leads to the acylaminocinnamic acid; the latter may be reduced catalytically (Adams PtO₂ catalyst : 40 lb. p.s.i.) and then hydrolysed by hydrochloric acid to the amino acid. Alternatively, the azlactone (say, of α -benzylaminocinnamic acid) may undergo reduction and cleavage with phosphorus, hydriodic acid and acetic anhydride directly to the α -amino acid (*dl*- β -phenylalanine).

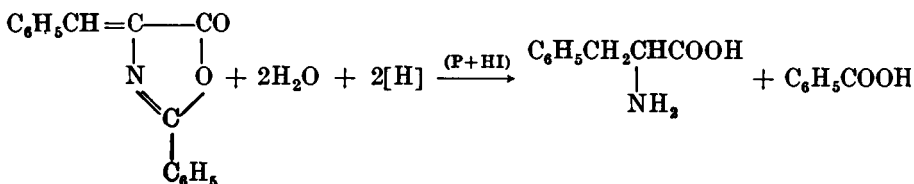
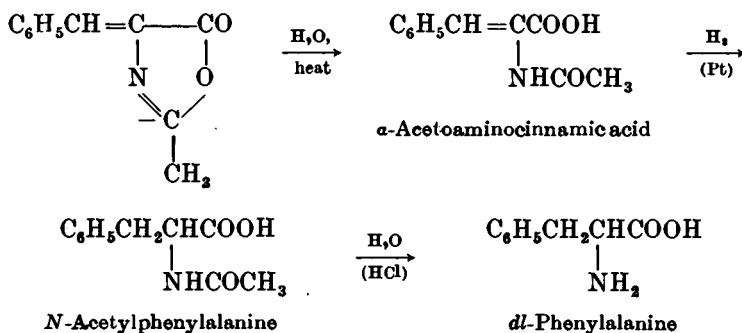

100 ml. of cold water and dry at 100°. The yield of α -acetoaminocinnamic acid, m.p. 191–192°, is 22 g.

Azlactone of α -benzoylamino-cinnamic acid. Place a mixture of 27 g. (26 ml.) of redistilled benzaldehyde, 45 g. of hippuric acid (Section IV, 54), 77 g. (71.5) ml. of acetic anhydride and 20.5 g. of anhydrous sodium acetate in a 500 ml. conical flask and heat on an electric hot plate with constant shaking. As soon as the mixture has liquefied completely, transfer the flask to a water bath and heat for 2 hours. Then add 100 ml. of alcohol slowly to the contents of the flask, allow the mixture to stand overnight, filter the crystalline product with suction, wash with two 25 ml. portions of ice-cold alcohol and then wash with two 25 ml. portions of boiling water: dry at 100°. The yield of almost pure azlactone, m.p. 165–166°, is 40 g. Recrystallisation from benzene raises the m.p. to 167–168°.

dl- β -Phenylalanine. In a 1-litre three-necked flask, fitted with a reflux condenser, mechanical stirrer and dropping funnel by means of new corks covered with tin foil, place 25 g. of the azlactone of α -benzoylamino-cinnamic acid, 20 g. of purified red phosphorus (Section II, 50, 5) and 135 g. (125 ml.) of acetic anhydride. Add with stirring over a period of 1 hour 125 ml. of hydriodic acid (sp. gr. 1.56; 50 per cent.). Reflux the mixture for 3 hours, cool and filter with suction: wash the unreacted phosphorus on the filter with two 5 ml. portions of glacial acetic acid. Place the filtrate and washings in a 500 ml. Claisen flask supported on a water bath and evaporate to dryness under reduced pressure: collect the distillate (which may be used for another reduction) in a 250 ml. distilling flask cooled in ice. Add 100 ml. of water to the dry residue in the Claisen flask and repeat the evaporation to dryness. Shake the residue in the flask with 150 ml. of water and 150 ml. of ether until solution is complete; separate the aqueous layer and extract it with three 75 ml. portions of ether. Discard the ether extracts. Introduce 2–3 g. of decolourising carbon and a trace of sodium sulphite into the water solution, heat on a water bath until the dissolved ether has been removed, filter, heat the filtrate to boiling and neutralise to Congo red with conc. ammonia solution (sp. gr. 0.88; about 25 ml. are required). When cold, filter the colourless phenylalanine at the pump and wash with two 30 ml. portions of cold water and finally with alcohol; dry at 100°. The yield is 11 g., m.p. 284–288° (decomp.).

VI, 20.

THE MANNICH REACTION

The Mannich reaction consists in the condensation of formaldehyde with ammonia or a primary or a secondary amine and a compound containing at least one hydrogen atom of pronounced reactivity; the active hydrogen atom may be derived from a methylene group activated by a neighbouring keto group, or from a nitroparaffin, or it may be the *o*- or *p*-hydrogen atoms in phenols. Thus when acetophenone is boiled in alcoholic solution with formaldehyde and dimethylamine hydrochloride, the Mannich base β -dimethylamino-propiofenone hydrochloride (I) is readily formed:

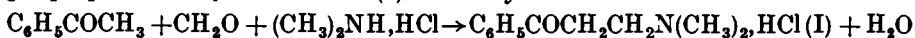

The exact *mechanism* of the reaction is not known with certainty. It has

transfer the filtrate to a 500 ml. wide-mouthed conical flask and, while still warm, add 200 ml. of acetone. Allow to cool to room temperature and leave in a refrigerator overnight. Filter the crystals at the pump, wash with 10 ml. of acetone, and dry for 6 hours at 40–50°: the yield of crude product, m.p. 152–155°, is 38 g. Recrystallise the crude product by dissolving in 45 ml. of hot rectified spirit and slowly adding 225 ml. of acetone to the solution; collect the solid which separates by suction filtration and dry at 70°. The purified material melts at 155–156° and the recovery is about 90 per cent.

β -Benzoylpropionitrile. To a mixture of 21.4 g. of β -dimethylamino-propiofenone hydrochloride, 13.0 g. of potassium cyanide in a 500 ml. flask, add 260 ml. of boiling water; heat the heterogeneous mixture under reflux for 30 minutes. Part of the dimethylamine, which is eliminated in the reaction, distils: collect this in dilute hydrochloric acid. Cool the reaction mixture in ice; the oil solidifies and crystals form from the aqueous layer. Collect the solid (crude β -benzoylpropionitrile, 10.5 g.) by suction filtration and recrystallise it from benzene-light petroleum (b.p. 40–60°); it separates as almost colourless blades, m.p. 76°.

VI.21.

THE MICHAEL REACTION

The addition of active methylene compounds (ethyl malonate, ethyl acetoacetate, ethyl phenylacetate, nitromethane, acrylonitrile, etc.) to the $\alpha\beta$ -double bond of a conjugated unsaturated ketone, ester or nitrile in the presence of a basic catalyst (sodium ethoxide, piperidine, diethylamine, etc.) is known as the **Michael reaction** or **Michael addition**. The reaction may be illustrated by the addition of ethyl malonate to ethyl fumarate in the presence of sodium ethoxide; hydrolysis and decarboxylation of the addendum (ethyl propane-1:1:2:3-tetracarboxylate) yields tricarballic acid:

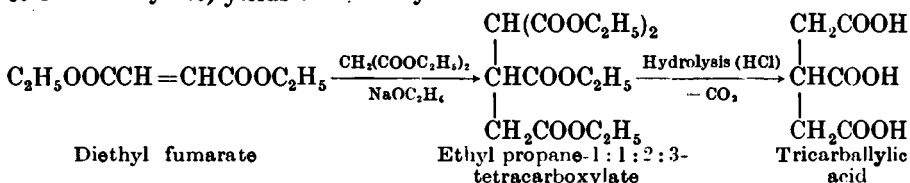

In the above reaction one molecular proportion of sodium ethoxide is employed; this is Michael's original method for conducting the reaction, which is reversible and particularly so under these conditions, and in certain circumstances may lead to apparently abnormal results. With smaller amounts of sodium alkoxide (1/5 mol or so: the so-called catalytic method) or in the presence of secondary amines, the equilibrium is usually more on the side of the adduct, and good yields of adducts are frequently obtained. An example of the Michael addition of the latter type is to be found in the formation of ethyl propane-1:1:3:3-tetracarboxylate (II) from formaldehyde and ethyl malonate in the presence of diethylamine. Ethyl methylene-malonate (I) is formed intermediately by the simple Knoevenagel reaction and this is followed by the Michael addition. Acid hydrolysis of (II) gives glutaric acid (III).

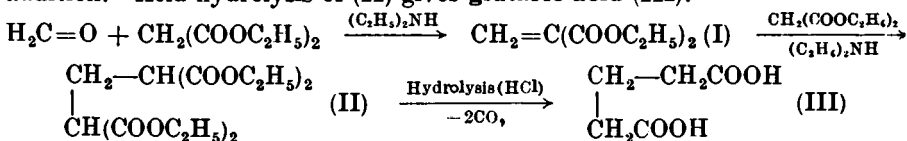

It is of interest to note that the preparation of dimethyldihydroresorcinol (also named dimedone and methone; Section VII,15) involves an initial Michael addition to mesityl oxide, followed by an internal Claisen condensation.

The *mechanism* of the Michael reaction probably follows the following course. Writing $RCH=CHCOOC_2H_5$ for $C_2H_5OOCCH=CHCOOC_2H_5$ and B for $\bar{O}C_2H_5$ or $(C_2H_5)_2NH$ for the sake of simplicity, we have :

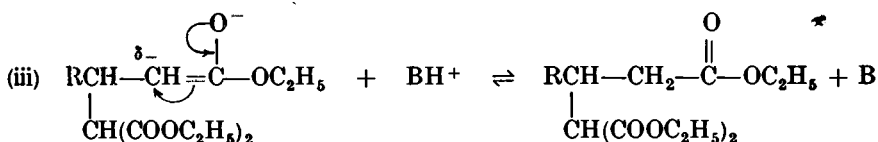
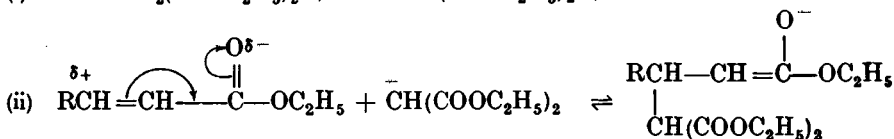
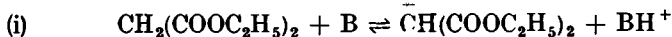

Ethyl propane-1 : 1 : 2 : 3-tetracarboxylate. In a 1-litre three-necked flask, fitted with an efficient reflux condenser, mechanical stirrer and a dropping funnel, prepare a solution of sodium ethoxide from 18.4 g. of clean sodium and 200 g. (253 ml.) of super-dry ethyl alcohol (see Section II,47,5). Cool the flask and add, with stirring, 160 g. (151 ml.) of redistilled diethyl malonate through the condenser. Warm the mixture gently on a water bath and introduce 140 g. (131.5 ml.) of redistilled diethyl fumarate (1) from the dropping funnel at such a rate that the mixture boils gently. When the addition is complete, boil for 1 hour, cool and add 50 g. (47.5 ml.) of glacial acetic acid. Distil off most of the alcohol on the water bath under slightly reduced pressure and pour the residue into sufficient distilled water to dissolve all the solid. Separate the ester layer : extract the aqueous layer with four 25 ml. portions of carbon tetrachloride. Wash the combined ester and carbon tetrachloride extracts twice with 25 ml. of water. Distil off the carbon tetrachloride under atmospheric pressure through a short column (the moisture is carried over with the solvent) and distil the residue under reduced pressure. Collect the ethyl propane-1 : 1 : 2 : 3-tetracarboxylate at 182-184°/8 mm. The yield is 250 g.

Note.

(1) The diethyl fumarate is readily prepared as follows. Reflux a mixture of 145 g. of fumaric acid (Section III,143), 185 g. (236 ml.) of absolute ethanol, 450 ml. of benzene and 20 g. of concentrated sulphuric acid for 12 hours. Pour into a large volume of water, separate the benzene layer, wash successively with water, saturated sodium bicarbonate solution and water, dry with anhydrous magnesium sulphate, and remove the solvent on a steam bath. Distil the residue and collect the diethyl fumarate at 213-215° : the yield is 150 g.

Tricarballic acid. Place 228 g. (204 ml.) of ethyl propane-1 : 1 : 2 : 3-tetracarboxylate and 240 ml. of 1 : 1-hydrochloric acid in a 1-litre three-necked flask, fitted with a mechanical stirrer and a fractionating column with condenser set for downward distillation ; attach a receiver with side tube to the condenser and connect the side tube to a wash bottle containing water. Boil the mixture, with continual stirring, at such a rate that the

alcohol is removed as fast as it is formed, but without undue removal of water from the flask. The progress of the reaction may be followed from the rate at which carbon dioxide passes through the wash bottle. When the temperature at the head of the column approaches 100° , adjust the heating of the flask so that very little liquid distils over: continue the heating until the evolution of carbon dioxide ceases (*ca.* 12 hours). Disconnect the flask from the stirrer and column, and distil the contents as completely as possible on the steam bath under reduced pressure (water pump): remove the residual moisture and hydrochloric acid by drawing a slow stream of air (use a tube leading to the bottom of the flask) through whilst still heating on a steam bath and maintaining a partial vacuum. Dissolve the residue in distilled water, filter the solution through a short column of decolourising carbon and again evaporate to dryness under reduced pressure. Grind the dry residue to a fine powder, mix it to a paste with dry ether, filter by suction, wash with a little anhydrous ether, and dry in a steam oven. The resulting tricarballic acid, m.p. $160\text{--}161^{\circ}$, is practically pure and weighs 118 g.

Ethyl propane-1 : 1 : 3 : 3-tetracarboxylate. Cool a mixture of 320 g. (302 ml.) of redistilled diethyl malonate and 80 g. of 40 per cent. formaldehyde solution ("formalin") contained in a 1-litre round-bottomed flask to 5° by immersion in ice, and add 5 g. (7 ml.) of diethylamine. Keep the mixture at room temperature for 15 hours and then heat under a reflux condenser on a boiling water bath for 6 hours. Separate the aqueous layer, dry the organic layer with anhydrous magnesium sulphate, and distil under reduced pressure. Collect the ethyl 1 : 1 : 3 : 3-tetracarboxylate at $200\text{--}215^{\circ}/20$ mm. The yield is 250 g.

Glutaric acid. Heat a mixture of 125 g. of the preceding ester and 250 ml. of 1 : 1-hydrochloric acid under reflux with stirring in a 1-litre three-necked flask equipped with a mechanical stirrer and reflux condenser (the third neck is stoppered). Continue the heating until the mixture becomes homogeneous (6–8 hours). Evaporate the contents of the flask to dryness on a steam bath, transfer the residual glutaric acid to a Claisen flask and distil under reduced pressure (compare Fig. II, 19, 4). Collect the fraction boiling at $185\text{--}195^{\circ}/10$ mm.: it crystallises on cooling. Moisten with a little water (to convert any glutaric anhydride present into the acid), heat gently and dry at 30° . Recrystallise from benzene; the resulting practically pure glutaric acid, m.p. $96\text{--}97^{\circ}$ (compare Section III, 158) weighs 40 g.

VI.22.

CYANOETHYLATION

Many inorganic and organic compounds possessing labile hydrogen atoms add acrylonitrile readily with the formation of compounds containing a cyanoethyl grouping ($-\text{CH}_2\text{.CH}_2\text{.CN}$). This reaction is usually known as *cyanoethylation*:

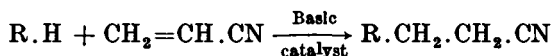

Typical compounds which undergo cyanoethylation include the following:

1. Compounds containing one or more $-\text{OH}$ or $-\text{SH}$ groups, such as water, alcohols, phenols, oximes, hydrogen sulphide and thiols.

2. Compounds containing one or more —NH— groups, *e.g.*, ammonia, primary and secondary amines, hydrazines, hydroxylamines and amides.

3. Ketones or aldehydes possessing a —CH—, —CH₂—, or —CH₃ group adjacent to the carbonyl group.

4. Compounds such as malonic esters, malonamide and cyanoacetamide, in which a —CH— or —CH₂— group is situated between —CO₂R, —CN, or —CONH— groups.

The cyanoethylation reaction, except with certain amines, usually requires the presence of an alkaline catalyst (0.5 to 5 percent. of the weight of acrylonitrile) such as the hydroxides, alkoxides and amides of sodium and potassium and the strongly basic quaternary ammonium hydroxides, particularly benzyltrimethylammonium hydroxide (Triton B); the last-named are very effective because of their solubility in organic solvents. Many of the reactions are vigorously exothermic and require cooling to prevent excessive polymerisation of the acrylonitrile; the addition of inert solvents, such as benzene, dioxan and pyridine, may moderate the reaction. It is frequently advisable to dissolve or disperse the catalyst in the hydrogen donor, with or without the use of an inert solvent, and to add the acrylonitrile gradually while controlling the temperature of the reaction.

Anion exchange resins of the quaternary ammonium hydroxide type (*e.g.*, De-Acidite FF, IRA-400 or Dowex I) are strong bases and are useful catalysts for the cyanoethylation of alcohols and possibly of other active hydrogen compounds.

Experimental details are given for the cyanoethylation of primary alcohols and of secondary aliphatic amines:

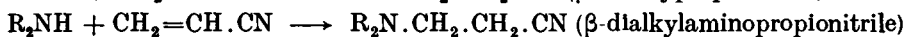

and also of substituted malonic esters:

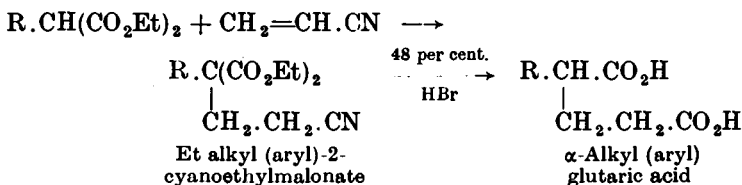

The last-named reaction provides an excellent method for the preparation of α -substituted glutaric acids: the intermediate alkyl (aryl) -2-cyanoethylmalonate is both hydrolysed and decarboxylated readily by boiling with an excess of 48 per cent. hydrobromic acid solution.

The *mechanism* of cyanoethylation is similar to that given in Section VI,21 for the Michael reaction. Acrylonitrile is the simplest $\alpha\beta$ -unsaturated organic nitrile.



and the various condensations with active hydrogen compounds are merely Michael additions: the active hydrogen is replaced by the cyanoethyl group. Compounds containing hydrogen insufficiently active to undergo Michael condensations with the usual acceptors react readily with acrylonitrile, *e.g.*, alcohols, ammonia, amines, etc., as detailed above. Cyanoethylation reactions usually proceed until all active hydrogen atoms are used up.

Pure acrylonitrile boils at 78°. *Acrylonitrile vapour is highly toxic*; it should therefore be handled with due caution and all operations with it should be conducted in a fume cupboard provided with an efficient draught. Acrylonitrile forms an azeotropic mixture with water, b.p. 70.5° (12.5 per cent. water). The commercial product may contain the polymer; it should be redistilled before use and the fraction b.p. 76.5–78° collected separately as a colourless liquid.

β-Ethoxypropionitrile, $C_2H_5O.CH_2.CH_2.CN$. Place 25 ml. of 2 per cent. aqueous sodium hydroxide and 26 g. (33 ml.) of ethyl alcohol in a 250 ml. reagent bottle, add 26.5 g. (33 ml.) of acrylonitrile and close the mouth of the bottle with a tightly-fitting cork. Shake the resulting clear homogeneous liquid in a shaking machine for 2 hours. During the first 15 minutes the temperature of the mixture rises 15° to 20° and thereafter falls gradually to room temperature; two liquid layers separate after about 10 minutes. Remove the *upper* layer and add small quantities of 5 per cent. acetic acid to it until neutral to litmus; discard the lower aqueous layer. Dry with anhydrous magnesium sulphate, distil and collect the β-ethoxypropionitrile at 172–174°. The yield is 32 g.

The technique for using an *anion exchange resin as catalyst* is as follows. Regenerate the resin (De-Acidite FF or IRA-400) by washing it on a Buchner funnel with 5 per cent. sodium hydroxide solution (5–6 times the volume of the resin); rinse the resin with distilled water until the washings are neutral and dry in the air. In a 500 ml. three-necked flask equipped with a reflux condenser, stirrer and a dropping funnel, place 25 g. of the regenerated resin and 46 g. (58.5 ml.) of ethyl alcohol. Immerse the flask in an ice bath to control the subsequent initial exothermic reaction and to hold the temperature below 15–20° throughout the experiment. Add 67 g. (85 ml.) of redistilled acrylonitrile slowly to the well-stirred mixture in the flask over a period of 1–2 hours; continue the stirring for a further 1.5 hours. Separate the resin by filtration. Distil the filtrate at atmospheric pressure to 100° in order to remove unreacted acrylonitrile and ethanol, and the residue under reduced pressure. Collect the β-ethoxypropionitrile at 77–78°/25 mm. The yield is about 100 g.

β-*n*-Propoxypropionitrile, $C_3H_7^{\alpha}O.CH_2.CH_2.CN$. Introduce 0.15 g. of potassium hydroxide and 33 g. (41 ml.) of dry *n*-propyl alcohol into a 150 ml. bolt-head flask, warm gently until the solid dissolves, and then cool to room temperature. Clamp the neck of the flask and equip it with a dropping funnel, a mechanical stirrer and a thermometer (suitably supported in clamps). Introduce from the dropping funnel, with stirring, 26.5 g. (33 ml.) of pure acrylonitrile over a period of 25–30 minutes (1 drop every *ca.* 2 seconds). Do not allow the temperature of the mixture to rise above 35–45°; immerse the reaction flask in a cold water bath, when necessary. When all the acrylonitrile has been added, heat under reflux in a boiling water bath for 1 hour; the mixture darkens. Cool, filter and distil. Collect the β-*n*-propoxypropionitrile at 187–189°. The yield is 38 g.

β-Diethylaminopropionitrile, $(C_2H_5)_2N.CH_2.CH_2.CN$. Mix 42.5 g. (60 ml.) of freshly-distilled diethylamine and 26.5 g. (33 ml.) of pure acrylonitrile in a 250 ml. round-bottomed flask fitted with a reflux

condenser. Heat at 50° in a water bath for 10 hours and then allow to stand at room temperature for 2 days. Distil off the excess of diethylamine on a water bath, and distil the residue from a Claisen flask under reduced pressure. Collect the β -diethylaminopropionitrile at 75–77°/11 mm.; the yield is 54 g.

β -Di-*n*-butylaminopropionitrile, $(C_4H_9^\alpha)_2N.CH_2.CH_2.CN$. Proceed as for the diethyl compound using 64.5 g. (85 ml.) of redistilled di-*n*-butylamine and 26.5 g. (33 ml.) of pure acrylonitrile. After heating at 50° and standing for 2 days, distil the entire product under diminished pressure (air bath); discard the low boiling point fraction containing unchanged di-*n*-butylamine and collect the β -di-*n*-butylaminopropionitrile at 120–122°/10 mm. The yield is 55 g.

***n*-Propylglutaric acid**. Add 8.0 g. (10.0 ml.) of redistilled acrylonitrile to a stirred solution of ethyl *n*-propyl malonate (30.2 g.) (Section III,154) and of 30 per cent. methanolic potassium hydroxide (4.0 g.) in *tert*-butyl alcohol (100 g.). Keep the reaction mixture at 30°–35° C. during the addition and stir for a further 3 hours. Neutralise the solution with dilute hydrochloric acid (1:4), dilute with water and extract with ether. Dry the ethereal extract with anhydrous magnesium sulphate and distil off the ether: the residue (ethyl *n*-propyl-2-cyanoethylmalonate; 11 g.) solidifies on cooling in ice, and melts at 31°–32° after recrystallisation from ice-cold ethyl alcohol. Boil the cyanoethyl ester (10 g.) under reflux with 40 ml. of 48 per cent. hydrobromic acid solution for 8 hours, and evaporate the solution almost to dryness under reduced pressure. Add sufficient water to dissolve the ammonium bromide, extract several times with ether, dry the ethereal extract, and distil off the solvent. The residual oil (7.5 g.) soon solidifies: upon recrystallisation from water, pure *n*-propylglutaric acid, m.p. 70°, is obtained.

VI,23. THE SCHMIDT REACTION OR REARRANGEMENT

The conversion of a carboxylic acid into an amine by treatment with hydrazoic acid in concentrated sulphuric acid is known as the Schmidt reaction or rearrangement;

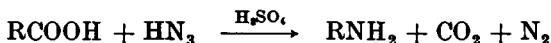

Other carbonyl compounds are within the scope of the reaction; ketones give amides, and aldehydes yield nitriles and formyl derivatives of amines:

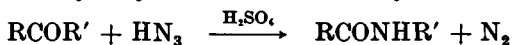

In the alkyl aryl ketones, the aryl groups migrate preferentially, yielding *N*-aryl amides.

The Schmidt reaction (as applied to a carboxylic acid) is therefore a method for the degradation of an acid to an amine with one less carbon atom and in this respect resembles the Hofmann rearrangement (see discussion prior to Section III,16) of acid amides. The yields are often higher and the carboxylic acid may be employed directly. The disadvantages are the toxicity of the reagent (usually a 4–10 per cent. solution of hydrazoic acid in chloroform or benzene) thus necessitating rigorous precautions, and also the possibility of explosion during the

3 : 5-Dinitroaniline from 3 : 5-dinitrobenzoic acid. Place a solution of 50 g. of 3 : 5-dinitrobenzoic acid (Section IV, 168) in 90 ml. of 10 per cent. oleum and 20 ml. of concentrated sulphuric acid in a 1-litre three-necked flask equipped with a reflux condenser, mechanical stirrer, a dropping funnel, and thermometer (*FUME CUPBOARD!*). Add 100 ml. of chloroform and raise the temperature to 45°. Stir rapidly and add 17.5 g. of sodium azide in small portions whilst maintaining the temperature at 35–45°. The reaction is accompanied by foaming, which usually commences after about 3 g. of sodium azide has been introduced. After all the sodium azide has been added raise the temperature so that the chloroform refluxes vigorously and maintain this temperature for 3 hours. Then cool the reaction mixture, pour it cautiously on to 500 g. of crushed ice, and dilute with 3 litres of water. After 1 hour, separate the yellow solid by filtration at the pump, wash well with water and dry at 100°. The yield of 3 : 5-dinitroaniline, m.p. 162–163°, is 39 g. The m.p. is unaffected by recrystallisation from dilute alcohol.

Acetanilide from acetophenone. Dissolve 12 g. of acetophenone in 100 ml. of glacial acetic acid containing 10 g. of concentrated sulphuric acid. To the stirred solution at 60–70°, add 9.8 g. of sodium azide in small portions at such a rate that the temperature does not rise above 70°. Stir the mixture with gentle heating until the evolution of nitrogen subsides (2–3 hours) and then allow to stand overnight at room temperature. Pour the reaction mixture on to 300 g. of crushed ice, filter the solid product, wash it with water and dry at 100°. The yield of crude acetanilide, m.p. 111–112°, is 13 g. Recrystallisation from water raises the m.p. to 114°.

VI.24.

THE STOBBE CONDENSATION

The condensation of aldehydes and ketones with succinic esters in the presence of sodium ethoxide is known as the *Stobbe condensation*. The reaction with sodium ethoxide is comparatively slow and a little reduction of the ketonic compound to the carbinol usually occurs; a shorter reaction time and a better yield is generally obtained with the more powerful condensing agent potassium *tert.*-butoxide or with sodium hydride. Thus benzophenone condenses with diethyl succinate in the presence of potassium *tert.*-butoxide to give a 94 per cent. yield of β -carbethoxy- γ -diphenylvinylacetic acid {(I) is the potassium salt} :

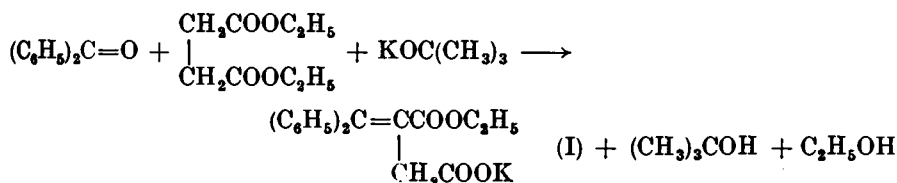

A simple application of the reaction may be mentioned. Refluxing of (I) with 48 per cent. hydrobromic acid and glacial acetic acid leads to hydrolysis and decarboxylation and the production of a mixture of the γ -lactone { γ -diphenylbutyrolactone (II)} and the isomeric unsaturated acid { γ -diphenylvinylacetic acid (III)}; reduction by the Clemmensen method or catalytically

(copper-chromium oxide) affords the saturated acid { $\gamma\gamma$ -diphenylbutyric acid (IV)} :

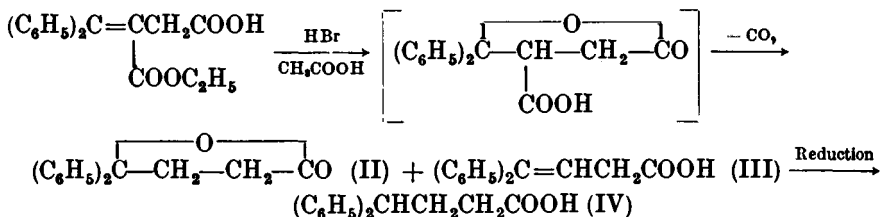

The Stobbe condensation thus provides a method for introducing a propionic acid residue at the site of a carbonyl group.

The following *mechanism* for the reaction has been suggested. It postulates formation of an intermediate paraconic ester (A); the irreversible alkoxide cleavage of this cyclic ester drives the reaction to completion :

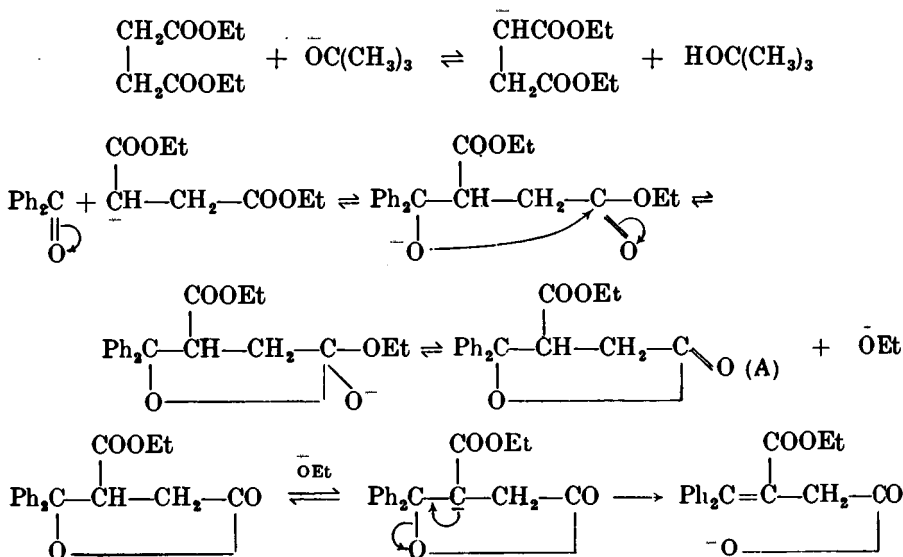

β -Carbethoxy- $\gamma\gamma$ -diphenylvinylacetic acid. Potassium *tert*-butoxide method. Fit up the apparatus shown in Fig. VI, 24, 1; all parts of the apparatus must be thoroughly dry. Attach a 500 ml. round-bottomed flask by a ground glass joint (not shown) to the reflux condenser (coil type) and connect the top to a three-way stopcock leading through (A) to a cylinder of nitrogen with fine control valve and a mercury trap, and through (B) to a water filter pump. Thoroughly dry the flask and condenser by warming with a gentle flame whilst the system is under reduced pressure (stopcock turned to B to connect filter pump). Admit dry nitrogen (1) to the apparatus by turning the stopcock slowly to position A while nitrogen is bubbled through the mercury trap. Charge the cooled flask rapidly with 45 ml. of anhydrous *tert*-butyl alcohol (2) and 2.15 g. of potassium (3) and reconnect it to the apparatus. Stop the stream of nitrogen, close the screw clip and boil the mixture under reflux until the

potassium dissolves completely (*ca.* 4 hours); the hydrogen evolved passes through the mercury trap. Allow the solution to cool to room temperature whilst admitting nitrogen to equalise the pressure. Disconnect the flask just long enough to introduce 9.11 g. of pure benzophenone and 13.05 g. (12.55 ml.) of redistilled diethyl succinate. Evacuate the system (until the alcohol commences to boil) and fill it with nitrogen. With the stop-cock in position A and the screw clip closed, reflux the mixture gently for 30 minutes; some of the potassium salt of the half ester may precipitate. Cool the flask in ice, acidify with 10 ml. of cold 1:1-hydrochloric acid and distil under reduced pressure (water pump) until most of the alcohol is removed. Add water to the residue, extract several times with ether, wash the combined ethereal extracts with *N* ammonia solution until a test portion gives no precipitate upon acidification. Extract the combined alkaline solutions once with a fresh portion of ether, and add the aqueous solution to an excess of dilute hydrochloric acid; the final mixture should still be acidic to Congo red. Collect the crystalline half-ester by filtration at the pump, wash it with water and dry at 100°. The yield is 14.5 g., m.p. 122–125°. Recrystallise by dissolving in about 40 ml. of warm benzene and adding an equal volume of petroleum ether (b.p. 40–60°); 13.5 g. of the colourless half-ester, m.p. 125–126°, are obtained.

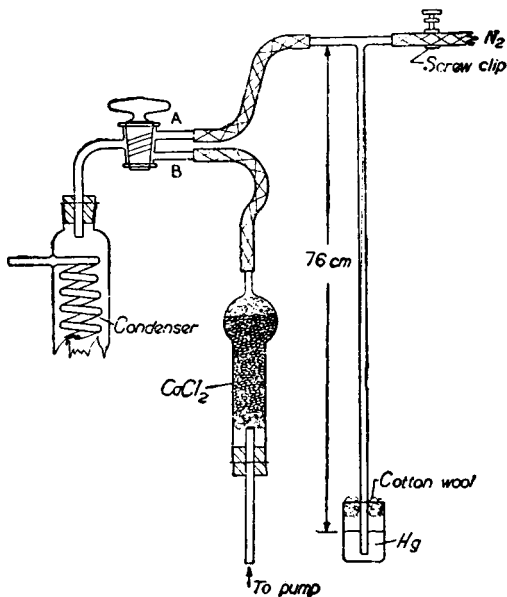

Fig. VI, 24, 1.

Notes.

(1) Dry the cylinder nitrogen by passing through a train consisting of (a) a trap, (b) a wash bottle containing concentrated sulphuric acid, and (c) a drying tube containing fresh soda lime.

(2) Prepare anhydrous *tert.*-butyl alcohol by refluxing the commercial product with sodium (*ca.* 4 g. per 100 ml.) until the metal is about two-thirds dissolved and then distilling. Free metal should be present during the distillation.

(3) *Great care must be taken in the handling of potassium* and the following precautions must be rigidly observed. Cut the metal under xylene (which has been dried over sodium wire) contained in a mortar; do not use a beaker or a crystallising dish because it is too fragile. Cut off the outer oxide-coated surface and *immediately* transfer the scraps with tweezers to a second mortar containing dry xylene. Weigh the freshly-cut potassium by removing it with tweezers to a filter paper, blot it rapidly, and introduce it into a tared beaker containing dry xylene. Introduce the weighed potassium into the reaction mixture: take adequate precautions with regard to the exclusion of air and moisture, rate of addition, etc., depending upon the reaction involved.

The scraps of potassium should not be stored : they must be decomposed immediately by transferring the mortar to the rear of an empty fume cupboard (hood) and adding *tert.*-butyl alcohol (*not* methyl or ethyl alcohol) in small portions from a dropper pipette at such a rate that the reaction does not become vigorous. Keep a square sheet of asbestos, large enough to cover the mortar, at hand ; if the liquid should catch fire, it may be extinguished easily by covering the mortar with the asbestos sheet. Add sufficient *tert.*-butyl alcohol to react completely with all the potassium. Any specks of potassium remaining in the first mortar used for the cutting operation or small scraps that adhere to the knife must be disposed of in the fume cupboard by cautious treatment with *tert.*-butyl alcohol as described above.

Sodium hydride method. All apparatus must be thoroughly dry. Equip a 125 ml. round-bottomed flask (ground glass joints) with a coil condenser, a Hershberg tantalum wire stirrer passing through a glass bearing capped with a silicone-lubricated rubber sleeve (compare Fig. II, 56, 35) ; the third neck carries a ground glass stopper which is removed for the addition of reagents. Attach the top of the condenser to a source of dry nitrogen and to a filter pump as in Fig. VI, 24, 1. Evacuate the apparatus, dry it by heating gently with a flame and fill it with nitrogen as described above. Whilst nitrogen is flowing, remove the stopper, wash in 2.4 g. of sodium hydride (1) with the aid of about 25 ml. of sodium-dried benzene, followed by 9.11 g. of pure benzophenone and 26.13 g. of freshly distilled diethyl succinate, washed into the flask with an additional 25 ml. of dry benzene. Add a little absolute ethyl alcohol (0.75 ml.) (2), replace the stopper, arrest the flow of nitrogen and close the screw clip. Start the stirrer : hydrogen is evolved through the mercury trap, slowly at first and then more rapidly as the reaction progresses. Cool the flask with a cold water bath, as required, to maintain the temperature below 40°. After about 8 hours the evolution of gas has usually subsided and the reaction is essentially complete. Cool the mixture with an ice bath, and add 10.5 ml. of glacial acetic acid dropwise (to avoid excessive foaming), followed by water and ether : separate the aqueous layer and extract it with ether. Extract the combined ethereal solutions repeatedly with 5 per cent. sodium carbonate solution until a test portion shows no cloudiness upon acidification. Acidify the combined alkaline solutions with dilute hydrochloric acid, filter off the crystalline half-ester, wash and dry at 100°. The yield of almost pure product, m.p. 124–125°, is 15.0 g.

Notes.

(1) *Great care must be taken in handling sodium hydride* and experimental details for its manipulation with comparative safety are given below. Sodium hydride* is a white, crystalline, free-flowing powder ; it must be kept in air-tight containers for protection against moisture and oxygen. The hermetically sealed tin in which it is supplied may be opened without hazard in ordinary dry air and the solid *rapidly* transferred from the container to a reaction vessel. If exposed to the air unduly, traces of sodium hydroxide formed on the surface render the material hygroscopic ; rapid absorption of atmospheric moisture may then take place, and the heat generated by the reaction with water may suffice to ignite the solid. The fire is not violent and may be extinguished readily by excluding air either by the application of an asbestos blanket or by the use of anhydrous sodium carbonate ; carbon dioxide and carbon

* Available from New Metals and Chemicals Ltd., 16 Northumberland Avenue, London, W.C. 2., or from Electrochemicals Dept., E.I. du Pont de Nemours and Co., Wilmington, U.S.A.

tetrachloride must not be used since some metallic sodium may be liberated. Sodium hydride may be weighed on an ordinary balance provided a stream of nitrogen is passed through the balance case and directed over the balance pans, and the operation is conducted rapidly. It is better, however, to conduct all operations involving weighing of sodium hydride in a "dry box" constructed from an old balance case: the latter contains an inlet and outlet for dry nitrogen and also two openings, one on each side, to which are attached sleeves made of plastic material. The operator's hands pass through these sleeves and reasonable seals between the hands and the sleeves are made with rubber bands. Manipulation, including weighing, can be carried out inside the box in an atmosphere of dry nitrogen.

(2) A little ethyl alcohol (0.25 mol alcohol per mol of ketone) is usually required to initiate the reaction. The alcohol reacts rapidly with the sodium hydride to produce sodium ethoxide, which may be the true condensing agent: as the reaction proceeds alcohol is formed as a by-product, which reacts with the sodium hydride, etc., and the rate of condensation gradually increases as shown by the increased evolution of hydrogen. The essential difference between this and the classical sodium ethoxide method is that there is no accumulation of alcohol: some self-condensation of the ester to give diethyl 1:4-diketocyclohexane-2:5-dicarboxylate occurs. The latter may be isolated by extracting the ethereal solution of the reaction product first with 5 per cent. sodium bicarbonate solution to remove the half-ester: a further extraction of the ethereal solution with 5 per cent. potassium hydroxide solution enables the self-condensation product to be isolated.

VI,25

THE WILLGERODT REACTION

When an alkyl aryl ketone is heated with yellow ammonium polysulphide solution at an elevated temperature, an aryl substituted aliphatic acid amide is formed; the product actually isolated is the amide of the ω -aryl carboxylic acid together with a smaller amount of the corresponding ammonium salt of the carboxylic acid. Thus acetophenone affords phenylacetamide (50 per cent.) and ammonium phenylacetate (13 per cent.):

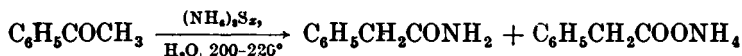

The conversion of a carbonyl compound by ammonium polysulphide solution into an amide with the same number of carbon atoms is known as the Willgerodt reaction. The procedure has been improved by the addition of about 40 per cent. of dioxan or of pyridine to increase the mutual solubility of the ketone and aqueous ammonium polysulphide; the requisite temperature is lowered to about 160° and the yield is generally better.

A further improvement is embodied in the Kindler variation of the Willgerodt reaction: this consists in heating the ketone with approximately equal amounts of sulphur and a dry amine instead of aqueous ammonium polysulphide. The principal product is a thioamide, and hydrolysis with acid or alkali affords the carboxylic acid, usually in good yield.

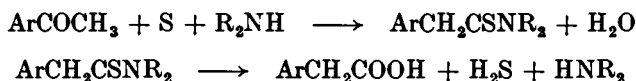

If the inexpensive morpholine $\text{HN} \begin{array}{l} \diagup \text{CH}_2-\text{CH}_2 \diagdown \\ \diagdown \text{CH}_2-\text{CH}_2 \diagup \end{array} \text{O}$, b.p. 128°, is employed, the

reaction may be conducted in an open apparatus in place of a bomb tube or

autoclave. The simplified procedure for carrying out the Willgerodt reaction is described for a number of ketones :

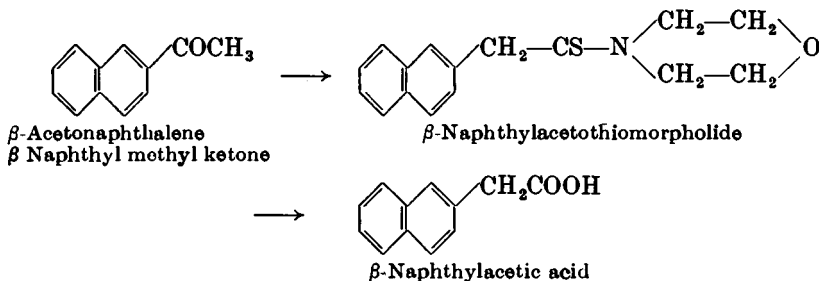

Propiophenone \longrightarrow hydrocinnamic acid

p-Methoxyacetophenone \longrightarrow *p*-methoxyphenylacetic acid

p-Bromoacetophenone \longrightarrow *p*-bromophenylacetic acid

The *mechanism* of the reaction is not known with certainty. It is known from studies utilising ^{14}C as tracer that no change in the carbon skeleton occurs during the reaction, and also that unsaturated hydrocarbons can undergo reactions very similar to those of ketones; thus both styrene and phenylacetylene can react with sulphur and morpholine to produce phenylacetothiomorpholide, hydrolysis of which yields phenylacetic acid :

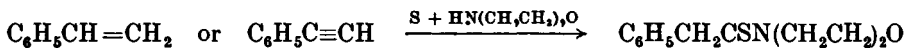

It has been tentatively suggested that one mechanism underlies the Willgerodt reaction and the Kindler modification of it. A labile intermediate is first formed which has a carbon-carbon bond in the side chain. The scheme is indicated below; it postulates a series of steps involving the addition of ammonia or amine ($\text{R} = \text{H}$ or alkyl), elimination of water, re-addition and elimination of ammonia or amine until the unsaturation appears at the end of the chain: then an irreversible oxidation between sulphur and the nitrogen compound may occur to produce a thioamide.

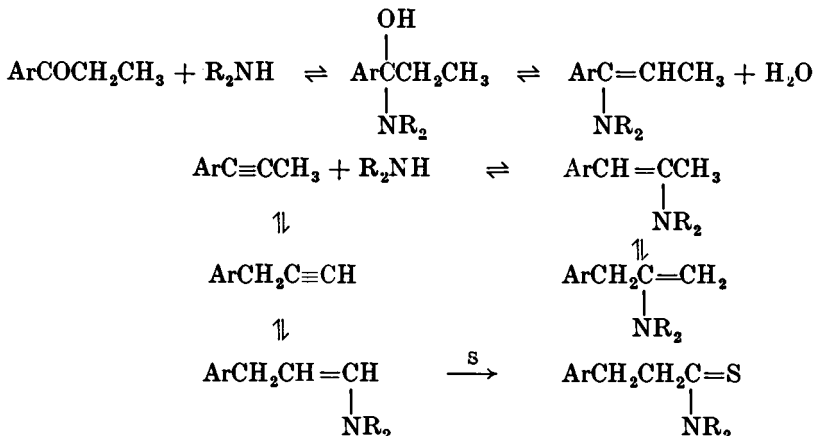

β -Naphthylacetic acid. In a conical or round-bottomed flask, fitted with a reflux condenser by means of a ground glass joint, place a mixture of 128 g. of β -naphthyl methyl ketone (Section IV, 136), 35 g. of sulphur and

97 g. (97 ml.) of morpholine (b.p. 126–128°). Reflux in the fume cupboard (hood) gently at first until the evolution of hydrogen sulphide subsides and then more vigorously for a total period of 14 hours. Pour the hot reaction mixture, which has separated into two layers, into 400 ml. of warm ethanol and leave to crystallise. The β -naphthylacetothiomorpholide separates as pale buff crystals. Filter at the pump and wash with a little cold ethanol; the yield of crude thiomorpholide, m.p. 103–108°, is 178 g.

Mix 130 g. of the crude thiomorpholide with 270 ml. of glacial acetic acid, 40 ml. of concentrated sulphuric acid and 60 ml. of water; raise the temperature of the mixture carefully to the boiling point and reflux for 5 hours. Decant the solution from a little tarry matter into 2 litres of water and keep overnight. Collect the solid by suction filtration and wash it well with cold water. Digest the solid with a solution of 50 g. of sodium hydroxide in 1 litre of water, filter and acidify the filtrate with hydrochloric acid; filter off the crude β -naphthylacetic acid, wash with water and dry. The yield of the crude acid, m.p. 137–140°, is 75 g. Recrystallisation from benzene raises the m.p. to 142–143°; the loss is about 10 per cent.

Hydrocinnamic acid. Reflux a mixture of 53.5 g. of propiophenone (Section IV,137), 20.5 g. of sulphur and 46 g. (46 ml.) of morpholine for 6 hours. Pour the reaction product into 400 ml. of 10 per cent. alcoholic sodium hydroxide solution and reflux for 7 hours. Distil off the alcohol, dilute with water, acidify with hydrochloric acid (to Congo red paper), and extract three times with ether. Wash the ether extracts with water, dry, remove the ether and distil. Collect the hydrocinnamic acid at 125–129°/6 mm.; it solidifies completely on cooling, m.p. 46–47°. The yield is 39 g.

***p*-Methoxyphenylacetic acid.** Reflux a mixture of 42 g. of *p*-methoxyacetophenone (Section IV,138), 13.5 g. of sulphur and 30 g. (30 ml.) of morpholine for 5 hours. Pour the reaction mixture slowly into water, allowing the first addition to crystallise before the bulk of the mixture is added. Filter off the crude yellow solid, grind it up thoroughly with water, filter again and dry in the air. The yield of crude acetothiomorpholide, m.p. 65–67°, is 68 g. Recrystallisation from dilute methanol raises the m.p. to 71–72°.

Add 50 g. of the crude acetothiomorpholide to 400 ml. of 10 per cent. alcoholic sodium hydroxide solution and reflux the mixture for 10 hours. Distil off most of the alcohol, add 100 ml. of water to the residue, and strongly acidify the alkaline solution with hydrochloric acid. Cool, extract thrice with ether, dry the combined ether extracts, evaporate the solvent, and recrystallise the residue from water or dilute alcohol. The yield of *p*-methoxyphenylacetic acid, m.p. 85–86°, is 26 g. A further quantity of acid may be obtained by extracting the mother liquors with ether.

***p*-Bromophenylacetic acid.** Reflux a mixture of 50 g. of *p*-bromoacetophenone (Section IV,138), 12.8 g. of sulphur and 30 ml. of morpholine for 8 hours. Saponify the crude reaction product with 250 ml. of 10 per cent. alcoholic sodium hydroxide solution and work up as described for the *p*-methoxy acid. The yield of crude *p*-bromophenylacetic acid, m.p. 107–109°, is 25 g. Recrystallisation from water gives the pure acid, m.p. 113–114°.

VI,26. THE WOHL - ZIEGLER REACTION. APPLICATIONS OF *N*-BROMOSUCCINIMIDE

The direct introduction of a halogen atom (usually bromine) by means of *N*-haloamine (generally *N*-bromosuccinimide) in the "allyl" position is known as the Wohl-Ziegler reaction :

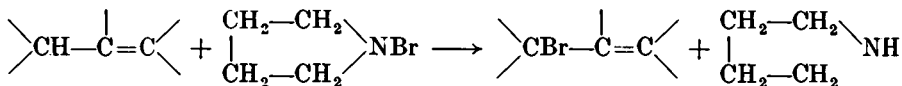

Bromination is carried out with anhydrous reagents (to avoid hydrolysis of the *N*-bromoimide), usually in boiling carbon tetrachloride or chloroform solution. The progress of the reaction can be followed by the fact that at first the heavy *N*-bromosuccinimide is at the bottom of the flask and is gradually replaced by succinimide, which rises to the surface : the reaction is complete when all the crystals are floating at the surface (detected by stopping the boiling momentarily). This can be confirmed (when equimolecular amounts are used) by transferring a drop of the solution to acidified potassium iodide - starch solution : iodine should not be liberated. After cooling, the insoluble succinimide is filtered off, washed with the solvent, and the product isolated, after removal of the solvent, by distillation or crystallisation.

Two simple applications may be mentioned. With *cyclohexene* (I) 3-bromo-*cyclohexene* (II) is obtained in good yield ; the latter upon dehydrobromination with quinoline affords an 80-90 per cent. yield of 1 : 3-*cyclohexadiene* (III) :

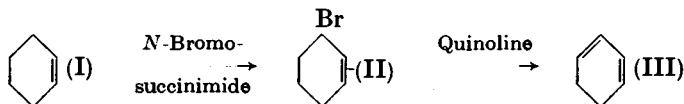

Methyl crotonate (IV) yields the valuable synthetic reagent methyl γ -bromocrotonate (V) :

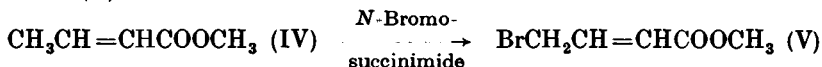

This compound permits the introduction (in moderate yield) of a four carbon atom chain at the site of the carbonyl group by the use of the Reformatsky reaction (compare Section VI,8) :

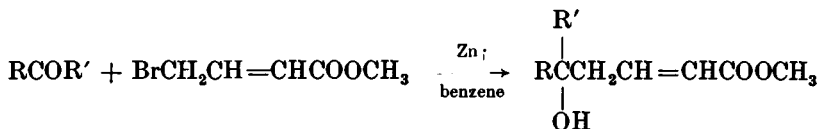

METHYL γ -BROMOCROTONATE

***N*-Bromosuccinimide.** Dissolve, with the aid of rapid mechanical stirring, 80 g. of pure succinimide (Section V,14) in a mixture of 150 g. of finely crushed ice and a solution of 32 g. of sodium hydroxide in 200 ml. of water contained in a litre beaker and cooled externally by ice. Immediately the imide has dissolved, continue the vigorous stirring and introduce 42.5 ml. of bromine in one lot from a separatory funnel supported over the beaker : it is essential that the bromine be instantly suspended in the solution. After stirring vigorously for 2 minutes, filter at the pump and

wash with ice-cold water until the washings are colourless. Recrystallise *as quickly as possible* from the minimum volume of hot water; dry first on a porous plate or upon pads of filter paper and then in a vacuum desiccator. The yield of pure dry bromosuccinimide is 110 g. The melting point is 180° (capillary tube; rapid heating) or 182° (hot plate; compare Fig. II, 11, 1). Recrystallisation from dry benzene does not affect the m.p.

A more active product is obtained by the following slight modification of the above procedure. Dissolve the succinimide in a slight molar excess of sodium hydroxide solution and add the bromine dissolved in an equal volume of carbon tetrachloride rapidly and with vigorous stirring. A finely crystalline white product is obtained. Filter with suction and dry thoroughly; the crude product can be used directly. It may be recrystallised from acetic acid.

Methyl crotonate. Purify commercial crotonic acid by distilling 100 g. from a 100 ml. Claisen flask attached to an air condenser; use an air bath (Fig. II, 5, 3). The pure acid passes over at 180–182° and crystallises out on cooling, m.p. 72–73°; the recovery is about 90 per cent. Place 75 g. of absolute methyl alcohol, 5 g. (2.7 ml.) of concentrated sulphuric acid and 50 g. of pure crotonic acid in a 500 ml. round-bottomed flask and heat under reflux for 12 hours. Add water, separate the precipitated ester and dissolve it in ether; wash with dilute sodium carbonate solution until effervescence ceases, dry with anhydrous magnesium sulphate, and remove the ether on a water bath. Distil and collect the methyl crotonate at 118–120°; the yield is 40 g.

Methyl γ -bromocrotonate. Mix 36 g. of *N*-bromosuccinimide, 40 g. of methyl crotonate and 60 ml. of dry, redistilled carbon tetrachloride in a 500 ml. round-bottomed flask. Reflux on a water bath for 12 hours; by this time all the solid should have risen to the surface of the liquid. Filter off the succinimide at the pump and wash it with a little dry carbon tetrachloride. Remove the solvent on a water bath and distil the residue under reduced pressure, preferably from a Widmer flask (compare Figs. II, 24, 4–5). Collect the methyl γ -bromocrotonate at 77–78°/8 mm.: the yield is 31 g.

VI,27. SYNTHESIS OF UNSYMMETRICAL DIARYLS

Unsymmetrical diaryls may be prepared by treating an aryl diazonium salt solution with sodium hydroxide or sodium acetate in the presence of a liquid aromatic compound. Thus 2-chlorodiphenyl is readily formed from *o*-chlorophenyl diazonium chloride and sodium hydroxide solution (or sodium acetate solution) in the presence of benzene:

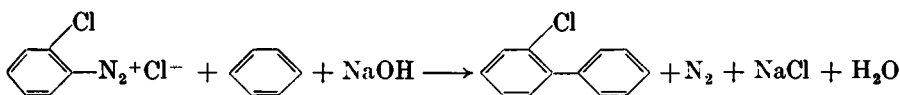

This is sometimes called the Gomberg or the Gomberg - Hey reaction.

The *mechanism* of the reaction probably involves the intermediate formation of the covalent diazo-hydroxide from the diazonium salt; the former decomposes

into free aryl radicals which displace hydrogen from the aromatic hydrocarbon present :

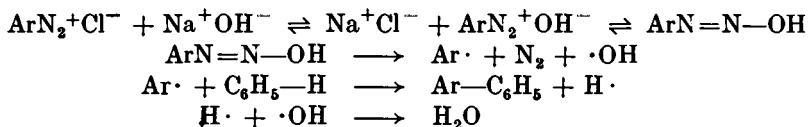

The usual directive influences are not operative in this and similar reactions for *ortho*-*para* substitution occurs (this may be modified by steric hindrance) irrespective of the nature of R in the aromatic liquid $\text{C}_6\text{H}_5\text{R}$, e.g. phenyldiazohydroxide and nitrobenzene yield 4-nitrodiphenyl; this supports the assumption that neutral free radicals are formed.

2-Chlorodiphenyl. Diazotise 32 g. of *o*-chloroaniline (Section IV,34) in the presence of 40 ml. of concentrated hydrochloric acid and 22.5 ml. of water in the usual manner (compare Section IV,61) with concentrated sodium nitrite solution. Transfer the cold, filtered diazonium solution to a 1.5 litre bolt-head flask surrounded by ice water, introduce 500 ml. of cold benzene, stir vigorously, and add a solution of 80 g. of sodium acetate trihydrate in 200 ml. of water dropwise, maintaining the temperature at 5–10°. Continue the stirring for 48 hours : after the first 3 hours, allow the reaction to proceed at room temperature. Separate the benzene layer, wash it with water, and remove the benzene by distillation at atmospheric pressure ; distil the residue under reduced pressure and collect the 2-chlorodiphenyl at 150–155°/10 mm. The yield is 18 g. Recrystallise from aqueous ethanol ; m.p. 34°.

4-Bromodiphenyl. Diazotise 43 g. of *p*-bromoaniline (Section IV,49) in the presence of 40 ml. of concentrated hydrochloric acid and 22.5 ml. of water (see Section IV,61) with a concentrated solution of sodium nitrite. Mix the filtered diazonium solution with 500 ml. of cold benzene, stir vigorously and add a solution of 30 g. of sodium hydroxide in 150 ml. of water dropwise (during 30–45 minutes) whilst maintaining the temperature at 5–10°. Complete the reaction as for 2-chlorodiphenyl. The yield of 4-bromodiphenyl, b.p. 170–175°/8 mm., m.p. 90° (from ethanol) is 25 g.

VI,28. SYNTHESSES WITH ORGANOLITHIUM COMPOUNDS

Many organolithium compounds may be prepared by the interaction of lithium with an alkyl chloride or bromide or with an aryl bromide in dry ethereal solution in a nitrogen atmosphere :

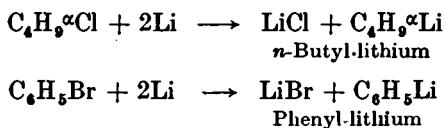

These compounds are soluble in ether, are comparatively stable, and exhibit many of the reactions of Grignard reagents but are more reactive. Because of their greater reactivity, organolithium compounds can often be used where Grignard reagents fail ; thus they add to the azomethine linkage in pyridines or

quinolines leading to 2-substituted compounds. This reaction is illustrated by the preparation of 2-phenylpyridine from pyridine and phenyl-lithium :

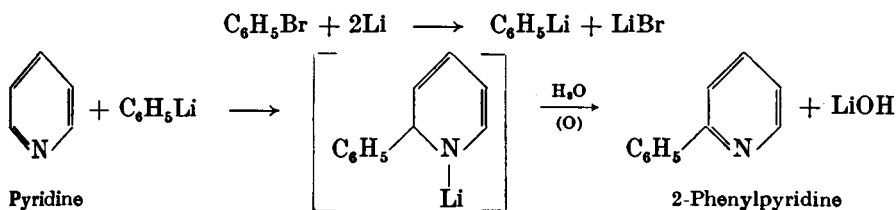

Another example illustrating the greater reactivity of organolithium compounds is the preparation of the otherwise difficultly accessible esters of 2-pyridyl-acetic acid by the following series of reactions from α -picoline :

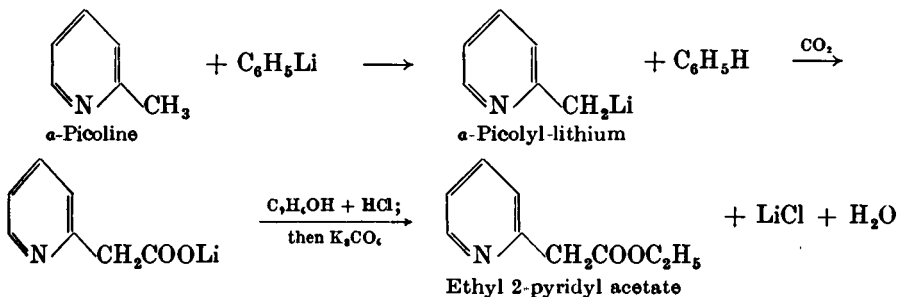

Many organic halides do not react satisfactorily with lithium to form RLi compounds or with metallic magnesium to form Grignard reagents. The desired organolithium compound can often be prepared by a halogen-metal interconversion reaction :

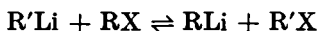

Thus *o*-hydroxyphenyl-lithium cannot be obtained from *o*-bromophenol and lithium but, under proper conditions, *o*-bromophenol reacts with *n*-butyl-lithium to give a good yield of the lithium salt of *o*-hydroxyphenyl-lithium. An interesting application is to the preparation from *m*-bromochlorobenzene and *n*-butyl-lithium of *m*-chlorobenzoic acid—an expensive chemical :

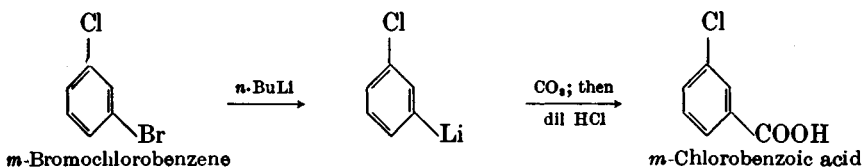

For initial experience in the use of lithium, the preparation of either *p*-toluic acid or of α -naphthoic acid may be undertaken. For the former, *p*-bromotoluene is converted into the lithium derivative and the latter carbonated with solid carbon dioxide :

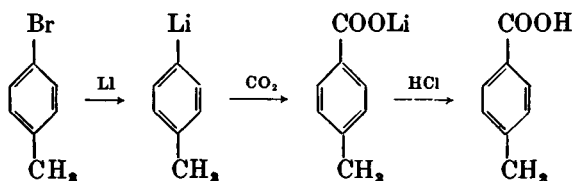

Some di-*p*-tolyl ketone is produced as a by-product, presumably by interaction of the lithium salt of the carboxylic acid with the aryl lithium :

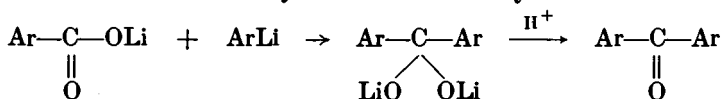

α -Naphthoic acid is similarly prepared from α -bromonaphthalene.

The reactions of organolithium compounds with carbonyl compounds, including carbon dioxide, may be interpreted as follows :

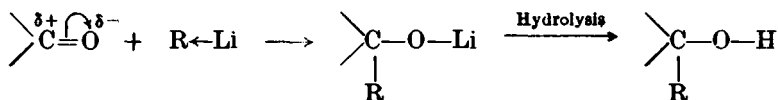

***p*-Toluic acid.** Fit a 250 ml. three-necked flask with a reflux condenser, mechanical stirrer, and a dropping funnel combined with a gas inlet tube (see Fig. II, 7, 12, *a*) (1). Place 35 ml. of anhydrous ether in the flask, displace the air by nitrogen and continue passing the nitrogen in a slow stream throughout the duration of the experiment. Introduce 1.90 g. of lithium in the form of fine shavings (2) into the ether and start the stirrer. Place a solution of 21.5 g. of *p*-bromotoluene (Section IV, 62) in 35 ml. of ether in the dropping funnel. Run in about 1 ml. of the solution into the stirred mixture. The ether in the flask soon becomes turbid ; if the ether does not reflux within 10 minutes, immerse the flask in a beaker of warm water and remove it immediately refluxing commences. Add the remainder of the *p*-bromotoluene solution dropwise or at such a rate that the solvent refluxes continuously (60–90 minutes). Stir the mixture whilst refluxing gently (warm water bath) for a further 45–60 minutes ; at the end of this period most of the lithium will have disappeared. Cool the reaction mixture in ice water, dilute it with 50–60 ml. of anhydrous ether, and cool (with stirring) to about -50° with the aid of an acetone-Dry Ice bath. Pour the contents of the flask slowly and with stirring (use a long glass rod) on to about 400 ml. of powdered Dry Ice-ether “slush” contained in a 5-litre beaker. Rinse the flask with a little of the solid carbon dioxide-ether slush and add the rinsings to the contents of the beaker. Allow the Dry Ice to evaporate (3–4 hours or preferably overnight). Add about 200 ml. of water to the contents of the beaker ; rinse the reaction flask with 10 ml. of 10 per cent. sodium hydroxide solution and pour the rinsings into the beaker. A white solid appears which dissolves upon stirring. (If most of the ether has evaporated on standing, add a further 50 ml.) Separate the two layers, extract the aqueous solution with 50 ml. of ether (to remove traces of neutral products) and combine the extract with the ether layer. Shake the combined ethereal solutions with 10 per cent. sodium hydroxide solution and add the alkaline extract to the aqueous layer. Warm the combined aqueous layers to $60-70^\circ$ (hot plate) to drive off the dissolved ether, then cool to about 5° and strongly acidify with hydrochloric acid. Collect the precipitated *p*-toluic acid by suction filtration and wash it with a little cold water. The yield of the crude acid, m.p. $174-176^\circ$, is 11.9 g. ; recrystallisation from dilute alcohol gives pure *p*-toluic acid, m.p. $176-177^\circ$.

Evaporate the dried ethereal extract; the residue, m.p. 85–90°, weighs 3.3 g. Recrystallise it from alcohol: pure di-*p*-tolyl ketone, m.p. 95°, is obtained.

Notes.

(1) Alternatively, use a wide tube with sealed-on side arm; insert the dropping funnel into the wide tube and connect the side arm to the nitrogen supply.

(2) A convenient method of preparing the lithium shavings is as follows. Place a piece of lithium weighing about 3 grams and slightly moist with paraffin oil on a dry surface (slate or tiles) and pound it with a clean hammer or 500 g. weight into a thin sheet about 0.5 mm. thick. Cut the sheet into thin strips about 2–3 mm. wide and transfer it to a beaker containing anhydrous ether. Weigh out the quantity of lithium required under dry ether or paraffin oil. Dry each strip with filter paper, cut it by means of a pair of scissors into small pieces about 1 mm. wide and allow the small pieces to fall directly into the anhydrous ether in the reaction flask. The lithium thus retains its bright lustre.

The lithium may also be pressed into wire of about 0.5 mm. diameter; a rather sturdy press is necessary. The wire may be collected directly in sodium-dried ether.

α -Naphthoic acid. Proceed as detailed for *p*-Toluic acid, using 1.50 g. of lithium and 20.7 g. of α -bromonaphthalene (Section IV,20). After carbonation, etc., acidify the alkaline aqueous extract with hydrochloric or 50 per cent. sulphuric acid, collect the precipitated α -naphthoic acid by suction filtration, wash with a little cold water, dry at 90° for 1 hour, and finally in a vacuum desiccator. The yield of crude acid, m.p. 140–150°, is 9.3 g. Recrystallise from hot toluene; the pale yellow α -naphthoic acid has m.p. 159–160°.

2-Phenylpyridine. The first stage is the *preparation of a solution of phenyl-lithium in dry ether*. Equip a 1-litre three-necked flask with a dropping funnel, a mercury-sealed mechanical stirrer, and an efficient reflux condenser; provide the last-named with a drying tube filled with calcium chloride or cotton wool (1). Flush the apparatus with dry, oxygen-free nitrogen gas. Place 7.35 g. of lithium shavings or wire (2) in the flask, and introduce a solution of 78.5 g. (52.5 ml.) of dry, redistilled bromobenzene in 250 ml. of anhydrous ether into the dropping funnel. Start the stirrer. Run in about 2 ml. of the solution; when the reaction starts, as indicated by an initial cloudiness (3), add the remainder at such a rate that the solvent refluxes gently (about 45 minutes). Finally, add 50 ml. of anhydrous ether through the dropping funnel. Continue the stirring until all or most of the lithium disappears (1–1.5 hours) (4).

Now introduce slowly, and with stirring, 79 g. of pure anhydrous pyridine (Section II,47,22) dissolved in 200 ml. of anhydrous, sulphur-free toluene: remove the ether by distillation, replace the dropping funnel by a thermometer and stir the residual suspension at 110° (internal temperature) for 8 hours. Then cool to about 40°, and add cautiously 75 ml. of water through the condenser; filter the liquids, if necessary. Separate the upper toluene layer, dry it by shaking for an hour with 20 g. of potassium hydroxide pellets, and distil slowly using a Claisen flask with fractionating side arm (Figs. II, 2A, 2–5). When the temperature reaches 150° at ordinary pressure (thus indicating the removal of most of the toluene, etc.), distil the residue under reduced pressure and collect the liquid passing over at 138–142°/12 mm. Upon redistillation 38 g. of pure 2-phenylpyridine, b.p. 140°/12 mm., is obtained.

Notes.

(1) If preferred, the apparatus depicted in Fig. II, 7, 13 may be used. This enables an oxygen-free nitrogen atmosphere to be maintained in the apparatus and leads to the best yield of phenyl-lithium.

(2) See Note 2 under *p-Toluic acid*.

(3) As pointed out in Note 1 a nitrogen atmosphere is preferred for the preparation of organolithium compounds. In the present example exclusion of oxygen is attained fairly satisfactorily by keeping the solution at the reflux point throughout; an atmosphere of ether vapour is thus maintained.

(4) The yield of phenyl-lithium generally exceeds 95 per cent. One interesting and instructive method of determination is to allow the phenyl-lithium to react with an excess of benzophenone and to weigh the triphenylcarbinol formed. It is assumed that the carbinol is formed quantitatively. A better method is to hydrolyse a 2 ml. aliquot portion of the filtered solution with distilled water and to titrate the hydrolysate with standard acid, using phenolphthalein as indicator. To obtain the filtered solution, the dropping funnel is replaced by a short L-shaped tube loosely plugged with glass wool, and the solution is decanted through this tube into a graduated funnel that has been swept out with nitrogen.

Ethyl 2-pyridylacetate. Prepare a solution of phenyl-lithium in anhydrous ether as detailed above for 2-Phenylpyridine, using 7.35 g. of lithium. Introduce 46.6 g. (48.5 ml.) of dry, redistilled α -picoline (Section II, 47, 28), with continued stirring dropwise during about 10 minutes. Stir the dark red-brown solution of picolyl-lithium for a further 30 minutes, and then pour it slowly (1) and with shaking upon about 400 g. of solid carbon dioxide (Dry Ice) contained in a 1.5 litre round-bottomed flask. Break up the lumpy residue of lithium salts before adding 375 ml. of absolute ethyl alcohol. Cool the solution in ice, and saturate it with dry hydrogen chloride. Allow the mixture to stand overnight, remove the alcohol under diminished pressure on a boiling water (or steam) bath, and dissolve the syrupy residue in 375 ml. of chloroform. Prepare a paste from 112.5 g. of potassium carbonate and 70 ml. of water, and add it slowly and with constant mechanical stirring to the chloroform solution; stir the almost boiling solution vigorously for 1 hour. Decant the chloroform solution from the inorganic salts, remove the solvent by distillation from a water bath, and distil the residue under diminished pressure from a Claisen flask with a fractionating side arm (Figs. II, 24, 2-5). α -Picoline (ca. 20 g.) passes over first, followed by ethyl 2-pyridylacetate as a pale yellow liquid at 135-137°/28 mm. or 110-112°/6 mm. The yield is 30 g.

Note.

(1) It is advisable to filter the α -picolyl-lithium solution rapidly through a thin layer of glass wool (to remove any unreacted lithium) on to the solid carbon dioxide.

***m*-Chlorobenzoic acid.** Prepare a solution of *n*-butyl-lithium in anhydrous ether as follows. In a 500 ml. three-necked flask, equipped with a reflux condenser, a mercury-sealed stirrer, and a thermometer combined with a gas inlet tube (see Fig. II, 7, 12, b), place 100 ml. of sodium-dried ether. Displace the air by oxygen-free nitrogen and maintain a slow stream of nitrogen throughout the experiment. Introduce 4.3 g. of fine lithium shavings into the reaction flask. Place a solution of 34.5 g. (26.5 ml.) of *n*-butyl bromide in 50 ml. of anhydrous ether in a dropping funnel supported by means of a grooved cork at the top of the reflux con-

denser, start the stirrer, and run in 1–2 ml. of the solution into the reaction flask cooled to about -10° (Dry Ice-acetone bath). The reaction has commenced when bright spots appear on the lithium and the reaction mixture becomes slightly cloudy. Add the remainder of the *n*-butyl bromide solution during about 30 minutes whilst the internal temperature is maintained at about -10° . Then allow the reaction mixture to warm up to $0-10^{\circ}$ during 1 hour (with stirring) in order to complete the formation of *n*-butyl-lithium (1).

Cool the solution of *n*-butyl-lithium to -35° in a Dry Ice-acetone bath and add, whilst stirring vigorously, a solution of 48 g. of *m*-chlorobromobenzene (Section IV,62) in 75 ml. of anhydrous ether. Stir for 8–10 minutes and pour the mixture with stirring on to a large excess of solid carbon dioxide in the form of a Dry Ice-ether slush contained in a 4-litre beaker. Isolate the acid as detailed above for *p*-Toluic acid and recrystallise it from hot water. The yield of *m*-chlorobenzoic acid, m.p. $150-151^{\circ}$, is 27 g.

Note.

(1) If a clear solution of *n*-butyl-lithium is required for any purpose, it may be decanted through a glass wool plug as detailed under 2-Phenylpyridine, Note 4.

VI.29. SYNTHESSES WITH ORGANOSODIUM COMPOUNDS

The formation of an organosodium compound (*p*-tolyl-sodium) is well illustrated by the interaction of sodium sand or wire with *p*-chlorotoluene in light petroleum (b.p. $40-60^{\circ}$) at about 25° , for when the reaction mixture is added to excess of solid carbon dioxide pure *p*-toluic acid is obtained directly in a yield exceeding 70 per cent. :

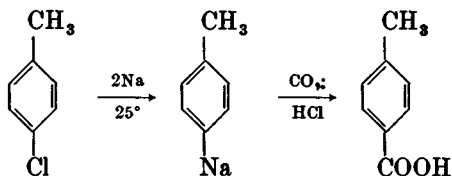

Upon prolonged standing or, more rapidly, upon refluxing for 4–18 hours, the sodium atom migrates and benzyl-sodium is formed, as is proved by the production of phenylacetic acid in good yield upon carbonation.

Two mechanisms for the formation of benzyl-sodium have been suggested. One is represented by the scheme :

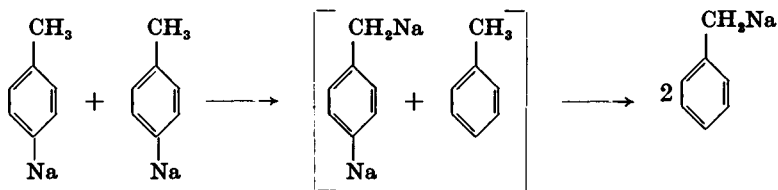

In the second, a trace of toluene (possibly formed by hydrolysis) is metalated by the *p*-tolyl-sodium to give benzyl-sodium and toluene. Since the toluene is regenerated in the reaction, a small quantity would be adequate as a sort of catalyst.

The formation of alkylbenzenes, largely free from unsaturated compounds, provides another interesting application of organosodium compounds. Thus pure *n*-butylbenzene is readily obtained in good yield from benzyl-sodium and *n*-propyl bromide. Benzyl-sodium is conveniently prepared by first forming phenyl-sodium by reaction between sodium and chlorobenzene in a toluene medium, followed by heating the toluene suspension of the phenyl-sodium at 105° for about 35 minutes :

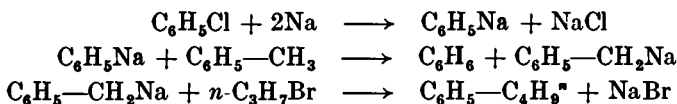

Other alkylbenzenes may be prepared similarly by using the appropriate primary or secondary alkyl bromide.

Alkylbenzenes are also obtained (but in somewhat lower yield) from phenyl-sodium and alkyl bromides. Thus ethylbenzene is produced from phenyl-sodium and ethyl bromide :

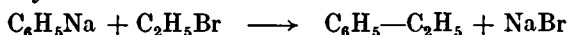

About 2–3 per cent. of diphenyl is formed in the initial preparation of phenyl-sodium and, in consequence, careful fractionation is required in the case of alkylbenzenes with a b.p. near that of diphenyl.

Pure *p*-xylene may be prepared from *p*-tolyl-sodium and methyl iodide or methyl sulphate.

***p*-Toluic acid.** Equip a dry 250 ml. three-necked flask with a reflux condenser, a mercury-sealed stirrer (1) and a thermometer and gas inlet tube (compare Fig. II, 7, 12, *b*). Introduce 50 ml. of dry light petroleum (b.p. 40–60°) and 4.6 g. of sodium wire, and pass a slow stream of nitrogen through the apparatus. Add 12.6 g. of redistilled *p*-chlorotoluene (Section IV, 61) by means of a dropping funnel supported at the top of the reflux condenser, whilst stirring vigorously, during 90 minutes: maintain the temperature at 25°. After the addition is complete, insert a calcium chloride tube into the open end of the reflux condenser, and continue the stirring for a further 2 hours at 25°. Prepare a “slush” of Dry Ice and ether (using 100–150 ml. of ether) in a 4-litre beaker and pour the reaction mixture rapidly on to the large excess of Dry Ice-ether. After 30–45 minutes, whilst some solid carbon dioxide still remains, add water cautiously to destroy the excess of sodium and to dissolve the sodium salt of the acid. Separate the aqueous layer, extract it once with 50 ml. of ether, and warm the aqueous solution on a hot plate to remove the dissolved solvent. Filter, if necessary, and acidify the aqueous solution with dilute hydrochloric acid. Collect the precipitated acid by suction filtration, wash it with a little water and dry at 100°. The yield of *p*-toluic acid, m.p. 175–176°, is 9.8 g.

Note.

(1) The mercury-sealed stirrer may be replaced by a Kyrides stirrer (Fig. II, 7, 12) formed from a P.V.C. gland and lubricated with a mixture of vaseline and light paraffin. The continuous passage of nitrogen may be dispensed with if a fairly wide tube dipping into a little mercury is connected to the top of the condenser; the latter serves to retain the nitrogen atmosphere.

***n*-Butylbenzene.** Equip a 500 ml. three-necked flask as detailed for *p*-Toluic acid and pass a slow stream of nitrogen through the apparatus. Charge the flask with 150 ml. of sodium-dried, sulphur-free toluene and

13.8 g. of sodium wire. Place 34 g. (31 ml.) of chlorobenzene (Sections IV,17 and IV,61) in a dropping funnel supported at the top of the condenser and add it dropwise through the condenser during 1 hour, with vigorous stirring, whilst maintaining the temperature inside the flask at 30–35°. The start of the reaction is indicated by the appearance of black specks on the sodium surface. (If the reaction is slow to start, it may be instantly initiated by a few drops of *n*-butyl alcohol.) Complete the formation of phenyl-sodium by stirring for 2–3 hours at 30°. Attach a calcium chloride tube to the top of the reflux condenser and reflux the mixture for 40 minutes. The reflux temperature, initially 107°, gradually falls to 103° as benzene is formed by the exchange reaction. Remove the heating bath and add 27.6 g. (20.5 ml.) of redistilled *n*-propyl bromide during 20–25 minutes at 103–105°; the reaction is strongly exothermic. Allow the reaction mixture to cool to room temperature: maintain the stirring and the slow stream of nitrogen. Add water slowly to destroy the excess of sodium. Separate the toluene layer, dry it (anhydrous magnesium sulphate), and distil it through a short, jacketed column filled with glass helices (19 cm. packed length, 14 mm. diameter; compare Fig. II, 24, 5). After removal of the toluene (up to 111°) and a small intermediate fraction (111–179°), pure *n*-butylbenzene passes over at 179.5–181°/752 mm. (23 g.). A brown residue (4 g.) remains in the flask.

Ethylbenzene. Prepare a suspension of phenyl-sodium from 23 g. of sodium wire, 200 ml. of light petroleum (b.p. 40–60°) and 56.3 g. (50.9 ml.) of chlorobenzene as described above for *p*-Toluic acid. Add 43.5 g. (30 ml.) of ethyl bromide during 30–45 minutes at 30° and stir the mixture for a further hour. Add water slowly to decompose the excess of sodium and work up the product as detailed for *n*-Butylbenzene. The yield of ethylbenzene, b.p. 135–136°, is 23 g.

***p*-Xylene.** Prepare *p*-tolyl-sodium, as described above for *p*-Toluic acid, using 76 g. of *p*-chlorotoluene and 27.5 g. of sodium wire in 250 ml. of light petroleum, b.p. 40–60°. Introduce, with vigorous stirring, a mixture of 78.5 g. (59 ml.) of dimethyl sulphate (**CAUTION**: toxic) with 30 ml. of dry benzene during 1 hour whilst maintaining the temperature at 30°. Add water to the colourless reaction mixture, separate the organic layer, and fractionate it until the vapour temperature reaches 90°. Then separate the crude xylene by steam distillation in the presence of potassium hydroxide; dry the upper layer from the steam distillate (anhydrous magnesium sulphate) and fractionate. Collect the *p*-xylene at 137–138°. The yield is 37 g.

VI,30. SYNTHESSES WITH ORGANOCADMIUM COMPOUNDS

Organocadmium compounds may be prepared by the action of anhydrous cadmium chloride upon the corresponding Grignard reagents, for example:

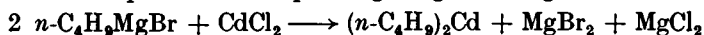

The cadmium chloride is added to a boiling ethereal solution of the Grignard reagent and the resulting mixture is stirred and heated under reflux until a negative Gilman test (compare Section III,10) is obtained, thus indicating the complete conversion of the Grignard reagent.

The main use of organocadmium compounds is for the preparation of ketones and keto-esters, and their special merit lies in the fact that they react vigorously with acid chlorides of all types but add sluggishly or not at all to multiple bonds (compare addition of Grignard reagents to carbonyl groups). Some typical syntheses are :

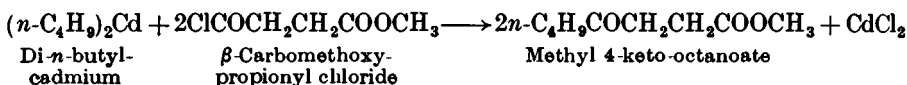
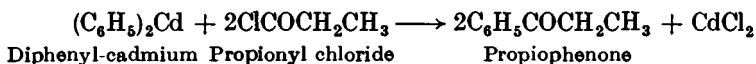
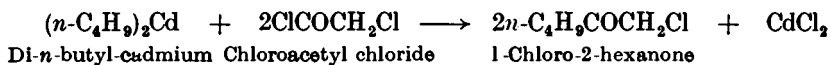

The success of the last reaction depends upon the inertness of the ester carbonyl groups towards the organocadmium compound : with its aid and the use of various ester acid chlorides, a carbon chain can be built up to any reasonable length whilst retaining a reactive functional group (the ester group) at one end of the chain.* Experimental details are given for 1-chloro-2-hexanone and propiophenone. The complete reaction (formation of ketones or keto-esters) can be carried out in one flask without isolation of intermediates, so that the preparation is really equivalent to one step.

For most purposes the use of 1.0 mol of an alkyl or aryl bromide (for the preparation of the organocadmium compound through the Grignard reagent) to 0.8 mol of the acid halide is recommended. This results in nearly equivalent molar ratios of the organocadmium compound and acid halide, since the overall yield of the former is usually about 80 per cent. It is generally advantageous to replace ether by benzene before the addition of the acid chloride: a higher reflux temperature is possible, thus reducing the time required for the reaction ; also the precipitate formed in the course of the reaction is more easily stirred in benzene than in ether.

1-Chloro-2-hexanone. Equip a 1-litre three-necked flask with a mercury-sealed Hershberg stirrer (preferably of tantalum wire) (see Fig. II, 7, 7), a reflux condenser and a 250 ml. dropping funnel (1). All apparatus must be thoroughly dry. Place 8.1 g. of dry magnesium turnings in the flask, add 60 ml. of anhydrous ether through the dropping funnel, and charge the latter with a solution of 46 g. (35.5 ml.) of *n*-butyl bromide in 110 ml. of dry ether. Start the stirrer and prepare the Grignard reagent in the usual manner (compare Sections III,18 and III,23). When the formation of the Grignard reagent is complete, cool the flask in an ice bath with stirring, remove the dropping funnel and, when cold, add 32.7 g. of anhydrous cadmium chloride (2) in portions from a small conical flask during 5-10 minutes. Replace the dropping funnel, remove the ice bath, stir for 5 minutes, and then heat the mixture under reflux with stirring for 45 minutes ; at this point a test for the presence of Grignard reagent is made (3) : continue stirring and refluxing until the test is negative. Replace the reflux condenser by a "knee tube" connected to a condenser set for distillation, distil off the ether as stirring is continued ; continue the distillation, with stirring, on a water bath until it becomes very slow and a dark viscous residue remains. At this point add 120 ml. of

* For experimental details, see *Organic Syntheses*, 28, 75 (1948) ; Cason, *J. Amer. Chem. Soc.*, 68, 2080 (1946).

anhydrous, thiophene-free benzene from the dropping funnel, and continue the distillation until a further 35 ml. of liquid has passed over. Then add 120 ml. of dry benzene and replace the reflux condenser: reflux the mixture with vigorous stirring in order to break up the cake inside the flask. Remove the heating bath, cool the mixture to about 5° in an ice bath, and add a solution of 38 g. (25.5 ml.) of chloroacetyl chloride (b.p. 105°) in 70 ml. of anhydrous pure benzene from the dropping funnel during 2-3 minutes. After completion of the addition, stir the reaction mixture and hold the temperature at 15-20° for 3 hours and then at 20-25° for a further 1.5 hours. Add excess of crushed ice (ca. 200 g.) and dilute sulphuric acid. Separate the benzene and aqueous layers; extract the aqueous phase with two 30 ml. portions of benzene. Wash the combined benzene layers successively with 70 ml. of water, 70 ml. of saturated sodium bicarbonate solution, 70 ml. of water and 35 ml. of saturated sodium chloride solution. Filter the benzene solution through a little anhydrous sodium sulphate (this separates most of the suspended water), remove the benzene by flash distillation at atmospheric pressure, and distil the residue under reduced pressure using a Claisen flask with fractionating side arm (Fig. II, 24, 5). Collect the 1-chloro-2-hexanone at 71-72°/15 mm.; the yield is 24 g.

Notes.

(1) It is best to conduct the preparation in a nitrogen atmosphere; the apparatus shown in Fig. II, 7, 13 may be used.

(2) Dry A.R. hydrated cadmium chloride to constant weight at 110°; grind finely, dry again for 2-3 hours at 110° and then place in a screw-capped bottle and keep in a desiccator over calcium chloride.

(3) Remove 0.5 ml. of the reaction mixture with a dropper pipette and add it to an equal volume of a 1 per cent. solution of Michler's ketone in dry benzene contained in a small test-tube. Shake the mixture for about 1 minute, add 1 ml. of water, followed by a few drops of a 0.2 per cent. solution of iodine in glacial acetic acid. Finally, add 1 ml. of glacial acetic acid, mix well and allow to settle. A positive test is a greenish-blue colour; a negative test is a shade of yellow. The cadmium reagent does not give the Gilman test.

Propiophenone. Prepare a solution of diphenyl-cadmium in 110 ml. of dry benzene using 4.9 g. of magnesium, 32.4 g. of bromobenzene and 19.5 g. of anhydrous cadmium chloride. Cool the solution to 10°, and add during 3 minutes a solution of 14.8 g. of propionyl chloride (b.p. 78-79°) in 30 ml. of dry benzene; use external cooling with an ice bath to prevent the temperature from rising above 40°. Stir the mixture for 2 hours at 25-35°. Work up the product as detailed above except that 5 per cent. sodium carbonate solution should replace the saturated sodium bicarbonate solution. The yield of propiophenone, b.p. 100-102°/16 mm., is 17.5 g.

VI.31. SOME ELECTROLYTIC SYNTHESSES

Hydrocarbons and di-esters, otherwise rather inaccessible in a pure state, are conveniently prepared by electrolytic (anodic) synthesis.* Thus simple coupling

* The preparations described below are based upon the work of Dr. R. P. Linstead, C.B.E., F.R.S., and co-workers; the author is indebted to Dr. Linstead for the experimental details concerning *n*-hexacosane.

at the anode is attained by electrolysis in anhydrous methanolic solution (containing a little sodium methoxide) of:—

(i) methyl hydrogen adipate to give **dimethyl sebacate** :

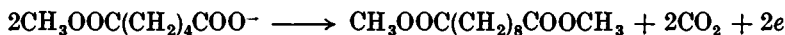

(ii) methyl hydrogen sebacate to give **dimethyl hexadecane-1 : 16-dicarboxylate** :



(iii) myristic acid (tetradecic or tetradecanoic acid) to give *n*-hexacosane :



Electrolysis, under similar conditions, of a mixture of two carboxylic acids RCOOH and $\text{R}'\text{COOH}$ leads, in addition to normal coupling products R—R and $\text{R}'\text{—R}'$, to "cross" coupling $\text{R—R}'$. If a mixture of a saturated carboxylic acid and a half-ester of an $\alpha\omega$ -dicarboxylic acid is electrolysed, there are three main products, *viz.*, a hydrocarbon (I), a mono-ester (II), and a di-ester (III) and these are readily separable by distillation. Some unsaturated ester (IV) is often present in small quantity.

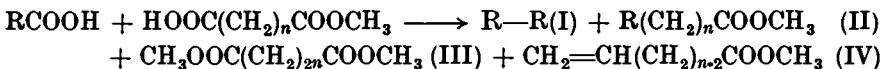

By increasing the molar proportion of the monocarboxylic acid, the yield of (II) is improved. Thus electrolysis of a mixture of decanoic acid (*n*-decoic acid; capric acid) (V) (2 mols) and methyl hydrogen adipate (VI) (1 mol) in anhydrous methanol in the presence of a little sodium methoxide gives, after hydrolysis of the esters formed, *n*-octadecane (VII), tetradecanoic or myristic acid (VIII) and sebacic acid (IX) :

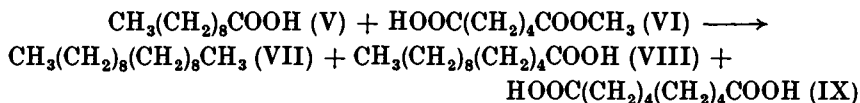

An excellent synthesis of myristic acid is thus achieved from readily accessible starting materials. An alternative synthesis of myristic acid utilises hexanoic acid (*n*-caproic acid; *n*-hexoic acid) (X) (2 mols) and methyl hydrogen sebacate (XI) (1 mol); the products, after hydrolysis, are *n*-decane (XII), myristic acid (XIII) and hexadecane-1 : 16-dicarboxylic acid (XIV) :

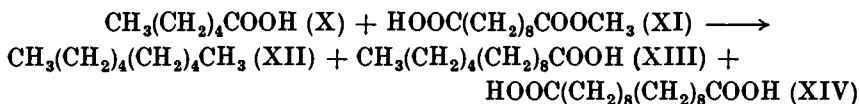

Methyl hydrogen adipate. Place 175 g. of adipic acid, 50 ml. of absolute methanol, 15 ml. of concentrated hydrochloric acid and a few fragments of "porous pot" ("boiling chips") in a 500 ml. round-bottomed flask provided with a reflux condenser. Heat cautiously at first until the mixture becomes homogeneous and then reflux for 8 hours. Transfer the mixture to a Claisen flask with fractionating side arm (Fig. II, 24, 5) fill the side arm with glass helices and arrange for heating it electrically with a heating tape, the heat input to which is controlled by a Variac transformer. Careful fractionation under reduced pressure yields dimethyl adipate, b.p. 113–114°/6 mm. (21 g.) and methyl hydrogen

adipate, b.p. 154–156°/6 mm. (66 g.). Unchanged adipic acid remains in the flask.

Methyl hydrogen sebacate. Place 115 g. of sebacic acid, 20 ml. of absolute methanol, 6 ml. of concentrated hydrochloric acid and a few fragments of "porous pot" in a 500 ml. round-bottomed flask fitted with a reflux condenser. Warm the mixture on a water bath until it becomes homogeneous and then reflux gently in an air bath (Fig. II, 5, 3) for 8 hours. Transfer the mixture to a Claisen flask with fractionating side arm (Fig. II, 24, 5) as for *Methyl hydrogen adipate* and fractionate under reduced pressure; due precautions must be taken so that the distillate does not solidify in the condenser or receiver. Collect the dimethyl sebacate at 153–154°/6 mm. (20 g., m.p. 26°) and the methyl hydrogen sebacate at 185–186°/6 mm. (46 g., m.p. 37°). The residue in the flask consists of unchanged sebacic acid.

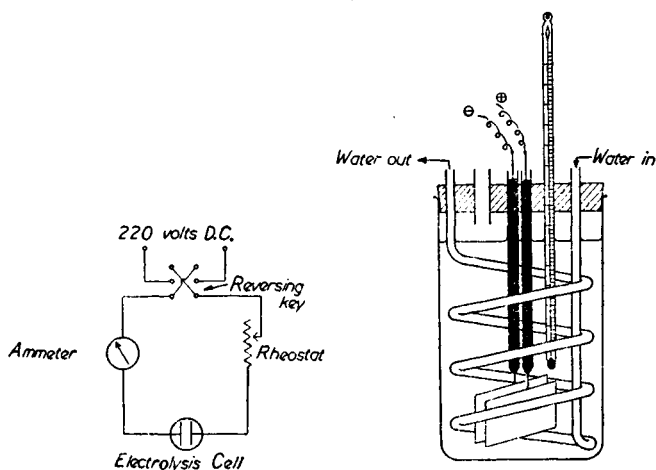

Fig. VI, 31, 1.

Electrolysis cell. This is shown in Fig. VI, 31, 1 and is almost self-explanatory. The cylindrical cell of Pyrex glass (6" long by 2 $\frac{3}{4}$ " diameter) is cooled by immersion in a cooling bath. The electrodes consist of two platinum plates (4 cm. \times 2.5 cm. \times 0.3 mm.), which are placed about 2 mm. apart. The temperature of the electrolyte is maintained at 30–35° by means of the internal cooling coil and also by immersion of the cell in ice-water. A current of 1.5–2.0 amperes is passed until the electrolyte becomes slightly alkaline, which normally takes about 20–50 per cent. longer than the calculated time on the basis of the current and the amounts of acid employed. It is advantageous to reverse the direction of the current occasionally.

Sebacic acid. Dissolve 40 g. of methyl hydrogen adipate in 100 ml. of absolute methanol to which 0.1 g. of sodium has been added. Pass a current of about 2.0 amps. until the pH of the solution is about 8 (ca. 5 hours); test with B.D.H. narrow-range indicator paper. Transfer the contents of the electrolysis cell to a 500 ml. round-bottomed flask, render neutral with a little acetic acid, and distil off the methanol on a water

bath. Dissolve the residue in 150 ml. of ether, wash with three 50 ml. portions of saturated sodium bicarbonate solution, then with water, dry over anhydrous magnesium sulphate, and distil under reduced pressure. Collect the dimethyl sebacate at $155^{\circ}/8$ mm.; it melts at 26° and the yield is 14.6–16.0 g.

Reflux 14.6 g. of the ester with a solution of 10 g. of sodium hydroxide in 125 ml. of 80 per cent. methanol for 2 hours on a water bath. Add 200 ml. of water to dissolve the solid which separates, extract with two 30 ml. portions of ether, and warm the aqueous solution on a water bath to remove dissolved ether. Acidify the ice-cold aqueous solution to litmus by the addition of concentrated hydrochloric acid. Collect the precipitated acid by suction filtration, wash it with a little cold water, and dry at 100° . The yield of sebacic acid, m.p. 133° , is 11.5 g.

Hexadecane-1 : 16-dicarboxylic acid. Dissolve 31.5 g. of methyl hydrogen sebacate in 140 ml. of absolute methanol to which 0.4 g. of sodium has been added. Electrolyse at 2.0 amps. until the pH of the electrolyte is 7.8–8.0 (3.5–4 hours). Work up as described for *Sebacic acid*. Upon distillation, an unsaturated ester passes over at 111 – $113^{\circ}/20$ mm. (4.6 g.), followed by dimethyl hexadecane-1 : 16-dicarboxylate at 212 – $219^{\circ}/4$ mm. (mainly at 214 – $215^{\circ}/4$ mm.), m.p. 56° (16.5 g.).

Reflux 6.8 g. of the dimethyl ester with a solution of 3.2 g. of sodium hydroxide in 150 ml. of 80 per cent. methanol for 2 hours on a water bath. When cold, filter off the solid and wash it with a little cold methanol. Dissolve the solid in 350 ml. of warm water, add concentrated hydrochloric acid to the solution at 60° until acidic to litmus, filter off the precipitated acid, wash with a little water and dry at 100° . The resulting hexadecane-1 : 16-dicarboxylic acid, m.p. 122° , weighs 5.3 g. Recrystallisation from absolute methanol raises the m.p. to 124.5° .

Myristic acid (from hexanoic acid and methyl hydrogen sebacate). Dissolve 23.2 g. of redistilled hexanoic acid (*n*-caproic acid), b.p. 204.5 – $205.5^{\circ}/760$ mm., and 21.6 g. of methyl hydrogen sebacate in 200 ml. of absolute methanol to which 0.13 g. of sodium has been added. Electrolyse at 2.0 amps., whilst maintaining the temperature between 30° and 40° , until the pH is about 8.0 (*ca.* 6 hours). Neutralise the contents of the electrolysis cell with a little acetic acid and distil off the methyl alcohol on a water bath. Dissolve the residue in 200 ml. of ether, wash with three 50 ml. portions of saturated sodium bicarbonate solution, once with water, dry with anhydrous magnesium sulphate, and distil with the aid of a fractionating column (see under *Methyl hydrogen adipate*). Collect the *n*-decane at $60^{\circ}/10$ mm. (3.0 g.), the methyl myristate at 158 – $160^{\circ}/10$ mm. (12.5 g.) and dimethyl hexadecane-1 : 16-dicarboxylate at 215 – $230^{\circ}/7$ mm. (1.5 g.)

Reflux a mixture of 7.3 g. of methyl myristate with a solution of 4.8 g. of sodium hydroxide in 200 ml. of 90 per cent. methanol for 2 hours, distil off the methanol on a water bath, dissolve the residue in 400 ml. of hot water, add 15 ml. of concentrated hydrochloric acid to the solution at 50° in order to precipitate the organic acid, and cool. Collect the acid by suction filtration, wash it with a little water and dry in a vacuum desiccator. The yield of myristic acid (tetradecanoic acid; tetradecoic acid), m.p. 57 – 58° , is 5.9 g.

Myristic acid (from decanoic acid and methyl hydrogen adipate). Dissolve 55.2 g. of pure decanoic acid (capric acid; decoic acid), m.p. 31–32°, and 25.6 g. of methyl hydrogen adipate in 200 ml. of absolute methanol to which 0.25 g. of sodium has been added. Electrolyse at 2.0 amps. at 25–35° until the pH of the electrolyte is 8.2 (ca. 9 hours). Neutralise the contents of the electrolytic cell with acetic acid, distil off the methanol on a water bath, dissolve the residue in about 200 ml. of ether, wash with three 50 ml. portions of saturated sodium bicarbonate solution, and remove the ether on a water bath. Treat the residue with a solution of 8.0 g. of sodium hydroxide in 200 ml. of 80 per cent. methanol, reflux for 2 hours, and distil off the methanol on a water bath. Add about 600 ml. of water to the residue to dissolve the mixture of sodium salts: extract the hydrocarbon with four 50 ml. portions of ether, and dry the combined ethereal extracts with anhydrous magnesium sulphate. After removal of the ether, 23.1 g. of almost pure *n*-octadecane, m.p. 23–24°, remains. Acidify the aqueous solution with concentrated hydrochloric acid (ca. 25 ml.), cool to 0°, filter off the mixture of acids, wash well with cold water and dry in a vacuum desiccator. The yield of the mixture of sebacic and myristic acids, m.p. 52–67°, is 26 g. Separate the mixture by extraction with six 50 ml. portions of almost boiling light petroleum, b.p. 40–60°. The residue (5.2 g.), m.p. 132°, is sebacic acid. Evaporation of the solvent gives 20 g. of myristic acid, m.p. 52–53°; the m.p. is raised slightly upon recrystallisation from methanol.

***n*-Hexacosane.** Dissolve 5.0 g. of pure myristic acid in 25 ml. of absolute methanol to which 0.1 g. of sodium has been added. Place the solution in a cylindrical cell (25 cm. long, 3 cm. diameter) provided with two platinum plate electrodes (2.5 × 2.5 cm.) set 1–2 mm. apart. Electrolyse at about 1 amp. until the electrolyte is just alkaline (pH 7.5–8). Cool the cell in an ice bath during the electrolysis. Reverse the current from time to time; this will help to dislodge the coating of insoluble by-products on the electrodes. Neutralise the cell contents by adding a few drops of glacial acetic acid, and evaporate most of the solvent under reduced pressure. Pour the residue into water and extract the crude product with ether. Wash the ethereal solution with dilute sodium hydroxide solution, dry (anhydrous magnesium sulphate) and evaporate the solvent. Recrystallise the residue from light petroleum (b.p. 40–60°). The yield of *n*-hexacosane, m.p. 57–58°, is 2.4 g.

VI,32. THE DIENE SYNTHESIS (DIELS - ALDER REACTION)

Compounds containing a double or triple bond, usually activated by additional unsaturation (carbonyl, cyano, nitro, phenyl, etc.) in the $\alpha\beta$ -position, add to the 1:4-positions of a conjugated (buta-1:3-diene) system with the formation of a six-membered ring. The ethylenic or acetylenic compound is known as the *dienophile* and the second reactant as the *diene*; the product is the *adduct*. The addition is generally termed the **Diels-Alder reaction** or the **diene synthesis**. The product in the case of an ethylenic dienophile is a *cyclohexene* and in that of an acetylenic dienophile is a *cyclohexa-1:4-diene*. The active unsaturated portion of the dienophile, or that of the diene, or those in both, may be involved in rings; the adduct is then polycyclic.

Simple examples include :—

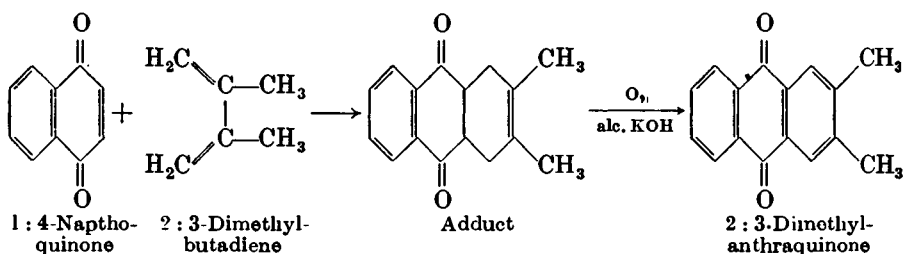
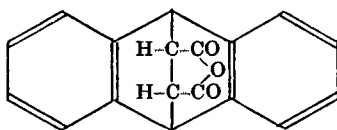
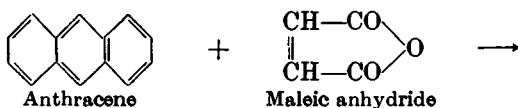
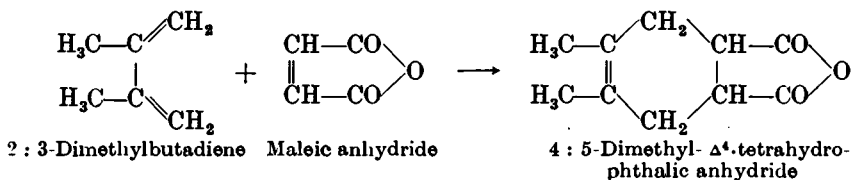

The last example is an interesting application of the diene synthesis, for the adduct upon dehydrogenation (most simply by the action of oxygen upon its solution in alcoholic potash) yields 2 : 3-dimethylantraquinone.

The *mechanism* of the diene synthesis appears to involve an electron transfer from the diene to the dienophile, *i.e.*, it is initiated by an ionic reaction. The following scheme may represent the addition of 2 : 3-dimethylbutadiene to maleic anhydride :

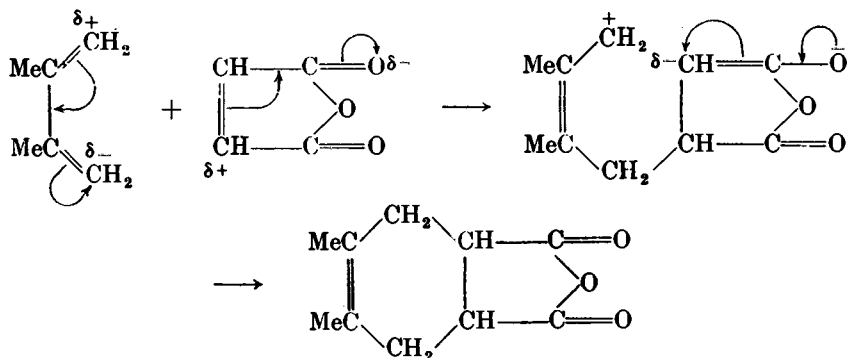

The Diels-Alder reaction is a purely *cis*-addition ; the relative positions of the substituents are retained in the adduct (compare anthracene and maleic anhydride above).*

2 : 3-Dimethylbutadiene and maleic anhydride. Add 4 g. of freshly distilled 2 : 3-dimethyl-1 : 3-butadiene (Section III,147) to 5 g. of finely powdered maleic anhydride (Section III,93) contained in a small conical flask. Reaction occurs in a few minutes (indicated by evolution of heat). Allow to stand until the mixture attains room temperature. Remove the excess of maleic anhydride by extraction with cold water until the aqueous extract no longer gives an acid reaction to Congo red paper. Dry the residual white crystals upon filter paper in the air, and then recrystallise from light petroleum (b.p. 40–60°). The yield of 4 : 5-dimethyl- Δ^4 -tetrahydrophthalic anhydride, m.p. 78–79°, is almost quantitative.

Anthracene and maleic anhydride. In a 50 ml. round-bottomed flask fitted with a reflux condenser, place 2.0 g. of pure anthracene, 1.1 g. of maleic anhydride (Section III,93) and 25 ml. of dry xylene. Boil the mixture under reflux for 20 minutes with frequent shaking during the first 10 minutes. Allow to cool somewhat, add 0.5 g. of decolourising carbon and boil for a further 5 minutes. Filter the hot solution through a small, preheated Buchner funnel. Collect the solid which separates upon cooling by suction filtration, and dry it in a vacuum desiccator containing paraffin wax shavings (to absorb traces of xylene). The yield of adduct (colourless crystals), m.p. 262–263° (decomp.), is 2.2 g. Place the product (9 : 10-dihydroanthracene-9 : 10-*endo*- α -succinic anhydride) in a well-stoppered tube, since exposure to air tends to cause hydration of the anhydride portion of the molecule.

2 : 3-Dimethylbutadiene and 1 : 4-naphthoquinone. 2 : 3-Dimethylanthraquinone. In a small round-bottomed flask, fitted with a reflux condenser, place a solution of 8 g. of freshly-distilled 2 : 3-dimethylbutadiene (Section III,147) and 8 g. of 1 : 4-naphthoquinone (Section IV,149) in 30 ml. of ethanol, and reflux for 5 hours. Keep the resulting solution in a refrigerator for 12 hours : break up the crystalline mass, filter, and wash with 5 ml. of alcohol. The yield of crude adduct, m.p. 147–149°, is 11.5 g. ; recrystallisation from methanol raises the m.p. to 150°.

For the dehydrogenation, dissolve 10 g. of the adduct in 150 ml. of 5 per cent. potassium hydroxide solution (prepared by dissolving 7.5 g. of potassium hydroxide pellets in 142.5 g. of 95 per cent. ethanol) in a 250 ml. three-necked flask equipped with a reflux condenser and gas inlet tube. Bubble a current of air through the solution for 24 hours ; the initial green colour changes to yellow and much heat is generated. Filter the yellow solid at the pump, wash successively with 50 ml. of water, 25 ml. of alcohol and 10 ml. of ether, and dry in the air. The yield of 2 : 3-dimethylanthraquinone, m.p. 209–210°, is 7.5 g.

* For a more detailed discussion, see *Organic Reactions*, 4, 10 (1948).

VI,33. SOME APPLICATIONS OF CHROMATOGRAPHIC ADSORPTION

An account of the general technique of chromatographic adsorption has been given in Section II,46. The simple applications to be described are:—

(i) Purification of anthracene (compare a similar purification of β -bromonaphthalene, Section IV,62).

(ii) Oxidation of cholesterol to cholestenone by cupric oxide (for formulae, see under *Oppenauer Oxidation* in Section VI,13) and isolation of the cholestenone chromatographically upon alumina.

(iii) Preparation of *cis*-azobenzene. Azobenzene, as normally encountered (see Section IV,86), is the *trans*-form. By exposure of a solution of *trans*-azobenzene in light petroleum, b.p. 50–60°, to ultraviolet light, some conversion into the yellow *cis*-form results; the latter can be separated by chromatographic adsorption upon alumina.

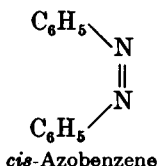
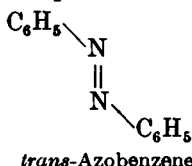

Purification of anthracene. Dissolve 0.3 g. of crude anthracene (usually yellowish in colour) in 150–200 ml. of hexane, and pass the solution through a column of activated alumina (1.5–2 × 8–10 cm.). Develop the chromatogram with 100 ml. of hexane. Examine the column in the light of an ultra-violet lamp. A narrow, deep blue fluorescent zone (due to carbazole, m.p. 238°) will be seen near the top of the column. Immediately below this there is a yellow, non-fluorescent zone, due to naphthacene (m.p. 337°). The anthracene forms a broad, blue-violet fluorescent zone in the lower part of the column. Continue the development with hexane until fluorescent material commences to pass into the filtrate. Reject the first runnings which contain soluble impurities and yield a paraffin-like substance upon evaporation. Now elute the column with hexane-benzene (1 : 1) until the yellow zone reaches the bottom region of the column. Upon concentration of the filtrate, pure anthracene, m.p. 215–216°, which is fluorescent in daylight, is obtained. The experiment may be repeated several times in order to obtain a moderate quantity of material.

Cholestenone.* Place a mixture of 1.0 g. of purified cholesterol and 0.2 g. of cupric oxide in a test-tube clamped securely at the top, add a fragment of Dry Ice in order to displace the air by carbon dioxide, and insert a plug of cotton wool in the mouth of the tube. Heat in a metal bath at 300–315° for 15 minutes and allow to cool; rotate the test-tube occasionally in order to spread the melt on the sides. Warm with a few ml. of benzene and pour the black suspension directly into the top of a previously prepared chromatographic column (1); rinse the test-tube with a little more benzene and pour the rinsings into the column. With the aid of slight suction (∇ 3–4 cm. of mercury), draw the solution into the alumina column; stir the top 0.5 cm. or so with a stout copper wire to

* The experimental details were kindly supplied by Professor D. H. R. Barton, F.R.S. and Dr. W. Rigby.

prevent blockage by the finely divided copper compounds. When all the black liquid has run in, there should be free flow without the necessity of further stirring. Continue the development with benzene until a distinctly yellowish diffuse zone approaches the bottom of the column ; some 150 ml. of liquid will have been collected. Now collect 5 ml. fractions until the yellow band is completely removed. Evaporate each of these fractions separately ; the earlier ones yield oils (giving a yellow 2 : 4-dinitrophenylhydrazone) and the later ones will crystallise upon rubbing (cholestenone). Continue the elution with a further 400 ml. of benzene ; the latter upon evaporation yields most of the cholestenone. Isolate the remaining cholestenone by continuing the elution with benzene containing 0.5 per cent. of absolute ethanol until a dark brown band approaches the bottom of the column. Collect all the crystalline residues with the aid of a little light petroleum, b.p. 40–60°, into a small flask and remove the solvent. Dissolve the residue in 40–50 ml. of hot methanol, add 0.2 g. of decolourising carbon, filter through a small bed of alumina (6 mm. × 6 mm.), concentrate to about 20 ml. and leave to crystallise overnight. The yield of cholestenone, m.p. 82°, is 0.5 g.

Note.

(1) Prepare the column for chromatography by mixing 100 g. of chromatographic alumina (Spence) with sufficient benzene to form a thin slurry when stirred. Pour this, stirring briskly, into a tube (40 cm. long and 20 mm. internal diameter) loosely plugged at its lower end with cotton wool, and rinse with a little more benzene. An evenly packed column, about 35 cm. long, should result. Allow to drain until the supernatant benzene is within 1 cm. of the alumina before adding the solution to be "chromatographed". Under no circumstances should air be permitted to enter the column.

cis-Azobenzene. Dissolve 1.0 g. of azobenzene (Section IV, 68 ; this is the *trans*-form) in 50 ml. of petroleum ether, b.p. 40–60°, in a 200 ml. beaker. Irradiate the solution for 30 minutes with ultraviolet light ; this is conveniently carried out by supporting a Hanovia fluorescent lamp, model 16, about 13 cm. above the surface of the liquid in the beaker. Meanwhile prepare a 20 cm. chromatographic column in a tube of 20 mm. bore (compare Fig. II, 46, 4) as follows. Weigh out 50 g. of activated alumina ; mix small portions with sufficient petroleum ether, b.p. 40–60°, to form a paste and introduce it into the column in *ca.* 3 mm. layers and tamp down gently with a suitable wooden pestle or other form of ramrod (compare Fig. II, 46, 6) after each addition. After the column has been formed in this way, place four well-fitting filter papers at the top of the column and pour the solution, immediately after it has been irradiated, slowly down a glass rod on to the filter papers until the column is filled with liquid ; take great care not to disturb the upper portion of the column. Develop the chromatogram with 100 ml. of petroleum ether, b.p. 40–60°. A sharp coloured band (*cis*-form), *ca.* 2 cm. in length, makes its appearance at the top of the column whilst a diffuse coloured region (containing the *trans*-form) moves down the column. The upper portion of the column should be screened from light by covering it with paper, held in position by a rubber band, during the development process ; this will largely prevent the reconversion of the *cis*- into the *trans*-form. Remove the coloured 2 cm. band from the top of the column with a glass spatula

and shake it with 150 ml. of petroleum ether, b.p. 40–60°, containing 1.5 ml. of absolute methanol; filter off the alumina, with suction, and wash the filtrate with two 15 ml. portions of water to remove the methyl alcohol present. Dry the petroleum ether extract by shaking it with *ca.* 1 g. of anhydrous sodium sulphate for 10 minutes, filter and evaporate the solvent at the laboratory temperature in a current of air. The residual coloured solid, m.p. 71.5°, is practically pure *cis*-azobenzene. Its individuality and its purity may be confirmed by ultraviolet absorption spectra measurements in chloroform solution as soon as possible after its isolation; the absorption spectrum is compared with that of the *trans*-compound (see Section A,7, Table XIII).

VI,34. RING ENLARGEMENT WITH DIAZOMETHANE CYCLOHEPTANONE FROM CYCLOHEXANONE

Reaction of cyclic ketones with diazomethane leads to ring enlargement. Thus *cyclohexanone* (I) (1 mol) and diazomethane (1 mol) give *cycloheptanone* (II) in about 60 per cent. yield together with a little epoxide (III) as by product and some *cyclooctanone* (IV) resulting from further reaction of *cycloheptanone* with diazomethane.

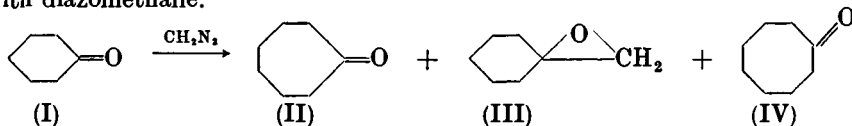

The *cycloheptanone* is readily separated by taking advantage of the experimental fact that it alone forms a solid bisulphite compound. Diazomethane is conveniently generated *in situ* from *p*-tolylsulphonylmethylnitrosamide (Section VII,20).

A possible *mechanism* of the reaction is represented by the following scheme:

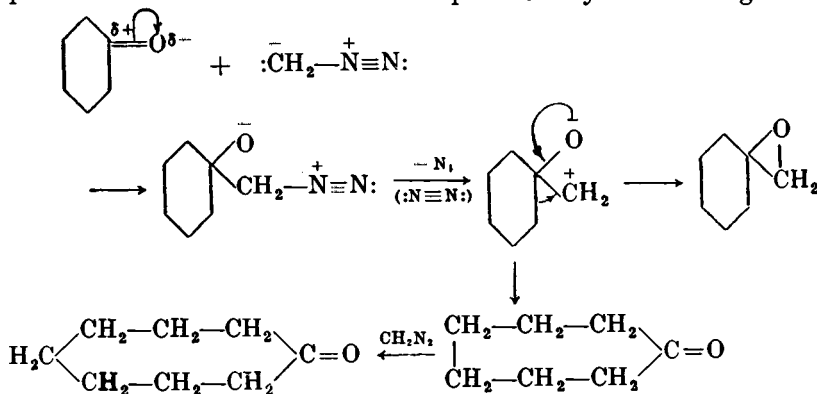

CAUTION: Carry out the preparation in an efficient fume cupboard (hood) since diazomethane is very toxic.

In a 1-litre three-necked flask equipped with a thermometer, a mechanical stirrer and a dropping funnel, place 49 g. of redistilled *cyclohexanone*, 125 g. of *p*-tolylsulphonylmethylnitrosamide, 150 ml. of 95 per cent. ethanol and 10 ml. of water. The nitrosamide is largely undissolved. Adjust the height of the stirrer so that only the upper part of the solution is stirred and the precipitate moves slightly; place the thermometer so that the bulb is in the liquid. Cool the mixture to about 0° in an ice-salt

batli. Whilst stirring gently, add a solution of 15 g. of potassium hydroxide in 50 ml. of 50 per cent. aqueous ethanol dropwise very slowly from the dropping funnel: after 0.5–1 ml. of the solution has been added, a vigorous evolution of nitrogen commences and the temperature rises. Adjust the rate of addition so that the temperature is maintained at 10–20°; the duration of the addition of alkali is about 2 hours and the nitroso compound ultimately disappears. Stir the orange-yellow solution for a further 30 minutes, and then add 2*N*-hydrochloric acid until the solution is acidic to litmus paper (*ca.* 50 ml.).

Introduce a solution of 100 g. of sodium bisulphite in 200 ml. of water and continue the stirring, preferably for 10 hours with exclusion of air. A thick precipitate separates after a few minutes. Collect the bisulphite compound by suction filtration, wash it with ether until colourless, and then decompose it in a flask with a lukewarm solution of 125 g. of sodium carbonate in 150 ml. of water. Separate the ketone layer, extract the aqueous layer with four 30 ml. portions of ether, dry the combined organic layers over anhydrous magnesium sulphate, remove the ether at atmospheric pressure, and distil the residual oil under reduced pressure from a Claisen flask with fractionating side arm (Fig. II, 24, 5). Collect the *cycloheptanone* at 64–65°/12 mm.; the yield is 23 g.

VI,35. DEHYDROGENATION OF HYDROAROMATIC COMPOUNDS

Dehydrogenation (the conversion of alicyclic or hydroaromatic compounds into their aromatic counterparts by removal of hydrogen and also, in some cases, of other atoms or groups) finds wide application in the determination of structure of natural products of complex hydroaromatic structure. Dehydrogenation is employed also for the synthesis of polycyclic hydrocarbons and their derivatives from the readily accessible synthetic hydroaromatic compounds. A very simple example is the formation of β -methyl-naphthalene from α -tetralone (which is itself prepared from benzene—see Section IV, 143):

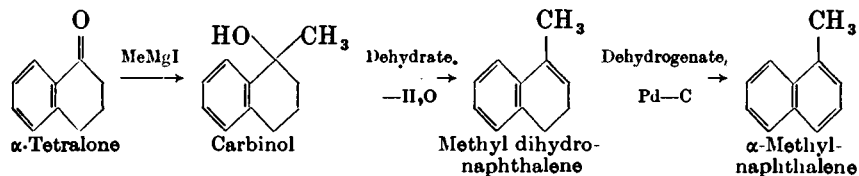

α -Tetralone may also be directly dehydrogenated to a mixture of naphthalene and α -naphthol, whilst tetralin yields naphthalene under similar conditions.

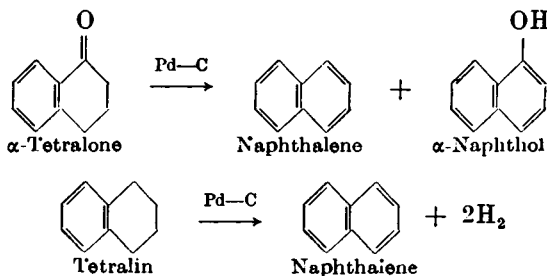

The principal dehydrogenating agents are (i) sulphur, (ii) selenium, and (iii) catalytic metals.

Sulphur. The general method is to heat the compound at 200–260° with the theoretical amount of sulphur required to bring it to the aromatic state :

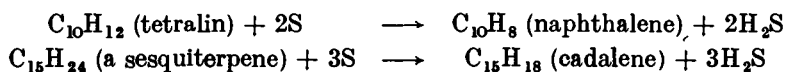

Selenium. The substance is heated with a large excess of selenium at 280–350° for 36–48 hours. Better yields (and less side reactions) are usually obtained than with sulphur, but, owing to the higher temperature, rearrangements are more likely. Oxygen-containing groups are particularly prone to elimination.

Palladium and platinum catalysts. These catalysts are generally employed with a charcoal or asbestos carrier. The dehydrogenation can be conducted in the vapour phase by distilling the compound through a tube containing the catalyst heated to 300–350°, but the liquid phase method is generally more convenient. Charcoals or asbestos are employed containing 10–30 per cent. of the metal. It has been established that the best results are obtained by conducting the process in an actively boiling medium (*e.g.*, mesitylene, b.p. 165°; *p*-cymene, b.p. 177°; naphthalene, b.p. 218°; and α -methyl-naphthalene, b.p. 242°) and to provide for the elimination of the hydrogen as it is formed (*e.g.*, by sweeping the system with a stream of carbon dioxide).

Preparation of 30 per cent. palladium or platinum catalysts (charcoal or asbestos carrier).

Purification of charcoal. Heat "Norit" charcoal on a water bath for 6 hours with 10 per cent. nitric acid, filter, wash free from acid, and dry at 100°. If the acid-washed form of "Norit" charcoal is available, it may be used directly without further purification.

Purification of asbestos. Boil Gooch asbestos (tremolite, not chrysolite variety) with concentrated nitric acid, filter, wash free from acid, and dry at 100°.

Method A. Cool a solution of the nitrate-free dichloride, prepared from or equivalent to 5.0 g. of palladium or platinum, in 50 ml. of water and 5 ml. of concentrated hydrochloric acid in a freezing mixture, and treat it with 50 ml. of formalin (40 per cent. formaldehyde) and 11 g. of the carrier (charcoal or asbestos). Stir the mixture mechanically and add a solution of 50 g. of potassium hydroxide in 50 ml. of water, keeping the temperature below 5°. When the addition is complete, raise the temperature to 60° for 15 minutes. Wash the catalyst thoroughly by decantation with water and finally with dilute acetic acid, collect on a suction filter, and wash with hot water until free from chloride or alkali. Dry at 100° and store in a desiccator.

Method B. For some purposes a slightly more active catalyst is obtained when it is prepared in more concentrated solutions. The procedure is the same as above, but the volumes of solution for 5 g. of metal are: dilute acid, 25 ml.; formaldehyde, 35 ml.; potassium hydroxide, 32 g. in 32 ml. of water.

The above catalysts contain about 30 per cent. of metal: catalyst with 10 per cent. of metal may be readily prepared by reducing the quantity of platinum or palladium chloride used.

Broadly speaking, the differences in effectiveness of palladium and platinum catalysts are very small; the choice will generally be made on the basis of availability and current price of the two metals. Charcoal is a somewhat more efficient carrier than asbestos.

DEHYDROGENATION OF TETRALIN

For small scale dehydrogenations, the apparatus shown in Fig. VI, 35, 1 may be used. Place 2.5 g. of purified tetralin (1) and 0.25 g. of palladised charcoal in the apparatus and heat to boiling for 4 hours in a slow current of dry carbon dioxide. Naphthalene, m.p. 81°, collects on the condenser in almost quantitative yield. If it is desired to follow the progress of the dehydrogenation, attach the side tube through a "sofnolite" (or soda lime) U-tube to a nitrometer filled with potassium hydroxide solution: almost the theoretical quantity of hydrogen will be collected.

If the current of inert gas is omitted, the reaction is complete after about 22 hours.

Note.

(1) Commercial tetralin may be purified as follows. Wash the technical product repeatedly with 10 per cent. of its volume of concentrated sulphuric acid, then with 10 per cent. sodium carbonate solution, followed by water, dry with anhydrous calcium sulphate, filter from the desiccant, reflux over sodium, and finally distil from sodium. Collect the pure tetralin at 206–207°.

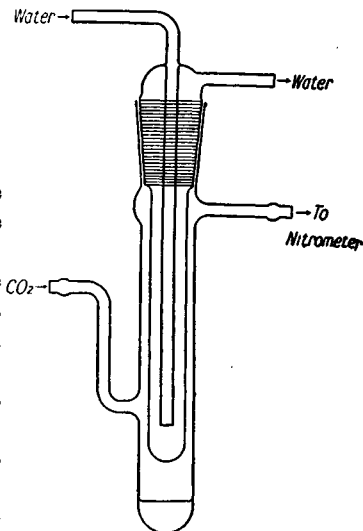
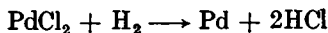

Fig. VI, 35, 1.

VI,36. PREPARATION OF PALLADIUM CATALYSTS FOR HYDROGENATION

Palladium catalysts are useful alternatives to Adams' platinum oxide catalyst described in Section III,150. The nearest equivalent to the latter is palladium chloride upon carbon and it can be stored indefinitely; the palladium salt is reduced to the metal as required:



The catalyst is also employed in the form of the finely-divided metal deposited upon activated carbon (usually containing 5 or 10 per cent. Pd); two methods of preparation are described, in one reduction is effected with alkaline formaldehyde solution and in the other with hydrogen:

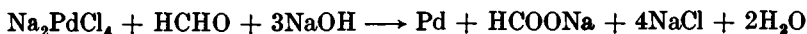

Catalysts reduced with formaldehyde contain no adsorbed hydrogen and are less pyrophoric.

Barium sulphate is frequently used as a support for the palladium (compare the Rosenmund reduction of acid chlorides, Section IV,120); barium carbonate

may also be employed when it is required to maintain the neutrality of the hydrogenation mixture. At times these are to be preferred to carbon which may, in some instances, so strongly adsorb the hydrogenation product that recovery is incomplete or difficult.

A. Palladium chloride on carbon. Prepare a solution of 4.2 g. of anhydrous palladium chloride (1) in 10 ml. of concentrated hydrochloric acid and 25 ml. of water by heating on a boiling water bath for 2 hours or until solution is complete. Add 70 ml. of water and pour all the resulting solution over 46 g. of nitric acid - washed activated carbon (2) contained in an evaporating dish or Pyrex crystallising dish. Mix the palladium chloride solution thoroughly with the carbon, and dry the mixture first on a water bath and then in an oven at 100° : stir occasionally. Powder the mass (49 g.) and store in a tightly-stoppered bottle.

This palladium chloride catalyst does not deteriorate during storage. When required for use, place the required quantity in a hydrogenation bottle (compare Fig. III, 150, 1) and reduce it with hydrogen in the solvent to be used for the hydrogenation ; a neutral solvent is to be preferred for the reduction of the palladium chloride. When no more hydrogen is absorbed by the catalyst, collect it on a sintered glass funnel, wash it with more of the solvent to remove the hydrogen chloride and then return it, with the aid of a little fresh solvent, to the reduction bottle : it is essential to keep the catalyst moist with the solvent during the washing process as it is pyrophoric. The presence of hydrogen chloride during the hydrogenation of many organic compounds is desirable (see introductory paragraph to Section III, 150) or is without effect ; in such cases, the palladium chloride on carbon is added to the solvent and hydrogen acceptor before reduction.

B. Palladium on carbon catalyst (10 per cent. Pd). Add a solution of 2.1 g. of palladium chloride (1) in 1.5 ml. of concentrated hydrochloric acid and 10 ml. of water (prepared as in A) to a solution of 44 g. of A.R. crystallised sodium acetate in 125 ml. of water contained in a 250-500 ml. reduction bottle, introduce 11.5 g. of nitric acid - washed activated carbon (2) and hydrogenate the mixture at 1.1 atmospheres until absorption ceases (2-5 hours). Collect the catalyst on a Buchner funnel, wash it with five 100 ml. portions of water, and suck as dry as possible. Dry the catalyst at room temperature (3) and then over potassium hydroxide pellets or anhydrous calcium chloride in a vacuum desiccator. Powder the catalyst (12-12.5 g.) and store it in a tightly-stoppered bottle.

C. Palladium on carbon catalyst (5 per cent. Pd). Suspend 41.5 g. of nitric acid - washed activated carbon in 600 ml. of water in a 2-litre beaker and heat to 80°. Add a solution of 4.1 g. of anhydrous palladium chloride (1) in 10 ml. of concentrated hydrochloric acid and 25 ml. of water (prepared as in A), followed by 4 ml. of 37 per cent. formaldehyde solution. Stir the suspension mechanically, render it alkaline to litmus with 30 per cent. sodium hydroxide solution and continue the stirring for a further 5 minutes. Filter off the catalyst on a Buchner funnel, wash it ten times with 125 ml. portions of water, and dry and store as in B. The yield is 46 g.

D. Palladium on barium sulphate catalyst (5 per cent. Pd). (4) Prepare a solution of 4.1 g. of anhydrous palladium chloride (1) in 10 ml. of concentrated hydrochloric acid and 25 ml. of water (as in *A*). Add all at once 60 ml. of 6*N*-sulphuric acid to a rapidly stirred, hot (80°) solution of 63.1 g. of A.R. crystallised barium hydroxide in 600 ml. of water contained in a 2-litre beaker. Add more 6*N*-sulphuric acid to render the suspension just acid to litmus (5). Introduce the palladium chloride solution and 4 ml. of 37 per cent. formaldehyde solution into the hot mechanically-stirred suspension of barium sulphate. Render the suspension slightly alkaline with 30 per cent. sodium hydroxide solution, continue the stirring for 5 minutes longer, and allow the catalyst to settle. Decant the clear supernatant liquid, replace it by water and resuspend the catalyst. Wash the catalyst by decantation 8-10 times and then collect it on a medium-porosity sintered glass funnel, wash it with five 25 ml. portions of water and suck as dry as possible. Dry the funnel and contents at 80°, powder the catalyst (48 g.), and store it in a tightly-stoppered bottle.

Notes.

(1) Alternatively, the equivalent quantity of palladium chloride dihydrate may be used.

(2) Any of the commercial forms of activated carbon (Norit, Darco, etc.) may be employed; the carbon should be heated on a steam bath with 10 per cent. nitric acid for 2-3 hours, washed free from acid with water, and dried at 100-110° before use.

(3) Heating may cause ignition of the carbon.

(4) This is an improvement on the procedure described in Section IV, 120, Note 3.

(5) Where it is advantageous to maintain the neutrality of the hydrogenation mixture, palladium upon barium carbonate catalyst is recommended: the barium hydroxide and sulphuric acid are then replaced by 46.5 g. of precipitated barium carbonate and the volume of hydrochloric acid is reduced to 4.1 ml.

VI,37. OXIDATION WITH LEAD TETRA-ACETATE *n*-BUTYL GLYOXYLATE

An interesting application of lead tetra-acetate is to the preparation of the otherwise difficultly-accessible *n*-butyl glyoxylate (II) by oxidation of di-*n*-butyl *d*-tartrate (I):

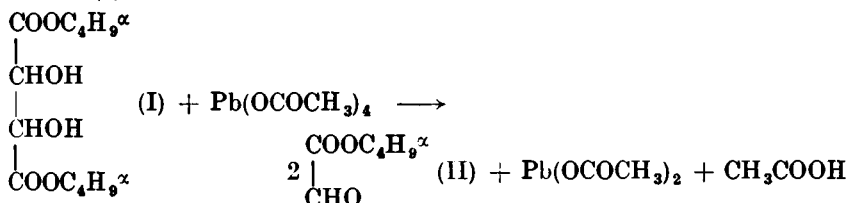

Place a mixture of 125 ml. of A.R. benzene and 32.5 g. of di-*n*-butyl *d*-tartrate (1) in a 500 ml. three-necked flask, equipped with a Hershberg stirrer (Section II,7) and a thermometer. Stir the mixture rapidly and add 58 g. of lead tetra-acetate (Section II,50,15) in small portions over a period of 20 minutes whilst maintaining the temperature below 30° by occasional cooling with cold water. Continue the stirring for a further 60 minutes. Separate the salts by suction filtration and wash with two

25 ml. portions of benzene. Remove the benzene and acetic acid from the filtrate by flash distillation (compare Section II,13) and distil the residue under diminished pressure, preferably in a slow stream of nitrogen. Collect the *n*-butyl glyoxylate (2) at 66–69°/5 mm. The yield is 26 g.

Notes.

(1) The purified commercial di-*n*-butyl *d*-tartrate, m.p. 22°, may be used. It may be prepared by using the procedure described under *iso*-propyl lactate (Section III,102). Place a mixture of 75 g. of *d*-tartaric acid, 10 g. of Zeo-Karb 225/H, 110 g. (135 ml.) of redistilled *n*-butyl alcohol and 150 ml. of sodium-dried benzene in a 1-litre three-necked flask equipped with a mercury-sealed stirrer, a double surface condenser and an automatic water separator (see Fig. III, 126, 1). Reflux the mixture with stirring for 10 hours: about 21 ml. of water collect in the water separator. Filter off the ion-exchange resin at the pump and wash it with two 30–40 ml. portions of hot benzene. Wash the combined filtrate and washings with two 75 ml. portions of saturated sodium bicarbonate solution, followed by 100 ml. of water, and dry over anhydrous magnesium sulphate. Remove the benzene by distillation under reduced pressure (water pump) and finally distil the residue. Collect the di-*n*-butyl *d*-tartrate at 150°/1.5 mm. The yield is 90 g.

(2) Store the *n*-butyl glyoxylate under nitrogen; it undergoes autoxidation in air. The product decomposes on boiling (159–161°) at atmospheric pressure.

CHAPTER VII

ORGANIC REAGENTS IN INORGANIC AND ORGANIC CHEMISTRY

VII.1. DIMETHYLGLYOXIME

Methyl ethyl ketone is allowed to react with *n*-butyl or *iso*-amyl nitrite in the presence of hydrochloric acid to yield diacetyl monoxime (nitrosomethyl ethyl ketone) :

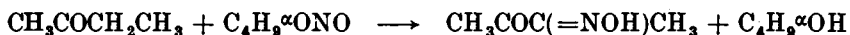

The diacetyl monoxime condenses readily with hydroxylamine hydrochloride or sulphate with the formation of dimethylglyoxime (diacetyl dioxime) :

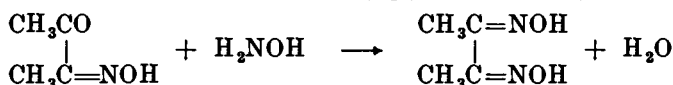

In a 500 ml. three-necked flask, supported on a water bath and provided with a dropping funnel, a mechanical stirrer and a thermometer, place 72 g. (90 ml.) of redistilled methyl ethyl ketone (dried over anhydrous magnesium or copper sulphate). Start the stirrer, introduce 3 ml. of concentrated hydrochloric acid and warm the liquid to 40°. Then add 100 g. (112 ml.) of *n*-butyl nitrite (b.p. 76–79°) or 112 g. (129 ml.) of *iso*-amyl nitrite (b.p. 96–99°) (Section III,53) slowly, maintaining the temperature at 40–50°; the mixture must be stirred vigorously. Heat is generated in the reaction so that cooling may now be required. Continue the stirring, without cooling, for 30 minutes after all the nitrite has been added. The reaction mixture now consists of a solution of diacetyl monoxime in *n*-butyl or *iso*-amyl alcohol. To remove any unused ketone, treat the mixture with a cold solution of 45 g. of sodium hydroxide in 100 ml. of water and stir for 20–30 minutes. Transfer the reaction mixture to a separatory funnel and extract the reddish-brown solution twice with 50 ml. portions of ether: the alcohol may be recovered, if desired, by fractionation of the ethereal extracts. Keep the aqueous layer; it contains the sodium salt of diacetyl monoxime. Prepare a solution of 70 g. of hydroxylamine hydrochloride {NH₂OH, HCl} or of 82 g. of hydroxylamine sulphate {(NH₂OH)₂, H₂SO₄} in about three times its weight of water, and add sodium hydroxide solution until the solution is neutral to litmus. Place the aqueous solution of the sodium salt of diacetyl monoxime in a 1 litre bolt-head flask and add the hydroxylamine solution with stirring. Heat the mixture on a water bath for about 45 minutes. Filter off the precipitated dimethylglyoxime (1) whilst the solution is still hot, wash it with hot water, and drain well. Recrystallise the crude product from about 10 times its weight of rectified spirit. The yield of pure dimethylglyoxime (a white, crystalline solid, m.p. 240°) is 55 g.

Note.

(1) If the product is coloured, dissolve it in 2*N* sodium hydroxide solution on a water bath. Filter the hot almost saturated solution, and to the hot filtrate add a

concentrated solution of ammonium chloride in excess of the amount required to precipitate all the dimethylglyoxime, *i.e.*, employ an amount greater than the equivalent of the sodium hydroxide used. Filter at once with suction, and wash with boiling water. Recrystallise the white product from rectified spirit.

VII.2. SEMICARBAZIDE HYDROCHLORIDE

Hydrazine sulphate reacts with sodium cyanate in the presence of sodium carbonate to give semicarbazide, which remains in solution :

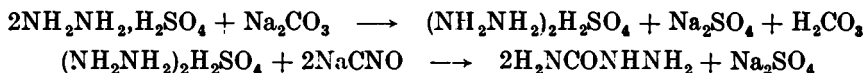

Small amounts of the insoluble hydrazodicarbonamide may also be formed :

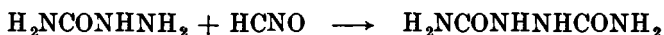

To isolate the semicarbazide hydrochloride, the filtered reaction mixture is treated with excess of acetone and the resulting acetone semicarbazone is decomposed with concentrated hydrochloric acid.

Dissolve 65 g. of hydrazine sulphate and 27 g. of anhydrous sodium carbonate in 250 ml. of boiling water contained in a 1 litre beaker, and cool the solution to 50–55°; add a solution of 34 g. of pure sodium cyanate in 500 ml. of water, and allow the mixture to stand overnight. Filter off any hydrazodicarbonamide which separates and treat the filtrate with 120 g. (152 ml.) of A.R. acetone. Shake the mixture mechanically (compare Fig. II, 7, 14) for 8 hours: filter off the crude acetone semicarbazone and dry it upon filter paper in the air (135 g.). A further 15 g. of the crude semicarbazone separates upon shaking for a further 6 hours. Upon evaporating the mother liquor to dryness on a water bath, the residue, after drying, weighs about 30 g. To obtain pure acetone semicarbazone, place all the crude product (180 g.) in a large modified Soxhlet apparatus (Figs. III, 40, 1–2), the lower end of which is filled with glass wool, and extract during 6 hours with 200 ml. of absolute alcohol. Allow the alcoholic extract to cool, filter off the acetone semicarbazone and dry: the yield is 50 g., m.p. 186°. Concentrate the filtrate to half the original volume and add excess of ether: a further 8 g. of pure acetone semicarbazone is recovered.

To decompose the acetone semicarbazone, warm 58 g. with 50 ml. of concentrated hydrochloric acid until it *just* dissolves. Cool in ice; the semicarbazide hydrochloride separates as a thick crystalline mass. Filter at the pump through a sintered glass funnel, and wash with a small quantity of alcohol and then with ether: dry in the air. The yield of pure semicarbazide hydrochloride, m.p. 173° (decomp.) is 35 g. A further quantity of product may be obtained either by saturating the mother liquor with hydrogen chloride or by treating it with twice its volume of alcohol and then with ether.

VII.3. DIPHENYLCARBAZIDE

Diphenylcarbazide is prepared by heating a mixture of phenylhydrazine and urea at 155°:

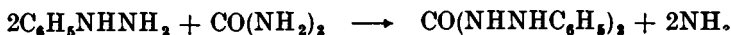

In a 500 ml. Pyrex round-bottomed flask, provided with a reflux condenser, place a mixture of 40 g. of freshly-distilled phenylhydrazine (Section IV,89) and 14 g. of urea (previously dried for 3 hours at 100°). Immerse the flask in an oil bath at 155°. After about 10 minutes the urea commences to dissolve accompanied by foaming due to evolution of ammonia: the gas evolution slackens after about 1 hour. Remove the flask from the oil bath after 135 minutes, allow it to cool for 3 minutes, and then add 250 ml. of rectified spirit to the hot golden-yellow oil; some diphenylcarbazide will crystallise out. Heat under reflux for about 15 minutes to dissolve the diphenylcarbazide, filter through a hot water funnel or a pre-heated Buchner funnel, and cool the alcoholic solution rapidly in a bath of ice and salt. After 30 minutes, filter the white crystals at the pump, drain well, and wash twice with a little ether. Dry upon filter paper in the air. The yield of diphenylcarbazide, m.p. 171°, is 34 g. A further 7 g. may be obtained by concentrating the filtrate under reduced pressure. The compound may be recrystallised from alcohol or from glacial acetic acid.

VII.4. DIPHENYLCARBAZONE

Oxidation of diphenylcarbazide (Section VII,3) with hydrogen peroxide in the presence of alcoholic potassium hydroxide affords diphenylcarbazone:



Place 24 g. of diphenylcarbazide and 200 ml. of rectified spirit in a 1 litre bolt-head flask equipped with a mechanical stirrer. Heat the solution until the solid dissolves, and to the hot vigorously stirred solution add 20 g. of potassium hydroxide pellets in one lot, followed by 20 ml. of "10-volume" hydrogen peroxide. Vigorous stirring is essential to prevent the blood-red solution foaming over. The potassium salt of the carbazone slowly separates. Allow the mixture to stand for 5 minutes and then add, with stirring, 2*N* sulphuric acid until the resulting orange-coloured suspension is acid to litmus (about 250 ml. are required). Transfer the suspension to a 3 litre beaker, and add 1500 ml. of water to dissolve the potassium sulphate. Cool, filter the orange diphenylcarbazone at the pump, wash well with water, and dry at about 50°. The yield of crude product, m.p. 150° (decomp.), is 17 g. Recrystallise from about 75 ml. of rectified spirit: 12 g. of pure diphenylcarbazone (orange crystals, m.p. 156–158° with decomposition) are obtained.

VII.5. DITHIZONE (DIPHENYLTHIOCARBAZONE)

Phenylhydrazine condenses with carbon disulphide to yield the phenylhydrazine salt of β -phenyldithiocarbamic acid (I), which on heating at 96–98° until the first evolution of ammonia is detectable affords diphenylthiocarbazide (II):

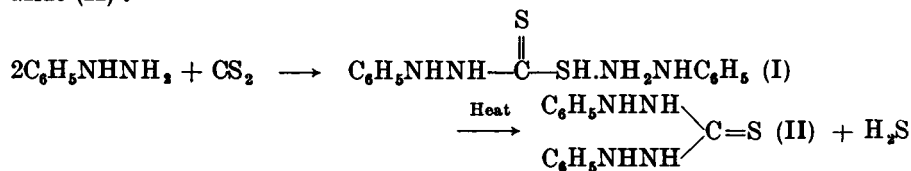

Upon heating diphenylthiocarbazide with methyl alcoholic potassium hydroxide dithizone (or diphenylthiocarbazono) (III) is produced :

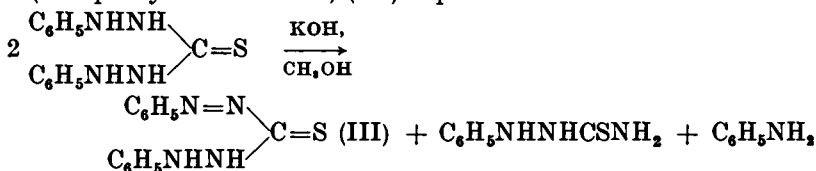

Equip a 500 ml. three-necked flask with a dropping funnel, a mechanical stirrer and a reflux condenser. Place a solution of 72 g. (65 ml.) of redistilled phenylhydrazine (Section IV,89) (*CAUTION* : poisonous) in 300 ml. of ether in the flask, stir vigorously, and add 33 g. (26 ml.) of A.R. carbon disulphide slowly during about 30 minutes. A precipitate is formed immediately upon the addition of the carbon disulphide, the mixture becomes warm and the temperature soon approaches the boiling point; maintain the temperature just below the b.p. by cooling with ice water if necessary. When the addition is complete, stir for a further 30 minutes, then filter the precipitate at the pump, wash it with about 25 ml. of ether, and spread it upon filter paper for 20 minutes to permit of the evaporation of the ether. The yield of the salt (I) is 92 g.

Transfer the salt to a 600 ml. beaker or 500 ml. wide-mouthed conical flask and heat on a boiling water bath (temperature 96–99°) with continuous stirring by hand using a heavy glass rod flattened at the bottom. After about 10 minutes, the substance softens and begins to decompose with the evolution of hydrogen sulphide; after 20–30 minutes ammonia is evolved. When the ammonia is first detected by its odour, immediately remove the vessel containing the reaction mixture (green or brown in colour) from the water bath to a bath of cold water for 1 minute, and then immerse it in finely-crushed ice. (Unless the mixture is immediately cooled after removal from the water bath, the product may decompose violently after 10–15 minutes.) Then add 75 ml. of alcohol and warm gently to loosen the mass; stir until the precipitate becomes granular. Allow to stand for 1 hour, filter at the pump and wash with 25 ml. of alcohol. The yield of crude, white diphenylthiocarbazide (II) is 60 g.

Dissolve 30 g. of potassium hydroxide pellets in 300 ml. of methyl alcohol in a 500 ml. round-bottomed flask, add the crude diphenylthiocarbazide, and fit a reflux condenser. Immerse the flask in a boiling water bath, and from the moment that the solution commences to boil, reflux the mixture for exactly 5 minutes: if the refluxing is prolonged beyond this period, the yield of product is decreased. Cool the resulting solution in ice water and filter by gravity (glass wool). Treat the red filtrate with ice-cold *N* sulphuric acid, stirring vigorously with a mechanical stirrer, until the solution is just acid to Congo red paper (about 500 ml. are required: at the end point the mother liquor is colourless). Filter the blue-black precipitate at the pump and wash it with 25 ml. of cold water. (Take care in handling the precipitate or suspensions of it since it dyes the skin black and other materials pink; if any of it is spilled or splashed, remove it at once since the compound dries to a light fine powder which is readily scattered.) Dissolve the crude dithizone in 250 ml. of 5 per cent. sodium hydroxide solution, filter with suction, cool the filtrate in ice and

immediately acidify it with ice-cold *N* sulphuric acid until it is just acid to Congo red paper (about 325 ml. are required). Filter the precipitate at the pump; transfer it to a 1 litre beaker and stir with about 900 ml. of water. Filter the mixture and repeat the washing process until the washings are free from sulphate. Finally suck the precipitate as dry as possible on the Buchner funnel, and dry upon clock glasses in the oven at 40°. The yield of dithizone is 75 g. The pure compound is completely soluble in chloroform and decomposes sharply at a temperature between 165° and 169°.

VII.6. CUPFERRON

Cupferron, the ammonium salt of the *N*-nitroso derivative of phenylhydroxylamine, is prepared by passing ammonia gas into an ethereal solution of phenylhydroxylamine and *n*-butyl nitrite:

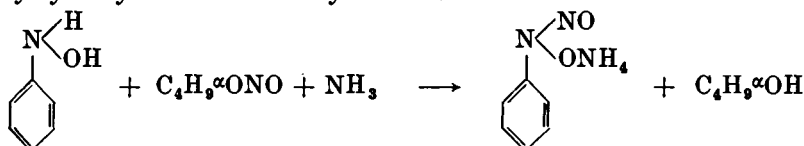

It is used in quantitative analysis as a reagent for copper and iron.

Weigh the moist phenylhydroxylamine obtained from 100 g. of nitrobenzene by the procedure described in Section IV,83 and dissolve it in 450 ml. of ether; weigh the ether-insoluble material (water and sodium chloride). The difference between the two weighings is the weight of phenylhydroxylamine in solution. Filter the ether solution through a dry fluted filter paper into a 500 ml. bolt-head flask, which is fitted with a mechanical stirrer and is immersed in an ice-salt bath. When the temperature has fallen to 0°, pass a rapid stream of dry ammonia from a cylinder into the solution. After 15 minutes, add the theoretical quantity of freshly-distilled *n*-butyl nitrite (Section III,53) (9.5 g. of Bu^nNO_2 for every 10 g. of $\text{C}_6\text{H}_5\text{NHOH}$) slowly through a dropping funnel whilst passing a rapid stream of ammonia into the solution; it is essential that the ammonia is always present in excess. Maintain the temperature of the reaction mixture below 10°. After the *n*-butyl nitrite has been added, stir the reaction mixture for an additional 10 minutes to complete the reaction. Filter off the cupferron and wash it several times with small volumes of ether. Spread the product upon sheets of filter paper until the ether has volatilised. Store it in tightly-stoppered bottles containing a little ammonium carbonate in a filter paper bag or thimble. The yield is about 85 per cent. of the theoretical based upon the weight of phenylhydroxylamine used.

VII.7. SALICYLALDOXIME

This substance is readily obtained by the interaction of salicylaldehyde with hydroxylamine hydrochloride in the presence of alkali:

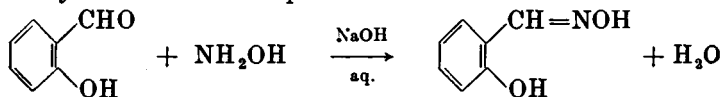

The compound is employed as a reagent for copper and nickel.

Method 1. Dissolve 25.0 g. of salicylaldehyde (Section IV,122) in 215 ml. of 2*N* sodium hydroxide solution, add 12.05 g. of hydroxylamine hydrochloride, and warm the mixture for 30 minutes on a water bath. Acidify with acetic acid and cool in ice; the salicylaldoxime separates as a congealed oil. Recrystallise from chloroform - light petroleum (b.p. 40–60°). The yield of salicylaldoxime (colourless crystals, m.p. 57°) is 5 g.

Method 2. Dissolve 20.0 g. of salicylaldehyde in 30 ml. of rectified spirit, add a solution of 15 g. of hydroxylamine hydrochloride in 10 ml. of water, and render the mixture just alkaline with 10 per cent. sodium carbonate solution whilst cooling in ice. Allow to stand overnight. Acidify with acetic acid, distil off the alcohol under reduced pressure (water pump), dilute with twice the volume of water, and extract with two 50 ml. portions of ether. Dry the ethereal extract with anhydrous sodium or magnesium sulphate, distil off most of the ether, and allow the residue to crystallise. Recrystallise from chloroform - light petroleum (b.p. 40–60°). The yield of salicylaldoxime, m.p. 57°, is 12 g.

VII,8.

 α -BENZOINOXIME

Benzoin condenses with hydroxylamine hydrochloride in the presence of alkali to give α -benzoinoxime ("cupron") as the main product:

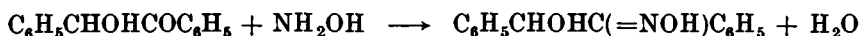

In a 250 ml. bolt-head flask, fitted with a reflux condenser, place a mixture of 10 g. of benzoin (Section IV,125) and 20 g. (25 ml.) of rectified spirit together with an aqueous solution of 8.0 g. of hydroxylamine hydrochloride which has previously been neutralised with 4.4 g. of sodium hydroxide. Reflux for 60 minutes. Add water to precipitate the benzoinoxime, and cool in an ice bath. Filter the solid with suction at the pump, wash it with water, and recrystallise from dilute alcohol. Alternatively, the dry solid may be recrystallised from ether. The yield of pure α -benzoinoxime, m.p. 151°, is 5 g.

VII,9.

 α -NITROSO- β -NAPHTHOL

Treatment of a solution of sodium nitrite and the sodium salt of β -naphthol with sulphuric acid gives an excellent yield of α -nitroso- β -naphthol:

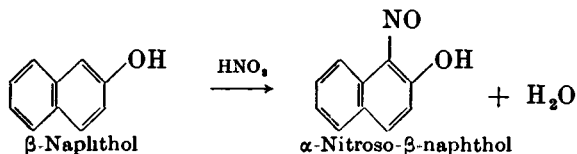

Dissolve 100 g. of β -naphthol (Section IV,102) in a warm solution of 28 g. of sodium hydroxide in 1200 ml. of water contained in a 2.5 litre round-bottomed or bolt-head flask fitted with a mechanical stirrer. Cool the solution to 0° in a bath of ice and salt, and add 50 g. of powdered sodium nitrite. Start the stirrer and add, by means of a separatory funnel supported above the flask, 220 g. (166.5 ml.) of sulphuric acid (sp. gr. 1.32) at such a rate that the whole is added during 90 minutes

and the temperature is kept at 0° : add crushed ice (about 200 g. in all) from time to time in order to maintain the temperature at 0° . The solution should react acid to Congo red paper after all the sulphuric acid has been introduced. Stir the mixture for an additional hour; keep the temperature at 0° . Filter off the α -nitroso- β -naphthol at the pump and wash it thoroughly with water. Dry the pale yellow product upon filter paper in the air for four days; the colour changes to dark brown and the α -nitroso- β -naphthol, m.p. 97° , weighs 130 g. It contains about 10 per cent. of its weight of moisture, but is otherwise almost pure. The moisture may be removed by leaving the air-dried compound in a desiccator for 24 hours; it then weighs 115 g. and melts at 106° .

If α -nitroso- β -naphthol is required in the crystalline condition, recrystallise it from light petroleum, b.p. 60 – 80° (7.5 ml. per gram); the recovery is almost quantitative, m.p. 106° .

VII,10. AMMONIUM SALT OF AURIN TRICARBOXYLIC ACID ("ALUMINON")

Formaldehyde condenses with salicylic acid in the presence of nitrite-containing sulphuric acid to give aurin tricarboxylic acid; this is converted by ammonia solution into the ammonium salt, which is employed as a reagent for aluminium ("aluminon"):

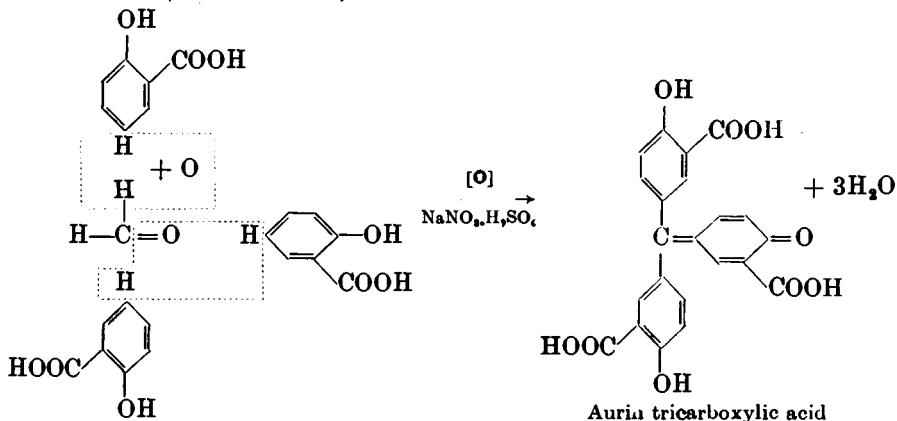

Equip a 1 litre bolt-head flask, immersed in an ice bath, with a mechanical stirrer. Place 70 ml. of concentrated sulphuric acid in the flask and add 10 g. of solid sodium nitrite in small portions with vigorous stirring at such a rate that only a very small amount of oxides of nitrogen are evolved. Then introduce, during 15 minutes, 20 g. of powdered salicylic acid. Continue the stirring at 20° until all the solid dissolves: a homogeneous, light red to brown, very viscid solution is obtained. Cool to 0° in a bath of ice and salt, add 5 ml. of formalin (35–40 per cent. formaldehyde) slowly and with very vigorous stirring and at such a rate that the temperature does not rise above 5 – 10° . The reaction is complete a few minutes after all the formalin has been introduced. Stir vigorously and add about 100 g. of finely-crushed ice, followed by 500 ml. of ice water; if frothing occurs, add a few drops of ether. Stop the stirring when the

aurin tricarboxylic acid has been disintegrated into small pieces, wash the solid several times with cold water by decantation, and then filter at the pump. Whilst the solid is still on the filter paper in the Buchner funnel, dissolve it in dilute ammonia solution (1 volume of concentrated ammonia solution to 1 volume of water). Evaporate the filtrate to dryness on a water bath. The resulting ammonium salt of aurin tricarboxylic acid (a pale yellowish-brown, glassy solid) weighs 21 g.

VII,11. *p*-NITROBENZENE-AZO- α -NAPHTHOL

p-Nitrobenzenediazonium chloride couples with an alkaline solution of α -naphthol to give *p*-nitrobenzene-azo- α -naphthol :

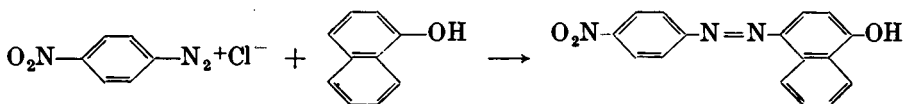

The substance is employed under the name of "Magneson II" as a test for magnesium.

Dissolve 5.0 g. of *p*-nitroaniline (Section IV,51) in a warm mixture of 13 ml. of concentrated hydrochloric acid and 13 ml. of water contained in a 250 ml. beaker. Place the beaker in an ice-salt bath and cool to 0–5° whilst stirring vigorously; *p*-nitroaniline hydrochloride will separate in a finely-divided crystalline form. Add a cold solution of 3.7 g. of sodium nitrite in 8 ml. of water slowly and with stirring to an end point with potassium iodide - starch paper: do not allow the temperature of the solution to rise above 8°. Dissolve 5.2 g. of α -naphthol in a solution of 7 g. of sodium hydroxide in 25 ml. of water, cool in ice and add the diazotised solution slowly and with stirring. Then add concentrated hydrochloric acid slowly and with vigorous stirring to the cold mixture until it is strongly acid to Congo red paper. The colour will change from violet to dark red-brown. Filter with *gentle suction*, wash with water until free from acid, and dry upon filter paper in the air. The yield is 21 g.

p-Nitrobenzene-azo-resorcinol ("Magneson I") may be similarly prepared by substituting resorcinol for α -naphthol; it may be recrystallised from methyl alcohol and melts at 199–200°.

VII,12. *p*-BROMOPHENACYL BROMIDE

This substance is conveniently obtained by treating *p*-bromoacetophenone (Section IV,138) with the calculated quantity of bromine dissolved in glacial acetic acid :

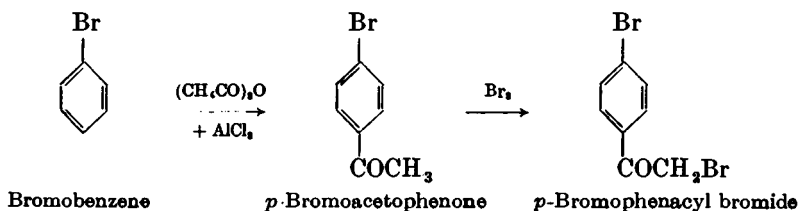

Place a solution of 50 g. of *p*-bromoacetophenone (Section IV,138) in 100 ml. of glacial acetic acid in a 500 ml. flask. Add very slowly (about 30 minutes) from a dropping funnel 40 g. (12.5 ml.) of bromine: shake the mixture vigorously during the addition and keep the temperature below 20°. *p*-Bromophenacyl bromide commences to separate as needles after about half of the bromine has been introduced. When the addition is complete, cool the mixture in ice water, filter the crude product at the pump, and wash it with 50 per cent. alcohol until colourless (about 100 ml. are required). Recrystallise from rectified (or methylated) spirit (*ca.* 400 ml.). The yield of pure *p*-bromophenacyl bromide (colourless needles, m.p. 109°) is 50 g.

VII,13.

***p*-NITROBENZYL BROMIDE**

Bromination of *p*-nitrotoluene yields *p*-nitrobenzyl bromide:

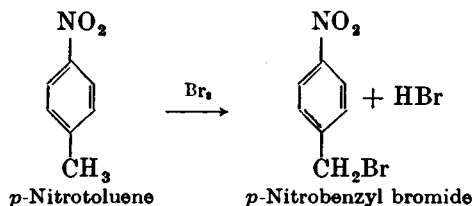

Place 150 g. of *p*-nitrotoluene, m.p. 51–52°, in a 500 ml. three-necked flask, fitted with a reflux condenser, a liquid-sealed mechanical stirrer, and a separatory funnel with stem reaching nearly to the bottom of the flask. Attach a gas absorption trap (Fig. II, 8, 1, c) to the top of the condenser. Heat the flask in an oil bath at 145–150° and add 184 g. (59 ml.) of bromine during 2 hours (1). Continue the stirring for an additional 10 minutes after all the bromine has been added. Pour the contents of the flask whilst still liquid (**CAUTION**) (2) into a 2.5 litre round-bottomed flask containing 2 litres of hot light petroleum, b.p. 80–100°, and 8 g. of decolourising carbon. Attach a reflux condenser to the flask, heat it on an electric hot plate until the material dissolves, boil for 10 minutes, and filter rapidly through a pre-heated Buchner funnel. Cool the filtrate to 20°, filter the crystals with suction, press well and wash with two 25 ml. portions of cold light petroleum. The crude *p*-nitrobenzyl bromide, m.p. 95–97° (150 g.) is sufficiently pure for many purposes. Purify by dissolving in 1500–1700 ml. of light petroleum, b.p. 80–100°, boil with 8 g. of decolourising carbon, and filter through a pre-heated Buchner or sintered glass funnel. Cool the filtrate in ice, filter at the pump, drain well, and wash with two 15 ml. portions of cold light petroleum. The yield of pure *p*-nitrobenzyl bromide (pale yellow crystals, m.p. 98–99°) is 135 g.

Notes.

(1) Improved yields may be obtained by exposing the flask to the light of two 300-watt tungsten lamps during the bromination.

(2) Care must be taken in manipulating the lachrymatory solutions of *p*-nitrobenzyl bromide. If the substance should come into contact with the skin, bathe the affected part with alcohol.

VII,14. *p*-PHENYLPHENACYL BROMIDE

p-Phenylphenacyl bromide may be prepared from diphenyl by the following series of reactions :—

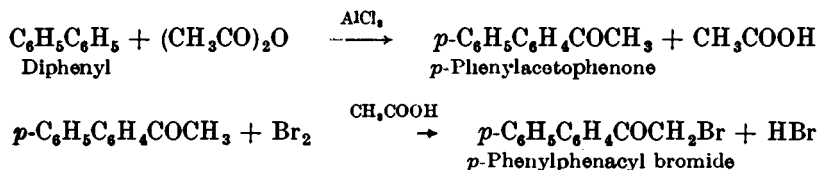

***p*-Phenylacetophenone.** In a 1 litre three-necked flask, provided with a dropping funnel, a mechanical stirrer and a reflux condenser, place 60 g. of diphenyl, 118 g. of finely-powdered anhydrous aluminium chloride and 350 ml. of anhydrous carbon disulphide. Charge the dropping funnel with 42.5 g. (40 ml.) of pure acetic anhydride and close the mouth of the funnel with a calcium chloride or cotton wool guard tube. Heat the mixture on a water bath until gentle refluxing commences, and add the acetic anhydride during 1 hour; the addition product makes its appearance as a curdy mass when about three-quarters of the anhydride has been added. Reflux the reaction mixture gently for a further hour. Allow to cool and pour the reaction product slowly and with stirring on to crushed ice to which hydrochloric acid has been added. Filter the precipitated *p*-phenylacetophenone on a Buchner funnel (1), wash repeatedly with water until free from acid, dry and distil under reduced pressure. There is usually a small fraction of low boiling point; the main product passes over at 196–210°/18 mm. and solidifies on cooling. The yield of crude *p*-phenylacetophenone, m.p. 118°, is 66 g. Upon recrystallisation from rectified spirit, the m.p. is raised to 120–121°; the recovery is about 80 per cent.

***p*-Phenylphenacyl bromide.** Suspend 36 g. of *p*-phenylacetophenone in 200 ml. of glacial acetic acid in a 500 ml. flask, warm gently on a water bath until a clear solution results, then cool as far as possible without the formation of crystals. To this solution add 29.5 (9.5 ml.) of bromine; do not allow the temperature to rise above 45° during the addition. The brominated product separates from the solution when about three-quarters of the bromine has been added. After 2 hours, cool the flask in a bath of ice and salt, filter the product, wash with a little cold glacial acetic acid, followed by small volumes of water until all the acid has been removed. The yield of crude material, m.p. 124.5–125.5°, is 42 g. Recrystallise from hot rectified spirit (600–700 ml.) and add a little decolourising carbon to remove the colour: pure, colourless *p*-phenylphenacyl bromide, m.p. 125.5°, is obtained.

Note.

(1) A further quantity of ketone may be isolated by evaporating the solvent from the carbon disulphide layer.

VII,15. 5 : 5-DIMETHYL-1 : 3-CYCLOHEXANEDIONE
(DIMETHYLDIHYDRORESORCINOL)

Mesityl oxide (Section III,79) (I) condenses with ethyl malonate in the presence of sodium ethoxide to give the sodium derivative of (II); this upon hydrolysis with aqueous potassium hydroxide, followed by acidification, gives the cyclic diketone 5 : 5-dimethyl-1 : 3-cyclohexanedione (III), of which the enolic form is 5 : 5-dimethyldihydroresorcinol (IV) :

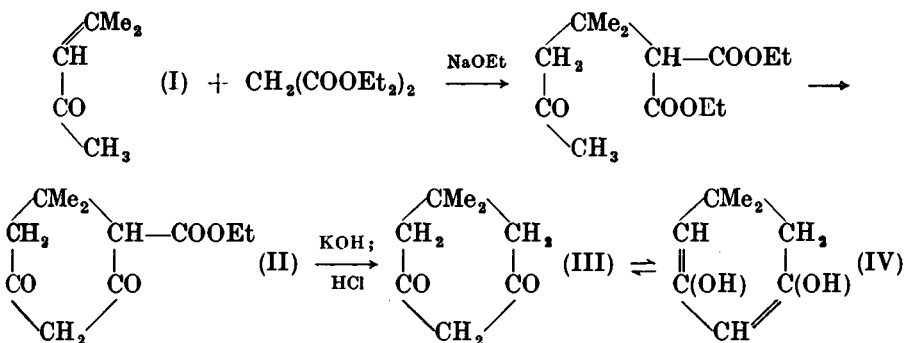

Equip a dry 1 litre three-necked flask with a dropping funnel, a mercury-sealed stirrer, and an efficient double surface condenser. Place 11.5 g. of sodium in the flask, cool in an ice bath, and add 200 ml. of absolute ethyl alcohol in one portion. When the initial vigorous reaction has subsided, remove the ice bath and allow the reaction to proceed until all the sodium has reacted: warming on a water bath is sometimes necessary to dissolve the last traces of sodium. Place a calcium chloride (or cotton wool) guard tube at the top of the condenser. Introduce 85 g. of ethyl malonate (Section III,153) and then add through the dropping funnel 50 g. of freshly-distilled mesityl oxide (Section III,79) slowly. Reflux the mixture with stirring for 2 hours, then add a solution of 62.5 g. of potassium hydroxide in 300 ml. of water, and reflux again on a water bath with stirring for 6 hours. Acidify the reaction mixture (to litmus) while still hot with dilute hydrochloric acid (1 : 2 by volume): about 275 ml. are required. Fit the flask with a condenser for distillation, and distil off as much alcohol as possible by heating with stirring on a water bath. Allow the residue in the flask to cool somewhat, add 8 g. of decolourising carbon slowly, boil for 10 minutes and filter; repeat the treatment with decolourising carbon. Neutralise the residue to litmus by the addition of dilute hydrochloric acid (about 75 ml.) and boil again with 8 g. of decolourising charcoal. Filter and render the hot yellow filtrate distinctly acid to methyl orange with dilute hydrochloric acid (25-50 ml.), boil for a few minutes, and allow to cool whereupon the dimedone crystallises out. Filter at the pump, wash with ice-cold water, and dry in the air. The yield of dimethyldihydroresorcinol, m.p. 147-148°, is 60 g. Recrystallisation from acetone (about 8 ml. per gram) raises the m.p. to 148-149°, but this is generally unnecessary.

VII,16.

XANTHHYDROL

Phenyl salicylate upon heating alone yields xanthone; the latter is reduced by sodium amalgam to xanthhydrol:

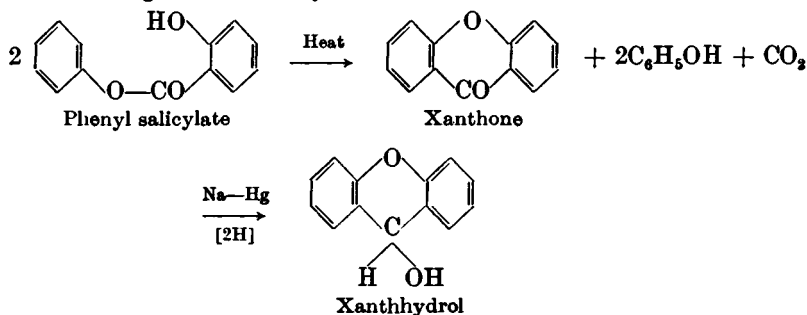

The substance is employed for the determination of urea and for the characterisation of amides (compare Section III,110).

Xanthone. Secure a 500 ml. Pyrex distilling flask with a side arm 20–25 cm. long and at least 10 mm. in diameter. Place 250 g. of phenyl salicylate in the flask and fit it with two thermometers, one extending just below the side arm and the other to the bottom of the flask. Use a conical flask as a receiver. Heat the flask on an asbestos-centred wire gauze. When the temperature of the liquid reaches 275–285°, phenol commences to distil. Regulate the heating so that the temperature on the upper thermometer never exceeds 175°, but preferably remains below 170°: phenol distils at the rate of 5–10 drops per minute. After 6–7 hours, the temperature of the liquid is 350–355° and phenol practically ceases to distil; the weight of distillate at this point is about 110 g. Change the receiver, raise the lower thermometer from the liquid and distil the contents of the flask as rapidly as possible with a free flame until the tarry residue begins to foam. Pour the distillate (*ca.* 85 g.) whilst still hot into a cold evaporating dish, allow to cool, grind it in a mortar with 50 ml. of 5 per cent. sodium hydroxide solution, then warm it on a water bath for 10–15 minutes with 200 ml. of this alkali solution. When cold, filter off the xanthone, wash it until free from alkali, and dry at 100°. Remove a small amount of low-melting impurity by boiling for 15 minutes with 125 ml. of methyl alcohol, filter when cold, and wash with a little methanol. The yield of xanthone, m.p. 171–172°, is 70 g.; this is sufficiently pure for the preparation of xanthhydrol. If it is required pure, recrystallise from rectified spirit (20 ml. per 1 g. of xanthone); the m.p. is thereby raised to 173–174°.

Xanthhydrol. Prepare an amalgam from 9.0 g. of clean sodium and 750 g. (55 ml.) of mercury (Section II,50,7, *Method 1*), and warm it to 50° in a 500 ml. Pyrex bottle. Add a cold suspension of 25 g. of xanthone in 175 ml. of rectified spirit, stopper the bottle and shake vigorously; raise the stopper from time to time to release the pressure. The temperature rises rapidly to 60–70°, the solid xanthone passes into solution, and a transient blue colour is developed. After about 5 minutes the alcoholic solution is clear and almost colourless. Shake for a further 10 minutes, separate the mercury, and wash it with 15 ml. of alcohol. Filter the

alcoholic solution whilst still warm, and pour it slowly and with stirring into 2 litres of cold distilled water. Filter the precipitated xanthhydrol with suction, wash it with water until free from alkali, and dry at 40–50° to constant weight. The yield of practically pure xanthhydrol, m.p. 122–123°, is 24 g. Recrystallisation from alcohol raises the m.p. by 1°.

The substance is comparatively unstable; it should be prepared when required or else kept in an alcoholic solution.

VII,17. 1 : 3 : 5-TRINITROBENZENE

1 : 3 : 5-Trinitrobenzene may be prepared by heating the sodium salt of 2 : 4 : 6-trinitrobenzoic acid with water :

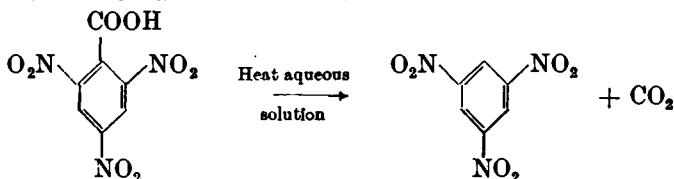

The compound is employed for the characterisation of aromatic hydrocarbons (compare Section IV,9), ethers and amines.

Dissolve 55 g. of crude 2 : 4 : 6-trinitrobenzoic acid (Section IV,142) in 400 ml. of water at 35° contained in a 1 litre bolt-head flask provided with a mechanical stirrer. Add 15 per cent. sodium hydroxide solution, with continuous stirring, until a *faint* red colour is *just* produced and take care that the temperature does not rise above 55°; discharge the colour by means of one or two drops of acetic acid and filter, if necessary, from unchanged trinitrotoluene. Treat the solution (or filtrate) in a 1 litre bolt-head flask with 14 ml. of glacial acetic acid and warm the mixture gently with continuous stirring: reduce the flame when once the evolution of carbon dioxide sets in otherwise the mixture might foam over. The trinitrobenzene separates in a crystalline condition and floats on the surface of the liquid as a frothy layer. The evolution of gas ceases after about 90 minutes: heat and stir for a further 45 minutes, allow to cool, and filter the crystals. Test the filtrate for undecomposed trinitrobenzoic acid by adding sulphuric acid: if a precipitate is produced, continue the heating of the filtrate. Recrystallise the compound from glacial acetic acid. The yield of 1 : 3 : 5-trinitrobenzene, m.p. 121–122°, is 30 g.

VII,18. S-BENZYL-ISO-THIURONIUM CHLORIDE

Benzyl chloride reacts with thiourea in dilute alcoholic solution to give *S*-benzyl-*iso*-thiuronium chloride* :

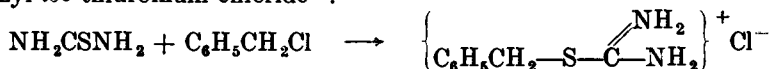

The compound separates in either, sometimes as both, of two dimorphic forms, m.p. 150° and 175° respectively. The former may be converted into the higher m.p. form by dissolving it in alcohol and seeding with crystals of the form, m.p. 175°: the low m.p. form when warmed to 175° gives, after solidification, a m.p. of 175°. Both dimorphic forms give identical derivatives with carboxylic acids and sulphonic acids (see Sections III,85 and IV,33).

* Also known as *S*-benzyl- ψ -thiuronium chloride and as *S*-benzyl-*iso*thiourea hydrochloride.

Method 1. Dissolve 76 g. of thiourea in 200 ml. of warm water in a 750 ml. or 1 litre round-bottomed flask. Dilute the solution with 135 ml. of rectified spirit and add 126.5 g. of benzyl chloride. Heat the mixture under reflux on a water bath until the benzyl chloride dissolves (about 15 minutes) and for a further 30 minutes taking care that the mixture is well shaken from time to time. Cool the mixture in ice: there is a tendency to supersaturation so that it is advisable to stir (or shake) the cold solution vigorously, when the substance crystallises suddenly. Filter off the solid at the pump. Evaporate the filtrate to about half bulk in order to recover a further small quantity of product. Dry the compound upon filter paper in the air. The yield of *S*-benzyl-*iso*-thiuronium chloride m.p. 174°, is 205 g. Recrystallise the salt from 400 ml. of 0.2*N* hydrochloric acid; filter off the solid which separates on cooling. Concentrate the filtrate to recover a further small quantity. The yield of recrystallised salt, m.p. 175° is 185 g.; some of the dimorphic form, m.p. 150°, may also separate.

Method 2. Place a mixture of 126.5 g. of benzyl chloride, 76 g. of thiourea and 150 ml. of rectified spirit in a 500 ml. round-bottomed flask fitted with a reflux condenser. Warm on a water bath. A sudden exothermic reaction soon occurs and all the thiourea passes into solution. Reflux the resulting yellow solution for 30 minutes and then cool in ice. Filter off the white crystals and dry in the air upon filter paper. Concentrate the filtrate to half its original volume and thus obtain a further small crop of crystals. The yield of crude *S*-benzyl-*iso*-thiuronium chloride, m.p. 145°, is 236 g. Recrystallise from 0.2*N* hydrochloric acid as in *Method 1*; the m.p. is raised to 150°, although on some occasions the form, m.p. 175°, separates.

VII,19. 3-NITROPHTHALIC ANHYDRIDE

The nitration of phthalic anhydride with a mixture of concentrated sulphuric and nitric acids yields a mixture of 3-nitro- and 4-nitro-phthalic acids; these are readily separated by taking advantage of the greater solubility of the 4-nitro acid in water. Treatment of 3-nitrophthalic acid with acetic anhydride gives 3-nitrophthalic anhydride.

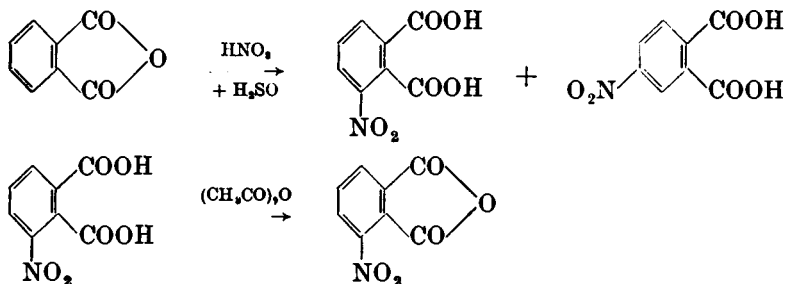

3-Nitrophthalic acid. Equip a 1500 ml. three-necked flask, supported on a water or steam bath, with a dropping funnel, a mechanical stirrer and a thermometer: the neck through which the stirrer passes should be open and the stirrer should be connected by means of a belt to the motor (nitrous fumes are evolved in the subsequent reaction and these would damage the motor if supported directly over the reaction

mixture). Place 250 g. of technical phthalic anhydride and 325 ml. of concentrated sulphuric acid in the flask and heat it until the temperature of the mixture rises to 80°. Shut off the steam or cool the water bath, and add 105 ml. of fuming nitric acid (sp. gr. 1.5) slowly from the dropping funnel at such a rate so as to maintain the temperature of the stirred mixture at 100–110° (about 1 hour). Then add 450 ml. of concentrated nitric acid (sp. gr. 1.42) as rapidly as possible without causing the temperature to rise above 110°. Heat the mixture on the water or steam bath, with stirring, for 2 hours. Allow the reaction mixture to stand overnight and then pour it into 750 ml. of cold water contained in a 2 litre beaker. Cool and filter the mixture of 3- and 4-nitrophthalic acids through a sintered glass funnel. Return the wet cake of acids to the rinsed-out beaker and stir it thoroughly with 100 ml. of water, which dissolves a large amount of the 4-nitrophthalic acid (1). Filter again at the pump and dissolve the solid in 100–150 ml. of boiling water: filter the hot solution and stir mechanically until crystallisation commences and then leave overnight until crystallisation is complete. Filter again with suction and dry upon filter paper. The yield of crude 3-nitrophthalic acid, m.p. 208–210° (sealed tube), is 110 g. Recrystallisation from about 250 ml. of boiling water (2) gives about 90 g. of the pure acid, m.p. 216–118° (sealed capillary tube).

Notes.

(1) The mother liquors from the washings and recrystallisations are saved for the recovery of the 4-nitrophthalic acid. The combined mother liquors are concentrated to a small bulk and the acid is extracted with ether. Upon esterification by the Fischer-Speier method, the 3-nitro acid forms only the acid ester and may be removed by slaking the product with sodium carbonate solution, whilst the neutral ester of 4-nitrophthalic acid remains unaffected. Hydrolysis of the neutral ester gives the pure 4-nitrophthalic acid, m.p. 165°.

(2) The acid may also be crystallised from glacial acetic acid.

3-Nitrophthalic anhydride. In a 250 ml. round-bottomed flask, fitted with a reflux condenser, place 75 g. of 3-nitrophthalic acid and 70 g. (65 ml.) of redistilled acetic anhydride. Heat the mixture to gentle boiling until a clear solution is obtained, and then for about 10 minutes longer. Pour the hot mixture (*FUME CUPBOARD*) into a large porcelain dish and allow to cool. Grind the crystalline mass thoroughly in a mortar and filter at the pump through a sintered glass funnel. Return the crystals to the mortar, grind them with 50 ml. of sodium-dried ether and filter. Again return the crystals to the mortar and wash once more with 50 ml. of dry, alcohol-free ether. Dry in the air for a short time, and then to constant weight at 100°. The yield of 3-nitrophthalic anhydride, m.p. 163–164°, is 60 g. If the m.p. is unsatisfactory, recrystallise the anhydride from benzene or from benzene - light petroleum.

VII.20.

DIAZOMETHANE

Liquid diazomethane CH_2N_2 , b.p. -24° , is an explosive compound and explosions may also occur in the gaseous state if the substance is dry and undiluted. The gas may be handled with safety by diluting it with nitrogen. For synthetical work, a dry ethereal solution of the gas is employed and this can be handled with safety; due regard must, however, be paid to the poisonous

and highly toxic character of the gas by carrying out all operations in an efficient fume cupboard (hood).

An ethereal solution of diazomethane is usually prepared immediately before it is required for reaction. Two intermediates may be used for this purpose, *viz.*, nitrosomethylurea and *p*-tolylsulphonylmethylnitrosamide: a number of methods are available for obtaining the former; the latter is prepared from methylamine and *p*-toluenesulphonyl chloride. Nitrosomethylurea is not very stable at room temperatures and must be kept at 0°; on the other hand *p*-tolylsulphonylmethylnitrosamide is a stable solid, which can be kept for long periods at room temperature in a dark bottle.

Nitrosomethylurea is conveniently prepared by treating acetamide (2.0 mols) with bromine (1.1 mols), followed by 10–25 per cent aqueous caustic alkali (2.0 mols) when acetylmethylurea is produced:

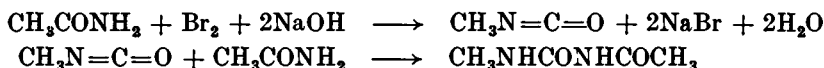

Excess of alkali must be avoided, otherwise the isocyanate (formed immediately) is converted into an amine:

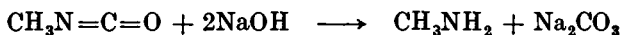

The acetylmethylurea is converted by concentrated hydrochloric acid into methylurea; the latter yields nitrosomethylurea with nitrous acid:

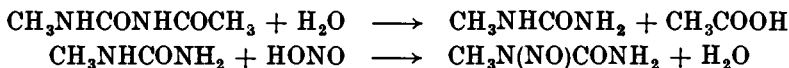

An alternative method of preparation involves the interaction of methylamine hydrochloride with urea to give methylurea, followed by interaction with nitrous acid as above:



Upon shaking nitrosomethylurea in the cold with a mixture of aqueous potassium hydroxide solution and pure ether, diazomethane is formed: the latter may be distilled off at 50° and collected in ether:

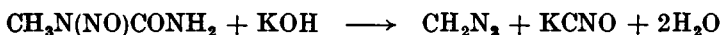

p-Tolylsulphonylmethylnitrosamide is obtained as follows. Interaction of *p*-toluenesulphonyl chloride and methylamine yields *p*-toluenesulphonylmethylamide:

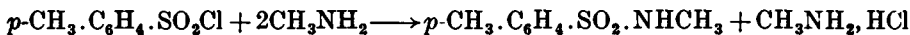

In order to secure the maximum conversion of the methylamine into the sulphonylmethylamide, the *p*-toluenesulphonyl chloride is introduced in several portions, and sodium hydroxide solution is added after each portion to liberate the methylamine from the hydrochloride formed in the reaction:

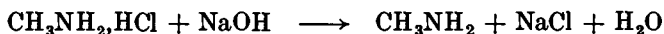

Treatment of the sulphonylmethylamide with nitrous acid gives *p*-tolylsulphonylmethylnitrosamide:

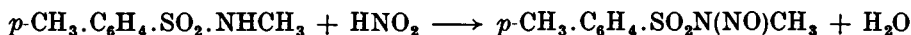

If alcoholic potassium hydroxide is added to an ethereal solution of the methylnitrosamide and the mixture distilled, an ethereal solution of diazomethane is obtained in high yield:

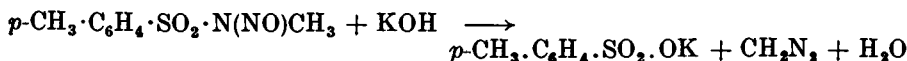

The structure of diazomethane is probably best represented as resonance hybrid :

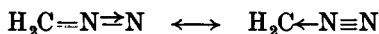

or as

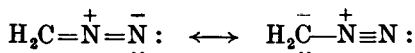

Nitrosomethylurea. Acetamide method. To a solution of 59 g. of acetamide in 88 g. (28 ml.) of bromine (1) in a 4-litre beaker add dropwise, with hand stirring, a solution of 40 g. of sodium hydroxide in 160 ml. of water. Heat the resulting yellow reaction mixture on a steam bath until effervescence sets in (2), after which continue the heating for 2-3 minutes. Crystallisation of the product from the yellow or red coloured solution usually commences immediately. Cool in an ice bath for 1-2 hours, collect the product by suction filtration, wash with a little ice-cold water, and dry in the air. The yield of colourless **acetylmethylurea**, m.p. 178-180°, is 50 g.

Heat a mixture of 49 g. of acetylmethylurea (3) and 50 ml. of concentrated hydrochloric acid, with hand stirring, on a steam bath until it is apparent that no more solid is dissolving (4) and continue the heating for 3-4 minutes longer : the total time of heating on the steam bath should be 8-12 minutes. Dilute the solution with 50 ml. of water and cool below 10° in an ice bath. Run in slowly and with stirring a cold saturated solution of 38 g. of A.R. sodium nitrite in 55 ml. of water below the level of the liquid. Keep the mixture in the ice bath for 5-10 minutes, filter the solid at the pump and wash it with 8-10 ml. of ice-cold water. Dry the nitrosomethylurea (pale yellow crystals) in the air or in a vacuum desiccator (5); the yield is 34 g., m.p. 123-124°.

Methylamine hydrochloride method. Place 100 g. of 24 per cent. methylamine solution (6) in a tared 500 ml. flask and add concentrated hydrochloric acid (about 78 ml.) until the solution is acid to methyl red. Add water to bring the total weight to 250 g., then introduce 150 g. of urea, and boil the solution gently under reflux for two and three-quarter hours, and then vigorously for 15 minutes. Cool the solution to room temperature, dissolve 55 g. of 95 per cent. sodium nitrite in it, and cool to 0°. Prepare a mixture of 300 g. of crushed ice and 50 g. of concentrated sulphuric acid in a 1500 ml. beaker surrounded by a bath of ice and salt, and add the cold methylurea - nitrite solution slowly and with mechanical stirring and at such a rate (about 1 hour) that the temperature does not rise above 0°. It is recommended that the stem of the funnel containing the methylurea - nitrite solution dip below the surface of the acid solution. The nitrosomethylurea rises to the surface as a crystalline foamy precipitate. Filter at once at the pump, and drain well. Stir the crystals into a paste with about 50 ml. of cold water, suck as dry as possible, and dry in a vacuum desiccator to constant weight. The yield is 55 g. (5).

Diazomethane. CAUTION. *Diazomethane is highly toxic : its preparation should be carried out only in a fume cupboard (hood) provided with a powerful exhaust system. The use of a screen of safety glass is recommended.*

Place 60 ml. of 50 per cent. aqueous potassium hydroxide solution and 200 ml. of pure ether in a 500 ml. round-bottomed flask. Cool the

mixture to 5°, and add 20.6 g. of nitrosomethylurea with shaking. Equip the flask with a condenser set for distillation, attach to the lower end of the condenser an adapter passing through a two-holed rubber stopper and dipping below the surface of 40 ml. of pure ether contained in a 300 ml. conical flask and immersed in an ice-salt mixture; pass the exit gases through a second 40 ml. portion of ether in a 300 ml. wash bottle cooled below 0°. Place the reaction flask on a water bath at 5° and bring it to the boiling point of the ether (7); shake occasionally. Distil the ether until it passes over colourless; this is usually the case when about two-thirds of the ether has been distilled. *Under no circumstances should all the ether be distilled as an explosion may result.* The combined ether solutions in the receivers contain 5.4–5.9 g. of diazomethane (8): this is sufficiently dry for most purposes. If a really dry solution is required, the ether solution may be allowed to stand for 2–3 hours over pellets of A.R. potassium hydroxide. The anhydrous ethereal solution may be kept for a day or two, but it undergoes gradual decomposition with the liberation of gas. The containing vessel should therefore be protected by a calcium chloride (or cotton wool) guard tube and kept in a refrigerator.

p*-Tolylsulphonylmethylnitrosamide. Divide 320 g. of *p*-toluenesulphonyl chloride, m.p. 68–69° (9) into three portions of 190, 90 and 40 g. Prepare a solution of 70 g. of sodium hydroxide in 70 ml. of water and cool to room temperature. Place 210 ml. of 33 per cent. aqueous methylamine solution (or 174 ml. of the 40 per cent. aqueous solution) in a 1-litre round-bottomed flask and add the 190 g. of *p*-toluenesulphonyl chloride in portions with swirling during about 5 minutes. The mixture becomes warm. Allow the temperature to rise to 80–90° in order to maintain the sulphonylmethylamide (m.p. 78°) in a molten condition, otherwise the latter may form a hard cake and reaction may be incomplete; also do not permit the temperature to rise above 90° as appreciable loss of methylamine may result. The mixture should be acid to litmus within 5 minutes after the completion of the first addition of the sulphonyl chloride (10). Then add 50 ml. of the 50 per cent. sodium hydroxide solution carefully with swirling, followed immediately by 90 g. of the sulphonyl chloride in portions as before. When the mixture has again become acidic (10), introduce 25 ml. of the sodium hydroxide solution, followed by 40 g. of the *p*-toluenesulphonyl chloride with vigorous swirling. After the mixture has again become acidic, add the remainder of the sodium hydroxide solution. The liquid phase of the final mixture should be alkaline; if it is acidic, indicating excessive loss of methylamine, add sufficient methylamine solution to render the mixture basic.

Rinse the walls of the flask with a little water and complete the reaction by heating the mixture (which consists of two layers and a precipitate of sodium chloride) on a boiling water bath for 15 minutes with vigorous mechanical stirring. Pour the *hot* reaction mixture into 1500 ml. of glacial acetic acid contained in a 4-litre round-bottomed flask; rinse the flask with 250 ml. of acetic acid. Cool the solution in an ice bath to 5° (11), stir mechanically, and add a solution of 125 g. of sodium nitrite in 250 ml.

* These experimental details are reproduced by kind permission of Professor H. J. Backer.

of water from a dropping funnel during about 45 minutes : maintain the temperature below 10° and continue the stirring for 15 minutes after the addition is complete. The nitroso derivative separates as a yellow crystalline solid during the reaction. Add 1 litre of water to the reaction mixture and collect the precipitate by suction filtration ; press it on the funnel and wash with about 500 ml. of water. Transfer the product to a beaker, stir it well with about 400 ml. of water, then filter and wash again on the funnel until the odour of acetic acid is no longer apparent. Dry to constant weight in a vacuum desiccator over concentrated sulphuric acid. The yield of *p*-tolylsulphonylmethylnitrosamide, m.p. $58-60^{\circ}$, is 325 g. This is sufficiently pure for the preparation of diazomethane. It should be kept in a dark bottle. It may be recrystallised by dissolution in boiling ether (1 ml./g.), addition of an equal volume of light petroleum, b.p. $40-50^{\circ}$, and cooling in a refrigerator.

Diazomethane. *CAUTION.* *Diazomethane is very toxic ; its preparation should be carried out only in a fume cupboard (hood) provided with a powerful exhaust system. The use of a screen of safety glass is recommended.*

The following procedures may be used for the preparation of ethereal solutions of diazomethane containing ethyl alcohol ; they differ slightly according to as to whether large or small quantities are required. The presence of alcohol is not harmful for many applications of diazomethane. (It may be pointed out that ethereal diazomethane solution prepared from nitrosomethylurea is free from alcohol.)

(a) Add 50 ml. of 96 per cent. ethanol to a solution of 10 g. of potassium hydroxide in 15 ml. of water. Place this solution in a 200 ml. distillation flask equipped with a dropping funnel and an efficient double surface condenser. Connect the condenser to two conical flasks (of 500 ml. and 100 ml. capacity respectively) to act as receivers ; charge the smaller flask with 40 ml. of ether and arrange that the inlet tube of the smaller receiver dips below the surface of the ether. Cool both receivers in an ice-salt mixture. Heat the distilling flask in a water bath at $60-65^{\circ}$ (7) ; place a solution of 43 g. of *p*-tolylsulphonylmethylnitrosamide in about 250 ml. of ether in the dropping funnel and introduce it into the flask over a period of 45 minutes. Adjust the rate of addition so that it is about equal to the rate of distillation. When the dropping funnel is empty, add more ether (*ca.* 30 ml.) gradually until the ether distilling over is colourless. The combined ethereal solutions in the receivers contain 5.9-6.1 g. of diazomethane (8).

(b) For smaller quantities of diazomethane, the use of a dropping funnel is unnecessary. Dissolve 2.14 g. of *p*-tolylsulphonylmethylnitrosamide in 30 ml. of ether, cool in ice, and add a solution of 0.4 g. of potassium hydroxide in 10 ml. of 96 per cent. ethanol. If a precipitate forms, add more ethanol until it just dissolves. After 5 minutes, distil the ethereal diazomethane solution from a water bath (7). The ethereal solution contains 0.32-0.35 g. of diazomethane (8).

An ethereal solution of diazomethane free from alcohol may be prepared as follows : such a solution is required, for example, in the Arndt-Eistert reaction with acid chlorides (compare Section VI,17). In a 100 ml. long-necked distilling flask provided with a dropping funnel and an efficient downward condenser, place a solution of 6 g. of potassium hydroxide in

10 ml. of water, 35 ml. of carbitol (diethyleneglycol monethyl ether) and 10 ml of ether : connect the condenser to two conical flasks in series containing 10 and 35 ml. of ether respectively and cooled in an ice-salt bath. Heat the mixture on a water bath at 70–75° (7) and as soon as the ether commences to distil, add a solution of 21.5 g. of *p*-tolylsulphonylmethyl-nitrosamide in 125 ml. of ether through the dropping funnel during a period of about 15 minutes. Shake the flask vigorously during the distillation; alternatively, pass a slow stream of nitrogen through the distilling flask during the distillation. After the addition of the nitrosamide, add 30–40 ml. of ether through the dropping funnel and distil until the distillate is colourless. The ethereal solution in the conical flasks contains about 3.4 g. of diazomethane (8).

Notes.

(1) It may be necessary to heat gently on a steam bath to dissolve the acetamide, and care should be taken that only the minimum amount of bromine is lost during the heating.

(2) The effervescence may become quite brisk: this is the reason for using a large container.

(3) The total yield of crude acetylmethylurea may be used without drying.

(4) If much sodium bromide is present in the crude acetylmethylurea, this will not dissolve in the concentrated hydrochloric acid; it dissolves, however, when the solution is diluted and has no effect upon the subsequent treatment with sodium nitrite.

(5) The preparation can be kept for long periods in a refrigerator, preferably in smooth, brown, alkali-free bottles; it should not be kept above 20° for more than a few hours: at 30°, it may undergo sudden decomposition and a serious explosion may result.

(6) Determine the methylamine content of the commercial solution by titration with standard acid using methyl orange as indicator. Adjust the quantity of methylamine solution in accordance with the methylamine content; for some commercial samples, the figure may be 33–40 per cent.

(7) Diazomethane is easily decomposed by rough surfaces: for this reason glass apparatus with scratches and also "porous pot" ("boiling stones") should not be used.

(8) To determine the exact diazomethane content, allow an aliquot portion of the ethereal diazomethane solution to react with an accurately weighed amount (say, about 1 g.) of A. R. benzoic acid in 50 ml. of anhydrous ether. The solution should be completely decolourised, thus showing that the benzoic acid is present in excess. Dilute the solution with water and titrate the excess of benzoic acid with standard 0.1*N* alkali using phenolphthalein as indicator.

(9) It may be recrystallised from benzene - light petroleum, b.p. 60–80° (1 : 20).

(10) Occasionally the liquid may not become acidic after the first or second addition, even through the sulphonyl chloride has reacted completely. (This is due to a smaller loss of methylamine than is expected.) If such is the case, no more than 5 minutes should be allowed between successive additions of sulphonyl chloride and alkali. The whole procedure occupies about 30 minutes.

(11) A reaction temperature below 0° should be avoided because the total volume of acetic acid is just sufficient to keep the sulphonylmethylamide in solution above 0°.

The diazomethane-ether solution should be dry. If in doubt, it may be dried with A.R. potassium hydroxide pellets. The anhydrous ethereal solution may be stored in a smooth glass flask or bottle in a refrigerator for a week or so; since slow decomposition occurs with liberation of gas, the containing vessel should be protected by a calcium chloride (or cotton wool) guard tube.

Methylation with diazomethane may be carried out as follows (*FUME CUPBOARD!*): Dissolve 2–3 g. of the compound (say, a phenol or a carboxylic acid) in a little anhydrous ether or absolute methanol, cool in ice, and add the ethereal solution of diazomethane in small portions until gas evolution ceases and the solution acquires a pale yellow colour. Test the coloured solution for the presence of excess of diazomethane by removing a few drops into a test-tube and introducing a glass rod moistened with glacial acetic acid: immediate evolution of gas should occur. Evaporate the solvent, and purify the product by distillation or crystallisation.

VII,21. 3 : 4 : 5-TRIIDOBENZOYL CHLORIDE

3 : 4 : 5-Triiodobenzoyl chloride may be prepared by the following series of reactions :

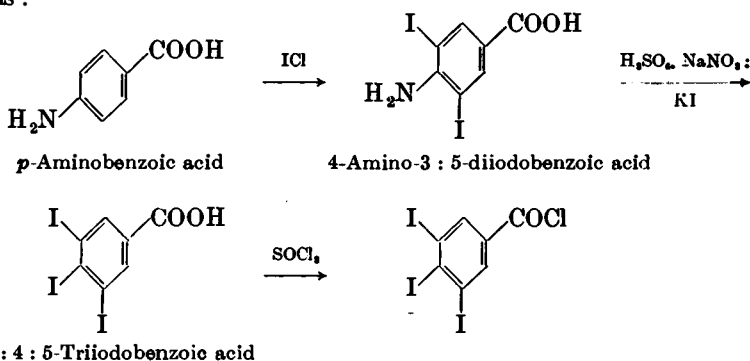

It is an excellent reagent for the characterisation of alcohol-ethers (see Section III,27).

4-Amino-3 : 5-diiodobenzoic acid. In a 2 litre beaker, provided with a mechanical stirrer, dissolve 10 g. of pure *p*-aminobenzoic acid, m.p. 192° (Section IX,5) in 450 ml. of warm (75°) 12·5 per cent. hydrochloric acid. Add a solution of 48 g. of iodine monochloride (1) in 40 ml. of 25 per cent. hydrochloric acid and stir the mixture for one minute: during this time a yellow precipitate commences to appear. Dilute the reaction mixture with 1 litre of water whereupon a copious precipitate is deposited. Raise the temperature of the well-stirred mixture gradually and maintain it at 90° for 15 minutes. Allow to cool to room temperature, filter, wash thoroughly with water and dry in the air; the yield of crude acid is 24 g. Purify the product by dissolving it in dilute sodium hydroxide solution and precipitate with dilute hydrochloric acid: the yield of air-dried 4-amino-3 : 5-diiodobenzoic acid, m.p. >350°, is 23 g.

3 : 4 : 5-Triiodobenzoic acid. Dissolve 6·8 g. of 3 : 5-diiodo-4-aminobenzoic acid in 30 ml. of cold concentrated sulphuric acid, add a large excess (3·0 g.) of powdered sodium nitrite, and allow the mixture to stand at 0° for 2 hours. Treat the cold diazonium solution with a solution of 17·0 g. of potassium iodide in 40 ml. of water; a dark red precipitate separates. Warm the mixture on a water bath until the evolution of nitrogen ceases, and remove any residual iodine with a little

sodium bisulphite. Filter the light yellow precipitate of crude 3 : 4 : 5-triiodobenzoic acid, and recrystallise from dilute alcohol. The yield of the pure acid, m.p. 289–290°, is 6·8 g.

3 : 4 : 5-Triiodobenzoyl chloride. Reflux 5 g. of 3 : 4 : 5-triiodobenzoic acid, m.p. 289–290°, gently with 10 ml. of redistilled thionyl chloride for 2 hours. Distil off the excess of thionyl chloride on a water bath, and recrystallise the residue from carbon tetrachloride - light petroleum with the use of a little decolourising charcoal. The yield of the acid chloride (bright yellow needles, m.p. 138°) is 3·8 g.; it keeps well in a stoppered bottle.

Note.

(1) Iodine monochloride may be prepared as follows. Pass dry chlorine into 127 g. of iodine contained in a 125 ml. distilling flask until the weight has increased by 34·5 g. The chlorine should be led in at or below the surface of the iodine whilst the flask is gently shaken; it is essential to have an excess of iodine. Distil the iodine chloride in an ordinary distillation apparatus: use a filter flask, protected from atmospheric moisture by a calcium chloride (or cotton wool) guard tube, as a receiver. Collect the fraction b.p. 97–105°; the yield is 140 g. Preserve the iodine monochloride in a dry, glass-stoppered bottle.

Since iodine monochloride attacks cork and rubber, the use of an all-glass apparatus is recommended. If it should come into contact with the skin, an effective antidote is dilute hydrochloric acid (1 : 1).

VII,22. 3 : 5-DINITROBENZOYL CHLORIDE

Place a mixture of 30 g. of 3 : 5-dinitrobenzoic acid (Section IV,168 and 33 g. of phosphorus pentachloride in a Claisen flask: fit a reflux condenser into the short neck and cork the other neck and side arm (compare Fig. III, 31, 1). Heat the mixture in an oil bath at 120–130° for 75 minutes. Allow to cool. Remove the phosphorus oxychloride by distillation under reduced pressure (25°/20 mm.); raise the temperature of the bath to 110°. The residual 3 : 5-dinitrobenzoyl chloride solidifies on cooling to a brown mass; the yield is quantitative. Recrystallise from carbon tetrachloride: the yield is 25 g., m.p. 67–68° and this is satisfactory for most purposes. Further recrystallisation from a large volume of light petroleum b.p. 40–60°, gives a perfectly pure product, m.p. 69·5°.

3 : 5-Dinitrobenzoyl chloride reacts readily with water and it should be kept in sealed tubes or under light petroleum. When required for qualitative organic analysis it is usually best prepared from 3 : 5-dinitrobenzoic acid immediately before use (see Section III,27,1).

VII,23. 1 : 2-CYCLOHEXANEDIONE-DIOXIME (NIOXIME)

*cyclo*Hexanone is oxidised by selenium dioxide to 1 : 2-*cyclo*hexanedione, and the latter is converted into the dioxime by treatment with aqueous hydroxylamine hydrochloride and aqueous potassium hydroxide.

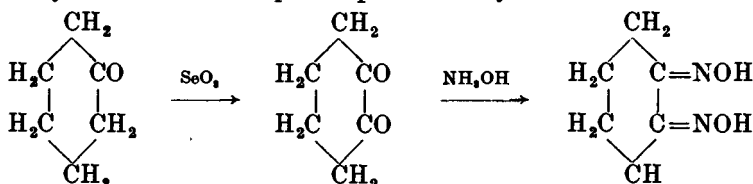

This reagent, to which the name nioxime has been given, is employed for the determination of palladium and may also be used for nickel: it is soluble in water, and possesses advantages over dimethylglyoxime. The latter is used as a solution in alcohol and may therefore contaminate the palladium or nickel precipitate when added to an aqueous solution.

1 : 2-cycloHexanedione. Equip a 1-litre, three-necked flask with a reflux condenser, thermometer and dropping funnel. Place 250 g. of pure *cyclohexanone* (preferably ex bisulphite compound) in the flask, heat to 70–80°, and add a solution of 280 g. of pure selenium dioxide in 1500 ml. of rectified spirit (95 per cent. ethyl alcohol) from the dropping funnel over a period of 2 hours, maintaining the temperature at 70–80°. Reflux the reaction mixture for a further 2 hours. Distil off as much of the alcohol as possible and decant the liquid residue from the elementary selenium. Wash the latter several times with ether, and combine the ether extracts with the decanted liquid. Remove the ether by distillation and distil the residue under reduced pressure (*ca.* 25 mm.): about 200 g. of an oil, consisting of 1 : 2-*cyclohexanedione*, *cyclohexanone* and water, is obtained. Dissolve the oil in 1 litre of ether, and extract thrice with ice-cold 10 per cent. potassium hydroxide solution; the total amount of potassium hydroxide solution should be equivalent to 1.5 times that necessary to react with the oil assumed to be the pure dione in the monoenol form. Shake the alkaline extract once with ether to remove *cyclohexanone*, acidify with ice-cold hydrochloric acid, and then saturate with salt. Extract the hydrochloric acid solution with ether, dry the ethereal extract with anhydrous magnesium sulphate, remove the ether by distillation at normal pressure, and distil the residue under reduced pressure. Collect the 1 : 2-*cyclohexanedione* (a pale green liquid) at 96–97°/25 mm.; the compound decomposes slightly on keeping. The yield is 55–56 g.

It is important that the synthesis should be carried out as quickly as possible, particularly the washing with alkali at 0°, since the latter tends to convert the product into *cyclopentane- α -hydroxycarboxylic acid*.

1 : 2-cycloHexanedione-dioxime. Dissolve 55 g. of the freshly distilled dione in 500 ml. of water, cool the solution to 0°, and dissolve 170 g. of pure hydroxylamine hydrochloride in it. Add a solution of 225 g. of potassium hydroxide in 1 litre of water at 0° dropwise over a period of 15 minutes with constant mechanical stirring. Heat the mixture on a steam bath for 2 hours, cool to 0°, neutralise with "dry ice," saturate with salt, filter off the precipitated dioxime, and wash with a little ice-cold water. Recrystallise the crude dioxime from water. The yield of pure *cyclohexanedione-dioxime* (white needles), m.p. 187–188° (decomp.), is 39 g.

VII,24.

QUINALDINIC ACID

Bromination of quinaldine (I) (Section V,2) with bromine in glacial acetic acid in the presence of anhydrous sodium acetate affords ω -tribromoquinaldine or 2-(tribromomethyl)-quinaldine (II); hydrolysis of the latter by boiling with dilute sulphuric acid gives quinaldinic acid (III).

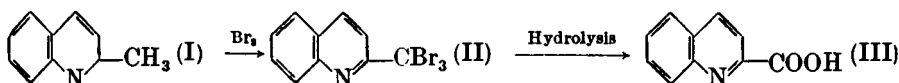

Fit a 500 ml. bolt-head flask with a reflux condenser and dropping funnel. Place a mixture of 50 g. of anhydrous, powdered sodium acetate, 100 g. of glacial acetic acid and 14 g. of pure quinaldine in the flask, and a solution of 48 g. (15.5 ml.) of bromine in 100 g. of glacial acetic acid in the dropping funnel. Heat the flask to 70° in a water bath, and add the bromine solution during 10–15 minutes whilst keeping the mixture thoroughly shaken. Boil the solution for a few minutes (until the separation of sodium bromide causes violent bumping), then heat for 30 minutes on a water bath, and allow to cool. Pour the reaction mixture into 300 ml. of ice-water, collect the precipitate by suction filtration, and wash thoroughly with water. The yield of crude product, after drying at 100°, is 36 g. Recrystallise if from alcohol or glacial acetic acid: the pure ω -tribromoquinaldine has m.p. 128°.

Hydrolyse the ω -tribromoquinaldine by boiling it under reflux with excess of dilute (1 : 10) sulphuric acid until a test portion, on neutralisation, yields no unchanged halogen compound. The quinaldinic acid is best isolated, via the copper salt, in the following manner. Cool, nearly neutralise the solution and add excess of copper sulphate solution. Collect the pale green copper quinaldinate by suction filtration and wash it well with cold water. Suspend the copper salt in hot water and subject it to prolonged treatment with hydrogen sulphide gas. Filter off the copper sulphide and evaporate the clear filtrate to dryness on a water bath. Recrystallise the residual quinaldinic acid from glacial acetic acid; it then melts at 157°. The yield is almost quantitative.

VII.25. GIRARD'S REAGENTS 'T' and 'P'

Girard's reagent 'T' is carbohydrazidomethyltrimethylammonium chloride (I) and is prepared by the reaction of the quaternary ammonium salt formed from ethyl chloroacetate and trimethylamine with hydrazine hydrate in alcoholic solution:

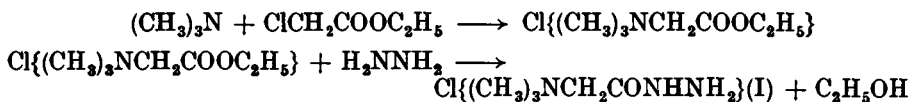

Girard's reagent 'P' is the corresponding pyridinium compound, prepared by replacing the trimethylamine by pyridine. The reagent 'T', unlike the reagent 'P', is very deliquescent, but is nevertheless widely used for laboratory work because of its greater solubility. The quaternary ammonium grouping imparts water solubility.

The main use of the Girard reagents 'T' and 'P' is for the isolation of small amounts of ketones from admixture with other organic matter contained in various natural products; the carbonyl derivatives are water soluble. The ketonic material, dissolved in alcohol containing 10 per cent. acetic acid, is heated for 30–60 minutes with the reagent in slight excess, the volume being adjusted to give 5 or 10 per cent. solution of the reagent. The cooled solution is diluted with water containing enough alkali to neutralise 90 per cent. of the acid and to give an alcohol content of 10–20 per cent. It is then exhaustively extracted with ether to remove non-ketonic compounds; the water-soluble hydrazone derivatives are decomposed by the addition of mineral acid up

to a concentration of 0.5*N* and, after about 1 hour at room temperature, the liberated ketonic compound is isolated by extraction with ether.

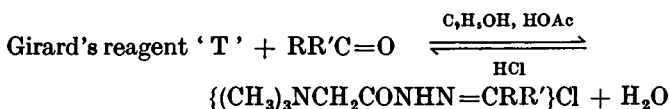

Girard's Reagent 'T'. Place a solution of 98.5 g. (84.5 ml.) of ethyl chloroacetate and 200 ml. of absolute ethanol in a 1-litre three-necked flask, fitted with a thermometer, stirrer and a Dewar type of condenser (Fig. II, 1, 4, *h*) filled with ice (1). Cool the solution to 0° by stirring in an ice-salt bath, stop the stirrer and add 49 g. (74 ml., measured after pre-cooling to -5°) of trimethylamine all at once. Control the exothermic reaction sufficiently by external cooling so that the temperature of the mixture rises to 60° during about 1 hour. When there is no further evolution of heat, allow the reaction mixture to stand at room temperature for 20-24 hours. Remove the condenser, replace the thermometer by a dropping funnel, and add 40 g. of 100 per cent. hydrazine hydrate (2) with stirring during 10-15 minutes. Stir for a further 45 minutes, cool the solution slightly and, unless crystallisation commences spontaneously, scratch the walls of the vessel with a glass rod to induce crystallisation. The product separates in fine, colourless needles. Cool in an ice bath, collect the highly hygroscopic salt rapidly on a Buchner funnel, wash with 150 ml. of cold absolute ethanol and press dry under a rubber dam. Dry the product in a vacuum desiccator over concentrated sulphuric acid; the yield is 105 g., m.p. 175-180° (decomp.). (This material (3) contains a small amount of the symmetrical dihydrazide, but is quite satisfactory as a reagent for the separation of ketones.) A further crop of 12 g. may be obtained after distilling off 200-300 ml. of solvent from the mother liquor and washings at the pressure of the water pump.

(1) Alternatively, a glass spiral, fitted by means of a cork at the lower end into a glass or metal vessel filled with ice, may be used.

(2) Hydrazine hydrate of 95-100 per cent. concentration is a commercial product. The 40-60 per cent. solution may be concentrated to 80-85 per cent. strength by distillation with xylene in an all-glass apparatus.

(3) The deliquescent solid must be stored in a dry, tightly-stoppered container. If exposed to the air it deteriorates rapidly, developing an unpleasant odour. Samples that have been kept for some time are best recrystallised from absolute ethanol before use.

Girard's reagent 'P', {C₅H₅NCH₂CONHNH₂}Cl. In a 1-litre three-necked flask, equipped as in the previous preparation, place 200 ml. of absolute ethyl alcohol, 63 g. (64.5 ml.) of pure anhydrous pyridine and 98.5 g. (84.5 ml.) of ethyl chloroacetate. Heat the mixture under reflux for 2-3 hours until the formation of the quaternary salt is complete; acidify a small test-portion with dilute sulphuric acid; it should dissolve completely and no odour of ethyl chloroacetate should be apparent. Cool the mixture in ice and salt. Replace the thermometer by a dropping funnel, and add a solution of 40 g. of 100 per cent. hydrazine hydrate in 50 ml. of absolute ethanol all at once. A vigorous exothermic reaction soon develops and is accompanied by vigorous effervescence. The product separates almost immediately. When cold, filter with suction, wash

with ice-cold ethanol, and dry in the air. The yield of Girard's reagent 'P' is 135 g.; this is satisfactory for the isolation of ketones. A pure product may be obtained by recrystallisation from methanol.

VII,26. PSEUDO-SACCHARIN CHLORIDE

Pseudo-saccharin chloride (II) is prepared by the action of phosphorus pentachloride upon saccharin (I) :

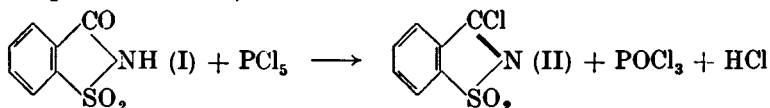

Mix intimately in a glass mortar 35 g. of saccharin (Section IV,209) and 70 g. of phosphorus pentachloride, transfer to a 250 ml. round-bottomed flask connected by a ground glass joint to a reflux condenser; attach the latter through a calcium chloride guard tube to a gas absorption trap (Fig. II, 8, 1). Heat the mixture in an oil bath at 175–180° for 90 minutes; at the end of this period the vigorous evolution of hydrogen chloride will have subsided. Replace the reflux condenser by a fractionating column, distil off the phosphorus oxychloride, and pour the warm residue upon finely crushed ice. Extract the crude solid pseudo-saccharin chloride with chloroform, dry the chloroform solution with anhydrous magnesium sulphate, and distil off the solvent. Recrystallise the residue from chloroform or from dry benzene. The yield of pure pseudo-saccharin chloride, m.p. 143–145° (decomp.), is 26 g. It is best kept in a sealed glass tube or in a glass-stoppered bottle.

CHAPTER VIII

DYESTUFFS, INDICATORS AND RELATED COMPOUNDS

THE procedures for the preparation of a number of azo dyestuffs are described in Sections IV,76-IV,82; these include the indicators methyl orange and methyl red. Experimental details for the preparation of other typical dyestuffs and indicators are given in the following pages.

VIII,1. CONGO RED

This dyestuff is prepared by tetrazotising benzidine and coupling with sodium naphthionate:

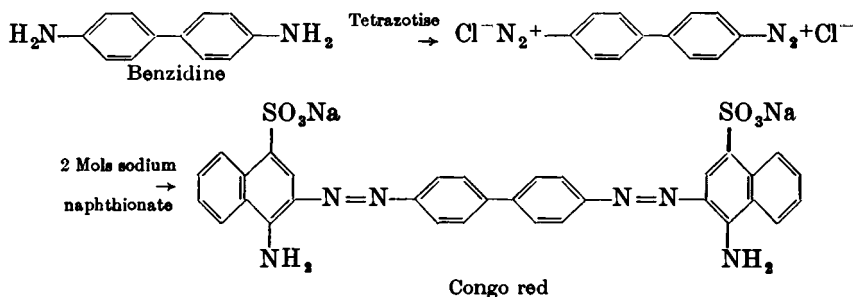

Dissolve 9.2 g. of benzidine (Section IV,88) in a hot mixture of 24 ml. of concentrated hydrochloric acid and 150-200 ml. of water. Cool in an ice bath to 0-5° and diazotise ("tetrazotise") by the addition of a solution of 6.9 g. of sodium nitrite (100 per cent.; if the purity is lower, the weight must be adjusted accordingly) in 50 ml. of water within 1 minute. Leave the "tetrazo" solution in ice for 5 minutes and then add it to a solution of 32 g. of sodium naphthionate (Section IV,56) and 40 g. of crystallised sodium acetate in 500 ml. of water. Stir well and allow the mixture to stand for 1 hour. When a sample of the liquid, upon warming with hydrochloric acid, no longer evolves nitrogen, dissolve the blue-black precipitate of the dye-acid by the gradual addition of sodium carbonate (*ca.* 20 g.), followed by stirring and warming until the temperature reaches 80°. By this time the dye should be in solution as the red sodium salt (Congo red). Filter, and just saturate (avoid an excess) the hot solution with sodium chloride and allow to cool spontaneously to room temperature. Cool in ice, filter off the Congo red at the pump (1), wash it with saturated sodium chloride solution and dry in the air. The yield is 60 g.

Note.

(1) If filtration is slow, the following procedure may be used. Place the fine suspension in a large evaporating dish and evaporate to dryness on a water bath. Dissolve the resulting sticky mass in the minimum volume of dilute alcohol (1 volume of water : 3 volumes of methylated spirit; about 200-250 ml.) and allow

to cool. Filter the Congo red, which is now granular, with gentle suction; and dry upon filter paper in the air. The product may contain an appreciable quantity of salt; this may be largely removed by repeating the recrystallisation from dilute alcohol.

VIII.2. INDIGO

Indigo may be prepared by the following series of reactions:—

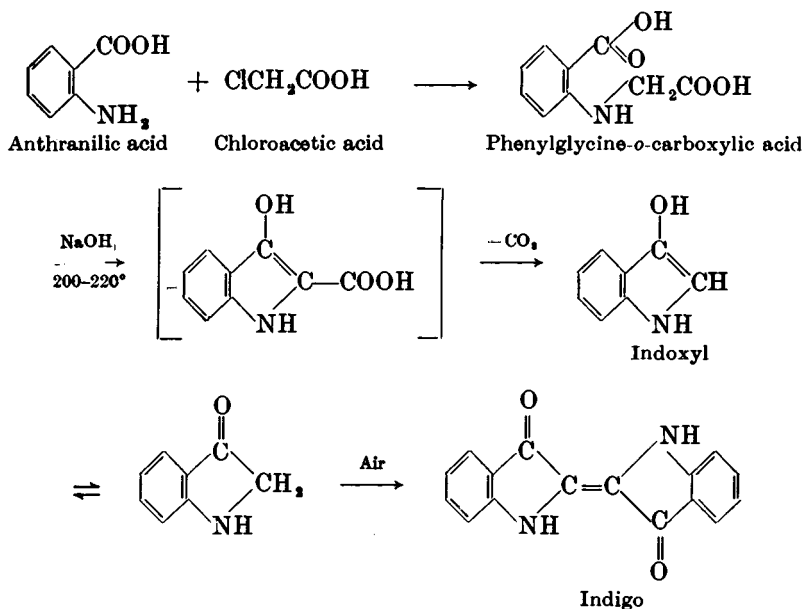

Phenylglycine-*o*-carboxylic acid. In a 750 ml. round-bottomed flask, fitted with a reflux condenser, place 14 g. of anthranilic acid (Section IV,170), 10 g. of chloroacetic acid, 20 g. of anhydrous sodium carbonate and 200 ml. of water. Reflux the mixture for 3 hours, then pour into a beaker, cool, render slightly acid with concentrated hydrochloric acid, and allow to stand overnight. Filter off the crude acid and wash it with water. Recrystallise from hot water with the aid of a little decolourising carbon, and dry the acid at 100°. The yield of phenylglycine-*o*-carboxylic acid, m.p. 208°, is 12 g.

Indigo. Place a mixture of 10 g. of phenylglycine-*o*-carboxylic acid, 30 g. of sodium hydroxide pellets and 10 ml. of water in a large nickel crucible or basin. Heat the mixture to 200–210° and stir well with a thermometer protected by a copper tube (Section IV,101). The mass fuses and the mixture gradually assumes an orange colour. Allow the crucible to cool somewhat, and dissolve the melt in 200 ml. of water. This solution oxidises upon shaking in contact with air forming a precipitate of indigo. The conversion into indigo may be more rapidly effected (1) by acidifying with hydrochloric acid and oxidising with ferric chloride solution until no further precipitate of the dyestuff is produced. Filter off the indigo at the pump, wash it with hot water and dry. The yield is 7 g.

Note.

(1) The filtered solution of indoxyl may also be oxidised by placing it in a filter flask and drawing air through the solution by means of a water pump until a drop of the aqueous suspension of indigo when placed upon filter paper produces a sharply defined ring of precipitated indigo, outside which the liquid no longer becomes blue upon exposure to air.

VIII.3.**ALIZARIN**

Upon heating anthraquinone with fuming sulphuric acid at 160° for about 1 hour, the main product is anthraquinone- β -sulphonic acid, which is isolated as the sparingly soluble sodium salt. The latter when heated under pressure with sodium hydroxide solution and an oxidising agent (sodium or potassium chlorate) yields first the corresponding hydroxy compound: further hydroxylation occurs in the α -position through oxidation by the chlorate and 1:2-dihydroxyanthraquinone (alizarin) is formed.

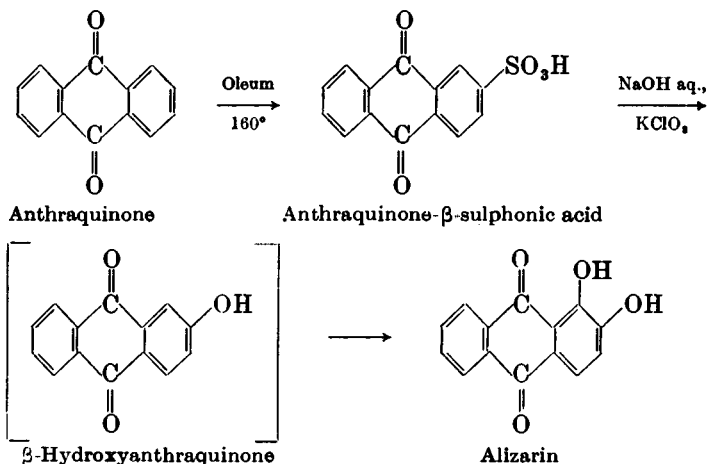

Sodium anthraquinone- β -sulphonate ("silver salt"). Place 50 g. of fuming sulphuric acid (40–50 per cent. SO_3) * in a 250 or 500 ml. round-bottomed flask and add 50 g. of dry, finely-powdered anthraquinone (Section IV,145). Fit an air condenser to the flask and heat the mixture slowly in an oil bath, with occasional shaking, so that at the end of 1 hour the temperature has reached 160°. Allow to cool and pour the warm mixture carefully into a 2 litre beaker containing 500 g. of crushed ice. Boil for about 15 minutes and filter off the unchanged anthraquinone at the pump. Neutralise the hot filtrate with sodium hydroxide and allow to cool, when the greater part of the sodium anthraquinone- β -sulphonate separates as silvery glistening plates ("silver salt"). Filter these with suction and dry upon filter paper or upon a porous plate. A second crop of crystals may be isolated by concentration of the filtrate to half the original volume. The yield is 40–45 g.

Alizarin. Dissolve successively in 75 ml. of water 6 g. of potassium chlorate, 20 g. of sodium anthraquinone- β -sulphonate and 75 g. of sodium hydroxide. Transfer the mixture to a 500 ml. autoclave (compare Section VI,4) and heat for 20 hours at 170°. After cooling, scrape out

* The solid acid is removed from the stock bottle by cautiously melting it in an air bath.

the violet coloured mass and extract it three or four times with 100 ml. portions of boiling water. Acidify the filtered extract with hydrochloric acid. When cold, filter the orange precipitate of alizarin at the pump, wash it thoroughly with cold water, and dry at 100°. The yield of alizarin is 14 g. It may be purified by recrystallisation from glacial acetic acid or by sublimation. The pure compound has m.p. 289°.

VIII.4. CRYSTAL VIOLET

Crystal violet is an example of a triphenylmethane dye. Its preparation in the laboratory may be illustrated by the condensation of 4 : 4'-tetramethyldiaminobenzophenone (Michler's ketone) and dimethylaniline in the presence of phosphorus oxychloride :

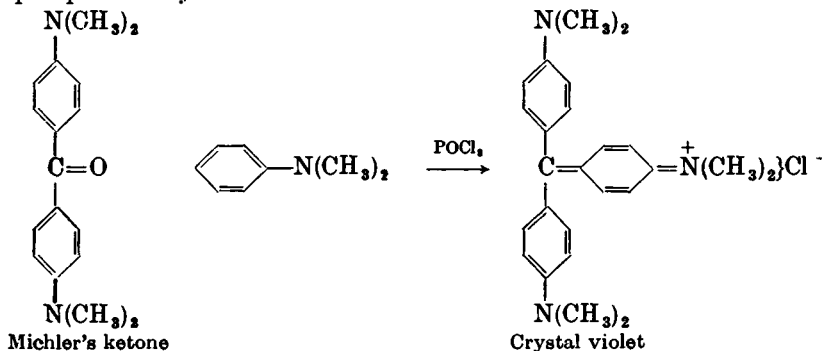

Michler's ketone is prepared industrially by the interaction of phosgene (COCl_2) and dimethylaniline.

In a 1 litre round-bottomed flask, provided with an air condenser, place a mixture of 25 g. (26 ml.) of pure dimethylaniline, 10 g. of Michler's ketone (4 : 4'-tetramethyldiaminobenzophenone) and 10 g. (6 ml.) of phosphorus oxychloride. Heat on a boiling water bath for 5 hours. Add about 150 ml. of water and sufficient sodium hydroxide solution to render the solution alkaline. Calculate the quantity of sodium hydroxide required upon the basis of the hydrolysis product derived from the phosphorus oxychloride :

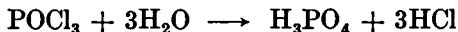

Pass steam into the mixture (Fig. II, 40, 1) until no more drops of un-attacked dimethylaniline pass over into the receiver. Allow to cool and filter the reddish precipitate of the "colour base" at the pump and wash it with water. Transfer the precipitate to a large beaker and boil it with a mixture of 5 ml. of concentrated hydrochloric acid and 1 litre of water. Filter the hot solution and set the filtrate aside for crystallisation to take place. Treat the residue with successive portions of fresh dilute hydrochloric acid until it has almost entirely dissolved. On cooling and standing, the crystal violet separates in green crystals; filter these with suction. Treat the combined filtrates, whilst stirring, with finely-powdered sodium chloride until precipitation is complete and the liquid is just saturated; collect the precipitate in a filter. The crystal violet may be recrystallised from a little water, and dried upon filter paper in the air. The yield is 12 g.

VIII.5. COPPER PHTHALOCYANINE (MONASTRAL BLUE)

The pure pigment may be obtained by heating phthalonitrile (4 mols) and copper bronze (1 atom) at 200–220° :

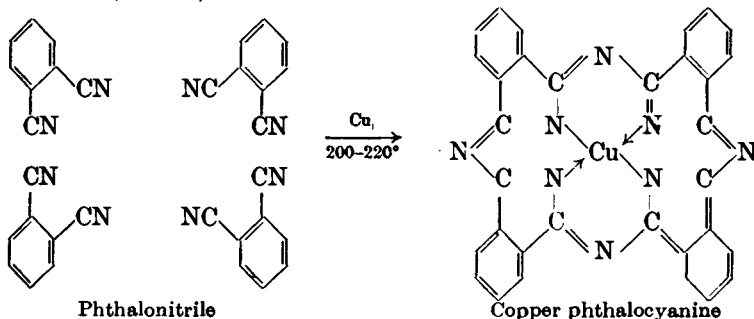

Phthalonitrile may be prepared by the following series of reactions from phthalimide :—

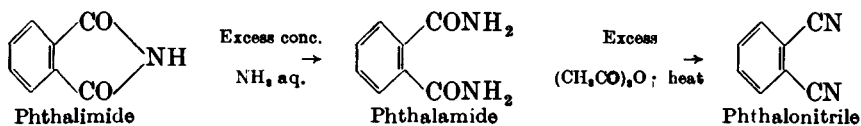

Phthalamide. Mix 200 g. of phthalimide (Section IV,169) with 600 ml. of concentrated ammonia solution in a 1 litre beaker and stir mechanically for 24 hours. Filter off the micro-crystalline cake of phthalamide and dry at 100°. The yield is 200 g., m.p. 220° (decomp.).

Phthalonitrile. In a 1 litre round-bottomed flask, provided with a reflux condenser, place 100 g. of phthalamide and 350 ml. of acetic anhydride. Reflux for 5–6 hours. Add the reaction product whilst still hot cautiously to 700 ml. of boiling water; this decomposes the excess of acetic anhydride. Cool in ice, and then render the reaction mixture alkaline with sodium hydroxide solution. Filter off the precipitated crystals at the pump, wash with water, and dry at 100°. The yield of the crude nitrile is 70 g. After one or two recrystallisations from benzene, the m.p. should be 141°—that of pure phthalonitrile. It is usually best to distil the crude nitrile under reduced pressure (Figs. II, 19, 3–4): the distillate has m.p. 137–138°, and the m.p. is raised to 141° after one recrystallisation from benzene.

Copper phthalocyanine (Monastral blue). In a wide glass tube place 12.8 g. of phthalonitrile and 1.59 g. of copper bronze. Heat, with stirring by means of a thermometer, in an oil bath. A green colour first forms at 190° and the mass becomes pasty at 220°. Maintain the bath temperature at 220° for 15 minutes: the internal temperature rises rapidly and at times exceeds that of the bath by 40–50° and stirring becomes impossible. Allow the mass to cool slightly and grind it with alcohol. Boil the finely-ground product repeatedly with alcohol until the washings are colourless and contain no phthalonitrile; then dry at 100°. The yield of crude copper phthalocyanine, which contains a little uncombined copper bronze, is 10 g. To remove the copper, dust 10 g. of the finely-powdered, crude product into 100 g. (55 ml.) of concentrated sulphuric acid with mechanical stirring. Allow to stand for 1 hour,

filter the solution through a sintered glass funnel, wash with concentrated sulphuric acid, and pour the combined filtrate and washings in a thin stream and with stirring on to 100 g. of finely-crushed ice. Allow the flocculent blue precipitate to coalesce for 2-3 hours, filter at the pump and wash with boiling water. Finally, boil the pigment with alcohol, filter and dry at 100°. The recovery of pure pigment is about 90 per cent.

The reaction between phthalonitrile and copper also takes place readily in boiling quinoline or α -methylnaphthalene: the pigment is precipitated as fast as it is formed as a crystalline product. It is separated from the excess of copper by shaking with alcohol, when the metal sinks and the pigment, which remains in suspension, can be poured off; the process may be repeated to give the pure compound.

VIII.6.

PHENOLPHTHALEIN

Phenol condenses with phthalic anhydride in the presence of concentrated sulphuric acid or anhydrous zinc chloride to yield the colourless phenolphthalein as the main product. When dilute caustic alkali is added to an alcoholic solution of phenolphthalein, an intense red colouration is produced. The alkali opens the lactone ring in phenolphthalein and forms a salt at one phenolic group. The reaction may be represented in steps, with the formation of a hypothetical unstable intermediate that changes to a coloured ion. The colour is probably due to resonance between which places the negative charge on either of the two equivalent oxygen atoms. With excess of concentrated caustic alkali, the first red colour disappears; this is due to the production of the carbinol and attendant salt formation, rendering resonance impossible. The various reactions may be represented as follows:

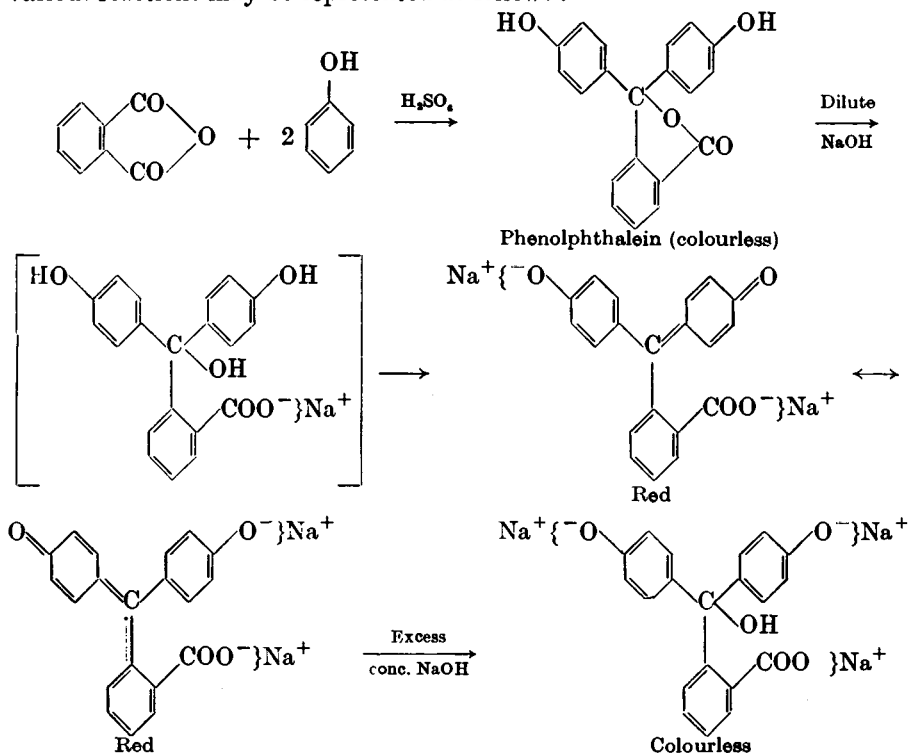

To a mixture of pure phenol and 25 g. of phthalic anhydride contained in a 250 ml. round-bottomed flask, add 20 g. (11 ml.) of concentrated sulphuric acid. Heat the flask in an oil bath at 115–120° for 9 hours. Then pour the reaction mixture whilst still hot into 1 litre of hot water contained in a 2 litre beaker, and boil until the odour of phenol has disappeared; add water to replace that lost by evaporation. When cold, filter the yellow, granular precipitate at the pump and wash it with water. Dissolve the solid in dilute sodium hydroxide solution, filter from the undissolved residue (the by-products of the reaction). Acidify the filtrate with dilute acetic acid and a few drops of dilute hydrochloric acid, and allow to stand overnight. The crude phenolphthalein separates as a pale yellow, sandy powder; filter and dry. Purify the crude product by dissolving it in six times its weight of absolute alcohol, add decolourising carbon and reflux on a water bath for 1 hour. Filter the hot solution through a preheated Buchner funnel, wash the residue with 2 parts by weight of boiling absolute alcohol and concentrate the combined filtrate and washings to two-thirds of its bulk on a water bath. Dilute the cooled solution with eight times the weight of cold water (it will become turbid), stir the mixture well and, after standing for a few seconds, filter through a wet filter to remove the resinous oil which separates. Heat the filtrate on a water bath to evaporate most of the alcohol; the turbidity disappears and the phenolphthalein separates out in the form of a white powder. Filter this off and dry. The yield of pure phenolphthalein, m.p. 256–258°, is 18 g.

VIII.7. FLUORESCEIN AND EOSIN

Fluorescein is obtained by condensing phthalic anhydride (1 mol) with resorcinol (2 mols) in the presence of anhydrous zinc chloride. The tetrabromo derivative, readily prepared by the addition of the calculated quantity of bromine, is eosin.

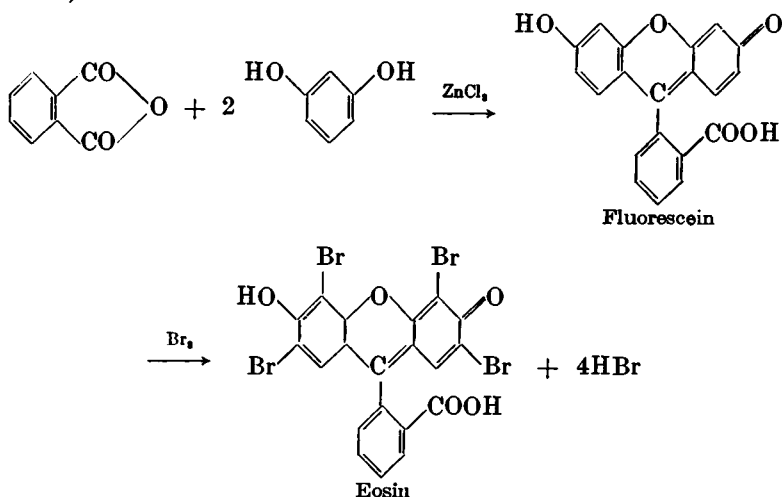

Dibromofluorescein is prepared by treating fluorescein in 80 per cent. acetic acid solution with the theoretical quantity of bromine.

Fluorescein. Grind together in a mortar 15 g. of phthalic anhydride and 22 g. of resorcinol, and transfer the mixture to a 350 or 500 ml. conical flask. Support the flask in an oil bath and heat to 180° (internal temperature). While the oil bath is being heated, weigh out rapidly 7 g. of anhydrous zinc chloride, immediately grind it to a coarse powder in a mortar and place it in a stoppered tube. (The zinc chloride should not be exposed to the air longer than is absolutely necessary; if the contents of the stock bottle appear moist, dry a 10–15 g. portion by fusing it in a porcelain dish.) Add the zinc chloride in small portions, with stirring by means of a thermometer, to the mixture in the flask. Continue the heating at 180° with stirring at intervals of 2–3 minutes until the solution becomes so viscous that further stirring is not practicable (45–90 minutes). The resulting dark red mass consists largely of a mixture of fluorescein and zinc chloride together with basic zinc salts. Allow the oil bath to cool to about 90°, and add 200 ml. of water and 10 ml. of concentrated hydrochloric acid to the reaction mixture, and then raise the temperature of the oil bath until the water boils. Stir the mixture from time to time when the temperature of the oil rises above 110°: great care should be taken to prevent the dilute acid from boiling over. Continue the boiling until the reaction mixture has disintegrated and all the zinc salts have dissolved. Filter the insoluble residue of fluorescein at the pump, grind it with water in a mortar, and filter again. Dry at 100°. The yield is 30 g. This product is pure enough for the preparation of eosin.

The fluorescein may be purified by dissolving it in dilute sodium hydroxide solution, filtering if necessary, precipitating with dilute hydrochloric acid (1:1), filtering, washing and drying.

Eosin (Tetrabromofluorescein). Place 16.5 g. of powdered fluorescein and 80 ml. of rectified (or methylated) spirit in a 250 ml. flask. Support a small dropping funnel, containing 36 g. (12 ml.) of bromine, above the flask: make sure that the stopcock of the funnel is well lubricated before charging the latter with bromine. Add the bromine dropwise during about 20 minutes. When half the bromine has been introduced, and the fluorescein has been converted into dibromofluorescein, all the solid material disappears temporarily since the dibromo derivative is soluble in alcohol: with further addition of bromine the tetrabromofluorescein (sparingly soluble in alcohol) separates out. Allow the reaction mixture to stand for 2 hours, filter off the eosin at the pump, wash it with alcohol, and dry at 100°. The yield of eosin (orange-coloured powder) is 25 g.

Sodium salt of eosin. Grind together in a mortar 12 g. of eosin with 2 g. of anhydrous sodium carbonate. Transfer the mixture to a 250 ml. conical flask, moisten it with 10 ml. of rectified spirit, add 10 ml. of water and warm on a water bath, with stirring, until the evolution of carbon dioxide ceases. Add 50 ml. of ethyl alcohol, heat to boiling, and filter the hot solution through a fluted filter paper (supported in a short-stemmed funnel) into a beaker, and allow to stand overnight. Filter off the brownish-red crystals of sodium eosin, wash with a little alcohol, and dry. The yield is 10 g.

Dibromofluorescein. To a suspension of 33 g. of fluorescein in 125 ml. of 80 per cent. acetic acid, warmed to 80° and stirred mechanically,

add a solution of 32 g. (10 ml.) of bromine in 100 ml. of 80 per cent. acetic acid. Continue the stirring for 2 hours at 80°, filter at the pump, and wash with alcohol, followed by ether. The product weighs 50 g., and is almost pure dibromofluorescein hydrobromide. Wash thoroughly with hot water, and thus obtain pure dibromofluorescein, m.p. 285°. The compound is a deep red, micro-crystalline powder and crystallises from 30 per cent. alcohol in red plates.

It may be converted into dibromofluorescein diacetate as follows. Reflux a mixture of 10 g. of dibromofluorescein, 40 ml. of redistilled acetic anhydride and 1 drop of concentrated sulphuric acid for 1 hour, pour into water, filter, wash, and dry: the resulting diacetate (95 per cent. yield) has m.p. 210°. Upon recrystallisation from acetic anhydride or nitrobenzene, the pure diacetate (colourless or pale yellow plates), m.p. 211°, is obtained. Hydrolysis with alcoholic sulphuric acid gives a quantitative yield of pure dibromofluorescein, m.p. 285°.

VIII.8. *pp'*-TETRAMETHYLDIAMINODIPHENYLMETHANE

This compound, also termed "tetramethyl base" is prepared by the condensation of dimethylaniline (2 mols) with formaldehyde (1.2 mols) in the presence of a little sulphanilic acid:

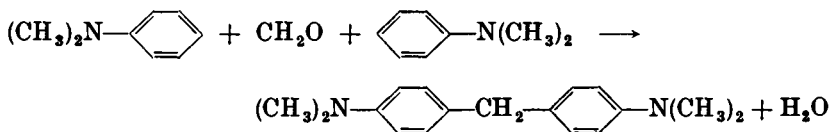

In a 500 ml. three-necked flask, fitted with a reflux condenser and mechanical stirrer, place 121 g. (126.5 ml.) of dimethylaniline, 45 g. of 40 per cent. formaldehyde solution and 0.5 g. of sulphanilic acid. Heat the mixture under reflux with vigorous stirring for 8 hours. No visible change in the reaction mixture occurs. After 8 hours, remove a test portion of the pale yellow emulsion with a pipette or dropper and allow it to cool. The oil should solidify completely and upon boiling it should not smell appreciably of dimethylaniline; if this is not the case, heat for a longer period. When the reaction is complete, steam distil (Fig. II, 41, 1) the mixture until no more formaldehyde and dimethylaniline passes over; only a few drops of dimethylaniline should distil. As soon as the distillate is free from dimethylaniline, pour the residue into excess of cold water when the base immediately solidifies. Decant the water and wash the crystalline solid thoroughly with water to remove the residual formaldehyde. Finally melt the solid under water and allow it to solidify. A hard yellowish-white crystalline cake of crude base, m.p. 80–90°, is obtained in almost quantitative yield. Recrystallise from 250 ml. of alcohol; the recovery of pure *pp'*-tetramethyldiaminodiphenylmethane, m.p. 89–90°, is about 90 per cent.

VIII.9. *o*-SULPHOBENZOIC ANHYDRIDE

Hydrolysis of saccharin (*o*-sulphobenzoic imide) (Section IV, 209) with dilute hydrochloric acid yields acid ammonium *o*-sulphobenzoate, which upon

heating with thionyl chloride in benzene solution affords *o*-sulphobenzoic anhydride :

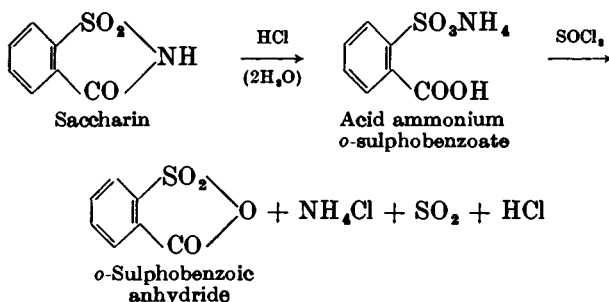

Acid ammonium *o*-sulphobenzoate. In a 1 litre three-necked flask, fitted with a mechanical stirrer and a reflux condenser, place 19 g. of *o*-sulphobenzoic imide ("saccharin insoluble"), 17 ml. of concentrated hydrochloric acid and 60 ml. of distilled water. Boil the mixture over a free flame with continual stirring until all the solid dissolves (2·5–3 hours); some foaming may occur during the first few minutes of boiling. Then add another 19 g. of *o*-sulphobenzoic imide and heat the mixture again as before until a clear solution results (about 1·5 hours). Continue the heating for a further hour, pour the solution into a 600 ml. beaker and allow to cool. Filter off the crystals which separate at the pump, wash as free as possible from hydrochloric acid with ice-cold distilled water, and dry in the air. The yield is 40 g. A further small quantity may be isolated by concentrating the mother liquor and washings on a water bath under reduced pressure. The product is sufficiently pure for conversion into *o*-sulphobenzoic anhydride. If perfectly pure acid ammonium *o*-sulphobenzoate is required, it may be recrystallised from an equal weight of distilled water.

***o*-Sulphobenzoic anhydride.** Place 40 g. of finely-powdered acid ammonium *o*-sulphobenzoate and 40 ml. of sodium-dried A.R. benzene in a dry 500 ml. three-necked flask, fitted with a separatory funnel, mechanical stirrer and double surface condenser. Add, with stirring, 64 g. (39 ml.) of redistilled thionyl chloride. Attach the upper end of the condenser by means of a bent glass tube to a gas absorption trap (Fig. II, 8, 1, c). Warm the mixture gently on a water bath, with stirring, for 3–4 hours or until the evolution of gas slackens; if the reaction becomes very vigorous, interrupt the heating for a short time. Add a further 80 ml. of sodium-dried benzene, reflux for 1 hour, and filter the hot suspension through a sintered glass funnel (*FUME CUPBOARD*: presence of thionyl chloride). Extract the solid material, consisting largely of ammonium chloride, with two 20 ml. portions of hot, dry benzene. Cool the combined filtrate and washings contained in a 250 ml. distilling flask in an ice bath; most of the sulphobenzoic anhydride crystallises out. Decant the benzene mother liquor from the crystals (1). Attach a condenser and filter flask receiver (compare Fig. II, 13, 1), distil the residual excess of solvent, and finally heat until the solid has just melted; remove any adhering solvent by *slightly* reducing the pressure. pour the clear liquid residue into a porcelain basin and allow it to cool

in a desiccator over calcium chloride. The yield of *o*-sulphobenzoic anhydride, m.p. 122–123°, is 24 g. The compound is sensitive to moist air, which converts it into the free acid; it should be kept in a desiccator or in a bottle fitted with a solid rubber stopper. The above crude product is quite satisfactory for the preparation of sulphonephthaleins. The pure compound, m.p. 128°, may be obtained by recrystallisation from dry benzene.

Note.

(1) A further small quantity may be recovered from the mother liquors by removing the solvent at atmospheric pressure and distilling the residue under reduced pressure: the anhydride passes over at 184–186°/18 mm.

VIII,10. SULPHONEPHTHALEINS

By condensing *o*-sulphobenzoic anhydride with phenol in the presence of anhydrous zinc chloride, phenolsulphonephthalein (phenol red) is formed. Tetrabromination of the latter affords tetrabromophenolsulphonephthalein (bromophenol blue):

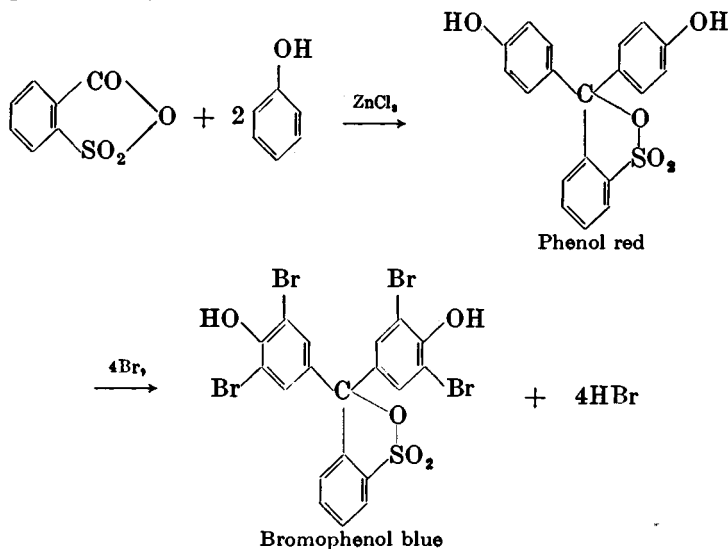

Similarly *o*-sulphobenzoic anhydride and *o*-cresol yields *o*-cresolsulphonephthalein (*o*-cresol red); dibromination of the last-named gives dibromo-*o*-sulphonephthalein (bromocresol purple):

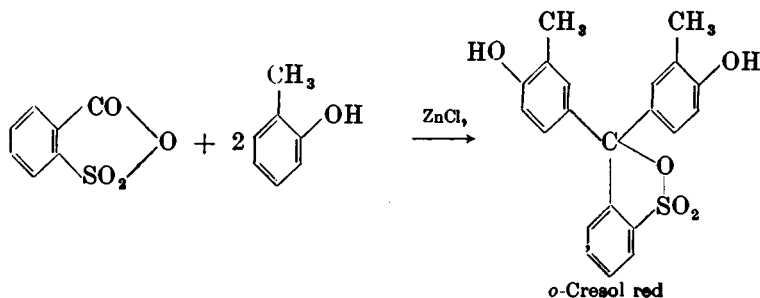

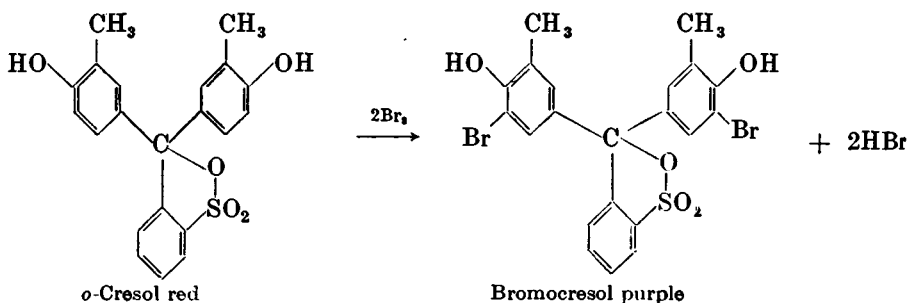

Phenolsulphonephthalein (phenol red). Mix 10 g. of *o*-sulphobenzoic anhydride (Section VIII,9), 14 g. of pure phenol and 10 g. of freshly fused zinc chloride in a small conical flask. Place a glass rod in the flask and heat gently over a flame to melt the phenol. Then heat the flask containing the well-stirred mixture in an oil bath at 135–140° for 4 hours. Stir from time to time, but more frequently during the first hour; if the mixture froths unduly, remove the flask from the bath, cool and then resume the heating. When the reaction is complete, add 50 ml. of water, allow the water to boil and stir to disintegrate the product. Filter the crude dye with suction and wash it well with hot water. Dissolve the residue in the minimum volume of warm (60°) 20 per cent. sodium hydroxide solution, filter, and just acidify the filtrate with warm dilute hydrochloric acid (1 : 1). Filter the warm solution, wash with water, and dry upon filter paper. The yield of phenol red (a brilliant red powder) is 11 g.

Tetrabromophenolsulphonephthalein (bromophenol blue). Suspend 5 g. of phenolsulphonephthalein in 40 ml. of glacial acetic acid. Heat the acid almost to boiling and add dropwise a solution of 5 ml. of bromine in 20 ml. of glacial acetic acid whilst keeping the original mixture just below the boiling point. Evolution of hydrogen bromide commences immediately the bromine is introduced. The phenolsulphonephthalein gradually dissolves and an almost colourless precipitate of the tetrabromo derivative gradually separates. Filter with suction, wash with glacial acetic acid to remove the excess of bromine, and finally with benzene. Dry upon filter paper in the air and preserve in a tightly stoppered bottle. The yield is 7.5 g. The product may be crystallised from acetone-glacial acetic acid and melts at 270–271° (decomp.).

***o*-Cresolsulphonephthalein (*o*-cresol red).** Proceed as for *Phenol Red*, but use a mixture of 10 g. of *o*-sulphobenzoic anhydride, 12 g. of pure *o*-cresol, 8 g. of freshly fused zinc chloride and heat for 4 hours at 115–120°. Add 50 ml. of water and 5 ml. of dilute hydrochloric acid (1 : 1), boil and disintegrate the melt. Filter and wash with a little warm water. Dry the residue on a water bath, powder, and triturate with a mixture of 20 ml. of benzene and 20 ml. of ether in order to remove the excess of *o*-cresol. Filter, wash with ether, and dry upon filter paper. The yield is 11 g. The compound may be recrystallised from glacial acetic acid.

Dibromo-*o*-cresolsulphonephthalein (bromocresol purple). Dissolve 5 g. of *o*-cresolsulphonephthalein in 50 ml. of glacial acetic acid, heat to boiling under reflux, add slowly a solution of 2 ml. of bromine in

20 ml. of glacial acetic acid, and boil gently for 1 hour. Allow to cool, filter off the bromocresol purple, wash with a little glacial acetic acid, followed by a little benzene, and dry. The yield is 4 g.

VIII,11. *N*-PHENYLANTHRANILIC ACID

N-Phenylanthranilic acid may be prepared by the action of aniline upon *o*-chlorobenzoic acid in the presence of anhydrous potassium carbonate and a little copper oxide :

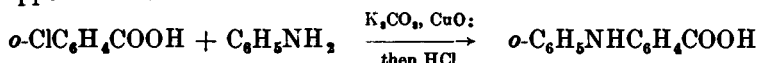

The compound is employed *inter alia* as an indicator in titrations with potassium dichromate and ceric sulphate solutions.

In a 1 litre round-bottomed flask, equipped with an air condenser, place a mixture of 44 g. of *o*-chlorobenzoic acid (Section IV,157) (1), 156 g. (153 ml.) of redistilled aniline, 41 g. of anhydrous potassium carbonate and 1 g. of cupric oxide. Reflux the mixture in an oil bath for 2 hours. Allow to cool. Remove the excess of aniline by steam distillation and add 20 g. of decolourising carbon to the brown residual solution. Boil the mixture for 15 minutes, and filter at the pump. Add the filtrate with stirring to a mixture of 30 ml. of concentrated hydrochloric acid and 60 ml. of water, and allow to cool. Filter off the precipitated acid with suction, and dry to constant weight upon filter paper in the air. The yield of *N*-phenylanthranilic acid, m.p. 181–182° (capillary tube placed in preheated bath at 170°), is 50 g. This acid is pure enough for most purposes. It may be recrystallised as follows : dissolve 5 g. of the acid in either 25 ml. of alcohol or in 10 ml. of acetic acid, and add 5 ml. of hot water ; m.p. 182–183°.

Note.

(1) Commercial *o*-chlorobenzoic acid may be purified in the following manner. Dissolve 60 g. of the technical acid in 200 ml. of hot water containing 20 g. of sodium carbonate, add 10 g. of decolourising carbon, boil for 15 minutes, and filter at the pump. Add the filtrate with stirring to 31 ml. of concentrated hydrochloric acid diluted with an equal volume of water. Collect the purified acid with suction, wash it with a little cold water, and dry at 100°.

VIII,12. 1 : 10-PHENANTHROLINE

This important oxidation-reduction indicator is readily prepared by a double Skraup reaction (compare Section V,1) upon *o*-phenylenediamine :

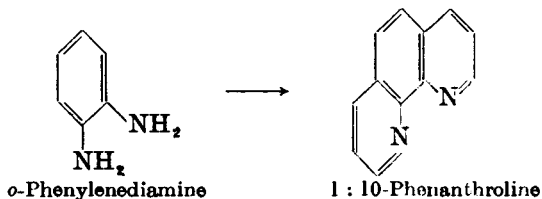

In view of the high reactivity and sensitivity to oxidation of *o*-phenylenediamine, the normal experimental conditions of the Skraup reaction are modified : the condensation is carried out in the presence of glycerol, arsenic acid solution and dilute sulphuric acid.

In a 2 litre round-bottomed flask, equipped with a reflux condenser, place 20 g. of *o*-phenylenediamine (Section IV,92), 108 g. of glycerol, 100 ml. of arsenic acid solution (1) and 400 ml. of dilute sulphuric acid (2). Reflux the mixture for 3.5 hours, and allow to cool. Transfer to a 3 litre beaker, dilute with an equal volume of water, render alkaline with concentrated ammonia solution, sp. gr. 0.88 (about 1050 ml. are required), and allow to stand overnight. Remove the tar by filtration through a fluted filter paper. Transfer the tar plus filter paper to a 500 ml. round-bottomed flask and reflux it for 20 minutes with 200 ml. of benzene. Remove the benzene layer and repeat the extraction with 100–200 ml. portions of benzene until the extracts are colourless: the total volume of benzene required is about 800 ml. Extract the dark aqueous filtrate with four or five 250 ml. portions of hot benzene. Combine all the benzene extracts in a 3 litre round-bottomed flask, and distil off the benzene on a water bath. Transfer the viscid, tarry residue to a small beaker or evaporating dish, evaporate as much benzene as possible on a water bath, and then cool in ice. The product sets to a dark solid mass of crude 1 : 10-(or *o*-)phenanthroline weighing 19 g. Reflux the crude *o*-phenanthroline for 5 minutes with 100 ml. of benzene and 2 g. of decolourising carbon, filter through a hot water funnel, and allow the benzene solution to cool. Collect the pale brown *o*-phenanthroline (4 g.) which separates, and dry it upon filter paper in the air; this is the monohydrate and melts at 108–110°. Evaporate the mother liquor to dryness and recrystallise the residue twice from 30 ml. of moist boiling benzene: a further 6 g. of pure *o*-phenanthroline monohydrate is isolated. The compound may also be recrystallised from benzene - light petroleum (b.p. 40–60°), but this medium yields a somewhat more coloured product.

Notes.

(1) The arsenic acid solution is prepared by dissolving 123 g. of arsenic pentoxide in 104 ml. of water; 100 ml. of the cold solution are used in the experiment.

(2) The dilute sulphuric acid is prepared by adding 240 ml. of concentrated sulphuric acid slowly and with stirring to 200 ml. of water; 400 ml. of the cold, diluted acid are employed in the preparation.

VIII,13.

2 : 2'-DIPYRIDYL

2-Aminopyridine (I) is converted by diazotisation in the presence of bromine and concentrated hydrobromic acid into 2-bromopyridine (II); the latter upon treatment with copper powder in the presence of *p*-cymene yields 2 : 2'-dipyridyl (III).

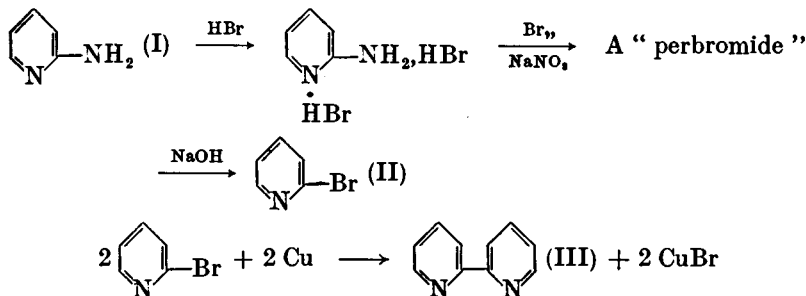

2-Bromopyridine. Place 395 ml. of 48 per cent. hydrobromic acid in a 3-litre three-necked flask, fitted with a dropping funnel, mechanical stirrer and low temperature thermometer. Cool to 10–15° in an ice-salt bath and add 75 g. of 2-aminopyridine (Section IX,10) over a period of about 10 minutes. Whilst maintaining the temperature at 0° or lower, add 375 g. (120 ml.) of bromine dropwise with stirring. The reaction mixture thickens during the addition of the first half of the bromine (*ca.* 30 minutes) owing to the formation of a yellow-orange “perbromide”; the second half may then be introduced more rapidly (*ca.* 15 minutes). Now add a solution of 140 g. of A.R. sodium nitrite in 200 ml. of water dropwise over a period of 2 hours whilst keeping the temperature at 0° or lower. Continue the stirring for 30 minutes; then run in a solution of 300 g. of sodium hydroxide in 300 ml. of water at such a rate that the temperature does not rise above 20–25°. Extract the reaction mixture with four 125 ml. portions of ether, dry the ethereal extracts for 1 hour over 50 g. of potassium hydroxide pellets, remove the ether on a steam bath, and distil the residue from a Claisen flask with fractionating side arm (Fig. II, 24, 2–5) under reduced pressure. Collect the 2-bromopyridine at 74–75°/13 mm.; the yield is 115 g. The b.p. at atmospheric pressure is 193–195°.

2-2'-Dipyridyl. In a 1-litre three-necked flask, equipped with a reflux condenser and mechanical stirrer, place 21 g. of copper powder and 200 ml. of *p*-cymene (b.p. 176–177°). Whilst refluxing the mixture gently with stirring, add 104 g. of 2-bromopyridine dropwise over a period of 1 hour; add three additional portions of 21 g. each of copper powder (through the otherwise closed third neck) during this period. Continue the heating with stirring for a further 2.5 hours, cool, acidify with dilute hydrochloric acid, and separate the *p*-cymene by steam distillation. Render the residual solution strongly alkaline with concentrated sodium hydroxide solution and steam distil again until the distillate gives only a pale red colouration with ferrous sulphate solution. Saturate the steam distillate with sodium chloride and extract repeatedly with ether; it is best to use a continuous extractor (Fig. II, 44, 2). Dry the ethereal extracts over anhydrous potassium carbonate, remove the ether by distillation through an efficient fractionating column (2:2'-dipyridyl is slightly volatile in ether vapour), and distil the residue under reduced pressure. Collect the 2:2'-dipyridyl (31.5 g.) at 147°/16 mm.; it solidifies on cooling, m.p. 69–70°.

VIII,14. NINHYDRIN (INDANE-1 : 2 : 3-TRIONE HYDRATE)

Ninhydrin (also named 1 : 2 : 3-triketoidane or 1 : 2 : 3-triketohydrindene hydrate) is prepared most simply from the inexpensive phthalic anhydride (I). The latter is condensed with acetic anhydride in the presence of potassium acetate to give phthalylacetic acid (II); reaction of the latter with sodium methoxide in methanol yields 1 : 3-indanedionecarboxylic acid, which is decomposed upon warming with dilute hydrochloric or sulphuric acid to indane-1 : 3-dione (or 1 : 3-diketohydrindene) (III). Selenium dioxide oxidation of (III) affords indane-1 : 2 : 3-trione hydrate (ninhydrin) (IV).

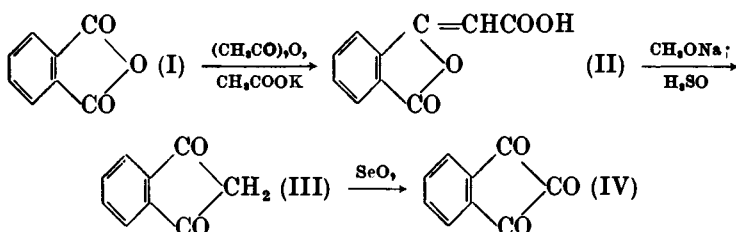

1 : 3-Indanedione (III) may also be prepared by condensation of diethyl phthalate (V) with ethyl acetate in the presence of sodium ethoxide; the resulting sodium 1 : 3-indanedione-2-carboxylic ester (VI) upon warming with sulphuric acid yields (III).

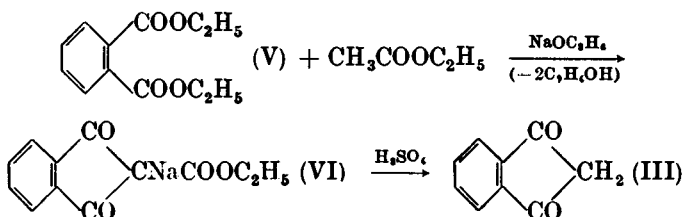

Phthalylacetic acid. Heat a mixture of 30 g. of phthalic anhydride, 40 ml. of acetic anhydride and 5 g. of potassium acetate under reflux in an oil bath at 155–165° for 15 minutes. Pour the reaction mixture into ice-cold water, collect the yellow precipitate by suction filtration, wash it three times with 25 ml. of water and once with 10 ml. of 50 per cent. ethanol. Dry the product at 100°; the yield of crude phthalylacetic acid is 20 g. Recrystallise from hot methanol; yellow needles, m.p. 245–246°, are obtained.

Indane-1 : 3-dione (1 : 3-diketohydrindene). *Method A.* To a solution of sodium methoxide, prepared from 6.1 g. of sodium and 200 ml. of anhydrous methanol, add 15 g. of phthalylacetic acid and allow to stand for 1 hour at room temperature; collect the yellow precipitate by suction filtration. Mix the yellow solid with 150 ml. of 10 per cent. sulphuric acid, heat on a steam bath until no more carbon dioxide is evolved (15–20 minutes), filter the hot solution and allow to cool. Collect the yellow crystals by filtration at the pump, wash with a little water and dry at 100°. The yield of crude 1 : 3-indanedione, m.p. 125–126°, is 7 g. Recrystallise from light petroleum, b.p. 80–100°, and thus obtain the pure product, m.p. 129–130°.

Method B. Place 125 g. (106.5 ml.) of diethyl phthalate and 25 g. of “molecular” sodium (sodium “sand”; see Section II, 50,6) in a 500 ml. round-bottomed flask fitted with a reflux condenser and dropping funnel. Heat the flask on a steam bath and add a mixture of 122.5 g. (136 ml.) of dry ethyl acetate and 2.5 ml. of absolute ethanol over a period of 90 minutes. Continue the heating for 6 hours, cool and add 50 ml. of ether. Filter the sodium salt (VI) on a sintered glass funnel and wash it with the minimum volume of ether. Dissolve the sodium salt (96 g.) in 1400 ml. of hot water in a 3-litre beaker, cool the solution to 70°, stir vigorously and add 100 ml. of sulphuric acid (3 parts of concentrated acid to 1 part of

water). Cool the mixture to 15° in an ice bath, collect the 1 : 3-indanedione by suction filtration, wash with a little water and dry at 100°; the yield is 58 g. Recrystallisation from a dioxan-benzene mixture by the addition of light petroleum (b.p. 80–100°) gives the pure compound, m.p. 130°.

Indane-1 : 2 : 3-trione hydrate (ninhydrin). In a 500 ml. three-necked flask, fitted with a reflux condenser and mechanical stirrer, place 11 g. of resublimed selenium dioxide dissolved in 240 ml. of dioxan and 5 ml. of water. Heat the stirred solution to 60–70°, remove the source of heat, add 15 g. of crude 1 : 3-indanedione and reflux the resulting mixture for 6 hours. A solid separates during this period. Filter the mixture, transfer the filtrate to a distilling flask and distil off about 180 ml. of dioxan; then add 100 ml. of water, boil the solution to coagulate the red tarry precipitate and remove it by filtration. Concentrate the filtrate to about 50 ml. and filter. Boil the filtrate with 0.2–0.3 g. of decolourising carbon, filter again, concentrate to 20–25 ml. and keep at room temperature. Collect the crystals of crude ninhydrin by suction filtration, and recrystallise from hot water with the addition of a little decolourising carbon, if necessary. The yield of colourless ninhydrin is 6 g.; the crystals turn red between 125° and 130° and melt at 242–243°.

CHAPTER IX

SOME PHYSIOLOGICALLY ACTIVE COMPOUNDS

IX.1. ASPIRIN (ACETYLSALICYLIC ACID)

Phenols, unlike amines, cannot be acetylated satisfactorily in aqueous solution: acetylation proceeds readily with acetic anhydride in the presence of a little concentrated sulphuric acid as catalyst. Salicylic acid (o-hydroxybenzoic acid) upon acetylation yields acetylsalicylic acid or aspirin:

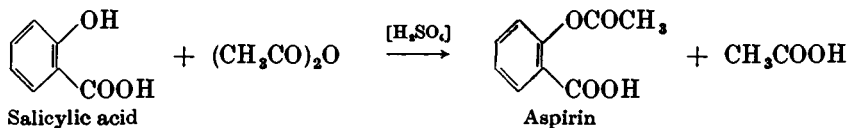

Place 10 g. of dry salicylic acid and 15 g. (14 ml.) of acetic anhydride in a small conical flask, add 5 drops of concentrated sulphuric acid, and rotate the flask in order to secure thorough mixing. Warm on a water bath to about 50–60°, stirring with the thermometer, for about 15 minutes. Allow the mixture to cool and stir occasionally. Add 150 ml. of water, stir well and filter at the pump. Recrystallise the crude acetylsalicylic acid from a mixture of equal volumes of acetic acid and water.

The following is an alternative method of purifying the crude aspirin. Dissolve the solid in about 30 ml. of hot alcohol and pour the solution into about 75 ml. of warm water: if a solid separates at this point, warm the mixture until solution is complete and then allow the clear solution to cool slowly. Beautiful needle-like crystals will separate. The yield is 13 g. The air-dried crude product may also be recrystallised from benzene or from ether - light petroleum (b.p. 40–60°).

Acetylsalicylic acid decomposes when heated and does not possess a true, clearly-defined m.p. Decomposition points ranging from 128° to 135° have been recorded; a value of 129–133° is obtained on an electric hot plate (Fig. II, II, 1). Some decomposition may occur if the compound is recrystallised from a solvent of high boiling point or if the boiling period during recrystallisation is unduly prolonged.

IX.2. PHENACETIN

Phenacetin may be conveniently prepared in the laboratory from *p*-aminophenol. The latter is readily acetylated with acetic anhydride to give *p*-acetylaminophenol; this is ethylated in the form of the sodio derivative to yield acetyl *p*-phenetidine (phenacetin):

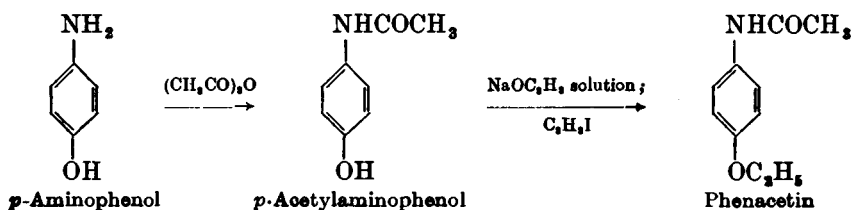

Phenacetin may also be prepared by acetylation of the commercially available *p*-phenetidine : *

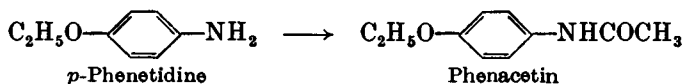

Method A

Suspend 11 g. of *p*-aminophenol in 30 ml. of water contained in a 250 ml. beaker or conical flask and add 12 ml. of acetic anhydride. Stir (or shake) the mixture vigorously and warm on a water bath. The solid dissolves. After 10 minutes, cool, filter the solid acetyl derivative at the pump and wash with a little cold water. Recrystallise from hot water (about 75 ml.) and dry upon filter paper in the air. The yield of *p*-acetylaminophenol, m.p. 169° (1), is 14 g.

Place 1.55 g. of clean sodium in a 250 ml. round-bottomed flask equipped with a reflux condenser. Add 40 ml. of absolute alcohol (or rectified spirit). If all the sodium has not disappeared after the vigorous reaction has subsided, warm the flask on a water bath until solution is complete. Cool the mixture and add 10 g. of *p*-acetylaminophenol. Introduce 15 g. (8 ml.) of ethyl iodide slowly through the condenser and reflux the mixture for 45–60 minutes. Pour 100 ml. of water through the condenser at such a rate that the crystalline product does not separate ; if crystals do separate, reflux the mixture until they dissolve. Then cool the flask in an ice bath : collect the crude phenacetin with suction and wash with a little cold water. Dissolve the crude product in 80 ml. of rectified spirit ; if the solution is coloured, add 2 g. of decolourising carbon and filter. Treat the clear solution with 125 ml. of hot water and allow to cool. Collect the pure phenacetin at the pump and dry in the air. The yield is 9.5 g., m.p. 137°.

Method B

Dissolve 14 g. of *p*-phenetidine (2) in 240 ml. of water to which 20 ml. of 5*N* hydrochloric acid (or 9 ml. of the concentrated acid) have been added ; stir the solution with about 5 g. of decolourising carbon for 5 minutes, warm, and filter the solution with suction. Transfer the cold filtered solution of *p*-phenetidine hydrochloride to a 700 ml. conical flask, add 13 g. (12 ml.) of acetic anhydride and swirl the contents to dissolve the anhydride. Immediately add a solution of 16 g. of crystallised sodium acetate in 50 ml. of water and stir (or swirl) the contents of the flask vigorously. Cool the reaction mixture in an ice bath, filter with suction and wash with cold water. Recrystallise from hot water (with the addition of a little decolourising carbon, if necessary), filter and dry. The yield of pure phenacetin, m.p. 137°, is 12 g.

Notes.

(1) If the m.p. is unsatisfactory, dissolve the product in dilute alkali in the cold and then reprecipitate it by the addition of acid to the neutralisation point. This procedure will eliminate traces of the diacetate of *p*-aminophenol which may be

* Prepared *inter alia* thus :

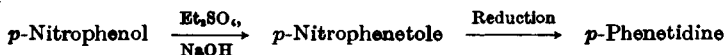

present ; the acetyl group attached to nitrogen is not affected by cold dilute alkali, but that attached to oxygen is readily hydrolysed by the reagent.

(2) The *p*-phenetidine is usually coloured and the procedure given permits a preliminary treatment with decolourising carbon, thus leading to an almost colourless phenacetin directly.

Acetylation of the amine may also be effected by boiling with 20 ml. of glacial acetic acid and 14 ml. of acetic anhydride for 15–20 minutes, followed by decomposition of the excess of anhydride with water and, after boiling for 5 minutes, pouring with stirring into about 75 ml. of water ; the product is appreciably coloured.

IX.3.

ANTIPYRIN

When ethyl acetoacetate is warmed with an equivalent quantity of phenylhydrazine, the compound (I), which is not a true hydrazone, is first formed ; this undergoes ring formation (II) with loss of ethyl alcohol upon further heating. The product (II) is *N* or 1-phenyl-3-methyl-5-pyrazolone.

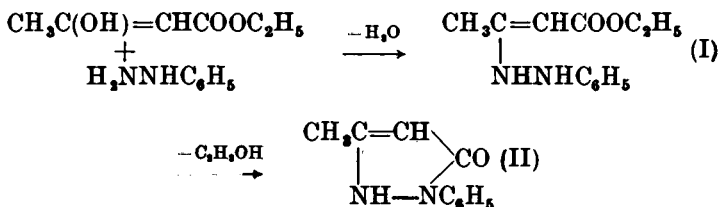

This substance may be conveniently methylated with dimethyl sulphate to yield 1-phenyl-2 : 3-dimethyl-5-pyrazolone or antipyrin (III) :

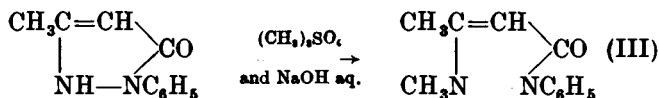

1-Phenyl-3-methyl-5-pyrazolone. Mix together 50 g. (49 ml.) of redistilled ethyl acetoacetate (Section III,151) and 40 g. (36.5 ml.) of phenylhydrazine (*CAUTION* in handling) (Section IV,89) in a large evaporating dish. Heat the mixture on a water bath in the fume cupboard for 1 hour and stir from time to time with a glass rod. Allow the heavy reddish syrup to cool somewhat, add about 100 ml. of ether and stir the mixture vigorously. The syrup, which is insoluble in ether, will solidify within 15 minutes. Filter the solid at the pump and wash it thoroughly with ether to remove coloured impurities. Recrystallise it from hot water or from a mixture of equal volumes of alcohol and water. The yield of phenylmethylpyrazolone (colourless crystals, m.p. 127°) is 52 g.

1-Phenyl-2 : 3-dimethyl-5-pyrazolone (antipyrin). In a 500 ml. three-necked flask, equipped with a dropping funnel, a mercury-sealed stirrer and a double surface condenser and set up in the fume cupboard, place a solution of 10 g. of sodium hydroxide in a small volume of water and also a solution of 43.5 g. of phenylmethylpyrazolone in 20 ml. of methyl alcohol. Warm the mixture on a water bath and add 36 g. (27 ml.) of dimethyl sulphate (*CAUTION*: toxic, see discussion prior to

Section IV,49). Reflux the mixture for 1 hour and allow to cool, with continuous stirring. Distil off the methyl alcohol. Add hot water to the residue, filter from impurities, extract the antipyrine with benzene, and evaporate the solvent. Recrystallise the crude product from benzene or benzene - light petroleum or from hot water with the addition of a little decolourising carbon. The yield of antipyrin (white crystalline solid, m.p. 113°) is 35 g.

IX.4. BROMURAL (α -BROMO-*ISO*-VALERYLUREA)

iso-Valeric acid is converted by phosphorus and bromine into α -bromo-*iso*-valeryl bromide; the latter upon heating with urea gives bromural:

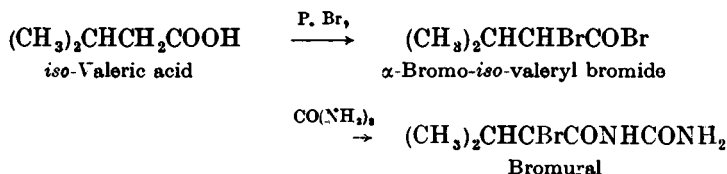

Equip a 1 litre bolt-head flask with dropping funnel and a double surface reflux condenser*; to the top of the latter attach a device (e.g., Fig. II, 8, 1, c) for the absorption of the hydrogen bromide evolved. Place 100 g. (108 ml.) of dry *iso*-valeric acid (Section III,80) and 12 g. of purified red phosphorus (Section II,50,5) in the flask. Add 255 g. (82 ml.) of dry bromine (Section II,49,8) slowly through the dropping funnel at such a rate that little or no bromine is lost with the hydrogen bromide evolved; the addition occupies 2-3 hours. Warm the reaction mixture on a water bath until the evolution of hydrogen bromide is complete and the colour of the bromine has disappeared. Pour off the liquid reaction product into a Claisen flask and distil under the reduced pressure of a water pump. Collect the α -bromo-*iso*-valeryl bromide at 117-122°/25-30 mm. The yield is 150 g.

In a 500 ml. bolt-head flask provided with a thermometer (reaching almost to the bottom) and a calcium chloride (or cotton wool) guard tube, place 100 g. of α -bromo-*iso*-valeryl bromide and 50 g. of dry, finely-divided urea. Start the reaction by warming the flask on a water bath; the temperature soon rises to about 80°. Maintain this temperature for about 3 hours; the mass will liquefy and then resolidify. Transfer the sticky reaction product to a large beaker containing saturated sodium bicarbonate solution, stir mechanically and add more saturated sodium bicarbonate solution in small quantities until effervescence ceases. Filter at the pump, suck as dry as possible and dry the crude bromural upon filter paper in the air. Recrystallise the dry product from toluene. Alternatively, recrystallise the moist product from hot water (ca. 700 ml.). The yield of pure bromural, m.p. 154-155°, is 28 g.

* It is best to employ an apparatus with ground glass joints. Failing this, an old rubber stopper or a cork covered with paraffin wax may be used.

IX.5. BENZOCAINE (ETHYL *p*-AMINOBENZOATE)

Benzocaine (or anaesthesine) is conveniently prepared from *p*-nitrobenzoic acid by either of the following methods :

(i) *p*-Nitrobenzoic acid is first reduced with tin and hydrochloric acid to *p*-aminobenzoic acid, and the latter is esterified with ethyl alcohol in the presence of hydrogen chloride :

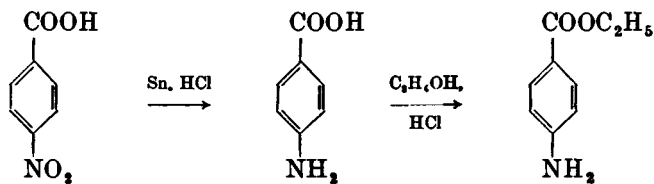

(ii) *p*-Nitrobenzoic acid is first converted into the ethyl ester and the latter is reduced with hydrogen in the presence of Adams' platinum oxide catalyst :

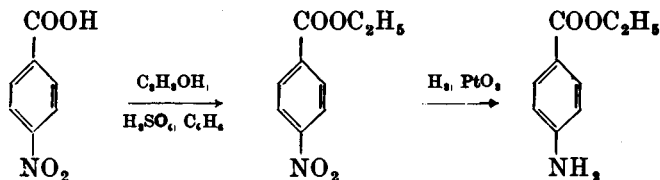

Method 1. *p*-Aminobenzoic acid. Place 15 g. of *p*-nitrobenzoic acid (Section IV,154) in a 1 litre round-bottomed flask fitted with a reflux condenser. Introduce 35 g. of powdered tin and 75 ml. of concentrated hydrochloric acid. Heat the mixture gently until the reaction commences, and remove the flame. Shake the flask frequently and take care that the insoluble acid adhering to the sides of the flask is transferred to the reaction mixture : occasional gentle warming may be necessary. After about 20 minutes, most of the tin will have reacted and a clear solution remains. Allow to cool somewhat and decant the liquid into a 1 litre beaker ; wash the residual tin by decantation with 15 ml. of water, and add the washings to the contents of the beaker. Add concentrated ammonia solution (sp. gr. 0.88) until the solution is just alkaline to litmus ; filter off the precipitate of hydrated tin oxide and wash well with water. If the total volume of the combined filtrate and washings exceeds 200 ml., evaporate in a large evaporating dish on a water bath until the volume has been reduced to 175–200 ml. : filter off any solid which separates. Acidify the liquid to litmus with glacial acetic acid and evaporate on a water bath until crystals commence to separate ; cool in ice, filter the crystals at the pump and dry in the steam oven. The yield of *p*-aminobenzoic acid, m.p. 192°, is 13 g.

Ethyl *p*-aminobenzoate (esterification of *p*-aminobenzoic acid). Place 80 ml. of absolute ethyl alcohol in a 250 ml. conical flask equipped with a two-holed cork and wash-bottle tubes. Pass dry hydrogen chloride (Section II,48,1) through the alcohol until saturated—the increase in weight is about 20 g.—and transfer the solution to a 250 ml. round-bottomed flask. Introduce 12 g. of *p*-aminobenzoic acid, fit a double surface condenser to the flask, and reflux the mixture for 2 hours. Upon

cooling, the reaction mixture sets to a solid mass of the hydrochloride of ethyl *p*-aminobenzoate. It is better, however, to pour the hot solution into excess of water (no hydrochloride separates) and add sodium carbonate to the clear solution until it is neutral to litmus. Filter off the precipitated ester at the pump and dry in the air. The yield of ethyl *p*-aminobenzoate, m.p. 91°, is 10 g. Recrystallisation from rectified (or methylated) spirit does not affect the m.p.

Method 2. Ethyl *p*-nitrobenzoate. Place 21 g. of *p*-nitrobenzoic acid (Section IV,154), 11.5 g. of absolute ethyl alcohol, 3.8 g. of concentrated sulphuric acid, and 30 ml. of sodium-dried A.R. benzene in a 250 ml. round-bottomed flask, fit a reflux condenser, and heat the mixture under reflux for 16 hours. Add 50 ml. of ether to the cold reaction mixture, wash the extract successively with sodium bicarbonate solution and water, dry with anhydrous magnesium sulphate or calcium chloride, and distil off the solvent on a water bath. Remove the last traces of benzene either by heating in an open evaporating dish on a water bath or in a bath at 100–110°. The residual ethyl *p*-nitrobenzoate (21 g.) solidifies completely on cooling and melts at 56°.

Ethyl *p*-aminobenzoate (catalytic reduction of ethyl *p*-nitrobenzoate). The general experimental details may be adapted from those described in Section III,150. Place a solution of 9.75 g. of ethyl *p*-nitrobenzoate in 100 ml. of rectified spirit together with 0.1 g. of Adams' platinum oxide catalyst in the hydrogenation bottle, and shake in hydrogen in the usual manner. The theoretical volume of hydrogen (*ca.* 3360 ml. at 24° and 760 mm.) is absorbed in 2.5 hours. Filter off the platinum through a "quantitative" filter paper with suction and rinse the reaction vessel with rectified spirit. Evaporate the alcohol from the combined filtrate and washings on a water bath; the residue solidifies on cooling and weighs 8.2 g. Dissolve the crude ethyl *p*-aminobenzoate in rectified spirit, add a little decolourising charcoal, boil and filter; heat the filtrate to the boiling point, add hot water to incipient crystallisation and allow to cool. The resulting pure benzocaine has m.p. 90°; the recovery is about 90 per cent.

IX.6.

BARBITURIC ACID

Ethyl malonate condenses with urea in the presence of sodium ethoxide to yield barbituric acid (malonylurea):

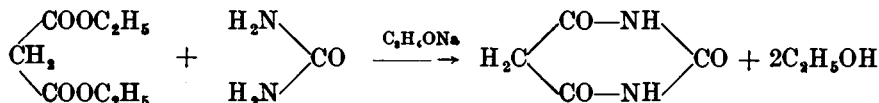

In a 2 litre round-bottomed flask, fitted with a double surface reflux condenser, place 11.5 g. of clean sodium. Add 250 ml. of absolute alcohol in one portion: if the reaction is unduly vigorous, immerse the flask momentarily in ice. When all the sodium has reacted, add 80 g. (76 ml.) of ethyl malonate (Section III,153), followed by a solution of 30 g. of dry urea in 250 ml. of hot (*ca.* 70°) absolute alcohol. Shake the mixture well, fit a calcium chloride (or cotton wool) guard tube to the top

of the condenser, and reflux the mixture for 7 hours on an oil bath heated to 110°. A white solid separates. Treat the reaction mixture with 450 ml. of hot (50°) water and then with concentrated hydrochloric acid, with stirring, until the solution is acid (about 45 ml.). Filter the resulting almost clear solution and leave it in the ice box overnight. Filter the solid at the pump, wash it with 25 ml. of cold water, drain well, and then dry at 100° for 4 hours. The yield of barbituric acid is 50 g. It melts with decomposition at 245°.

IX.7. DIETHYLBARBITURIC ACID (VERONAL)

The condensation of 1 mol of ethyl malonate with two mols of ethyl iodide in the presence of two mols of sodium ethoxide gives a good yield of ethyl diethylmalonate. Upon allowing the latter to react with the theoretical quantity of urea in the presence of an alcoholic solution of sodium ethoxide, veronal (diethylbarbituric acid or diethylmalonylurea) is produced.

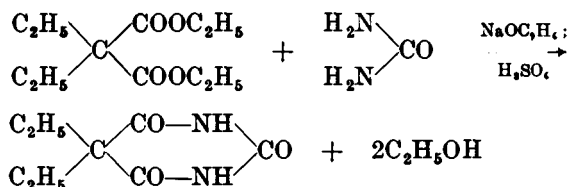
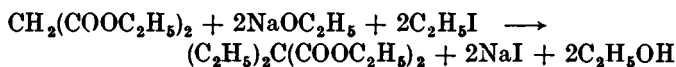

Ethyl diethylmalonate. Equip a 1 litre three-necked flask with a mercury-sealed mechanical stirrer, a dropping funnel (with calcium chloride or cotton wool guard tube) and a double surface reflux condenser; it is important that the apparatus be perfectly dry. Place 23 g. of clean sodium in the flask and add 300 ml. of "super-dry" ethyl alcohol (Section II,47,5). It may be necessary to warm the flask gently on a water bath towards the end of the reaction in order to complete the solution of the sodium. Insert a guard tube into the top of the condenser. Allow the sodium ethoxide solution to cool with stirring; when the sodium ethoxide commences to separate out, add 75 g. (71 ml.) of ethyl malonate (dried over anhydrous calcium sulphate) during 1 hour. Towards the end of the addition some solid may separate; it is then necessary to heat on a water bath to dissolve the solid. When all the ethyl malonate has been introduced, heat the mixture on a water bath for 15 minutes, and then allow to cool. When the ethyl sodiomalonate commences to crystallise out, add 156 g. (81 ml.) of dry ethyl iodide over a period of 1 hour. Heat on a water bath for 3 hours to complete the reaction. Rearrange the flask for distillation but keep the stirrer in position; distil off as much as possible of the alcohol on a water bath (it is advisable to wrap the flask in a cloth or towel). Dilute the residue in the flask with water and extract with three 75 ml. portions of ether. Wash the combined ethereal extracts with water, dry with anhydrous calcium chloride or magnesium sulphate, remove the ether on a water bath and distil the residue from a 200 ml. Claisen flask. Collect the ethyl diethylmalonate at 218–222° (mainly 221°); the yield is 84 g.

Diethylbarbituric acid. In a dry 250 ml. distilling flask, fitted with a thermometer reaching to within 3–4 cm. of the bottom and a condenser, place 5.1 g. of clean sodium and add 110 g. (140 ml.) of "super-dry" ethyl alcohol (Section II,47,5). When all the sodium has reacted, introduce 20 g. of ethyl diethylmalonate and 7.0 g. of dry urea (dried at 60° for 4 hours). Heat the flask in an oil bath and slowly distil off the ethyl alcohol. As soon as the temperature of the *liquid* reaches 110–115°, adjust the flame beneath the bath so that the contents of the flask are maintained at this temperature for at least 4 hours. Allow the flask to cool somewhat, add 100 ml. of water and warm until the solid (veronal-sodium) dissolves. Pour the solution into a beaker, and add a further 100 ml. of water but containing 7.0 ml. of concentrated sulphuric acid; this will liberate the veronal from the sodium derivative. The veronal usually crystallises out; if it does not, add a few more drops of dilute sulphuric acid until the solution is acid to Congo red. Heat the contents of the beaker, with stirring and the addition of more water if necessary, until all the veronal dissolves at the boiling point. Allow the hot solution to cool, filter off the crystals of veronal and dry in the air. The yield is 12 g., m.p. 190°.

IX,8. PHENYLETHYLBARBITURIC ACID (PHENOBARBITONE)

Phenylethylbarbituric acid (also termed luminal and phenobarbitone) may be prepared by condensing ethyl phenylethylmalonate with urea in the presence of sodium methoxide:

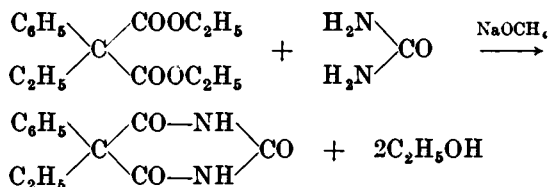

The ethyl phenylethylmalonate may be obtained from ethyl phenylacetate by the following series of reactions:

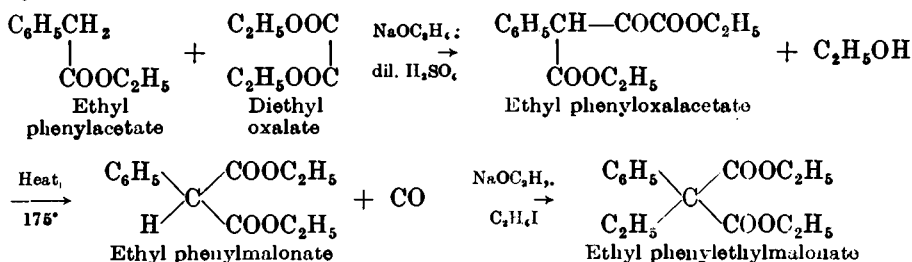

Ethyl phenylmalonate. In a 1-litre flask, equipped with a dropping funnel, mercury-sealed stirrer and reflux condenser,* place 11.5 g. of clean sodium pieces (see Section III,7, Note 1); add 250 ml. of "super-dry" ethyl alcohol (Section II,47,5) and allow the vigorous reaction to

* It is important that the apparatus be dry; calcium chloride or cotton wool guard tubes should be placed in the funnel and condenser respectively.

proceed, cooling only if the reaction appears to be beyond control. When all the sodium has reacted, cool the solution to 60° , and add 73 g. (67 ml.) of pure, freshly distilled, neutral diethyl oxalate (compare Section III, 100) from the dropping funnel in a rapid stream with vigorous stirring. Wash this down with 5 ml. of absolute ethanol and add immediately 87.5 g. (85 ml.) of pure ethyl phenylacetate (Section IV, 179). Discontinue stirring, lower the reaction flask from the stirrer and have a 1-litre beaker at hand. Within 4–7 minutes after the ethyl phenylacetate has been added, crystallisation commences; transfer the contents of the flask immediately to the beaker at the first sign of crystallisation. Allow the nearly solid paste of the sodio derivative to cool to room temperature and then stir thoroughly with 400 ml. of dry ether. Collect the solid by suction filtration and wash it repeatedly with dry ether. Transfer the solid to a beaker and liberate the ethyl phenyloxalacetate with ice-cold dilute sulphuric acid (14–15 ml. of concentrated sulphuric acid in 250 ml. of water). Separate the almost colourless oil and extract the aqueous layer with three 50 ml. portions of ether; dry the combined oil and ethereal extracts with anhydrous magnesium sulphate, remove the ether on a steam bath by "flash distillation" (compare Fig. II, 13, 4) from a modified Claisen flask with fractionating side arm. Heat the flask under a pressure of about 15 mm. of mercury (water pump) in an oil or Wood's metal bath. Raise the temperature of the bath gradually to 175° and maintain this temperature until the evolution of carbon monoxide is complete (*FUME CUPBOARD!*); if the pressure rises unduly during the heating (owing to a rather rapid evolution of gas), discontinue the heating momentarily. When the reaction is complete (5–6 hours), return the oil which has passed over to the flask, and distil under reduced pressure. Collect the ethyl phenylmalonate at $159\text{--}161^{\circ}/10$ mm. (or at $165\text{--}166^{\circ}/15$ mm.). The yield is 95 g.

Ethyl phenylethylmalonate. In a dry 500 ml. round-bottomed flask, fitted with a reflux condenser and guard tube, prepare a solution of sodium ethoxide from 7.0 g. of clean sodium and 150 ml. of "super dry" ethyl alcohol in the usual manner; add 1.5 ml. of pure ethyl acetate (dried over anhydrous calcium sulphate) to the solution at 60° and maintain this temperature for 30 minutes. Meanwhile equip a 1 litre three-necked flask with a dropping funnel, a mercury-sealed mechanical stirrer and a double surface reflux condenser: *the apparatus must be perfectly dry* and guard tubes should be inserted in the funnel and condenser respectively. Place a mixture of 74 g. of ethyl phenylmalonate and 60 g. of ethyl iodide in the flask. Heat the apparatus in a bath at 80° and add the sodium ethoxide solution, with stirring, at such a rate that a drop of the reaction mixture when mixed with a drop of phenolphthalein indicator is never more than faintly pink. The addition occupies 2–2.5 hours; continue the stirring for a further 1 hour at 80° . Allow the flask to cool, equip it for distillation under reduced pressure (water pump) and distil off the alcohol. Add 100 ml. of water to the residue in the flask and extract the ester with three 100 ml. portions of benzene. Dry the combined extracts with anhydrous magnesium sulphate, distil off the benzene at atmospheric pressure and the residue under diminished pressure. Collect the ethyl phenylethylmalonate at $159\text{--}160^{\circ}/8$ mm. The yield is 72 g.

Phenylethylbarbituric acid. In a 250 ml. round-bottomed flask, fitted with an efficient reflux condenser and guard tube, prepare a solution of sodium methoxide from 4.6 g. of clean sodium and 50 ml. of "super dry" methyl alcohol (Section II,47,6). Add 15 g. of urea (previously dried at 60° for 4 hours), and insert a separatory funnel, charged with 26.4 g. of ethyl phenylethylmalonate, into the top of the condenser by means of a grooved cork. Add the ester dropwise, and then reflux the mixture for 6 hours. Remove the excess of methyl alcohol under reduced pressure (do not allow the temperature of the external water bath to rise above 60°), transfer the residue to a small beaker cooled in a freezing mixture and add 100 ml. of ice-water with mechanical stirring: the temperature of the reaction mixture must be kept below 5° since barbiturates are decomposed by concentrated alkali into the salt of the corresponding malonic acid, sodium carbonate and ammonia. Filter and extract the filtrate with two 50 ml. portions of benzene in order to remove esters; acidify the aqueous solution cautiously to Congo red, allow to stand for a few hours, and filter off the crude phenobarbitone at the pump. The yield after drying at 90–100° is 13 g. Recrystallisation from hot water yields reasonably pure phenylethylbarbituric acid, m.p. 171°. A somewhat higher m.p. (175–176°) is obtained if rectified spirit is employed for recrystallisation, but the recovery is considerably less.

IX.9. *p*-AMINO BENZENESULPHONAMIDE (SULPHANILAMIDE)

The synthesis of this important compound may be accomplished by the following series of reactions:

(i) Treatment of acetanilide with excess of chlorosulphonic acid affords *p*-acetamidobenzenesulphonyl chloride—a solid, m.p. 149°:

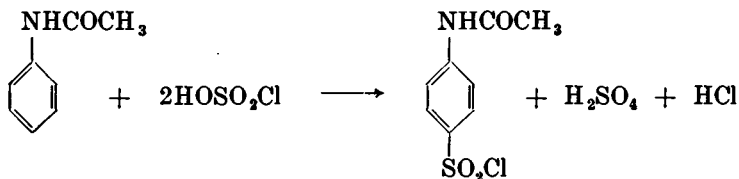

(ii) This is converted by aqueous ammonia into *p*-acetamidobenzenesulphonamide—the pure compound has m.p. 218°.

(iii) By boiling with dilute hydrochloric acid the protecting acetyl group is removed without hydrolysing the sulphonamido group. The liberated sulphonamide passes into solution as the hydrochloride, and the free base (*p*-aminobenzenesulphonamide) is obtained by neutralisation with sodium bicarbonate or aqueous ammonia.

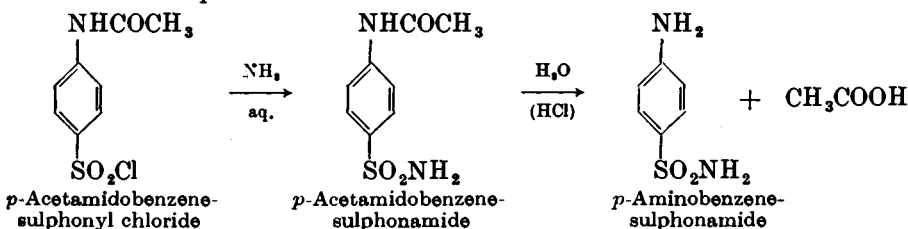

***p*-Acetamidobenzenesulphonyl chloride.** Equip a 500 ml. bolt-head flask with a two-holed cork carrying a dropping funnel and a reflux condenser : attach the top of the latter to a device for the absorption of hydrogen chloride (*e.g.*, Fig. II, 8, 1, *c*). Place 20 g. of dry acetanilide in the flask and 50 ml. (90 g.) of a good grade of chlorosulphonic acid {*CAUTION*; (1)} in the dropping funnel and insert a calcium chloride guard tube into the latter. Add the chlorosulphonic acid in small portions and shake the flask from time to time to ensure thorough mixing (2). When the addition has been made, heat the reaction mixture on a water bath for 1 hour in order to complete the reaction. Allow to cool and pour the oily mixture in a thin stream with stirring into 300 g. of crushed ice (or ice water) contained in a 1 litre beaker. Carry out this operation carefully in the fume cupboard since the excess of chlorosulphonic acid reacts vigorously with the water. Rinse the flask with a little ice water and add the rinsings to the contents of the beaker. Break up any lumps of solid material and stir the mixture for several minutes in order to obtain an even suspension of the granular white solid. Filter off the *p*-acetamidobenzenesulphonyl chloride at the pump and wash it with a little cold water ; press and drain well. *Use the crude product* (3) *immediately in the next stage.*

***p*-Acetamidobenzenesulphonamide.** Transfer the crude *p*-acetamidobenzenesulphonyl chloride to the rinsed reaction flask, and add a mixture of 70 ml. of concentrated ammonia solution (sp. gr. 0.88) and 70 ml. of water. Mix the contents of the flask thoroughly, and heat the mixture with occasional swirling (*FUME CUPBOARD*) to just below the boiling point for about 15 minutes. The sulphonyl chloride will be converted into a pasty suspension of the corresponding sulphonamide. Cool the suspension in ice, and then add dilute sulphuric acid until the mixture is just acid to Congo red paper. Collect the product on a Buchner funnel, wash with a little cold water, and drain as completely as possible. It is desirable, but not essential, to dry the crude *p*-acetamidobenzene-sulphonamide at 100° : the yield is about 18 g. The material is sufficiently pure (4) for the next stage.

***p*-Aminobenzenesulphonamide.** Transfer the crude *p*-acetamidobenzenesulphonamide to a 500 ml. flask, add 10 ml. of concentrated hydrochloric acid and 30 ml. of water. Boil the mixture gently under reflux for 30–45 minutes. The solution, when cooled to room temperature should deposit no solid amide ; if a solid separates, heat for a further short period. Treat the cooled solution with 2 g. of decolourising carbon, heat the mixture to boiling, and filter with suction through a hardened filter paper. Place the filtrate (a solution of sulphanilamide hydrochloride) in a litre beaker and cautiously add 16 g. of solid sodium bicarbonate in portions with stirring. After the evolution of gas has subsided, test the suspension with litmus paper and if it is still acid, add more sodium bicarbonate until neutral. Cool in ice, filter off the sulphanilamide with suction, and dry. The yield is 15 g., m.p. 161–163°. A pure product, m.p. 163–164°, may be obtained by recrystallisation from water or from alcohol.

Notes.

(1) *Chlorosulphonic acid* must be handled with great care : it is very corrosive to the skin and to clothing, and reacts with water with great violence. If the

specimen is impure or discoloured, it should be redistilled in an all-glass apparatus and the fraction, b.p. 148–150°, collected: due precautions should be taken to protect the distillate from moisture.

(2) The reaction may be more easily controlled and the chlorosulphonic acid added all at once if the acetanilide is employed in the form of a hard cake. The latter is prepared by melting the acetanilide in the flask over a free flame and causing the compound to solidify over the lower part of the flask by swirling the liquid. If the reaction becomes too vigorous under these conditions, cool the flask momentarily by immersion in an ice bath.

(3) The crude sulphonyl chloride, even if dry, cannot be kept without considerable decomposition. It may be purified by dissolving it in a mixture of equal volumes of benzene and acetone, separating the water, and allowing the solvent to evaporate until crystallisation occurs: the recrystallised substance may be preserved for long periods.

An alternative method of purification consists in dissolving the crude sulphonyl chloride in the minimum volume of boiling chloroform, transferring rapidly to a warm separatory funnel, and separating the lower chloroform layer; upon cooling the chloroform solution, the crystalline sulphonyl chloride separates, and is collected by filtration with suction. A further quantity is obtained by concentrating the mother liquor.

(4) A small portion may be recrystallised from water, with the addition of a little decolourising carbon if necessary. The pure compound has m.p. 218°.

IX.10. 2-(*p*-AMINOBENZENESULPHONAMIDO)PYRIDINE (SULPHAPYRIDINE)

The important drug sulphapyridine (or M. & B. 693 or 2-sulphanilylaminopyridine) may be readily synthesised from 2-aminopyridine and *p*-acetamidobenzene sulphonyl chloride (Section IX,9) as follows:

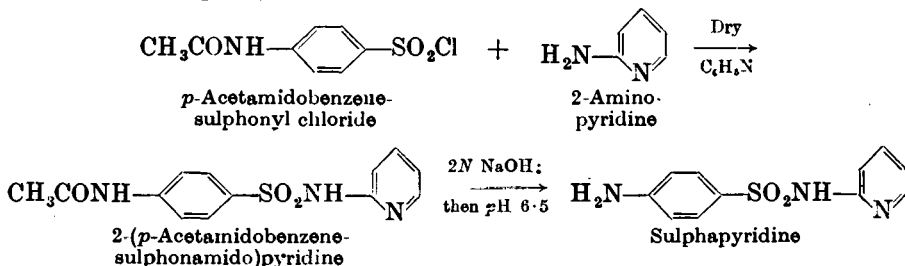

The 2-aminopyridine is prepared by adding pure, dry pyridine to sodamide in dry toluene at 110°:

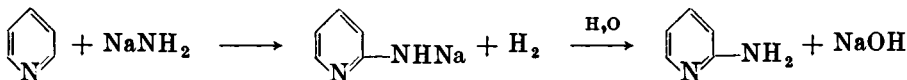

It has been stated (Tschitschibabin, 1914) that the addition of a little dry ethyl acetate helps the reaction.

2-Aminopyridine. In a 1 litre three-necked flask, equipped with a sealed mechanical stirrer, reflux condenser, thermometer and inlet tube for nitrogen, place 300 ml. of dry toluene (1) and 75 g. of fine granular sodamide (2); bubble a steady stream of nitrogen through the toluene. Stir the mixture vigorously and heat the flask in an oil bath until the internal temperature is 110° (the bath temperature required is approximately 130°). Add 100 g. of pure dry pyridine (compare Section II,47,22)

dropwise through the condenser over a period of 4 hours : maintain the very efficient stirring and the stream of nitrogen. After 1 hour the reaction mixture becomes black in colour, and after 3 hours becomes viscous, and bubbling and slight frothing occur, due to liberation of hydrogen. When all the pyridine has been introduced, continue the heating for a further 5 hours whilst maintaining the internal temperature at 110°. Towards the end of the reaction, stirring may become difficult owing to the separation of a solid or viscous cake. Allow the reaction mixture to cool (without the stream of nitrogen and without stirring); then introduce 175 ml. of water very slowly through the condenser over a period of 2 hours whilst continuing the passage of the stream of nitrogen. During the addition the temperature rises to about 50°; resume the stirring as soon as possible. Transfer the contents of the flask to a separatory funnel, separate the lower aqueous solution and extract it with two 150 ml. portions of toluene. Dry the combined main toluene layer and toluene extracts over anhydrous potassium carbonate for 2 hours; filter and remove the toluene by distillation. Distil the syrupy residue from an oil bath under diminished pressure through an air condenser: adjust the bath temperature to 120–130°. Collect the 2-aminopyridine at 95°/10 mm.; this solidifies on cooling to a colourless solid, m.p. 55° (3). The yield is about 80 g.

Sulphapyridine. Dissolve 18.8 g. of 2-aminopyridine in 40 ml. of dry pyridine (Section II,47,22) in a 250 ml. flask and add 48.0 g. of *p*-acetamidobenzenesulphonyl chloride (4); the temperature rises to about 70°. Cool, add excess of water, filter the precipitated 2-(*p*-acetamidobenzenesulphonamido)pyridine (\equiv acetyl-sulphapyridine) at the pump and recrystallise it from 50 per cent. acetic acid. The yield of pure product, m.p. 224°, is 46.5 g.

Hydrolyse the acetyl-sulphapyridine by boiling it with 10 parts of 2*N* sodium hydroxide for 1 hour, and allow to cool. Precipitate the base by the addition of 50 per cent. acetic acid until the mixture is just acid to litmus (*pH* about 6.5); avoid a large excess of acid. Filter off the crude sulphapyridine, wash well with water, and dry at 90° to constant weight (about 12 hours; any acetate formed will be decomposed). The yield is 35 g. Recrystallise from 90 per cent. acetone (5); the recovery of the pure compound, m.p. 190–191°, is about 80 per cent.

Notes.

(1) Technically pure toluene can be conveniently dried by distilling 350 ml. from a litre flask and rejecting the first 50 ml.

(2) It is important to use recently-prepared pure sodamide, which must be of fine granular form. Old material of irregular lumpy form, even if ground gives poor results, and should not be employed. The sodamide may be prepared as detailed in Section II,50,8. A satisfactory grade is marketed by May and Baker Ltd.

(3) The residue in the flask is said to contain 4-amino- and 2 : 6-diamino-pyridine, $\gamma\gamma$ -dipyridyl and $\alpha\alpha'$ -dipyridylamine in varying amounts.

(4) The *p*-acetamidobenzenesulphonyl chloride (Section IX,9) must be pure: under no circumstances should it contain more than 1–2 per cent. of the corresponding sulphonic acid. This may be ensured by lixiviating the sulphonyl chloride with pure anhydrous acetone and filtering the solution from the acid.

(5) An alternative method of purification, well adapted for large scale practice, is as follows. Dissolve the crude sulphapyridine in 1.05 mols of 30 per cent. *w/v* sodium hydroxide, salt out the sodium derivative with excess of sodium chloride,

cool and filter. Dissolve in the minimum volume of hot water, treat with about 0.5 per cent. by weight of decolourising carbon, filter, precipitate the base with 50 per cent. acetic acid until just acid to litmus (avoid an excess of acid), filter off the sulphapyridine at the pump, wash thoroughly with hot water, and dry to constant weight at 90° (about 12 hours). Alternatively, the cold solution of the sodium salt may be just acidified with dilute hydrochloric acid with very vigorous stirring: the presence of a local excess of acid must be avoided since sulphapyridine is hydrolysed by mineral acids to sulphanilic acid and 2-aminopyridine.

IX.11. SULPHAGUANIDINE

p-Aminobenzenesulphonylguanidine (sulphanilylguanidine or sulphaguandine) is an important chemotherapeutic reagent and its structure (IV) follows from its preparation by the condensation of *p*-acetamidobenzenesulphonyl chloride (I) with guanidine (II), followed by the hydrolysis of the *p*-acetamidobenzenesulphonylguanidine (III) at the acetamido group:

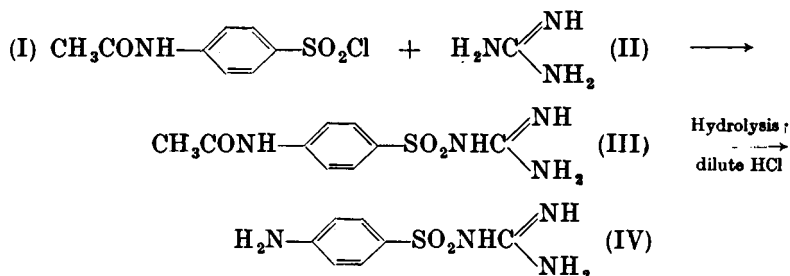

It is conveniently prepared in the laboratory by the interaction of sulphanilamide and guanidine (from guanidine nitrate and sodium methoxide solution); the resulting guanidine salt of sulphanilamide decomposes upon heating at 150–160° into sulphaguandine and ammonia:

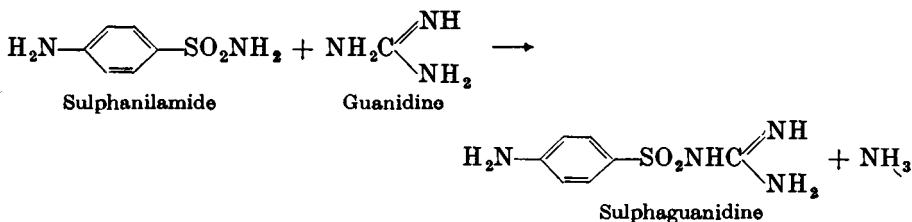

In a 500 ml. three-necked flask, equipped with a thermometer, mechanical stirrer and efficient reflux condenser, dissolve 16 g. of sodium hydroxide pellets in 95 ml. of hot methyl alcohol. Add 49 g. of guanidine nitrate, stir the mixture at 50–65° for 15 minutes, and then cool to about 20°. Filter off the separated sodium nitrate and wash with two 12 ml. portions of methyl alcohol. Return the combined filtrates to the clean reaction flask, add 69 g. of sulphanilamide (Section IX,9) and stir at 50–55° for 15 minutes. Detach the reflux condenser and, with the aid of a still-head (“knee-tube”), arrange the apparatus for distillation from an oil bath with stirring; about 100 ml. of methyl alcohol are recovered. Add 12 g. of pure cyclohexanol. Raise the temperature of the oil bath to 180–190° and continue the distillation. Reaction commences with the evolution of ammonia when the internal temperature reaches 145°. Maintain the

internal temperature at 150–160° for 2 hours. Pour the warm reaction mixture into 450 ml. of 1.5*N* hydrochloric acid and stir until all the solid passes into solution; precipitate the sulphanilylguanidine by the gradual addition, with stirring, of sodium hydroxide solution until alkaline. After cooling, filter the crude sulphaguanidine at the pump, recrystallise it from 400 ml. of hot water, and dry. The yield of sulphanilylguanidine, m.p. 189–190°, is 54 g.

IX.12. 2-PHENYLQUINOLINE-4-CARBOXYLIC ACID (ATOPHAN)

Atophan (or cinchophen) may be prepared by condensing equimolecular proportions of benzaldehyde, aniline and pyruvic acid in alcoholic solution:

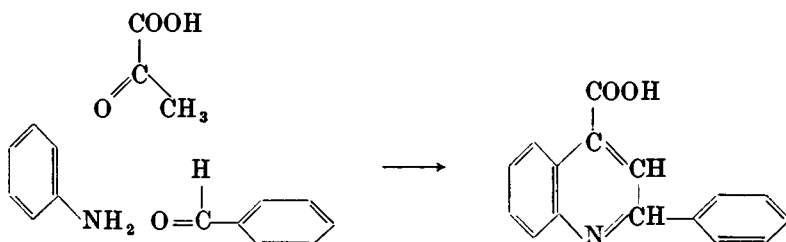

This is an example of the Doebner synthesis of quinoline-4-carboxylic acids (cinchoninic acids); the reaction consists in the condensation of an aromatic amine with pyruvic acid and an aldehyde. The *mechanism* is probably similar to that given for the Doebner-Miller synthesis of quinaldine (Section V,2), involving the intermediate formation of a dihydroquinoline derivative, which is subsequently dehydrogenated by the Schiff's base derived from the aromatic amine and aldehyde.

Pyruvic acid is conveniently prepared by the distillation of tartaric acid with a dehydrating agent, such as potassium bisulphate:

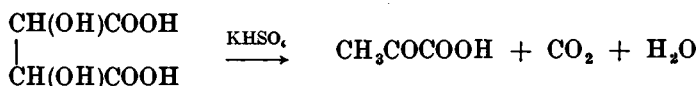

The reaction probably proceeds through oxalacetic acid as an intermediate:

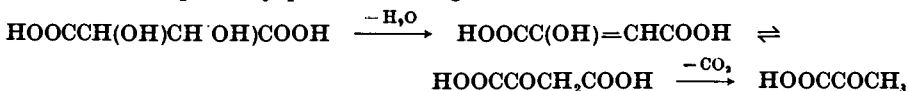

Pyruvic acid. Grind together in a glass mortar 200 g. of powdered tartaric acid and 300 g. of freshly fused potassium bisulphate to form an intimate mixture. Place the mixture in a 1500 ml. round-bottomed flask; connect the latter with a Liebig's condenser which is filled with water, but does not have any water flowing through it. Heat the flask in an oil bath maintained at 210–220° until liquid no longer distils over. If the foaming is considerable and there is danger of the mixture frothing over, heat the upper part of the flask with a free flame. Fractionate the distillate under reduced pressure and collect the pyruvic acid at 75–80°/25 mm. The yield is 60 g.

Atophan. In a 1 litre round-bottomed flask, equipped with a reflux condenser, place 25 g. (24 ml.) of purified benzaldehyde (Section IV,115), 22 g. of freshly-distilled pyruvic acid and 200 ml. of absolute ethyl alcohol. Heat the mixture to the boiling point on a water bath and add slowly, with frequent shaking, a solution of 23 g. (22.5 ml.) of pure aniline in 100 ml. of absolute ethyl alcohol. The addition usually occupies about 1 hour. Reflux the mixture on a water bath for 3 hours, and allow to stand overnight. Filter off the crude atophan (1) at the pump and wash the crystals with a little ether. Recrystallise from ethyl alcohol (about 20 ml. per gram). The yield of pure 2-phenylquinoline-4-carboxylic acid, m.p. 210° , is 30 g.

Note.

(1) If the atophan does not crystallise—this is rarely the case unless pyruvic acid which has been standing for some time is employed—pour the reaction mixture into a solution of 25 g. of potassium hydroxide in 1 litre of water, and extract the resulting solution two or three times with ether. Place the ether extracts in the *ETHER RESIDUES* bottle. Treat the aqueous layer with 70 ml. of glacial acetic acid with vigorous stirring. Allow to stand for several hours and collect the crude atophan by filtration with suction.

IX,13. 2 : 2-bis(p-CHLOROPHENYL)-1 : 1 : 1-TRICHLOROETHANE (D.D.T.)

The name D.D.T. is derived from *dichlorodiphenyltrichloroethane*: this is a misnomer since the name represents 27 different compounds. As commonly employed it refers to 2 : 2-bis(*p*-chlorophenyl)-1 : 1 : 1-trichloroethane. It is conveniently prepared by the condensation of chlorobenzene and chloral hydrate in the presence of concentrated sulphuric acid :

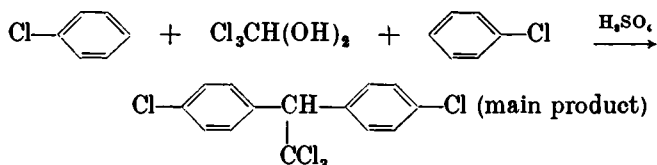

Method 1

In a 1 litre three-necked flask, equipped with a thermometer, glycerine-sealed mechanical stirrer (compare Fig. II, 7, 10) and calcium chloride (or cotton wool) guard tube, introduce successively 700 g. (380 ml.) of concentrated sulphuric acid, 100 g. (53 ml.) of oleum (20 per cent. SO_3), 90 g. (81.5 ml.) of chlorobenzene and 68 g. of chloral hydrate. Stir the mixture rapidly enough to keep the materials well mixed for 1 hour : during this period the temperature rises to about 50° and some granular D.D.T. separates. Stir the mixture for a further 1 hour in order to complete the reaction. Pour the reaction mixture with stirring into 3 litres of a 2 : 1 mixture of ice and water. Filter the precipitated somewhat sticky solid at the pump and wash it well with cold water. Remove the occluded acid by transferring the crude product to a beaker containing 1 litre of boiling water and stirring well : this causes the D.D.T. to melt. Decant the aqueous layer, and repeat the washing with two further

Dimethylaminomethylindole (gramine). Cool 42.5 ml. of aqueous methylamine solution (5.2*N*; ca. 25 per cent. w/v) contained in an 100 ml. flask in an ice bath, add 30 g. of cold acetic acid, followed by 17.2 g. of cold, 37 per cent. aqueous formaldehyde solution. Pour the solution on to 23.4 g. of indole; use 10 ml. of water to rinse out the flask. Allow the mixture to warm up to room temperature, with occasional shaking as the indole dissolves. Keep the solution at 30–40° overnight and then pour it, with vigorous stirring, into a solution of 40 g. of potassium hydroxide in 300 ml. of water; crystals separate. Cool in an ice bath for 2 hours, collect the crystalline solid by suction filtration, wash with three 50 ml. portions of cold water, and dry to constant weight at 50°. The yield of gramine is 34 g.; this is quite suitable for conversion into 3-indoleacetic acid. The pure compound may be obtained by recrystallisation from acetone-hexane; m.p. 133–134°.

3-Indoleacetic acid In a 1-litre flask, fitted with a reflux condenser, place a solution of 35.2 g. of sodium cyanide in 70 ml. of water, then add 25 g. of gramine and 280 ml. of 95 per cent. ethanol. Reflux the mixture (steam bath) for 80 hours. Dilute the cooled reaction mixture with 35 ml. of water, shake with a little activated charcoal (e.g., Norit), filter and concentrate to about 350 ml. under reduced pressure (water pump) in order to remove most of the alcohol. Cool to about 5°, filter off the solid and wash it with a little cold water; keep the filtrate (A). Recrystallise the solid from alcohol-ether to give 5.0 g. of 3-indoleacetamide, m.p. 150–151°.

Cool the filtrate (A) to 5–10° and add concentrated hydrochloric acid dropwise and with vigorous stirring (*FUME CUPBOARD*: hydrogen cyanide is evolved) to a pH of 1–2 (about 50 ml.); a crude, slightly pink 3-indoleacetic acid is precipitated. The yield of crude acid, m.p. 159–161°, is 20 g. Recrystallise from ethylene dichloride containing a small amount of ethanol; 17.5 g. of pure 3-indoleacetic acid, m.p. 167–168°, are obtained.

Hydrolyse the 5 g. of 3-indoleacetamide by heating it under reflux for 4 hours with a solution of 6 g. of sodium hydroxide in 40 ml. of water. Cool to 5°, treat with decolourising carbon (if necessary), filter, render strongly acid with concentrated hydrochloric acid (pH about 1.5). Collect the acid which precipitates and dry it at 70°; the crude acid weighs 4.5 g. Purify as above.

CHAPTER X

SYNTHETIC POLYMERS

X.1. BRIEF INTRODUCTION TO SUBJECT

Polymerisation involves the chemical combination of a number of identical or similar molecules to form a complex molecule. The resulting polymer has a high molecular weight. The term **synthetic polymer** is usually employed to denote these compounds of very high molecular weight.

Compounds which polymerise include :

1. Those which contain a reactive multiple bond (C=C, C≡C, C=O, etc.).
2. Polyfunctional molecules (glycols, dibasic acids, hydroxy acids, diamides, etc.).
3. Cyclic compounds capable of undergoing ring opening (alkylene oxides, lactones, lactams, anhydrides, etc.).

Polymers can be classified as addition polymers and condensation polymers. *Addition polymers* are formed by intermolecular reactions of the monomeric units without the elimination of atoms or groups. An example is vinyl chloride, which can be made to combine with itself to yield polyvinyl chloride :

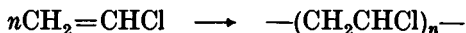

The terminal valencies of the chain are saturated by univalent groups such as hydrogen, halogen, hydroxyl, etc., or an organic fragment derived from the polymerisation catalyst. *Copolymers* are obtained by addition polymerisation of a mixture of two different monomers, for example, butadiene and styrene. The properties of the product depend upon the proportions of the two monomers and upon the average molecular weight of the copolymer. *Condensation polymers* are produced by reactions which are attended by the elimination of some simple molecule (*e.g.*, water, alcohol or ammonia) between functional groups : such reactions are esterification, anhydride formation, amide formation, aldol condensation, and the like. Only a very limited number of examples can, of necessity, be given in this volume.

In practice, synthetic polymers are sometimes divided into two classes, *thermo-setting* and *thermo-plastic*. Those polymers which in their original condition will flow and can be moulded by heat and pressure, but which in their finished or "cured" state cannot be re-softened or moulded are known as thermo-setting (examples: phenol formaldehyde or urea formaldehyde polymer). Thermoplastic polymers can be resoftened and remoulded by heat (examples : ethylene polymers and polymers of acrylic esters).

ADDITION POLYMERS

Many of the compounds which undergo addition polymerisation may be represented by the general formula $\text{CH}_2=\text{CR}-\text{X}$, for example, ethylene (R = H, X = H), *isobutylene* (R = CH₃, X = CH₃), vinyl chloride (R = H, X = Cl), vinylidene chloride (R = Cl, X = Cl), vinyl acetate (R = H, X = OCOCH₃), methyl acrylate (R = CH₃, X = COOCH₃), and styrene (R = H, X = C₆H₅). At least three types

of polymeric structures may result from the polymerisation of unsymmetrical compounds $\text{CH}_2=\text{CRX}$, depending upon the arrangement of structural units in the chain :

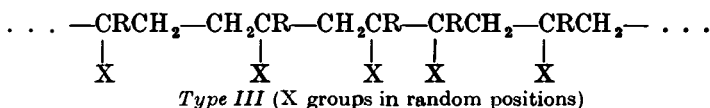
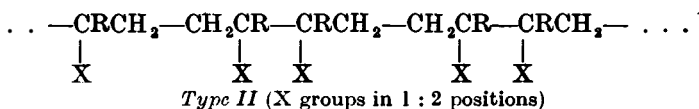
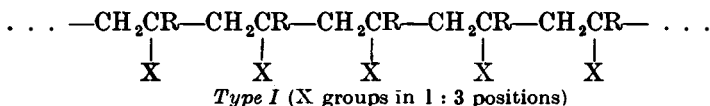

The structure of the linear polymer formed under a particular set of experimental conditions can be formulated in a number of cases after a detailed examination of its properties.

Examples of addition polymers include :

Ethylene. Under the influence of pressure and a catalyst, ethylene yields a white, tough but flexible waxy solid, known as *Polythene*. Polyethylene possesses excellent electrical insulation properties and high water resistance ; it has a low specific gravity and a low softening point (about 110°). The chemical inertness of *Polythene* has found application in the manufacture of many items of apparatus for the laboratory. It is a useful lubricant for ground glass connexions, particularly at relatively high temperatures.

Tetrafluoroethylene. Emulsion polymerisation of tetrafluoroethylene, catalysed by oxygen, yields polytetrafluoroethylene (*Teflon*) as a very tough horn-like material of high melting point. It possesses excellent electrical insulation properties and a remarkable inertness towards all chemical reagents, including aqua regia.

Styrene. Styrene is readily polymerised to a glass-clear resin, polystyrene, but the exact nature of the polymer is influenced by the nature of the catalyst, the temperature, solvent, etc.

Styrene (or vinylbenzene) is prepared technically by the "cracking dehydrogenation" of ethylbenzene :

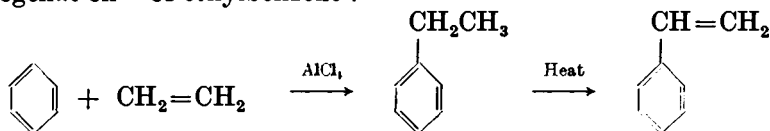

Polystyrene may be represented as :

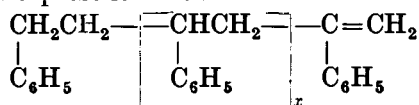

Vinyl compounds. Vinyl chloride (prepared from acetylene and hydrogen chloride) yields polyvinyl chloride (*P.V.C.*), which is employed as a rubber substitute and for other purposes. Vinyl acetate (from

acetylene and acetic acid) similarly gives polyvinyl acetate. Vinylidene chloride $\text{CH}_2=\text{CCl}_2$ affords polyvinylidene chloride.

Acrylic acid derivatives. Acrylic esters polymerise readily under the influence of oxygen, peroxides, light or heat to give colourless, glass-like plastics.

Methyl acrylate is usually prepared from ethylene chlorohydrin thus :

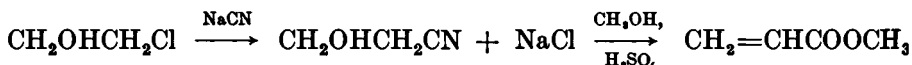

Methyl methacrylate is obtained commercially from acetone cyanohydrin :

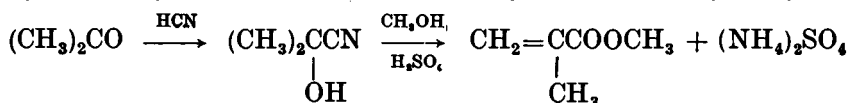

The action of sulphuric acid alone upon acetone cyanohydrin affords α -methylacrylic acid. The methyl methacrylate polymers are the nearest approach to an organic glass so far developed, and are marketed as *Perspex* (sheet or rod) or *Diakon* (powder) in Great Britain and as *Plexiglass* and *Lucite* in the U.S.A. They are readily depolymerised to the monomers upon distillation. The constitution of methyl methacrylate polymer has been given as :

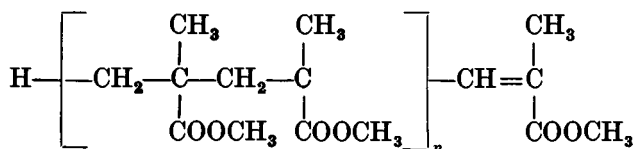

COPOLYMERS

Emulsion polymerisation of a mixture of butadiene and styrene gives a synthetic rubber (*Buna S* ; *GBS rubber*), which is used either alone or blended with natural rubber for automobile tyres and a variety of other articles.

A mixed polymer of butadiene and acrylonitrile (*Perbunan*, *Hycar*, *Chemigum*) may be vulcanised like rubber and possesses good resistance to oils and solvents in general.

Copolymerisation of vinyl acetate and vinyl chloride yields resins of desirable properties : they are strong and adhesive, thermoplastic, and are suitable for the manufacture of synthetic fibre (*Vinyon*).

Vinylidene chloride and vinyl chloride lead to the copolymer known as *Saran*. Other commercial copolymers are produced from vinyl chloride and acrylonitrile (*Dynel*), and from maleic anhydride and styrene.

CONDENSATION POLYMERS

These may be produced from a great variety of poly-functional compounds : to obtain satisfactory products, the reactants must be pure. A few examples follow.

Phenol - aldehyde polymers. L. Baekland (1909) first demonstrated the possibilities of the reaction between phenol and formaldehyde from the commercial view point. Condensation in the presence of either

alkaline or acid catalysts gives valuable polymers, covered by the general name *Bakelite*. Baekland recognised three distinct stages in the reaction of phenol and formaldehyde in alkaline solution. The initial product, *Bakelite A*, is a liquid or semi-solid, and is converted by continued heating into an intermediate, *Bakelite B*, a relatively insoluble, fusible solid: when the latter is subjected to heat and pressure, it is converted into *Bakelite C*, an insoluble and infusible plastic. A possible formula is:

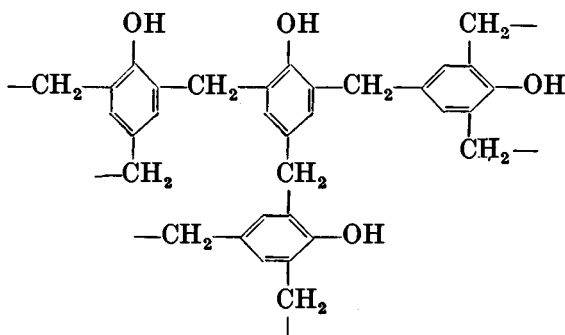

The condensation proceeds somewhat differently with an acid catalyst; the product is termed *Novolak*.

If formaldehyde is replaced by furfural, the furfural-phenol polymer (U.S.A. *Durite*) results. The above polymers are largely used for moulding purposes.

Urea-formaldehyde polymers. Formalin and urea (usually in the molecular proportions of 3 : 2) condense in the presence of ammonia, pyridine or hexamine to give urea-formaldehyde polymers, known commercially as *Beetle* or *Plaskon*, and are widely used as moulding powders. It is believed that the intermediate products in the condensation are methylol-urea and dimethylol-urea:

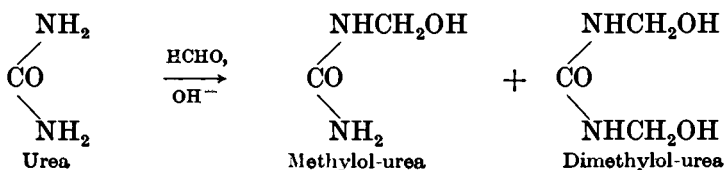

Polymerisation may occur as a result of dehydration of these compounds to methylene and dimethylene urea or more probably by a stepwise loss of water between the molecules of methylol and dimethylol-urea.



Melamine-formaldehyde polymers. Melamine (2 : 4 : 6-triamino-1 : 3 : 5-triazine), obtained by heating dicyandiamide under pressure, condenses with formalin to give melamine-formaldehyde polymers (*Beetle* - *Melamine*), which have similar uses, but better stability to heat

and light, to urea-formaldehyde plastics. The polymerisation probably proceeds through the intermediate hexamethylol-melamine :

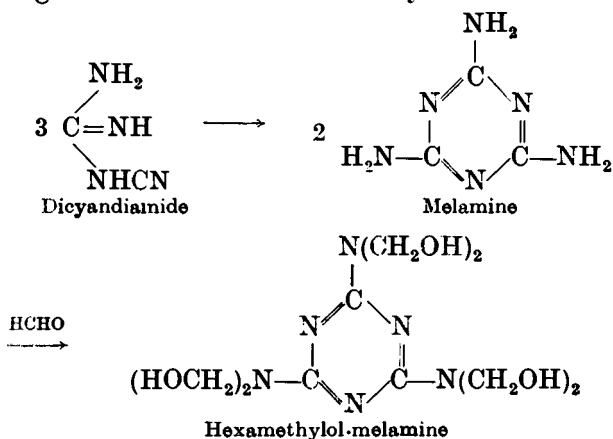

Polyesters from polybasic acids and polyhydric alcohols. Alkyd resins. The condensation of polyhydric alcohols and polybasic acids or anhydrides leads to polyesters known as *alkyd resins*. The most common member of the group is a glycerol-phthalic acid polymer, and this has led to the term *glyptal resins* being frequently applied to the whole group.

By controlling the relative amounts of, for example, glycerol and phthalic anhydride and the experimental conditions of the reaction, various polymers of different properties are obtained. Under mild conditions (*ca.* 150°) only the primary alcohol groups are esterified and the secondary alcohol group remains free. The structural unit of the resulting linear polymer is :



These are comparatively soft materials and they are soluble in a number of organic solvents. Under more drastic conditions (200–220°) and with a larger proportion of phthalic anhydride, the secondary alcohol groups are esterified and the simple chains become cross-linked; three dimensional molecules of much higher molecular weight are formed :

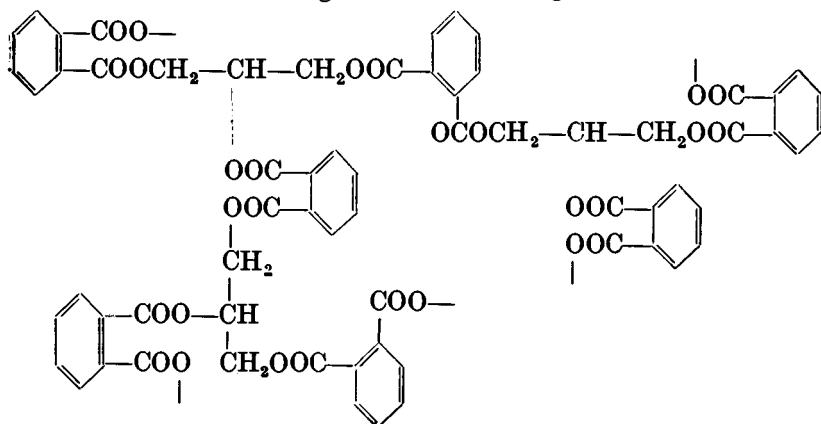

utilised synthetic resins capable of cation exchange by virtue of the presence of the groups $-\text{SO}_3\text{H}$, $-\text{COOH}$ and $-\text{CH}_2\text{COOH}$.

Anion-exchange resins contain a basic radical, such as $-\text{NH}_2$ and $=\text{NH}$, and are prepared by the condensation of formaldehyde with amines such as *m*-phenylenediamine and urea. These resins can absorb acids by the formation of salts, $-\text{NH}_3\text{Cl}$ and $=\text{NH}_2\text{Cl}$, and are regenerated by treatment with sodium hydroxide or sodium carbonate.

The exchange resins find application in (i) the purification of water (cation-exchange resin to remove salts, followed by anion-exchange resin to remove free mineral acids and carbonic acid), (ii) removal of inorganic impurities from organic substances, (iii) in the partial separation of amino acids, and (iv) as catalysts in organic reactions (*e.g.*, esterification, Section III,102, and cyanoethylation, Section VI,22).

Organosilicon polymers. Silicon resembles carbon in certain respects and attempts have been made to prepare polymers combining carbon and silicon units in the molecule with the object of increasing the heat resistance of polymers. It has been found that the hydrolysis of a dialkyldichlorosilane or an alkyltrichlorosilane, or a mixture of the two, leads to polymers (*Silicones*), both solid and liquid, which possess great thermal stability. Thus dimethyldichlorosilane (I) is rapidly converted by water into the silicol (II), which immediately loses water to give a silicone oil of the type (III) :

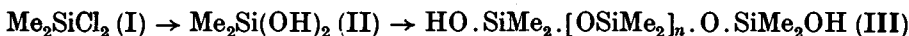

Hydrolysis of mixtures of dialkyldichlorosilanes and alkyltrichlorosilanes leads *inter alia* to cross-linked silicones of the type :

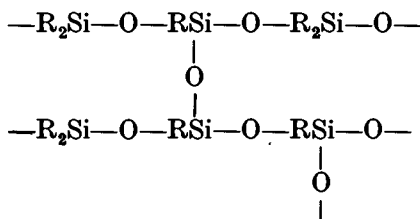

In addition to the above, cyclic polymers, *e.g.* $(\text{R}_2\text{SiO})_n$, and also three-dimensional polymers can be formed. The exact nature of the polymer (its structure, and whether it is liquid or solid at room temperatures) will depend upon the substituted chloroalkyl-(or aryl)-silane, or mixture of substituted silanes, used and upon the experimental conditions.

The silicone oils and silicone resins find application as (i) lubricants (their change of viscosity with temperature is small), (ii) hydraulic fluids (they are unusually compressible), (iii) dielectric fluids, (iv) for the production of water-repellant surfaces, and (v) in the electrical industry (because of their high insulating properties).

The intermediates may be produced from silicon tetrachloride by interaction with the appropriate Grignard reagent, the composition of the product depending upon the proportions of the reactants :

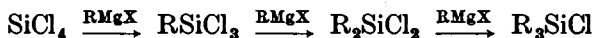

The alkyl- or aryl-halogenosilanes are prepared commercially by passing the vapour of an alkyl or an aryl halide over a heated intimate mixture of powdered silicon and either copper or silver.

Polysulphide rubbers. Ethylene dichloride and excess of sodium tetrasulphide when heated together give a polymeric polysulphide, *Thiokol A*, with properties resembling those of rubber :

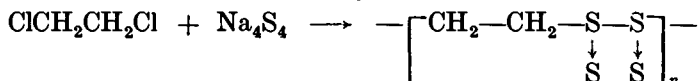

Other polysulphide rubbers are obtained by the use of

$\beta\beta'$ -dichloroethyl ether $\text{O}(\text{CH}_2\text{CH}_2\text{Cl})_2$ (*Thiokol B*),
and glycerol $\alpha\gamma$ -dichlorohydrin $\text{ClCH}_2\text{CH}(\text{OH})\text{CH}_2\text{Cl}$ (*Vulcaplas*).

It is of interest to note that synthetic rubbers are produced by the polymerisation of dienes and are therefore examples of additive polymerisation. Thus :

(i) **Polychloroprene** (*Neoprene*) is formed from chloroprene or 2-chlorobutadiene :

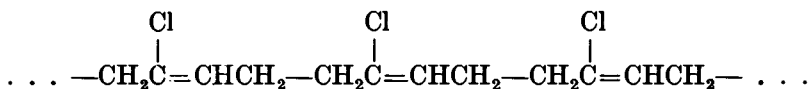
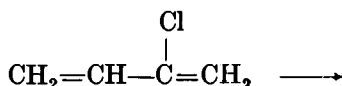

This polymer is vulcanised by heating with metallic oxides, such as zinc oxide ; the reaction may involve the formation of ether bridges :

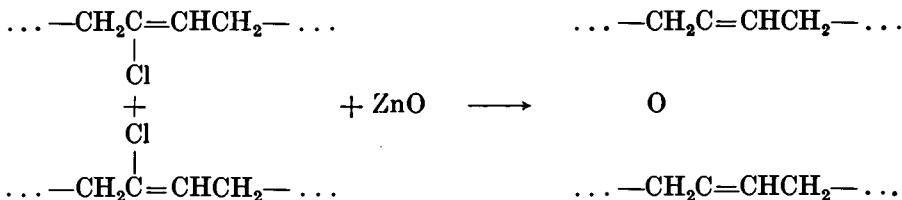

2-Chlorobutadiene is prepared commercially by the following reactions :

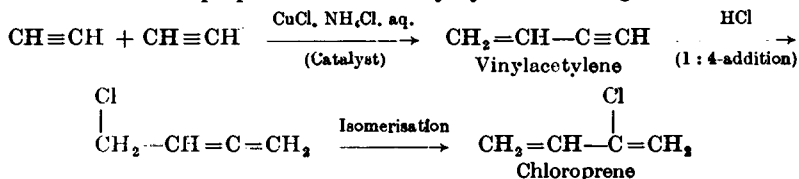

(ii) **Polybutadiene** (*Buna*) is produced by the polymerisation of butadiene in the presence of sodium (the name *Buna* is derived from butadiene-natrium) :

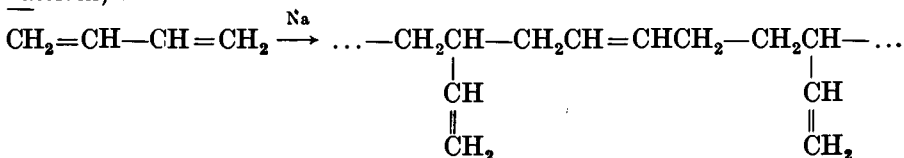

The following scheme indicates one commercial method for the production of *butadiene* :

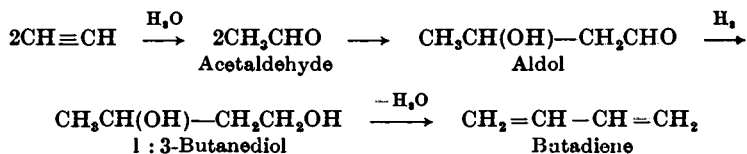

By polymerising an emulsified mixture of butadiene and styrene (*ca.* 25 per cent.) *Buna S* or *GBS rubber* is produced :

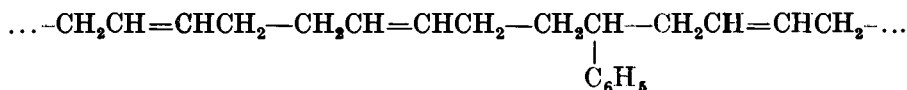

Copolymers of butadiene and acrylonitrile ($\text{CH}_2=\text{CH}-\text{C}\equiv\text{N}$) are termed *Perbunan*, *Hycar*, *Ameripol* and *Chemigum* :

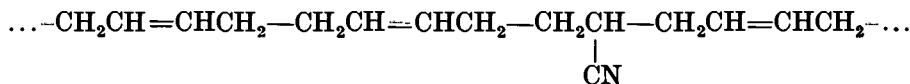

Acrylonitrile is prepared from ethylene chlorohydrin :

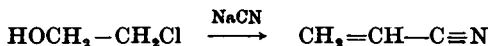

or from acetylene and hydrogen cyanide

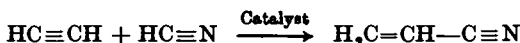

Mention may here be made of the fact that natural unvulcanised rubber is poly-isoprene (2-methylbutadiene) :

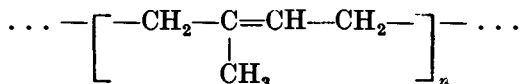

The preparation of synthetic polymers is hardly suitable for the ordinary organic laboratory. However, a few simple demonstration experiments are described below which, it is hoped, will provide an elementary introduction to the subject.

X.2. PHENOL-FORMALDEHYDE RESIN

The formation of various types of phenol - formaldehyde resins (the so-called *Bakelite*) may be demonstrated by the following experiments.

1. In a 500 ml. conical flask place 50 ml. of glacial acetic acid, 25 ml. of 40 per cent. formaldehyde solution (formalin) and 20 g. of phenol. Wrap a cloth or towel loosely around the neck and opening of the flask. Pass dry hydrogen chloride gas (Section II,48,I) into the mixture. Within 5 minutes, a large mass of pink plastic is formed ; the reaction is sometimes very vigorous. The yield is 36 g. It is frequently necessary to break the flask in order to remove the product completely : for this reason a beaker, or metal flask or beaker, is preferable.

2. Place a mixture of 25 g. of phenol, 50 ml. of formalin and 3 ml. of 40 per cent. sodium hydroxide solution in a 500 ml. conical flask. Attach a reflux condenser to the flask and reflux gently. As the heating proceeds, the mixture acquires a red coloration and becomes increasingly more viscous. After 60–75 minutes the contents of the flask are so viscous that the bubbles which rise through the mass encounter great difficulty in escaping from the surface. At this point remove the flame and immediately pour the viscous mass into a wide test-tube ("boiling tube"); upon cooling, an opaque white solid is obtained. (Immediately clean the reaction flask with 40 per cent. sodium hydroxide solution: if it is allowed to stand, the hardened product lining the flask is difficult to remove.) To complete the preparation, place the "boiling tube" in an air oven for 1 hour at 50° and for 4 hours at 60–75°; when the "baking" process is complete, a hard pink mass of plastic is obtained.

3. In a wide-mouthed test-tube ("boiling tube") place 5 g. of phenol, 15 ml. of 40 per cent. formaldehyde solution and 3 ml. of concentrated ammonia solution (sp. gr. 0.88). Warm the mixture with a small flame until it becomes opaque. Cool, discard the aqueous layer, but retain the viscous material in the tube. Heat the latter in a water bath at 60° for 30 minutes and then heat the pasty mass in an air oven at 75° for 4–6 hours. A hard solid resin is produced.

X.3. DEPOLYMERISATION OF METHYL METHACRYLATE RESIN

Place 25 g. of methyl methacrylate polymer (G.B. *Diakon* (powder), *Perspex* (sheet); U.S.A. *Lucite*, *Plexiglass*) in a 100 ml. Claisen flask, attach an efficient condenser (*e.g.*, of the double surface type) and distil with a small luminous flame; move the flame to and fro around the sides of the flask. At about 300° the polymer softens and undergoes rapid depolymerisation to the monomer, methyl methacrylate, which distils over into the receiver. Continue the distillation until only a small black residue (3–4 g.) remains. Redistil the liquid; it passes over at 100–110°, mainly at 100–102°. The yield of methyl methacrylate (monomer) is 20 g. If the monomer is to be kept for any period, add 0.1 g. of hydroquinone to act as a stabiliser or inhibitor of polymerisation.

POLYMERISATION OF METHYL METHACRYLATE

Place 10 g. of liquid methyl methacrylate in a test-tube, add 10–20 mg. of benzoyl peroxide (Section IV, 196), stopper the test-tube loosely and heat in a boiling water bath. After 20–25 minutes, the liquid suddenly becomes very viscous and soon sets to a hard, colourless mass of the polymer.

X.4. FORMATION OF A GLYPTAL RESIN

In a 250 ml. beaker place 15 g. of powdered phthalic anhydride and 10 g. of glycerol; mix thoroughly with a thermometer. Heat the mixture gently to 150–180° on a wire gauze: water vapour is evolved.

Raise the temperature gradually to 200–250° until the mass finally forms large bubbles and puffs up into a voluminous mass. At this point allow the beaker to cool. Remove the brittle mass from the beaker as completely as possible and powder it in a mortar.

Note.

The solid polymer tends to stick to glass; for this reason, it is preferable to employ a metal beaker for the experiment.

X.5. THIOKOL A (POLYETHYLENE POLYSULPHIDE)

Prepare a saturated solution of sodium sulphide, preferably from the fused technical sodium polysulphide, and saturate it with sulphur; the sulphur content should approximate to that of sodium tetrasulphide. To 50 ml. of the saturated sodium tetrasulphide solution contained in a 500 ml. round-bottomed flask provided with a reflux condenser, add 12.5 ml. of ethylene dichloride, followed by 1 g. of magnesium oxide to act as catalyst. Heat the mixture until the ethylene dichloride commences to reflux and remove the flame. An exothermic reaction sets in and small particles of *Thiokol* are formed at the interface between the tetrasulphide solution and the ethylene chloride; these float to the surface, agglomerate, and then sink to the bottom of the flask. Decant the liquid, and wash the solid several times with water. Remove the *Thiokol* with forceps or tongs and test its rubber-like properties (stretching, etc.).

X.6. PHENYLETHYLENE (STYRENE)

Styrene may be conveniently prepared in the laboratory by heating β -phenylethyl alcohol (Section IV,204) with solid sodium or potassium hydroxide when an almost quantitative dehydration occurs:

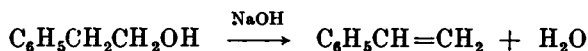

In a 250 ml. distilling flask (1) place 122 g. (119 ml.) of β -phenylethyl alcohol and 40 g. of sodium hydroxide pellets (or 56 g. of potassium hydroxide). Heat is evolved. Warm gently until bubbles commence to form and the mixture separates into two sharply-defined layers. Distil slowly; water, etc. passes over first accompanied by the gradual disappearance of the upper phase. Finally the styrene passes over at 140–160° (mainly 150°); collect this separately in a receiver containing about 0.1 g. of hydroquinone. Dry the distillate with a little anhydrous calcium chloride or magnesium sulphate, and then distil under reduced pressure (2). Collect the pure styrene at 42–43°/18 mm. The yield is 80 g. Add about 0.2 g. of hydroquinone (anti-oxidant) if it is desired to keep the phenylethylene.

Notes.

(1) Fused alkalis attack glass; if several preparations are to be carried out, a copper flask should be used.

(2) Phenylethylene boils at 145–146° at atmospheric pressure, but the high temperature causes a considerable loss by polymerisation. It has been stated that the addition of about 0.1 per cent. by weight of hydroquinone considerably reduces the extent of polymerisation at atmospheric pressure.

X.7.

POLYSTYRENE

Heat 20 g. of styrene (Section IX,6) with 0.2 g. of benzoyl peroxide (Section IV,196) on a water bath for 60-90 minutes. A glass-like polymer (polystyrene) is produced. The polymer is soluble in benzene and in dioxan and can be precipitated from its solution by alcohol.

Note.

Great care should be taken in conducting the polymerisation as the reaction may become extremely violent.

X.8. ETHYLENEDIAMINE—ADIPIC ACID POLYMER

This is an example of a polymer of the "nylon" type.

Add 40 ml. of ethyl alcohol to 21.5 g. of 70 per cent. ethylenediamine solution (0.25 mol); dissolve 36.5 g. of adipic acid (0.25 mol) in 50 ml. of a 6:1 mixture of ethyl alcohol and water. Mix the two solutions, stir and cool. Filter off the resulting salt and recrystallise it from 60 ml. of a 6:1 ethyl alcohol - water mixture, and dry the salt in the air. Heat the salt in an atmosphere of oxygen-free nitrogen or of carbon dioxide in an oil bath until it melts (*ca.* 160°); the product will solidify after a short time. Reduce the pressure to 15 mm. of mercury or less and raise the temperature of the oil bath until the product remelts (about 290°) and continue the heating for 4-5 hours. Upon cooling, a "nylon" type polymer is obtained.

X.9. DEPOLYMERISATION OF A HEXAMETHYLENE-DIAMINE - ADIPIC ACID POLYMER (NYLON '66')

Add 10 ml. of concentrated sulphuric acid cautiously to 45 ml. of water contained in a 200 ml. round-bottomed flask, introduce 3 g. of *Nylon* '66' polymer* into the hot solution, and heat under reflux for 6 hours. Allow to stand for 1 hour and cool in ice for a further hour. Filter off the solid and keep the filtrate. Recrystallise the solid (adipic acid) from water m.p. 152°.

Neutralise about one third of the filtrate with 5*N* sodium hydroxide and add a further 2 ml. of the alkali solution. Add 1 ml. of benzoyl chloride and stir until the odour of the acid chloride disappears. Collect the solid by suction filtration, wash it with water until free from alkali, and then recrystallise it from dilute alcohol. The product is the dibenzoyl derivative of hexamethylenediamine and melts at 159°.

* The '66' polymer refers to the number of carbon atoms in each of the components. I.C.I. "Maranyl" Nylon compound A100 may be used.

CHAPTER XI

QUALITATIVE ORGANIC ANALYSIS

XI.1. BASIS OF QUALITATIVE ORGANIC ANALYSIS

MANY of the organic compounds normally encountered may be regarded as derived from the paraffin hydrocarbons either by the substitution of one or more inorganic atoms or radicals for hydrogen or by the insertion of one or more inorganic atoms or radicals between the carbon atoms constituting the carbon chain, *i.e.*, by the attachment of inorganic atoms or radicals to paraffin hydrocarbon residues. Thus, by the introduction of halogen atoms, of oxygen as hydroxyl (OH), of oxygen as carbonyl (C=O), of nitrogen, of the ammonia residue (NH₂), of sulphur as sulphydryl (SH), etc. one may arrive at the homologous series of halogen compounds, alcohols, aldehydes, ketones, nitriles, amines, thiols, etc. Likewise, if an oxygen atom, sulphur atom or ammonia residue (NH) etc. is coupled with paraffin hydrocarbon residues, the homologous series of ethers, thio-ethers, or secondary amines, etc. is obtained. Both the chemical and physical properties of the paraffin hydrocarbons are fundamentally changed by the introduction of these inorganic substituents; they are, indeed, essentially dependent upon them. It is known, however, that members of any homologous series exhibit similar chemical reactions, which are markedly different from those members of another homologous series. Certain physical properties, such as melting point, volatility and solubility, on the other hand, depend upon the size of the paraffin hydrocarbon residue and thus undergo considerable change, within each series, with increasing molecular weight. It is usually possible to separate the components of a mixture of organic compounds into members of different homologous series as a result of their differing chemical reactions or more obvious physical differences. Mixtures of various members of a homologous series can frequently be separated by physical methods: in some cases the separation may be extremely difficult (necessitating the use of precision physical methods, *e.g.*, of fractional distillation) or be almost impossible.

In addition to inorganic radicals, which profoundly modify the properties of a paraffin hydrocarbon residue, there is a whole series of organic groupings which are distinguished by exceptional reactivity, for example, the ethylene and acetylene groupings, and the phenyl and naphthyl radicals. Thus the characterisation of unsaturated hydrocarbons and their derivatives, *e.g.*, the aromatic compounds, becomes possible.

Although more than 400,000 organic compounds have been recorded in the literature, most of these may be grouped into a comparatively small number of homologous series or of classes of organic substances. By identifying the class to which an organic compound belongs, the problem of characterisation is enormously simplified. For purposes of qualitative organic analysis, the following admittedly incomplete scheme will be adopted in this book. It must be emphasised, however, that,

unlike systematic inorganic analysis,* the scheme is merely intended as a rough guide to the method of attack of the problem ; the student must be prepared to apply his knowledge of organic chemistry at all points, and must be alert at all times to the significance of any observations which may throw light on the analysis.

1. Determination of the physical constants and the establishment of the purity of the compound. For a solid, the melting point is of great importance : if recrystallisation does not alter it, the compound may be regarded as pure. For a liquid, the boiling point is first determined : if most of it distils over a narrow range (say, 1–2°), it is reasonably pure. (Constant boiling point mixtures, compare Section I,4, are, however known.) The refractive index and the density, from which the molecular refractivity may be calculated, are also valuable constants for liquids.

2. Qualitative analysis for the elements. This includes an examination of the effect of heat upon the substance—a test which *inter alia* will indicate the presence of inorganic elements—and qualitative analysis for nitrogen, halogens and sulphur and, if necessary, other inorganic elements. It is clear that the presence or absence of any or all of these elements would immediately exclude from consideration certain classes of organic compounds.

3. Study of the solubility behaviour of the compound. A semi-quantitative study of the solubility of the substance in a limited number of solvents (water, ether, dilute sodium hydroxide solution, dilute hydrochloric acid, sodium bicarbonate solution, concentrated sulphuric and phosphoric acid) will, if intelligently applied, provide valuable information as to the presence or absence of certain classes of organic compounds.

4. Application of class reactions. The application of selected reactions that indicate the presence or absence of certain functional groups, with due regard to the indications provided by tests 1, 2 and 3, will locate the class (or classes) to which the compound belongs or will, at least, serve to eliminate all but a few classes to which the compound can be assigned.

5. Location of the compound within a class (or homologous series) of compounds. Reference to the literature or to tables of the physical properties of the class (or classes) of organic compounds to which the substance has been assigned, will generally locate a number of compounds which boil or melt within 5° of the value observed for the unknown. If other physical properties (e.g., refractive index and density for a liquid) are available, these will assist in deciding whether the unknown is identical with one of the known compounds. In general, however, it is more convenient in practice to prepare one, but preferably two, crystalline derivatives of the substance.

6. Preparation of derivatives. If two distinct crystalline derivatives of the unknown have the same melting point (or other physical properties) as those of the compound described in the literature (or in the tables), the identity of the two compounds may be assumed. Further

* See, for example, the author's *Text Book of Macro and Semimicro Qualitative Inorganic Analysis*, Fourth Edition, 1954 (Longmans, Green and Co. Ltd.).

confirmation may be obtained, if desired, by mixed melting point determinations (see Section I,17)

XI.2. DETERMINATION OF PHYSICAL CONSTANTS

The most widely used physical constants in the characterisation of organic compounds are melting points and boiling points. The technique of the determination of melting points is discussed in detail in Section II,10. For routine use in the laboratory the apparatus shown in Fig. II, 10, 2, *a* is satisfactory. The melting point of a solid which melts slightly above or below room temperature is determined with the aid of the apparatus depicted in Fig. II, 10, 4. For compounds which melt above 250°, the electrically-heated melting point apparatus of Fig. II, 11, 1 should be used. The latter apparatus is suitable for melting point determinations from just above room temperature to about 400°; it is recommended that at least one such apparatus be available in every laboratory.

In general, a sharp melting point (say, within 0.5°) is one of the most characteristic properties of a pure organic compound. The purity should not, however, be assumed but must be established by observation of any changes in the melting point (or in the melting range) when the compound is subjected to purification by recrystallisation (the technique of recrystallisation is discussed fully in Sections II,27–II,31). If the melting point is unaffected by at least one recrystallisation, then the purity of the substance may be regarded as established. In rare cases purification may be effected by sublimation at atmospheric or under reduced pressure (see Section II,45).

The experimental determination of the boiling point of a liquid is dealt with in Section II,12. Since only small quantities are generally supplied for qualitative analysis, the boiling point determination is usually made with a volume of 5–10 ml. and the apparatus of Fig. II, 12, 1 is proportionally reduced, using a distilling flask of 10–15 ml. capacity. It is convenient to use a set-up such as is shown in Fig. II, 19, 1, which dispenses with the Liebig's condenser; the neck of the flask is closed by a cork for distillation at atmospheric pressure and a few small pieces of porous porcelain are placed in the flask to ensure smooth boiling. The small (10–15 ml.) Claisen flask may be replaced by a distilling flask, but it is better, if possible, to use the former. Heating is best conducted in an air bath (Fig. II, 5, 3). The distillation is carried out at a slow steady rate; it is advisable to collect the first portion of the distillate separately, since this will contain any water present in the sample. If the boiling point range does not exceed 1–3° for the main bulk of the sample (there is usually some superheating towards the end of the distillation), it is reasonably safe to assume that the liquid is pure. The possibility that it may be a constant boiling point mixture (compare Section I,4) should be borne in mind.

When the volume of the liquid available is less than 1 ml. or is limited owing to consideration of cost, etc., the boiling point may be determined by the Siwoloboff method (see Fig. II, 12, 2). It should, however, be remembered that the Siwoloboff method gives trustworthy results only

for comparatively pure liquids; small amounts of volatile impurities, such as ether and water, may lead to boiling points which approximate to those of the volatile component.

If the liquid is shown by distillation to have a wide boiling range (10–30°), it may be necessary to subject it to fractional distillation in order to obtain a reasonably pure sample of the compound. The simple Hempel column, filled with glass or porcelain rings, shown in Fig. II, 16, 1 may be used. Alternatively a Claisen flask with fractionating side arm (Figs. II, 24, 2–5) will be found satisfactory. When the boiling points of the components of the mixture are quite close to each other (5–10°), a more efficient type of fractionating column (see Section II, 17) will be required.

DETERMINATION OF DENSITY AND OF REFRACTIVE INDEX

The density and the refractive index of a liquid will frequently be of value in assisting its characterisation.

Density. The density of a liquid is conveniently determined with the

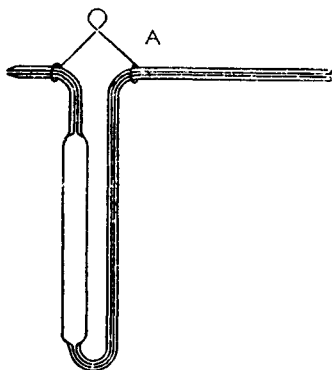

Fig. XI, 2, 1.



Fig. XI, 2, 2.

aid of a pycnometer (Fig. XI, 2, 1). The bulb has a capacity of 1–2 ml. and the capillary arms have a bore of 1 mm.; a mark *A* is made with a fine file or diamond (in the position indicated) for the adjustment of the level of the liquid in the pycnometer. A thin silver wire loop is provided for supporting the pycnometer on the hook over the balance pan. This pycnometer is readily filled by means of the device shown in Fig. XI, 2, 2 (colloquially known as a “snake”); it consists of a short length of narrow (about 3 mm. bore) rubber tubing into one end of which is fitted a piece of glass tubing shaped as shown in the figure. The liquid is placed in a small glazed crucible (3–5 ml. capacity) and the rubber tubing is fitted over the longer arm of the pycnometer. By holding the pycnometer vertically so that the short capillary end is below the surface of the liquid in the crucible, and applying *gentle* suction at the glass tube of the

"snake" by means of the mouth,* the pycnometer is completely filled slightly beyond the file mark *A*. The pycnometer is then returned to the vertical position (no air bubbles should be present if the pycnometer has been carefully filled) and the short arm touched with filter paper. This will cause the liquid to move along the capillary; immediately it reaches the mark *A*, the filter paper is sharply removed. With a little practice, no difficulty will be experienced in filling the pycnometer accurately to the mark *A*. After carefully polishing the outside with a clean linen cloth and weighing the pycnometer, the liquid is emptied into the crucible or other vessel by attaching the snake to the longer arm and blowing gently. The pycnometer is then cleaned by charging the crucible with rectified spirit and then filling the pycnometer; the alcohol is emptied into the "ALCOHOL RESIDUES" bottle and the pycnometer is then filled again. The process is repeated with sodium-dried ether; finally a stream of air is drawn through the pycnometer by attaching the "snake" through a filter flask trap to a water pump for 10–15 minutes. The outside of the pycnometer is again wiped with a clean linen cloth and weighed empty.

The density determination may be carried out at the temperature of the laboratory. The liquid should stand for at least one hour and a thermometer placed either in the liquid (if practicable) or in its immediate vicinity. It is usually better to conduct the measurement at a temperature of 20° or 25°; throughout this volume a standard temperature of 20° will be adopted. To determine the density of a liquid at 20°, a clean, corked test-tube containing about 5 ml. of the liquid is immersed for about three-quarters of its length in a water thermostat at 20° for about 2 hours. An empty test-tube and a shallow beaker (*e.g.*, a "Baco" beaker) are also supported in the thermostat so that only the rims protrude above the surface of the water; the pycnometer is supported by its capillary arms on the rim of the test-tube, and the small crucible is placed in the beaker, which is covered with a clock glass. When the liquid has acquired the temperature of the thermostat, the small crucible is removed, charged with the liquid, the pycnometer rapidly filled and adjusted to the mark. With practice, the whole operation can be completed in about half a minute. The error introduced if the temperature of the laboratory differs by as much as 10° from that of the thermostat does not exceed 1 mg.; if the temperature of the laboratory is adjusted so that it does not differ by more than 1–2° from 20°, the error is negligible. The weight of the empty pycnometer and also filled with distilled (preferably conductivity) water at 20° should also be determined. The density of the liquid can then be computed.

The specific gravity (d_4^{20}) of a liquid may be defined as the ratio of the weight of the liquid to that of an equal volume of water at the same temperature. Thus :

$$\text{Specific gravity, } d_4^{20} = \frac{\text{Weight of liquid at } 20^\circ}{\text{Weight of an equal volume of water at } 20^\circ} = \frac{W_l^{20}}{W_w^{20}}$$

* An empty wash-bottle, equipped with a two-holed cork, may be interposed between the mouth and the pycnometer for corrosive or poisonous liquids.

The density ($d_{4^{\circ}}^{20^{\circ}}$) may be regarded as the specific gravity referred to an equal volume of water at 4° , *i.e.*,

$$d_{4^{\circ}}^{20^{\circ}} = \frac{W_l^{20^{\circ}}}{W_w^{20^{\circ}}} \times D^{20^{\circ}} = W_l^{20^{\circ}} \times \left(\frac{0.9982}{W_w^{20^{\circ}}} \right)$$

where $D^{20^{\circ}}$ is the density of water at 20° , *i.e.*, 0.9982. The quantity enclosed in the bracket is the constant for the pycnometer and should be recorded permanently. In all subsequent determinations of the density, only the weight of the liquid filling the pycnometer will be required. It is advisable, however, to redetermine the constant periodically.

Notes on the construction of a thermostat. A thermostat may be easily constructed by a skilled mechanic. The essential requirements are :

(1) A large metal tank, preferably lagged to within 5 cm. of the upper rim.

(2) A motor-driven stirrer. That illustrated in Figs. II, 7, 1 (see also Fig. II, 7, 7) is quite satisfactory: the motor is supported on a stout metal bar fitted across the thermostat tank.

(3) A conventional type of mercury-toluene regulator.

(4) A relay: the Sunvic type F.102N hot-wire vacuum switch * with neon indicator lamp is satisfactory.

(5) A suitable heating lamp or other heating device. The author has found the 250 watts vertical pattern radiator lamp ("sausage" lamp) or, alternatively, the Santon 250 or 500 watts immersion heater † to give excellent results.

No difficulty should be experienced in constructing a thermostat with the aid of the components recommended that will maintain a temperature of $20^{\circ} \pm 0.01^{\circ}$.

For circulating water through a refractometer any commercial water circulating pump may be used.‡

Refractive index. The refractive index of a liquid is conveniently determined with an Abbe refractometer. This refractometer possesses the following advantages :

(a) The refractive index (1.3000 to 1.7000) may be read directly on a scale with accuracy of about 0.0002.

(b) It requires only a drop of the sample.

(c) A source of monochromatic light is not essential; by means of a "compensator" the observed refractive index corresponds to that obtained with the D line of sodium even though white light is used as a source of illumination.

The principle of the instrument is the observation of the "critical angle" for total reflection between glass of high refractive index (*e.g.*, flint glass, n_D 1.75) and the substance to be examined. The glass is in the form of a right-angled prism upon the hypotenuse face *AB* of which the compound to be investigated is placed. If the compound is a solid,

* Supplied by Sunvic Controls Ltd.

† Manufactured by Santon Ltd.

‡ The author employs the Stuart centrifugal pump, No. 10, supplied by Stuart Turner Ltd.

optical contact with the prism is made by means of a liquid of higher refractive index than the solid (*e.g.*, methylene iodide); if it is a liquid (as is usual in qualitative organic analysis), it is enclosed as a thin film (about 0.15 mm. thick) between two similar prisms (Fig. XI, 2, 4). The face *AC* of the prism plays a part in the refraction of the light, and it is the angle of emergence (α) from this face which is measured, the scale of the instrument being, however, divided to read the refractive index directly. The ray shown in Fig. XI, 2, 3 and in Fig. XI, 2, 4 is that which enters the face *AB* at grazing incidence, and corresponds to the edge of the dark part of the field of view of the instrument. The direction of the ray after entering the face *AB* depends upon its wave length, and thus the scale of refractive index will vary with the light employed. That selected is for sodium light, but in order to permit the use of white light, the resultant dispersion of the light emerging from the face *AC* is neutralised by means of a dispersion "compensator" situated at the base of the telescope. It consists of two direct vision prisms, made accurately direct for the D sodium line, which are capable of rotation at

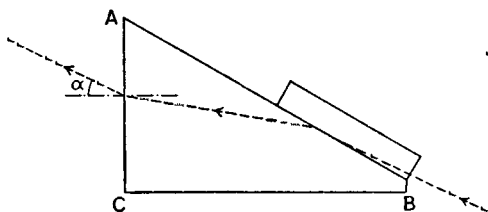

Fig. XI, 2, 3.

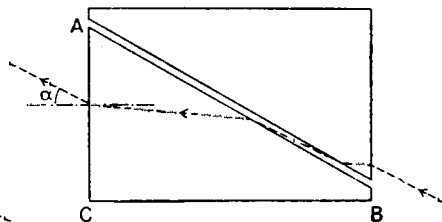

Fig. XI, 2, 4.

equal rates and in opposite directions about the axis of the telescope of the refractometer. They form a system of variable dispersion which can be made equal in amount and of opposite direction to the resultant dispersion (*D*) of the refractometer prism and the substance investigated.

Fig. XI, 2, 5* is a drawing of the Hilger Abbe refractometer, whilst Fig. XI, 2, 6* is a line diagram showing the essential parts of the instrument.

To determine the refractive index of a liquid at 20°, circulate water at 20° from a thermostat through the jacket surrounding the two prisms until the temperature on the thermometer has remained steady for at least 10 minutes. Separate the prism jackets by opening the clamp, and move the index arm, if necessary, until the face of the prism is horizontal. Wipe the latter with a clean linen cloth, place a drop or two of the liquid on the ground glass prism face and then clamp it to the upper polished prism. Focus the cross-wires of the telescope by rotating the eyepiece, and then adjust the mirror so as to give good illumination from a suitably placed frosted electric lamp. By means of the rack and pinion controlling the arm at the side of the apparatus, turn the prism box until the field of view becomes partly light and partly dark. When white light is used,

* The author is indebted to Messrs. Adam Hilger Ltd. for these two figures. A detailed description of the instrument will be found in their booklet, "*Instructions for the Use of the Abbe Refractometer*," and to which the reader is referred for further particulars.

the edge of the light band will show a coloured fringe. By means of the milled screw head at the base of the telescope, rotate the dispersion "compensator" until the coloured fringe disappears and the light (or dark) band is bounded by a sharp edge. Now rotate the prism box slowly until the sharp edge coincides with the intersection of the cross

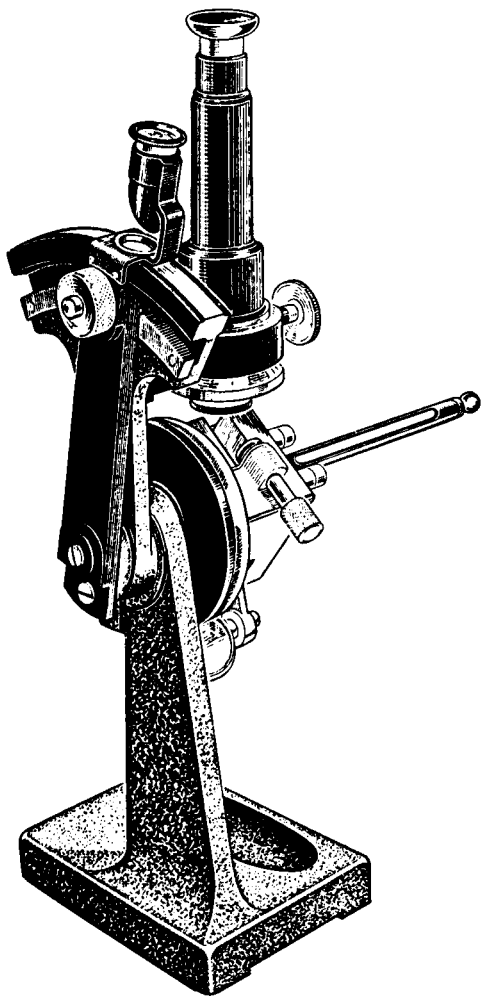

Fig. XI, 2, 5.

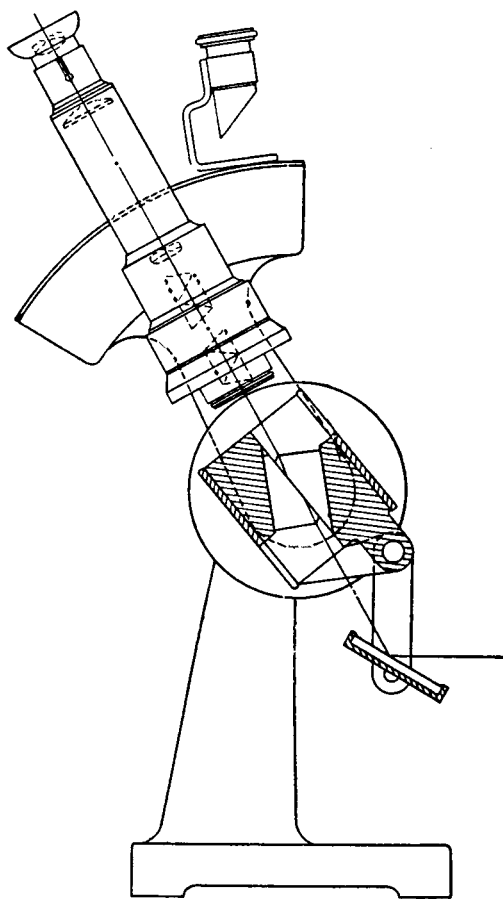

Fig. XI, 2, 6.

wires in the telescope, and read off directly the refractive index for the D sodium line on the divided arc by means of the magnifying lens. Immediately the determination has been completed, wipe off the organic liquid with filter paper or cotton wool, and clean the prism surfaces with cotton wool soaked in acetone. The accuracy of the instrument may be checked by measuring the refractive index of distilled water ($n_D^{10^\circ}$ 1.3337, $n_D^{20^\circ}$ 1.3330, $n_D^{30^\circ}$ 1.3320, $n_D^{40^\circ}$ 1.3307).

The refractive index of a liquid is recorded as n_D^t where t is the temperature at which the measurement is made, and D refers to the wave length of the D line of sodium. As already pointed out, it is usual to determine both the refractive index and the density of the liquid at 20°; in any case they should be determined at the same temperature. These two constants are useful in assisting the characterisation of a pure liquid; they are particularly valuable for aliphatic hydrocarbons and similar compounds where the methods of characterisation by the formation of solid derivatives are not entirely satisfactory.

The molecular refractivity can be computed from the Lorenz and Lorentz equation :

$$[R_L]_D = \frac{n_D^2 - 1}{n_D^2 + 2} \cdot \frac{M}{d}$$

where n is the refractive index, d is the density at the same temperature, and M is the molecular weight. The molecular refractivity may also be *calculated* from the structural formula by the summation of either the atomic and structural constants or the bond refractions. Agreement between the observed and calculated values of the molecular refractivity constitutes powerful evidence for the correctness of the structural formula from which $[R_L]_D$ was calculated.

The values for the D sodium line of the atomic and structural constants and of the bond refractions, as determined by the author, are collected in Tables XI,2A and XI,2B respectively.

TABLE XI,2A. ATOMIC AND STRUCTURAL CONSTANTS (D-LINE)

CH ₂	4·647	CO (methyl ketones)	4·76
H (in CH ₂)	1·028	COO (esters)	6·20
C (in CH ₂)	2·591	COOH	7·23
CH ₃	5·65	OH (aliphatic alcohols)	2·55
C ₂ H ₅	10·30	SH (alkyl thiols)	8·76
<i>n</i> -C ₃ H ₇	14·97	S (dialkyl sulphides)	7·92
<i>iso</i> -C ₃ H ₇	14·98	S ₂ (dialkyl disulphides)	16·05
<i>n</i> -C ₄ H ₉	19·59	Double bond (C=C)	1·58
<i>iso</i> -C ₄ H ₉	19·62	Triple bond (C≡C), terminal	1·98
<i>sec.</i> -C ₄ H ₉	19·42	Triple bond (C≡C), non-terminal	2·35
<i>tert.</i> -C ₄ H ₉	19·85	3-membered carbon ring	0·61
<i>n</i> -C ₅ H ₁₁	24·25	4-membered carbon ring	0·32
<i>iso</i> -C ₅ H ₁₁ *	24·20	NH ₂ (primary aliphatic amines)	4·44
<i>iso</i> -C ₅ H ₁₁ †	24·28	NH (secondary aliphatic amines)	3·61
<i>n</i> -C ₆ H ₁₃	28·86	NH (secondary aromatic amines)	4·68
<i>n</i> -C ₇ H ₁₅	33·55	N (tertiary aliphatic amines)	2·74
<i>n</i> -C ₈ H ₁₇	38·14	N=N (azo)	6·19
C ₃ H ₅ (allyl)	14·52	CN (aliphatic nitriles)	5·46
C ₆ H ₅	25·36	NO ₂ (aliphatic nitro compounds)	6·71
Cl	5·84	O, NO (aliphatic nitrites)	7·24
Br	8·74	NO (nitroso)	5·20
I	13·95	SCN (aliphatic thiocyanates)	13·40
F	0·81	NCS (aliphatic <i>iso</i> -thiocyanates)	15·62
O (ethers)	1·76	CO ₃ (dialkyl carbonates)	7·70
O (acetals)	1·61	SO ₃ (dialkyl sulphites)	11·34
CO (ketones)	4·60	PO ₄ (trialkyl phosphates)	10·77

* From synthetic *iso*-amyl alcohol.† From fermentation *iso*-amyl alcohol.

TABLE XI,2B. BOND REFRACTIONS AT 20° (D-LINE)

C—H	1.676	C=S	11.91
C—C	1.296	C—N	1.57
C=C	4.17	C=N	3.76
C≡C (terminal)	5.87	C≡N	4.82
C≡C (non-terminal)	6.24	O—H (alcohols)	1.66
C—C (3-ring)	1.49	O—H (acids)	1.80
C—C (4-ring)	1.37	S—H	4.80
C—C (5-ring)	1.26	S—S	8.11
C—C (6-ring)	1.27	S—O	4.94
C—F	1.55	S→O	-0.20
C—Cl	6.51	N—H	1.76
C—Br	9.39	N—O	2.43
C—I	14.61	N→O	1.78
C—O (ethers)	1.54	N=O	4.00
C—O (acetals)	1.46	N—N	1.99
C=O	3.32	N=N	4.12
C=O (methyl ketones)	3.49	C _{ar} —C _{ar}	2.69
C—S	4.61		

Note.

In the calculation of the molecular refractivity of esters, the C—O value for acetals is employed.

DETERMINATION OF MOLECULAR WEIGHT

The determination of the molecular weight of a compound is rarely necessary in qualitative organic analysis. Occasionally a knowledge of the molecular weight may be useful, particularly in those cases where a derivative cannot easily be prepared or is unknown. The usual methods of determining molecular weights are too cumbersome and too time-consuming for characterisation work. The high freezing point depression of camphor permits the use of an ordinary melting point apparatus, thus enabling the molecular weight to be determined rapidly (Rast's camphor method).

Support a small clean test-tube (*e.g.*, 75 × 10 mm.) in a hole bored in a cork so that it will stand conveniently on the pan of a balance. Weigh the tube. Introduce about 50 mg. of the compound of which the molecular weight is to be determined, and weigh again. Then add 500–600 mg. of pure, resublimed camphor (*e.g.*, the micro-analytical reagent, B.D.H.) and weigh again. Stopper the test-tube loosely and melt the contents by placing it in an oil bath previously heated to about 180°* ; stir the liquid with a platinum wire, but do not heat the liquid for more than one minute or camphor will sublime from the solution. Allow to cool, transfer the solid to a clean watch glass and powder the solid. Introduce some of the powder into a thin capillary tube of which the closed end is carefully rounded: press the solid down into the closed end with the aid of a platinum wire or with a closed capillary tube of smaller diameter. The height of the solid should not exceed 2 mm. Determine the melting point of the mixture (Fig. II, 10, 2, *a* or II, 10, 3) using, preferably, a 100–200° thermometer graduated in 0.1° or 0.2° ; good illumination is essential. The melting point is taken as that temperature at which the last fragment of solid disappears. To make sure that the mixture is homogeneous, repeat the melting point determination with a second sample ; if the two differ appreciably, prepare a new mixture. Then determine the melting point of the original camphor. The difference in melting points gives the depression of the melting point of camphor caused by the addition of the compound. The molecular weight *M* can then be calculated from the formula :

$$M = \frac{K \times w \times 1000}{\Delta T \times W}$$

where *K* is the molecular depression constant of camphor (39.7)

w is the weight of the compound

W is the weight of the camphor

and ΔT is the depression of the melting point.

Note

The solute concentration should be above 0.2*M* ; in dilute solution *K* increases from 39.7 to about 50.

* If very great care is taken, the mixture may be melted by heating over a very small flame for about 30 seconds : the technique described in the text is to be preferred.

XI.3. QUALITATIVE ANALYSIS FOR THE ELEMENTS

The most commonly occurring elements in organic compounds are carbon, hydrogen, oxygen, nitrogen, sulphur and the halogen elements; less common elements are phosphorus, arsenic, antimony, mercury, or other metals which may be present as salts of organic acids. There is no direct method for the detection of oxygen.

It is usually advisable to carry out the ignition test first. This will provide useful information as to the general properties of the compound and, in particular, the residue may be employed for the detection of any inorganic elements which may be present.

IGNITION TEST

Place about 0.1 g. of the compound in a porcelain crucible or crucible cover. Heat it gently at first and finally to dull redness. Observe :

(a) Whether the substance melts, is explosive, or is inflammable and the nature of the flame.

(b) Whether gases or vapour are evolved and their odour (*CAUTION!*)

(c) Whether the residue fuses.

If an appreciable amount of residue remains, note its colour. Add a few drops of water and test the solution (or suspension) with litmus or with Universal indicator paper. Then add a little dilute hydrochloric acid and observe whether effervescence occurs and the residue dissolves. Apply a flame test with a platinum wire on the hydrochloric acid solution to determine the metal present. (In rare cases, it may be necessary to subject a solution of the residue to the methods of qualitative inorganic analysis to identify the metal or metals present.) If the flame test indicates sodium, repeat the ignition of the substance on platinum foil.

Heating with soda lime is often a useful preliminary test. Mix thoroughly about 0.2 g. of the substance with about 1 g. of powdered soda lime. Place the mixture in a Pyrex test-tube; close the tube by a cork and delivery tube. Incline the test-tube so that any liquid formed in the reaction cannot run back on the hot part of the tube. Heat the test-tube gently at first and then more strongly. Collect any condensate produced in a test-tube containing 2-3 ml. of water. Nitrogenous compounds will usually evolve ammonia or vapours alkaline to litmus and possessing characteristic odours; hydroxybenzoic acids yield phenols; formates and acetates yield hydrogen; simple carboxylic acids yield hydrocarbons (methane from acetic acid, benzene from benzoic or phthalic acid, etc.); amine salts and aromatic amino carboxylic acids yield aromatic amines; etc.

CARBON AND HYDROGEN

Evidence of the organic nature of the substance may be provided by the behaviour of the compound when heated on porcelain or platinum or other comparatively inert metal (*e.g.*, nickel): the substance is inflammable, burns with a more or less smoky flame, chars and leaves a black residue consisting largely of carbon (compare *Ignition Test* above).

If it is desired to test directly for the presence of carbon and hydrogen in a compound, mix 0.1 g. of the substance with 1-2 g. of ignited, fine

copper oxide powder * in a dry test-tube, and fit the latter with a cork carrying a tube bent at an angle so that the escaping gases can be bubbled below the surface of lime water contained in a second test-tube. Clamp the test-tube containing the mixture near the cork. Heat the mixture gradually. If carbon is present, carbon dioxide will be evolved which will produce a turbidity in the lime water. If hydrogen is present, small drops of water will collect in the cooler part of the tube.

NITROGEN, SULPHUR AND HALOGENS

In order to detect these elements in organic compounds, it is necessary to convert them into ionisable inorganic substances so that the ionic tests of inorganic qualitative analysis may be applied. This conversion may be accomplished by several methods, but the best procedure is to fuse the organic compound with metallic sodium (Lassaigne's test). In this way sodium cyanide, sodium sulphide and sodium halides are formed, which are readily identified. Thus :

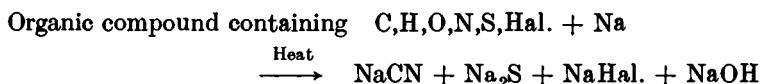

It is essential to use an excess of sodium, otherwise if sulphur and nitrogen are both present sodium thiocyanate, NaCNS, may be produced ; in the test for nitrogen it may give a red coloration with ferric iron but no Prussian blue since there will be no free cyanide ions. With excess of sodium the thiocyanate, if formed, will be decomposed :

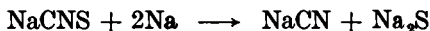

The filtered alkaline solution, resulting from the action of water upon the sodium fusion, is treated with ferrous sulphate and thus forms sodium ferrocyanide :

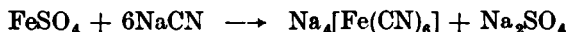

Upon boiling the alkaline ferrous salt solution, some ferric ions are inevitably produced by the action of the air ; upon the addition of dilute sulphuric acid, thus dissolving the ferrous and ferric hydroxides, the ferrocyanides reacts with the ferric salt producing ferric ferrocyanide (Prussian blue) :

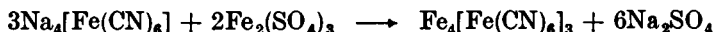

Hydrochloric acid should not be used for acidifying the alkaline solution since the yellow colour, due to the ferric chloride formed, causes the Prussian blue to appear greenish. For the same reason, ferric chloride should not be added—as is frequently recommended : a sufficient concentration of ferric ions is produced by atmospheric oxidation of the hot alkaline solution. The addition of a little dilute potassium fluoride solution may be advantageous in assisting the formation of Prussian blue in a readily filterable form.

Sulphur, as sulphide ion, is detected by precipitation as black lead sulphide with lead acetate solution and acetic acid or with sodium plumbite solution (an alkaline solution of lead acetate). Halogens are detected as the characteristic silver halides by the addition of silver nitrate solution and dilute nitric acid : the interfering influence of sulphide and cyanide ions in the latter tests are discussed under the individual elements.

* Copper oxide powder, prepared by grinding copper oxide (wire form), is heated to dull redness in a porcelain basin, allowed to cool partially in the air and finally in a desiccator.

Support a small, soft glass test-tube (50×12 mm.)* in a clamp or insert the tube through a small hole in a piece of asbestos board (or of "uralite") so that the tube is supported by the rim. Place a cube (ca. 4 mm. side = 0.04 g.) of freshly cut sodium † in the tube. Have in readiness about 0.05 g. of the compound on a spatula or the tip of a knife blade; if the compound is a liquid, charge a capillary dropper or a melting point capillary with about three drops of the liquid. Heat the ignition tube, gently at first to prevent cracking, until the sodium melts and the vapour rises 1–2 cm. in the tube. Drop the substance, preferably portionwise, directly on to the molten sodium (**CAUTION**: there may be a slight explosion, particularly with chloroform, carbon tetrachloride, nitroalkanes and azo compounds.) Remove the tube from its support and hold it by means of a pair of tongs. Heat it carefully at first, then strongly until the entire end of the tube is red hot and maintain it at this temperature for a minute or two. Plunge the tube while still hot into an evaporating basin ‡ containing about 10 ml. of distilled water, and cover the dish *immediately* with a clean wire gauze. The tube will be shattered and the residual sodium will react with the water. When the reaction is over, heat to boiling, and filter. The filtrate should be water-clear and alkaline. If it is dark coloured, decomposition was probably incomplete: repeat the entire sodium fusion.

The following *alternative procedure* is recommended and it possesses the advantage that the same tube may be used for many sodium fusions. Support a Pyrex test-tube (150×12 mm.) vertically in a clamp lined with asbestos cloth or with sheet cork. Place a cube (ca. 4 mm. side = 0.04 g.) of freshly cut sodium in the tube and heat the latter until the sodium vapour rises 4–5 cm. in the test-tube. Drop a small amount (about 0.05 g.) of the substance, preferably portionwise, directly into the sodium vapour (**CAUTION**: there may be a slight explosion); then heat the tube to redness for about 1 minute. Allow the test-tube to cool, add 3–4 ml. of methyl alcohol to decompose any unreacted sodium, then half-fill the tube with distilled water and boil gently for a few minutes. Filter and use the clear, colourless filtrate for the various tests detailed below. Keep the test-tube for sodium fusions; it will usually become discoloured and should be cleaned from time to time with a little scouring powder.

Nitrogen. Pour 2–3 ml. of the filtered "fusion" solution into a test-tube containing 0.1–0.2 g. of powdered ferrous sulphate crystals. Heat

* If preferred, suitable ignition tubes may be prepared by the student from soft glass tubing: it is important that the thickness of the glass at the closed end be uniform, otherwise the tube is likely to crack when heated. The simplest procedure is to blow a small bulb of uniform wall thickness at the end of the tube. The small test-tubes are available from all laboratory supply dealers.

† **CAUTION**: Handle sodium with great care. Small pieces for sodium fusions may be kept in a small dry bottle. Larger quantities and pieces are better kept under solvent naphtha or xylene. Do not handle the metal with the fingers: use tongs or pincers or a penknife. If the sodium is stored under naphtha or xylene, dry it quickly with filter paper immediately before use. Any residual sodium should be placed in the bottle for "*Sodium Residues*." Never throw small pieces of residual sodium in the sink or into water; if you wish to destroy sodium residues, use methylated spirit.

‡ An alternative technique is as follows. Plunge the hot tube into about 10 ml. of water contained in a small, clean mortar and cover the latter immediately with a clean wire gauze. When the reaction is over, grind the mixture of solution and broken glass to ensure thorough extraction of the sodium salts. Transfer with the aid of a little water to a porcelain basin, heat to boiling, and filter.

the mixture gently with shaking until it boils, then, without cooling, add just sufficient dilute sulphuric acid to dissolve the iron hydroxides and give the solution an acid reaction. {The addition of 1 ml. of 5 per cent. potassium fluoride solution is beneficial (possibly owing to the formation of potassium ferrifluoride $K_3[FeF_6]$) and usually leads to a purer Prussian blue.} A Prussian blue precipitate or coloration indicates that nitrogen is present. If no blue precipitate appears at once, allow to stand for 15 minutes, filter through a small filter and wash the paper with water to remove all traces of coloured solution : any Prussian blue present will then become perceptible in the cone of the filter paper. If in doubt, repeat the sodium fusion, preferably using a mixture of the compound with pure sucrose or naphthalene. In the absence of nitrogen, the solution should have a pale yellow colour due to iron salts.

If sulphur is present, a *black* precipitate of ferrous sulphide is obtained when the ferrous sulphate crystals dissolve. Boil the mixture for about 30 seconds, and acidify with dilute sulphuric acid ; the ferrous sulphide dissolves and a precipitate of Prussian blue forms if nitrogen is present.

Sulphur. This element may be tested for by any one of the following three methods :

(a) Prepare a solution of sodium plumbite by adding 10 per cent. sodium hydroxide solution to a few drops of about *N* lead acetate solution until the white precipitate of lead hydroxide initially formed just redissolves to a clear solution. Add 1 ml. of the "fusion" solution : the presence of sulphur is indicated by a black precipitate of lead sulphide.

(b) Acidify 2 ml. of the "fusion" solution with dilute acetic acid, and add a few drops of lead acetate solution. A black precipitate of lead sulphide indicates the presence of sulphur.

(c) To 2 ml. of the "fusion" solution add 2-3 drops of a freshly-prepared dilute solution (*ca.* 0.1 per cent.) of sodium nitroprusside $Na_2[Fe(CN)_5NO]$. (The latter may be prepared by adding a minute crystal of the solid to about 2 ml. of water.) A purple coloration indicates sulphur ; the coloration slowly fades on standing.

Halogens. If nitrogen and/or sulphur are present, the addition of silver nitrate to the acidified "fusion" solution will precipitate silver cyanide and/or silver sulphide in addition to the silver halides. The removal of hydrogen cyanide and/or hydrogen sulphide before precipitation of the silver halides is effected by boiling the "fusion" solution, just acidified with dilute nitric acid, in an evaporating basin until it has been reduced to half its original volume. Cool, dilute with an equal volume of water and add a few drops of silver nitrate solution. A white or pale yellow precipitate, which darkens rapidly upon exposure to light, indicates the presence of halogen.

Nitrogen and sulphur absent. (i) *If only one halogen is present*, acidify with dilute nitric acid and add excess of silver nitrate solution. A precipitate indicates the presence of a halogen. Decant the mother liquor and treat the precipitate with dilute aqueous ammonia solution. If the precipitate is white and readily soluble in the ammonia solution, chlorine is present ; if it is pale yellow and difficultly soluble, bromine is present ; if it is yellow and insoluble, then iodine is indicated. Iodine and bromine should be confirmed by the tests given below.

If one or more halogens may be present, proceed as follows :

(ii) Acidify 1–2 ml. of the “fusion” solution with a moderate excess of glacial acetic acid and add 1 ml. of carbon tetrachloride. Then introduce 20 per cent. sodium nitrite solution drop by drop with constant shaking. A purple or violet colour in the organic layer indicates the presence of iodine. The reaction is :



This solution may also be employed in the test for bromine. If iodine has been found, add small amounts of sodium nitrite solution, warm slightly and shake with fresh 1 ml. portions of carbon tetrachloride until the last extract is colourless ; boil the acid solution until no more nitrous fumes are evolved and cool. If iodine is absent, use 1 ml. of the “fusion” solution which has been strongly acidified with glacial acetic acid. Add a small amount of lead dioxide, place a strip of fluorescein paper across the mouth of the tube, and warm the solution. If bromine is present, it will colour the test paper rose-pink (eosin).

Fluorescein test paper is prepared by dipping filter paper into a dilute solution of fluorescein in ethyl alcohol ; it dries rapidly and is then ready for use. The test paper has a lemon yellow colour.

Lead dioxide in acetic acid solution gives lead tetra-acetate which oxidises hydrogen bromide (and also hydrogen iodide), but has practically no effect under the above experimental conditions upon hydrogen chloride.

(iii) Acidify 1–2 ml. of the “fusion” solution with dilute sulphuric acid, cool, and add 1 ml. of carbon tetrachloride. Prepare the equivalent of “chlorine water” by acidifying 10 per cent. sodium hypochlorite solution with one fifth of its volume of dilute hydrochloric acid. Add this solution dropwise (use a dropper) with vigorous shaking to the mixture. If iodine is present, the organic phase first becomes purple in colour. As the addition of the “chlorine water” is continued, the purple colour disappears (owing to the oxidation of the iodine to iodate) and, if bromine is present, is replaced by a brown or reddish colour. If bromine is absent, the organic layer will be colourless. It is, of course, evident that if the carbon tetrachloride layer remains uncoloured, the halogen present is chlorine.

(iv) Acidify 1–2 ml. of the “fusion” solution with acetic acid, add a slight excess of pure lead dioxide (say, 0.5 g.) and boil gently until all the iodine and bromine are liberated. Dilute, filter off the excess of lead dioxide, and test for chloride with dilute nitric acid and silver nitrate solution.

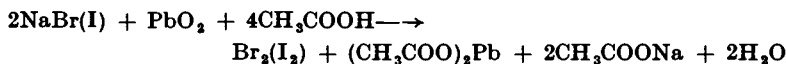

Nitrogen and sulphur present. Just acidify 2–3 ml. of the “fusion” solution with dilute nitric acid, and evaporate to half the original volume in order to expel hydrogen cyanide and/or hydrogen sulphide which may be present. Dilute with an equal volume of water. If only one halogen is present, proceed as in tests (i) or (iii). If one or more halogens may be present, use tests (ii), (iii) or (iv).

Alternatively, add 1 or 2 drops of 5 per cent. nickel nitrate solution to 2-3 ml. of the "fusion" solution, filter off the nickel cyanide and/or nickel sulphide, acidify the filtrate with 2*N* nitric acid, and test for halides as above.

The detection of the following elements, which occur infrequently in organic compounds, is included here for the sake of completeness.

Fluorine. Strongly acidify 2 ml. of the "fusion" solution with glacial acetic acid, and boil until the volume is reduced by about one half. Cool. Use either of the following tests.

(a) Place one drop of the solution upon zirconium-alizarin-S test paper.* A yellow colour on the red paper indicates the presence of fluoride.

(b) Add a few drops of saturated calcium chloride solution, and allow to stand for several hours. If fluorine is present, a gelatinous precipitate of calcium fluoride will form.

Phosphorus. The presence of phosphorus may be indicated by a smell of phosphine during the sodium fusion. Treat 1 ml. of the "fusion" solution with 3 ml. of concentrated nitric acid and boil for one minute. Cool and add an equal volume of ammonium molybdate reagent. Warm the mixture to 40-50°, and allow to stand. If phosphorus is present, a yellow crystalline precipitate of ammonium phosphomolybdate will separate.

It is usually preferable to oxidise the compound directly as follows. Intimately mix 0.02-0.05 g. of the compound with 3 g. of sodium peroxide and 2 g. of anhydrous sodium carbonate in a nickel crucible. Heat the crucible and its contents with a small flame, gently at first, afterwards more strongly until the contents are fused, and continue heating for a further 10 minutes. Allow to stand, extract the contents of the crucible with water, and filter. Add excess of concentrated nitric acid to the filtrate and test with ammonium molybdate reagent as above. A yellow precipitate indicates the presence of phosphorus. It must be borne in mind that the above treatment will convert any arsenic present into arsenate.

Arsenic. The presence of arsenic in an organic compound is generally revealed by the formation of a dull grey mirror of arsenic on the walls of the test-tube when the compound is fused with sodium in the Lassaigntest. Usually sufficient arsenic is found in the "fusion" solution to give a yellow precipitate of arsenic trisulphide when the solution is acidified with hydrochloric acid and treated with hydrogen sulphide.

It is recommended that the compound be fused with a mixture of sodium carbonate (2 parts) and sodium peroxide (1 part) as in the test for *Phosphorus*. Extract the fused mass with water, filter, and acidify with dilute hydrochloric acid. Pass hydrogen sulphide through the hot solution; arsenic is precipitated as yellow arsenic sulphide. If antimony is present, it will be precipitated as orange antimony trisulphide.

Mercury. Upon heating a mixture of the compound with soda lime in a long test-tube, a bright metallic mirror and, finally, drops of mercury will form in the upper part of the tube if mercury is present.

THE SODIUM CARBONATE - ZINC METHOD FOR THE DETECTION OF NITROGEN, SULPHUR AND HALOGENS IN ORGANIC COMPOUNDS

The Lassaigntest procedure for detecting nitrogen in organic compounds frequently gives unsatisfactory results with explosive compounds (diazonium salts, polynitro compounds and the like) and with certain volatile nitrogenous substances, such as bases, their acyl derivatives or their salts. These difficulties

* For further details, see A. I. Vogel, *Text-Book of Macro and Semimicro Qualitative Inorganic Analysis*, Fourth Edition, 1954, p. 363 (Longmans, Green and Co. Ltd.).

may often be surmounted either by mixing the compound with pure naphthalene or sucrose, or by mixing the substance with sodium and placing a layer of soda lime above the mixture. Difficulties are also sometimes experienced in the sodium fusion test with liquids of low boiling point, such as ethyl bromide. Satisfactory results are obtained by heating the organic compound with sodium carbonate and zinc powder (Middleton, 1935). The latter method has been proposed for the detection of the common elements in all organic compounds. It is doubtful, however, whether it is to be preferred to the sodium fusion procedure in routine testing for elements, although it may be recommended for those relatively few cases in which the Lassaigne test is not entirely satisfactory.

When an organic compound is heated with a mixture of zinc powder and sodium carbonate, the nitrogen and halogens are converted into sodium cyanide and sodium halides respectively, and the sulphur into zinc sulphide (insoluble in water). The sodium cyanide and sodium halides are extracted with water and detected as in Lassaigne's method, whilst the zinc sulphide in the residue is decomposed with dilute acid and the hydrogen sulphide is identified with sodium plumbite or lead acetate paper. The test for nitrogen is thus not affected by the presence of sulphur: this constitutes an advantage of the method.

Prepare the zinc powder - sodium carbonate mixture by grinding together in a dry, clean mortar 25 g. of A.R. anhydrous sodium carbonate and 50 g. of the purest obtainable zinc powder. The reagent is unlikely to contain nitrogen, but traces of sulphur and halogens may be present. It is therefore essential to carry out a blank or control test for sulphur and halogens with every fresh batch of the mixture.

Place about 0.1 g. of the powdered compound in a small dry test-tube, add sufficient of the reagent to give a column about 1 cm. high, and then shake the closed tube until the contents are well mixed. Now add more reagent, without mixing with the material already in the tube, until the total height is about 3 cm. If the compound is a liquid, introduce 2-3 drops into a small dry test-tube, add sufficient of the mixture to form a column about 1 cm. long, and allow the liquid to soak well into the reagent. Then add more reagent, without mixing, until a total height of about 3 cm. is secured. Hold the tube horizontally (use tongs or a special test-tube holder) and, by means of a *small* flame, heat a 1 cm. length of the mixture gently near the open end. Gradually increase the size of the flame until the mixture is red hot at the end. Extend the heating gradually and cautiously towards the closed end of the tube until the whole of the mixture is red hot. (The extension of the heating towards the closed end of the tube must be carried out with great care, otherwise the mixture may be projected from the tube; if the mixture tends to be pushed out of the tube by the evolution of gas, stop the heating momentarily and rotate the tube while still in a horizontal position in order to redistribute the contents.) Finally heat the tube to redness in a vertical position for a minute or two and, while the end of the tube is still red hot, plunge the tube in about 10 ml. of water in a porcelain dish. Boil the contents of the dish gently for 1-2 minutes and filter. (If the filtrate is not colourless, repeat the whole process.) Retain the residue in the basin for the sulphur test. Divide the clear filtrate into two portions.

Nitrogen. Treat one portion with 1–2 ml. of 5 per cent. sodium hydroxide solution and 0.1 g. of powdered ferrous sulphate. Boil for 1 minute and cool. Cautiously acidify with dilute sulphuric acid (carbon dioxide is evolved). A precipitate of Prussian blue indicates that nitrogen is present.

Halogens. Proceed as described under the Lassaigne test. If nitrogen is present, the cyanide must first be eliminated.

Sulphur. Moisten the centre of a filter paper with sodium plumbite solution. Add about 10 ml. of dilute hydrochloric acid to the residue in the dish and immediately cover it with the prepared filter paper. If zinc sulphide is present in the residue, a dark brown stain, visible on the upper surface of the paper, will be obtained: frequently the presence of hydrogen sulphide can also be detected by its odour.

XI.4. THE SOLUBILITIES OF ORGANIC COMPOUNDS

When a mixture of a specified amount of a given solute and a specified amount of a given solvent forms a homogeneous liquid, the former is said to be soluble in the latter. This essentially practical definition of solubility* forms the basis of the various schemes which have been proposed to employ solubility as a basis for the classification of organic compounds (O. Kamm, 1922; H. Staudinger, 1923). A detailed discussion of the relationship between solubility and chemical constitution in organic compounds is outside the scope of this work,† but the following qualitative generalisations (to which numerous exceptions are known), due largely to Kamm, may be found helpful.

1. *A compound is most soluble in that solvent to which it is most closely related in structure.* Thus *n*-hexane, which is sparingly soluble in water, dissolves in three volumes of methyl alcohol, is more soluble in anhydrous ethyl alcohol, and is completely miscible with *n*-butyl and higher alcohols. As the chain length increases the compound tends to resemble the hydrocarbon more and more, and hence the solubility increases.

The mono-hydroxy and mono-carboxy derivatives of the hydrocarbons (alcohols and carboxylic acids) are soluble in ether: the lower homologues (up to about C₅—see below) are soluble in water. If two or more hydroxyl groups are present in the molecule, the compound becomes more like water in structure and less like the hydrocarbons; consequently the solubility in water increases and the solubility in ether decreases. The following examples may be quoted: ethyl and *n*-propyl alcohol are completely miscible with ether and with water, but ethylene glycol and glycerol whilst very soluble in water are almost insoluble in ether; the carbohydrates, which contain several hydroxyl groups, are very soluble in water but insoluble in ether; succinic acid is sparingly soluble and malic, tartaric and citric acids are insoluble in ether, but all of these polybasic acids are soluble in water. Most salts (derived from organic acidic substances

* The arbitrary standard employed in this book is 0.1 g. of solid or 0.2 ml. of liquid to 3 ml. of solvent.

† See, for example, J. H. Hildebrand and R. L. Scott, *The Solubility of Nonelectrolytes*, 1950 (Reinhold).

and inorganic bases, or from organic bases and mineral acids) are soluble in water but insoluble in ether.

2. *The effect of a halogen atom or of phenyl is analogous to an increase in the number of carbon atoms.*

3. *As one ascends a given homologous series, the physical properties of the members increasingly resemble those of the hydrocarbons from which they may be regarded as derived.* Thus the solubility of alcohols in water decreases as the series is ascended and for normal alcohols, the limit of solubility lies between C_4 and C_5 . Branching of the carbon chain of the alkyl group decreases the effect of this group, hence a branched-chain alcohol is usually more soluble than a straight-chain alcohol of the same carbon content. The influence of various constitutional factors upon the solubilities of alcohols at 20° will be apparent from an examination of Table XI, 4.1.

TABLE XI, 4.1. SOLUBILITIES OF ALCOHOLS IN WATER AT 20°

ALCOHOL	FORMULA	SOLUBILITY (G./100 ML. OF H_2O)
Methyl	CH_3OH	∞
Benzyl	$C_6H_5CH_2OH$	4.0
Ethyl	CH_3CH_2OH	∞
β -Chloroethyl	$ClCH_2CH_2OH$	∞
<i>n</i> -Propyl	$CH_3CH_2CH_2OH$	∞
<i>iso</i> Propyl	$CH_3CH(OH)CH_3$	∞
γ -Chloropropyl	$ClCH_2CH_2CH_2OH$	50.0
γ -Bromopropyl	$BrCH_2CH_2CH_2OH$	∞
1-Chloro-2-propanol	$ClCH_2CH(OH)CH_3$	∞
1 : 3-Dichloro-2-propanol	$ClCH_2CH(OH)CH_2Cl$	11.0
<i>n</i> -Butyl	$CH_3CH_2CH_2CH_2OH$	8.3
<i>iso</i> Butyl	$(CH_3)_2CHCH_2OH$	9.6
<i>sec.</i> -Butyl	$CH_3CH_2CH(OH)CH_3$	13.0
<i>tert.</i> -Butyl	$(CH_3)_3COH$	∞
<i>n</i> -Amyl	$CH_3(CH_2)_4OH$	2.0
Methyl <i>n</i> -propyl carbinol	$CH_3CH_2CH_2CH(OH)CH_3$	6.0
Diethyl carbinol	$CH_3CH_2CH(OH)CH_2CH_3$	8.0
<i>iso</i> Butyl carbinol	$(CH_3)_2CHCH_2CH_2OH$	2.8
Dimethyl ethyl carbinol	$(CH_3)_2C(OH)CH_2CH_3$	12
<i>n</i> -Hexyl alcohol	$CH_3(CH_2)_5OH$	0.5
<i>n</i> -Heptyl alcohol	$CH_3(CH_2)_6OH$	0.12

The lower members of other homologous series of oxygen compounds—the acids, aldehydes, ketones, anhydrides, ethers and esters—have approximately the same limits of solubility as the alcohols and substitution and branching of the carbon chain has a similar influence. For the amines (primary, secondary and tertiary), the limit of solubility is about C_6 , whilst for the amides and nitriles it is about C_4 .

4. *Compounds of very high molecular weight frequently exhibit decreased solubility in inert solvents.** Thus whilst glucose ($C_6H_{10}O_6$) and methyl

* Inert solvents, e.g., water and ether, are those solvents from solutions in which the solute may be recovered by simple evaporation.

acrylate ($\text{CH}_2=\text{CHCOOCH}_3$) are readily soluble in water, the polymers starch, cellulose and glycogen ($\text{C}_6\text{H}_{10}\text{O}_5$) $_n$ and methyl acrylate resin are insoluble in water. Some exceptions are known, for example, methyl cellulose and the polyethylene oxides $\text{HOCH}_2(\text{CH}_2-\text{O}-\text{CH}_2)_n\text{CH}_2\text{OH}$ (n up to 100) dissolve in water.

5. *The solubility of solid compounds is dependent upon the molecular aggregation in the solid state.* The molecular aggregation in the solid state finds some expression in the melting points of the compounds or, otherwise expressed, the melting point of a solid is generally a criterion of the intermolecular cohesive forces. Heat is required to overcome these forces and convert the solid into a liquid; hence the higher the m.p., the greater is the intermolecular attraction. The solution of a solid involves a similar destruction of the intermolecular forces so that, for structurally related compounds, higher melting points are associated with lower solubilities in inert solvents.* The solubilities of some stereoisomers in water and in alcohol are collected in Table XI, 4.2.

TABLE XI, 4.2. SOLUBILITIES OF STEREOISOMERS IN WATER AND IN ALCOHOL

COMPOUND	M.P.	SOLUBILITY IN 100 G. OF SOLVENT AT 20°	
		WATER	ALCOHOL
Maleic acid (<i>cis</i>)	135° †	60 g.	51 g.
Fumaric acid (<i>trans</i>)	286°	0.6 g.	5 g.
<i>d</i> -Tartaric acid	170°	139 g.	27 g. (25°)
<i>l</i> -Tartaric acid	170°	139 g.	27 g. (25°)
<i>dl</i> -Tartaric acid	206°	20 g.	2 g. (25°)

† The m.p. depends upon the rate of heating: the pure acid has m.p. 143° (see Section III, 143), but commercial samples usually melt at a slightly lower temperature.

Similar relationships are found among the position isomers in benzene derivatives, but some abnormal results are encountered. Among compounds of a homologous series, high melting points often correspond to lower solubilities. Thus with the aliphatic dibasic acids $\text{HOOC}(\text{CH}_2)_n\text{COOH}$, the "even" acid has the higher melting point and lower solubility in water than the next higher homologue ("odd" acid). This can be clearly seen from an examination of Table XI, 4.3.

An interesting illustration is urea $\text{CO}(\text{NH}_2)_2$, m.p. 132°, which is very soluble in water, and oxamide $(\text{CONH}_2)_2$, m.p. 420°, which is sparingly soluble in water.

* This does not apply to salts; these are highly polar compounds, dissociate in solution in water, and are usually very soluble.

TABLE XI, 4.3. MELTING POINTS AND SOLUBILITIES OF DIBASIC ACIDS, $\text{HOOC}(\text{CH}_2)_n\text{COOH}$

ACID	M.P.	SOLUBILITY (G./100 G. OF H_2O) AT 20°
Oxalic ($n = 0$) . . .	189°	9.5
Malonic ($n = 1$) . . .	135°	73.5
Succinic ($n = 2$) . . .	185°	6.9
Glutaric ($n = 3$) . . .	98°	63.9
Adipic ($n = 4$) . . .	152°	1.5
Pimelic ($n = 5$) . . .	105°	4.9
Suberic ($n = 6$) . . .	142°	0.15
Azelaic ($n = 7$) . . .	106°	0.24
Sebacic ($n = 8$) . . .	134°	0.10

6. *Solvation increases solubility above predicted values.* When the components of a solution possess an abnormally large attraction for each other, "solvates" are formed. Thus certain oxygen-containing compounds have a great tendency to form hydrates, thus contributing to increased water solubility: hydrogen bonding also plays an important rôle.

SOLUBILITY IN REACTION SOLVENTS

In addition to water and ether, the following reagents are employed as "solvents" for the characterisation of organic compounds: 5 per cent. aqueous solutions of hydrochloric acid and of sodium hydroxide, and also concentrated sulphuric acid.

Dilute hydrochloric acid. Most compounds that are soluble in dilute hydrochloric acid contain a basic nitrogen atom in the molecule. Thus most aliphatic amines (primary, secondary and tertiary) form salts (polar, water-soluble compounds) with hydrochloric acid. Primary aromatic amines (*e.g.*, aniline) behave similarly, but in secondary and tertiary purely aromatic amines (*e.g.*, diphenylamine and triphenylamine) the basic character of the nitrogen atom has been diminished to such an extent that they do not form salts with dilute hydrochloric acid and consequently do not dissolve. Arylalkylamines and alicyclic amines, however, do dissolve. A few types of oxygen-containing compounds (such as the pyrones and the anthocyanidin pigments of certain flowers) which form oxonium salts dissolve in dilute hydrochloric acid. Amides RCONH_2 , RCONHR' and $\text{RCONR}'\text{R}''$, which are insoluble in water, are generally neutral to 5 per cent. hydrochloric acid but may dissolve in higher concentrations (10–20 per cent.) of acid: this emphasises the importance of employing the correct strength of acid in the solubility tests.

Dilute sodium hydroxide solution. Carboxylic acids (RCOOH), sulphonic acids (RSO_3H), phenols (ArOH), thiophenols (ArSH), mercaptans (RSH), imides (RCONHCOR), aryl sulphonamides (ArSO_2NH_2), arylsulphonyl derivatives of primary amines (ArSO_2NHR), oximes ($\text{RCH}=\text{NOH}$), primary and secondary nitro compounds ($\text{RCH}=\text{NOOH}$ and $\text{R}_2\text{C}=\text{NOOH}$ -*aci* forms), and some enols (*e.g.*, of 1:3-diketones

$RCH(OH)=CHCOR$ or β -keto esters $RCH(OH)=CHCOOR'$ dissolve in dilute sodium hydroxide solution, *i.e.*, contain an acidic group of sufficient strength to react with the alkali. Carboxylic acids and sulphonic acids are soluble in dilute solutions of sodium bicarbonate: some negatively-substituted phenols, for example, picric acid, 2:4:6-tribromophenol and 2:4-dinitrophenol, are strongly acidic and also dissolve in dilute sodium bicarbonate solution.

The presence of certain substituents (*e.g.*, the amino group) may markedly affect the solubility and other properties of the sulphonic acid or carboxylic acid. Thus such sulphonic acids as the aminobenzenesulphonic acids, pyridine- and quinoline-sulphonic acids exist in the form of inner salts or "zwitter-ions" that result from the interaction of the basic amino group and the acidic sulphonic acid. Sulphanilic acid, for example, is more accurately represented by formula (I) than by formula (II):

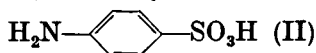
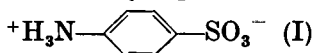

These aminosulphonic acids possess the high melting points usually associated with salts and are sparingly soluble or insoluble in water. They all dissolve readily in dilute alkali but not in dilute acid, *i.e.*, they appear to exhibit the reactions of the sulphonic acid group but not of the amino group. The aliphatic aminocarboxylic acids, because of the presence of the strongly basic amino group, exist as inner salts:

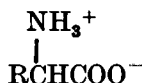

they are soluble in water but not in ether, and dissolve in both dilute acid and dilute alkali. The carboxyl derivatives of the arylamines (*e.g.*, *p*-aminobenzoic acid) are also amphoteric, but the diminution of the basic character of the amino group because of its attachment to the aryl group prevents the formation of inner salts to any degree.

Concentrated sulphuric acid. The paraffin hydrocarbons, *cyclo*-paraffins, the less readily sulphonated aromatic hydrocarbons (benzene, toluene, xylenes, etc.) and their halogen derivatives, and the diaryl ethers are generally insoluble in cold concentrated sulphuric acid. Unsaturated hydrocarbons, certain polyalkylated aromatic hydrocarbons (such as mesitylene) and most oxygen-containing compounds are soluble in the cold acid.

Unsaturated hydrocarbons dissolve through the formation of soluble alkyl hydrogen sulphates:



Polyalkylated aromatic hydrocarbons and alkyl phenyl ethers are sulphonated:

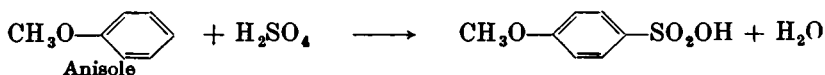
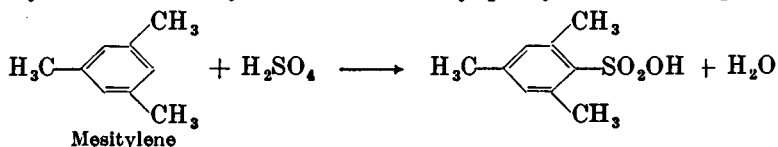

Many oxygen-containing compounds dissolve because of the formation of oxonium salts; the latter are readily decomposed (hydrolysed) by pouring the acid into ice water.

The purpose of the reagent is merely to ascertain whether the substance is soluble in the concentrated acid or not. For this reason, the attendant disadvantages of the reagent—the production of more fundamental changes with certain oxygen-containing compounds than mere dissolution or oxonium salt formation—are of secondary importance provided careful distinction be made between the solubility of the original compound and the insolubility of the *products* of the reaction. Thus certain unsaturated hydrocarbons yield insoluble polymers, and benzyl alcohol affords an insoluble poly-benzyl alcohol of the average composition



Compounds which dissolve in concentrated sulphuric acid may be further subdivided into those which are soluble in syrupy phosphoric acid (*A*) and those which are insoluble in this solvent (*B*); in general, dissolution takes place without the production of appreciable heat or colour. Those in class *A* include alcohols, esters, aldehydes, methyl ketones and cyclic ketones provided that they contain less than nine carbon atoms. The solubility limit is somewhat lower than this for ethers: thus *n*-propyl ether dissolves in 85 per cent. phosphoric acid but *n*-butyl ether and anisole do not. Ethyl benzoate and ethyl malonate are insoluble.

XI.5.

THE SOLUBILITY GROUPS

It has been found convenient (O. Kamm, 1922) to place organic compounds into seven solubility groups on the basis of:

(a) their solubility behaviour towards water, ether, 5 per cent. aqueous sodium hydroxide solution, 5 per cent. hydrochloric acid and cold concentrated sulphuric acid, and

(b) the elements, other than carbon and hydrogen, that they contain.

The resulting groups are:

Group I. Compounds soluble in both water and ether.

Group II. Compounds soluble in water, but insoluble in ether.

Group III. Compounds insoluble in water, but soluble in dilute sodium hydroxide. This group may be further subdivided into Group IIIA—soluble in dilute sodium hydroxide and soluble in dilute sodium bicarbonate; and Group IIIB—soluble in dilute sodium hydroxide and insoluble in dilute sodium bicarbonate.

Group IV. Compounds insoluble in water, but soluble in dilute hydrochloric acid.

Group V. Hydrocarbons and compounds containing C, H and O that are not in Groups I-IV and are soluble in concentrated sulphuric acid ("indifferent compounds").

This group may be further subdivided into **Group VA**—soluble in concentrated sulphuric acid and soluble in 85 per cent. phosphoric acid—and **Group VB**—soluble in concentrated sulphuric acid and insoluble in 85 per cent. phosphoric acid.

Group VI. All compounds, not containing N or S, that are insoluble in concentrated sulphuric acid.

Group VII. Compounds that contain N or S which are not in Groups I-IV. Many of the compounds in this group are soluble in concentrated sulphuric acid.

It will be observed that halogen compounds are not listed separately, but appear in each of the seven groups in accordance with their solubility behaviour. Similarly, certain compounds containing N or S will fall in Groups I-IV (see preceding Section).

Table XI,5,1 shows this grouping of organic compounds, together with the commoner classes of compounds that fall into the respective solubility groups.

TABLE XI,5,1.

DIVISION OF ORGANIC COMPOUNDS INTO SOLUBILITY GROUPS

Group I <i>Soluble in Both Ether and Water</i>	Group II <i>Soluble in Water but Insoluble in Ether</i>	Group III <i>Soluble in 5 % Sodium Hydroxide Solution</i>	Group IV <i>Soluble in 5 % Hydrochloric Acid</i>	Group V <i>Not Containing N or S. Soluble only in Concentrated Sulphuric Acid</i>	Group VI <i>Not Containing N or S. Insoluble in Concentrated Sulphuric Acid</i>	Group VII <i>Containing N or S. Compounds Not in Groups I to IV</i>
<p>The lower members of the homologous series of :</p> <ol style="list-style-type: none"> 1. Alcohols 2. Aldehydes 3. Ketones 4. Acids 5. Esters 6. Phenols 7. Anhydrides 8. Amines 9. Nitriles 10. Polyhydroxy phenols 	<ol style="list-style-type: none"> 1. Polybasic acids and hydroxy acids. 2. Glycols, polyhydric alcohols, polyhydroxy aldehydes and ketones (sugars) 3. Some amides, amino acids, di- and polyamino compounds, amino alcohols 4. Sulphonic acids 5. Sulphinic acids 6. Salts 	<ol style="list-style-type: none"> 1. Acids 2. Phenols 3. Imides 4. Some primary and secondary nitro compounds; oximes 5. Mercaptans and thiophenols 6. Sulphonic acids, sulphinic acids, sulphuric acids, and sulphonamides 7. Some diketones and β-keto esters 	<ol style="list-style-type: none"> 1. Primary amines 2. Secondary aliphatic and aryl-alkyl amines 3. Aliphatic and some aryl-alkyl tertiary amines 4. Hydrazines 	<ol style="list-style-type: none"> 1. Unsaturated hydrocarbons 2. Some polyalkylated aromatic hydrocarbons 3. Alcohols 4. Aldehydes 5. Ketones 6. Esters 7. Anhydrides 8. Ethers and acetals 9. Lactones 10. Acyl halides 	<ol style="list-style-type: none"> 1. Saturated aliphatic hydrocarbons 2. Cyclic paraffin hydrocarbons 3. Aromatic hydrocarbons 4. Halogen derivatives of 1, 2 and 3 5. Diaryl ethers 	<ol style="list-style-type: none"> 1. Nitro compounds (tertiary) 2. Amides and derivatives of aldehydes and ketones 3. Nitriles 4. Negatively substituted amines 5. Nitroso, azo, hydrazo, and other intermediate reduction products of nitro compounds 6. Sulphones, sulphonamides of secondary amines, sulphides, sulphates and other sulphur compounds

NOTES ON TABLE XI,5,1

Group I. This includes the lower members of the various homologous series (4–5 atoms in a normal chain) that contain oxygen and/or nitrogen in their structures: they are soluble in water because of their low carbon content. If the compound is soluble in both water and ether, it would also be soluble in other solvents so that further solubility tests are generally unnecessary: the test with sodium bicarbonate solution should, however, be performed (see Section XI,6).

Group II. The classes 1 to 5 are usually soluble in dilute alkali and acid. Useful information may, however, be obtained by examining the behaviour of *Salts* to alkaline or acidic solvents. With a salt of a water-soluble base, the characteristic odour of an amine is usually apparent when it is treated with dilute alkali: likewise, the salt of a water-soluble, weak acid is decomposed by dilute hydrochloric acid or by concentrated sulphuric acid. The water-soluble salt of a water-insoluble acid or base will give a precipitate of either the free acid or the free base when treated with dilute acid or dilute alkali. The salts of sulphonic acids and of quaternary bases (R_4NOH) are unaffected by dilute sodium hydroxide or hydrochloric acid.

Group III. Carboxylic and sulphonic acids (also *sym.*-tribromophenol, 2:4-dinitrophenol and picric acid) are also soluble in dilute sodium bicarbonate solution.

Group IV. The student should remember that the hydrochlorides of some bases are sparingly soluble in cold water and should therefore not be misled by an apparent insolubility of a compound (containing N) in dilute hydrochloric acid. The suspension in dilute hydrochloric acid should always be filtered and the filtrate made alkaline. A precipitate will indicate that the compound should be placed in Group IV: if no precipitate is formed, the compound is relegated to Group VII.

Group V. This group includes all the water-insoluble hydrocarbons and oxygen compounds that do not contain N or S and are soluble in cold concentrated sulphuric acid. Any changes—colour, excessive charring, evolution of gases or heat, polymerisation and precipitation of an insoluble compound—attending the dissolution of the substance should be carefully noted.

Alcohols, esters (but not ethyl benzoate, ethyl malonate or ethyl oxalate), aldehydes, methyl ketones and cyclic ketones containing less than nine carbon atoms as well as ethers containing less than seven carbon atoms are soluble in 85 per cent. phosphoric acid.

Group VI. Concentrated sulphuric acid provides a simple test for the differentiation *inter alia* between (a) saturated paraffin and cyclic hydrocarbons and also simple aromatic hydrocarbons and (b) unsaturated hydrocarbons.

Group VII. This group comprises all compounds containing N or S which are insoluble in water and are indifferent (*i.e.*, insoluble in dilute acid or alkali).

An outline of the solubility classification procedure is given in Table XI,5,2, whilst the characteristic features of each of the solubility groups are summarised in Table XI,5,3.

TABLE XI,5,2. OUTLINE OF SOLUBILITY CLASSIFICATION PROCEDURE

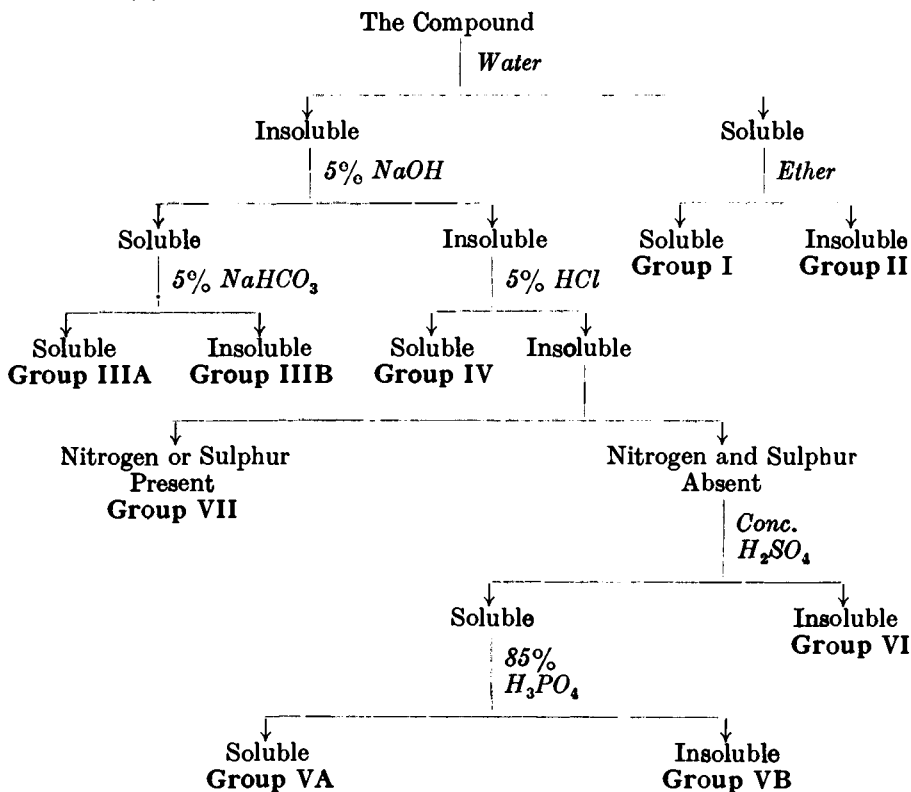

TABLE XI,5,3. CLASSIFICATION OF SOLUBILITY GROUPS

Group	Water	Ether	NaOH	NaHCO ₃	HCl	H ₂ SO ₄	H ₃ PO ₄
I	+	+					
II	+	—					
IIIA	—		+	+			
IIIB	—		+	—			
IV	—		—		+		
VA (3)	—		—		—	+	+
VB (3)	—		—		—	+	—
VI (3)	—		—		—	—	
VII (4)	—		—		—		

Notes.

(1) + denotes soluble ; — denotes insoluble.

(2) If a compound contains nitrogen its solubility in dilute hydrochloric acid should be tested also to ascertain whether it is amphoteric.

(3) These are neutral compounds in which nitrogen and sulphur are *absent*.

(4) These are neutral compounds in which nitrogen or sulphur is *present*.

XI,6. DETERMINATION OF THE SOLUBILITIES OF ORGANIC COMPOUNDS (*for Group Tests*)

All solubility determinations for Group tests are carried out at the laboratory temperature in small test-tubes (*e.g.*, 100 × 12 mm.) but of sufficient size to permit of vigorous shaking of the solvent and the solute.

Amount of material required. It is convenient to employ an arbitrary ratio of 0·10 g. of solid or 0·20 ml. of liquid for 3·0 ml. of solvent. Weigh out 0·10 g. of the *finely-powdered* solid to the nearest 0·01 g.: after some experience, subsequent tests with the *same* compound may be estimated by eye. Measure out 0·20 ml. of the liquid either with a calibrated dropper (Fig. II, 27, 1) or a small graduated pipette. Use either a calibrated dropper or a graduated pipette to deliver 3·0 ml. of solvent. Rinse the delivery pipette with alcohol, followed by ether each time that it is used.

Much time will be saved if each of the solvents (Water, Ether, 5 per cent. Sodium Hydroxide, 5 per cent. Sodium Bicarbonate and 5 per cent. Hydrochloric Acid) be contained in a 30 or 60 ml. bottle fitted with a cork carrying a calibrated dropper.* The concentrated sulphuric acid should be kept in a glass-stoppered bottle and withdrawn with a dropper or pipette as required.

Attention is directed to the fact that if only minute amounts of material are available or if the substance is expensive, considerable economy may be effected by treating, *e.g.*, the aqueous solution or suspension with the necessary quantity of concentrated sodium hydroxide solution or concentrated hydrochloric acid.

Solubility in water. Treat a 0·10 g. portion of the solid with successive 1·0 ml. portions of water, shaking vigorously after each addition, until 3·0 ml. have been added. If the compound does not dissolve completely in 3·0 ml. of water, it may be regarded as insoluble in water. When dealing with a liquid, add 0·20 ml. of the compound to 3·0 ml. of water and shake. In either case, test the contents of the small test-tube with litmus (or with Universal indicator paper): it is best to remove a little of the solution or supernatant liquid with a dropper.

Solubility in ether. Use 0·10 g. of solid or 0·20 ml. of a liquid in a dry test-tube and proceed exactly as in testing the solubility in water, but do not employ more than 3·0 ml. of solvent.

Solubility in 5 per cent. sodium hydroxide solution. Note whether there is any rise in temperature. If the compound appears insoluble, remove some of the supernatant liquid by means of a dropper to a semimicro test-tube (75 × 10 mm.), add 5 per cent. hydrochloric acid dropwise until acid, and note whether any precipitate (or turbidity) is formed. The production of the latter will place the compound in Group III.

Solubility in 5 per cent. sodium bicarbonate solution. If the compound is soluble in 5 per cent. sodium hydroxide solution, test its solubility in a 5 per cent. solution of sodium bicarbonate. Observe

* See, for example, A. I. Vogel, *A Text-Book of Macro and Semimicro Qualitative Inorganic Analysis*, Fourth Edition, 1954, p. 168 (Longmans, Green and Co. Ltd.). A commercial form of the apparatus ("pipette reagent bottle") is available from Baird and Tatlock (London) Ltd. The bottle has a capacity of 250 ml. and a calibrated 5 ml. pipette is fitted into the neck with a B19 ground glass joint. This is recommended for large classes of students.

whether it dissolves and particularly whether carbon dioxide is evolved either immediately (carboxylic acids, sulphonic acids, negatively substituted phenols) or after a short time (some amino acids).

Solubility in 5 per cent. hydrochloric acid. Add the acid to 0.10 g. of the solid or 0.20 ml. of the liquid in quantities of 1.0 ml. until 3.0 ml. have been introduced. Some organic bases (e.g., β -naphthylamine) form hydrochlorides that are soluble in water but are precipitated by an excess of acid: if solution occurs at any time, the unknown is assigned to Group IV. If the compound appears insoluble, remove some of the supernatant liquid by means of a dropper to a semimicro test-tube (75 \times 10 mm.), and add 5 per cent. sodium hydroxide solution until basic and observe whether any precipitate is produced: the formation of a precipitate will place the compound in Group IV.

Solubility in concentrated sulphuric acid. Place 3.0 ml. of pure concentrated sulphuric acid in a dry test-tube and add 0.10 g. of a solid or 0.20 ml. of a liquid. If the compound does not dissolve immediately, agitate for some time but do not heat. Observe any change in colour, charring, evolution of gaseous products, polymerisation accompanied by precipitation etc.

Solubility in syrupy phosphoric acid. This test should only be applied if the compound is soluble in concentrated sulphuric acid. Place 3.0 ml. of 85 per cent. orthophosphoric acid in a dry test-tube and add 0.10 g. of a solid or 0.20 ml. of a liquid. If the compound does not dissolve immediately, agitate for some time but do not boil.

Practice in solubility determinations. It is suggested that the student should carry out solubility determinations with a selection from the following compounds:

Hydrocarbons. Hexane: Toluene: Naphthalene: *cyclo*Hexane: Amylene: *cyclo*Hexene.

Halogen compounds. *n*-Butyl bromide: Chlorobenzene: Allyl bromide: Benzoyl chloride.

Alcohols. *n*-Butyl alcohol: *n*-Hexyl alcohol: *tert.*-Butyl alcohol: Benzyl alcohol: Glycerol: Sucrose.

Aldehydes and ketones. *n*-Butyraldehyde: Acetone: Methyl *n*-amyl ketone: Benzaldehyde: Acetophenone: Benzophenone.

Ethers. Di-*n*-butyl ether: Anisole: Diphenyl ether.

Esters. *n*-Butyl acetate: Ethyl acetate: Ethyl benzoate.

Acids. Acetic acid: *n*-Caproic acid: Benzoic acid: Phenylacetic acid: Succinic acid: Adipic acid: Anthranilic acid.

Phenols. Phenol: β -Naphthol.

Anhydrides. Acetic anhydride: Benzoic anhydride.

Enols. Ethyl acetoacetate.

Nitro compounds. Nitromethane: Nitrobenzene: *m*-Dinitrobenzene.

Amides and imides. Acetamide: *n*-Caproamide: Acetanilide: Benz-anilide: Phthalimide.

Amines. Aniline: Benzidine: α -Naphthylamine: *p*-Nitroaniline: Dimethylaniline.

Nitriles. *n*-Butyronitrile: Benzyl cyanide.

Salts. Sodium benzoate: Sodium benzenesulphonate: Aniline hydrochloride: Methylamine hydrochloride.

Record your results in tabular form thus:

Compound	Solubility in						Solubility Group	
	Water	Ether	5% NaOH	5% NaHCO ₃	5% HCl	Conc. H ₂ SO ₄		85% H ₃ PO ₄
Phloroglucinol	+	+						I
Benzoic acid	—		+	+				IIIA
Aniline	—		—		+			IV
Acetophenone	—		—		—	+	+	VA
n-Hexane	—		—		—			VI
Etc.								

XI.7. CLASS REACTIONS (REACTIONS FOR FUNCTIONAL GROUPS)

The qualitative analysis and the solubility behaviour of an unknown compound will serve to place it in one of the seven solubility groups (Table XI,5,1). It is then necessary to ascertain to which of the classes of the particular solubility group the compound belongs, *i.e.*, to determine the functional group (or groups) present in the substance. Many of the functional groups are to be found in more than one of the solubility groups, consequently the ensuing discussion of the characteristic class reactions will, in many instances, cover several solubility groups. Where an organic compound contains more than one functional group, the classification is generally based upon the one that is most readily detected and manipulated. Thus, benzoic acid, *p*-chlorobenzoic acid, *p*-methoxybenzoic acid (anisic acid), and *p*-nitrobenzoic acid will be classified as *acids* both by the solubility tests and the class reactions, and the identification of, say, the nitrogen-containing acid *may* be completed by the preparation of derivatives of the carboxyl group without the absolute necessity of applying the class reactions that would discover the nitro group; however, if possible, it is always advisable to establish the nature of the subsidiary functional group (or groups) since this would provide additional extremely valuable evidence for the characterisation of the unknown compound. It must also be remembered that in compounds containing two or more typical groups, the latter may influence one another so that the properties cannot easily be predicted: for example, in chlorobenzene the chlorine is not very reactive (say, towards alcoholic silver nitrate solution and to aniline), but in 1-chloro-2:4-dinitrobenzene the chlorine exhibits high reactivity to aniline (due to the presence of nitro groups in the *ortho* and *para* positions), but not to alcoholic silver nitrate.

I. UNSATURATED HYDROCARBONS. TESTS FOR UNSATURATION

Unsaturated hydrocarbons are found in Solubility Group V. The two reagents employed for the detection of unsaturation, not only of unsaturated hydrocarbons but of all classes of unsaturated compounds ($RR'C=CR''R'''$), are:

(a) a dilute solution (2-3 per cent.) of bromine in carbon tetrachloride, and

(b) a dilute aqueous solution (2 per cent.) of potassium permanganate.

It is essential to apply *both* tests, since some symmetrically substituted ethylenic compounds (e.g., stilbene $C_6H_5CH=CHC_6H_5$) react slowly under the conditions of the bromine test. With dilute permanganate solution the double bond is readily attacked, probably through the intermediate formation of a *cis* diol :

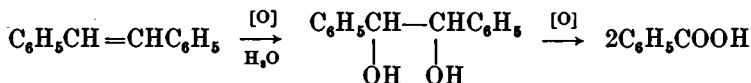

Attention is directed to the fact that other classes of organic compounds, such as phenols, aromatic amines and enols which are found in other Solubility Groups, rapidly decolourise both the bromine and permanganate reagents, but there is a fundamental difference in the reaction with the former reagent. These compounds are *substituted* by bromine and an equivalent of hydrogen bromide is evolved during the reaction white fumes when a glass stopper moistened with concentrated ammonia solution is held near the mouth of the test-tube.

Bromine test. Dissolve 0.2 g. or 0.2 ml. of the compound in 2 ml. of carbon tetrachloride, and add a 2 per cent. solution of bromine in carbon tetrachloride dropwise until the bromine colour persists for one minute. Blow across the mouth of the tube to detect any hydrogen bromide which may be evolved (compare Sections III,6 and III,11).

Potassium permanganate test. Dissolve 0.2 g. or 0.2 ml. of the substance in 2 ml. of water or in 2 ml. of acetone (which gives a negative test with the reagent), and add 2 per cent. potassium permanganate solution dropwise. The test is negative if no more than 3 drops of the reagent are decolourised.

2. SATURATED HYDROCARBONS

Generally speaking the saturated aliphatic and cyclic hydrocarbons found in Solubility Group VI are inert to most simple chemical reagents.* The aromatic hydrocarbons in this Solubility Group exhibit the usual reactivity associated with the presence of the aromatic nucleus (nitration, substitutive halogenation with chlorine or bromine in the presence of catalysts, sulphonation). The most satisfactory reagent for distinguishing between paraffin and aromatic hydrocarbons is *fuming sulphuric acid* (containing 20 per cent. of free SO_3); only the latter react :

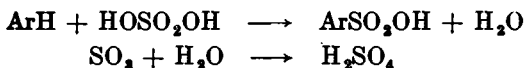

Fuming sulphuric acid test. Place 2 ml. of 20 per cent. fuming sulphuric acid in a dry test-tube, add 0.5 ml. of the hydrocarbon and shake vigorously. Only the aromatic hydrocarbon dissolves completely : heat is evolved, but excessive charring should be absent.

Aromatic hydrocarbons also form coloured and highly characteristic picrates by interaction with a solution of picric acid (Section IV,9,1).

* They do, however, react readily, even in the dark, with sulphuryl chloride in the presence of a trace of benzoyl peroxide as a catalyst (compare Section IV,22).

3. REACTIVITIES OF HALOGEN COMPOUNDS

Halogen-containing compounds may be found in each of the seven Solubility Groups. Those in Group I are of low molecular weight and owe their solubility to the presence of such groups as OH, COOH, etc. Most halogen compounds in Solubility Group II are salts in which the halogen is present as an anion; these, with the exception of quaternary ammonium salts, are converted by dilute alkali into basic compounds of Solubility Group IV. Halogen compounds may also be present in Solubility Groups III and IV, but, like those in Groups I and II, they contain other functional groups which are more easily identified. The nature of the halogen in Solubility Groups V to VII is best determined with the aid of a 2 per cent. solution of silver nitrate in absolute alcohol, the alcohol serving as a common solvent for the silver nitrate and the organic compound to be tested. For water-soluble compounds, aqueous silver nitrate solution should also be used after acidification with dilute nitric acid.

Organic compounds containing halogens react with silver nitrate in the following order of decreasing reactivity :

(i) Water-soluble compounds containing ionisable halogen or compounds such as acyl halides of low molecular weight which readily yield ionisable compounds with water, will react immediately, even with aqueous silver nitrate.

(ii) Acyl and sulphonyl halides, α -halogeno-ethers and alkyl iodides react instantly.

(iii) Alkyl chlorides and aromatic compounds containing halogen in the side chain do not usually react to any appreciable extent at room temperature, but react fairly rapidly on heating. For monohalogen-substituted compounds, the order of reactivity is

tertiary > secondary > primary, and I > Br > Cl > F

and, indeed, some tertiary halides may react in the cold.

(iv) Aromatic compounds in which the halogen is attached directly to the aromatic nucleus, polyhalogenated compounds with three or more halogens on the same carbon atom, and the α -halogenated ketones (*e.g.*, ω -chloroacetophenone or phenacyl chloride, $C_6H_5COCH_2Cl$ —a powerful lachrymator) do not react even on heating. The presence of nitro groups in the *ortho* and/or *para* positions may cause increased activity of the halogen.

Reaction with alcoholic silver nitrate. To carry out the test, treat 2 ml. of a 2 per cent. solution of silver nitrate in alcohol with 1 or 2 drops (or 0.05 g.) of the compound. If no appreciable precipitate appears at the laboratory temperature, heat on a boiling water bath for several minutes. Some organic acids give insoluble silver salts, hence it is advisable to add 1 drop of *dilute* (5 per cent.) nitric acid at the conclusion of the test : most silver salts of organic acids are soluble in nitric acid.

Note.

If concentrated nitric acid is used, a dangerous explosion may result.

Another test, which indicates the reactivity of the halogen atom (chlorine and bromine), is based upon the fact that sodium chloride and sodium bromide are sparingly soluble in pure acetone :

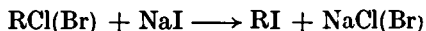

It consists in treating a solution of sodium iodide in pure acetone with the organic compound. The reaction is probably of the S_N2 type involving a bimolecular attack of the iodide ion upon the carbon atom carrying the chlorine or bromine ; the order of reactivities of halides is : primary > secondary > tertiary and Br > Cl.

Primary bromides give a precipitate of sodium bromide within 3 minutes at 25°; chlorides react only when heated at 50° for up to 6 minutes. Secondary and tertiary bromides must be heated at 50° for up to 6 minutes, but tertiary chlorides do not react within this time.

1 : 2-Dichloro- and dibromo-compounds give a precipitate with the reagent and also liberate free iodine :

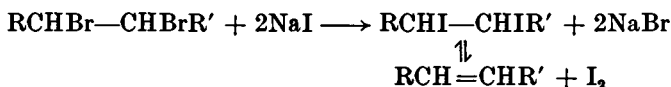

Polybromo compounds (bromoform, *s*-tetrabromoethane) react similarly at 50°, but simple polychloro compounds (chloroform, carbon tetrachloride and trichloroacetic acid) do not.

Sulphonyl chlorides give an immediate precipitate and also liberate iodine :

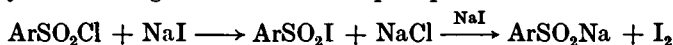

Acid chlorides and bromides, allyl halides, α -halo-ketones, esters, amides and nitriles react at 25° within 3 minutes. Vinyl and aryl halides are inert.

Prepare the reagent by dissolving 7.5 g. of sodium iodide in 50 ml. of A.R. acetone. The colourless solution gradually acquires a yellow colour. Keep it in a dark bottle. When a red-brown colour develops, it should be discarded.

Apply the test to compounds which contain chlorine or bromine. If the compound is a solid, dissolve 0.1 g. in the minimum volume of pure, dry acetone. To 1 ml. of the sodium iodide-acetone reagent add 2 drops of the compound (if a liquid) or the acetone solution (if a solid). Shake and allow to stand at room temperature for 3 minutes. Note whether a precipitate is formed and also whether the solution acquires a reddish-brown colour (liberation of iodine). If no change takes place at room temperature, place the test-tube in a beaker of water at 50°. After 5 minutes, cool to room temperature, and observe whether a reaction has occurred.

4.

ALDEHYDES AND KETONES

It is convenient to consider the indifferent or neutral oxygen derivatives of the hydrocarbons—(a) *aldehydes and ketones*, (b) *esters and anhydrides*, (c) *alcohols and ethers*—together. All of these, with the exception of the water-soluble members of low molecular weight, are soluble only in concentrated sulphuric acid, *i.e.*, fall into Solubility Group V. The above classes of compounds must be tested for in the order in which they are listed, otherwise erroneous conclusions may be drawn from the reactions for functional groups about to be described.

Both aldehydes and ketones contain the carbonyl group, hence a general test for carbonyl compounds will immediately characterise both classes of compounds. The preferred reagent is 2 : 4-dinitrophenylhydrazine, which gives sparingly soluble phenylhydrazones with carbonyl compounds :

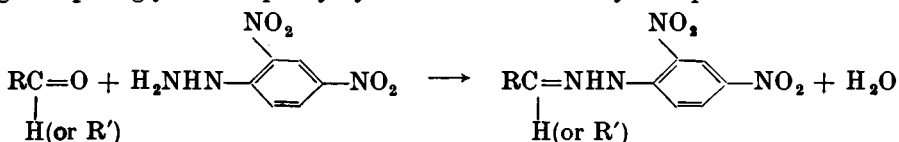

Reaction with 2 : 4-dinitrophenylhydrazine. Add 2 drops (or 0.05–0.1 g.) of the substance to be tested to 3 ml. of the 2 : 4-dinitrophenylhydrazine reagent, and shake. If no precipitate forms immediately

allow to stand for 5–10 minutes. A crystalline precipitate indicates the presence of a carbonyl compound. Occasionally the precipitate is oily at first, but this becomes crystalline upon standing.

2 : 4 Dinitrophenylhydrazine reagent may be prepared by either of the following methods.

Method 1. Suspend 2.0 of 2 : 4-dinitrophenylhydrazine in 100 ml. of methanol ; add *cautiously* and slowly 4.0 ml. of concentrated sulphuric acid. The mixture becomes warm and the solid usually dissolves completely. Filter, if necessary.

Method 2. Dissolve 0.25 g. of 2 : 4-dinitrophenylhydrazine in a mixture of 42 ml. of concentrated hydrochloric acid and 50 ml. of water by warming on a water bath : dilute the cold solution to 250 ml. with distilled water. This reagent is more suitable for water-soluble aldehydes and ketones since alcohol is absent.

The above reagent is very dilute and is intended for qualitative reactions. It is hardly suitable for the preparation of crystalline derivatives except in very small quantities (compare Section III,74,1).

The acetals $RCH(OR')_2$ are so readily hydrolysed by acids that they may give a positive result in the above test :

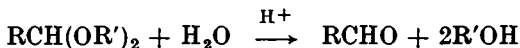

(For a more detailed discussion on *Acetals*, see Section III,69.)

If an unknown compound gives a positive test with the 2 : 4-dinitrophenylhydrazine reagent, it then becomes necessary to decide whether it is an aldehyde or a ketone. Although the dimedone reagent (Section III,70,2) reacts only with aldehydes,* it is hardly satisfactory for routine use in class reactions. It is much simpler to make use of three other reagents given below, the preparation and properties of which have already been described (Section III,70).

Differentiation between aldehydes and ketones.

(i) **Schiff's reagent.** Aldehydes produce a pink colour, while ketones are without effect. Use 2 drops (or 0.05 g.) of the compound and 2 ml. of Schiff's reagent and shake the mixture in the cold. A number of aromatic aldehydes (*e.g.*, vanillin) give a negative result.

(ii) **Fehling's solution.** Aldehydes alone reduce Fehling's solution to yellow or red cuprous oxide. Use 2 drops (or 0.05 g.) of the compound and 2–3 ml. of Fehling's solution : heat on a boiling water bath for 3–4 minutes. This test is positive for aliphatic aldehydes, but is usually indecisive for aromatic aldehydes.

(iii) **Ammoniacal silver nitrate solution (Tollen's solution).** Aldehydes alone reduce Tollen's reagent and produce a silver mirror on the inside of the test-tube. Add 2–3 drops (or 0.05 g.) of the compound to 2–3 ml. of Tollen's solution contained in a *clean* test-tube (the latter is preferably cleaned with hot nitric acid). If no reaction appears to take place in the cold, warm to about 35° in a beaker of warm water.

CAUTION : After the test, pour the contents of the test-tube into the sink and wash the test-tube with dilute nitric acid. Any silver fulminate present, which is highly explosive when dry, will thus be destroyed.

If the tests for an aldehyde are negative, the unknown compound is a ketone. When once the compound has been established as an aldehyde or ketone, it is permissible to refer to tables of physical constants : information thus obtained may be of value in indicating other possible groups to be tested for, with due regard to possible complications caused by the presence of these groups.

* The dimedone reagent may, however, be used if it is desired to detect an aldehyde in the presence of a ketone.

5. ESTERS AND ANHYDRIDES

When the compound for identification fails to respond to test 4 (aldehyde or ketone), the next class reactions to apply are the *hydroxamic acid test* and *saponification, i.e.*, hydrolysis in alkaline solution. These are the class reactions for esters and anhydrides; the rarely-encountered lactones react similarly.

Esters react with hydroxylamine to form an alcohol and a hydroxamic acid, RCONHOH. All hydroxamic acids, in acid solutions, react with ferric chloride to form coloured (usually violet) complex salts:

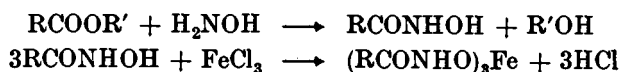

Lactones, which may be regarded as cyclic or inner esters, react similarly. Anhydrides of carboxylic acids also react with hydroxylamine to form hydroxamic acids:

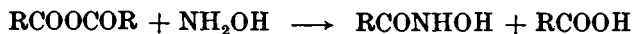

It may be noted that primary aliphatic amides are readily converted by hydroxylamine hydrochloride into hydroxamic acids, which may be detected by the addition of ferric chloride solution:

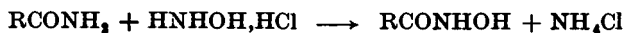

An ester is converted upon saponification into an alcohol and the salt of an acid, or the salts of both an acid and a phenol if it is an ester of a phenol. An anhydride upon hydrolysis yields *only* a salt of an acid.

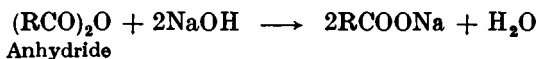
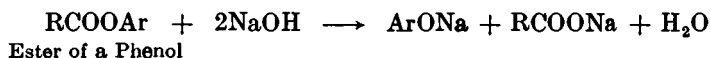

Anhydrides may often be hydrolysed in the cold with dilute alkali; they also react with primary amines (compare Section III,94). All anhydrides boil above 130°; thus acetic anhydride has b.p. 140°.

Some esters (oxalates, methyl and ethyl formates and acetates, etc.) are readily hydrolysed. In general, however, esters require heating with strong aqueous alkali. If the ester is sparingly soluble or insoluble in water, hydrolysis will usually be slow: saponification may then be carried out with ethyl alcoholic sodium or potassium hydroxide (compare Section III,106), but difficulty will be experienced in obtaining a pure derivative of the resulting alcohol. This difficulty may be avoided by employing the inexpensive diethylene glycol ($\beta\beta'$ -dihydroxyethyl ether), b.p. 244°, as the solvent: potassium hydroxide dissolves readily in this solvent, hydrolysis occurs rapidly at the elevated temperature, and all but high boiling point alcohols can be distilled from the reaction mixture in a fairly pure state (*e.g.*, benzyl alcohol, b.p. 205°, can be easily isolated). If the ester yields a glycol or polyhydric alcohol on saponification, the identification of the alcohol part is not possible although identification of the acid can still be made.

Aromatic aldehydes, and also aliphatic aldehydes containing no α -hydrogen atom, undergo the Cannizzaro reaction (see Section IV,123) when treated with aqueous alkali, for example:

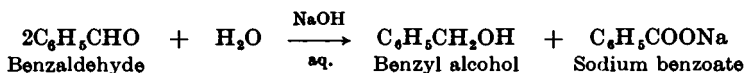

The production of both an alcohol and the sodium salt of an acid might easily be confused with the hydrolysis products of an ester (in the above instance benzyl benzoate). Such an error would soon be discovered (*e.g.*, by reference to the b.p. and other physical properties), but it would lead to an unnecessary expenditure of time and energy. The above example, however, emphasises the importance of conducting the class reactions of neutral oxygen-containing compounds in the proper order, *viz.*, (1) aldehydes and ketones, (2) esters and anhydrides, (3) alcohols, and (4) ethers.

Hydroxamic acid test for esters and anhydrides.

A. Carry out the following preliminary test. Dissolve a drop or a few small crystals of the compound in 1 ml. of rectified spirit (95 per cent. ethanol) and add 1 ml. of *N* hydrochloric acid. Note the colour produced when 1 drop of 5 per cent. ferric chloride solution is added to the solution. If a pronounced violet, blue, red or orange colour is produced, the hydroxamic acid test described below is not applicable and should not be used.

B. Mix 1 drop or several small crystals (*ca.* 0.05 g.) of the compound with 1 ml. of 0.5 *N* hydroxylamine hydrochloride in 95 per cent. ethanol and add 0.2 ml of 6*N* aqueous sodium hydroxide. Heat the mixture to boiling and, after the solution has cooled slightly, add 2 ml. of *N* hydrochloric acid. If the solution is cloudy, add 2 ml. of 95 per cent. ethyl alcohol. Observe the colour produced when 1 drop of 5 per cent. ferric chloride solution is added. If the resulting colour does not persist, continue to add the reagent dropwise until the observed colour pervades the entire solution. Usually only 1 drop of the ferric chloride solution is necessary. Compare the colour with that produced in test *A*. A positive test will be a distinct burgundy or magenta colour as compared with the yellow colour observed when the original compound is tested with ferric chloride solution in the presence of acid.

Saponification of esters. Aqueous sodium hydroxide method. To hydrolyse an ester of an alcohol, reflux 5–6 g. with 50 ml. of 20 per cent. sodium hydroxide solution for 1–2 hours * or until the ester layer disappears.† Distil the alkaline mixture and collect about 6 ml. of distillate. This will contain any volatile alcohol formed in the saponification. If the alcohol does not separate, *i.e.*, is water-soluble, saturate the distillate with solid potassium carbonate: an upper layer of alcohol is then usually formed. (The alcohol may be subsequently identified as the 3:5-dinitrobenzoate: see Section III,27,1.) Cool the residual alkaline mixture, and acidify it with dilute sulphuric acid. If no crystalline acid is precipitated, the acid may frequently be isolated by ether extraction, or it may be distilled from the acidified solution and isolated from (or investigated in) the distillate. (The acid may be subsequently identified, *e.g.*, as the *S*-benzyl-*iso*-thiuronium salt: see Section III,85,4.)

* The addition of about 0.2 g. of an emulsifying agent, such as sodium lauryl or oleyl sulphate, assists in reducing the time required for complete saponification: a large flask should be used since there is usually considerable foaming.

† A water-insoluble alcohol is sometimes formed and care should be taken that this is not confused with the original ester. It usually differs in physical properties (odour, b.p., etc.) from the original ester (see Section III,106).

When dealing with esters of water-soluble, non steam-volatile, polyhydric alcohols (*e.g.*, ethylene glycol or glycerol), the distillate consists of water only (density 1.00). The water-soluble, non-volatile alcohol may be isolated by evaporation of the alkaline solution to a thick syrup on a water bath and extraction of the polyhydric alcohol from the salt with cold ethyl alcohol.

To hydrolyse an ester of a phenol* (*e.g.*, phenyl acetate), proceed as above but cool the alkaline reaction mixture and treat it with carbon dioxide until saturated (solid carbon dioxide may also be used). Whether a solid phenol separates or not, remove it by extraction with ether. Acidify the aqueous bicarbonate solution with dilute sulphuric acid and isolate the acid as detailed for the ester of an alcohol. An alternative method, which is not so time-consuming, may be employed. Cool the alkaline reaction mixture in ice water, and add dilute sulphuric acid with stirring until the solution is acidic to Congo red paper and the acid, if aromatic or otherwise insoluble in the medium, commences to separate as a faint but permanent precipitate. Now add 5 per cent. sodium carbonate solution with vigorous stirring until the solution is alkaline to litmus paper and the precipitate redissolves completely. Remove the phenol by extraction with ether. Acidify the residual aqueous solution and investigate the organic acid as above.

Diethylene glycol method. Place 0.5 g. of potassium hydroxide pellets, 3 ml. of diethylene glycol and 0.5 ml. of water in a 10 or 25 ml. distilling flask; heat the mixture gently until the alkali has dissolved and cool. Add 1-2 g. of the ester and mix well. Fit the flask with a thermometer and a small water-cooled condenser in the usual way. Heat the flask over a small flame whilst shaking gently to mix the contents. When only one liquid phase, or one liquid phase and one solid phase, remains in the flask, heat the mixture more strongly so that the alcohol distils. Identify the alcohol in the distillate by the preparation of the 3 : 5-dinitrobenzoate (Section III,27,1).

The residue in the flask is either a solution or a suspension of the potassium salt of the acid derived from the ester in diethylene glycol. Add 10 ml. of water and 10 ml. of ethyl alcohol to the residue and shake until thoroughly mixed. Then add a drop or two of phenolphthalein and dilute sulphuric acid, dropwise, until just acid. Allow the mixture to stand for about 5 minutes and then filter the potassium sulphate. Use the clear filtrate for the preparation of a solid derivative or two of the acid (see Section III,85,4).

The determination of the saponification equivalent of an ester by the alcoholic potassium hydroxide method is described in Section III,106 : an alternative procedure using diethylene glycol is given below. This constant should be determined if possible in the preliminary examination, since a knowledge of its value together with the boiling point provides a basis for a fairly good approximation of the size of the ester molecule.

* Preliminary indication of the presence of a phenol ester may be obtained by heating the compound with soda-lime : esters of phenols and also aromatic hydroxy-acids usually give the phenol. (Likewise amides, imides, nitriles, substituted hydrazines, urethanes, etc. afford ammonia.)

DETERMINATION OF THE SAPONIFICATION EQUIVALENT OF AN ESTER
BY THE DIETHYLENE GLYCOL METHOD

The alcoholic potassium hydroxide method (Section III,106) has the following undesirable features:—(i) the reaction is often slow, necessitating long refluxing; (ii) possible transposition of the unknown ester (by ethoxide ions) to the corresponding ethyl ester and consequent possible loss because of increased volatility; and (iii) poor keeping quality of the standard solution. These disadvantages are largely overcome by using a solution of potassium hydroxide in diethylene glycol: the procedure is particularly valuable for esters which are insoluble in water.

The reagent is prepared by weighing about 6.0 g. of A.R. potassium hydroxide pellets into a 50 or 100 ml. flask, adding 25 ml. of technical diethylene glycol and heating to effect solution; it is essential to use a thermometer for stirring and to keep the temperature below 130°, otherwise a dark yellow colour will develop. As soon as the solid has dissolved, the warm solution is poured into 75 ml. of diethylene glycol in a glass-stoppered bottle. The solution is thoroughly mixed and allowed to cool. It is *ca.* 1.0*N* and is standardised by pipetting 10 ml. into a flask, adding 15 ml. of water, and titrating with standardised 0.25*N* or 0.5*N* hydrochloric acid using phenolphthalein as indicator. (Because of the high viscosity of the solution, it is advisable to open the tip of the pipette to an internal diameter of 2–3 mm. in order to facilitate drainage; the pipette should be recalibrated before use.)

To determine the saponification equivalent of an ester transfer 10 ml. of the reagent by means of a pipette into a 50 ml. glass-stoppered Pyrex conical flask. Place the sample of the ester in a weight burette or in a weighing bottle fitted with a cork carrying a small dropper pipette (compare Fig. II, 27, 1); transfer about 0.5 g. of the ester, accurately weighed, into the Erlenmeyer flask and insert the ground stopper. Mix the ester with the reagent by a rotary motion of the flask. Hold the stopper firmly in place and heat the mixture in an oil bath so that a temperature of 70–80° is reached within 2–3 minutes: agitate the liquid by a whirling motion during the heating. At this point remove the flask from the heating bath, shake the flask vigorously, allow to drain and loosen the stopper *carefully* to allow air to escape. Replace the stopper and heat again in an oil bath to 120–130°. (For esters of very high boiling point, the stopper may be removed and a thermometer inserted.) After 3 minutes at this temperature, cool the flask and its contents to 80–90°, remove the stopper and wash it with distilled water so that the rinsings drain into the flask. Add about 15 ml. of distilled water and a drop or two of phenolphthalein indicator, mix well and then titrate with standard 0.25*N* or 0.5*N* hydrochloric acid. Calculate the saponification equivalent from the expression:

$$\text{Saponification Equivalent} = \frac{\text{Weight of ester} \times 1000}{\text{Ml. of } N \text{ KOH used}}$$

6.

ALCOHOLS AND ETHERS

If the unknown neutral, oxygen-containing compound does not give the class reactions for aldehydes, ketones, esters and anhydrides, it is probably

either an alcohol or an ether. Alcohols and ethers may be most simply distinguished by the use of two reagents—*metallic sodium and acetyl chloride*.

Metallic sodium reacts with alcohols with the evolution of hydrogen :



The most common interfering substance, especially with alcohols of low molecular weight, is water ; this may result in an inaccurate interpretation of the test if applied alone. Most of the water may usually be removed by shaking with a little anhydrous calcium sulphate. Although dry ethers (and also the saturated aliphatic and the simple aromatic hydrocarbons) do not react with sodium, many other classes of organic compounds do. Thus :

(a) Aliphatic esters are converted into salts of acyloins :

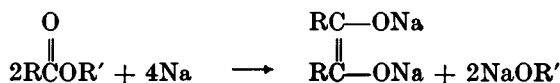

Upon treatment with dilute sulphuric acid, the *acyloin* is produced :

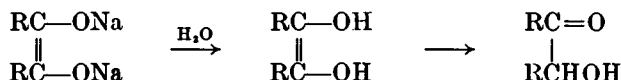

The term *acyloin* is commonly used as a class name for the symmetrical keto-alcohols $\text{RCOCH}(\text{OH})\text{R}$, and the name of the individual compound is derived by adding the suffix *oin* to the stem name of the acid to which the acyloin corresponds, e.g., acetoin, propionoin, butyroin, etc.

(A Note on acyloins is given at the end of this Section, i.e., immediately before Section XI,8.)

(b) Simple esters (e.g., ethyl acetate) undergo the acetoacetic ester condensation (compare Section III,151). The effective condensing agent is sodium ethoxide, produced by the action of sodium upon traces of alcohol present in the ester :

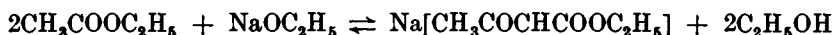

(c) Ketones containing an α -hydrogen atom may react through their enolic forms or they may be partially reduced to a sodium pinacolate (compare Section III,77) :

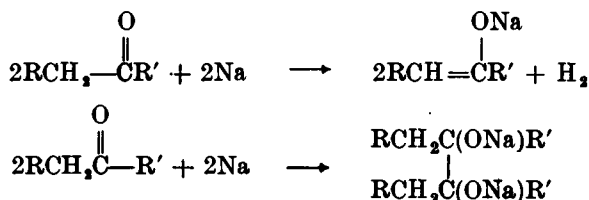

This is another reason why aldehydes, ketones and esters must be tested for in the order already given, and why it is necessary to employ *both* the sodium and acetyl chloride tests.

Acetyl chloride reacts vigorously with primary and secondary alcohols to yield esters ; it also reacts readily with any water present to form acetic acid :

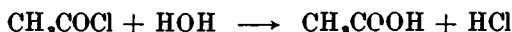
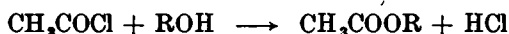

The resulting esters differ sufficiently in odour and water solubility to be readily distinguished from the original alcohol. With tertiary alcohols the product is largely the alkyl chloride :

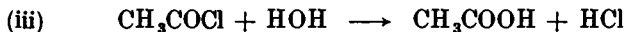

The reason for this is that reaction (i) is usually much slower than (ii) and (iii) so that the main reaction appears to be (iv) (compare the preparation of tertiary butyl chloride from tertiary butyl alcohol and concentrated hydrochloric acid, Section III,33). If the reaction is carried out in the presence of pyridine, the latter combines with the hydrogen chloride as it is formed, thus preventing reactions (ii) and (iii), and a good yield of the ester is generally obtained. The differentiation between primary, secondary and tertiary alcohols with the aid of the Lucas reagent is described in Section III,27,(vii).

Benzoyl chloride may replace acetyl chloride as a class reagent : it possesses the advantage that it is only very slowly decomposed by cold water and consequently may be employed for detecting alcohols even in aqueous solution. The reaction is usually carried out in aqueous solution containing sufficient caustic alkali to decompose any excess of benzoyl chloride into the water-soluble alkali benzoate (Schotten - Baumann reaction ; compare Section IV,52). The benzoyl esters formed are insoluble in water :

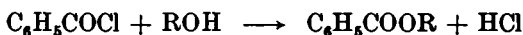

Alcohols (but not ethers) also react with phenyl isocyanate or with the corresponding crystalline α -naphthyl isocyanate to give carbamates or urethanes (see Section III,27,4), but these substances are hardly suitable as class reagents.

Ethers are unaffected by sodium and by acetyl (or benzoyl) chloride. Both the purely aliphatic ethers {e.g., di-*n*-butyl ether ($\text{C}_4\text{H}_9^{\alpha}\text{O}$) and the mixed aliphatic - aromatic ethers (e.g., anisole $\text{C}_6\text{H}_5\text{OCH}_3$) are encountered in Solubility Group V : the purely aromatic ethers {e.g., diphenyl ether ($\text{C}_6\text{H}_5\text{O}$) are generally insoluble in concentrated sulphuric acid and are found in Solubility Group VI. The purely aliphatic ethers are very inert and their final identification may, of necessity, depend upon their physical properties (b.p., density and/or refractive index). Ethers do, however, suffer fission when heated with excess of 57 per cent. hydriodic acid, but the reaction is generally only of value for the characterisation of symmetrical ethers ($\text{R} \equiv \text{R}'$) :

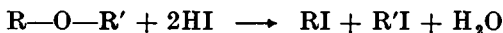

The mixed aliphatic - aromatic ethers are somewhat more reactive : in addition to cleavage by strong hydriodic acid and also by constant b.p. hydrobromic acid in acetic acid solution into phenols and alkyl halides, they may be brominated, nitrated and converted into sulphonamides (Section IV,106,2).

Sodium test. Treat 1 ml. of the compound with a *small* thin slice of freshly cut sodium (handle with the tongs or with a penknife) in a small, dry test-tube (75 \times 10 mm. or 100 \times 12 mm.). Observe whether hydrogen is evolved and the sodium reacts. (If the compound is suspected to contain water, dry it first with a little anhydrous calcium or magnesium sulphate.)

Acetyl chloride test. In a small, dry test-tube treat 0.5 ml. of the compound with 0.3–0.4 ml. of redistilled acetyl chloride and note whether reaction occurs. Add 3 ml. of water and neutralise the aqueous layer with solid sodium bicarbonate. Look for a product different from the original alcohol.

Benzoyl chloride test. (This is an alternative to the acetyl chloride test.) Place 1 ml. of the compound, 0.5 ml. of redistilled benzoyl chloride (*CAUTION* in handling) and 2.5 ml. of 10 per cent. aqueous sodium hydroxide in a small test-tube, cork the tube and shake vigorously until the odour of benzoyl chloride has disappeared. Observe the odour, density and other obvious properties of the product.

Fission of ethers with hydriodic acid. Reflux 1 ml. of the compound with 5 ml. of freshly distilled constant b.p. hydriodic acid (b.p. 126–128°) for 2–3 hours in a small flask fitted with a double surface condenser. Add 10 ml. of water, distil and collect about 7 ml. of liquid. Decolourise the distillate by the addition of a little sodium bisulphite and separate the two layers by means of a dropper pipette. If the original compound is suspected to be an aliphatic ether, determine the b.p. of the iodide by the Siwoloboff method (Section II,12): if the amount of product is insufficient, repeat the original experiment.

Acetals $RCH(OR')_2$ are stable in alkaline solution, but are readily hydrolysed by dilute acids to give aldehydes, which may be characterised as detailed under 4 (see Section III,69).

7.

THE IODOFORM TEST

Neutral oxygen-containing compounds in Solubility Groups I, II and V which either contain the CH_3CO- group attached to H, alkyl, aryl, or ester

$(CH_3)_nCOOR'$ (e.g., $CH_3\overset{\text{H}}{\underset{|}{C}}=O$ and $CH_3\overset{\text{R}}{\underset{|}{C}}=O$), or are oxidised to this structure

under the conditions of the experiment (e.g., $CH_3-\overset{\text{H}}{\underset{|}{C}}-OH$ and $CH_3-\overset{\text{R}}{\underset{|}{C}}-OH$),

give iodoform with sodium hypiodite solution (compare Section III,45). The reactions which occur may be illustrated by reference to a secondary alcohol (a methyl carbinol) :

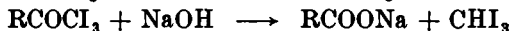
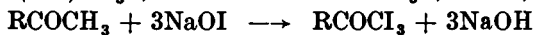
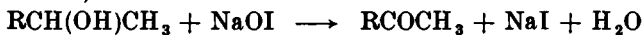

If the compound to be tested is insoluble in water, it should be brought into solution by the addition of a little dioxan. Alcohols and some methyl ketones frequently react slowly: in such cases it is advisable to employ a large excess (4–5 fold) of the relatively unstable reagent ($3NaOI \rightarrow NaIO_3 + 2NaI$). Quinones and hydroquinones also give the iodoform reaction.

The iodoform test. Dissolve 0.1 g. or 5 drops of the compound in 2 ml. of water; if it is insoluble in water, add sufficient dioxan to produce a homogeneous solution. Add 2 ml. of 5 per cent. sodium hydroxide solution and then introduce a potassium iodide - iodine reagent dropwise with shaking until a definite dark colour of iodine persists. Allow to

stand for 2-3 minutes : if no iodoform separates at room temperature, warm the test-tube in a beaker of water at 60°. Add a few more drops of the iodine reagent if the faint iodine colour disappears : continue the addition of the reagent until the dark colour is not discharged after 2 minutes heating at 60°. Remove the excess of iodine by the addition of a few drops of dilute sodium hydroxide solution with shaking, dilute with an equal volume of water and allow to stand for 10 minutes. The test is positive if a yellow precipitate of iodoform is deposited. Filter off the yellow precipitate, dry upon pads of filter paper and determine the m.p. : iodoform melts at 120°.

The potassium iodide-iodine reagent is prepared by dissolving 20 g. of potassium iodide and 10 g. of iodine in 100 ml. of water.

8. POLYHYDRIC ALCOHOLS AND THE POLYHYDROXY ALDEHYDES AND KETONES (SUGARS)

The polyhydric alcohols of Solubility Group II are liquids of relatively high boiling point and may be detected *inter alia* by the reactions already described for *Alcohols* (see 6). Compounds containing two hydroxyl groups attached to adjacent carbon atoms (1 : 2-glycols), α -hydroxy aldehydes and ketones, and 1 : 2-diketones may be identified by the periodic acid test, given in reaction 9.

The simple sugars or monosaccharides are polyhydroxy aldehydes or ketones, and belong to Solubility Group II. They are termed tetroses, pentoses, hexoses, etc. according to the number of carbon atoms in the long chain constituting the molecule, and aldoses or ketoses if they are aldehydes or ketones. Most of the monosaccharides that occur in nature are pentoses and hexoses.

All carbohydrates (mono-, di- and poly-saccharides) give the Molisch colour test {for details, see Section III, 139, (i)}.

Both aldoses and ketoses reduce Fehling's solution (for details, see under 4). This fact may appear surprising when it is remembered that Fehling's solution is one of the reagents for distinguishing between aldehydes and ketones (see 4). The explanation lies in the fact that α -hydroxyketones are much more readily oxidised than simple ketones, perhaps because the hydroxy ketone allows its isomerisation, in the presence of alkali, into an aldehyde. For example, fructose, a keto-hexose, might isomerise thus :

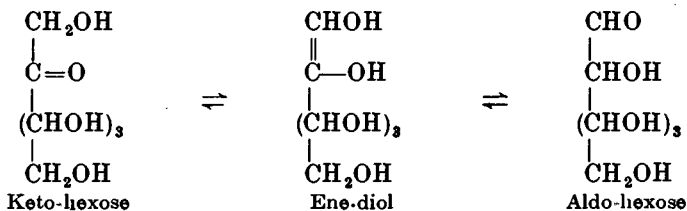

Positive results are given with aldoses and ketoses and with disaccharides containing potential aldehyde groups (*e.g.*, maltose). Disaccharides which do not contain potential aldehyde groups (*e.g.*, sucrose) and also polysaccharides (*e.g.*, starch and cellulose) do not reduce Fehling's solution. Non-reducing disaccharides and polysaccharides upon warming for a short time with 5 per cent. hydrochloric acid or sulphuric acid are hydrolysed to monosaccharides : upon neutralisation (to phenolphthalein) of the excess of acid with sodium hydroxide solution, a positive test is obtained with Fehling's solution.

Another reaction that is characteristic of α -hydroxy aldehydes or ketones, which has been found of value for the characterisation of sugars, is the formation of **osazones** with phenylhydrazine. This reagent reacts with either an aldose

or a ketose to yield a phenylhydrazone, which is then oxidised and converted into a bis-phenylhydrazone or osazone by more of the phenylhydrazine (see theoretical discussion before Section III,137). Certain osazones also possess characteristic appearances under the microscope (see Fig. III, 153, 1).

Galactose and also carbohydrates which yield galactose upon hydrolysis (*e.g.*, lactose) are oxidised to the sparingly soluble mucic acid (compare Section III,139).

Oxidation of galactose (or a galactose-containing sugar) to mucic acid. Dissolve 1 g. of galactose or lactose in a mixture of 10 ml. of water and 5 ml. of concentrated nitric acid contained in a small evaporating dish, and evaporate the solution to dryness on a water bath. Stir the cold residue with 10 ml. of cold water, filter off the mucic acid, wash it with cold water, dry and determine the m.p. (212–213° with decomposition).

9. THE PERIODIC ACID TEST

Periodic acid has a selective oxidising action upon compounds having two hydroxyl groups or a hydroxyl and an amino group attached to adjacent carbon atoms and is characterised by the cleavage of the carbon-carbon bond (Malaprade reaction) :

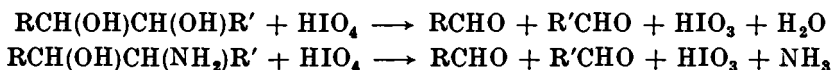

No oxidation occurs unless the hydroxyl groups or a hydroxyl and an amino group are attached to adjacent carbon atoms, hence the test may be employed for testing for the presence of contiguous hydroxyl groups (*e.g.*, 1,2-diols) and hydroxyl and amino groups. Carbonyl compounds in which the carbonyl group is contiguous to a hydroxyl group or a second carbonyl group are also oxidised, *e.g.*, α -hydroxy aldehydes or ketones, 1 : 2-diketones and α -hydroxy acids :

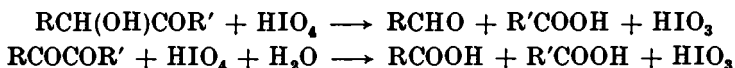

The oxidation may proceed through the hydrated form of the carbonyl group $> \text{CH(OH)}_2$. The rate of oxidation is 1,2-glycols $>$ α -hydroxy aldehydes $>$ α -hydroxy ketones $>$ α -hydroxy acids. Under the conditions enumerated below, α -hydroxy acids usually give a negative test.

In qualitative organic analysis, use is made of the fact that silver iodate is sparingly soluble in *dilute* nitric acid whereas silver periodate is very soluble. For water-insoluble compounds solutions in ethanol or in *pure* dioxan may be employed.

The periodic acid reagent is prepared by dissolving 1.0 g. of paraperiodic acid H_5IO_6 in 200 ml. of distilled water.

Place 2 ml. of the periodic acid reagent in a small test-tube, add one drop (no more—otherwise the silver iodate, if formed, will fail to precipitate) of concentrated nitric acid, and shake well. Add one drop or a small crystal of the compound to be tested, shake the mixture for 15–20 seconds, and then add 1–2 drops of 3 per cent. silver nitrate solution. The instantaneous formation of a *white* precipitate of silver iodate is a positive test. Failure to form a precipitate, or the appearance of a brown precipitate which redissolves on shaking, constitutes a negative test.

10. CARBOXYLIC ACIDS AND PHENOLS

Most of the acidic compounds containing only the elements C, H and O are either carboxylic acids or phenols. They are found mainly in Solubility Group III, although the water-soluble members are in Solubility Groups I and II.

Carboxylic acids are :

(a) Soluble in 5 per cent. sodium hydroxide solution *and* in 5 per cent. sodium bicarbonate solution (the latter reaction is accompanied by the evolution of carbon dioxide).

(b) Non-reactive towards bromine water or a solution of bromine in carbon tetrachloride (unless an ethylenic or acetylenic or other unsaturated group is *also* present).

(c) Titratable with standard sodium hydroxide solution in aqueous or in alcoholic solution in the presence of phenolphthalein as indicator, thus enabling the equivalent weight to be determined.

Phenols (and enols), broadly speaking, give the following reactions :

(a) They are soluble in 5 per cent. sodium hydroxide solution and *insoluble* in 5 per cent. sodium bicarbonate solution ; they are precipitated from their solutions in aqueous sodium hydroxide by carbon dioxide. [Exceptions : the presence of certain negative groups in phenols increases the acidity to such an extent that they may dissolve in sodium bicarbonate solution, for example, 2 : 4-dinitrophenol, picric acid and *s*-tribromophenol.]

(b) They react with a solution of bromine in carbon tetrachloride by *substitution* and an equivalent quantity of hydrogen bromide is evolved (compare *addition* with unsaturated compounds). When the test is conducted with bromine water and a dilute aqueous solution of a phenol, the sign of reaction is the separation of a sparingly soluble bromine substitution product.

(c) They yield intense colorations (blue, green, red or purple) when treated with a solution of ferric chloride. Some phenols (and enols) do not give this test in aqueous solution, but react readily in alcoholic solution. [The coloration is said to be due to a complex ion $[\text{Fe}(\text{OAr})_6]^{+}$. Some phenolic acids, such as *m*- and *p*-hydroxybenzoic acids, do not give this test, but others, such as salicylic acid (which is the enolic form of a cyclo β -keto acid), do.]

It must be borne in mind that there are many nitrogen-containing phenols and acids ; of these the nitro and amino derivatives are the most common. The aromatic nitrocarboxylic acids may usually be identified through the reactions and derivatives of the carboxyl group without recourse to the reactions of the nitro group : examination for the latter will, however, provide additional confirmation. The influence of the nitro and other groups in the *o*- and *p*-positions upon the acidity of a phenol has already been noted : such groups tend to produce a marked deepening in the colour of alkaline solutions of the phenol. Amino substituents in water-insoluble phenols and acids cause these compounds to be soluble in both dilute acid and dilute alkali, *i.e.*, to be amphoteric. Frequently it is helpful to destroy the basic character of the nitrogen by conversion of the amino group into a neutral amide group by acetylation or benzoylation in aqueous alkaline solution : the resulting compound is not amphoteric and its equivalent may be determined.

An indication whether a water-insoluble compound is an acid or a phenol (or enol) will be obtained from the Solubility Tests : water-soluble acids will liberate carbon dioxide from 5 per cent. sodium bicarbonate solution {see Section III,85,(1)}.

Equivalent weight of an acid. Determine the equivalent weight of the acid (use about 0.2 g.) by titration with standard *ca.* 0.1*N* alkali

with phenolphthalein as indicator; if the acid is sparingly soluble in water, add alcohol to increase the solubility.

The presence of simple water-insoluble phenols (or enols) will be indicated by the insolubility in 5 per cent. sodium bicarbonate solution. Further evidence will be obtained by carrying out the following tests.

Bromine test (*cf. 1*). Dissolve 0.2 g. or 0.2 ml. of the compound in 2 ml. of carbon tetrachloride and add a 2 per cent. solution of bromine in carbon tetrachloride dropwise until the bromine colour persists for 1 minute. If no hydrogen bromide fumes are observed, blow gently across the mouth of the tube.

Dissolve 0.1 g. of the compound in 10–15 ml. of water and add bromine water until the colour of the latter persists. A white precipitate will form if a phenol is present.

Ferric chloride test. Dissolve 1 drop or 0.05 g. of the compound in 5 ml. of water and add 1 drop of ferric chloride solution: observe the colour produced. If the result is negative in aqueous solution, repeat the test in alcoholic solution.

11. AMINES (BASIC NITROGEN COMPOUNDS)

Organic compounds that dissolve in dilute hydrochloric acid and are placed in Solubility Group IV contain nitrogen: the rarely encountered pyrones and anthocyanidin pigments are exceptions. Indeed, when solubility tests have placed a compound in Solubility Group IV but elementary analysis has failed to prove the presence of nitrogen, it is advisable to repeat the test for the elements. The most important basic nitrogen compounds are the amines—primary, secondary and tertiary amines. The only hydrazines commonly encountered in this Group are the monoaryl hydrazines: they are most conveniently detected by using benzaldehyde or some other suitable carbonyl compound as a reagent. The lower aliphatic amines and diamines are soluble in water and possess characteristic ammoniacal odours which distinguish them from the water-insoluble amines of Solubility Group IV. The reactions to be described below apply to both water-soluble and water-insoluble amines.

The following reagents may be conveniently employed for the detection of amines:

(1) Acetyl chloride or acetic anhydride.

Acetyl chloride reacts immediately and often violently with primary and secondary amines, but not with tertiary amines, for example:



It will be observed that the reaction involves two equivalents of the amine and produces, in addition to the substituted amide, an equivalent quantity of the amine hydrochloride. Acetic anhydride, on the other hand, converts the amine quantitatively into the acyl derivative, for example:

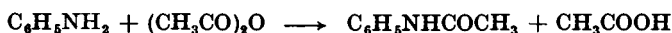

For this reason, acetic anhydride is generally preferred for the preparation of acetyl derivatives, but acetyl chloride, in view of its greater reactivity, is a better diagnostic reagent for primary and secondary amines.

(2) Benzoyl chloride.

This acid chloride is much less reactive than acetyl chloride and indeed it may be employed to benzoylate a primary or secondary amine in the presence of a dilute

solution of sodium hydroxide (Schotten-Baumann reaction). The resulting benzoyl derivative is insoluble in the alkaline medium and can be separated by filtration or extraction. The slight excess of benzoyl chloride which is employed is decomposed by the alkali. The reactions which occur with a typical secondary amine, monoethylaniline, are :

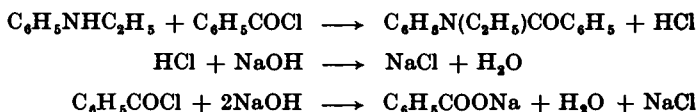

(3) Benzenesulphonyl chloride.

Benzenesulphonyl chloride reacts with primary and secondary, but not with tertiary, amines to yield substituted sulphonamides (for full discussion, see Section IV,100,3). The substituted sulphonamide formed from a primary amine dissolves in the alkaline medium, whilst that produced from a secondary amine is insoluble in alkali; tertiary amines do not react. Upon acidifying the solution produced with a primary amine, the substituted sulphonamide is precipitated. The reactions form the basis of the Hinsberg procedure for the separation of amines {see Section IV,100,(viii) for details}. Feebly basic amines, such as *o*-nitroaniline, react slowly in the presence of alkali: in such cases it is best to carry out the reaction in pyridine solution {see Section IV,100,3}.

Some reference to the use of nitrous acid merits mention here. Primary aromatic amines yield diazonium compounds, which may be coupled with phenols to yield highly-coloured azo dyes (see Section IV,100,(iii)). Secondary aromatic amines afford nitroso compounds, which give Liebermann's nitroso reaction {Section IV,100,(v)}. Tertiary aromatic amines, of the type of dimethylaniline, yield *p*-nitroso derivatives {see Section IV,100,(vii)}.

The carbylamine or isocyanide test for primary amines {Section IV,100,(i)} is so extremely delicate that it will detect traces of primary amines in secondary and tertiary amines: it must therefore be applied with due regard to this factor.

Acetyl chloride test (for primary and secondary amines). In a semi-micro test-tube (75 × 10 mm.) treat 0.5 ml. (or 0.5 g.) of the compound with acetyl chloride drop by drop. Note whether reaction occurs. If no solid separates, pour the contents of the tube into 3 ml. of water and neutralise the aqueous layer with solid sodium bicarbonate. Observe whether a product different from the original compound is produced.

Benzoyl chloride test (for primary and secondary amines). Place 0.5 ml. (or 0.5 g.) of the compound, 10 ml. of 5 per cent. sodium hydroxide solution and 1 ml. of benzoyl chloride (*CAUTION*) in a test-tube, stopper the tube and shake until the odour of benzoyl chloride disappears. Examine the properties of the substance formed.

Benzenesulphonyl chloride test.* Proceed as in the benzoyl chloride test, but use 15–20 ml. of 5 per cent. sodium hydroxide solution. Examine the product when the odour of the sulphonyl chloride has disappeared. (If no reaction has occurred, the substance is probably a tertiary amine.) If a precipitate appears in the alkaline solution, dilute with about 10 ml. of water and shake; if the precipitate does not dissolve, a secondary amine is indicated. If the solution is clear, acidify it cautiously to Congo red with dilute hydrochloric acid: a precipitate is indicative of a primary amine.

* *p*-Toluenesulphonyl chloride is more convenient to handle and gives similar results.

12. ACIDIC AND NEUTRAL NITROGEN COMPOUNDS

The imides, primary and secondary nitro compounds, oximes and sulphonamides of Solubility Group III are weakly acidic nitrogen compounds: they cannot be titrated satisfactorily with a standard alkali nor do they exhibit the reactions characteristic of phenols. The neutral nitrogen compounds of Solubility Group VII include: tertiary nitro compounds; amides (simple and substituted); derivatives of aldehydes and ketones (hydrazones, semicarbazones, etc.); nitriles; nitroso, azo, hydrazo and other intermediate reduction products of aromatic nitro compounds. All the above nitrogen compounds, and also the sulphonamides of Solubility Group VII, respond, with few exceptions, to the same classification reactions (*reduction and hydrolysis*) and hence will be considered together.

Nitro compounds and their reduction products. Tertiary nitro compounds (these are generally aromatic)* are reduced by zinc and ammonium chloride solution to the corresponding hydroxylamines, which may be detected by their reducing action upon an ammoniacal solution of silver nitrate or Tollen's reagent:

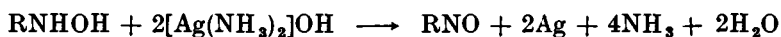
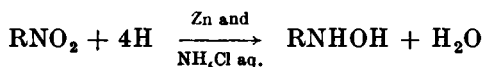

It must be remembered, however, that nitroso, azoxy and azo compounds (which are usually more highly coloured than nitro compounds) may be reduced by zinc powder to the corresponding hydroxylamine, hydrazo and hydrazine compounds respectively, all of which reduce Tollen's reagent in the cold.

Nitro compounds are reduced in acid solution (for example, by tin and hydrochloric acid) to the corresponding primary amines, which may be detected as described under 11:

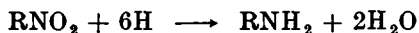

Nitrosamines are similarly reduced to secondary amines:



(compare Section IV,40); they (and some C-nitroso compounds that yield nitrous acid when treated with concentrated sulphuric acid) may be detected by Liebermann's reaction {see Section IV,100,(v)}.

Azo compounds may be identified by examination of the amine(s) formed on reduction in acid solution (see Sections IV,76 and IV,78):

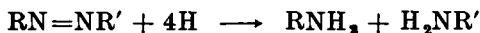

They are always coloured but give colourless products upon reduction. **Hydrazo and azoxy compounds** are reduced in acid solution to the parent amine.

Amides. Simple (primary) amides (RCONH_2) when warmed with dilute sodium hydroxide solution give ammonia readily, together with the salt of the corresponding acid:

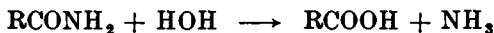

Complete hydrolysis may be effected by boiling either with 10 per cent. sodium hydroxide solution or with 10 per cent. sulphuric acid for 1-3 hours. It is preferable to employ the non-volatile sulphuric acid for acid hydrolysis; this

* Nitro-paraffins may be primary, secondary or tertiary: $-\text{CH}_2.\text{NO}_2$, primary; $>\text{CH}.\text{NO}_2$, secondary; and $>\text{C}.\text{NO}_2$, tertiary.

acid should also be used for acidification of the solution resulting from alkaline hydrolysis since any volatile organic acid (formic acid, acetic acid, etc.) may be distilled off.

Substituted amides suffer hydrolysis with greater difficulty. The choice of an acid or an alkaline medium will depend upon (a) the solubility of the compound in the medium and (b) the effect of the reagent upon the products of hydrolysis. Substituted amides of comparatively low molecular weight (*e.g.*, acetanilide) may be hydrolysed by boiling either with 10 per cent. sodium hydroxide solution or with 10 per cent. sulphuric acid for 2-3 hours. Other substituted amides are so insoluble in water that little reaction occurs when they are refluxed with dilute acid or dilute alkali for several hours. These include such substances as benzanilide ($C_6H_5CONHC_6H_5$) and the benzoyl derivative of a naphthylamine ($C_6H_5CONHC_{10}H_7$) or a toluidine ($C_6H_5CONHC_7H_7$). For these substances satisfactory results may be obtained with 70 per cent. sulphuric acid: * this hydrolysis medium is a much better solvent for the substituted amide than is water or more dilute acid; it also permits a higher reaction temperature (compare Section IV 192):

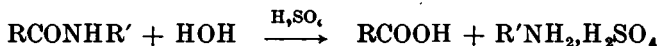

Nitriles. These are best hydrolysed by boiling either with 30-40 per cent. sodium hydroxide solution or with 50-70 per cent. sulphuric acid during several hours, but the reaction takes place less readily than for primary amides. Indeed the latter are intermediate products in the hydrolysis:

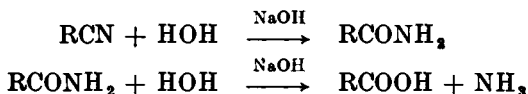

Nitriles and simple amides differ in physical properties: the former are liquids or low-melting solids, whilst the latter are generally solids. If the amide is a solid and insoluble in water, it may be readily prepared from the nitrile by dissolving in concentrated sulphuric acid and pouring the solution into water:

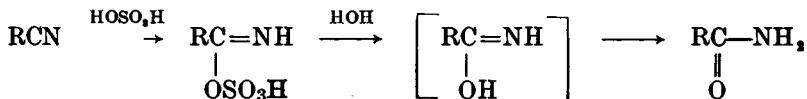

Oximes, hydrazines and semicarbazones. The hydrolysis products of these compounds, *i.e.*, aldehydes and ketones, may be sensitive to alkali (this is particularly so for aldehydes): it is best, therefore, to conduct the hydrolysis with strong mineral acid. After hydrolysis the aldehyde or ketone may be isolated by distillation with steam, extraction with ether or, if a solid, by filtration, and then identified. The acid solution may be examined for hydroxylamine or hydrazine or semicarbazide: substituted hydrazines of the aromatic series are precipitated as oils or solids upon the addition of alkali.

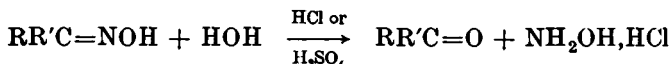

Imides. Imides are generally water-soluble, consequently they are much more readily hydrolysed in an alkaline medium, *e.g.*, by refluxing with 10 per cent. sodium hydroxide solution:

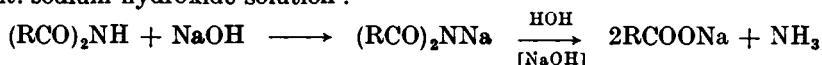

* Prepared by adding 40 ml. of concentrated sulphuric acid cautiously and with stirring and cooling to 30 ml. of water.

Sulphonamides. Sulphonamides are very resistant to the normal reagents for hydrolysis. Heating with 80 per cent. sulphuric acid at 160–170° results in rapid hydrolysis :

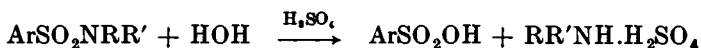

The reaction product may then be examined for a sulphonic acid and an amine.

Reduction of a nitro compound to a hydroxylamine. Dissolve 0.5 g. of the compound in 10 ml. of 50 per cent. alcohol, add 0.5 g. of solid ammonium chloride and about 0.5 g. of zinc powder. Heat to boiling and allow the ensuing chemical reaction to proceed for 5 minutes. Filter from the excess of zinc powder and test the filtrate with Tollen's reagent {see Section III, 70, (i)}. An immediate black or grey precipitate or a silver mirror indicates the presence of a hydroxylamine formed by the reduction of the nitro compound. Alternatively, warm the filtrate with Fehling's solution : a hydroxylamine will precipitate red cuprous oxide. (A blank test should be performed with the original compound.)

Reduction of a nitro compound to a primary amine. In a 50 ml. round-bottomed or conical flask fitted with a reflux condenser, place 1 g. of the nitro compound and 2 g. of granulated tin. Measure out 10 ml. of concentrated hydrochloric acid and add it in three equal portions to the mixture : shake thoroughly after each addition. When the vigorous reaction subsides, heat under reflux on a water bath until the nitro compound has completely reacted (20–30 minutes). Shake the reaction mixture from time to time ; if the nitro compound appears to be very insoluble, add 5 ml. of alcohol. Cool the reaction mixture, and add 20–40 per cent. sodium hydroxide solution until the precipitate of tin hydroxide dissolves. Extract the resulting amine from the cooled solution with ether, and remove the ether by distillation. Examine the residue with regard to its solubility in 5 per cent. hydrochloric acid and its reaction with acetyl chloride or benzene-sulphonyl chloride.

Reduction of a nitrosamine to a secondary amine. Proceed as for a nitro compound. Determine the solubility of the residue after evaporation of the ether and also its behaviour towards benzenesulphonyl (or *p*-toluenesulphonyl) chloride.

Hydrolysis of simple (primary) amides in alkaline solution. Boil 0.5 g. of the compound with 5 ml. of 10 per cent. sodium hydroxide solution and observe whether ammonia is evolved.

Hydrolysis of a substituted amide. *A. With 10 per cent. sulphuric acid.* Reflux 1 g. of the compound (*e.g.*, acetanilide) with 20 ml. of 10 per cent. sulphuric acid for 1–2 hours. Distil the reaction mixture and collect 10 ml. of distillate : this will contain any volatile organic acids which may be present. Cool the residue, render it alkaline with 20 per cent. sodium hydroxide solution, cool, and extract with ether. Distil off the ether and examine the ether-soluble residue for an amine.

B. With 70 per cent. sulphuric acid. Reflux 1 g. of the substance (*e.g.*, benzanilide) with 10–15 ml. of 70 per cent. sulphuric acid (4 : 3 by volume) for 30 minutes. Allow to cool and wash down any acid which has sublimed into the condenser with hot water. Filter off the acid, wash it with water, and examine for solubility, etc. Render the filtrate alkaline

with 10–20 per cent. sodium hydroxide solution, cool, and extract with ether. Examine the residue, after evaporation of the ether, for an amine.

Hydrolysis of a nitrile to an acid. Reflux 1 g. of the nitrile with 5 ml. of 30–40 per cent. sodium hydroxide solution until ammonia ceases to be evolved (2–3 hours). Dilute with 5 ml. of water and add, with cooling, 7 ml. of 50 per cent. sulphuric acid. Isolate the acid by ether extraction, and examine its solubility and other properties.

Hydrolysis of a nitrile to an amide. Warm a solution of 1 g. of the nitrile (*e.g.*, benzyl cyanide) in 4 ml. of concentrated sulphuric acid to 80–90°, and allow the solution to stand for 5 minutes. Cool and pour the solution cautiously into 40 ml. of cold water. Filter off the precipitate; stir it with 20 ml. of cold 5 per cent. sodium hydroxide solution and filter again. Recrystallise the amide from dilute alcohol, and determine its m.p. Examine the solubility behaviour and also the action of warm sodium hydroxide solution upon the amide.

Hydrolysis of a sulphonamide. Mix 2 g. of the sulphonamide with 3.5 ml. of 80 per cent. sulphuric acid* in a test-tube and place a thermometer in the mixture. Heat the test-tube, with frequent stirring by means of the thermometer, at 155–165° until the solid passes into solution (2–5 minutes). Allow the acid solution to cool and pour it into 25–30 ml. of water. Render the resulting solution alkaline with 20 per cent. sodium hydroxide solution in order to liberate the free amine. Two methods may be used for isolating the base. If the amine is volatile in steam, distil the alkaline solution and collect about 20 ml. of distillate: extract the amine with ether, dry the ethereal solution with anhydrous potassium carbonate and distil off the solvent. If the amine is not appreciably steam-volatile, extract it from the alkaline solution with ether. The sulphonic acid (as sodium salt) in the residual solution may be identified as detailed under 13.

13.

SULPHUR COMPOUNDS

The following classes of sulphur compounds occur in Solubility Groups II, III and VII: sulphonic acids and derivatives, ArSO_2OR ; sulphinic acids and derivatives, ArSOOR ; mercaptans, RSH ; thiophenols, ArSH ; sulphides or thioethers, RSR' ; disulphides, RSSR' ; sulphoxides, $\text{RR}'\text{S}\rightarrow\text{O}$;

sulphones, $\text{RR}'\text{S}\overset{\text{O}}{\rightarrow}$; esters of sulphuric acid, $\text{ROSO}_2\text{OR}'$; salts of alkyl sulphuric acids, *e.g.*, ROSO_2ONa ; bisulphite addition products of aldehydes, methyl ketones (RCOCH_3) and alicyclic ketones; isothiocyanates, $\text{RN}=\text{C}=\text{S}$; sulphates of amines; and sulphonamides. The sulphonamides have already been discussed under 12. The sulphates of amines are converted by aqueous sodium hydroxide into the free bases; the sulphate anion can be detected in the resulting aqueous solution as barium sulphate in the usual manner.

Sulphonic acids. The aromatic sulphonic acids and their alkali-metal salts are soluble in water, but insoluble in ether (Solubility Group II). They are best characterised by conversion into crystalline S-benzyl-*iso*-thiuronium salts (see Section IV, 33,2 and III, 85,5), which possess characteristic melting points. A more time-consuming procedure is to treat the well-dried acid or

* Prepared by cautiously mixing 3 volumes of concentrated sulphuric acid with 1 volume of water.

its salt with phosphorus pentachloride or with phosphorus oxychloride, and to convert the resulting sulphonyl chloride (a) into a sulphonamide by pouring the reaction mixture into concentrated ammonia solution or (b) into a substituted sulphonamide by treating it with a primary amine in the presence of aqueous sodium hydroxide (compare Section IV,33,1) :

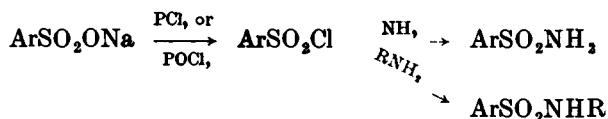

Sulphinic acids. Aromatic sulphinic acids are found in Solubility Group II. They may be detected by dissolving in cold concentrated sulphuric acid and adding one drop of phenetole or anisole when a blue colour is produced (Smiles's test), due to the formation of a *para*-substituted aromatic sulphoxide. Thus the reaction with benzenesulphinic acid is :

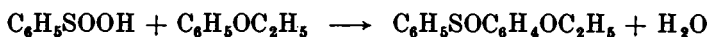

Aromatic sulphinic acids are oxidised by potassium permanganate to sulphonic acids and are reduced by zinc and hydrochloric acid to thiophenols.

Mercaptans and thiophenols (thiols). The thiols are generally liquids with penetrating and disagreeable odours, which persist even at extremely low concentrations in the air. They are soluble in dilute sodium hydroxide solution. Thiols are best characterised as the crystalline 2 : 4-dinitrophenyl thioethers or as the corresponding sulphones (see Section III,168).

Sulphides (thioethers). The organic sulphides are usually liquids with penetrating and disagreeable odours. In contrast to the oxygen analogues (ethers), they are readily oxidised; thus sulfoxides are produced with hydrogen peroxide, and sulphones with nitric acid or with potassium permanganate in glacial acetic acid solution :

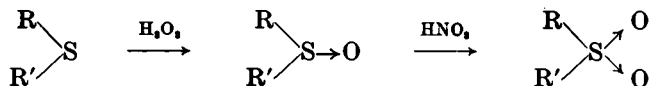

Thioethers usually yield sulphonium salts when warmed with ethyl iodide and allowed to cool. The physical properties (b.p., density and refractive index) are useful for identification purposes.

Disulphides. Disulphides are liquids or low m.p. solids and have unpleasant odours, particularly if liquid. They are reduced by zinc and dilute acids to the mercaptans :



Sulfoxides. These are usually solids of low m.p. They may be oxidised in glacial acetic acid solution by potassium permanganate to the corresponding sulphones, and reduced to the sulphides by boiling with tin or zinc and hydrochloric acid.

Sulphones. Sulphones are usually crystalline solids, and are extremely stable to most oxidising, reducing and hydrolytic reagents.

Esters of sulphuric acid. These compounds are generally water-insoluble liquids and are saponified by boiling with water or dilute alkali to the corresponding alcohols and sulphuric acid :

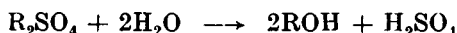

They are usually poisonous and can be identified by using them to alkylate β -naphthol (compare Section IV,104).

The alkyl esters of sulphonic acids exhibit properties similar to those of the alkyl sulphates, and are hydrolysed, by boiling with aqueous alkalis, to the alcohols and sulphonates. Thus with ethyl *p*-toluenesulphonate :

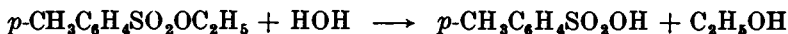

The salts of monoalkyl sulphates are frequently encountered as commercial detergents (for example, "dreet," "gardinol" and "pentrone") : they are usually sodium salts, the alkyl components contain 12 or more carbon atoms, and give colloidal solutions. They are hydrolysed by boiling with dilute sodium hydroxide solution :

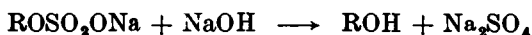

Bisulphite compounds of aldehydes and ketones. These substances are decomposed by dilute acids into the corresponding aldehydes or ketones with the liberation of sulphur dioxide. The aldehyde or ketone may be isolated by steam distillation or by extraction with ether. Owing to the highly reactive character of aldehydes, the bisulphite addition compounds are best decomposed with saturated sodium bicarbonate solution : sodium carbonate solution is generally employed for the bisulphite compounds of ketones.

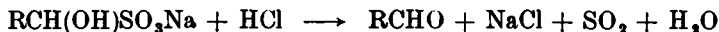

isoThiocyanates. These compounds, also known as mustard oils, are oils or low melting point solids, and usually possess irritating odours. Upon boiling with acids, for example with concentrated hydrochloric acid, they are hydrolysed to the primary amines and hydrogen sulphide is evolved :

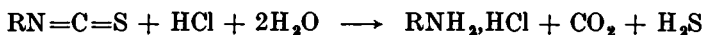

They react with amines to form substituted thioureas :

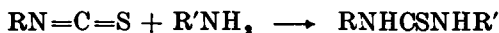

this reaction is also employed for the characterisation of amines (see Section III,123,2).

It is convenient to summarise the more important class reactions given in this Section.

Summary of the more important Class Reactions

Unsaturation :

- (a) Bromine in carbon tetrachloride.
- (b) Potassium permanganate solution.

Saturated hydrocarbons :

Fuming sulphuric acid.

Halogens :

- (a) Alcoholic silver nitrate solution.
- (b) Sodium iodide in acetone.

Aldehydes and ketones :

2 : 4-Dinitrophenylhydrazine.

Aldehydes :

- (a) Schiff's reagent.
- (b) Fehling's solution.
- (c) Ammoniacal silver nitrate solution.

Esters and anhydrides :

- (a) Hydroxamic acid test.
- (b) Saponification ; saponification equivalent.

Alcohols :

- (a) Sodium together with reaction (b).
- (b) Acetyl chloride or benzoyl chloride.
- (c) Hydrochloric acid - zinc chloride reagent.

Ethers :

- (a) Sodium.
- (b) Acetyl chloride.
- (c) Hydriodic acid.

Carboxylic acids :

- (a) Sodium bicarbonate and sodium hydroxide solution.
- (b) Neutralisation equivalent.

Phenols :

- (a) Sodium bicarbonate and sodium hydroxide solution.
- (b) Bromine in carbon tetrachloride and bromine water.
- (c) Ferric chloride solution.

Amines :

- (a) Acetyl, benzoyl or benzenesulphonyl chloride.
- (b) Nitrous acid.

Nitro compounds :

- (a) Zinc and ammonium chloride solution.
- (b) Tin and hydrochloric acid.

Amides :

- (a) Dilute sodium hydroxide solution.
- (b) Dilute sulphuric acid.

Nitriles :

- (a) Dilute sodium hydroxide solution.
- (b) Dilute sulphuric acid.

Sulphonic acids :

- (a) Sulphur present.
- (b) Sodium bicarbonate and sodium hydroxide solution.
- (c) *S*-Benzyl-*iso*-thiuronium chloride.
- (d) Neutralisation equivalent.

Sulphonamides :

- (a) Sulphur and nitrogen present.
- (b) Sodium hydroxide solution.
- (c) Sulphuric acid (70-80 per cent.).

NOTE ON ACYLOINS

The formation of acyloins (α -hydroxyketones of the general formula $RCH(OH)COR$, where R is an aliphatic residue) proceeds best by reaction between finely-divided sodium (2 atoms) and esters of aliphatic acids (1 mol) in anhydrous ether or in anhydrous benzene with exclusion of oxygen: salts of enediols are produced, which are converted by hydrolysis into acyloins. The yield of acetoin from ethyl acetate is low (ca. 23 per cent. in ether) owing to the accompanying acetoacetic ester condensation; the latter reaction is favoured when the ester is used as the solvent. Ethyl propionate and ethyl *n*-butyrate give yields of 52 per cent. of propionoin and 72 per cent. of butyroin respectively in ether.

The *mechanism* of the formation of an acyloin from an ester may involve the initial formation of a diketone; the latter is reduced by the metal to give the sodium salt of the enediol form of the acyloin:

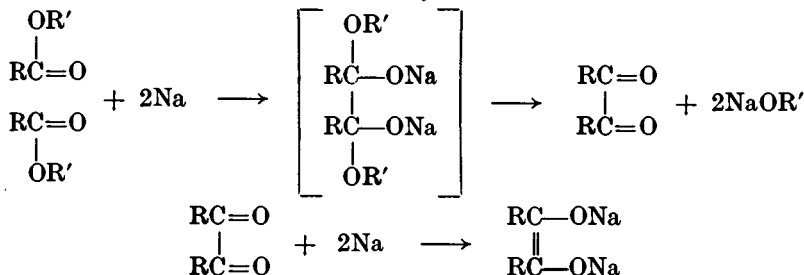

Some support for this mechanism is provided by the isolation of small amounts of 1 : 2-diketones (RCOCOR) as by-products of the reaction.

XI,8. THE PREPARATION OF DERIVATIVES

The steps so far taken in the identification of a compound, *viz.*, (i) determination of the physical constants and the establishment of the purity (Section XI,2), (ii) qualitative analysis for the elements (Section XI,3), (iii) study of the solubility behaviour towards selected solvents (Section XI,5 and XI,6) and (iv) application of class reactions (Section XI,7), will, in general, establish the class to which the compound belongs. The next step is to prove its identity with one of the members of the class. It is at this stage that the literature is consulted. In the first instance, the appropriate table or tables in this volume are examined.* Those compounds are selected which have melting points or boiling points within about 5° of the unknown: it is assumed, of course, that the latter was supplied or subsequently obtained in a state of purity (Section XI,2). To distinguish between these, a suitable *derivative* is prepared and its physical properties determined; if these agree with those of the known derivative of one of the possibilities already considered, then the identity of the compounds may be assumed. If the list of possible compounds is long, the preparation of two derivatives may be desirable. It must, however, be pointed out that in eliminating compounds from the list of possibilities, due consideration must be paid to other sufficiently characteristic properties, such as density, refractive index, neutralisation equivalent, molecular weight and optical rotation (where applicable), with adequate allowance for experimental error.

The requirements of a satisfactory derivative include:

(1) The derivative should be easily and quickly prepared in good yield by an unambiguous reaction, and be easily purified. In practice, this generally means that the derivative must be a solid, because of the

* It will be observed that these tables have not been arranged in the order of increasing melting or boiling points to facilitate quick reference: in the author's view it is far more satisfactory to group analogous compounds together so that variations of the physical properties of the actual compounds and their derivatives may be seen at a glance. The student is recommended to rearrange the compounds constituting the various classes in order of increasing melting points and/or boiling points, and to add a column for the formulae of the individual compounds; these modified tables should be preserved in a stiff-covered folder for reference. This task will serve to familiarise the student with the individual members of the different classes of organic compounds.

greater ease of manipulation of small quantities of solids and the fact that melting points are more accurate and more easily determined than boiling points. The melting point should preferably be above 50° , but below 250° ; compounds which melt below 50° are frequently difficult to crystallise.

(2) The derivative should be prepared preferably by a general reaction, which under the same experimental conditions would yield a definite derivative with the other individual possibilities. Rearrangements and side reactions should be avoided.

(3) The properties (physical and chemical) of the derivatives should be markedly different from those of the original compound.

(4) The derivative selected in any particular instance should be one which clearly singles out one compound from among all the possibilities and thus enables an unequivocal choice to be made. The melting points of the derivatives to be compared should differ by at least $5-10^{\circ}$. Whenever possible, a derivative should be selected which has a neutralisation equivalent as well as a melting point (e.g., an aryloxyacetic acid derivative of a phenol, Section IV, 114, 4, or a hydrogen 3-nitrophthalate of an alcohol, Section III, 25, 5).

The above considerations will assist the student in the selection of a derivative. It should also be borne in mind that when a compound has several functional groups, that functional group should be chosen for the preparation of a derivative which gives the least ambiguous reaction.

The methods of preparation of some of the more important derivatives of a number of classes of organic compounds are described in the various Sections dealing with their reactions and characterisation. These Sections conclude with tables incorporating the melting points and boiling points of the compounds themselves, and also the melting points of selected derivatives. For convenience, the references to the various tables are collected below.

Saturated Aliphatic Hydrocarbons, Table III, 6.

Unsaturated Aliphatic Hydrocarbons, Table III, 11.

Aromatic Hydrocarbons, Table IV, 9.

Aliphatic Alcohols, Table III, 27.

Polyhydric Alcohols, Table III, 136.

Sugars, Table III, 139.

Aromatic Alcohols, Table IV, 205.

Phenols, Table IV, 114.

Enols, Table IV, 114A.

Aliphatic Halogen Compounds, Table III, 42

Aromatic Halogen Compounds, Table IV, 28.

Aliphatic Ethers, Table III, 60.

Aromatic Ethers, Table IV, 106.

Acetals, Table III, 69.

Aliphatic Aldehydes, Table III, 70.

Aromatic Aldehydes, Table IV, 135.

Aliphatic Ketones, Table III, 74.

Aromatic Ketones, Table IV, 148.

Aliphatic Carboxylic Acids, Table III, 85.

Aromatic Carboxylic Acids, Table IV, 175.
Aliphatic Acid Chlorides, Table III, 88.
Aliphatic Acid Anhydrides, Table III, 94.
Acid Chlorides and Acid Anhydrides of Aromatic Acids, Table IV, 187.
Aliphatic Esters, Table III, 106.
Aromatic Esters, Table IV, 183.
Primary Aliphatic Amides, Table III, 110.
Primary Aromatic Amides, Table IV, 191.
Substituted Aromatic Amides, Table IV, 192.
Aliphatic Nitriles, Table III, 115.
Aromatic Nitriles, Table IV, 195.
Primary and Secondary Aliphatic Amines, Table III, 123.
Primary Aromatic Amines, Table IV, 100A.
Secondary Aromatic Amines, Table IV, 100B.
Tertiary Aliphatic and Aromatic Amines, Table IV, 100C.
Amino Acids, Table III, 132.
Mercaptans (Thiols), Table III, 168.
Aromatic Nitro Compounds, Table IV, 16A.
Aliphatic Nitro Compounds, Table IV, 16B.
Aromatic Sulphonic Acids, Table IV, 33.
Aromatic Sulphonamides, Table IV, 33A.
Quinones, Table IV, 152.

For the sake of completeness, the following Tables are included in this Chapter :

Imides, Table XI, 8,1.
Nitroso, Azo, Azoxy and Hydrazo Compounds, Table XI, 8,2.
Oximes, Table XI, 8,3.
Miscellaneous Sulphur Compounds, Table XI, 8,4.

TABLE XI,8,1.

IMIDES

<i>Compound</i>	<i>M.P.</i>
Succinimide	125°
<i>N</i> -Phenylsuccinimide	156
Maleimide	93
<i>N</i> -Phenylmaleimide	91
Phthalimide	233
<i>N</i> -Phenylphthalimide	205
3-Nitrophthalimide	216
β -Bromoethylphthalimide	82
β -Hydroxyethylphthalimide	128
Naphthalimide	300
Alloxan (4H ₂ O)	170d
<i>o</i> -Benzoic sulphimide (saccharin)	226d
Barbituric acid	245d
Diethylbarbituric acid (<i>Veronal</i>)	190
Diallylbarbituric acid (<i>Dial</i>)	173
Ethyl- <i>n</i> -butyl-barbituric acid (<i>Neonal</i>)	128
Ethyl-(1-methylbutyl)-barbituric acid (<i>Pentobarbital</i>)	130
Ethyl- <i>n</i> -hexyl-barbituric acid (<i>Ortal</i>)	126
Ethyl- <i>isopropyl</i> -barbituric acid (<i>Ipral</i>)	201
Ethyl- <i>isoamyl</i> -barbituric acid (<i>Amytal</i>)	155
Ethyl-phenyl-barbituric acid (<i>Phenobarbital</i>)	171

TABLE XI,8,2. NITROSO, AZO, AZOXY AND HYDRAZO COMPOUNDS

<i>Compound</i>	<i>M.P.</i>
<i>Nitroso Compounds :</i>	
Methylphenylnitrosoamine	B.P. 120°/13 —
Ethylphenylnitrosoamine	B.P. 134°/16 —
Nitrosobenzene	68°
<i>o</i> -Nitrosotoluene	72
<i>m</i> -Nitrosotoluene	53
<i>p</i> -Nitrosotoluene	48
α -Nitrosonaphthalene	98
<i>p</i> -Nitrosophenol	125d
α -Nitroso- β -naphthol	109
4-Nitroso- α -naphthol	198
<i>p</i> -Nitroso- <i>NN</i> -dimethylaniline	87
<i>p</i> -Nitroso- <i>NN</i> -diethylaniline	84
<i>p</i> -Nitroso- <i>N</i> -methylaniline	118
<i>p</i> -Nitroso- <i>N</i> -ethylaniline	78
<i>p</i> -Nitrosodiphenylamine	144
<i>Azo Compounds :</i>	
Azobenzene	68°
<i>o</i> -Azotoluene	55
<i>m</i> -Azotoluene	55
<i>p</i> -Azotoluene	144
<i>o</i> -Azophenetole	131
<i>p</i> -Azophenetole	160
Benzeneazo- <i>o</i> -cresol	128
α -Benzeneazo- β -naphthol	134
β -Benzeneazo- α -naphthol	138
4-Benzeneazo- α -naphthol	206d
Benzeneazodiphenylamine	82
α -Benzeneazo- β -naphthylamine	104
4-Benzeneazo- α -naphthylamine	123
<i>p</i> -Aminoazobenzene	126
<i>p</i> -Dimethylaminoazobenzene	117
<i>p</i> -Hydroxyazobenzene	152
2 : 2'-Dichloroazobenzene	137
3 : 3'-Dichloroazobenzene	101
4 : 4'-Dichloroazobenzene	188
<i>Azoxy Compounds :</i>	
Azoxybenzene	36°
<i>o</i> -Azoxytoluene	60
<i>m</i> -Azoxytoluene	39
<i>p</i> -Azoxytoluene	70
<i>o</i> -Azoxyanisole	81
<i>m</i> -Azoxyanisole	52

TABLE XI,8,2. NITROSO, AZO, AZOXY AND HYDRAZO COMPOUNDS
(continued)

Compound	M.P.
<i>Azoxy Compounds (continued) :</i>	
<i>p</i> -Azoxyanisole	119°
<i>o</i> -Azoxyphenetole	102
<i>m</i> -Azoxyphenetole	50
<i>p</i> -Azoxyphenetole	138
1 : 1'-Azoxynaphthalene	127
2 : 2'-Azoxynaphthalene	168
2 : 2'-Dichloroazoxybenzene	56
3 : 3'-Dichloroazoxybenzene	97
4 : 4'-Dichloroazoxybenzene	158
<i>Hydrazo Compounds :</i>	
Hydrazobenzene	126°
<i>o</i> -Hydrazotoluene	165
<i>m</i> -Hydrazotoluene	38
<i>p</i> -Hydrazotoluene	134
<i>o</i> -Hydrazophenol	148
<i>o</i> -Hydrazoanisole	102
<i>o</i> -Hydrazophenetole	89
<i>m</i> -Hydrazophenetole	119
<i>p</i> -Hydrazophenetole	86
1 : 1'-Hydrazonaphthalene	153
2 : 2'-Hydrazonaphthalene	141

TABLE XI,8,3.

OXIMES

<i>Compound</i>	<i>B.P.</i>	<i>M.P.</i>
α -Acetaldoxime	—	47°
α -Propionaldoxime	—	40
α - <i>n</i> -Butyraldoxime	153°	—
α - <i>iso</i> -Butyraldoxime	140	—
α - <i>n</i> -Valeraldoxime	—	52
α - <i>iso</i> -Valeraldoxime	—	49
α - <i>n</i> -Hexaldoxime	—	51
α - <i>n</i> -Heptaldoxime	—	54
α -Benzaldoxime	—	33
β -Benzaldoxime	—	128
α -Furfuraldoxime	—	76
β -Furfuraldoxime	—	92
Salicylaldoxime	—	59
Acetoxime	—	61
Methyl ethyl ketoxime	152	—
Diethyl ketoxime	165	—
Di- <i>n</i> -propyl ketoxime	195	—
Di- <i>n</i> -butyl ketoxime	124°/15 mm.	—
Acetophenone oxime	—	60
Benzophenone oxime	—	142
Benzil monoxime	—	137
α -Benzil dioxime	—	237
Diacetyl monoxime	—	75
Dimethyl glyoxime	—	237
Carvoxime	—	71
<i>d</i> -Camphor oxime	—	116

TABLE XI,8,4. MISCELLANEOUS SULPHUR COMPOUNDS

<i>Compound</i>	<i>B.P.</i>	<i>M.P.</i>	d_{4}^{20}	n_D^{20}
Dimethyl sulphide	38°	—	0.849	1.436
Methyl ethyl sulphide	66	—	0.846	1.440
Diethyl sulphide	92	—	0.837	1.442
Di- <i>n</i> -propyl sulphide	142	—	0.839	1.449
Di- <i>iso</i> -propyl sulphide	119	—	0.817	1.440
Di- <i>n</i> -butyl sulphide	187	—	0.840	1.453
D- <i>iso</i> -butyl sulphide	169	—	0.826	1.447
Di- <i>sec</i> -butyl sulphide	165	—	0.835	1.451
Di- <i>n</i> -amyl sulphide	85°/4	—	0.841	1.456
Di- <i>iso</i> -amyl sulphide	86°/5	—	0.834	1.453
Di- <i>n</i> -hexyl sulphide	114°/4	—	0.841	1.459
Di- <i>n</i> -heptyl sulphide	142°/4	—	0.842	1.461
Di- <i>n</i> -octyl sulphide	162°/4	—	0.845	1.469
Di-allyl sulphide	140	—	—	—
Diphenyl sulphide	145°/8	—	1.114	1.633
Di- <i>p</i> -tolyl sulphide	—	57°	—	—
Dibenzyl sulphide	—	50	—	—
Dimethyl disulphide	109	—	1.065	1.526
Diethyl disulphide	153	—	0.992	1.507
Di- <i>n</i> -propyl disulphide	194	—	0.960	1.498
Di- <i>iso</i> -propyl disulphide	176	—	0.944	1.492
Di- <i>n</i> -butyl disulphide	231	—	0.938	1.493
Di- <i>iso</i> -butyl disulphide	215	—	0.928	1.487
Di- <i>tert</i> -butyl disulphide	65°/5	—	0.923	1.490
Di- <i>n</i> -amyl disulphide	119°/7	—	0.922	1.489
Di- <i>iso</i> -amyl disulphide	115°/9	—	0.919	1.486
Di-allyl disulphide	100°/48	—	—	—
Diphenyl disulphide	—	60	—	—
Di- <i>p</i> -tolyl disulphide	—	48	—	—
Dibenzyl disulphide	—	73	—	—
Diphenyl sulphoxide	—	70	—	—
Di- <i>p</i> -tolyl sulphoxide	—	95	—	—
Dibenzyl sulphoxide	—	134	—	—
Dimethyl sulphone	238	109	—	—
Diethyl sulphone	248	74	—	—
Di- <i>n</i> -propyl sulphone	—	29	—	—
Di- <i>n</i> -butyl sulphone	—	44	—	—
Sulphonal	—	126	—	—
Trional	—	76	—	—
Diphenyl sulphone	—	128	—	—
Di- <i>p</i> -tolyl sulphone	—	159	—	—
Dibenzyl sulphone	—	150	—	—
Methyl thiocyanate	131	—	1.082	—
Ethyl thiocyanate	147	—	1.024	1.465
<i>iso</i> -Propyl thiocyanate	151	—	—	—
<i>n</i> -Propyl thiocyanate	165	—	0.981	1.463
<i>n</i> -Butyl thiocyanate	184	—	0.961	1.464
Benzyl thiocyanate	—	38	—	—

TABLE XI,8,4. MISCELLANEOUS SULPHUR COMPOUNDS
(continued)

Compound	B.P.	M.P.	d_4^{20}	n_D^{20}
Allyl <i>iso</i> -thiocyanate	152°	—	1.010	1.524
Phenyl <i>iso</i> -thiocyanate	221	—	1.134	1.651
Thiophene	84	—	1.062	1.525
Methyl <i>p</i> -toluenesulphonate	—	28°	—	—
Ethyl <i>p</i> -toluenesulphonate	173°/15	33	—	—
<i>n</i> -Propyl <i>p</i> -toluenesulphonate	165°/10	—	—	—
<i>n</i> -Butyl <i>p</i> -toluenesulphonate	175°/10	—	—	—
Phenyl <i>p</i> -toluenesulphonate	—	96	—	—
Thiourea	—	180	—	—
Allyl thiourea	—	78	—	—
Phenyl thiourea	—	154	—	—
<i>sym.</i> -Diphenylthiourea (thiocarbanilide)	—	154	—	—
<i>sym.</i> -Di- <i>o</i> -tolyl thiourea	—	166	—	—
<i>sym.</i> -Di- <i>m</i> -tolyl thiourea	—	112	—	—
<i>sym.</i> -Di- <i>p</i> -tolyl thiourea	—	178	—	—
Thiosemicarbazide	—	182	—	—

Suggestions as to the methods for identifying the above classes of compounds will be found under *Class Reactions* in Section XI,7. Some further remarks upon enolic compounds (see Table IV,114A) may be made here. Enols may be divided into (a) β -keto esters and (b) 1 : 3-diketones. With 5 per cent. sodium hydroxide solution, a β -keto ester yields the salt of the corresponding acid, which when heated with dilute hydrochloric acid is decarboxylated to a ketone :

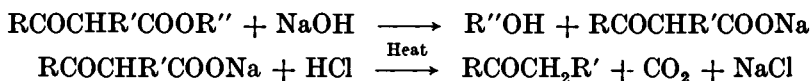

A 1 : 3-diketone, under similar conditions, affords a ketone and the salt of an acid :

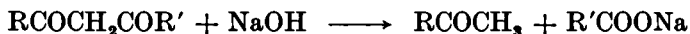

Two simple tests for enols may be given here :

(i) *Ferric chloride solution.* Add a few drops of neutral aqueous ferric chloride to a solution of 0.1 g. of the compound in water or in methanol. Most enols give a red colouration.

Prepare the neutral ferric chloride solution (*i.e.*, free from hydrochloric acid) by adding dilute sodium hydroxide solution dropwise to the bench reagent until a slight precipitate of ferric hydroxide is formed. Filter off the precipitate and use the clear filtrate for the test.

(ii) *Copper derivative.* Shake 0.2 g. of the substance vigorously with a little cold, saturated, aqueous copper acetate solution. Many enols give a solid, green or blue, copper derivative, which can be crystallised from alcohol and often has a definite m.p.

An enol is usually characterised by treatment with ketonic reagents or with phenylhydrazine (compare Section IV, 114 and Table IV, 114A), or by hydrolysis with acid, followed by the identification of the ketone.

It will be appreciated that the Tables are far from complete, but they do contain most of the common organic compounds which the student is likely to encounter in the course of his work in the laboratory. For compounds which are not listed in the Tables, reference should be made to larger treatises. These include :

Mulliken, *Identification of Pure Organic Compounds*, Volumes I-IV, 1904-1922 (J. Wiley : this work is difficult to obtain in Great Britain).

Huntress - Mulliken, *Identification of Pure Organic Compounds*, Order I, 1941 (J. Wiley : Chapman and Hall).

Huntress, *Organic Chlorine Compounds*, Order III, 1948 (J. Wiley; Chapman and Hall).

Heilbron and Bunbury, *Dictionary of Organic Compounds*, Revised Edition, Four Volumes, 1953 (Eyre and Spottiswoode).

Beilstein, *Handbuch der Organischen Chemie*, Fourth Edition, 1919-1955, 84 Volumes (J. Springer, Berlin).

Elsevier's Encyclopaedia of Organic Chemistry, Edited by F. Radt, 1946-1955, 14 Volumes (Elsevier Press ; Cleaver-Hume Press).

"Beilstein" is the most comprehensive list of organic compounds. The main series, volumes 1-27, 30 and 31, part I, covers the literature up to 1910. The first supplement, volumes 1-27, and the subject and formulae indexes constituting volumes 28 and 29, survey the literature up to 1919. The second supplement, volumes 1-27, and the subject and formulae indexes constituting volumes 28 and 29, covers the period 1920-1929. For compounds not listed in "Beilstein", *i.e.*, for those which first appear in the literature after 1929, the indexes of the Abstract Journals {Chemical Abstracts, Chemisches Zentralblatt or British Chemical Abstracts (to 1953)} should be consulted. The Collective Formula Index to Chemical Abstracts, 1920-1946, is extremely useful. For general reference work "Heilbron" will be found less cumbersome than "Beilstein", although of necessity not so comprehensive.

XI.9. QUALITATIVE ANALYSIS OF MIXTURES OF ORGANIC COMPOUNDS

The general method to be adopted for the analysis of mixtures of organic compounds is to separate them into their components and to

identify each component as previously described. It is impossible, however, to give a set of procedures which will be applicable, without modification, to the great variety of combinations which may be encountered. The student will be expected to take advantage of any facts which have emerged in the preliminary examination and to adapt, if necessary, the general schemes given below to the mixture under examination. The preliminary examination is therefore of fundamental importance.

Broadly speaking, the separation of the components of mixtures may be divided into three main groups.

(1) **Separations based upon differences in the chemical properties of the components.** Thus a mixture of toluene and aniline may be separated by extraction with dilute hydrochloric acid: the aniline passes into the aqueous layer in the form of the salt, aniline hydrochloride, and may be recovered by neutralisation. Similarly, a mixture of phenol and toluene may be separated by treatment with dilute sodium hydroxide. The above examples are, of course, simple applications of the fact that the various components fall into different solubility groups (compare Section XI,5). Another example is the separation of a mixture of di-*n*-butyl ether and chlorobenzene: concentrated sulphuric acid dissolves only the *n*-butyl ether and it may be recovered from solution by dilution with water. With some classes of compounds, *e.g.*, unsaturated compounds, concentrated sulphuric acid leads to polymerisation, sulphonation, etc., so that the original component cannot be recovered unchanged: this solvent, therefore, possesses limited application. Phenols may be separated from acids (for example, *o*-cresol from benzoic acid) by a dilute solution of sodium bicarbonate: the weakly acidic phenols (and also enols) are not converted into salts by this reagent and may be removed by ether extraction or by other means; the acids pass into solution as the sodium salts and may be recovered after acidification. Aldehydes, *e.g.*, benzaldehyde, may be separated from liquid hydrocarbons and other neutral, water-insoluble liquid compounds by shaking with a solution of sodium bisulphite: the aldehyde forms a solid bisulphite compound, which may be filtered off and decomposed with dilute acid or with sodium bicarbonate solution in order to recover the aldehyde.

In connexion with the above "chemical" methods of separation, it is important to note that sufficient of the extracting reagent must be used to remove *completely* the component which it dissolves or with which it reacts.

(2) **Separations based upon differences in the volatilities of the components in aqueous solution.** This procedure is generally employed for the water-soluble compounds listed in Solubility Table XI,5, and may also be applied to mixtures in which one of the components is slightly soluble in water. The water-soluble compounds include the lower members of the homologous series of alcohols, aldehydes, ketones, acids, esters, amines and nitriles; compounds containing two or more hydroxyl or amino groups, hydroxy-, amino-, di- and polybasic acids, sulphonic acids and salts. The compounds with one functional group are usually volatile in steam and distil with the water: compounds with two or more functional groups (amino, hydroxyl or

carboxyl) are not generally steam-volatile. The stable salts of steam-volatile bases and acids may be decomposed by a stronger non-volatile mineral acid (sulphuric acid or phosphoric acid) or base (sodium or potassium hydroxide), and the organic base or acid separated by steam distillation from the aqueous solution or suspension. The salts of weaker bases and acids (*e.g.*, the amine or ammonium salts of carboxylic acids and the alkali metal salts of some phenols) are sufficiently hydrolysed by boiling water to permit the basic or acidic compound to distil with the water. It should be noted that sulphonic acids and their salts are not volatile in steam. The only disadvantage of this procedure is that certain compounds may decompose or polymerise or otherwise undergo change under the influence of aqueous alkali or acid at 100°, and this fact must be borne in mind when the method is employed. Thus sugars are decomposed by alkali; these may sometimes be isolated by evaporation of the solvent at pH 7, preferably under diminished pressure.

The essential basis of the scheme for the separation of water-soluble compounds is, therefore, distillation of (a) an aqueous solution of the mixture, (b) an alkaline (with sodium hydroxide) solution of the mixture, and (c) an acidic (with sulphuric or phosphoric acid) solution of the mixture. The residue will contain the non-volatile components, which must be separated from inorganic salts and from each other by any suitable process.

The following are examples of the above procedure. A mixture of diethylamine and *n*-butyl alcohol may be separated by adding sufficient dilute sulphuric acid to neutralise the base: steam distillation will remove the alcohol. The amine can be recovered by adding sodium hydroxide to the residue and repeating the distillation. A mixture of diethyl ketone and acetic acid may be treated with sufficient dilute sodium hydroxide solution to transform the acid into sodium acetate and distilling the aqueous mixture. The ketone will pass over in the steam and the non-volatile, stable salt will remain in the flask. Acidification with dilute sulphuric acid liberates acetic acid, which can be isolated by steam distillation or by extraction.

(3) **Separations based upon differences in the physical properties of the components.** When procedures (1) or (2) are unsatisfactory for the separation of a mixture of organic compounds, purely physical methods may be employed. Thus a mixture of volatile liquids may be fractionally distilled (compare Sections II,15 and II,17): the degree of separation may be determined by the range of boiling points and/or the refractive indices and densities of the different fractions that are collected. A mixture of non-volatile solids may frequently be separated by making use of the differences in solubilities in inert solvents: the separation is usually controlled by m.p. determinations. Sometimes one of the components of the mixture is volatile and can be separated by sublimation (see Section II,45).

1. PRELIMINARY EXAMINATION OF A MIXTURE

A. LIQUID MIXTURES

(i) **Physical properties.** Examine the mixture with regard to odour, viscosity and colour.

(ii) **Solubility in water.** Transfer 1.0 ml. of the mixture by means of a calibrated dropper or a small pipette into a small graduated test-tube : add 1 ml. of water and shake. Observe whether there is complete or partial solution and if there is any sign of chemical reaction. If solution is not complete, add more water (in 1 ml. portions) and note (a) if the mixture dissolves completely, and (b) if a portion is insoluble and, if so, whether it is heavier or lighter than the aqueous layer. If an emulsion is formed, it may be assumed that at least one component of the mixture is insoluble in water and at least one component is soluble. Test the aqueous layer obtained with litmus and with phenolphthalein : if there is an acid reaction, test also with 5 per cent. sodium bicarbonate solution.

(iii) **Presence or absence of water.** Determine the absence or presence of water in the solution by one or more of the following tests :

(a) Investigate its miscibility with ether or with benzene.

(b) Observe its action upon anhydrous copper sulphate.

(c) Distil a small portion and note the b.p. and properties of the distillate.

(d) Distil 3 ml. of the mixture with 3 ml. of dry toluene from a dry 10 ml. distilling flask. Collect 2 ml. of the distillate and dilute it with 5 ml. of dry toluene ; the formation of two layers or of distinct drops suspended in the toluene indicates the presence of water.

(iv) **Behaviour upon distillation.** If the original mixture is not an aqueous solution, place 5 ml. (or 10 ml.) of it in a 10 ml. (or 25-ml.) distilling flask, immerse the latter in a small beaker of cold water, and gradually heat to boiling. Observe the b.p. of any liquid which passes over and set it aside for subsequent examination. Determine the water solubility of any residue. If it dissolves in water, examine it by Table XI,9,2 ; if it is insoluble in water, apply Table XI,9,1.

(v) **Test for elements.** If the mixture is an aqueous solution, evaporate a small portion (*ca.* 1 ml.) to dryness upon platinum foil or in a small crucible. Use a portion of the residue to test for elements (Section XI,3) and another portion for the *Ignition Test* (vi).

If no water is present in the mixture, use it directly in the tests for elements.

(vi) **Ignition test.** Place 0.1–0.2 g. of the mixture on a porcelain crucible cover : heat gently at first over a small flame and finally ignite strongly. Observe :

(a) The inflammability and nature of the flame (*e.g.*, smoky or otherwise).

(b) Odour of gases or vapours evolved (**CAUTION !**).

(c) Whether a residue is left after ignition ; moisten with hydrochloric acid and test with a platinum wire.

(vii) **Miscellaneous solubility tests.** If water is absent, carry out the following tests. Treat 1 ml. of the mixture with 5 per cent. sodium hydroxide solution until strongly alkaline : note whether an oil or solid separates, whether any ammonia is evolved, and any colour changes

which occur. Heat to boiling and cool : compare odour with that of the original mixture (a change in odour may indicate the presence of esters). Add dilute hydrochloric acid and observe the result.

Treat 1 ml. of the mixture with dilute hydrochloric acid until strongly acid. Note any evolution of gas or the separation of a solid. Add dilute sodium hydroxide solution and observe the effect.

(viii) **Miscellaneous class reactions.** Determine the effect of the following class reagents upon small portions of the original mixture : (a) bromine in carbon tetrachloride solution, (b) potassium permanganate solution, (c) alcoholic silver nitrate solution, (d) 2 : 4-dinitrophenylhydrazine reagent, (e) Schiff's reagent, (f) acetyl chloride, (g) benzoyl chloride (in the presence of aqueous sodium hydroxide), (h) sodium (only if water is absent), (i) ferric chloride solution, and (j) bromine water.

B. SOLID MIXTURES

(i) **Physical properties.** Observe the colour, odour and crystalline form. Examine with a lens or a microscope, if available.

(ii) **Solubility in water.** Determine the solubility of 1.0 g. of the sample in water. If in doubt as to whether a portion of the mixture dissolves, remove the supernatant liquid with a dropper and evaporate to dryness on a water bath. Determine the reaction of the aqueous solution or suspension to litmus and to phenolphthalein.

(iii) **Test for elements.** See Section XI.3.

(iv) **Ignition test.** Place 0.1–0.2 g. of the mixture upon a porcelain crucible cover or upon a piece of platinum foil ; heat gently at first and finally ignite strongly. Note :

(a) Whether the mixture melts and if decomposition occurs.

(b) The inflammability and the nature of the flame (e.g., if smoky or otherwise).

(c) Whether a residue is obtained after ignition (moisten with hydrochloric acid and test with a platinum wire).

(v) **Miscellaneous solubility tests.** Test the solubility behaviour of 0.5–1 g. of the mixture to 5 per cent. sodium hydroxide solution, 5 per cent. sodium bicarbonate solution and to 5 per cent. hydrochloric acid (for details, see under *Liquid Mixtures*).

(vi) **Miscellaneous class reactions.** Determine the effect of the following class reagents upon small portions of the original mixture (for some of the tests an aqueous solution or suspension may be used) : (a) bromine in carbon tetrachloride solution, (b) potassium permanganate solution, (c) alcoholic silver nitrate solution, (d) 2 : 4-dinitrophenylhydrazine reagent, (e) Schiff's reagent, (f) acetyl chloride, (g) benzoyl chloride (in the presence of aqueous sodium hydroxide), (h) ferric chloride solution and (i) bromine water.

A careful consideration of the results of the above tests will provide much useful information and will indicate which of the following general procedures should be applied and the modifications which are necessary. Thus if nitrogen is absent, it is doubtful whether the separation for bases would be necessary.

2. SEPARATION OF WATER-INSOLUBLE MIXTURES

If the water-insoluble mixture is a liquid, evaporate a small sample (say, 4 ml.) in an evaporating dish on a water bath in order to determine the amount of volatile components, if any. If the solvent distils at the temperature of the boiling water bath, it is advisable to distil off this solvent on a water bath and to replace it by ether.

Place 15–20 ml. of the liquid mixture in a 50 ml. distilling flask arranged for distillation (Fig. II, 13, 2), and heat the flask on a boiling water bath until no more liquid passes over: redistil the distillate and if it is a single substance, identify it in the usual manner. Dissolve the residue (*R*) in ether and employ the same proportions as given for a solid mixture.

Step 1. Extraction and separation of the acidic components. Shake 5–10 g. of the solid mixture (or of the residue *R* obtained after the removal of the solvent on a water bath) with 50 ml. of pure ether.* If there is a residue (this probably belongs to Solubility Group II or it may be a polysaccharide), separate it by filtration, preferably through a sintered glass funnel, and wash it with a little ether. Shake the resulting ethereal solution in a small separatory funnel with 15 ml. portions of 5 per cent. aqueous sodium hydroxide solution until *all* the acidic components have been removed. Three portions of alkali are usually sufficient. Set aside the residual ethereal solution (*E*₁) for *Step 2*. Combine the sodium hydroxide extracts and wash the resulting mixture with 15–20 ml. of ether: place the ether in the *ETHER RESIDUES* bottle. Render the alkaline extract acid to litmus with dilute sulphuric acid and then add excess of solid sodium bicarbonate.

Separate any *phenolic or enolic compounds* which may be present by extracting the sodium bicarbonate solution with two 20 ml. portions of ether; remove the ether from the extract and examine any residue for phenols (or enols).

Strongly acidify the residual sodium bicarbonate solution to Congo red with dilute sulphuric acid. If a solid acid forms, filter. Extract the filtrate or the acidified solution with two 20 ml. portions of ether: keep the aqueous solution (*A*). Distil off the ether, and add the residual acid (if a solid) to the solid separated by filtration. Identify the acid.

Now distil the filtrate (*A*) and collect the distillate as long as it is acid to litmus. Should any solid separate out in the distilling flask during the distillation, add more water to dissolve it. Set aside the residue (*B*) in the flask. Identify the volatile acid in the distillate. A simple method is to just neutralise it with sodium hydroxide solution, evaporate to dryness and convert the residual sodium salt into the S-benzyl-iso-thiuronium salt (Section III,85,5).

The residue (*B*) in the distilling flask may still contain a water-soluble, non-volatile acid. Cool the acid solution, neutralise it with dilute sodium hydroxide solution to Congo red, and evaporate to dryness on a water bath under reduced pressure (water pump). Heat a little of the residual salt (*C*) upon the tip of a nickel spatula in a Bunsen flame and observe whether any charring takes place. If charring occurs, thus

* Peroxide-free ether should be employed: for detection and removal of peroxides in diethyl ether, see Section II,47,1.

indicating the presence of organic matter, extract the solid residue with 25 ml. portions of hot absolute ethyl alcohol. Evaporate the alcoholic extract and identify the material which remains. The residue (*C*) contains the sodium salt of a water-soluble, non-volatile acid, which may be characterised as the *S*-benzyl-*iso*-thiuronium salt.

Step 2. Extraction of the basic components. Extract the ethereal solution (E_1) with 15 ml. portions of 5 per cent. hydrochloric acid until *all* the basic components have been removed: two or three portions of acid are usually sufficient. Preserve the residual ethereal solution (E_2) for the separation of the neutral components. Wash the combined acid extracts with 15–20 ml. of ether: discard the ether extract as in *Step 1*. Make the acid extract alkaline with 10–20 per cent. sodium hydroxide solution: if any basic component separates, extract it with ether, evaporate the ether, and characterise the residue. If a water-soluble base is also present, it may be recognised by its characteristic ammoniacal odour: it may be isolated from the solution remaining after the separation of the insoluble base by ether extraction by distilling the aqueous solution as long as the distillate is alkaline to litmus. Identify the base with the aid of phenyl *iso*-thiocyanate (compare Section III,123) or by other means.

Step 3. The neutral components. The ethereal solution (E_2) remaining after the acid extraction of *Step 2* should contain only the neutral compounds of Solubility Groups V, VI and VII (see Table XI,5). Dry it with a little anhydrous magnesium sulphate, and distil off the ether. If a residue is obtained, neutral compounds are present in the mixture. Test a portion of this with respect to its solubility in concentrated sulphuric acid; if it dissolves in the acid, pour the solution slowly and cautiously into ice water and note whether any compound is recovered. Examine the main residue for homogeneity and if it is a mixture devise procedures, based for example upon differences in volatility, solubility in inert solvents, reaction with hydrolytic and other reagents, to separate the components.

The above procedure for water-insoluble mixtures is shown, in outline, in tabular form in Table XI,9,1. If the mixture is a liquid, the volatile solvent is assumed to have been removed.

TABLE XI,9,1. GENERAL SCHEME FOR SEPARATION OF A WATER-INSOLUBLE MIXTURE

Treat the mixture with pure ether and filter, if necessary.				
Residue. Examine for polysaccharides etc., according to nature of original mixture.	Filtrate or ether solution. Extract with 5% NaOH solution and separate the ethereal layer.			
	Sodium hydroxide extract. This will contain the acids and phenols (or enols) present. Acidify (litmus) with dilute sulphuric acid, add excess of solid NaHCO ₃ . Extract with ether.		Ether solution (E ₁). Extract with 5% HCl. Separate ether layer.	
	Ether solution. Contains phenolic (or enolic) compounds.	Sodium bicarbonate solution. Acidify with dilute H ₂ SO ₄ . (i) Filter or extract acid with ether. (ii) Distil aqueous solution (A) from (i) as long as distillate is acid to recover water-soluble volatile acids. (iii) Neutralise aqueous solution (B) from (ii), evaporate to dryness, and extract with absolute ethyl alcohol to recover water-soluble, non-volatile compounds. The residue may contain the sodium salt of a water soluble, non-volatile acid.		Hydrochloric acid extract. This will contain any basic components present. Render alkaline with 10-20% NaOH and extract with ether.
		Ether solution. Contains water-insoluble amines.	Aqueous solution. Will possess ammoniacal odour of water-soluble amines present. Distil as long as distillate is alkaline to recover volatile water-soluble amines.	Ether solution (E ₂). This will contain any neutral compounds present. Dry with anhydrous magnesium sulphate, and distil off the ether. A residue indicates the presence of a neutral component. Determine the solubility of a portion in conc. H ₂ SO ₄ . Apply any other suitable tests.

3. SEPARATION OF WATER-SOLUBLE MIXTURES

A water-soluble mixture may be in the form of a mixture of water-soluble solids or in the form of a liquid. The liquid mixtures are frequently aqueous solutions. The preliminary examination of a liquid mixture (see 1) will indicate whether a volatile solvent (*i.e.*, removable on a boiling water bath) is present. If a volatile solvent is present, distil 20 g. of the mixture from a water bath until no more liquid passes over: set aside the volatile solvent for identification. Dissolve the residue (*R*) in water as detailed below for a mixture of solids.

Step 1. Distillation from acid solution and the separation of the volatile acidic and neutral compounds. Dissolve 6–10 g. of a solid mixture in 50–75 ml. of water: for a liquid mixture, use 6–10 g. of the residue (*R*) (non-volatile from a boiling water bath) and dilute with 50–75 ml. of water: for an aqueous solution use sufficient of it to contain 6–10 g. of the dissolved components and dilute, if necessary, to 50–75 ml. Acidify the solution with sufficient 20 per cent. sulphuric acid to decompose the salts of all the acidic components and to ensure the presence of a slight excess of acid: many organic acids give an acid reaction with Congo red, hence it is necessary to add the sulphuric acid somewhat beyond the point at which the mixture is acid to this indicator. If an insoluble acidic component separates, filter it off and identify it. Distil the acid solution so long as the distillate appears turbid, or is acid to litmus, or until 100–150 ml. are collected: in the last case, add more water to the contents of the distilling flask if the volume has been reduced below one-fourth of the original volume. Keep the residue (*R*₁) in the distilling flask for *Step 2*.

The distillate may contain volatile neutral compounds as well as volatile acids and phenols. Add a slight excess of 10–20 per cent. sodium hydroxide solution to this distillate and distil until the liquid passes over clear or has the density of pure water. The presence of a volatile, water-soluble neutral compound is detected by a periodic determination of the density (see Section XI,2); if the density is definitely less than unity, the presence of a neutral compound may be assumed. Keep this solution (*S*₁) for *Step 4*.

Cool the alkaline solution resulting from the distillation of the volatile neutral compounds, make it acid to litmus with dilute sulphuric acid, and add an excess of *solid* sodium bicarbonate. Extract this bicarbonate solution with two 20 ml. portions of ether; remove the ether from the combined ether extracts and identify the residual phenol (or enol). Then acidify the bicarbonate solution cautiously with dilute sulphuric acid; if an acidic compound separates, remove it by two extractions with 20 ml. portions of ether; if the acidified solution remains clear, distil and collect any water-soluble, volatile acid in the distillate. Characterise the acid as under 2.

Step 2. Distillation from alkaline solution. Treat the solution (*R*₁) remaining in the distilling flask after the volatile acidic and neutral compounds have been removed with 10–20 per cent. sodium hydroxide solution until distinctly alkaline. If a solid separates, filter it off and identify it. Distil the alkaline solution until no more volatile bases pass

over (turbid distillate or no further basic reaction to litmus: water-soluble bases also possess characteristic odours): add more water to the contents of the flask if the solution becomes too concentrated during this distillation. (Set aside the solution in the distilling flask (S_2) for *Step 3*.) If the volatile basic compounds are insoluble in water, remove them by extraction with two 20 ml. portions of ether, and identify the bases (compare Sections III,123 and IV,100) after evaporation of the ether. The water-soluble amines may be identified with phenyl *iso*-thiocyanate: it is best to concentrate the bases by redistilling and collecting the first half of the distillate separately.

Step 3. The non-steam-volatile compounds. The alkaline solution (S_2) remaining in the distilling flask from *Step 2* may contain water-soluble, non-volatile acidic, basic or neutral compounds. Add dilute sulphuric acid until the solution is just acid to Congo red, evaporate to dryness, and extract the residual solid with boiling absolute ethyl alcohol: extraction is complete when the undissolved salt exhibits no sign of charring when heated on a metal spatula in the Bunsen flame. Evaporate the alcoholic solution to dryness and identify the residue.

Step 4. The steam-volatile neutral compounds. The solution (S_1) containing water-soluble neutral compounds obtained in *Step 1* is usually very dilute. It is advisable to concentrate it by distillation until about one-third to one-half of the original volume is collected as distillate; the process may be repeated if necessary and the progress of the concentration may be followed by determination of the densities of the distillates. It is frequently possible to salt out the neutral components from the concentrated distillate by saturating it with solid potassium carbonate. If a layer of neutral compound makes its appearance, remove it. Treat this upper layer (which usually contains much water) with solid anhydrous potassium carbonate: if another aqueous layer forms, separate the upper organic layer and add more anhydrous potassium carbonate to it. Identify the neutral compound.

Notes.

Some neutral compounds (*e.g.*, methyl alcohol) cannot be salted out with potassium carbonate: distillation of the saturated aqueous potassium carbonate solution frequently yields the organic compound in a comparatively pure state, or at least in sufficiently concentrated a form to enable certain derivatives to be prepared.

The above procedure for the separation of a water-soluble mixture is summarised in Table XI,9,2.

TABLE XI,9,2. GENERAL SCHEME FOR SEPARATION OF A WATER-SOLUBLE MIXTURE

<p>Acidify the aqueous solution (50–75 ml.): prepared from (a) 6–10 g. of the solid mixture, (b) from 6–10 g. of the liquid residue (<i>R</i>) after distillation from a boiling water bath, or (c) from sufficient of original aqueous solution to contain 6–10 g. of solute) with 20% H_2SO_4 and distil.</p>				
<p>Distillate. This will contain the steam-volatile acidic and neutral components present. Render alkaline with 10–20% NaOH and distil.</p>		<p>Aqueous acid solution (R_1). Render alkaline with 10–20% NaOH and distil.</p>		
<p>Distillate (S_1). This will contain the volatile neutral components present. Concentrate by distillation and saturate with solid K_2CO_3; the neutral component may separate.</p>	<p>Aqueous alkaline solution. This will contain any acids or phenols present. Cool, acidify (litmus) with dilute H_2SO_4, and add excess of solid $NaHCO_3$. Extract with ether.</p>		<p>Distillate. Extract with ether.</p>	
	<p>Ether solution. Contains phenolic compounds</p>	<p>Sodium bicarbonate solution. Acidify with dilute H_2SO_4. Extract with ether.</p>		<p>Ether solution. Contains volatile water-insoluble amines.*</p>
		<p>Ether solution. Contains volatile water-insoluble acids.</p>		
		<p>Aqueous solution. Concentrate by distillation contains volatile water-soluble amines.*</p>	<p>Aqueous alkaline solution (S_2). Neutralise with dilute H_2SO_4 (Congo red). Evaporate to dryness and extract with absolute ethyl alcohol. The alcoholic extract contains the water-soluble, non-volatile components.</p>	

* The separation of a mixture of amines by means of benzenesulphonyl chloride or *p*-toluenesulphonyl chloride (Hinsberg's procedure) is described in Section IV,100,(viii).

CHAPTER XII

SEMIMICRO TECHNIQUE

XII.1. INTRODUCTION AND GENERAL CONSIDERATIONS

ORGANIC preparations in the laboratory are sometimes divided into three categories :—

(1) *Macro scale* : Usually from 1 g. to 200+ g. for solids and 5 g. to 200+ g. for liquids.

(2) *Semimicro scale* : From ca. 100 mg. to 1,000 mg. for solids and 1 g. to 5 g. for liquids.

(3) *Micro scale* : Below 100 mg. for solids and 1 g. for liquids.

It must be pointed out that the division is entirely arbitrary and the categories overlap; they are, however, useful for purposes of rough classification.

The proper training for the organic chemist must be based upon a correct interpretation and wide practice of the technique on the macro scale. A knowledge of, and experience in, semimicro technique is a valuable *supplement* to that training. It is the purpose of this Chapter to provide an outline of semimicro technique, which the student may utilise when the opportunity arises. Thus when only small quantities of organic material are available (as occurs frequently in qualitative organic analysis, in research problems or when dealing with very expensive compounds), their manipulation must of necessity be performed on a correspondingly small scale.

There are no serious difficulties in working with small quantities of solids (say, of the order of 100 mg.); full experimental details will be given in a later Section. For liquids special attention must be given to losses which may occur as a result of :—

- Surface effects (drainage from spherical vessels).
- Transference from one spherical vessel to another.
- Absorption by corks and retention by filter papers.

It must be appreciated that one drop, say, of 0.05 ml. weighs 50–75 mg., hence manipulation with quantities of less than 1 ml. presents new problems involving a specialised technique (micro technique), which will not be discussed here.

As a general rule, when working with semimicro quantities, it is best to employ pear-shaped vessels (Fig. XII, 1, 1, a) and centrifuge tubes (Fig. XII, 1, 1, b) as containers for liquids; convenient capacities are 5, 10 and 20 or 25 ml. for flasks, and 1, 3, and 5 ml. for centrifuge tubes. Round-bottomed vessels of similar volumes

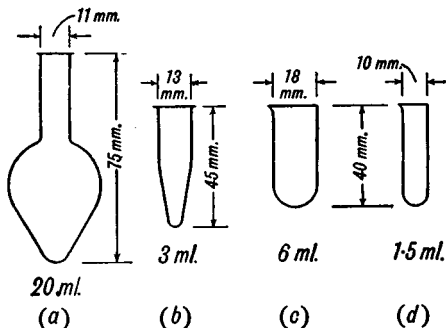

Fig. XII, 1, 1.

may be used, but the losses may be significant if the volume of liquid is less than about 5 ml. Small test-tubes with lips are shown in *c* and *d*.

A liquid may be transferred from one vessel to another with a dropper pipette (Fig. XII, 1, 2, *a* or *b*). If the dropper pipette is calibrated, it may be employed for measuring out a definite volume of liquid.

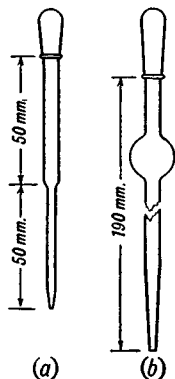

Fig. XII, 1, 2.

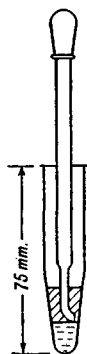

Fig. XII, 1, 3.

A cylindrical or, preferably, a pear-shaped separatory funnel (Fig. II, 1, 5, *e* and *d*) of 10–15 ml. capacity is usually employed for the separation of immiscible liquids. For separations on a smaller scale, a dropper pipette may be used; the upper layer is best removed with a “bent” pipette as in Fig. XII, 1, 3. For liquids which tend to emulsify, centrifugation (a hand centrifuge is satisfactory) will usually produce a clean line of demarcation between two immiscible liquids.

Single pieces of apparatus are used wherever possible in order to reduce to a minimum the absorption of liquids by corks.

As a general rule flasks and similar vessels should be heated in an air bath (compare Fig. II, 5, 3). A glycerol bath may be employed for temperatures up to 140°; the glycerol is subsequently removed from the outside of the vessel by washing with water. Medicinal liquid paraffin may be used for temperatures up to about 220°; “hard hydrogenated” cotton seed oil, “Silicone” fluids or fusible metal may be employed when higher temperatures are required. Small test-tubes and centrifuge tubes

may be heated by a semimicro Bunsen burner, but great care must be taken that the liquid does not “bump”; it is preferable to heat these small open vessels in a water (or other liquid) bath.

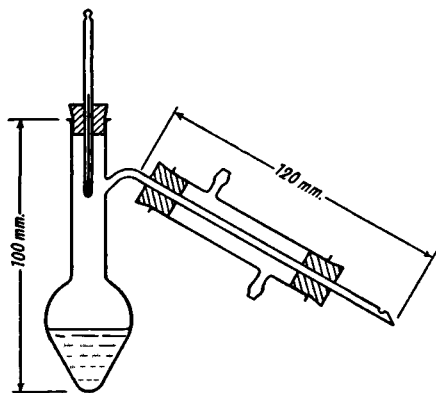

Fig. XII, 2, 1.

XII.2. SOME TYPICAL OPERATIONS ON THE SEMIMICRO SCALE

1. Distillation at atmospheric pressure.—A simple apparatus is shown in Fig. XII, 2, 1; the pear-shaped distilling flask with long side

arm is employed for liquids of b.p. above 140° . For liquids of lower b.p., the side arm is surrounded for a large proportion of its length by a glass jacket held in position by rubber stoppers. The distillate is collected in a centrifuge tube or other small vessel (test-tube, conical flask, etc.). In

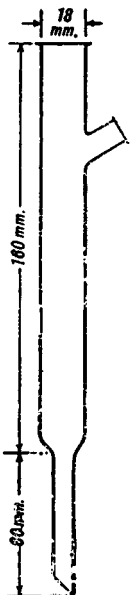

Fig. XII, 2, 2.

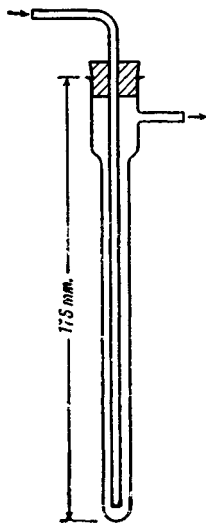

Fig. XII, 2, 3.

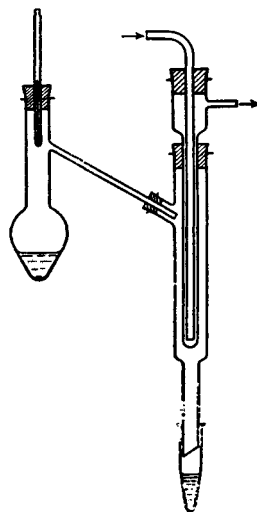

Fig. XII, 2, 4.

an alternative set-up, a "distillation tube" (Fig. XII, 2, 2) and a "cold finger" condenser (Fig. XII, 2, 3; this may be constructed entirely of glass, if desired) are assembled as shown in Fig. XII, 2, 4. All thermometers employed in small-scale work must have very small bulbs.

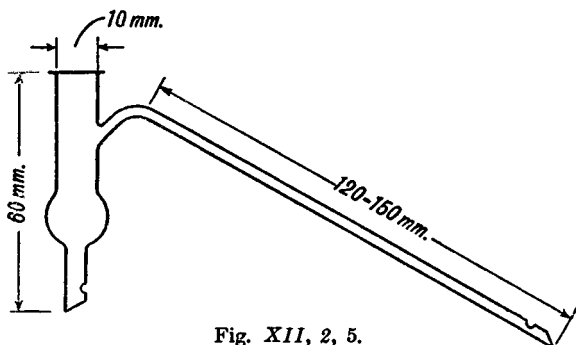

Fig. XII, 2, 5.

It is sometimes necessary to remove the products of a reaction in a flask (Fig. XII, 1, 1, a) by distillation. The still head depicted in Fig. XII, 2, 5 may be used for this purpose; the side arm may be fitted with a water condenser, if required.

The simple spring clamps shown in Fig. XII, 2, 6 are recommended for the rapid assembly and dismantling of semimicro apparatus. These clamps have hardwood stems about 15 cm. long, which are slotted and

can accommodate "Terry clips" of suitable sizes; they may be used in conjunction with ordinary stands and bossheads.

2. **Distillation under diminished pressure.**—A simple apparatus is illustrated in Fig. XII, 2, 7. The Claisen flask with pear-shaped bulb is

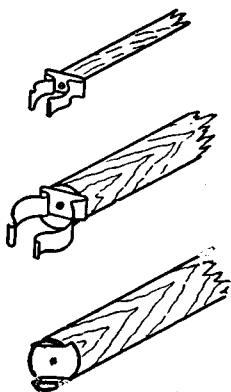

Fig. XII, 2, 6.

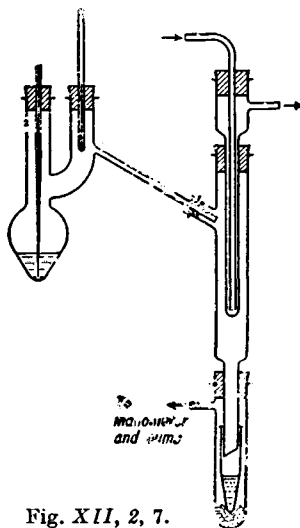

Fig. XII, 2, 7.

attached to a "distillation tube" and a "cold finger" condenser. The receiver consists of a centrifuge tube or test-tube supported inside a large test-tube to which a side arm is fused.

Alternatively, the apparatus shown in Fig. II, 19, 1 with obvious modifications (small flask with pear-shaped bulb, etc.) may be used. The set-up

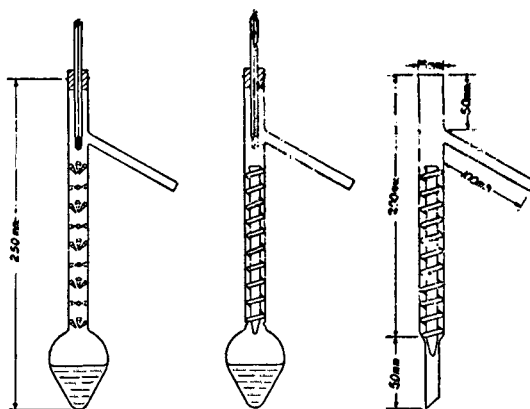

Fig. XII, 2, 8.

of Fig. II, 20, 1, utilising, say, a 10 or 20 ml. Claisen flask with pear-shaped bulb, a Perkin triangle (capacity of bulb *ca.* 10 ml.) and a small test-tube receiver, is recommended; it may be employed for fractional distillation under reduced pressure.

3. **Fractional distillation at atmospheric pressure.**—The flask may have the fractionating column attached (compare Figs. II, 24, 4-5): the latter may be:—

- (i) of the Vigreux type (Fig. XII, 2, 8, a) ;
- (ii) of the Widmer type (Fig. XII, 2, 8, b)—a central glass rod or sealed tube is wound with copper or nichrome wire (16 gauge : about 24 turns) or with glass yarn ; or
- (iii) it may be filled with hollow glass rings ($\frac{1}{8}$ " diameter) or, preferably, with single turn glass helices or with Dixon gauze rings (see Section II, 17).

Alternatively, an independent column (Fig. XII, 2, 8, c) may be inserted into a flask; the column may be of the Vigreux, Widmer or Hempel form. The fractionating column should be lagged with asbestos cloth or string for distillation temperatures above 100° : for the best results the column should be heated electrically (compare Section II, 15) to a temperature $5-10^{\circ}$ below the b.p. of the fraction being collected. The side arm of the flask or fractionating column may be attached to a "cold spot" condenser and receiver as in Fig. XII, 2, 4 or to a Liebig's condenser and receiver as in Fig. XII, 2, 1.

4. Fractional distillation under diminished pressure.—A 5-25 ml. Claisen flask (with pear-shaped bulb) provided with a fractionating side arm (Fig. II, 24, 4-5) and attached to a Liebig's condenser and a Perkin triangle (Fig. II, 20, 1 or II, 20, 2 ; volume of receiver ca. 10 ml.) will be found to have wide application.

5. Heating under reflux.—A water condenser of total length 25 cm. (cooling jacket 15 cm.) may be used. If the upper end is provided with a long side arm as in Fig. XII, 2, 9, refluxing may be followed by distillation without transferring the contents of the flask : it may be necessary to surround part of the side arm with a short water condenser (compare

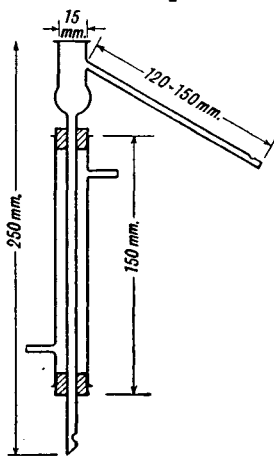

Fig. XII, 2, 9.

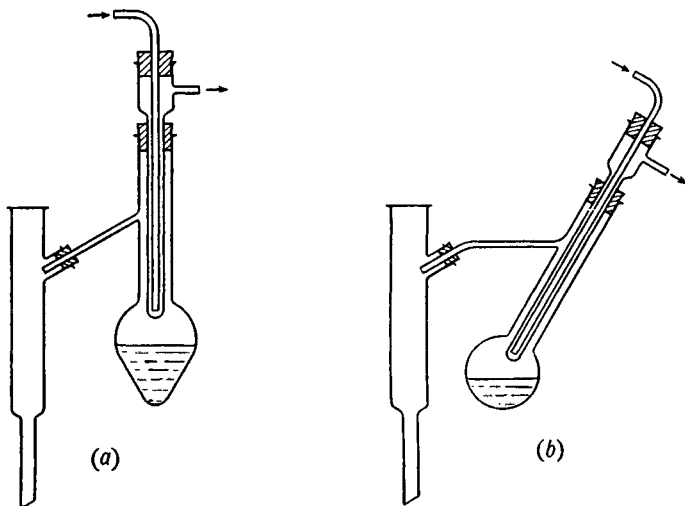

Fig. XII, 2, 10.

Fig. XII, 2, 1). For very small volumes of liquid either of the apparatus depicted in Fig. XII, 2, 10, incorporating a "cold finger" condenser may be employed; subsequent distillation (or steam distillation) is a facile operation as it merely involves moving the condenser as in Fig. XII, 2, 4 and Fig. XII, 2, 11. (Some of the Figures are not strictly to scale; this is in order to assist clarity of representation.)

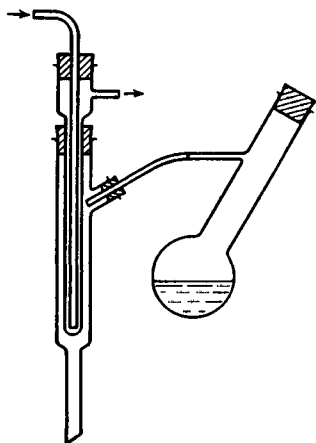

Fig. XII, 2, 1.

6. Steam distillation.—For small quantities of compounds, which are readily volatile in steam, water may be added to the contents of the reaction flask (*e.g.* Figs. XII, 2, 4 and XII, 2, 11) and the flask heated in an air bath or with a small flame. Alternatively, if preferred, steam may be passed into the reaction flask from a separate generator: this may consist of a small conical flask provided with the usual safety tube (compare Fig. II, 40, 1).

A compact apparatus is depicted in Fig. XII, 2, 12. It is designed to be fitted into a standard 100 ml. Pyrex Kjeldahl flask: if desired, the dimensions may be reduced proportionately for use with a 50 ml. flask. A screw clip is attached by rubber tubing to the side arm E; the latter may be replaced by a thin glass tube (3–4 mm. external diameter) inserted through the upper cork, thus permitting the use of a Kjeldahl flask without modification. The liquid to be steam distilled is placed in the tube A and water in the outer vessel B. Upon heating the latter, steam passes through the inlet tube C and steam-volatile compounds pass out through D; a condenser is attached at D and the steam distillate is collected in a suitable receiver. The functions of the bulb in the inlet tube C are to reduce the danger of spurting and also the "sucking back" of the liquid in A; the latter can be prevented by the timely opening of the screw clip on E.

7. Recrystallisation and filtration.—Recrystallisation is carried out in apparatus of conventional type but reduced in size. Operations involving hot inflammable solvents should preferably be performed under reflux: when semimicro test-tubes (75 × 10 mm. or 100 × 12 mm.) or centrifuge tubes (1–5 ml.) are employed, they must be heated in a water bath and not directly by a semimicro burner. The crystals, which separate on cooling, are removed by filtration using a small Hirsch funnel (*i.e.*, a conical, porcelain Buchner funnel) or a small Pyrex funnel with sintered glass filtration plate; it is often advantageous to place a small filter paper upon the sintered glass

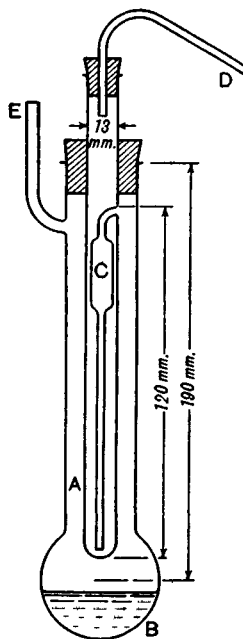

Fig. XII, 2, 12.

plate since complete removal of the crystals is thereby facilitated. The filtration assembly is shown in Fig. XII, 2, 13. It includes a boiling tube (150 × 25 mm.) having a side arm for attachment to the pump; the filtrate is collected in a centrifuge tube or in a semimicro test-tube resting upon a pad of cotton wool.

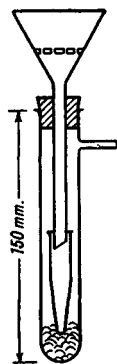

Fig. XII,
2, 13.

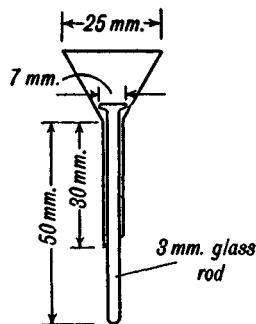

Fig. XII, 2, 14.

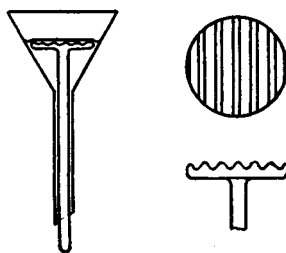

Fig. XII, 2, 15.

An apparatus for the filtration of small to moderate quantities of crystals incorporates the so-called Willstätter "filtration nail." The latter consists of a thin glass rod flattened at one end. It is readily constructed by heating the end of a short glass rod in the blowpipe flame and pressing vertically upon an asbestos board. The "nail" is fitted into small glass funnel; it is covered by a circle of a filter paper cut with the aid of a cork borer of appropriate size. A "filtration nail" and funnel, capable of handling up to 1 g. of solid is depicted in Fig. XII, 2, 14. It is convenient to make several "nails" of different size head for a single funnel so that a filter paper of diameter appropriate to the amount of solid to be collected may be employed. For the larger sizes of "nail," accommodating filter papers of 15-25 mm. diameter, it is advisable to corrugate the head of the "nail," as shown (somewhat exaggerated) in Fig. XII, 2, 15, in order to permit drainage of filtrate over the entire area of the paper: these corrugations are easily produced by pressing the hot glass on the surface of an old single-cut file of coarse grade. The method of use of the glass filtration "nail" is similar to that for the conical Buchner funnel (Fig. XII, 2, 13). By employing a slightly modified funnel, the glass "nail" can be utilised, in conjunction with a drying tube packed with desiccant, for drying the product by suction; this assembly is illustrated in Fig. XII, 2, 16.



Fig. XII,
2, 16.

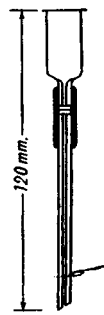

Fig. XII,
2, 17.

The Schwinger filter, shown in Fig. XII, 2, 17, finds application when dealing with very small quantities of crystals. The solid collects as a pellet above the small filter paper disc at the throat of the filter: after dismantling, the pellet may be expelled by a snugly fitting glass rod.

A Pyrex micro filter (Fig. *XII*, 2, 18) of 8 ml. capacity and furnished with a sintered glass disc is useful for the filtration of hot or boiling liquids. The long cylindrical tube reduces evaporation. The filter may be inserted into a test-tube with side arm (Fig. *XII*, 2, 13) and the filtrate collected in a centrifuge tube or semimicro test-tube receiver.

8. Stirring.—It is frequently necessary to stir organic reaction mixtures for comparatively long periods. Magnetic stirrers (see Fig. *II*, 7, 15) are useful for this purpose provided the viscosity of the reaction mixture is not too high. Inexpensive magnetic stirrers, suitable for semimicro vessels, are available commercially, as are also combined hot plate and magnetic stirring apparatus.

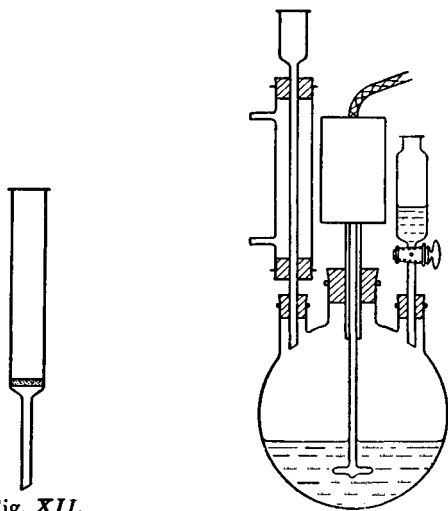

Fig. *XII*,
2, 18.

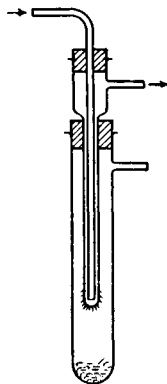

Fig. *XII*, 2, 20.

When the curvature of the reaction vessel is too great for the efficient operation of the bar-type magnetic stirrer, a miniature solenoid-operated reciprocating stirrer may be employed (Fig. *XII*, 2, 19). This stirrer may be easily constructed from a telephone relay or electric bell. It is advisable to have a control for adjusting the stroke while running.

In those cases where stirring for short periods is necessary, this may usually be accomplished by gentle rotation of the vessel thus imparting a swirling motion to its contents. If the vessel cannot conveniently be moved, a hand-operated stirrer constructed entirely of glass (compare Fig. *II*, 10, 4 and Fig. *II*, 10, 2) will be found satisfactory provided the glass loop is not too large.

9. Sublimation.—This is a valuable means for the purification of many organic substances and is admirably adapted for small-scale work since losses are generally small. Sublimation may be carried out either at atmospheric pressure or under reduced pressure. The apparatus shown in Fig. *XII*, 2, 20 is simple and effective: the sublimate is collected on the "cold finger" condenser.

XII.3. SEMIMICRO APPARATUS WITH INTERCHANGEABLE GROUND GLASS JOINTS

Small scale apparatus with interchangeable ground glass joints (compare Section II,56) are available commercially.* One set of apparatus (*A) is based largely upon B10 and B14 joints, although occasionally a larger size joint is used as in the steam distillation apparatus shown in Fig. XII, 3, 1.

Another set of apparatus (*B) adopts the § 19 joint as standard (apart from § 7/12 for thermometers) but connexions to condensers, etc., incorporate internal glass seals. A typical assembly for distillation is depicted in Fig. XII, 3, 2.

In a third set of commercial apparatus (*C and D), the § 14/20 joint is standard. In the basic assembly, shown in Fig. XII, 3, 3, the flask (50 or 100 ml.) is equipped

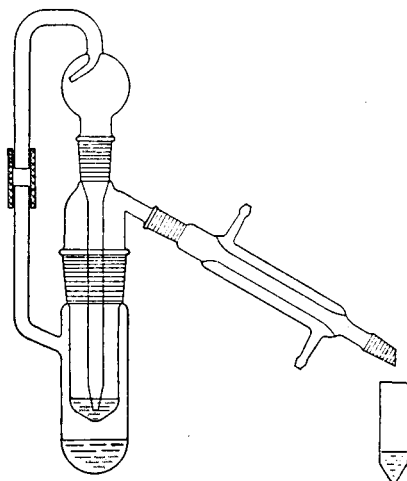

Fig. XII, 3, 1.

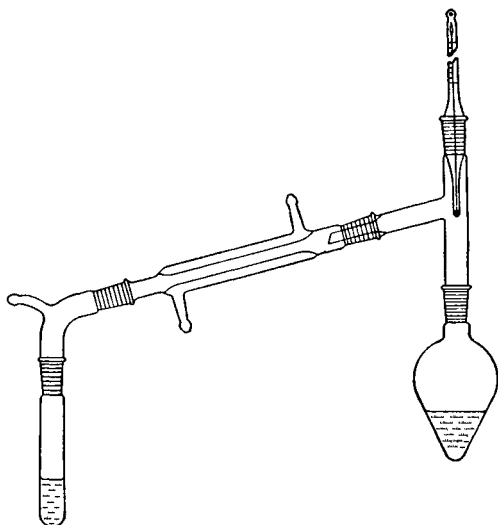

Fig. XII, 3, 2.

with a spherical 65/40 or a § 45/50 joint; the head is fabricated with three outer § 14/20 joints surrounding the centre opening, which is § 19/38; the central neck usually carries a precision ground stirrer. The flask may be heated by an electric heating mantle.

A semimicro assembly, suitable for precision fractionation, used in the author's laboratory is illustrated in Fig. XII, 3, 4; the mode of heating the fractionating column is not shown for reasons of clarity (compare Fig. II, 17, 2).

* For example, from :—

- A. Quickfit and Quartz Ltd., Heart of Stone, Staffs., England.
- B. Metro Industries, 29-28 41st Avenue, Long Island City 1, New York.
- C. Ace Glass Incorporated, Vineland, New Jersey.
- D. Scientific Glass Apparatus Co. Inc., Bloomfield, New Jersey.

The catalogues of these manufacturers contain full details of assemblies and individual items.

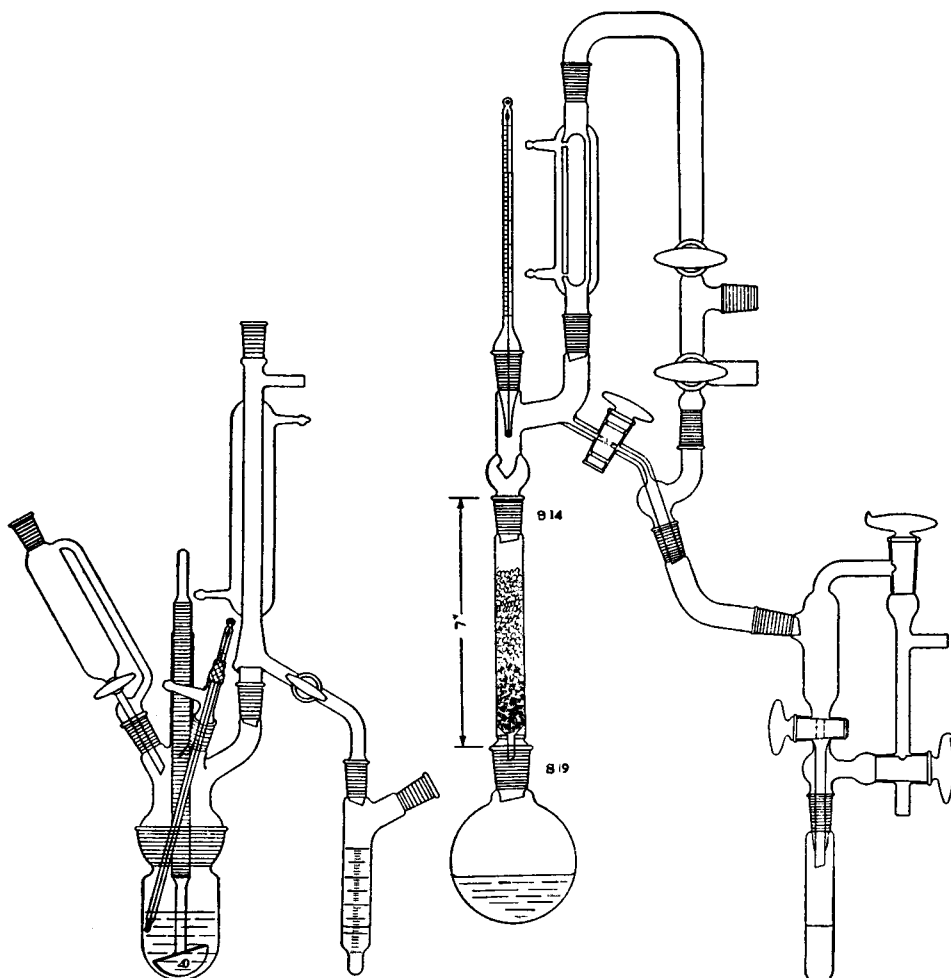

Fig. XII, 3, 3.

Fig. XII, 3, 4.

XII.4. SMALL-SCALE PREPARATIONS*

Experienced students may carry out some typical preparations described in the text, but on a considerably reduced scale and employing the modifications described in Section XII,2 wherever these seem suitable.

Beginners may also undertake small-scale preparations on a slightly larger scale than can be strictly classified as semimicro: the resulting saving in time, chemicals and in bench and fume cupboard space are such as to commend the reduced scale of working to all. Some advantages of small scale working may be amplified further:—

(i) Saving of time in setting up apparatus, in periods of refluxing, in filtration and washing of solids, and in recrystallisation of solids.

* This subject is dealt with *ab initio* in the author's book entitled *Elementary Practical Organic Chemistry*. Part I. *Small Scale Preparations*. (Longmans, Green and Co. Ltd., 1957.) The treatment is comprehensive and includes a detailed account of small scale apparatus of novel design.

- (ii) Economy in bench and fume cupboard space.
- (iii) Economy in initial cost of apparatus and of chemicals.
- (iv) Reduced cost of breakages.
- (v) Reduced hazard in handling dangerous chemicals, such as bromine.
- (vi) The small-scale preparation of organic compounds provides invaluable experience for subsequent training in qualitative organic analysis.

Much can be done with such standard apparatus in borosilicate glass as :—

Round-bottomed flasks ; 5 ml., 10 ml. and 25 ml.

Pear-shaped flasks ("boiling flasks, conical form"); 5 ml., 10 ml. and 25 ml.

Distilling flasks ; 10 ml., 25 ml. and 50 ml.

Claisen flasks ; 25 ml. and 50 ml.

Liebig's condenser (16 cm. jacket held in position by rubber stoppers, inner jacket 7 mm. in diameter; *or* condenser, 20 cm. body with inner tube fused to outer tube).

Separatory funnels ; 10 ml. and 25 ml.

Conical flasks ; 5 ml., 10 ml. and 25 ml.

Funnels for above conical flasks.

Buchner funnel ; 2 cm.

Semimicro test-tubes ; 75 × 10 mm. or 100 × 12 mm.

Filter tubes ; 55 × 7 mm. or 100 × 12 mm.

Semimicro boiling tubes ; 60 × 25 mm.

Conical centrifuge tubes ; 1 ml., 2 ml., 3 ml., and 5 ml.

Although the yields with the above simple apparatus may not be quite so high as can be obtained with the purely semimicro apparatus described in Sections XII,1 and XII,2, the numerous advantages attending the purchase of standard (and therefore comparatively inexpensive) apparatus usually outweigh the small reduction in yield.

The following list of experiments is suggested as the basis of an elementary course :

1. Determination of melting points (α -naphthylamine, α -naphthol, benzoic acid, succinic acid and *p*-nitrobenzoic acid). Use the apparatus shown in Fig. II, 10, 2, a. Construction of calibration curve for thermometer. Determination of m.p. of "unknown" compound.

2. Determination of boiling points. Distillation method (Fig. II, 12, 1) for carbon tetrachloride (25 ml. distillation flask and small water condenser), and Siwoloboff's method (Fig. II, 12, 2) for carbon tetrachloride, aniline and nitrobenzene. Calibration curve for thermometer. Determination of b.p. of "unknown" liquid.

3. Purification of solid by recrystallisation : acetanilide from water ; naphthalene from methylated spirit (III,5). Use 1 g. of solid, 25 ml. flask and short water condenser.

4. *n*-Butyl acetate (III,95, $\frac{1}{16}$ scale ; use 25 ml. round-bottomed flask, water condenser ; reflux for 30 minutes).

5. *tert*-Butyl chloride (III,33, $\frac{1}{16}$ scale ; if 0.5–1 g. of anhydrous zinc chloride is dissolved in the concentrated HCl, the *tert*-butyl chloride forms almost immediately).

6. *n*-Butyl bromide (III,36, $\frac{1}{2}$ scale ; use 50 ml. conical flask ; reflux 30–45 minutes).
7. *n*-Butyl iodide (III,40, $\frac{1}{10}$ scale).

If a small-scale special apparatus is not available, proceed as follows : Place 1.5 g. (1.9 ml.) of *n*-butyl alcohol and 0.28 g. of purified red phosphorus in a 25 ml. round-bottomed flask, and add 2.5 g. of iodine in 2 portions. Allow to stand for 2–3 minutes, heat on a boiling water bath under reflux for 30 minutes, add 5 ml. of water and distil. Separate the lower layer of the distillate. Work up the product as described in III,40.

8. Di-*n*-butyl ether (III,57, $\frac{1}{2}$ scale ; use 100 ml. Pyrex bolt-head flask).
9. Chloroform (III,43 ; $\frac{1}{10}$ scale ; use 250 ml. round-bottomed flask).
10. Iodoform (III,45, $\frac{1}{2}$ scale ; use 50 ml. conical flask ; recrystallise product in 25 ml. flask with short water condenser).
11. Acetyl chloride (III,86, $\frac{1}{2}$ scale ; use 25 ml. distilling flask ; PCl_3 may be added all at once and mixture then heated for 15 minutes at 40–50°).
12. Acetic anhydride (III,89, $\frac{1}{2}$ scale ; use 25 ml. distilling flask).
13. Reactions of acetic anhydride (III,94, $\frac{1}{2}$ scale).
14. Acetamide (III,108, $\frac{1}{2}$ scale ; use a 50 ml. distilling flask for the initial reaction).
15. Acetonitrile (III,111, $\frac{1}{2}$ scale ; use a 50 ml. distilling flask for the initial reaction).
16. Reactions of aldehydes (III,70, (i), (ii), (iii) and (vi), and 1 in III,74 on $\frac{1}{2}$ scale ; use *n*-butyraldehyde).
17. Reactions of ketones {use acetone ; reactions (i), (ii), (iii) and (vi) as for aldehydes ; *cyclohexanone oxime* ($\frac{1}{2}$ scale), *cyclohexanone phenylhydrazone*, and *acetone semicarbazone* ($\frac{1}{4}$ scale) as in III,74}.
18. Hydrolysis of esters (III,106) ; *n*-butyl acetate.
19. Nitrobenzene (IV,10, $\frac{1}{2}$ scale ; use a 100 ml. flask ; heat at 60° for 20 minutes).
20. Aniline (IV,34, *Method A*, $\frac{1}{2}$ scale).

The following additional experimental details may be regarded as illustrative of a typical small-scale preparation. Place 5.0 g. (4.2 ml.) of nitrobenzene and 9 g. of granulated tin in a 100 ml. bolt-head or round-bottomed flask fitted with a short reflux water condenser. Add 10 ml. of concentrated HCl down the condenser and shake the contents of the flask steadily ; cool in a beaker of cold water if the reaction becomes unduly vigorous. When the reaction slackens, add a further 10 ml. of concentrated HCl and shake the flask to ensure good mixing. Heat on a boiling water bath for 30 minutes. Cool the flask and add gradually, with shaking, a solution of 15 g. of NaOH in 25 ml. of water ; the initial precipitate should dissolve almost completely. Add 20 ml. of water. Fit the flask with a wide bent tube ("knee" tube) and water condenser (Fig. II, 13, 3 but with thermometer omitted), add a few small fragments of broken porcelain, heat over a wire gauze and collect the distillate in a small flask. The aniline passes over with the steam and the distillate suddenly becomes clear after about 25 ml. have been collected ; collect a further 15 ml. of distillate.

Saturate the distillate with sodium chloride (*ca.* 8 g.) and extract four times with 5 ml. portions of ether. Dry the combined ethereal extracts with a little anhydrous potassium carbonate or a few pellets of potassium hydroxide. Remove the ether (Fig. II, 13, 4), using a 20–25 ml. distilling flask. When all

the ether has distilled over, run the water out of the condenser, and distil the residue ether by direct heating over a wire gauze or, better, with the aid of an air bath. The yield of aniline, b.p. 180–184°, is 3·0 g.

21. *m*-Dinitrobenzene (IV,12, $\frac{1}{8}$ scale; use a 50 or 100 ml. round-bottomed flask; a water condenser is not essential; heat on a boiling water bath for 10–15 minutes after all the nitrobenzene has been added).

22. *m*-Nitroaniline (IV,44, $\frac{1}{10}$ scale; use a 100 ml. conical flask; add the sodium polysulphide solution from a test-tube during 5 minutes; shaking and swirling the contents of the flask by hand may replace mechanical stirring; boil gently for 5 minutes and maintain the original volume by the addition of water, if necessary).

23. Acetanilide (IV,45, *Method 2*, $\frac{1}{8}$ scale; boil reaction mixture for 15 minutes). Use product for preparations 24 and 25.

24. *p*-Bromoacetanilide (IV,48, $\frac{1}{10}$ scale; allow reaction mixture to stand for 10 minutes).

25. *p*-Nitroacetanilide (IV,50, $\frac{1}{10}$ scale; allow reaction mixture to stand at room temperature for 10 minutes instead of 1 hour, then for 5 minutes after addition of crushed ice).

26. *p*-Nitroaniline (IV,51, $\frac{1}{10}$ scale; heat mixture in test-tube or small conical flask for 5 minutes).

27. *o*- and *p*-Nitrophenols (IV,108, $\frac{1}{10}$ scale; add phenol solution to acid mixture in 100 ml. conical flask during 5 minutes, keeping thoroughly mixed by swirling contents of flask; do not permit temperature to rise above 20–30°; allow to stand for 2 hours with frequent shaking during first hour when temperature may rise to, but must not be permitted to exceed, 50–55°; it is best to allow to stand overnight).

28. Bromobenzene and *p*-dibromobenzene (IV,18, $\frac{1}{10}$ scale; when reaction slackens, heat on a water bath at 65–70° for 30 minutes).

29. Chlorobenzene (IV,61, $\frac{1}{10}$ scale).

30. *p*-Tolunitrile and *p*-toluic acid (IV,66, $\frac{1}{8}$ scale; convert all *p*-tolunitrile into acid).

31. Diazoaminobenzene (IV,81, $\frac{1}{10}$ scale; reduce periods of standing to one third).

32. *p*-Amino-azobenzene (IV,82, $\frac{1}{8}$ scale; heat at 40–45° for 30 minutes; allow to stand for 5 minute periods in lieu of 15 minutes).

33. Benzyl alcohol and benzoic acid (IV,123); $\frac{1}{8}$ scale.

34. Benzoin (IV,125); $\frac{1}{10}$ scale.

35. Benzil (IV,126); $\frac{1}{10}$ or $\frac{1}{8}$ scale.

36. Cinnamic acid (IV,124); $\frac{1}{8}$ scale.

Alternatively, use the following procedure in which triethylamine replaces potassium acetate as the basic catalyst. Place 2·1 g. (2·0 ml.) of purified benzaldehyde, 2·0 ml. of anhydrous triethylamine and 5·0 ml. of A.R. acetic anhydride in a 200 ml. round-bottomed flask, equipped with a short reflux condenser and a calcium chloride drying tube. Boil the solution gently for 24 hours—heating may be interrupted. Incorporate a steam distillation apparatus in the flask and steam distil until the distillate is no longer cloudy (about 100 ml.) and then collect a further 50 ml. of the distillate; discard the steam distillate. Transfer the residue in the flask to a 400 ml. beaker, add water until the volume is about 200 ml., then 0·2 g. of decolourising carbon, and boil for a few minutes. Filter the hot solution, and acidify the hot filtrate with 1 : 1-hydrochloric acid

to Congo red paper. Cool and filter. Recrystallise the crude cinnamic acid from hot water. The yield of pure acid, m.p. 133° , is 1.5 g.

37. Sulphanilic acid (IV,55, $\frac{1}{10}$ scale; heat reaction mixture in oil bath at $180-190^{\circ}$ for 30 minutes).

38. Methyl orange (IV,78; $\frac{1}{10}$ or $\frac{1}{5}$ scale).

39. Triphenylcarbinol (IV,202, procedure for elementary students, $\frac{1}{10}$ or $\frac{1}{5}$ scale).

APPENDIX

LITERATURE OF ORGANIC CHEMISTRY

A.1. BEILSTEIN'S "HANDBUCH"

THE fourth edition of Beilstein's *Handbuch der organischen Chemie* originally issued by the Deutsche Chemische Gesellschaft* is the largest compilation of information upon organic chemistry. The main series (Hauptwerk) is composed of 27 volumes and covers the literature to January 1, 1910. The first supplement (Erstes Ergänzungswerk), 27 volumes, surveys the literature to 1919. Thus far (1955) some 26 volumes of the second supplement (Zweites Ergänzungswerk), covering the decade to 1929, have been published. In addition there is a comprehensive subject index (Volume XXVIII, Parts I and II) and a formula index (Volume XXIX, Parts I and II) for the main series and first supplement and also for the second supplement: all organic compounds described to 1929 are listed with references to the appropriate volumes of Beilstein.

The system of classification adopted is based upon the premise that every definite compound can be expressed by a structural formula. This leads to the four divisions tabulated below. Furthermore, the position of each definite organic compound in the appropriate division is determined by its stem nucleus, which is obtained by replacing in the formula of the compound all atoms or groups attached to carbon by the equivalent number of hydrogen atoms except where such replacement would involve the breaking of a cyclic chain. Moreover, whenever a given formula gives rise to stem nuclei of more than one division, the compound will be found in the same main division as the one of its component stem nuclei which comes last in the systematic arrangement: this is sometimes spoken of the "principle of latest position in the system." No cyclic chain of atoms may be broken during the formulation of the stem nucleus: this principle leads to the inclusion of compounds such as the anhydrides and imides of dibasic acids, sulphimides, lactides and lactones of hydroxy-acids, etc. under heterocyclic compounds.

The four main divisions, with examples of stem nuclei, are tabulated below.

Division I. Acyclic compounds (*Acyclic stem nuclei*). The carbon atoms are joined in open chains only.

COMPOUND	STEM NUCLEUS
$\text{CH}_3\text{CHClCOOH}$	$\text{CH}_2\text{CH}_2\text{CH}_2$
$\text{CH}_3\text{CH}_2\text{OCH}_3$	CH_3CH_3 and CH_4
$\text{CH}_3\text{CH}_2\text{OSO}_2\text{OH}$	CH_3CH_3
$\text{CH}_3\text{CH}_2\text{CH}_2\text{N}_3$	$\text{CH}_3\text{CH}_2\text{CH}_3$

Division II. Acyclic compounds (*Isocyclic stem nuclei*). The carbon

* Julius Springer, Berlin.

Division IV. Natural products. These may be compounds of unknown or partially known structure at 1.1.1910 or 1.1.1920 and have not been assigned places in the previous divisions.

Some amplification of the classification of heterocyclic compounds may now be given. The two important hetero atoms are oxygen and nitrogen: in the former class are included S, Se and Te and in the latter class P, As, etc. The sub-division (hetero-classes) of Division III is as follows:

- Compounds with one cyclically bound oxygen atom.
- Compounds with two cyclically bound oxygen atoms.
- Compounds with three cyclically bound oxygen atoms, etc.
- Compounds with one cyclically bound nitrogen atom.
- Compounds with two cyclically bound nitrogen atoms.
- Compounds with three cyclically bound nitrogen atoms, etc.
- Compounds with one cyclic nitrogen and one cyclic oxygen atom.
- Compounds with one cyclic nitrogen and two cyclic oxygen atoms.
- Compounds with one cyclic nitrogen and three cyclic oxygen atoms, etc.
- Compounds with two cyclic nitrogen and one cyclic oxygen atom.
- Compounds with two cyclic nitrogen and two cyclic oxygen atoms.
- Compounds with two cyclic nitrogen and three cyclic oxygen atoms, etc.

The acyclic division, the isocyclic division and all hetero-classes are further divided into 28 main classes, the first of which consists of the stem nuclei (*i.e.*, hydrocarbons in the acyclic and isocyclic divisions), whilst the others depend upon the functional group present. The most important main classes and functional groups are collected below.

CLASS	CHARACTERISING GROUPS
1. Stem nuclei	—
2. Hydroxy compounds	—OH
3. Carbonyl compounds	—CHO or $>C=O$
4. Carboxylic acids	—COOH
5. Sulphinic acids	—SO ₂ H
6. Sulphonic acids	—SO ₃ H
7. Selenious and selenic acids	—SeO ₂ H, —SeO ₃ H
8. Amines	—NH ₂
9. Hydroxylamines	—NHOH
10. Hydrazines	—NHNH ₂
11. Azo compounds	—N=NH
12-22. Other nitrogen derivatives	
23-28. Compounds in which C is united directly to a metallic element (organo-metallic compounds). The order is according to Periodic Groups 5, 4, 3, 2, 1, 6, 7 and 8. Thus Class 23 consists of compounds in which C is attached to P, As, Sb or Bi.	

Space does not permit the inclusion of a further discussion of the detailed sub-divisions adopted in the Handbuch,* and it may be noted

* The reader is referred to the following for a more comprehensive account:

- (1) Beilstein's *Handbuch*, Main Series, Volume I, pp. 1-46 (1918).
- (2) Prager, Stern and Ilberg, *System der organischen Verbindungen*, 246 pp. (1929). This volume lists the 4877 "system numbers" and includes the common names with appropriate references to "system numbers" (Julius Springer: Edwards Brothers).
- (3) Huntress, *A Brief Introduction to the Use of Beilstein's Handbuch der organischen Chemie*, 44 pp. (1938) (J. Wiley).
- (4) Richter and Ilberg, *Kurze Anleitung zur Orientierung in Beilsteins Handbuch der organischen Chemie*, 23 pp. (1936) (Julius Springer).
- (5) Soule, *Library Guide for the Chemist*, pp. 127-153 (1938) (McGraw-Hill).
- (6) Dyson, *A Short Guide to Chemical Literature*, pp. 68-74 (1951) (Longmans, Green)

that in order to facilitate cross references within the various parts of the classification, the entire subject matter has been divided into 4877 arbitrary units called "system numbers." The general scope of the work will be evident from Table A,1, in which is included the page numbers of selected key compounds in the Hauptwerk (Main Series).

TABLE A.1. MODIFIED KEY TO BEILSTEIN'S HANDBUCH
DER ORGANISCHEN CHEMIE, 4TH EDITION

VOLUME	YEAR OF PUBLICATION	"SYSTEM NUMBERS"	BRIEF LIST OF CONTENTS
ACYCLIC DIVISION			
I	1918	1-151	<i>Hydrocarbons.</i>
I, 1st Supplement	1928	1-151	Methane, 56. Ethane, 80. Ethylene, 180. Acetylene, 228.
I, 2nd Supplement	1941	1-151	<i>Hydroxy Compounds: Alcohols and Derivatives.</i> Methyl alcohol, 273. Ethyl alcohol, 292. Ethyl ether, 314. Glycerol, 502. <i>Carbonyl Compounds: Aldehydes, Ketones, Ketenes and Derivatives.</i> Formaldehyde, 558. Acetaldehyde, 635. Acetone, 635. Ketene, 724. <i>Hydroxy-Carbonyl Compounds: Aldehyde-Alcohols, Ketone-Alcohols, Monosaccharides and Derivatives.</i> Glycolaldehyde, 817. Aldol, 824. Pentoses, 858. Hexoses, 878.
II	1920	152-194	<i>Carboxylic Acids: Salts and Derivatives.</i>
II, 1st Supplement	1929	152-194	Formic acid, 8. Acetic acid, 96.
II, 2nd Supplement	1942	152-194	Oxalic acid, 502. Succinic acid, 601. Fumaric acid, 737
III	1921	195-322	<i>Carboxylic Acids: Polyfunctional and Derivatives.</i>
III, 1st Supplement (combined with Volume IV)	1929	195-449	<i>Hydroxy-carboxylic acids:</i> Carbonic acid, 3. Glycollic acid, 228. Lactic acid, 261. Tartaric acid, 481. Citric acid, 566. Urea, 42. Cyanamide, 74. Thiocyanic acid, 140.
III, 2nd Supplement (combined with Volume IV)	1942	195-449	<i>Carbonyl-carboxylic acids:</i> Glyoxalic acid, 594. Acetoacetic acid, 630. <i>Hydroxy-carbonyl carboxylic acids:</i> Glycuronic acid, 883.
IV	1922	323-449	<i>Sulphonic Acids.</i>
IV, 1st Supplement	1929	195-449	Hydroxy, 13. Carbonyl, 21.
IV, 2nd Supplement	1942	195-449	<i>Amines.</i> Methylamine. <i>Hydroxy-amines:</i> Aminoethyl alcohol, 274. <i>Carbonyl-amines:</i> Aminoacetaldehyde, 307. Aminoacetone, 314. <i>Hydroxy-carbonyl amines:</i> Glucosamine, 328. <i>Aminocarboxylic acids:</i> Glycine, 333. <i>Hydroxylamines,</i> 534. <i>Hydrazines,</i> 546. <i>Azo Compounds,</i> 562. <i>Organo-metallic Compounds,</i> 580.

TABLE A.1. MODIFIED KEY TO BEILSTEIN'S HANDBUCH
DER ORGANISCHEN CHEMIE, 4TH EDITION (*continued*)

VOLUME	YEAR OF PUBLICATION	"SYSTEM NUMBERS"	BRIEF LIST OF CONTENTS
ISOCYCLIC DIVISION			
V	1922	450-498	<i>Hydrocarbons.</i> <i>cyclo</i> Propane, 15. Benzene, 179. Toluene, 280. Xylene, 362. Naphthalene, 531. Diphenyl, 576. Anthracene, 657. Triphenylmethane, 698.
V, 1st Supplement	1930	450-498	
V, 2nd Supplement	1943	450-498	
VI	1923	499-608	<i>Hydroxy Compounds.</i> Phenols, Aromatic Alcohols, Phenol-Alcohols: Menthol, 28. Phenol, 110. Cresol, 349. Benzyl alcohol, 428. Naphthol, 596. Resorcinol, 796. Pyrogallol, 1071.
VI, 1st Supplement	1931	499-608	
VI, 2nd Supplement	1946	499-608	
VII	1925	609-736	<i>Carbonyl Compounds.</i> Aldehydes, Ketones, Ketenes, Quinones: Camphor, 101. Benzaldehyde, 174. Acetophenone, 271. Benzophenone, 410. Benzoquinone, 600. Benzil, 747. Anthraquinone, 781.
VII, 1st Supplement (combined with Volume VIII)	1931	609-890	
VII, 2nd Supplement	1948	609-736	
VIII	1925	737-890	<i>Hydroxy-Carbonyl Compounds.</i> Salicylaldehyde, 31. Benzoin, 166. Vanillin, 247. Aurin, 361. Rosolic acid, 365. Alizarin, 439.
VIII, 1st Supplement	1931	609-890	
VIII, 2nd Supplement	1948	737-890	
IX	1926	891-1050	<i>Carboxylic Acids.</i> Benzoic acid, 92. Cinnamic acid, 572. Phthalic acid, 791.
IX, 1st Supplement	1932	891-1050	
IX, 2nd Supplement	1949	891-1050	
X	1927	1051-1504	<i>Hydroxy-Carboxylic Acids.</i> Salicylic acid, 43. Mandelic acid, 194. Gallic acid, 470. Carbonyl carboxylic acids, 594. Hydroxy-carbonyl carboxylic acids, 943.
X, 1st Supplement	1932	1051-1504	
X, 2nd Supplement	1949	1051-1504	

TABLE A.1. MODIFIED KEY TO BEILSTEIN'S HANDBUCH
DER ORGANISCHEN CHEMIE, 4TH EDITION (*continued*)

VOLUME	YEAR OF PUBLICATION	"SYSTEM NUMBERS"	BRIEF LIST OF CONTENTS
ISOCYCLIC DIVISION (<i>continued</i>)			
XI	1928	1505-1591	<i>Other Acids.</i>
XI, 1st Supplement	1933	1505-1739	Sulphinic acids: Benzenesulphinic acid, 2.
(combined with Volume XII)			Sulphonic acids: Benzenesulphonic acid, 26. <i>p</i> -Toluenesulphonic acid, 97. Naphthalene-sulphonic acid, 155.
XI, 2nd Supplement	1950	1505-1591a	Hydroxy-sulphonic acids: Phenol-sulphonic acid, 234. Naphthol-sulphonic acid, 269. Hydroxy-carbonyl sulphonic acids: Camphor-sulphonic acid, 345. Carboxylic-sulphonic acids, 368. Se and Te acids, 422.
XII	1929	1592-1739	<i>Monoamines.</i>
XII, 1st Supplement	1933	1505-1739	Aniline, 59. Toluidine, 772. Benzylamine, 1013. Naphthylamine, 1212.
XII, 2nd Supplement	1950	1592-1739	
XIII	1930	1740-1871	<i>Polyamines.</i>
XIII, 1st Supplement	1933	1740-1928	Diamines: <i>o</i> -Phenylenediamine, 6. Benzidine, 314. Triamines, 294.
(combined with Volume XIV)			Hydroxy-amines: <i>o</i> -Aminophenol, 354. Pararosanine, 750.
XIII, 2nd Supplement	1950	1740-1871	
XIV	1931	1872-1928	<i>Carbonyl-Amines.</i>
XIV, 1st Supplement	1933	1740-1928	Aminobenzaldehyde, 21. Aminoacetophenone, 41. Aminobenzophenone, 76.
XIV, 2nd Supplement	1951	1872-1928	Aminoanthraquinone, 177. Hydroxy-carbonyl amines, 233. Amino-carboxylic acids: Anthranilic acid (<i>o</i> -aminobenzoic acid), 310. Amino-hydroxy-carboxylic acids, 577. Amino-sulphonic acids: Sulphanilic acid, 695.
XV	1932	1929-2084	<i>Hydroxylamines.</i>
XV, 1st Supplement	1934	1929-2358	β -Phenylhydroxylamine, 2.
(combined with Volume XVI)			<i>Hydrazines.</i>
XV, 2nd Supplement	1951	1929-2084	Phenylhydrazine, 67. Acetaldehyde phenylhydrazone, 127. 2 : D4-initrophenylhydrazine, 489.

TABLE A.1. MODIFIED KEY TO BEILSTEIN'S HANDBUCH
DER ORGANISCHEN CHEMIE, 4TH EDITION (*continued*)

VOLUME	YEAR OF PUBLICA- TION	" SYSTEM NUMBERS "	BRIEF LIST OF CONTENTS
ISOCYCLIC DIVISION (<i>continued</i>)			
XVI	1933	2085-2358	<i>Azo Compounds.</i>
XVI, 1st Supplement	1934	1929-2358	Azobenzene, 8. Azotoluene, 60. Azo- phenol, 90. Azocresol, 130.
XVI, 2nd Supplement	1951	2085-2358	<i>Diazo Compounds.</i> Diazobenzene, 428. <i>Azoxy Compounds.</i> Azoxybenzene, 621. <i>Nitramines and Nitroso-hydroxylamines.</i> Phenylnitramine, 661. <i>Triazines.</i> Diazoaminobenzene, 687. <i>Phosphorus Compounds.</i> Triphenylphosphine, 759. <i>Arsenic Compounds.</i> Triphenylarsine, 828. Phenylarsonic acid, 868. <i>Antimony Compounds,</i> 891. Bi, Si, Sn, Pb, B, Tl, Mg, Ca, Hg, Na, Pt.

TABLE A.1. MODIFIED KEY TO BEILSTEIN'S HANDBUCH
DER ORGANISCHEN CHEMIE, 4TH EDITION (*continued*)

VOLUME	YEAR OF PUBLICATION	"SYSTEM NUMBERS"	BRIEF LIST OF CONTENTS
HETEROCYCLIC DIVISION			
XVII XVII, 1st Supplement (combined with Volumes XVIII and XIX) XVII, 2nd Supplement	1933	2359-2503	<i>One Cyclic Oxygen (S, Se or Te).</i> Stem nuclei : Furan, 27. Thiophene, 29. Hydroxy compounds : Furfuryl alcohol, 112. Carbonyl compounds : Butyrolactone, 234. Furfural, 272. 2-Acetylthiophene, 287. Xanthone, 355. Succinic anhydride, 404. Phthalic anhydride, 469.
	1934	2359-3031	
	1952	2359-2503	
XVIII XVIII, 1st Supplement XVIII, 2nd Supplement	1934	2504-2665	<i>One Cyclic Oxygen (continued).</i> Carbonyl compounds (<i>continued</i>) : Phenolphthalein, 143. Quercetin, 242. Carboxylic acids : Furoic acid, 272. Furfuracrylic acid, 300. Sulphonic acids, 567. Amines, 583. Hydroxylamines, 637. Hydrazines, 639. Azo compounds, 643. Diazo compounds, 651. Carbon-metal compounds, 653.
	1934	2359-3031	
	1952	2504-2665	
XIX XIX, 1st Supplement XIX, 2nd Supplement	1934	2666-3031	<i>Two Cyclic Oxygens.</i> Stem nuclei : Dioxan, 1. Thianthrene, 45. Hydroxy compounds, 63. Carbonyl compounds : Ethylene carbonate, 100. Piperonal, 115. Thioindigo, 177. Fluorescein, 222. Carboxylic acids : Piperonylic acid, 269. Amines, 328. <i>Three Cyclic Oxygens, 381.</i> <i>Four Cyclic Oxygens, 433.</i> <i>Five Cyclic Oxygens, 459. . . .</i>
	1934	2359-3031	
	1952	2666-3031	
XX XX, 1st Supplement (combined with Volumes XXI and XXII) XX, 2nd Supplement	1935	3032-3102	<i>One Cyclic Nitrogen.</i> Piperidine, 6. Pyrrole, 159. Pyridine, 181. Indole, 304. Quinoline, 339. Isoquinoline, 380. Carbazole, 433. Acridine, 459.
	1935	3032-3457	
	1953	3032-3102	

TABLE A.1. MODIFIED KEY TO BEILSTEIN'S HANDBUCH
DER ORGANISCHEN CHEMIE, 4TH EDITION (*continued*)

VOLUME	YEAR OF PUBLICATION	"SYSTEM NUMBERS"	BRIEF LIST OF CONTENTS
HETEROCYCLIC DIVISION (<i>continued</i>)			
XXI	1935	3103-3241	<i>One Cyclic Nitrogen</i> (continued). Hydroxy compounds: Atropine, 27. Hydroxy-pyridine, 43. Indoxyl, 69. Hydroxyquinoline, 77. Papaverine, 220. Carbonyl compounds: α -Pyrrolidone, 236. Tropinone, 259. Succinimide, 369. Isatin, 432. Phthalimide, 458.
XXI, 1st Supplement	1935	3032-3457	
XXI, 2nd Supplement	1953	3103-3241	
XXII	1935	3242-3457	<i>One Cyclic Nitrogen</i> (continued). Carboxylic acids: Nicotinic acid, 38. Quinoline carboxylic acid, 74. Cinchomeronic acid, 155. Hydroxy-carboxylic acids, 190: Indoxyl acid, 226. Carbonyl-carboxylic acids, 284. Sulphonic acids, 386: Quinoline sulphonic acid, 390. Amines, 419: 2-Aminopyridine, 428. Amino-carboxylic acids, 541: Tryptophane, 545. Hydrazines, 563. Azo compounds, 572. Diazo compounds, 590.
XXII, 1st Supplement	1935	3032-3457	
XXII, 2nd Supplement	1953	3242-3457	
XXIII	1936	3458-3554	<i>Two Cyclic Nitrogens</i> . Stem nuclei: Piperazine, 4. Diazomethane, 25. Pyrimidine, 89. Pyrazine, 91. Nicotine, 110. Dipyriddy, 199. Phenanthroline, 227. Hydroxy compounds, 348: Cinchonine, 424. Quinine, 511. Indigo white, 538.
XXIII, 1st Supplement (combined with Volumes XXIV and XXV)	1936	3458-3793	
XXIII, 2nd Supplement	1954	3458-3554	
XXIV	1936	3555-3633	<i>Two Cyclic Nitrogens</i> (continued). Carbonyl compounds: Antipyrin, 27. Picrolonic acid, 51. Hydantoin, 242. Uracil, 312. Indigo, 416. Barbituric acid, 467. Alloxan, 500.
XXIV, 1st Supplement	1936	3458-3793	
XXIV, 2nd Supplement	1954	3555-3663	
XXV	1936	3634-3793	<i>Two Cyclic Nitrogens</i> (continued). Hydroxy-carbonyl compounds, 1: Hydroxy-indanthrene, 102. Carboxylic acids: Diazoacetic acid, 109. Sulphonic acids: Indigo-disulphonic acid (indigocarmine), 304. Amines, 308. Keto-amines: Pyramidone, 452. Allantoin, 474. Murexide, 499. Amino-carboxylic acids: Histidine, 513. Hydrazines, 531. Azo compounds, 535.
XXV, 1st Supplement	1936	3458-3793	
XXV, 2nd Supplement	1955	3634-3793	

**TABLE A.1. MODIFIED KEY TO BEILSTEIN'S HANDBUCH
DER ORGANISCHEN CHEMIE, 4TH EDITION (continued)**

VOLUME	YEAR OF PUBLICATION	"SYSTEM NUMBERS"	BRIEF LIST OF CONTENTS
HETEROCYCLIC DIVISION (continued)			
XXVI	1937	3794-4187	<i>Three Cyclic Nitrogens to Eight Cyclic Nitrogens.</i>
XXVI, 1st Supplement (combined with Volume XXVII)	1938	3794-4720	Aldehyde-ammonia, 6. Triazole, 11. Hydroxy compounds, 103. Carbonyl compounds: Cyanuric acid, 231. Carboxylic acids, 276: Benzotriazole-carboxylic acid, 291.
XXVI, 2nd Supplement	1955	3794-4187	Four cyclic nitrogens, 321: Xanthine, 447. Caffeine, 461. Uric acid, 513.
XXVII	1937	4199-4720	<i>One Cyclic Oxygen and One Cyclic Nitrogen.</i>
XXVII, 1st Supplement	1938	3794-4720	Stem nuclei. Morpholine, 5. Hydroxy compounds: Scopolamine, 99. Carbonyl compounds, 135: Saccharin, 169. Carboxylic acids, 313. Sulphonic acids, 355. Amines, 361: Meldola's blue, 383. Methylene blue, 395. <i>Two to Four Cyclic Oxygens and One Cyclic Nitrogen.</i> <i>One Cyclic Oxygen and Two Cyclic Nitrogens.</i> <i>Two to Six Cyclic Oxygens and Two Cyclic Nitrogens.</i>
GENERAL INDEXES TO VOLUMES I-XXVII OF MAIN SERIES AND FIRST SUPPLEMENT AND ALSO TO SECOND SUPPLEMENT			
XXVIII	1938 1939 1955 1956		<i>Subject Index.</i> Part I. A-G. Part II. H-Z. Part I. A-G. Part II. H-Z.
XXIX	1939 1940 1956 1956		<i>Formula Index.</i> Part I. C ₁ -C ₁₃ . Part II. C ₁₄ -C ₁₉₅ . Part I. C ₁ -C ₁₁ . Part II. C ₁₂ -C ₁₇ .

TABLE A.1. MODIFIED KEY TO BEILSTEIN'S HANDBUCH
DER ORGANISCHEN CHEMIE, 4TH EDITION (*continued*)

VOLUME	YEAR OF PUBLICATION	"SYSTEM NUMBERS"	BRIEF LIST OF CONTENTS
NATURALLY OCCURRING COMPOUNDS			
XXX	1938	4723-4723a	<i>Rubber, 1. Guttapercha and Balata, 64. Carotenoids, 81.</i>
XXXI	1938	4746-4767a	<i>Carbohydrates, Part I. Arabinose, 32. Glucose, 83. Arbutin, 210. Fructose, 321. Maltose, 386. Lactose, 407. Sucrose, 424. Raffinose, 462.</i>

Each entry in "Beilstein" includes, where available, the information listed below with the references to the important original articles.

Name, formula and structure.

Important historical notes.

Occurrence, formation, preparation.

Properties: colour, crystallography, physical constants, etc.

Chemical changes: action of heat, light, electricity, inorganic reagents and organic reagents.

Physiological properties.

Technical applications.

Analysis.

Addition compounds and salts.

Conversion products of unknown structure.

The space devoted to any one compound varies from one line to several pages according to its importance.

A.2. ORIGINAL SOURCES OF CHEMICAL INFORMATION

All new information on chemical matters or original presentations and discussions of known material are published in scientific journals. The most important of these dealing with organic compounds are (the abbreviated names are given in parentheses) :

Journal of the Chemical Society (*J. Chem. Soc.*).

American Chemical Journal (merged with the Journal of the American Chemical Society in 1913) (*Amer. Chem. J.*).

Journal of the American Chemical Society (*J. Amer. Chem. Soc.*).

Journal of Organic Chemistry (*J. Org. Chem.*).

Annalen der Chemie or Liebig's Annalen (*Annalen*).

Berichte der deutschen chemischen Gesellschaft (*Ber.*).

Bulletin de la Société chimique de France (*Bull. Soc. chim.*).

Bulletin de la Société chimique de Belgique (*Bull. Soc. chim. Belg.*).

Recueil des Travaux chimiques des Pays-Bas (*Rec. Trav. chim.*).

Helvetica Chimica Acta (*Helv. Chim. Acta*).

Monatshefte für Chemie (*Monatsh.*).

Journal für praktische Chemie (*J. pr. Chem.*).

Zhurnal Obshchei Khimii or Journal of General Chemistry, U.S.S.R. (*J. Gen. Chem., U.S.S.R.*).

Gazzetta Chimica Italiana (*Gazzetta*).

Periodical summaries of recent knowledge are to be found in the Annual Reports on the Progress of Chemistry (issued annually by the Chemical Society, London), Quarterly Reviews (issued quarterly by the Chemical Society, London), and in Chemical Reviews.

A.3. SECONDARY SOURCES OF CHEMICAL INFORMATION. ABSTRACTING JOURNALS

Abstracting journals are publications giving contemporaneous, concise summaries of the various original communications and other contributions to knowledge. Each abstract usually supplies the title of the original contribution abstracted, name(s) of author(s), original reference (*i.e.*, name of journal or other source of information, year, series volume, page) and generally a brief summary of the original source. The value of the abstract, in the first instance, will depend upon how detailed the summary is. It must be emphasised, however, that the reader should never be satisfied with the account to be found in the abstract : he should, as far as possible, consult the original work and abstract it.

The three most important abstracting journals for organic chemistry are :

1. **British Chemical Abstracts.** These were commenced in the year 1871 and were included in the Journal of the Chemical Society. In 1926 the abstracting was taken over by the Bureau of Chemical Abstracts ; abstracts were then published in two parts : Part A " Pure Chemistry " (formerly issued by the Chemical Society) and Part B " Applied Chemistry "

(formerly issued by the Society of Chemical Industry). The Collective Indexes (1873-1882; 1883-1892; 1893-1902; 1903-1912; 1913-1922; 1923-1932; 1933-1937) provide an excellent means for following abstracts in the English language from 1871. Publication of the abstracts in "Pure Chemistry" was discontinued in January 1954.

2. Chemical Abstracts. These were commenced by the American Chemical Society in 1907. The abstracts are very comprehensive (particularly in recent years) from the standpoint of subject matter and journals covered. Four decennial indexes have appeared—1917, 1927, 1937 and 1947—and these are widely used for locating information published during the period 1907-1947. The annual indexes cover the period 1948 to date.

3. Chemisches Zentralblatt. This periodical, published by the Deutsche Chemische Gesellschaft to 1945, originated in 1830 as the Pharmaceutisches Zentralblatt, the name was changed in 1850 to Chemisches-Pharmaceutisches Zentralblatt, again in 1856 to Chemisches Zentralblatt, and in 1907 to Chemisches Zentralblatt. Collective indexes are available from 1870. The abstracts, particularly for organic chemistry, are very detailed to 1939.

A.4. LOCATING AN ORGANIC COMPOUND

A problem that frequently arises in the organic laboratory is to obtain more information concerning a particular compound than is found in the ordinary text-book, or whether such a compound is known. Formerly Richter's *Lexicon der Kohlenstoff-Verbindungen* (covering all the organic compounds known to December 31, 1909) and Stelzner's *Literatur Register der organischen Chemie* (1910-1922) were first consulted, but since the publication of the General Indexes to Beilstein's *Handbuch* (Volumes I-XXVII of the Main Series and First Supplement), this is no longer necessary. The two General Indexes (Subject Index and Formula Index) to Beilstein's *Handbuch* include all organic compounds known to 1919: the references are to the appropriate volume of "Beilstein." After 1919, it is necessary to consult the Collective Indexes of the various journals (compare Section A.3); of these the Decennial Indexes to 1947 of Chemical Abstracts (including the Collective Formula, 1920-1946) and the subsequent annual indexes to Chemical Abstracts will be found the most satisfactory.

A.5. SELECTED REFERENCE WORKS ON ORGANIC CHEMISTRY

Apart from a complete set of Beilstein's *Handbuch* and as many scientific journals with indexes as the Institution can afford, the following selected volumes are suggested as forming the nucleus of a small library for use in connexion with work in the organic chemistry laboratory.

- Heilbron and Bunbury, *Dictionary of Organic Compounds*, Revised Edition, Four Volumes, 1953 (Eyre and Spottiswoode).
- Mulliken, *Identification of Pure Organic Compounds*, Volumes I-IV, 1904-1922 (J. Wiley).
- Huntress-Mulliken, *Identification of Pure Organic Compounds*, Order I, 1941; Huntress, *Organic Chlorine Compounds*, Order III, 1948 (J. Wiley : Chapman and Hall).
- Organic Syntheses*, Volumes 1-35, 1921-1955 (J. Wiley: Chapman and Hall).
- Organic Syntheses*, Collective Volume I, Second Edition, 1941.
- Organic Syntheses*, Collective Volume II, 1943.
- Organic Syntheses*, Collective Volume III, 1955.
- Adams, *Organic Reactions*, Volumes I-VIII, 1942-1954 (J. Wiley : Chapman and Hall).
- Houben-Weyl, *Die Methoden der organischen Chemie*, Third Edition, Four Volumes, 1925-1941; Fourth Edition, Volume VIII, 1952 : Volume II, 1953 and subsequent volumes (G. Thieme, Stuttgart).
- Richter-Anschütz, *Chemie der Kohlenstoffverbindungen*, Twelfth Edition, 3 Volumes in 4, 1928-1935 (Akad. Verlag, Leipzig). An English translation under the title *Richter's Organic Chemistry* is available (Elsevier Publishing Co., 1934-1947).
- Rodd (Editor), *Chemistry of Carbon Compounds*, Five Volumes, each in two parts, 1951- (Elsevier Press : Cleaver-Hume Press).
- Radt (Editor), *Elsevier's Encyclopaedia of Organic Chemistry*, Eleven Volumes, 1940-1954; First Supplement, Three Volumes, 1951-1955 (Elsevier Press : Cleaver-Hume Press).

This reference work differs from Beilstein in that it is based upon structural formulae and compounds are grouped according to the carbon skeleton rather than the functional group; the latter system has the advantage that closely related compounds are grouped together. The volumes are not published in numerical order but rather on the basis of fields of current interest. They are a valuable supplement to Beilstein. The volumes which have been published to date (1955) are :

- XII A Bicyclic condensed compounds except naphthalene. (1948.)
- XII B (i) Naphthalene : hydrocarbons : halogen compounds. (1948.)
- XII B (ii) Naphthalene : nitrogen compounds. (1949.)
- XII B (iii) Naphthalene : hydroxy compounds. (1950.)
- XII B (iv) Naphthalene : oxo-compounds except quinones. (1950.)
- XII B (v) Naphthalene : quinones. (1952.)
- XII B (vi) Naphthalene : carboxylic acids with CO_2H in the side chain. (1953.)
- XII B (vii) Naphthoic acids and their halogen, nitrogen and hydroxyl derivatives. (1953.)
- XII B (viii) Naphthoic acids: CO_2 in the nucleus: oxo-acids, poly-acids. (1954.)
- XIII Tricyclic condensed compounds. (1946.)
- XIV Tetracyclic and higher condensed compounds. (1940.)
- XIV Tetra- and higher cyclic compounds except steroids and triterpenes. (1951.)
- Supp. (i) Triterpenes. (1952.)
- Supp. (ii) Steroids : hydrocarbon, halogen, nitrogen and hydroxyl derivatives. (1955.)
- XIV Steroids : hydrocarbon, halogen, nitrogen and hydroxyl derivatives. (1955.)
- Supp. (iii)

- Theilheimer, *Synthetic Methods of Organic Chemistry*, Volumes I–VIII, 1947–1954 (S. Karger, Basel).
- Gilman, *Organic Chemistry*, Four Volumes, 1943–1953 (J. Wiley : Chapman and Hall).
- Elderfield, *Heterocyclic Compounds*, Volumes I–IV, 1951–1954 (J. Wiley : Chapman and Hall).
- Wagner - Zook, *Synthetic Organic Chemistry*, 1953 (J. Wiley : Chapman and Hall).
- Raphael, *Acetylenic Compounds in Organic Synthesis*, 1955 (Butterworths).
- Whitmore, *Organic Chemistry*, Second Edition, 1951 (Van Nostrand).
- Turner and Harris, *Organic Chemistry*, 1952 (Longmans, Green).
- Ingold, *Structure and Mechanism in Organic Chemistry* (Cornell U.P. : G. Bell).
- Wheeler and Gowan, *Name Index of Organic Reactions*, 1953 (Society of Chemical Industry).
- Surrey, *Name Reactions in Organic Chemistry*, 1954 (Academic Press).
- Mitchell, *British Chemical Nomenclature*, 1948 (Arnold).
- Weissberger (Editor), *Technique of Organic Chemistry*, Volumes 1–8, 1949–1955 (Interscience).
- Siggia, *Quantitative Organic Analysis via Functional Groups*, Second Edition, 1954 (J. Wiley : Chapman and Hall).
- Organic Analysis*, Volumes I and II, 1953–1954 (Interscience).
- Biochemical Preparations*, Volumes I–IV, 1949–1955 (J. Wiley ; Chapman and Hall).
- Inorganic Syntheses*, Volumes I–IV, 1939–1953 (McGraw-Hill).
- Lange, *Handbook of Chemistry*, Eighth Edition, 1952 (Handbook Publishers, Sandusky, Ohio).

A.6. LABORATORY ACCIDENTS AND FIRST AID *

In case of accidents, always call or notify the demonstrator or teacher as soon as possible.

A First Aid Box or Cupboard should be kept in a readily accessible position in the laboratory and should contain the following articles clearly labelled :

* A valuable report, containing many references to cognate literature, is given in *The Origins and Prevention of Laboratory Accidents*, 1949 (Royal Institute of Chemistry, London, W.C. 1). See also *Guide for Safety in the Chemical Laboratory*, 1955 (Van Nostrand ; Macmillan).

Bandages (several sizes), gauze, lint, cotton wool, adhesive plaster, "Elastoplast" or equivalent, and a sling.

Delicate forceps, needles, thread, scissors, and safety pins.

Fine glass dropper.

Two eye glasses.

Vaseline, Castor oil, Olive oil, Sal volatile, Boracic acid powder, Sodium bicarbonate powder, Chloramine-T powder, Sulpha-pyridine powder, Butesin picrate ointment.

Acriflavine jelly or emulsion (*e.g.*, "Burnol").

Tannic acid jelly (*e.g.*, "Tannafax").

One fireproof blanket—this is best stored in a special container just outside the First Aid Cupboard.

Bottles containing :

One per cent. acetic acid.

One per cent. boric acid.

Saturated sodium bicarbonate solution.

One per cent. sodium bicarbonate solution.

Rectified spirit.

Glycerine.

Light petroleum, b.p. 80–100°.

A disinfectant, *e.g.*, "Dettol" or "T.C.P."

A "Laboratory Emergency Chart," which should be hung in a prominent position near the First Aid Box, is obtainable from the Fisher Scientific Company.

BURNS

Burns caused by dry heat (*e.g.*, by flames, hot objects, etc.). For slight burns in which the skin is not broken, apply tannic acid jelly ("Tannafax"), acriflavine jelly ("Burnol") or butesin picrate ointment (butesin is *n*-butyl *p*-aminobenzoate).

For larger burns, or burns in which the skin is reddened or blistered, apply one per cent. sodium bicarbonate solution without delay, and call for medical aid at once.

Acids on the skin. Wash immediately and thoroughly with a liberal quantity of water, then with saturated sodium bicarbonate solution, and finally with water. For a serious acid burn, follow this by applying a disinfectant, drying the skin and covering with acriflavine jelly.

Alkalis on the skin. Wash immediately with a large volume of water, then with 1 per cent. acetic acid, and finally with water. For a serious burn, follow this treatment by applying a disinfectant, drying the skin and covering with acriflavine jelly.

Bromine on the skin. Wash the affected part immediately with a liberal supply of light petroleum, b.p. 80–100°, and then rub glycerine well into the skin. After a little time remove the superficial glycerine and apply acriflavine jelly or butesin picrate ointment.

Sodium on the skin. If a small solidified fragment of sodium can still be seen, remove it carefully with forceps. Wash thoroughly with water, then with 1 per cent. acetic acid, and finally cover with gauze soaked in olive oil or acriflavine jelly.

Phosphorus on the skin. Wash well with cold water and treat with 1 per cent. silver nitrate solution.

Methyl sulphate on the skin. Wash immediately and liberally with concentrated ammonia solution, and then rub *gently* with wads of cotton wool soaked in concentrated ammonia solution.

Organic substances on the skin. Wash freely with rectified spirit, then with soap and warm water.

CUTS

If the cut is only a minor one, allow it to bleed for a few seconds, see that no glass remains, apply a disinfectant (rectified spirit, "Dettol," 1 per cent aqueous chloramine-T solution, or sulpha-pyridine powder) and bandage.

For serious cuts, send for a doctor at once: meanwhile wash with a disinfectant and endeavour to check bleeding by applying pressure immediately above the cut. Continuous pressure should not be maintained for more than five minutes.

EYE ACCIDENTS

In all cases the patient should see a doctor. If the accident appears serious, medical aid should be summoned immediately *while* first aid is applied.

Acid in the eye. If the acid is dilute, wash the eye repeatedly with 1 per cent. sodium bicarbonate solution in the eye cup. If the acid is concentrated, first wash the eye with a large amount of water and then continue with the bicarbonate solution.

Caustic alkali in the eye. Proceed as for acid in the eye, but wash with 1 per cent. boric acid solution in place of bicarbonate solution.

Bromine in the eye. Wash thoroughly with water and then immediately with 1 per cent. sodium bicarbonate solution.

Glass in the eye. Remove loose glass *very gently* with forceps or by washing with water in an eye bath. Call for a doctor immediately.

Soreness which may follow minor accidents to the eye may be relieved by placing 1 drop of castor oil in the corner of the eye.

FIRES

Burning clothing. Prevent the person from running and fanning the flames. Make the victim lie down on the floor, or throw him (her) down if necessary, and wrap the fireproof blanket firmly around the ignited clothes until the fire is extinguished.

Burning reagents. Turn out all gas burners and switch off all electric hot plates in the vicinity; remove everything which may ignite. The control of the fire depends upon its size and kind.

A small fire (for example, liquid in a beaker or flask, or an oil bath) may usually be extinguished by covering the opening of the vessel with a clean damp cloth or duster: the fire usually dies out from lack of air. For larger fires, dry sand may be employed. Buckets of dry sand should be distributed round the laboratory and should be *strictly reserved* for this purpose. Most fires on the laboratory bench can be smothered by

the liberal use of sand. Sand once employed for this purpose should always be thrown away afterwards as it may contain appreciable quantities of inflammable, non-volatile substances (*e.g.*, nitrobenzene).

Although sand is usually very effective for extinguishing fires, it has the disadvantage that the compound or reaction mixture is usually lost and any glass apparatus around which the fire centres may be broken under the weight of the sand. Alternatively, *small* fires may be extinguished with carbon tetrachloride under high pressure of carbon dioxide (as contained for example, in the commercial Autelex extinguisher *); the mixture is directed on the fire and the "blanketing" effect of the carbon dioxide and heavy carbon tetrachloride vapour will soon put out the fire. It must be noted particularly that :—

(a) carbon tetrachloride should not be used if sodium or potassium is present as violent explosions may result ;

(b) the laboratory must be ventilated immediately the fire is extinguished in order to disperse the highly poisonous phosgene vapour which is always formed.

It is usually better to use a fire extinguisher charged with carbon dioxide under pressure *; this produces a spray of solid carbon dioxide upon releasing the pressure intermittently and is effective for extinguishing most fires in the laboratory.

For burning oil (or organic solvents), do not use water as it will only spread the fire: a mixture of sand and sodium bicarbonate is very effective.

POISONS

Solids or liquids.

(i) In the mouth but not swallowed. Spit out at once and wash repeatedly with water.

(ii) If swallowed. Call a doctor immediately. In the meantime, give an antidote according to the nature of the poison.

(a) *Acids (including oxalic acid)*. Dilute by drinking much water, followed by lime water or milk of magnesia. Milk may then be given but no emetics.

(b) *Caustic alkalis*. Dilute by drinking much water, followed by vinegar, lemon or orange juice, or solutions of lactic acid or citric acid. Milk may then be given but no emetics.

(c) *Salts of heavy metals*. Give milk or white of an egg.

(d) *Arsenic or mercury compounds*. Give an emetic immediately, *e.g.*, one teaspoonful of mustard, or one tablespoonful of salt or zinc sulphate, in a tumbler of warm water.

Gas.

Remove the victim to the open air, and loosen clothing at neck. To counteract chlorine or bromine fumes if inhaled in only small amounts, inhale ammonia vapour or gargle with sodium bicarbonate solution. Afterwards the patient should suck eucalyptus pastilles, or drink warm dilute peppermint or cinnamon essence, to soothe the throat and lungs.

If breathing has stopped, apply artificial respiration.

* Supplied by Read and Campbell Ltd., 75 Victoria Street, London, S.W. 1., etc.

A.7. APPLICATIONS OF INFRARED AND ULTRAVIOLET SPECTRA TO ORGANIC CHEMISTRY*

INTRODUCTION

Information about the structure of a molecule can frequently be obtained from observations of its absorption spectrum. The positions of the absorption bands due to any molecule depend upon its atomic and electronic configuration. To a first approximation, the internal energy E of a molecule can be regarded as composed of additive contributions from the electronic motions within the molecule (E_e), the vibrational motions of the constituent atoms relative to one another (E_v), and the rotational motion of the molecule as a whole (E_r):

$$E = E_e + E_v + E_r$$

The energies of the various contributions are "quantised", *i.e.*, in a given state the isolated molecule may possess one of a discrete set of values; these values are often referred to as energy levels. When a molecule absorbs light, its energy is momentarily increased by an amount equal to that of the photon. The energy is related to the wave length (λ) and frequency (ν) by the equation:

$$E = h\nu = hc/\lambda$$

where h is Planck's constant and c is the velocity of light. The increase in energy can be accommodated as electronic, vibrational or rotational energy. The relative magnitudes in the changes of rotational : vibrational : electronic energies are approximately 1 : 50 : 1000; it is possible to excite changes in the rotational energy without affecting appreciably the vibrational or electronic energy, or vibrational-rotational energy without influencing the electronic energy to any degree. Absorption by molecules in the infrared region involves changes in their rotational and vibrational energies only; absorption by molecules in the ultraviolet region produces changes in the electronic energies in addition. For these and other reasons, molecular absorption gives rise to bands instead of the sharp lines obtained with atoms.

The positions of lines or bands in the electromagnetic spectrum may be expressed either as wave lengths (λ) or as frequencies (ν). The units employed in the measurement of wave lengths are:

$$\begin{aligned} 1 \text{ micron} &= 1\mu = 10^{-4} \text{ cm.} \\ 1 \text{ millimicron} &= 1 \text{ m}\mu = 10^{-7} \text{ cm.} \\ 1 \text{ Angstrom} &= 1 \text{ \AA} = 10^{-8} \text{ cm.} \end{aligned}$$

The frequency is related to the wave length by the equation:

$$\nu = c/\lambda$$

where c is the velocity of light. When c is in cm. per sec. (2.99776×10^{10} cm. per sec. in vacuo) and λ is in cm., ν is in reciprocal seconds (sec.^{-1}), the unit of frequency is the *fresnel*. Frequencies in the optical region of the electromagnetic spectrum are large numbers and it is more convenient to use the *wave number* ($\tilde{\nu}$), which is the number of waves per cm.:

$$\tilde{\nu} (\text{cm.}^{-1}) = 1/\lambda (\text{cm.}) = 10^4/(\mu) = 10^8/\lambda (\text{\AA})$$

* Written in collaboration with R. F. Branch, B.Sc., A.R.I.C.

The conversion of wave lengths into wave numbers may be illustrated by a simple example :

$$\begin{aligned} 5\mu &= 5 \times 10^{-4} \text{ cm.} = 1/(5 \times 10^{-4}) \text{ wave numbers} \\ &= 2000 \text{ wave numbers (cm.}^{-1}\text{)} \end{aligned}$$

The wave lengths of the various parts of the electromagnetic spectrum of immediate interest are :

$$\begin{aligned} \text{Far ultraviolet} &= 1000\text{--}2000 \text{ \AA} = 100\text{--}200 \mu\mu \\ \text{Near ultraviolet} &= 2000\text{--}4000 \text{ \AA} = 200\text{--}400 \mu\mu \\ \text{Visible} &= 4000\text{--}8000 \text{ \AA} = 400\text{--}800 \mu\mu \\ \text{Near infrared} &= 0.8\text{--}2\mu \\ \text{Infrared} &= 2\text{--}25\mu \\ \text{Far infrared} &= 25\text{--}100\mu \end{aligned}$$

For infrared spectra, both microns and wave numbers (cm.^{-1}) are convenient units. For electronic spectra (ultraviolet and visible), the milli-micron is largely used ; the wave numbers (cm.^{-1}) may range between 13,000 and 50,000 and consequently many authors employ $\text{cm.}^{-1} \times 10^{-3}$.

The *intensity of a spectral absorption band* at a given wave length is expressed in terms of absorption or extinction coefficients, defined on the basis of the Beer-Lambert law. The latter states that the fraction of incident light absorbed is proportional to the number of molecules in the light path, *i.e.*, to the concentration (c) and the path length (l). The law may be expressed mathematically as :

$$\log_{10} (I_0/I) = E = kcl$$

where I_0 and I represent the intensities (in arbitrary units) of incident and transmitted light ; E is the "extinction" or "optical density"; and k is an absorption coefficient, the numerical value of which depends upon the units in which c and l are expressed. The two absorption coefficients now most frequently employed by chemists are :

(a) The *molecular extinction coefficient*, defined by

$$\epsilon = E/cl$$

where c is in g.-mols per litre and l is in cm.

Thus ϵ may be regarded as the absorption of a sample 1 cm. thick and having a concentration of 1 g.-mol per litre ; this is a useful form of the equation since ϵ provides a comparison of intensity for equal numbers of molecules.

(b) The *extinction, one per cent., one centimetre*, given by

$$E_{1 \text{ cm.}}^{1\%} = E/cl$$

where c is in g. per 100 ml. and l is in cm. This is convenient when the molecular weight is unknown.

Both $E_{1 \text{ cm.}}^{1\%}$ and ϵ are independent of concentration and cell length, provided the Beer-Lambert law is obeyed. The two quantities are related by the expression :

$$E_{1 \text{ cm.}}^{1\%} = 10\epsilon/\text{mol. wt.}$$

The absolute intensity of an absorption band may be expressed by giving the value of $\epsilon_{\text{max.}}$, the molecular extinction coefficient at the wave

length of maximum absorption, λ_{\max} . This quantity can be determined by means of the Beer-Lambert law provided the slit widths are sufficiently narrow. This criterion can usually be fulfilled when measuring the ultra-violet spectra of solutions, but is seldom fulfilled for infrared spectra.

The term *transmittance* (T) at a given wave length is defined by

$$T = I/I_0 \quad ; \quad 100T = \text{per cent transmittance.}$$

INFRARED SPECTRA

The infrared region of the electromagnetic spectrum can, perhaps, yield the most information concerning the structure of organic molecules. The masses of the atoms, and the forces holding them together, are of such magnitude that the usual vibration of organic molecules interact with electromagnetic energy so as to absorb and radiate in the infrared region. Overtones and combinations of these vibrational frequencies may appear in the visible region and in the near-infrared ($0.8-2\mu$), but most of the fundamental vibrations occur in the interval from 2 to 25μ . It is this region of fundamental frequencies that is generally of greatest value in the study of organic molecules. Problems of identity, purity, gross structural features, as well as many finer points of structural detail, can be solved through the use of infrared spectroscopy, often faster than by any other analytical method. For a molecule of high complexity and molecular weight and of unknown constitution, it is usually better to break it down to simpler parts just as is done when a structure is elucidated chemically by degradative methods. The infrared spectrum provides a physical constant which is more valuable than the melting point for characterising organic compounds. A mixed melting point can take as much time as is needed to obtain an infrared spectrum, yet it yields only a single fact whilst the spectrum may provide a great deal of information.

Modern automatically recording infrared spectrophotometers employ a rock-salt prism (rock salt is transparent to infrared radiation) and scan the range from 5000 cm.^{-1} to 600 cm.^{-1} (or 2μ to 16.7μ) in a few minutes, the spectrum being obtained as a graph of frequency or wave length against percentage transmittance. Liquids are examined by placing them in cells of suitable thickness (normally about 0.05 mm.) which are equipped with rock-salt windows. Solids can either be dissolved in a solvent and placed in a rock-salt cell, or ground to a paste with pure liquid paraffin (Nujol) and examined as a fine suspension or "mull" on a rock-salt plate. The amount of sample required is 1-5 mg. If the C-H bands of the sample are to be examined, Nujol cannot be used; it may be replaced by a completely fluorinated hydrocarbon (e.g., perfluorokerosene, which is satisfactory for the region above 1450 cm.^{-1}) available commercially. The useful transparent regions of solvents employed in infrared work are given in Table I.

It has been observed that particular vibrational bands can be associated with specific groupings in the molecule and, furthermore, the position of a band varies only slightly in frequency throughout a large number of organic compounds. For example, all compounds containing the carbonyl (C=O) group are found to show a strong absorption band between 1800 cm.^{-1} (5.56μ) and 1650 cm.^{-1} (6.06μ). Also, the precise position

TABLE I. USEFUL RANGES OF SOLVENTS FOR INFRARED MEASUREMENTS

<i>Solvent</i>	<i>Range (cm.⁻¹)</i>	<i>Range (μ)</i>
Carbon tetrachloride	10000-830	1-12
Carbon disulphide	10000-2500	1-4
	2000-1670	5-6
	1330-600	7.5-16.7
Bromoform	10000-3333	1-3
	2500-1176	4-8.5
	1110-715	9-14
Chloroform	10000-3333	1-3
	2857-1250	3.5-8
	1110-830	9-12
Nujol (liquid paraffin)	10000-3333	1-3
	2500-1470	4-6.8
	1250-667	8-15
Nitromethane	909-690	11-14.5
Perfluorokerosene	10000-2000	1-5

of the carbonyl absorption band within this range is characteristic of the type of keto compound.

For purposes of discussion, it is convenient to divide the region from 5000 to 600 cm.⁻¹ (2 to 16.7μ) into four main divisions.

TABLE II. REGION 5000-2000 CM.⁻¹ (2-5μ)

<i>Bond or Group</i>	<i>Range (cm.⁻¹)</i>	<i>Range (μ)</i>
O—H (free)	3650-3590 (<i>v</i>)*	2.74-2.79 (<i>v</i>)
O—H (associated)	3570-3200 (<i>s</i>)	2.80-3.13 (<i>s</i>)
N—H	3500-3200 (<i>m</i>)	2.86-3.13 (<i>m</i>)
≡C—H (acetylenic)	3310-3200 (<i>s</i>)	3.02-3.13 (<i>s</i>)
=C—H (olefinic)	near 3030 (<i>m</i>)	near 3.3 (<i>m</i>)
C—H	2926-2850 (<i>s</i>)	3.38-3.51 (<i>s</i>)
S—H	2600-2550 (<i>w</i>)	3.85-3.92 (<i>w</i>)
C≡N	2260-2215 (<i>v</i>)	4.43-4.52 (<i>v</i>)
N≡N	2160-2120 (<i>s</i>)	4.63-4.72 (<i>s</i>)
C=C=C	near 1950 (<i>m</i>)	near 5.13 (<i>m</i>)

* (*vs*) = very strong; (*s*) = strong; (*m*) = medium; (*w*) = weak; and (*v*) = variable intensity of band.

The intensity of an absorption band assists its identification, but it is difficult to obtain accurate absolute intensity measurements with existing spectrophotometers, although a given instrument will give accurately reproducible measurements. However, a rough indication of intensity is given in the Tables by the following symbols: *vs*, very strong; *s*, strong; *m*, medium; *w*, weak; and *v*, variable.

1. **Region 5000–2000 cm.^{-1} (2–5 μ).** This is the region of the characteristic stretching vibrations of single and triple bonds, and it includes the strong C—H stretching absorption which occurs in the majority of organic compounds. Alcohols, phenols, amines, imines, amides, hydrocarbons, mercaptans, nitriles, azides and allenes show absorption in this region. Allenes, which contain two adjacent double bonds, behave as though they contained a triple and a single bond. The lowering of the O—H and N—H stretching frequencies by hydrogen bonding renders this region of the infrared spectrum valuable for the study of this phenomenon (see Table II).

2. **Region 2000–1500 cm.^{-1} (5.00–6.67 μ).** The highly characteristic stretching vibrations of double bonds are to be found here. Aldehydes, ketones, carboxylic acids and their salts, esters, acid halides, amides, lactones, nitro groups, azo compounds, ethylenes and aromatic rings absorb in this region. Conjugation of double bonds results in a shift to lower frequencies. This is illustrated for carbonyl compounds in Table IV. Full aliphatic conjugation causes a larger shift to lower frequencies than does aryl conjugation except for carboxylic acids.

TABLE III. REGION 2000–1500 cm.^{-1} (5–6.67 μ)

Bond or Group	Range (cm.^{-1})	Range (μ)
NO ₂	1560–1500 (<i>s</i>)* and 1360–1300 (<i>s</i>)	6.41–6.67 (<i>s</i>) and 7.35–7.69 (<i>s</i>)
C=C	1660–1590 (<i>v</i>)	6.02–6.29 (<i>v</i>)
C=N	1660–1590 (<i>v</i>)	6.02–6.29 (<i>v</i>)
N=N	1630–1575 (<i>v</i>)	6.14–6.35 (<i>v</i>)
Aromatic (phenyl) ring	near 1600 (<i>v</i>) and near 1500 (<i>v</i>)	near 6.25 (<i>v</i>) and near 6.67 (<i>v</i>)
COO ⁻	1610–1550 (<i>s</i>)	6.21–6.45 (<i>s</i>)

3. **Region 1500–900 cm.^{-1} (6.67–11.11 μ).** This is the region of deformation and skeletal vibrations; these are less stable in frequency, and hence are less characteristic, than the stretching vibrations. The assignment of absorption bands to specific groups is less trustworthy in this region, and the spectrum is characteristic of the whole skeletal structure of the molecule. This region is known as the “fingerprint” region. Some correlations are available, but it must be remembered that many interfering bands are likely to be present (see Table IV).

* (*vs*) = very strong; (*s*) = strong; (*m*) = medium; (*w*) = weak; and (*v*) = variable intensity of band.

TABLE IV. CARBONYL FREQUENCIES *

<i>Compound</i>	<i>Type</i>	<i>Range (cm.⁻¹)</i>	<i>Range (μ)</i>
Anhydride . . .	normal	1860-1800 and 1800-1750	5.38-5.56 and 5.56-5.71
Aldehyde . . .	alkyl	1740-1720	5.75-5.81
	aryl	1715-1695	5.83-5.90
	αβ-unsaturated	1705-1680	5.86-5.95
Ketone . . .	alkyl	1725-1705	5.80-5.86
	aryl	1700-1680	5.88-5.95
	αβ-unsaturated	1685-1665	5.93-6.00
Acid . . .	alkyl	1725-1700	5.80-5.88
	aryl	1700-1680	5.88-5.95
	αβ-unsaturated	1715-1690	5.83-5.92
Ester . . .	alkyl	1750-1735	5.71-5.76
	aryl	1730-1717	5.78-5.83
	αβ-unsaturated	1730-1717	5.78-5.83
Acid halide . . .	alkyl	1815-1770	5.51-5.65
	aryl	1800-1770	5.56-5.65
	αβ-unsaturated	1800-1770	5.56-5.65
Amide . . .	alkyl	1700-1630	5.88-6.14
	aryl	1700-1630	5.88-6.14
γ-Lactone . . .	alkyl	1780-1760	5.62-5.68
	aryl	1760-1740	5.68-5.75
	αβ-unsaturated	1760-1740	5.68-5.75

TABLE V. REGION 1500-900 CM.⁻¹ (6.67-11.11μ)

<i>Bond or Group</i>	<i>Range (cm.⁻¹)</i>	<i>Range (μ)</i>
C-CH ₃	1470-1430 and 1380-1370 (<i>m</i>)	6.80-6.99 and 7.25-7.30 (<i>m</i>)
CH ₂	1485-1445 (<i>m</i>)	6.73-6.92 (<i>m</i>)
COO ⁻ (salt)	1420-1300 (<i>s</i>)	7.04-7.69 (<i>s</i>)
O=C-O-H (acid)	1440-1395 (<i>w</i>) and 1320-1210 (<i>s</i>)	6.94-7.17 (<i>w</i>) 7.58-8.26 (<i>s</i>)
O=C-O-C	1150-1060 (<i>vs</i>)	8.70-9.43 (<i>vs</i>)
O-H	near 1100 (<i>s</i>)	near 9.09 (<i>s</i>)
-O-O-	890-820 (<i>v</i>)	11.24-12.20 (<i>v</i>)
P=O (free)	1300-1250 (<i>s</i>)	7.69-8.00 (<i>s</i>)
P=O (bonded)	1250-1200 (<i>vs</i>)	8.00-8.33 (<i>vs</i>)
P-O-C (alkyl)	1050-1000 (<i>vs</i>)	9.52-10.00 (<i>vs</i>)
P-O-C (aryl)	1240-1190 (<i>vs</i>)	8.07-8.40 (<i>vs</i>)
C-F	1400-1000 (<i>vs</i>)	7.14-10.00 (<i>vs</i>)
S=O	1060-1040 (<i>s</i>)	9.43-9.62 (<i>s</i>)
SO ₂	1160-1140 (<i>s</i>) and 1350-1300 (<i>s</i>)	8.62-8.77 (<i>s</i>) and 7.41-7.69 (<i>s</i>)

* All strong absorptions.

4. Region $900\text{--}600\text{ cm.}^{-1}$ ($11\cdot11\text{--}16\cdot67\mu$). This is the region of strong, aryl, out-of-plane, C—H deformation vibration absorptions, which are valuable for identifying the substitution pattern in the aromatic ring. Substitution in the ring alters the number of C—H groups which are vibrating together and causes changes in the absorption pattern. Identification is not trustworthy for heavily substituted, nitro substituted or heterocyclic ring-substituted aromatic compounds (see Table VI).

TABLE VI. AROMATIC (PHENYL) RING ABSORPTION FREQUENCIES *

<i>Substitution</i>	<i>Groups</i>	<i>Range (cm. ⁻¹)</i>	<i>Range (μ)</i>
Monosubstituted	5 C—H	770–730 and 710–690	13·0–13·7 and 14·1–14·5
<i>o</i> -Disubstituted	4 C—H	770–735	13·0–13·6
<i>m</i> -Disubstituted	3 and 1 C—H	810–750 and 900–860	12·4–13·3 and 11·1–11·6
<i>p</i> -Disubstituted	2 C—H	860–800	11·6–12·5

* Usually all strong absorptions.

Interpretation of spectra. The infrared spectrum of *m*-hydroxybenzoic acid (solid ground in Nujol) is shown in Fig. A, 7, 1. The more important bands may be interpreted as follows.

Band 1, 3·08 μ (3242 cm.⁻¹). Hydrogen bonded O—H absorption of the phenolic group (Table II).

Band 2, 3·48 μ (2873 cm.⁻¹). C—H stretching absorption of Nujol. The weak =C—H stretching absorption of the aromatic (phenyl) ring is hidden by the broad Nujol band (Table II).

Band 3, 3·93 μ (2548 cm.⁻¹). This absorption is characteristic of carboxylic acids and is due to the O—H stretching absorption in the resonance-stabilised dimer. (Carboxylic acids generally exist as dimers in the solid state and in all but very dilute solutions.)

Band 4, 5·94 μ (1683 cm.⁻¹). Aryl carboxylic acid C=O stretching vibration (Table IV).

Band 5, 6·25 μ (1601 cm.⁻¹). Aromatic (phenyl) ring absorption. The weak "shoulder" at 6·33 μ (1580 cm.⁻¹) may be noted. When the aromatic ring is conjugated, as in the present example, the aromatic (phenyl) band is often split into a doublet and is usually more pronounced (Table III).

Band 6, 6·65 μ (1503 cm.⁻¹). Aromatic ring absorption (Table III).

Band 7, 6·91 μ (1447 cm.⁻¹). C—H deformation vibration of CH₂ groups in Nujol (Table V).

Band 8, 7·10 μ (1408 cm.⁻¹). This is a characteristic carboxylic acid absorption band and it arises from a C—O vibration coupled with an

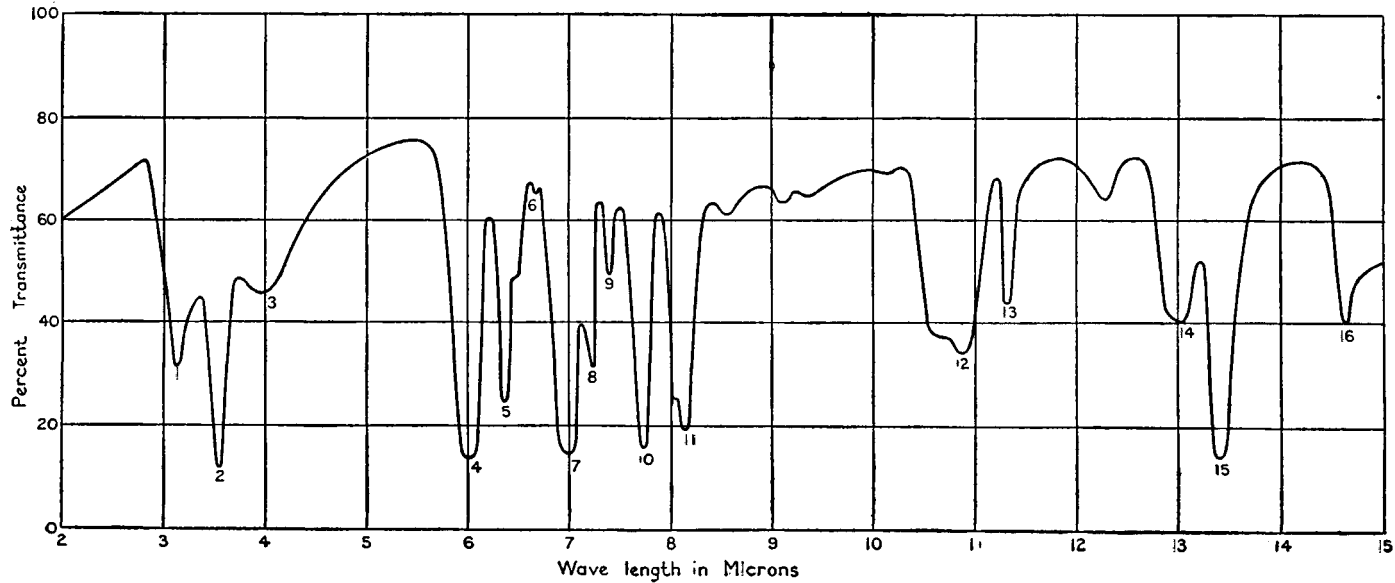

Fig. A, 7, 1.—Infrared Spectrum of *m*-Hydrobenzoic Acid.

O—H deformation vibration. It is readily observed in the spectrum as it lies between two characteristic Nujol bands in this region (Table V).

Band 9, 7.30 μ (1370 cm.^{-1}). C—H deformation vibration absorption of C—CH₃ in Nujol (Table V).

Band 10, 7.75 μ (1290 cm.^{-1}). This band arises from a C—O vibration coupled with an O—H deformation vibration (Table V).

Band 11, 8.15 μ (1227 cm.^{-1}). The origin of this absorption (a doublet) is uncertain, but is believed to be associated with the C—O bond.

Band 12, 10.85 μ (921 cm.^{-1}). This composite band is due partly to the O—H deformation vibration of a carboxylic acid.

Band 13, 11.45 μ (873 cm.^{-1}). Out-of-plane C—H deformation vibration. Meta substitution (Table VI).

Band 14, 13.00 μ (769 cm.^{-1}). Out-of-plane C—H deformation vibration. Meta substitution (Table VI).

Band 15, 13.25 μ (755 cm.^{-1}). This may be the C—C absorption of the ring carboxyl group.

Band 16, 14.80 μ (676 cm.^{-1}). Origin uncertain.

It must be emphasised that the above Tables must be used with caution. The presence of a specific group cannot always be established with certainty from the presence of the absorption band, particularly in the deformation vibration region; on the other hand, the absence of the appropriate absorption band indicates that the grouping is not present. The physical state in which the substance is examined may have an appreciable influence; the Tables apply generally to dilute solutions in organic solvents (see Table I).

Some applications of infrared spectra. A few of the applications of infrared spectroscopy may be mentioned.

1. Compound comparison. Because of the large number of absorption bands, the infrared spectrum of a molecule provides a good method of comparison. Two non-identical molecules have different infrared spectra when obtained by identical techniques; hence identification of unknowns may be made by a direct comparison. The infrared absorption bands in the region 2–8 μ are largely interpretable as due to specific functional groups. Not all bands that appear in the region of longer wave length (8–16 μ) are as yet capable of interpretation but the region nevertheless is highly characteristic of the specific compound involved. This part of the infrared spectrum is called the "fingerprint" region and is very useful for the comparison of an unknown with an authentic sample; if the two intricate spectra are exactly superposable, the compounds may be regarded as identical.

2. Testing the purity of a compound. If the spectrum of a sample of known purity is available, the presence of impurities in another sample can be detected from the additional bands in its infrared spectrum.

3. Recognition of functional groups or gross structural features.

4. Following the isolation of a desired product. The isolation of a desired substance by a purification procedure such as distillation or chromatography may be followed by a determination of the infrared spectrum. It is not essential to know what the compound is in this

connexion, since the concentration of the unknown substance can be traced by observing some characteristic absorption band.

5. Study of hydrogen bonding. Hydrogen bonding through an O—H or N—H group alters the characteristic vibrational frequency of that group: broadly, the stronger the hydrogen bonding, the greater is the lowering of the fundamental O—H or N—H vibration frequency.

6. Quantitative analysis of mixtures.

7. Following the progress of chemical operations.

ULTRAVIOLET AND VISIBLE SPECTRA

Ultraviolet and visible spectra arise from transitions between the electronic states in molecules. The terms "electronic spectra" and "ultraviolet and visible spectra" are synonymous and cover the range 200–800 $m\mu$. The far-ultraviolet region 100–200 $m\mu$, only partially transmitted by quartz and appreciably absorbed by air, will not be considered.

Ultraviolet and visible spectrophotometers employ a glass or quartz prism, and the necessary range is normally scanned manually; automatically recording instruments which provide a direct tracing of E against λ are available commercially. Substances are generally examined in solution in glass or quartz cells of about 1 cm. thickness. Owing to the greater energy of visible and ultraviolet radiation, the ratio of spectral slit width to band width can be made much smaller in visible and ultraviolet spectrophotometers than in infrared instruments. For this reason and also because cell thicknesses of the order of 1 cm. are easily reproducible, accurate absolute intensity measurements can be made in this region of the spectrum, and the intensity of an absorption band becomes correspondingly more important for identification purposes.

The electronic transitions which produce spectra in the visible and ultraviolet are accompanied by vibrational and rotational transitions. In the condensed state, however, rotation is hindered by solvent molecules, and stray electrical fields affect the vibrational frequencies. For these reasons, electronic bands are very broad. An electronic band is characterised by the wave length and molecular extinction coefficient at the position of maximum intensity (λ_{\max} . and ϵ_{\max}).

Electronic absorption bands can be correlated with molecular structure and therein lies the importance of visible and ultraviolet spectra to the organic chemist. For the purpose of structure analysis, infrared spectra are generally more valuable than visible and ultraviolet spectra. Infrared spectroscopy possesses the advantage that all organic compounds absorb in the region. Infrared spectra contain many sharp bands, are more sensitive to structural changes, and solid materials can be investigated. In the ultraviolet and visible portion of the electromagnetic spectrum, however, a wider range of solvents (including water) is available.

The substance is examined in a dilute solution in a solvent. A wide choice of solvents, transparent to ultraviolet radiation, is available. The paraffin hydrocarbons are all suitable, as are the aliphatic alcohols and the chlorinated hydrocarbons, such as chloroform and carbon tetrachloride. The most useful solvents are *n*-hexane, *cyclohexane*, chloro-

form and carbon tetrachloride ; water, diethyl ether, ethanol and methanol are used only if considerations of solubility make it necessary. In general, polar solvents should be avoided. The selected solvent must be free from absorbing impurities ; "spectroscopically pure" solvents can be purchased. The possibility of interaction between the solvent and the compound under examination must always be considered. When the absorption spectrum of a pure substance is determined in each of a series of solvents, a slight difference in the location and the intensity of the absorption bands is usually observed with variation in solvent. The small solvent effects depend upon the nature of the solvent, the type of absorption band (*K*- or *R*-band *), and the nature of the solute (polar or non-polar). Marked changes in the nature of the absorption may be due to chemical interaction with the solvent, complex formation, dissociation or to equilibration of two tautomers in solution. Table VI gives the lowest wave length ($m\mu$) at which a number of purified solvents transmit ultraviolet radiation in 1 cm. cells.

TABLE VII. LOWEST WAVE LENGTH ($m\mu$) AT WHICH SOLVENTS TRANSMIT ULTRAVIOLET RADIATION

<i>Solvent</i>	<i>Wave Length</i>	<i>Solvent</i>	<i>Wave Length</i>
<i>cyclo</i> Hexane	195	Water	191
<i>n</i> -Hexane	200	Ethanol	204
Carbon tetrachloride	257	<i>iso</i> Propanol	205
Chloroform	237	Methanol	225
Benzene	280	Diethyl ether	225

SURVEY OF DATA

Chromophores and auxochromes. Absorption of light in the visible and ultraviolet regions is due to the excitation of relatively loosely-bound electrons, such as in multiple bonds or of lone pairs. The classical term for an arrangement of multiple bonds in adjacent positions (*i.e.*, separated by one single bond) and for the electronic interaction resulting therefrom is "conjugation". The unsaturation electrons of multiple bonds are the π -electrons and we may adopt the term π - π conjugation for this case. In saturated organic compounds containing elements other than carbon and hydrogen, *e.g.*, nitrogen, oxygen or halogen, unshared *p*-electrons are present as well as the σ -valency electrons. The non-bonding *p*-electrons are held rather less firmly than σ -electrons. We may also have a π -*p* conjugation with certain groups, such as $-\text{NR}_2$; this is now realised to be

* Two or more chromophores (see below) in conjugation produce intense bands, which are termed *K*-bands (from the German *Konjugation*) in the neighbourhood of 230 $m\mu$. Low intensity bands at longer wave lengths, probably due to single chromophores, are termed *R*-bands (from German *Radikal*).

as strong as π - π conjugation. The π - σ conjugation is much weaker. Each type of conjugation results in a band displacement to longer wave lengths (*bathochromic effect*). It should be noted that the term *hypsochromic* effect refers to displacement to shorter wave lengths.

In addition to π - and p -electrons, two other types of electrons contribute to ultraviolet and visible absorption; these are charge-electrons and unpaired electrons. The profound effect of introducing a permanent charge is shown, for instance, by the difference in absorption of the colourless triphenylmethane and the coloured triphenylmethyl ion. The visible band of the latter is probably due to a transition in which the distribution of the "resonating" charge between the several available positions in the phenyl rings becomes momentarily altered under the influence of the light field. Such spectra are called charge-resonance spectra; they are responsible *inter alia* for the intense long wave absorption and visible colour of triphenylmethane dyes, cyanine dyes, etc. The presence of a "resonating" unpaired electron in a conjugated system similarly produces "electron resonance" spectra, which are responsible for the visible colour, for example, of the triphenylmethyl radical.

Witt in 1876 coined the term *chromophore* for unsaturated groups such as $C=C$, $C=O$ and $N=N$, which he thought to be essential for colour in organic compounds, and the term *auxochrome* for groups, such as $-NR_2$, thought to play an auxiliary role in producing and modifying colour. In modern usage the terms chromophore and auxochrome are employed to designate π -electron and p -electron groups respectively.

Some of the simple chromophoric groups, together with the absorption maxima of simple compounds containing these groups, are collected in

TABLE VIII. TYPICAL SINGLE CHROMOPHORIC GROUPS

Chromophore	System	Example	$\lambda_{\max. m\mu}$	$\epsilon_{\max.}$	Solvent
Ethylene .	$>C=C<$	Oct-3-ene	185	8000	Hexane
Acetylene .	$-C\equiv C-$	Acetylene	173	6000	Vapour
Carbonyl .	$>C=O$	Acetone	188	900	Hexane
Azomethine.	$>C=N-$	Acetoxime	279	15	—
			190	5000	Water
Nitrile .	$-C\equiv N$	Acetonitrile	<160	—	—
Thiocarbonyl	$>C=S$	Diethyl thioncarbonate	330	5	Water
Azo .	$-N=N-$	Ethyl diazoacetate	252	8000	Ethanol
Nitroso .	$-N=O$	Nitrosobutane	300	100	Ether
Nitro .	$-NO_2$	Nitromethane	271	19	Alcohol
Nitrite .	$-ON=O$	Octyl nitrite	230	2200	Hexane
Nitrate .	$-ONO_2$	Ethyl nitrate	270	12	Dioxan
Sulphoxide	$>SO$	cycloHexyl methyl sulphoxide	210	1500	Alcohol
Sulphone .	$>SO_2$	Dimethyl sulphone	<180	—	—
Carboxyl .	$-CO_2$	Acetic acid	204	60	Water

Table VIII. The compounds selected are as typical as possible, but it must be remembered that there are many environmental factors that produce changes in the location of the absorption bands. These displacements are usually of the order of a few $m\mu$, but in some cases they are so great as to move the absorption band into a completely different region of the spectrum.

Typical auxochromes are hydroxyl, alkoxy and aroxy, amino, alkyl-amino and arylamino, all of which promote conjugation with lone pairs on oxygen or nitrogen atoms.

When two or more chromophores are present in the same molecule, their absorption is usually additive as long as they are separated by two or more single bonds. Two chromophores in conjugation (*i.e.*, separated by only one single bond) give rise to a new type of absorption with increased λ_{\max} and ϵ_{\max} . Some examples are given in Table IX.

TABLE IX. TWO CONJUGATED CHROMOPHORES

<i>System</i>	<i>Example</i>	λ_{\max} $m\mu$	ϵ_{\max} .
C=C—C=C	Butadiene	217	21000
C=C—C≡C	Vinylacetylene	219	6500
C=C—C=N	<i>N</i> -Butylcrotonaldimine	220	23000
C=C—C≡N	1-Cyanocyclohexene	211	11000
C=N—N=C	Butyraldazine	205	13000
C=C—C=O	Crotonaldehyde	217	16000

The conjugation of three unsaturated centres results in a further increase in λ_{\max} , and ϵ_{\max} . Some results are given in Table X.

TABLE X. THREE CONJUGATED CHROMOPHORES

<i>System</i>	<i>Example</i>	λ_{\max} $m\mu$	ϵ_{\max} .
C=C—C=C—C=C	Hexatriene	258	35000
C=C—C=C—C=O	Sorbaldehyde	263	27000
C=C—CO—C=C	Dipropenyl ketone	245	16000
O=C—C=C—C=O	Diacetylene	226	14500

The electronic spectra of benzenoid systems differ in a characteristic manner from their acyclic analogues. Thus benzene, unlike hexatriene,

exhibits a relatively weak band at 255 $m\mu$, but has two strong bands at 184 $m\mu$ and 202 $m\mu$. Fusion of two or more benzene nuclei results in changes in absorption with displacement to higher wave lengths. Some complicated selected results are collected in Table XI.

TABLE XI. AROMATIC HYDROCARBONS

	$\lambda_{\max.}$	$\log \epsilon_{\max.}$	$\lambda_{\max.}$	$\log \epsilon_{\max.}$	$\lambda_{\max.}$	$\log \epsilon_{\max.}$
Benzene	184	4.67	202	3.84	255	2.35
Naphthalene	220	5.05	275	3.75	312	2.40
Anthracene	252	5.30	375	3.90	—	—
Phenanthrene	252	4.70	295	4.10	330	2.90
Chrysene	268	5.15	320	4.10	360	2.80
Diphenyl	—	—	252	4.26	—	—

Space does not permit any further detailed discussion except for a brief account of two interesting subjects. The first is concerned with keto-enol tautomerism. The classical example is ethyl acetoacetate, which can exist in the keto form (I) and the enol form (II) :

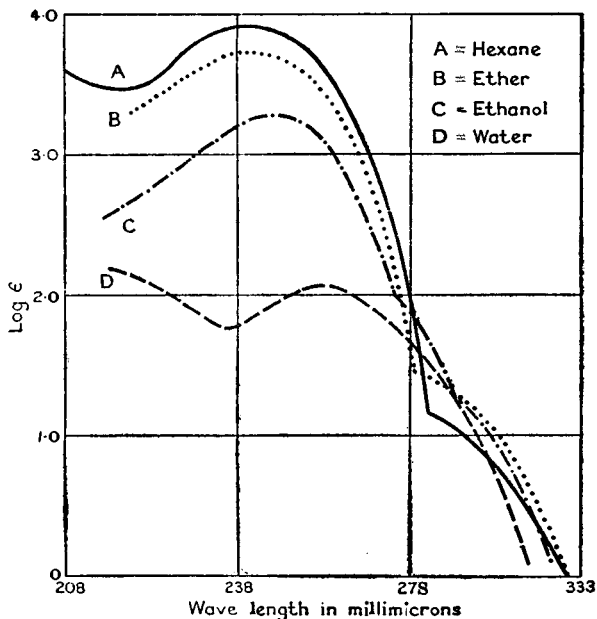
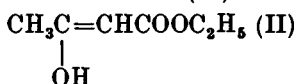
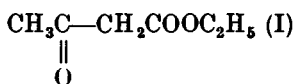

Fig. A, 7, 2.—Ultraviolet spectrum of ethyl acetoacetate in various solvents.

The former exhibits absorption typical of an isolated keto group, whereas the latter shows a high intensity *K*-band associated with the conjugated system $\text{HO}-\text{C}=\text{C}-\text{C}=\text{O}$. The proportions of the two forms under various conditions are readily determined from the ultraviolet spectra. The ultraviolet spectra in various solvents are shown in Fig. A, 7, 2.

Since the absorption of the keto form is negligible, the percentage of enol present is $100(\epsilon_m/\epsilon_e)$, where ϵ_m is the observed extinction at 245 $m\mu$ and ϵ_e that of the pure enol. It was shown that in alcoholic solution ϵ_m is 1900 and the percentage of enol is 12. Thus ϵ_e is *ca.* 16000, and use of this value permits the approximate evaluation of the enol content in different solvents. The results are collected in Table XII.

TABLE XII. KETO-ENOL EQUILIBRIA OF ETHYL ACETOACETATE

<i>Solvent</i>	$\lambda_{\text{max.}}$ $m\mu$	$\epsilon_{\text{max.}}$	% <i>Enol</i>
Hexane . . .	243.9	8100	51
Water . . .	255.1	120	—
Ether . . .	243.9	5100	32
Ethanol . . .	235.7	1900	12

The second subject is concerned with *cis* and *trans* isomers. The *trans* isomer has the higher $\lambda_{\text{max.}}$ value (except for azobenzene) and the larger $\epsilon_{\text{max.}}$. This will be apparent from the data in Table XIII.

TABLE XIII. ULTRAVIOLET ABSORPTION MAXIMA OF *CIS* AND *TRANS* ISOMERS

	<i>Cis</i>		<i>Trans</i>	
	$\lambda_{\text{max.}}$ $m\mu$	$\epsilon_{\text{max.}}$	$\lambda_{\text{max.}}$ $m\mu$	$\epsilon_{\text{max.}}$
PhCH=CHPh . . .	280	10500	295	27000
PhCH=CHCOOH . . .	264	9500	273	21000
PhCH=CHCOPh . . .	289	8900	298	24000
PhN=NPh . . .	324	15000	319	20000

Some applications of electronic spectra. These include :—

1. Qualitative identification. The spectrum is of help in identifying organic compounds. If two compounds are identical, the electronic spectra must be identical : the converse is not necessarily true and in this

respect ultraviolet data are less suitable than infrared data for the "fingerprinting" of substances. The spectrum is characteristic of the chromophoric system rather than that of the complete molecule.

2. Determination of purity. The ultraviolet and visible absorption is often a fairly intensive property; thus ϵ values of high intensity bands may be of the order of 10^4 - 10^5 . In infrared spectra ϵ values rarely exceed 10^3 . It is therefore often easy to pick out a characteristic band of a substance present in small concentration in admixture with other materials. Thus small amounts of aromatic compounds can be detected in hexane or in cyclohexane.

3. Determination of structural features. The ultraviolet spectrum has been of value in the determination of the structure of several vitamins. Thus the presence of an α -naphthoquinone system in vitamin K was first detected by this means. Also the 4-methylthiazole and the 2:5-dimethyl-6-aminopyridine system was first identified in vitamin B₁ (thiamine). α - and β -Ionones can be distinguished since the former contains two conjugated chromophores and the latter three conjugated chromophores.

4. Quantitative analysis. Spectroscopic analysis is widely used in the analysis of vitamin preparations, mixtures of hydrocarbons (*e.g.*, benzene, toluene, ethylbenzene, xylenes) and other systems exhibiting characteristic electronic spectra. The extinction coefficient at $326\text{ m}\mu$, after suitable treatment to remove other materials absorbing in this region, provides the best method for the estimation of the vitamin A content of fish oils.

5. Determination of the dissociation constants of acids and bases from the change of absorption spectra with *pH*. The spectrochemical method is particularly valuable for very weak bases, such as aromatic hydrocarbons and carbonyl compounds which require high concentrations of strong mineral acid in order to be converted into the conjugate acid to a measurable extent.

6. Detecting steric hindrance. Hindered rotation about single bonds may be studied. Diphenyls containing bulky *ortho* substituents can exist as two optical enantiomorphs. For a hindered diphenyl to be resolved, the energy barrier must be of the order of 20 k. cal./mol, but electronic spectra are a much more sensitive test of non-planarity. Thus in *ortho*-ditolyl the *K* band near $250\text{ m}\mu$ (present in diphenyl) has completely disappeared and the planes of the two rings must be at an angle of over 45° . The method is therefore of advantage when optical resolution cannot be used as a criterion.

7. Study of reaction rates.

The above account of infrared and ultraviolet spectra should provide an introduction to the subject. Further information can be obtained by reference to the books listed below.

SELECTED BIBLIOGRAPHY

- Bellamy, *The Infra-Red Spectra of Complex Molecules*, 1954 (Methuen).
Randall, Fowler, Fuson and Dangle, *Infrared Determination of Organic Structures*, 1942 (Van Nostrand).
Gilman, *Organic Chemistry*, Volume III, 1953 (J. Wiley: Chapman and Hall).

- Braude and Nachod, *Determination of Organic Structures by Physical Methods*, 1955 (Academic Press).
- Strouts, Gilfillan and Wilson, *Analytical Chemistry. The Working Tools*, Volume II, 1955 (Oxford University Press).
- Gillam and Stern, *An Introduction to Electronic Absorption Spectroscopy in Organic Chemistry*, 1954 (Arnold).
- Braude, *Ultra-Violet Light Absorption and the Structure of Organic Compounds* {Annual Reports, 42, 105 (1945)}.

DENSITIES AND PERCENTAGE COMPOSITIONS OF VARIOUS SOLUTIONS

TABLE A,8,1.

AQUEOUS ETHYL ALCOHOL

PER CENT. C ₂ H ₅ OH BY WEIGHT	DENSITY $d_{4}^{20^{\circ}}$	DENSITY $d_{4}^{25^{\circ}}$	PER CENT. C ₂ H ₅ OH BY VOLUME (20°)	PER CENT. C ₂ H ₅ OH BY WEIGHT	DENSITY $d_{4}^{20^{\circ}}$	DENSITY $d_{4}^{25^{\circ}}$	PER CENT. C ₂ H ₅ OH BY VOLUME (20°)
5	0.98938	0.98817	6.2	75	0.85564	0.85134	81.3
10	0.98187	0.98043	12.4	80	0.84344	0.83911	85.5
15	0.97514	0.97334	18.5	85	0.83095	0.82660	89.5
20	0.96864	0.96639	24.5	90	0.81797	0.81362	93.3
25	0.96168	0.95895	30.4	91	0.81529	0.81094	94.0
30	0.95382	0.95067	36.2	92	0.81257	0.80823	94.7
35	0.94494	0.94146	41.8	93	0.80983	0.80549	95.4
40	0.93518	0.93148	47.3	94	0.80705	0.80272	96.1
45	0.92472	0.92085	52.7	95	0.80424	0.79991	96.8
50	0.91384	0.90985	57.8	96	0.80138	0.79706	97.5
55	0.90258	0.89850	62.8	97	0.79846	0.79415	98.1
60	0.89113	0.88699	67.7	98	0.79547	0.79117	98.8
65	0.87948	0.87527	72.4	99	0.79243	0.78814	99.4
70	0.86766	0.85340	76.9	100	0.78934	0.78506	100.0

TABLE A,8,2.

AQUEOUS METHYL ALCOHOL

PER CENT. CH ₃ OH BY WEIGHT	DENSITY $d_{4}^{15^{\circ}}$	PER CENT. CH ₃ OH BY VOLUME	PER CENT. CH ₃ OH BY WEIGHT	DENSITY $d_{4}^{15^{\circ}}$	PER CENT. CH ₃ OH BY VOLUME
5	0.99029	6.22	75	0.86300	81.34
10	0.98241	12.35	80	0.85048	85.50
15	0.97518	18.38	85	0.83742	89.45
20	0.96814	24.33	90	0.82396	93.19
25	0.96108	30.19	91	0.82124	93.91
30	0.95366	35.95	92	0.81849	94.63
35	0.94570	41.59	93	0.81568	95.33
40	0.93720	47.11	94	0.81285	96.02
45	0.92815	52.49	95	0.80999	96.70
50	0.91852	57.71	96	0.80713	97.37
55	0.90839	62.78	97	0.80428	98.04
60	0.89781	67.69	98	0.80143	98.70
65	0.88662	72.42	99	0.79859	99.35
70	0.87507	76.98	100	0.79577	100.00

TABLE A,8,3.

AQUEOUS HYDROCHLORIC ACID

PER CENT. HCl BY WEIGHT	DENSITY d_{4}^{20}	GRAMS HCl PER 100 ML.	PER CENT. HCl BY WEIGHT	DENSITY d_{4}^{20}	GRAMS HCl PER 100 ML.	PER CENT. HCl BY WEIGHT	DENSITY d_{4}^{20}	GRAMS HCl PER 100 ML.
1	1.0032	1.003	14	1.0675	14.95	28	1.1392	31.90
2	1.0082	2.006	16	1.0776	17.24	30	1.1492	34.48
4	1.0181	4.007	18	1.0878	19.58	32	1.1593	37.10
6	1.0279	6.167	20	1.0980	21.96	34	1.1691	39.75
8	1.0376	8.301	22	1.1083	24.38	36	1.1789	42.44
10	1.0474	10.47	24	1.1187	26.85	38	1.1885	45.16
12	1.0574	12.69	26	1.1290	29.35	40	1.1980	47.92

TABLE A,8,4.

AQUEOUS SULPHURIC ACID

PER CENT. H ₂ SO ₄ BY WEIGHT	DENSITY d_{4}^{20}	GRAMS H ₂ SO ₄ PER 100 ML.	PER CENT. H ₂ SO ₄ BY WEIGHT	DENSITY d_{4}^{20}	GRAMS H ₂ SO ₄ PER 100 ML.	PER CENT. H ₂ SO ₄ BY WEIGHT	DENSITY d_{4}^{20}	GRAMS H ₂ SO ₄ PER 100 ML.
1	1.0051	1.005	40	1.3028	52.11	91	1.8195	165.6
2	1.0118	2.024	45	1.3476	60.64	92	1.8240	167.8
3	1.0184	3.055	50	1.3951	69.76	93	1.8279	170.0
4	1.0250	4.100	55	1.4453	79.49	94	1.8312	172.1
5	1.0317	5.159	60	1.4983	89.90	95	1.8337	174.2
10	1.0661	10.66	65	1.5533	101.0	96	1.8355	176.2
15	1.1020	16.53	70	1.6105	112.7	97	1.8364	178.1
20	1.1394	22.79	75	1.6692	125.2	98	1.8361	179.9
25	1.1783	29.46	80	1.7272	138.2	99	1.8342	181.6
30	1.2185	36.56	85	1.7786	151.2	100	1.8305	183.1
35	1.2579	44.10	90	1.8144	163.3			

TABLE A,8,5.

AQUEOUS NITRIC ACID

PER CENT. HNO ₃ BY WEIGHT	DENSITY d_{4}^{20}	GRAMS HNO ₃ PER 100 ML.	PER CENT. HNO ₃ BY WEIGHT	DENSITY d_{4}^{20}	GRAMS HNO ₃ PER 100 ML.	PER CENT. HNO ₃ BY WEIGHT	DENSITY d_{4}^{20}	GRAMS HNO ₃ PER 100 ML.
1	1.0036	1.004	40	1.2463	49.85	91	1.4850	135.1
2	1.0091	2.018	45	1.2783	57.52	92	1.4873	136.8
3	1.0146	3.044	50	1.3100	65.50	93	1.4892	138.5
4	1.0201	4.080	55	1.3393	73.66	94	1.4912	140.2
5	1.0256	5.128	60	1.3667	82.00	95	1.4932	141.9
10	1.0543	10.54	65	1.3913	90.43	96	1.4952	143.5
15	1.0842	16.26	70	1.4134	98.94	97	1.4974	145.2
20	1.1150	22.30	75	1.4337	107.5	98	1.5008	147.1
25	1.1469	28.67	80	1.4521	116.2	99	1.5056	149.1
30	1.1800	35.40	85	1.4686	124.8	100	1.5129	151.3
35	1.2140	42.49	90	1.4826	133.4			

TABLE A,8,6.

AQUEOUS ACETIC ACID

PER CENT. CH ₃ COOH BY WEIGHT	DENSITY d_{4}^{20}	GRAMS CH ₃ COOH PER 100 ML.	PER CENT. CH ₃ COOH BY WEIGHT	DENSITY d_{4}^{20}	GRAMS CH ₃ COOH PER 100 ML.	PER CENT. CH ₃ COOH BY WEIGHT	DENSITY d_{4}^{20}	GRAMS CH ₃ COOH PER 100 ML.
1	0.9996	0.9996	40	1.0488	41.95	91	1.0652	96.93
2	1.0012	2.002	45	1.0534	47.40	92	1.0643	97.92
3	1.0025	3.008	50	1.0575	52.88	93	1.0632	98.88
4	1.0040	4.016	55	1.0611	58.36	94	1.0619	99.82
5	1.0055	5.028	60	1.0642	63.85	95	1.0605	100.7
10	1.0125	10.13	65	1.0666	69.33	96	1.0588	101.6
15	1.0195	15.29	70	1.0685	74.80	97	1.0570	102.5
20	1.0263	20.53	75	1.0696	80.22	98	1.0549	103.4
25	1.0326	25.82	80	1.0700	85.60	99	1.0524	104.2
30	1.0384	31.15	85	1.0689	90.86	100	1.0498	105.0
35	1.0438	36.53	90	1.0661	95.95			

TABLE A,8,7.

AQUEOUS FORMIC ACID

PER CENT. HCOOH BY WEIGHT	DENSITY d_4^{20}	GRAMS HCOOH PER 100 ML.	PER CENT. HCOOH BY WEIGHT	DENSITY d_4^{20}	GRAMS HCOOH PER 100 ML.	PER CENT. HCOOH BY WEIGHT	DENSITY d_4^{20}	GRAMS HCOOH PER 100 ML.
1	1.0019	1.002	40	1.0963	43.85	91	1.2059	109.7
2	1.0044	2.009	45	1.1085	49.88	92	1.2078	111.1
3	1.0070	3.021	50	1.1207	56.04	93	1.2099	112.5
4	1.0093	4.037	55	1.1320	62.26	94	1.2117	113.9
5	1.0115	5.058	60	1.1424	68.54	95	1.2140	115.3
10	1.0246	10.25	65	1.1543	75.03	96	1.2158	116.7
15	1.0370	15.66	70	1.1655	81.59	97	1.2170	118.0
20	1.0488	20.98	75	1.1769	88.27	98	1.2183	119.4
25	1.0609	26.52	80	1.1860	94.88	99	1.2202	120.8
30	1.0729	32.19	85	1.1953	101.6	100	1.2212	122.1
35	1.0847	37.96	90	1.2044	108.4			

TABLE A,8,8.

AQUEOUS PHOSPHORIC ACID

PER CENT. H ₃ PO ₄ BY WEIGHT	DENSITY d_4^{20}	GRAMS H ₃ PO ₄ PER 100 ML.	PER CENT. H ₃ PO ₄ BY WEIGHT	DENSITY d_4^{20}	GRAMS H ₃ PO ₄ PER 100 ML.	PER CENT. H ₃ PO ₄ BY WEIGHT	DENSITY d_4^{20}	GRAMS H ₃ PO ₄ PER 100 ML.
2	1.0092	2.018	40	1.254	50.16	80	1.633	130.6
4	1.0200	4.080	45	1.293	58.19	85	1.689	143.6
6	1.0309	6.185	50	1.335	66.75	90	1.746	157.1
8	1.0420	8.336	55	1.379	75.85	92	1.770	162.8
10	1.0532	10.53	60	1.426	85.56	94	1.794	168.6
20	1.1134	22.27	65	1.475	95.88	96	1.819	174.6
30	1.1805	35.42	70	1.526	106.8	98	1.844	180.7
35	1.216	42.56	75	1.579	118.4	100	1.870	187.0

TABLE A,8,9.

AQUEOUS HYDROBROMIC ACID

PER CENT. HBr BY WEIGHT	DENSITY $d_{4}^{20^{\circ}}$	GRAMS HBr PER 100 ML.	PER CENT. HBr BY WEIGHT	DENSITY $d_{4}^{20^{\circ}}$	GRAMS HBr PER 100 ML.	PER CENT. HBr BY WEIGHT	DENSITY $d_{4}^{20^{\circ}}$	GRAMS HBr PER 100 ML.
10	1.0723	10.7	40	1.3772	56.1	60	1.6787	100.7
20	1.1579	23.2	45	1.4446	65.0	65	1.7675	114.9
30	1.2580	37.7	50	1.5173	75.8			
35	1.3150	46.0	55	1.5953	87.7			

TABLE A,8,10.

AQUEOUS HYDRIDIC ACID

PER CENT. HI BY WEIGHT	DENSITY $d_{4}^{15^{\circ}}$	GRAMS HI PER 100 ML.	PER CENT. HI BY WEIGHT	DENSITY $d_{4}^{15^{\circ}}$	GRAMS HI PER 100 ML.
20.77	1.1758	24.4	56.78	1.6998	96.6
31.77	1.2962	41.2	61.97	1.8218	112.8
42.7	1.4489	61.9			

TABLE A,8,11.

FUMING SULPHURIC ACID (OLEUM)

PER CENT. FREE SO ₂ BY WEIGHT	DENSITY d_{20}^{20}	GRAMS FREE SO ₂ PER 100 ML.	PER CENT. FREE SO ₂ BY WEIGHT	DENSITY d_{20}^{20}	GRAMS FREE SO ₂ PER 100 ML.	PER CENT. FREE SO ₂ BY WEIGHT	DENSITY d_{20}^{20}	GRAMS FREE SO ₂ PER 100 ML.
1.54	1.860	2.8	8.16	1.890	15.4	15.95	1.920	30.6
2.66	1.865	5.0	9.43	1.895	17.7	18.67	1.925	35.9
4.28	1.870	8.0	10.07	1.900	19.1	21.34	1.930	41.2
5.44	1.875	10.2	10.56	1.905	20.1	25.65	1.935	49.6
6.42	1.880	12.1	11.43	1.910	21.8			
7.29	1.885	13.7	13.33	1.915	25.5			
PER CENT. FREE SO ₂ BY WEIGHT	DENSITY d_{15}^{15}	PER CENT. TOTAL SO ₂ BY WEIGHT	PER CENT. FREE SO ₂ BY WEIGHT	DENSITY d_{15}^{15}	PER CENT. TOTAL SO ₂ BY WEIGHT	PER CENT. FREE SO ₂ BY WEIGHT	DENSITY d_{15}^{15}	PER CENT. TOTAL SO ₂ BY WEIGHT
10	1.888	83.46	50	2.009	90.81	90	1.990	98.16
20	1.920	85.30	60	2.020	92.65	100	1.984	100.00
30	1.957	87.14	70	2.018	94.48			
<p><i>Note.</i> Oleum with 0-30 per cent. free SO₂ is liquid at 15°. 30-56 per cent. free SO₂ is solid at 15°. 56-73 per cent. free SO₂ is liquid at 15°. 73-100 per cent. free SO₂ is solid at 15°.</p>								

TABLE A,8,12.

AQUEOUS AMMONIA SOLUTIONS

PER CENT. NH ₃ BY WEIGHT	DENSITY d_{4}^{20}	GRAMS NH ₃ PER 1000 ML.	PER CENT. NH ₃ BY WEIGHT	DENSITY d_{4}^{20}	GRAMS NH ₃ PER 1000 ML.	PER CENT. NH ₃ BY WEIGHT	DENSITY d_{4}^{20}	GRAMS NH ₃ PER 1000 ML.
1	0.9939	9.94	10	0.9575	95.75	20	0.9229	184.6
2	0.9895	19.79	12	0.9501	114.0	22	0.9164	201.6
4	0.9811	39.24	14	0.9430	132.0	24	0.9101	218.4
6	0.9730	58.38	16	0.9362	149.8	26	0.9040	235.0
8	0.9651	77.21	18	0.9295	167.3	28	0.8980	251.4
						30	0.8920	267.6

TABLE A,8,13.

AQUEOUS SODIUM HYDROXIDE

PER CENT. NaOH BY WEIGHT	DENSITY d_{4}^{20}	GRAMS NaOH PER 100 ML.	PER CENT. NaOH BY WEIGHT	DENSITY d_{4}^{20}	GRAMS NaOH PER 100 ML.	PER CENT. NaOH BY WEIGHT	DENSITY d_{4}^{20}	GRAMS NaOH PER 100 ML.
1	1.0095	1.010	18	1.1972	21.55	36	1.3900	50.04
2	1.0207	2.041	20	1.2191	24.38	38	1.4101	53.58
4	1.0428	4.171	22	1.2411	27.30	40	1.4300	57.20
6	1.0648	6.389	24	1.2629	30.31	42	1.4494	60.87
8	1.0869	8.695	26	1.2848	33.40	44	1.4685	64.61
10	1.1089	11.09	28	1.3064	36.58	46	1.4873	68.42
12	1.1309	13.57	30	1.3279	39.84	48	1.5065	72.31
14	1.1530	16.14	32	1.3490	43.17	50	1.5253	76.27
16	1.1751	18.80	34	1.3696	46.57			

TABLE A,8,14.

AQUEOUS POTASSIUM HYDROXIDE

PER CENT. KOH BY WEIGHT	DENSITY $d_{4}^{15^{\circ}}$	GRAMS KOH PER 100 ML.	PER CENT. KOH BY WEIGHT	DENSITY $d_{4}^{15^{\circ}}$	GRAMS KOH PER 100 ML.	PER CENT. KOH BY WEIGHT	DENSITY $d_{4}^{15^{\circ}}$	GRAMS KOH PER 100 ML.
1	1.0083	1.008	18	1.1688	21.04	36	1.3549	48.78
2	1.0175	2.035	20	1.1884	23.77	38	1.3769	52.32
4	1.0359	4.144	22	1.2083	26.58	40	1.3991	55.96
6	1.0544	6.326	24	1.2285	29.48	42	1.4215	59.70
8	1.0730	8.584	26	1.2489	32.47	44	1.4443	63.55
10	1.0918	10.92	28	1.2695	35.55	46	1.4673	67.50
12	1.1108	13.33	30	1.2905	38.72	48	1.4907	71.55
14	1.1299	15.82	32	1.3117	41.97	50	1.5143	75.72
16	1.1493	19.70	34	1.3331	45.33	52	1.5382	79.99

TABLE A,8,15.

AQUEOUS SODIUM CARBONATE

PER CENT. Na ₂ CO ₃ BY WEIGHT	DENSITY $d_{4}^{20^{\circ}}$	GRAMS Na ₂ CO ₃ PER 100 ML.	PER CENT. Na ₂ CO ₃ BY WEIGHT	DENSITY $d_{4}^{20^{\circ}}$	GRAMS Na ₂ CO ₃ PER 100 ML.	PER CENT. Na ₂ CO ₃ BY WEIGHT	DENSITY $d_{4}^{20^{\circ}}$	GRAMS Na ₂ CO ₃ PER 100 ML.
1	1.0086	1.009	8	1.0816	8.653	16	1.1682	18.50
2	1.0190	2.038	10	1.1029	11.03	18	1.1905	21.33
4	1.0398	4.159	12	1.1244	13.49	20	1.2132	24.26
6	1.0606	6.364	14	1.1463	16.05			

TABLE A,8,16.

AQUEOUS POTASSIUM CARBONATE

PER CENT. K ₂ CO ₃ BY WEIGHT	DENSITY $d_{4}^{20^{\circ}}$	GRAMS K ₂ CO ₃ PER 100 ML.	PER CENT. K ₂ CO ₃ BY WEIGHT	DENSITY $d_{4}^{20^{\circ}}$	GRAMS K ₂ CO ₃ PER 100 ML.	PER CENT. K ₂ CO ₃ BY WEIGHT	DENSITY $d_{4}^{20^{\circ}}$	GRAMS K ₂ CO ₃ PER 100 ML.
1	1.0072	1.007	14	1.1291	15.81	28	1.2756	35.72
2	1.0163	2.033	16	1.1490	18.38	30	1.2979	38.94
4	1.0345	4.138	18	1.1692	21.05	35	1.3548	47.42
6	1.0529	6.317	20	1.1898	23.80	40	1.4141	56.56
8	1.0715	8.572	22	1.2107	26.64	45	1.4759	66.42
10	1.0904	10.90	24	1.2320	29.57	50	1.5404	77.02
12	1.1096	13.32	26	1.2536	32.59			

TABLE A,8,17.

AQUEOUS SODIUM CHLORIDE

PER CENT. NaCl BY WEIGHT	DENSITY $d_{4}^{20^{\circ}}$	GRAMS NaCl PER 100 ML.	PER CENT. NaCl BY WEIGHT	DENSITY $d_{4}^{20^{\circ}}$	GRAMS NaCl PER 100 ML.	PER CENT. NaCl BY WEIGHT	DENSITY $d_{4}^{20^{\circ}}$	GRAMS NaCl PER 100 ML.
1	1.0053	1.005	10	1.0707	10.71	20	1.1478	22.96
2	1.0125	2.025	12	1.0857	13.03	22	1.1640	25.61
4	1.0268	4.107	14	1.1009	15.41	24	1.1840	28.33
6	1.0413	6.248	16	1.1162	17.86	26	1.1972	31.13
8	1.0559	8.447	18	1.1319	20.37			

TABLE A,8,18.

AQUEOUS POTASSIUM CHLORIDE

PER CENT. KCl BY WEIGHT	DENSITY $d_{4}^{20^{\circ}}$	GRAMS KCl PER 100 ML.	PER CENT. KCl BY WEIGHT	DENSITY $d_{4}^{20^{\circ}}$	GRAMS KCl PER 100 ML.	PER CENT. KCl BY WEIGHT	DENSITY $d_{4}^{20^{\circ}}$	GRAMS KCl PER 100 ML.
1	1.0046	1.005	8	1.0500	8.400	16	1.1043	17.67
2	1.0110	2.022	10	1.0633	10.63	18	1.1185	20.13
4	1.0239	4.096	12	1.0768	12.92	20	1.1328	22.66
6	1.0369	6.221	14	1.0905	15.27	22	1.1474	25.24
						24	1.1623	27.90

TABLE A,8,19.

AQUEOUS SODIUM NITRITE

PER CENT. NaNO ₂ BY WEIGHT	DENSITY $d_{4}^{15^{\circ}}$	GRAMS NaNO ₂ PER 100 ML.	PER CENT. NaNO ₂ BY WEIGHT	DENSITY $d_{4}^{15^{\circ}}$	GRAMS NaNO ₂ PER 100 ML.	PER CENT. NaNO ₂ BY WEIGHT	DENSITY $d_{4}^{15^{\circ}}$	GRAMS NaNO ₂ PER 100 ML.
1	1.0058	1.006	8	1.0535	8.428	16	1.1103	17.76
2	1.0125	2.025	10	1.0675	10.68	18	1.1248	20.25
4	1.0260	4.104	12	1.0816	12.98	20	1.1394	22.79
6	1.0397	6.238	14	1.0959	15.34			

A.9.

DENSITY AND VAPOUR PRESSURE OF WATER : 0° TO 35° C.

$t^{\circ} \text{C}$	DENSITY $d_4^{t^{\circ}}$	VAPOUR PRESSURE (MM. OF MERCURY)	$t^{\circ} \text{C}$	DENSITY $d_4^{t^{\circ}}$	VAPOUR PRESSURE (MM. OF MERCURY)	$t^{\circ} \text{C}$	DENSITY $d_4^{t^{\circ}}$	VAPOUR PRESSURE (MM. OF MERCURY)
0°	0.99987	4.58	12°	0.99952	10.48	24°	0.99733	22.18
1°	0.99993	4.92	13°	0.99940	11.19	25°	0.99708	23.54
2°	0.99997	5.29	14°	0.99927	11.94	26°	0.99682	24.99
3°	0.99999	5.68	15°	0.99913	12.73	27°	0.99655	26.50
4°	1.00000	6.09	16°	0.99897	13.56	28°	0.99627	28.10
5°	0.99999	6.53	17°	0.99880	14.45	29°	0.99597	29.78
6°	0.99997	7.00	18°	0.99862	15.38	30°	0.99568	31.55
7°	0.99993	7.49	19°	0.99843	16.37	31°	0.99537	33.42
8°	0.99988	8.02	20°	0.99823	17.41	32°	0.99505	35.37
9°	0.99981	8.58	21°	0.99802	18.50	33°	0.99473	37.43
10°	0.99973	9.18	22°	0.99780	19.66	34°	0.99440	39.59
11°	0.99963	9.81	23°	0.99757	20.88	35°	0.99406	41.85

A,10.

ATOMIC WEIGHTS

Aluminium	Al	26.98	Manganese	Mn	54.94
Antimony	Sb	121.76	Mercury	Hg	200.61
Arsenic	As	74.91	Molybdenum	Mo	95.95
Barium	Ba	137.36	Nickel	Ni	58.69
Beryllium	Be	9.03	Nitrogen	N	14.008
Bismuth	Bi	209.00	Oxygen	O	16.000
Boron	B	10.82	Palladium	Pd	106.7
Bromine	Br	79.92	Phosphorus	P	30.98
Cadmium	Cd	112.41	Platinum	Pt	195.23
Calcium	Ca	40.08	Potassium	K	39.10
Carbon	C	12.011	Selenium	Se	78.96
Cerium	Ce	140.13	Silicon	Si	28.09
Chlorine	Cl	35.46	Silver	Ag	107.88
Chromium	Cr	52.01	Sodium	Na	22.99
Cobalt	Co	58.94	Strontium	Sr	87.63
Copper	Cu	63.54	Sulphur	S	32.066
Fluorine	F	19.00	Tellurium	Te	127.61
Germanium	Ge	72.60	Thorium	Th	232.05
Gold	Au	197.0	Tin	Sn	118.70
Hydrogen	H	1.008	Titanium	Ti	47.90
Iodine	I	126.91	Tungsten	W	183.92
Iron	Fe	55.85	Uranium	U	238.07
Lead	Pb	207.21	Vanadium	V	50.95
Lithium	Li	6.940	Zinc	Zn	65.38
Magnesium	Mg	24.32	Zirconium	Zr	91.22

INDEX

Page numbers in bold-faced type refer to experimental procedures. Numbers followed by an asterisk * refer particularly to qualitative organic analysis. Numbers followed by a dagger † refer to apparatus with ground glass joints. Numbers followed by a double dagger ‡ refer to reaction mechanisms.

- Abbe refractometer, 1033
Absorption bands, 1134, 1135, 1136
 intensity of, 1135, 1138
Abstracting journals, 1126, 1127
Accidents, laboratory, 1130
Acetal, 320, 327
Acetaldehyde, 319, 324
Acetals, 320, 1061*
 reactions and characterisation of, 327*, 1061*
 table of, 329*
p-Acetamidobenzenesulphonamide, 1005, 1006
p-Acetamidobenzenesulphonyl chloride, 1005, 1006
Acetamide, 401, 402, 403
Acetanilide, 576, 577, 919
Acetates, 456*, 652*, 682*, 1073*
Acetic anhydride, 371, 372
Acetoacetic ester condensation, 475, 476‡, 477-481
 α -Acetoaminocinnamic acid, 908, 909
 α -Acetonaphthalene, 767
 β -Acetonaphthalene, 726, 731, 767, 924
Acetone, purification of, 171
 cyanohydrin, 348
 semicarbazone, 344
 test reagent, 884*
Acetonitrile, 407
Acetophenone, 725, 729, 730
 phenylhydrazone, 852
p-Acetotoluidide, 593, 605
Acetoxime, 343
Acetylacetone, 861‡, 862‡, 863
Acetylation, reductive, 749
 Thiele, 749
Acetyl chloride, 367
2-Acetylcyclohexanone, 862, 864
Acetylene, 245, 897
 reactions of, 245, 246
Acetylenic compounds, synthesis of, 467-469, 895-902
Acetylglycine, 909
Acetylmethylurea, 968, 969
Acetylsalicylic acid, 996
Acetyl-*o*-toluidide, 578
2-Acetylthiophene, 837
Acid anhydrides of aliphatic carboxylic acids, 371
Acid anhydrides—*cont.*
 reactions and characterisation of, 376*, 1062*
 table of, 378*
Acid anhydrides of aromatic carboxylic acids, 794
 table of, 796*
Acid chlorides of aliphatic acids, 367
 reactions and characterisation of, 369*, 1059*
 table of, 371*
Acid chlorides of aromatic acids, 791
 reactions of, 795*, 1059*
 table of, 796*
Acid hydrazides, 395*
Acrolein, 446
Acrylonitrile, 916, 1022
 reactions with, 914-917
Acrylic acid derivatives, 1016, 1023
Acylation of ketones, with acid anhydrides, 861‡
 with esters, 861, 862‡
Acyloins, 1067*, 1080‡, 1081‡
Adams platinum oxide catalyst, 470, 471, 1001
Adapters, 52
 expansion, 212†
 multiple, 51, 214†
 receiver, 219†
 reduction, 213†
 "swan neck," 215†
Addition of solids to stirred liquids, 68
Addition tubes, 51
 two-way, 51
 three-way, 51
Adipic acid, 489, 494
Adipic dialdehyde, 892
Adsorbents for chromatographic adsorption, 159, 160
Adsorption column, formation of, 160, 161
Air bath, 60, 221, 222
dl-Alanine, 427, 432
Alcoholic potassium hydroxide solution, 290*, 393*, 1064*
Alcoholic silver nitrate solution, 290*, 1059*
Alcohols, primary, 247
 secondary, 247
 tertiary, 248

- Alcohols, general reactions of, 1065* ;
see also Aliphatic alcohols and
 Aromatic alcohols
- Aldehydes, *see* Aliphatic aldehydes and
 Aromatic aldehydes
- Aldehydes and ketones, differentiation
 between, 1061*
 reactions of, 1060*, 1061*
- Aldose, 1069*
- Aliphatic acid amides, 401
 reactions and characterisation of,
 404*, 1074*, 1076*
 table of, 406*
- Aliphatic alcohols, 247, 248
 differentiation between primary,
 secondary and tertiary (Lucas test),
 261*
 reactions and characterisation of,
 260*, 1065*
 table of and derivatives of, 267*
- Aliphatic aldehydes, 318
 reactions and characterisation of,
 330*, 1060*
 table of and derivatives of, 334*
- Aliphatic amines, 413
 reactions and characterisation of,
 420*, 1072*, 1073*
 table of and derivatives of, 424*,
 661*
- Aliphatic carboxylic acids, 354
 reactions and characterisation of,
 360*, 1071*
 substituted, 427
 table of and derivatives of, 365*
- Aliphatic cyanides (nitriles), 407
 reactions and characterisation of,
 410*, 1075*, 1077*
 table of, 412*
- Aliphatic esters, 379
 hydrolysis of, 390*, 1063*, 1065*
 reactions and characterisation of,
 390*, 1062*, 1063*, 1065*
 table of, 396*
- Aliphatic ethers, 309
 cleavage of, 316*, 1067*, 1068*
 reactions and characterisation of,
 315*, 1067*, 1068*
 table of, 317*
- Aliphatic hydrocarbons, di- and poly-
 halogenated 292
 table of, 295*, 296*
- Aliphatic ketones, 335
 reactions and characterisation of,
 341*, 1061
 table of and derivatives of, 346*
- Aliphatic nitro compounds, 302
 reactions and characterisation of,
 531*, 1074*, 1076*
 table of, 532
- Aliphatic sulphonic acids, 557
- Aliphatic sulphur compounds, 496
- Alizarin, 981
- Alkyd resins, 1018
- Alkyl borates, 302
- Alkyl bromides, 270
- Alkyl chlorides, 270
- Alkyl fluorides, 272
- Alkyl halides, 270
 reactions and characterisation of,
 289*, 1059*
 table of and derivatives of, 293*
- Alkyl iodides, 271
- Alkyl mercuric halides, 291*
- Alkyl nitrites, 302
- Alkyl phosphates, 302
- Alkyl sulphates, 302
- Alkyl sulphites, 302
- Alkyl thiocyanates, 302
- S-Alkyl-*iso*-thiuronium picrates, 291*
- Allyl alcohol, 459
- Allyl bromide, 280
- Allyl chloride, 276
- Allyl cyanide, 464
- Allyl iodide, 285
- Aluminium alkoxides, reductions
 with, 882-886
- Aluminium amalgam, 198, 514
- Aluminium *tert.*-butoxide, 887
- Aluminium *iso*-propoxide, 883
 reductions with, 882†, 883-886
- Aluminon, 959, 960
- Amalgamated zinc, 198 ; *see also* under
 Clemmensen reduction
- Amides, 361* 1074*, 1075* ; *see also*
 Aliphatic acid amides and Aro-
 matic acid amides
- Amines, reactions of, 1072*, 1073* : *see*
also Aliphatic amines and Aromatic
 amines
- Amines, separation by Hinsberg's
 method, 650*
- Amino acids, 427
 benzoates of, 426*
 2 : 4-dichlorophenoxyacetates of,
 438*
 3 : 5-dinitrobenzoates of, 436*
 α -naphthylhydantoic acids of, 437*
 phtalyl derivatives of, 438*
p-toluenesulphonates of, 437*
 reactions and characterisation of,
 435*
 table of and derivatives of, 439*
- Aminoacetic acid, 427, 432
- p*-Aminoazobenzene, 622, 627
- p*-Aminobenzenesulphonamide, 1005,
 1006
- 2-(*p*-Aminobenzenesulphonamido)-
 pyridine, 1007, 1008
- p*-Aminobenzenesulphonylguanidine,
 1009
- p*-Aminobenzoic acid, 1000
- o*-Aminobenzyl alcohol, 878, 880

- α -Amino-*n* caproic acid, 427, 432
 4-Amino-3 : 5-diiodobenzoic acid, 973
p-Aminodimethylaniline, 621, 624, 625
 α -Amino- β -naphthol hydrochloride, 620, 623
 2-Amino-5-methylthiazole, 841
 2-Amino-*n*-octane, 413, 419
p-Aminophenol, 628, 630
p-Aminophenylacetic acid, 764
 2-Aminopyridine, 993, 1007
 2-Aminothiazole, 840
 Ammonia, 184; *see also* Liquid ammonia
 Ammoniacal cuprous chloride solution, 245*
 Ammoniacal silver nitrate solution, 245*, 320*, 1061*
 Ammonolysis, 401
 Ampoules, glass, 205
n-Amylamine, 413, 417
n-Amyl acetate, 383
n-Amyl alcohol, 247, 249
n-Amylbenzene, 511, 517
n-Amyl borate, 305
n-Amyl bromide, 279
iso-Amyl bromide, 279
n-Amyl chloride, 273
iso-Amyl chloride, 273
tert.-Amyl chloride, 275
n-Amyl cyanide, 407, 408
 Amylene, 239
n-Amyl fluoride, 272, 289
n-Amyl iodide, 288
n-Amyl nitrite, 302, 306
 2-*n*-Amylpyridine, 845
 3-*n*-Amylpyridine, 845
 4-*n*-Amylpyridine, 846
n-Amyl sulphite, 304
 Analyser, 503
 Anhydrides, tests for, 1062*
 hydroxamic acid test for, 1063*
 of dibasic acids, 371; *see also* Acid anhydrides
 Anilic acids, 376*
 Anilides, 290*, 361*, 362*
 Aniline, 559, 563, 564, 1162
 hydrochloride, 627
 Anion exchange resin, 915, 916
 as catalyst for cyanoethylation, 916
 Anisaldehyde, 690, 703
 Anisole, 665, 669
 Anthracene, 942, 943
 adduct with maleic anhydride, 942, 943
 purification of, 944
 Anthranilic acid, 754, 773, 880, 980
 Anthraquinone, 728, 740
 Anthraquinone- β -sulphonic acid, sodium salt, 981
 Anthrone, 729, 741
 Antimony, detection of, 1043*
 Anti-oxidants, 694
 Antipyrin, 998
 Apparatus for distillation and refluxing (typical assemblies), 88-89, 226†-228†
 Apparatus for hydrogenation at atmospheric pressure, 470-473
 for high pressure hydrogenation, 868-870
 for preparation of aliphatic ethers, 312
 for preparation of bromides, 281
 for preparation of iodides, 286
 for preparation of ketones (vapour catalyst method), 328
 for reaction in an inert atmosphere, 69
 for reactions in liquid ammonia, 897-898
 for reactions under pressure, 866-870
 for stirring, refluxing and addition of a liquid, 67, 1108, 1110
 for stirring, refluxing and addition of a solid, 68
 with interchangeable ground glass joints, 222-225, 226-228, 1109-1110
 Arndt-Eistert reaction, 902, 903, 904†, 908, 906
 Aromatic acid amides, 797
 hydrolysis of, 799*, 801*, 1076*
 reactions and characterisation of primary, 799*, 1074*, 1075*, 1076*
 table of primary, 800*
 reactions and characterisation of substituted, 801*, 1075*, 1076*
 table of substituted, 802*
 Aromatic acid chlorides, 791
 reactions and characterisation of, 795*, 1060*
 table of, 796*
 Aromatic alcohols, 811
 reactions and characterisation of, 817*, 1066*
 table of derivatives of, 818*
 Aromatic aldehydes, 689
 condensation reactions of, 706
 reactions and characterisation of, 720*, 1060*, 1061*
 table of and derivatives of, 723*
 Aromatic amines, 559
 acetylation of, 576
 benzoylation of, 582
 sulphonation of, 585
 reactions and characterisation of, 648*, 1072*, 1073*
 separation of, 650*
 table of and derivatives of, 656*, 659*, 661*

- Aromatic carboxylic acids, 751
 reactions and characterisation of, 777*, 1071*
 table of and derivatives of, 778*
- Aromatic diamines, 640
- Aromatic esters, 780
 hydrolysis of, 786*, 1063*, 1065*
 table of, 787*
- Aromatic ethers, 665
 cleavage of, 671*, 1068*
 reactions and characterisation of, 671*, 1067*, 1068*
 table of and derivatives of, 673*
- Aromatic hydrocarbons, 508, 1058, 1147
 characterisation of, 518*
 halogenation of, 533
 oxidation of side chains in, 520*
 nitration of, 520*, 523
 nitro derivatives of, 520*
 sulphonation of, 548
 table of and derivatives of, 521*
- Aromatic ketones, 725
 reactions and characterisation of, 741*, 1060*, 1061*
 table of and derivatives of, 743*
- Aromatic nitriles (cyanides), 803
 reactions and characterisation of, 805*, 1075*, 1077*
 table of, 806*
- Aromatic nitro compounds, 523
 reactions and characterisation of, 528*, 1074*, 1076*
 reduction to hydroxylamines, 528*, 1076*
 reduction with tin and hydrochloric acid, 529*, 1076*
 table of, 531*
- Aromatic peroxides and per-acids, 807
- Aromatic substitution, 524, 525
- Aromatic sulphonamides, 553
 reactions and characterisation of, 558*, 1076*, 1077*
 table of, 556*, 558*
- Aromatic sulphonic acids, 554
 compounds derived from, 820
 reactions and characterisation of, 552*, 1077*
 table of and derivatives of, 556*
- Aroylbenzoic acids, 519*
- Arsenic, detection of, 1043*
- Aryloxyacetic acids, 682*
- Asbestos-sodium silicate stoppers, 494
- Aspirin, 996
- Atomic weights, table of, 1163
- Atophan, 1010
- Aurin tricarboxylic acid, ammonium salt of, 959, 960
- Autoclaves, 866-870
- Auto-oxidation, 694
- Auxochromes, 1144, 1145, 1146
- Azelaic hemialdehyde, 892
- Azines, 341, 722*
- Azeotropic mixtures, 9
 breaking up of, 12
 of maximum b.p., 11
- Azeotropic mixtures of minimum b.p., 10
- Az lactone of α -acetylaminocinnamic acid, 908, 909
- Az lactone of α -benzoylaminocinnamic acid, 908, 910
- Az lactones, 907, 908, 909
- Azobenzene, 628, 631, 632
cis, 944, 945
 ultraviolet absorption maximum, 1148
- Azo compounds, 1075*
 table of, 1085*
- Azo dyestuffs, 620, 648, 979
 reduction of, 623, 624
- Azoxybenzene, 629, 631
- Azoxy compounds, 1074*
 table of, 1085*
- Barfoed's reagent, 454*
- Barbituric acid, 1001, 1002
- Bart reaction, 597, 617, 618
- Baths; *see* Heating baths and Cooling baths
- Beakers, 46
- Beckmann rearrangement, 729, 741
- Bending of glass tubing, 57
- Beilstein's "Handbuch," 1115-1126
- Beilstein's test, 289*
- Benedict's solution, 454*
- Benzalacetone, 709, 716
- Benzalacetophenone, 709, 718
- Benzal chloride, 534, 539
- Benzaldehyde, 689, 693
 auto-oxidation of, 694
 purification of, 694
- Benzal derivatives, 345*, 653
- α -Benzaldoxime, 711, 719
- β -Benzaldoxime, 711, 719
- Benzamide, 797
- Benzanilide, 582, 583
 hydrolysis of, 583*
- Benzene, removal of thiophene in, 172, 173
- Benzenesulphinic acid, 593, 607
- Benzenesulphonates, 422*, 650*, 652*
 1073*
- Benzenesulphonyl chloride, 820, 822,
 1073*
- Benzhydrol, 811, 813, 885
- Benzidine, 629, 633
- Benzidine rearrangement, 629†, 633
- Benzil, 709, 714, 715
 monohydrazone, 856
- Benzilic acid, 709, 715, 716
- Benzilic acid rearrangement, 709†, 715
 716

- α -Benzilmonoxime, 720
 β -Benzilmonoxime, 720
 Benzimidazole, 853
 Benzoates, 263*, 447*, 456*, 682*, 1073*
 Benzocaine, 1000
 Benzoic acid, 706, 711, 752, 755, 756
 Benzoic anhydride, 794
 Benzoin, 708, 714
 Benzoin condensation, 708†, 714
 α -Benzoin oxime, 958
 Benzonitrile, 609, 803
 hydrolysis of, 609*
 Benzophenone, 726, 733, 734
 Benzophenone oxime, 729, 741
 Beckmann rearrangement of, 729, 741
p-Benzoquinone, 745
 Benzoylacetone, 865
o-Benzoylbenzoic acid, 728, 739
 Benzoyl chloride, 791, 792
 Benzoyl glycine, 584
 Benzoyl peroxide, 807
 determination of, 809
 Benzoyl piperidine, 489, 492
 β -Benzoylpropionic acid, 728, 737
 β -Benzoylpropionitrile, 911, 912
 Benzoyl-*p*-toluidide, 582, 583
 Benzyl acetate, 780, 783
 Benzylacetophenone, 726, 734
 Benzyl alcohol, 706, 711, 811, 812, 884
N-Benzylamides, 394*
 table of, 395*
 Benzylamine, 394, 560, 569
 Benzylaniline, 572
 Benzyl chloride, 517, 534, 538, 539
 Benzyl cyanide, 752, 761
 hydrolysis to acid, 761
 hydrolysis to phenylacetamide, 762
 Benzylidene derivatives, 345*, 653*
 Benzyl magnesium chloride, 517
 Benzyl phthalimide, 560, 569
 Benzyl-sodium, 933†
S-Benzyl-*iso*-thiuronium chloride, 965,
 966
 salts, 363*, 554*
 Bisulphite compounds, 331*, 332*, 341,
 342, 1079*
 Biuret reaction, 442*
 Blanc chloromethylation reaction, 534,
 539, 540
 Boiling chips (stones), 4
 Boiling point, 2
 approximate, under reduced pres-
 sure, 106
 calculated at selected pressures, 2
 maximum, 10
 minimum, 9
 of mixtures, 8-12
 Boiling point, experimental determina-
 tion of, 83-86, 230, 1027
 by Emich's method, 86
 by Siwoloboff's method, 85
 Boiling-point - composition curves, 7-12
 Bond refractions, 1036
 Boring of corks, 55, 56
 Boron trifluoride, 183, 862, 864, 865
 Bouveault-Blanc reduction, 247, 249,
 250, 812, 832
 Bromination of aromatic hydrocarbons,
 533†
 Bromine, detection of, 1041*, 1042*,
 1043*, 1045*
 precautions in handling of, 278
 purification of, 189
 3-Bromo-4-acetaminotoluene, 593, 605
p-Bromoacetanilide, 577, 580
p-Bromoacetophenone, 726, 732
m-Bromo-*p*-acetotoluidide, 593, 605
 3-Bromo-4-aminotoluene, 593, 605
 hydrochloride, 605
p-Bromoanilides, 361*
p-Bromoaniline, 577, 580
o-Bromoanisole, 404
p-Bromobenzaldehyde, 689, 694, 696
 diacetate, 696
 Bromobenzene, 533, 535, 536
 α -Bromo-*n*-caproic acid, 427, 430
 Bromocresol purple, 990
 Bromoform, 297, 299
 α -Bromonaphthalene, 533, 537, 765
 β -Bromonaphthalene, 604, 767
m-Bromonitrobenzene, 533, 537
p-Bromonitrobenzene, 523, 527
 2-Bromopentane, 279
 3-Bromopentane, 279
p-Bromophenacyl bromide, 960, 961
p-Bromophenacyl esters, 362*
o-Bromophenol, 666, 679
p-Bromophenol, 666, 679
 Bromophenol blue, 989, 990
 4-Bromodiphenyl, 927, 928
p-Bromophenylacetic acid, 924, 925
p-Bromophenyl *iso*-thiocyanate, 644
p-Bromophenylurea, 645
 α -Bromopropionic acid, 427, 430
 2-Bromopyridine, 992, 993
N-Bromosuccinimide, 926, 927
o-Bromotoluene, 593, 603, 606
m-Bromotoluene, 593, 605
p-Bromotoluene, 593, 602
 Bromural, 999
 α -Bromo-*iso*-valerylurea, 999
 Brucina, 506
 recovery of, 507
 Bucherer hydantoin synthesis, 843†, 844
 Bucherer reaction, 561†, 568, 569
 Bumping of liquids, 3, 4
 devices for preventing, 4, 5
 Burns, 1131
 Butadiene, 1022
 polymers, 1021
 1 : 4-Butanediol, 250
o-n-Butoxynitrobenzene, 665, 670

- n*-Butyl acetate, 380, 382
 hydrolysis of, 390*
sec-Butyl acetate, 382
tert-Butyl acetate, 380, 383, 384
n-Butylacetylene, 896, 899
n-Butylbenzene, 508, 510, 511, 516, 934, 935
tert-Butylbenzene, 509, 513
n-Butyl benzoate, 782
n-Butyl borate, 302, 304
n-Butyl bromide, 270, 277, 280, 281
iso-Butyl bromide, 282
sec-Butyl bromide, 270, 278
n-Butyl chloride, 270, 273
iso-Butyl chloride, 270, 274
sec-Butyl chloride, 270, 273
tert-Butyl chloride, 270, 276
n-Butyl cyanide, 407, 408
n-Butyl formate, 380, 384
n-Butyl glyoxylate, 951
n-Butyl iodide, 271, 284, 285
iso-Butyl iodide, 272, 285
sec-Butyl iodide, 285, 288
n-Butyl-lithium, 928, 929, 932
n-Butyl magnesium bromide, 247, 248, 253, 256, 257, 359
sec-Butyl magnesium bromide, 354, 358
n-Butylmalonic acid, 488
n-Butyl mercaptan, 497
n-Butyl nitrite, 306
n-Butyl oleate, 388
n-Butyl phosphate, 302, 304
tert-Butyl propionate, 384
n-Butyl sulphite, 302, 303
n-Butyl thiocyanate, 306
n-Butyl-*p*-toluenesulphonate, 821, 825
n-Butyraldehyde, 318, 320, 322
iso-Butyric acid, 354, 355, 356
 Butyrolactone, 859
 Butyrophenone, 726, 732
n-Butyryl chloride, 367, 368
- Calcium chloride, as desiccant, 42, 140
 tube, 52
 Calcium sulphate, as desiccant, 41, 141
 Calibration curve of thermometer, 229
 Calibration of thermometers, 72-75
 reference substances for, by boiling
 point method, 74
 reference substances for, by melting
 point method, 73
 Camphor method, for molecular weights,
 1037
 Cannizzaro reaction, 706†, 711, 712, 811,
 812, 832
 crossed, 811, 812
n-Caproamide, 401, 404
n-Caproic acid, 484, 486
n-Caproic anhydride, 371, 374
n-Capronitrile, 407, 408
- 2-Carboethoxycyclopentanone, 856, 857
 β -Carboethoxy- $\gamma\gamma$ -diphenylacetic acid,
 919, 920
 Capillary, for distillation, 103, 104
 melting point tubes, 75, 76
 Carbanilide; *see sym*-Diphenylurea
 Carbitol, 171, 444
 butyl, 171, 444
 methyl, 171, 444
 derivatives of, 265*
 Carbohydrates, 449
 reactions and characterisation of,
 453*, 455*
 table of and derivatives of, 457*
 Carbonation of Grignard reagent, 354,
 358, 359, 752, 756
 Carbonation of lithium derivatives, 929,
 930, 933
 Carbon and hydrogen, detection of,
 1038*
 Carbon dioxide, 184, 358, 359
 solid; *see* Dry Ice
 Carbon disulphide, 767
 purification of, 175
 Carbon monoxide, 185, 1003, 1004
 Carbon, decolourising, 127, 128
 Carbon tetrachloride, 733, 815
 drying of, 734
 purification of, 176
 Carbonyl chloride, 185
 Carborundum chips, 4
 Carboxylic acids, equivalent weights of,
 1071*
 reactions of, 360*, 1071*; *see also*
 Aliphatic carboxylic acids and Aro-
 matic carboxylic acids
o-Carboxyphenylacetoneitrile, 753, 772
 Carbylamine test, 420*, 648*
 Catalytic reduction, with Adams' plat-
 inum oxide catalyst, 470
 with copper-chromium oxide, 873
 with Raney nickel, 566
 Cation exchange resin, for esterification,
 381, 387, 388
 Cellosolve, 170, 265, 444
 butyl, 170, 444
 methyl, 170, 444
 Cellulose, 458*
 Chalkone, 709, 718
 Charcoal, decolourising, 127, 128
 Chloral hydrate, 1011
 reactions of, 298*
 Chloramine-T, 820, 824
 Chlorine, 183
 detection of, 1041*, 1042*, 1043*,
 1045*
 water, equivalent reagent, 1042*
p-Chloroacetophenone, 733
o-Chloroaniline, 565
p-Chloroaniline, 566
 Chlorobenzene, 533, 535, 592, 601

- m*-Chlorobenzoic acid, 929, 932
o-Chlorobenzoic acid, 751, 758, 759
p-Chlorobenzoic acid, 751, 760
p-Chlorobenzoic anhydride, 794
m-Chlorobromobenzene, 604
o-Chlorobromobenzene, 593, 603
 2-Chlorobutadiene, 1021
 polymers of, 1021
 2-Chlorodiphenyl, 927, 928
 Chloroform, 297
 purification of, 176
 1-Chloro-2-hexanone, 936, 937
 Chloromethylation, 534, 539, 540
 α -Chloromethylnaphthalene, 540, 752
m-Chloronitrobenzene, 592, 601
 2-Chloropentane, 274
 3-Chloropentane, 274
 2 : 2-*bis* (*p*-chlorophenyl)-1 : 1 : 1-tri-
 chlorethane, 1011, 1012
 Chlorosulphonic acid, 543, 822, 1005, 1006
 purification of, 1006
 Chlorosulphonylation, 543*
o-Chlorotoluene, 592, 601
p-Chlorotoluene, 591, 592, 600
 Cholestenone, 887, 888, 944
 Chromatogram, 157
 liquid, 163
 Chromatographic adsorption, 156-163
 adsorbents for, 159, 160
 apparatus for, 158-163
 applications of, 605, 944-946
 eluent for, 161, 162
 formation of adsorption column for,
 160, 945
 selection of solvents for, 161
 uses of, 161
 "Chromic acid" cleaning mixture, 53
 Chromophores, 1144-1146
 three conjugated, 1146
 two conjugated, 1146
 typical single, 1145
 Chrysoidine, 620, 623
 Cinnamic acid, 707, 712, 1113
 reduction to dihydrocinnamic acid,
 474, 768, 769
 cis and *trans* isomers, ultraviolet
 absorption maxima, 1148
 Claisen aldol condensation, 710†, 718
 Claisen condensation, 477, 861†, 862†,
 863-865
 Claisen flask, 47, 103
 with fractionating side arm, 47, 116,
 117
 Claisen-Schmidt reaction, 709, 710†,
 716-718
 Class reactions, 1057-1081
 summary of, 1079, 1080
 Cleaning of glassware, 53, 54
 Clemmensen reduction, 238, 510, 515,
 516, 728, 738
 Cold finger, 92
 Condenser, air, 47
 Allihn, 47
 coil, 48, 217*
 Dewar, 49
 double surface, 48, 216*
 Friedrich, 48, 216*
 Hahn, 885
 Condenser, Liebig, 47, 216*
 West, 47, 215*, 216*
 Conglomerate, 25
 Congruent melting point, 29
 Congo red, 979
 Conjugate solutions, 17-20
 Consolute temperature, 17, 18, 19, 20
 Continuous extraction, of liquids by
 solvents, 152-154
 of solids by solvents, 153, 154, 222†,
 223†
 of steam distillates by solvents, 224†,
 225†
 Continuous steam distillation, 147, 148
 Cooling baths, 61
 Cooling curve method, 26
 Copper bronze, activated, 193
 Copper-chromium oxide catalyst,
 for aldehyde synthesis, 318, 321
 for hydrogenation, 872, 873
 hydrogenolysis with, 872†
 Copper phthalocyanine, 983
 Copper powder, 192
 Copper sulphate, as desiccant, 40, 41
 Cork stoppers, 55
 boring of, 56
 Cotton wool (absorbent), 143
 Coumarin, 707, 713
p-Cresol, 595, 614, 664, 667
o-Cresol red, 989, 990
 Critical solution temperature, 17-20
 application to determination of water
 in alcohols, 20, 21
 influence of added substances upon, 20
 Crotonaldehyde, 460
 Crotonic acid, 463, 464
 Crotyl alcohol, 882, 883
 Crystal violet, 982
 Crystallisation, *see* Recrystallisation
 Cumene, 509, 512
 Cupferron, 957
 Cuprous bromide, 191, 602, 603, 604
 solution of, 602
 Cuprous chloride, 190, 600, 601
 Cuprous cyanide, 191, 192, 607, 608, 609
 solution of, 607
 Cuts, 1132
 Cutting of glass tubing, 57
 Cyanoacetamide, 428, 434
 Cyanoacetic acid, 428, 433
 Cyanoethylation, 914, 915†, 916, 917
 Cyanohydrins, 347, 348
 β -Cyanopyridine, 850
 Cyclobutanecarboxylic acid, 857, 858

- Cyclobutane-1 : 1-dicarboxylic acid, 857, 858
 1 : 2-Cyclohexanedione, 974, 975
 1 : 4-Cyclohexanedione-dioxime, 974, 975
 Cycloheptanone, 946, 947
cis-1 : 2-Cyclohexanediol, 894, 895
trans-1 : 2-Cyclohexanediol, 893, 896
 Cyclohexanone, 335, 337
 oxime, 343
 phenylhydrazone, 342, 343
 purification via bisulphite compound, 342
 Cyclohexene, 243
 ozonolysis of, 892
 Cyclohexyl acetate, 380, 385
 Cyclohexyl bromide, 277
 Cyclohexyl carbinol, 247, 252
 Cyclohexyl chloride, 270, 275
 Cyclohexyl ethyl ether, 310, 314
 Cyclohexyl formate, 385
 Cyclohexyl iodide, 284, 288
 Cyclohexyl magnesium chloride, 247, 252
 α -Cyclohexylphenylacetonitrile, 897, 902
 Cyclopentanol, 255
 Cyclopentanone, 336, 340, 489, 493
 Cyclopentyl bromide, 277
 Cyclopentyl chloride, 276
 Cyclopentyl iodide, 285
- Dalton's law of partial pressures, 12
 Darzens glycidic ester condensation, 906 $\frac{1}{2}$, 907
 Decolourising carbon, 127, 128
 animal charcoal, 128
 Darco, Norit, Nuchar, 128
 D.D.T., 1011, 1012
 Dean and Stark apparatus, modified, 429
n-Decane, 237, 940
 Decane-1 : 10-dicarboxylic acid, 904, 905
 Dehydrogenation, 942, 943, 949
 agents, 948
 catalysts, 948
 of hydroaromatic compounds, 947-949
 of tetralin, 949
 of α -tetralone, 947
 Deliquescence, 43
 Densities and percentage compositions of various solutions, 1151-1161
 Density, determination of a liquid, 1029
 Derivatives, preparation of, 1027, 1081
 requirements of a satisfactory, 1081
 Dephlegmator, 92
 Desiccators, 137
 "vacuum," 137, 138, 139
 Detergents, 445
- Diacetone alcohol, 351, 352
 Diacetyl-*o*-toluidine, 576, 578
 Diallyl, 466
 Dialkylanilines, pure, from commercial products, 572
 Di-*n*-amyl ether, 313
 Di-*iso*-amyl ether, 313
 Di-*n*-amyl ketone, 340
 Diazoaminobenzene, 622, 627
 Diazoamino-aminoazo rearrangement, 622 $\frac{1}{2}$, 626, 627
 Diazo ketone, 903, 904, 905
 Diazomethane, 946, 967, 968, 969-972
 determination of, 972
 methylation with, 973
 precautions in the use of, 968, 969
 ring enlargement with, 946 $\frac{1}{2}$, 947
 Diazonium fluoroborates, 594, 610, 611, 612, 613
 Diazonium salts, 590 *et seq.*
 caution in preparation of, 597
 reduction of, 635
 solid, 597, 598
 Diazotisation, 590, 598, 599, 600, 601, 602, 603, 604, 617, 759, 978
 Dibenzalacetone, 709, 717
 Dibenzyl ketone, 735
 Dibenzoyl peroxide, 807
m-Dibromobenzene, 604
p-Dibromobenzene, 536
 1 : 4-Dibromobutane, 271, 280, 283
 $\alpha\beta$ -Dibromoethylbenzene, 896, 900
 Dibromofluorescein, 985, 986
 diacetate, 987
 1 : 6-Dibromohexane, 271, 280, 283
 1 : 4-Dibromopentane, 271, 280, 283, 489, 492
 Di-*n*-butyl acetal, 320, 327
 Di-*n*-butylamine, 414, 419
 β -Di-*n*-butylaminopropionitrile, 915, 917
 Di-*n*-butylaniline, 572
 Di-*n*-butyl cadmium, 935, 936
 Di-*n*-butyl carbinol, 248, 256
 Di-*n*-butyl cyanamide, 414, 419
 Di-*n*-butyl disulphide, 496, 498
 Di-*n*-butyl ether, 309, 311
 purification of, 165
 as a solvent in the Grignard reaction, 254
 Di-*n*-butyl *d*-tartrate, 951, 952
 Dichloramine-T, 820, 823
 Dichloroacetic acid, 427, 431
 1 : 4-Dichlorobutane, 270, 275
 2 : 4-Dichlorophenoxyacetates, 438*
 1 : 5-Dicyanopentane, 493
 Dicyclohexyl, 21, 470
 Dieckmann reaction, 856, 857
 Diels-Alder reaction, 941, 942 $\frac{1}{2}$, 943
 Diene synthesis, 941, 942, 943
 β -Diethylaminopropionitrile, 915, 917

- Diethylaniline, 562, 573
 purification of, 562, 573
- Diethylbarbituric acid, 1002, 1003
- Diethyl carbonate, 250, 259, 785
 purification of, 259, 785
- Diethyl disulphide, 496, 498
- Diethyleneglycol, 516, 1064, 1065
- Diethyleneglycol, monoalkyl ethers of, 171, 444
 dialkyl ethers of, 171, 444
- Diethyl ether, 309, 310
 precautions in the use of, 165
 preparation of absolute, 163-165
 removal of peroxides in, 163, 164
- Diethyl fumarate, 913
- NN*-Diethylhydrazine, 880
- Diethyl ketone, 335, 338
- Diethyl maleate, 381, 388
- Diethyl malonate, 483, 484, 1001
 alkylation of, 483†
 applications, of 483, 484
- Diethylnitrosamine, 426
- Diethyl oxalate, 381, 386
- Diethyl sebacate, 381, 387
- Diethyl succinate, 386
- Diethyl sulphate, 303
- 4 : 4'-Difluorodiphenyl, 612
- Di-*n*-hexyl ether, 313
- Di-*n*-hexyl sulphide, 496, 498
- Dihydrocinamic acid; *see* Hydrocinamic acid
- 2 : 5-Dihydroxyacetophenone, 664, 677
- 2 : 4-Dihydroxybenzaldehyde, 690, 702
- 1 : 4-Diiodobutane, 272, 284
- 1 : 6-Diiodohexane, 284
- 1 : 5-Diiodopentane, 284
- 1 : 3-Diketohydrindene, 993, 994
- Dimedone derivatives, 332*, 721*, 963*
- Dimethones, 333*
- ββ-Dimethylacrylic acid, 460
- Dimethylamine hydrochloride, 414, 416
- Dimethylaminomethylindole, 1012, 1013
- β-Dimethylaminopropiophenone hydrochloride, 910, 911
- Dimethylaniline, 562, 572
 pure, from commercial product, 573
- 2 : 3-Dimethylanthraquinone, 942, 943
- 2 : 3-Dimethyl-1 : 3-butadiene, 467, 942, 943
- Dimethyl *n*-butyl carbinol, 248, 257
- 5 : 5-Dimethyl-1 : 3-cyclohexanedione, 332, 963
- Dimethyldihydroresorcinol, 332, 963
- 2 : 4-Dimethyl-3 : 5-dicarbethoxy-pyrrole, 839
- 3 : 3'-Dimethyldiphenyl, 596, 616
- Dimethyl ethyl carbinol, 260
- Dimethyl ethynyl carbinol, 467, 468
- ββ-Dimethylglutaric acid, 876
- Dimethylglyoxime, 952
- Dimethyl hexadecane-1 : 16-dicarboxylate, 938, 940
- 5 : 5-Dimethylhydantoin, 843
- Dimethylnitrosamine, 426
- Dimethyl *n*-propyl carbinol, 248, 258, 259
- 3 : 5-Dimethylpyrazole, 842
- 2 : 5-Dimethylpyrrole, 839
- Dimethyl sebacate, 938, 939, 940
- as*-Dimethylsuccinic acid, 490, 495
- Dimethyl sulphate, 303
 precautions in use of, 669
 purification of, 804
- 4 : 5-Dimethyl-Δ⁴-tetrahydrophthalic anhydride, 942, 943
- 2 : 4-Dimethylthiazole, 841
- 2 : 5-Dimethylthiophene, 836
- Di-β-naphthol, 668
- 2 : 4-Dinitroaniline, 638
- 3 : 5-Dinitroaniline, 918, 919
- o*-Dinitrobenzene, 595, 612
- m*-Dinitrobenzene, 523, 526
- p*-Dinitrobenzene, 595, 613
- 3 : 5-Dinitrobenzoates, 262*, 436*, 682*
- 3 : 5-Dinitrobenzoic acid, 753, 770
- 3 : 5-Dinitrobenzoyl chloride, 262*, 974
- 2 : 2'-Dinitrodiphenyl, 524, 527
- 2 : 4-Dinitrophenylacetic acid, 751, 758
- 2 : 4-Dinitrophenol, 666, 678
- 2 : 4-Dinitrophenyl derivatives, 654*
- Di-*o*-nitrophenyl disulphide, 585, 587
- 2 : 4-Dinitrophenylhydrazine, 635, 638, 1060*
 reagent, 344, 884, 1061*
- 2 : 4-Dinitrophenylhydrazones, 332, 342*, 344*, 722*, 1061*
- 2 : 4-Dinitrophenylsulphides, 500*
- 2 : 4-Dinitrophenylsulphones, 500*, 501*
- 3 : 5-Dinitrothiobenzoates, 501*
- 2 : 4-Dinitrotoluene, 523, 527
- Dioxan, 923
 purification of, 177
- Diphenic acid, 596, 617, 755, 768
- Diphenylacetic acid, 754, 773
- γγ-Diphenylbutyric acid, 920
- Diphenylcarbazide, 954
- Diphenylcarbazone, 955
- Diphenylcarbinol, 811, 812
- sym.*-Diphenylhydrazine, 628, 629, 632
- Diphenylene, 629, 634
- Diphenyliodonium iodide, 535, 542
- Diphenylmethane, 509, 513, 514
- Diphenylnitrosamine, 562, 572
- Diphenylthiocarbazine, 955, 956
- Diphenylthiocarbazono, 955, 956
- sym.*-Diphenylurea, 645, 646
- sym.*-Diphenylthiourea, 642
- Di-*n*-propylaniline, 572
- Di-*iso*-propyl ether, purification of, 165
- Di-*n*-propyl ketone, 340

- Di-*iso*-propyl ketone, 477, 480
 Di-*n*-propyl sulphide, 496, 497
 2 : 2'-Dipyridyl, 992, 993
 Disaccharides, 451, 453
 Dismutation, 706, 832
 Disproportionation, 706, 832
 Distillation, assemblies of apparatus for, 86-88
 Distillation, flash, 89
 theory, 1
 with superheated steam, 15
 see Fractional distillation
 Distillation heads, 213*, 214*
 Distillation of solids under reduced pressure, 106, 107
 Distillation of volatile solvents from solutions, 86-89, 105
 fire hazards attending, 90
 Distillation under diminished pressure, 103-108
 manometers for, 104, 112-114
 manostats for, 114-116
 preparation of capillaries for, 103
 refinements in technique of, 116-119, 1110
 Distilling flasks, 47
 Distribution coefficient, 44
 law, 44
 Disulphides, 1078*
 dialkyl, 496, 498
 Dithizone, 955
 Di-*p*-tolyl ketone, 930, 931
 Dixon gauze rings, 97
n-Dodecane, 237
n-Dodecyl bromide, 282
n-Dodecyl chloride, 275
n-Dodecyl *p*-toluenesulphonate, 825
 Doebner reaction, 463, 465, 710, 711†, 719
 Drierite, 41, 141, 142
 Drikold, 39, 61, 185
 Dropper pipette, 1102
 Dry Ice, 39, 61, 185
 Drying agents, 140-143
 common, for organic compounds, 140-143, 144
 comparison of, 42
 for vacuum desiccators, 138
 theory of the action of, 39
 Drying by distillation, 143, 144
 Drying by hydrolysis, 144
 Drying of glassware, 53, 54
 Drying of liquids or of solutions of organic compounds in organic solvents, 139-143
 Drying of recrystallised material, 132
 Drying of solid organic compounds, 136, 137
 Drying oils, 445, 446
 Drying pistol (Abderhalden), 139
 Efflorescence, 43
 Electric furnace, tube, construction of, 338
 Electric heating mantles, 221, 222
 Electric hot plate, 61
 Electrolysis cell, 939
 Electrolytic (anodic) syntheses, 937-941
 Electronic spectra, *see* Ultraviolet and visible spectra.
 Eluents, 161
 Elution, 157, 161, 162
 Enols, 475, 684, 1089*, 1090*, 1147
 table of, 688*
 Eosin, 985, 986
 sodium salt of, 986
 Epoxidation of ethylenic compounds, 893-895
 Erlenmeyer azlactone synthesis, 907, 908†, 909, 910
 Equilibrium diagrams, 22-26
 construction of, 26-29
 Equivalent weight of an acid, 1071
 Ester-amides, table of, 425*
 Esterification, 379†-382, 1000, 1001
 Esters, hydroxamic acid test for, 1062*, 1063*
 of inorganic acids, 302, 1078
 of phenols, hydrolysis of, 1065*
 saponification (quantitative), 392*, 1065*
 saponification equivalent of, 392*, 1065*
 Esters, simple, identification of acidic components, 393*, 1063*, 1064*
 identification of alcohol component, 393*, 1063*, 1064*
 Ether still, 165
 Ethers, reactions of, 315*, 671*, 1067*, 1068* ; *see* also under Aliphatic ethers and Aromatic ethers.
p-Ethoxyphenylurea, 646
p-Ethoxypropionitrile, 915, 916
 Ethyl acetate, 383
 purification of, 174
 Ethyl acetoacetate, 475, 476†, 477
 keto-enol equilibrium of, 475, 1148
 purification of, 478
 reactions of, 478*
 ultraviolet spectrum in various solvents, 1147
 Ethyl alcohol, absolute, 166
 determination of water in, 21
 preparation of absolute from rectified spirit, 166, 167
 preparation of "super-dry." 167-169
 Ethyl *p*-aminobenzoate, 1000, 1001
 Ethylaniline, 570, 571
 Ethylbenzene, 510, 515, 516, 934, 935
 Ethyl benzoate, 782

- p*-Ethylbenzyl chloride, 540
 Ethyl benzyl ketone, 727, 735
 Ethyl bromide, 279
 Ethyl bromoacetate (mono), 429
 Ethyl α -bromopropionate, 430
 Ethyl *n*-butylacetoacetate, 482
 Ethyl *n*-butylmalonate, 483, 485
 Ethyl *S*-*n*-butyl xanthate, 496, 499
 Ethyl *n*-butyrate, 383
 Ethyl *isobutyrylisobutyrate*, 477, 479
 Ethyl chloroacetate, 907
 Ethyl cinnamate, 710, 718
 Ethyl cyanoacetate, 428, 433
 alkylation of, 484†
 condensation with ketones, 496
 Ethyl α -cyano- $\beta\beta$ -dimethylacrylate, 495
 Ethyl cyclopropanecarboxylate, 390
 Ethyl diethylmalonate, 1002
 Ethyl α -1-epoxycyclohexyl acetate, 907
 Ethyl *S*-ethyl xanthate, 496, 499
 Ethyl formate, 385
 purification of, 257
 Ethyl *n*-hexyl ether, 309, 313
 Ethyl 1-hydroxycyclohexyl acetate, 875
 Ethyl iodide, 287
 Ethyl α -naphthoate, 781, 785
 Ethyl α -naphthylacetate, 905
 Ethyl nicotinate, 849
 Ethyl *p*-nitrobenzoate, 1001
 Ethyl orthoformate, 318, 323
 Ethyl phenylacetate, 780, 783
 Ethyl β -phenylethyl ketone, 727, 736
 Ethyl β -phenyl- β -hydroxypropionate,
 874
 Ethyl phenylmalonate, 1003
 Ethylphenylnitrosamine, 570
 Ethyl phenyloxalacetate, 1003, 1004
 Ethyl *n*-propylacetoacetate, 475, 481
 Ethyl propane-1 : 1 : 2 : 3-tetracarboxy-
 late, 912, 913
 Ethyl propane-1 : 1 : 3 : 3-tetracarboxy-
 late, 912, 914
 Ethyl *isopropylidene* cyanoacetate, 490,
 495
 Ethyl *n*-propylmalonate, 486
 Ethyl *n*-propyl ketone, 340
 4-Ethylpyridine, 844
 Ethyl 2-pyridylacetate, 931, 932
 Ethyl salicylate, 783
 Ethyl sulphite, 304
 Ethyl *n*-valerate, 382, 389
 Ethyl vinylacetate, 382, 389
 Ethylenediamine-adipic acid polymer,
 1019, 1025
 Ethylene glycol, 285
 Ethylene glycol, monoalkyl ethers of,
 170, 444
 dialkyl ethers of, 171, 444
 Ethylene oxide, 247, 253, 444
 Ethylenic hydrocarbons, 239, 1059
 reactions and characterisation of,
 241*, 1058*
 table of, 242*
 Ethylenic linkages, determination of
 number of, 809
 1-Ethynylcyclohexanol, 896, 901
 Eutectic, 29, 21
 Eutectic mixture, 25
 Eutectic point, 25, 29, 31
 Eutectic temperature, 24, 25
 Evaporation of the solvent, 135, 136
 Expansion adapters, 213†
 Extinction, 1135
 Extraction by chemically active sol-
 vents, 151
 Extraction of steam distillates by sol-
 vents, 225†
 Extraction thimble, 153
 Extraction with solvents, continuous, of
 liquids, 152, 153, 223†, 224†
 continuous, of solids, 153, 154, 222†,
 223†
 technique of, 149-154
 theory of, 44, 45
 Eye accidents, 1132
 Fats, 444
 saponification of, 445
 Fehling's solution, 330*, 454*, 1061*
 Fenske helices (rings), 97, 98
 Fieser's solution, 186
 Filtration of hot solutions, 49, 126
 Filtration with suction, 50, 130, 31
 of corrosive liquids, 135
 of small volumes, 133, 1107
 miscellaneous apparatus for, 133, 134
 with "Buechner stable filter," 134
 with "Mini filter," 134
 Fire hazards, prevention of, 90
 Fires, 1132, 1133
 First aid, 1130-1133
 Fischer indole synthesis, 851†, 852
 Fischer-Speier esterification, 379†, 380†,
 382, 383, *et seq.*
 Flasks, 46, 212†, 1101
 Buchner (or filter or suction), 50, 134
 Claisen, 47, 103 213†
 Claisen, with fractionating side arm,
 47, 116, 117
 distilling, 47, 213†
 Grignard, 51
 multi-necked, 51, 67, 68, 69 215†
 for distilling solids under reduced
 pressure, 107
 Widmer, 117
 Fluoboric acid, 611
 Fluorescein, 985, 986
 test paper, 1042*
 Fluorine, detection of, 1043*

- p*-Fluoroanisole, 594, 611
 Fluorobenzene, 594, 609
p-Fluorotoluene, 594, 617
 Fluted filter paper, preparation of, 127
 Formaldehyde, 318
 tests for, 325*
 Formalin, 319
 Formamide, purification of, 179
 Formyl derivatives, 655*
 Fractional distillation, 5, 91, 231
 efficient units for, 97-102
 improved apparatus for, 94-102, 1110
 separation of benzene and toluene by, 231
 simple apparatus for, 93
 still-heads for, 97, 102, 217†
 theory of, 5, 96-98
 Fractional distillation under diminished pressure, 108-110, 119, 1110
 flasks for, 47, 116, 117, 119
 receivers for, 108, 109, 118, 119, 219†
 Fractionating columns, 8, 9
 all-glass Dufton, 91, 96, 217†
 desiderata of, 94-96
 efficiency of, 94
 electrically-heated jackets for, 97, 98, 99, 100
 Hempel, 91, 218†
 hold-up of, 95
 modified Hempel, 92
 notes on operation of precision, 100
 packings for, 91, 92, 96, 97, 118
 Stedman type, 219†
 still-heads for, 102
 thermal insulation for, 93, 95
 Vigreux, 91, 217†
 Widmer, 96, 97, 219†
 Free radicals (aryl), 927, 951
 Freezing, theory of, 21
 Freezing mixtures, 61, 62
 Freezing point, 22
 determination of, 80
 of mixtures, 26
 Friedel-Crafts reaction: alkylation, 508, 509†, 512, 513, 515
 acylation, 725, 726†, 728, 729-734, 811, 815
 Fries reaction, 664†, 665†, 676, 677, 727
 Fructose, 449, 451, 455
 Fuchsin aldehyde reagent, 330*, 1061*
 Fumaric acid, 461, 463
 Functional groups, reactions for, 1057-1081
 Funnels, 49
 Buchner, 51
 dropping, 49
 Hirsch, 51
 hot water, 49
 sintered glass, 50, 133
 Funnels—*cont.*
 "slit sieve," 51, 133
 separatory, 49, 221†
 Furfural, 832, 833
 purification of, 833
 2-Furfuralacetone, 833
 Furfuryl acetate, 388
 Furfuryl alcohol, 832
 Furil, 835
 Furoic acid, 832
 Furoin, 835
 Furylacrylic acid, 834
 Fusible metal alloys, 59
 Fusion with caustic alkali, 552*, 664, 667, 668
 Fusion with soda lime, 777*, 1038*
 Gabriel synthesis, 559, 560†, 569
 Galactose, 1070
 oxidation to mucic acid, 1070*
 Gas absorption traps, 71
 Gattermann aldehyde reaction, 689, 690†, 701-703
 Adams modification of, 690, 701, 702
 Gattermann reaction, 593, 606
 Gattermann-Koch, reaction 689†, 697, 698
 Girard's reagents "T" and "P", 976, 977, 978
 Glass septum, 222†
 Glass tubing, cutting and bending of, 57
 Glass wool, purification of, 142, 166
 Glucose, 449, 451, 455
 α -Glucose penta-acetate, 451
 β -Glucose penta-acetate, 452
 Glutaric acid, 489, 491, 493, 912, 914
 Glutaronitrile, 407, 409
 Glyceride, 391
 Glycerol, anhydrous, 829
 Glycine, 427, 432
 Glycogen, 458
 Glyptal resins, 1018
 formation of, 1023
 Gomberg-Hey reaction, 927, 928†
 Gramme, 1012, 1013
 Grignard reaction, 237, 240, 247, 248†, 249†, 253, 255-259, 358, 359, 394, 511, 516, 517, 752, 756, 757, 765, 781, 811, 813-815
 Grignard reagent, test for, 241*
 Ground glass joints; *see* Interchangeable ground glass joints
 Guanidine, 1009
 Guareschi reaction, 876†, 877
 Haloform reaction, 297
 Halogenated aromatic hydrocarbons, 533
 reactions and characterisation of, 542*
 table of and derivatives of, 545*

- Halogen carriers, 533
 Halogen compounds, reaction with alcoholic silver nitrate, 1059*
 reaction with sodium iodide in acetone, 1059*, 1060*
 Halogens, detection of, 1041*, 1042*, 1043*, 1045*
 Haworth reaction, for synthesis of polynuclear hydrocarbons, 726, 728†, 737, 738
 Heating baths, 57
 air, 60
 constant temperature, 60
 fusible metal, 59
 oil, 58
 sand, 59
 water, 57, 58
 Heating mantles, electric, 221, 222
 Hell-Volhard-Zelinsky reaction, 427†, 429, 430
 Height equivalent per theoretical plate (H.E.T.P.), 95
n-Heptaldehyde, 251
n-Heptaldoxime, 348
n-Heptane, 238
 1-Heptene, 240
n-Heptoic acid, 354, 356
n-Heptoic anhydride, 371, 374
n-Heptyl alcohol, 247, 251
n-Heptylamine, 413, 418
n-Heptyl chloride, 275
n-Heptyl iodide, 288
n-Hexacosane, 938, 941
 Hexadecane-1 : 16-dicarboxylic acid, 938, 940
n-Hexadecyl bromide, 283
 Hexadiene-1 : 5, 466
n-Hexaldehyde, 318, 321 (catalyst method), 323, 324
 Hexamethylene dibromide, 271, 280, 283
 Hexamethylene glycol, 251, 873, 879
 Hexamethylenetetramine (hexamine), 319, 326, 692, 700
n-Hexane, 237
 1 : 6-Hexanediol, 251, 873, 879
n-Hexyl alcohol, 247, 253
 dehydrogenation of, 322
 β-*n*-Hexylacrylic acid, 465, 466
n-Hexylbenzene, 510, 516
n-Hexyl bromide, 282
n-Hexyl chloride, 270, 274
n-Hexyl cyanide, 409
n-Hexyl fluoride, 288, 289
n-Hexyl iodide, 288
n-Hexyl magnesium bromide, 237
n-Hexyl mercaptan, 496, 497
n-Hexyl nitrite, 306
 1-Hexyne, 896, 899
 Hinsburg method for separation of amines, 650
 Hippuric acid, 584
 Hoesch reaction, 727†, 736, 737
 Hofmann reaction, 413†, 414, 754, 773
 Homophthalic acid, 753, 771
 Hot plate, electric, 58, 61
 Hydratropaldehyde, 906, 907
 Hydrazine hydrate, 190, 976, 977
 Hydrazines, 1075*
 Hydrazobenzene, 628, 629, 632
 conversion into benzidine, 633
 Hydrazo compounds, 1074*
 table of, 1085*
 Hydrazoic acid, 917, 918
 Hydrazones, 341, 510, 1075*
 Hydriodic acid, 187, 188
 Hydrobenzamide, 711, 720
 Hydrobromic acid, 186, 187
 Hydrocarbons, saturated, 234, 1058*
 unsaturated, 239, 1057*, 1058*; *see* also under Aromatic hydrocarbons and Saturated aliphatic hydrocarbons
 Hydrocinnamic acid, 474, 753, 768, 769, 924, 925
 Hydrogen, purification of, 186
 Hydrogenation, catalytic, 471
 high pressure, 866-874
 Hydrogen bromide, 180-182
 Hydrogen chloride, 179, 180
 Hydrogen cyanide, 182
 Hydrofluoric acid, 611
 precautions in the use of, 611
 Hydrogen iodide, 182
 Hydrogen 3-nitrophthalates, 264
 Hydrogen sulphide, 185
 Hydrolysis of ketonic esters, acid, 475
 ketonic, 475
 Hydrolysis, quantitative, 392*, 1065*
 Hydrolysis of acid amides, 405*, 799*
 1076*
 Hydrolysis of an ester of a phenol, 1064*
 Hydrolysis of esters, 390*, 391* 486, 487, 488, 770*, 786*, 1063*, 1064*
 Hydrolysis of fats, 445
 Hydrolysis of nitriles (cyanides), 357, 410*, 490, 491, 493, 760, 762, 763, 798, 805*, 1077*
 Hydrolysis of substituted amides, 801*, 1076*
 Hydrolysis of sulphonamides, 1077*
 Hydroquinone diacetate, 664, 677
 Hydroquinones, 749
 Hydroxamic acid test for esters, 1062*, 1063*
o-Hydroxyacetophenone, 664, 676
p-Hydroxyacetophenone, 664, 676
p-Hydroxybenzaldehyde, 691, 704
 Hydroxybenzoic acid, infrared spectrum of, 1141
p-Hydroxybenzoic acid, 755, 775

- Hydroxylation of ethylenic compounds, 893, 894
- 2-Hydroxylepidine, 855
- β -Hydroxy- α -naphthaldehyde, 690, 691, 703, 704
- 8-Hydroxyquinoline, 830
- Hygrosopic, 43
- Hypsochromic effect, 1145
- Ideal solution, 5
- Ignition test, 1038*
- Imides, 1075*
table of, 1084*
- Immiscible liquids, 12
boiling point of, 13, 14
vapour pressure of, 13, 14
- Incongruent melting point, 31
- Indane-1 : 2-dione, 903, 904
- Indane-1 : 2 : 3-trione hydrate, *see* Ninhydrin
- Indigo, 980
- 3-Indoleacetic acid, 1012, 1013
- Infrared spectra, 1136
applications of, 1142, 1143
applications to organic chemistry, 1134-1143
of *m*-hydroxybenzoic acid, interpretation of, 1140
technique for, 1136
typical bonds or groups, 1137-1140
useful ranges of solvents for, 1137
- Inorganic reagents, gases, 179-186
- Inorganic reagents, liquids, 186-190
- Inorganic reagents, solids, 190-201
- Interchangeable ground glass joints, 206
advantages of, 207
apparatus with, for general use in preparative organic chemistry, 212-221, 226-228
dimensions of British standards, 207, 208
dimensions of U.S.A. standards, 209
lubrication of, 225
semimicro apparatus with, 1109, 1110
sticking of, 225, 226
spherical (semi-ball), 211, 212
types of, 210-212
typical assemblies with, 226-228
- Inulin, 458
- Iodine, detection of, 1041*, 1042*, 1043*, 1045*
recovery of, 647
- Iodine monochloride, 974
- 5-Iodo-2-aminotoluene, 647
- p*-Iodoaniline, 647
- Iodobenzene, 533, 538, 591, 598
- Iodobenzene diacetate, 541
- Iodobenzene dichloride, 534, 541
- o*-Iodobenzoic acid, 760
- Iodoform, 297, 299
test, 1068*, 1069*
- p*-Iodonitrobenzene, 600
- 2-Iodopentane, 288
- p*-Iodophenol, 666, 680
- Iodosobenzene, 534, 541
- p*-Iodotoluene, 591, 599
- Iodoxybenzene, 534, 542
- Ion-exchange resins, 1019; *see* Anion exchange resin and Cation exchange resin
- Keten, 371, 372
- β -Keto-esters, 392
- Ketones; *see* under Aliphatic ketones and Aromatic ketones
- Ketonic hydrolysis, 475, 480, 481
- Ketose, 437
- Knoevenagel reaction, 490, 710, 711†, 719
Doebner modification of, 463, 465, 710, 711†, 719
- Kofler hot bench, 82
- Knorr pyrrole synthesis, 839†, 840
- Kolbe-Schmitt reaction, 754, 755†, 774-776
- Kyrides seal, 66
- Laboratory accidents and first aid, 1130-1133
- Laboratory apparatus, common organic, 46-52
- Laboratory work, general instructions for, 204, 205
- Lactones, 1062*
- Lassaigne test, 1039*, 1040*
defects in, 1043
- Lead dioxide, 199
- Lead tetracetate, 199, 951
- Lessing rings, 92
- Leuckart reaction, 561, 567
- Liebermann nitroso reaction, 649*
- Light petroleum, purification of, 174
- Ligroin, 174
- Linseed oil, 445
- Liquid, determination of density and refractive index of, 1029-1034
- Liquid ammonia, reactions in, 895-902
- Liquids, partially miscible, 17-19
- Liquids, supercooled, 22, 23
- Liquidus, 26, 33
- Literature of organic chemistry, 1115-1130
- Lithium, use of, 931
- Lithium aluminium hydride, reductions with, 877-881
- Locating an organic compound, 1128
- Lubrication of ground glass joints, 225
- Lucas test, 261*
reagent, 261*

- Magnesium sulphate, as desiccant, 41, 140
- Magnesium turnings, for Grignard reaction, purification of, 237
- Magneson I, 960
- Magneson II, 960
- Magnetic stirring, 70
- Malaprade reaction, 446, 1070*
- Maleic acid, 461, 462
catalytic reduction to succinic acid, 473
conversion into fumaric acid, 463
melting point of, 462
- Maleic anhydride, 371, 376, 462, 942, 943
- Malonic acid, 489, 490
- Malononitrile, 428, 434
- Mandelic acid, 754, 774
- Manganous oxide catalyst, 339
- Mannich bases, 910, 911
- Mannich reaction, 910, 911†, 912, 1012, 1013
- Mannitol, 448
- Manometers, 104, 112
U-tube, 112
"vacustat," 112, 113
Zimmerli, 113
- Manostats, 112, 114
Cartesian, 115, 116
needle type, 115
Newman, 114
- Mechanical agitation, 62-70
- Mechanical shaking machine, 69
- Mechanical stirring, 62-70, 1108
- Meerwein-Ponndorf-Verley reduction, 882†, 883-886
- Melamine-formaldehyde polymers, 1017
- Melting theory, of, 21
under the solvent, 35
- Melting point, 21
and vapour pressure, 21
congruent, 29
effect of impurities upon, 23, 24
experimental determination of, 75-83, 229
incongruent, 31, 32
mixed, 34, 35, 229, 230
of a mixture, 26
- Melting point apparatus, 77-83
bath liquid for, 78
electrically-heated, 81-83
housing for, 78
Kofler hot bench, 82
- Melting point capillaries (tubes), preparation of, 75, 76
filling of, 76
- l*-Menthone, 335, 337
- Mercaptans, 496, 1077
general remarks on the preparation of, 497
- Mercaptans—*cont.*
reactions and characterisation of, 500*, 1078*
table of and derivatives of, 502*
- Mercury, detection of, 1043*
- Mercury benzamide, 797
- Mercury-sealed stirrers, 66-69, 220†
- Mesitaldehyde, 690, 701
- Mesityl oxide, 353
- Metaldehyde, 319
- Metanilic acid, 586, 589
- Methiodides, 660*
- Metho-*p*-toluenesulphonates, 660*
p-Methoxyacetophenone, 733
p-Methoxybenzaldehyde, 690, 703
4-Methoxybenzoin, 708, 714
p-Methoxycinnamic acid, 719
p-Methoxyphenylacetic acid, 904, 905, 924, 925
p-Methoxyphenylurea, 646
- Methyl acetate, 383
purification of, 174
- Methyl alcohol, 169
determination of water in, 21
preparation of absolute, 169, 170
- p*-Methylacetophenone, 725, 730
- Methyl alcoholic potassium hydroxide solution, 1063*
- Methylamine hydrochloride, 411, 414, 415
- Methyl *n*-amyl carbinol, 247, 254
- Methyl *n*-amyl ketone, 482
- Methylaniline (mono), pure, from commercial methylaniline, 562, 570
- β -Methylanthraquinone, 728, 740
- Methyl benzoate, 780, 781
- p*-Methyl benzyl alcohol, 811, 812
- Methyl benzyl ketone, 727, 735
- Methyl γ -bromocrotonate, 926, 927
- 2-Methyl-2-butene, 239
- Methyl *n*-butyl carbinol, 247, 255
- Methyl *n*-butyl ether, 314
- Methyl *n*-butyl ketone, 475, 481
- 4-Methylcarbostyryl, 855
- p*-Methylcinnamic acid, 719
- 4-Methylcoumarin, 853, 854
- Methyl crotonate, 926, 927
- dl*-Methylethylacetic acid, 354, 358
- Methylethylethynyl carbinol, 468
- Methyl ethyl ketone, 335, 336
purification of, 172
- Methyl *n*-hexyl ether, 314
- Methyl *n*-hexyl ketone, 335, 336
- Methyl *n*-hexyl ketoxime, 348
- Methyl hydrogen adipate, 938
- Methyl hydrogen sebacate, 938, 939
- 4-Methyl-7-hydroxycoumarin, 834
- Methyl iodide, 287
- Methyl isopropyl carbinol, 247, 255
- Methyl 4-keto-octanoate, 936

- Methyl methacrylate, 1016
 depolymerisation of resin, 1023
 polymerisation of, 1023
 Methyl α -naphthyl ketone, 767
 Methyl β -naphthyl ketone, 726, 731,
 767, 924
 Methyl *m*-nitrobenzoate, 753, 769
 Methyl orange, 620, 621, 624
 reduction of, 624
 Methyl β -phenylethyl ketone, 727, 736
 Methylphenylnitrosamine, 562, 570
 Methylphenylosazones, 456*
 Methyl *n*-propyl ketone, 340
 Methyl pyridines, purification of, 177-179
N-Methylpyrrole, 837, 838
 Methyl red, 621, 625
 sodium salt of, 626
 Methyl salicylate, 780, 782
 Methyl sulphite, 304
 2-Methylthiophene, 836
 Methyl *p*-toluenesulphonate, 825
 Methylurea, 968, 969
 Methylene bromide, 300
 Methylene chloride, purification of, 176
 3 : 4-Methylenedioxybenzoic acid, 711,
 719
 Methylene iodide, 300
 Michael reaction, 912, 913†, 914
 Michler's ketone, 982
 Mixed melting point, 34, 229, 1028
 Mixtures of organic compounds, quali-
 tative analysis of, 1090*-1100*
 preliminary examination, 1093*,
 1094*
 separation of water-insoluble, 1095*-
 1097*
 separation of water-soluble, 1098*-
 1100*
 Mol fraction, 5
 Molecular distillation, 120-122
 still for, 121, 122
 Molecular extinction coefficients, 1135
 Molecular weight, by Rast camphor
 method, 1037
 Molisch test, 453*
 Monastral blue, 983
 Monobromoacetic acid, 427, 429
 Monochloroacetic acid, 427, 428
 Monoethylaniline, *see* Ethylaniline
 Monoperphthalic acid, 807, 810
 Monosaccharides, 449, 455
 Mucic acid, 452, 1070*
 Myristic acid, 938, 940, 941

 α -Naphthaldehyde, 692, 700
 β -Naphthaldehyde, 691, 698, 699, 701
 α -Naphthalides, 290*
 1 : 2-Naphthoquinone, 745, 746
 1 : 4-Naphthoquinone, 745, 746, 942,
 943
 Naphthionic acid, 585, 586
 β -Naphthol, 664, 668
 conversion into di- β -naphthol, 668
 β -Naphthol- α -aldehyde, 690, 691, 703,
 704
 β -Naphthol orange, 621, 625
 α -Naphthoic acid, 752, 764, 765, 929,
 931
 β -Naphthoic acid, 753, 766, 767
 α -Naphthonitrile, 752, 764
 β -Naphthoyl chloride, 691, 699
 β -Naphthyl acetate, 665, 669
 α -Naphthylacetic acid, 752, 763, 903,
 904
 β -Naphthylacetic acid, 924, 925
 α -Naphthylacetoneitrile, 752, 763
 α -Naphthylamine, 561, 568
 β -Naphthylamine, 561, 568
 carcinogenic properties of, 562
 2 Naphthylamine-1-sulphonic acid, 604,
 752, 767
 β -Naphthyl benzoate, 784
 α -Naphthylcarbamates, 364*
 α -Naphthyl isocyanate, 264, 291
 α -Naphthylhydantoic acids, 437*
 β -Naphthyl methyl ether, 665, 670,
 767
 α -Naphthyl magnesium bromide, 765
 α -Naphthylureido acids, 437*
 α -Naphthylurethanes, 264, 683
 Nerolin, 665, 670
 Neutralisation equivalent, determina-
 tion of, 360, 1071
 Nicol prism, 503
 Nicotinamide, 850
 Nicotinic acid, 848
*iso*Nicotinic acid, 848
 Ninhydrin, 436*, 993, 994, 995
 NiOXime, 974, 975
 Nitration of aromatic hydrocarbons,
 523†
 Nitric acid, 188
 fuming, 189
 Nitriles, 410*, 805*, 1075*
 hydrolysis of, 1077*; *see* under
 Aliphatic cyanides and Aromatic
 cyanides
*iso*Nitriles, 420, 648, 1073
 Nitro compounds, 1074*
 intermediate products in reduction
 of, 628, 1074*
 reduction of, to amines, 563, 564,
 565, 1076*; *see* also Aliphatic
 nitro compounds and Aromatic
 nitro compounds
 Nitro derivatives of aromatic hydro-
 carbons, 520*
 of halogenated aromatic hydrocar-
 bons, 543*
p-Nitroacetanilide, 577, 581

- m*-Nitroaniline, 563, 574
p-Nitroaniline, 577, 581
 Nitrobarbituric acid, 851
o-Nitrobenzaldehyde, 696
 diacetate, 696
m-Nitrobenzaldehyde, 881
p-Nitrobenzaldehyde, 689, 695, 700
 diacetate, 696
 Nitrobenzene, 523, 525
 purification of, 175
p-Nitrobenzene-azo- α -naphthol, 960
p-Nitrobenzene-azoresorcinol, 960
m-Nitrobenzenesulphonic acid, 586, 589
o-Nitrobenzenesulphonyl chloride, 585, 586
p-Nitrobenzoates, 263*, 682*
m-Nitrobenzoic acid, 753, 769
p-Nitrobenzoic acid, 751, 757
p-Nitrobenzoyl chloride, 791, 792
p-Nitrobenzoyl peroxide, 807, 808
o-Nitrobenzyl alcohol, 882
m-Nitrobenzyl alcohol, 881
p-Nitrobenzyl bromide, 961
p-Nitrobenzyl cyanide, 751, 763
p-Nitrobenzyl esters, 362*
 1-Nitro-*n*-butane, 302, 307
m-Nitrocinnamic acid, 719
 Nitrogen, detection of, 1040*, 1045*
 purification of, 186
 1-Nitro-*n*-hexane, 307
 Nitromethane, 302, 307, 709
 α -Nitronaphthalene, 523, 526
o-Nitrophenol, 665, 677
m-Nitrophenol, 595, 614
p-Nitrophenol, 665, 677
p-Nitrophenylacetic acid, 752, 763
p-Nitrophenylarsonic acid, 597, 618
p-Nitrophenylhydrazine, 635, 637
p-Nitrophenylhydrazones, 436*, 722*
 3-Nitrophthalic acid, 966
 4-Nitrophthalic acid, 966, 967
 3-Nitrophthalic anhydride, 966, 967
 derivatives with, 654*
 8-Nitroquinoline, 828, 830
 5-Nitrosalicylaldehyde reagent, 421*
 test, 421*
 Nitrosamines, 1074*, 1076*
 Nitrosobenzene, 629, 630
 Nitroso compounds, table of, 1085*
p-Nitroso derivatives, 660*
N-Nitrosodiethylamine, 426
N-Nitrosodimethylamine, 426
p-Nitrosodimethylaniline, 562, 573
N-Nitrosoethylamine, 570
N-Nitrosomethylamine, 562, 563, 570
p-Nitroso-*N*-methylaniline, 563, 574
 Nitrosomethylurea, 968, 969
 α -Nitroso- β -naphthol, 958
 β -Nitrostyrene, 709, 717
 $\alpha\beta$ -Nonenoic acid, 465, 468
n-Nonoic acid, 487
n-Nonyl alcohol, 247, 254
n-Nonylaldehyde, 892
 Norleucine, 427, 432
 Note books, 204
 "Nylon," 1019
 "Nylon," depolymerisation of, 1025
 formation of, 1025
n-Octaldehyde, 324
n-Octane, 236, 238
n-Octonitrile, 408
sec.-Octyl alcohol, resolution of, 505
n-Octyl bromide, 282
n-Octyl iodide, 288
 Oil, fatty, vegetable or animal, 444
 Oil pumps, 110
 protection of, 111
 Oleum, 188
 Oppenauer oxidation, 886, 887†, 888
 Orange II, 621, 625, 745
 Organocadmium compounds, syntheses
 with, 933-935
 Organolithium compounds, syntheses
 with, 928-933
 Organosodium compounds, syntheses
 with, 935-937
 Organosilicon polymers, 1020
 Original sources of chemical informa-
 tion, 1127
 Orthanic acid, 585, 587
 Osazones, 450*, 1069*
 formation of, 455*
 photographs of, facing 455
 Osmium tetroxide, 894, 895
 Oxidation of a side chain, 520*, 529*,
 672*
 Oximes, 341*, 343, 345*, 348, 721*,
 1075*
 table of, 1087*
 Oxine, 830
 Ozonides, 888
 Ozonisers, 890, 891
 Ozonolysis, 888-893

 Palladium-barium carbonate catalyst,
 951
 Palladium-barium sulphate catalyst,
 699, 951
 Palladium-calcium carbonate catalyst,
 891
 Palladium-carbon catalysts, 948, 950
 Palladium catalysts, for dehydrogena-
 tion, 948
 for hydrogenation, 949, 950, 951
 Paraformaldehyde, 319
 Paraldehyde, 319, 324
 Partially miscible liquids, 17
 Partition coefficients, 44, 45
 Pechmann reaction, 853†, 854, 855

- Pelargonic acid, 487
 Pentamethylene dibromide, *see* 1 : 5-Dibromopentane
 Pentamethylene dicyanide, 493
 2-Pentene, 239
 4-Pentyn-1-ol, 896, 901
 Peracetic acid oxidation, 755, 768, 893
 Perbenzoic acid, 807, 808, 894
 analysis of, 809
 Performic acid, 893, 894
 Periodic acid, 1070
 reagent, 1070*
 Perkin reaction, 706, 707†, 708, 712, 713
 Oglialoro modification of, 708
 Perkin triangle, 108, 218†
 Kon modification of, 109
 Peroxides, detection of, in ether, 163
 removal from diethyl ether, 163
 removal from *isopropyl* alcohol, 886
 Petroleum ether, purification of, 174
 Phenacetin, 996, 997
 1 : 10-Phenanthroline, 991, 992
p-Phenetidine, 997, 998
 Phenetole, 665, 670
 Phenobarbitone, 1003, 1004, 1005
 Phenol, 595, 613
 Phenol - aldehyde polymers, 1016
 formation of, 1022
 Phenolphthalein, 984, 985
 action as indicator, 984†
 Phenol red, 989, 990
 Phenols, 664
 crystalline derivatives of, 682*
 reactions and characterisation of, 664*, 1071*, 1072*
 separation from acids, 786*
 table of and derivatives of, 685*
 Phenosulphonephthalein, 990
 Phenyl acetate, 665, 669
 Phenylacetamide, 752, 762
 Phenylacetic acid, 752, 757, 761
p-Phenylacetophenone, 962
 Phenylacetylene, 896, 900
dl- β -Phenylalanine, 908, 910
N-Phenylanthranilic acid, 991
 Phenylarsonic acid, 597, 617
 Phenyl-azo- β -naphthol, 620, 622
 reduction of, 623
 Phenyl benzoate, 780, 784
 hydrolysis of, 786*
 Phenylbenzoyldiazomethane, 856
 Phenyl *isocyanate*, 264, 290
 Phenyl *n*-butyl ether, 665, 671
 γ -Phenylbutyric acid, 728, 738
 Phenylcarbamates, 264*
 Phenyl cinnamate, 780, 784
 α -Phenyleinnmic acid, 707, 708, 713
 Phenylidiazonium chloride, solid, 591, 597
 solution of, 590, 598
 Phenylidiazonium hydrogen sulphate, solid, 591, 598
o-Phenylenediamine, 640
m-Phenylenediamine, 640, 641
 1-Phenyl-2 : 3-dimethyl-5-pyrazolone, 998
 β -Phenylethyl alcohol, 812, 816
 Phenylethylene, 1015, 1024
 α -Phenylethylamine, 560, 566
 β -Phenylethylamine, 560, 567, 569
 Phenylethylbarbituric acid, 1003, 1005
 β -Phenylethyl bromide, 283
 β -Phenylethyl iodide, 288
 Phenylglycine-*o*-carboxylic acid, 980
 Phenylglyoxal, 866
 Phenylhydrazine, 635, 636
 hydrochloride, 636, 637
 Phenylhydrazine acetate reagent, 343*, 721*
 Phenylhydrazones, 342*, 343*, 721*, 852
 β -Phenylhydroxylamine, 628, 629, 959
 conversion into *p*-aminophenol, 630
 2-Phenylindole, 851, 852
 Phenyl-lithium, 928, 931, 932
 Phenylmethylglycidic ester, 906, 907
 1-Phenyl-3-methyl-5-pyrazolone, 998
p-Phenylphenacyl bromide, 962
p-Phenylphenacyl esters, 363*
 Phenylpropionic acid, 755, 776
 Phenylpropionaldehyde, 906, 907
 Phenyl propionate, 676
 2-Phenylpyridine, 929, 931
 2-Phenylquinoline-4-carboxylic acid, 1010, 1011
 Phenyl *iso*-thiocyanate, 642, 643
 Phenylthioureas, 422*, 655*
 Phenylurea, 644, 645
 Phenylurethanes, 264*
 Phloracetophenone, 727, 736
 Phosgene, 185
 Phosphoric acid, 189, 284
 Phosphorus, detection of, 1043*
 Phosphorus, red, purification of, 193
 Phosphorus oxychloride, 367
 Phosphorus pentabromide, 489, 492
 Phosphorus pentachloride, 799, 822, 974
 Phosphorus pentoxide, handling of, 407
 Phosphorus tribromide, 189, 492
 Phosphorus trichloride, 367
 Phosphorus "trisulphide," 836
 Phthalamide, 983
 Phthalein test, 681*
 Phthalic anhydride, 681, 753, 984, 985
 purification of, 507
 Phthalide, 753, 772
 Phthalimide, 753, 754, 771
 Phthalimides, *N*-substituted, 423*
 Phthalonitrile, 983
 Phthalylacetic acid, 995
 Physical constants, determination of, 1028-1037

- α -Picoline, purification of, 177
 β -Picoline, purification of, 178
 γ -Picoline, purification of, 178
 Picolinic acid, 847
 Picrates, 422*, 518*, 544, 672*
 of β -naphthyl alkyl ethers, 292*
 Picric acid, 666, 678
 Pimelic acid, 489, 492, 493
 Pinacol, 349, 350
 Pinacol hydrate, 350
 Pinacol-pinacolone rearrangement, 349†,
 350, 351
 Pinacolone, 349, 351
 β -Piperonylacrylic acid, 711, 719
 Pivalic acid, 350, 351
 Platinum catalysts, for dehydrogena-
 tion, 948
 for hydrogenation, 470, 471
 Poisons, 1133
 Polarimeter, 503
 half-shadow, 503, 504
 tube, 504
 Polarizer, 503
 Polyamides, 1019
 depolymerisation of, 1025
 formation of, 1025
 Polyethylene polysulphide, 1024
 Polyhalogen aliphatic compounds, 297
 Polyhydric alcohols, 444
 reactions and characterisation, of
 447*, 1069*, 1070*
 table of, and derivatives of, 448*
 Polyphosphoric acid, 853
 Polystyrene, 1015, 1025
 Polythene, 1015
 Polymers, addition, 1015
 condensation, 1014, 1016
 copolymers, 1014
 organosilicon, 1020
 Polysaccharides, 449
 notes on identification of, 458*
 Porous porcelain, "pot", 4, 5
 Potassium, precautions in the use of, 920
 Potassium acetate, fused, 713
 Potassium borohydride, reductions with,
 881, 882
 Potassium *tert.*-butoxide, 920, 921
 Potassium *n*-butyl xanthate, 499
 Potassium ethyl xanthate, 496, 499
 Potassium hypochlorite solution, 461
 Potassium iodide - iodine reagent, 1069*
 Prileschajew epoxidation reaction, 893†,
 894
 Primary aliphatic amines, 413
 crystalline derivatives of, 424*
 reactions of, 420*, 1072*
 table of, and derivatives of, 424*
 Primary aromatic amines, 539
 crystalline derivatives of, 652*
 reactions and characterisation of,
 648*, 1073*
 Primary aromatic amines—*cont.*
 table of, and derivatives of, 656*
 Pro-oxidants, 694
 Propionaldehyde, 321, 322
o-Propiophenol, 664, 676
p-Propiophenol, 664, 676
 Propiophenone, 732, 936, 937
 β -*n*-Propoxypropionitrile, 915, 916
n-Propyl acetate, 383
 iso-Propyl acetate, 383
 n-Propyl alcohol, absolute, 170
 iso-Propyl alcohol, recovery of, 886
 removal of peroxides in, 886
 n-Propylaniline, 571
 iso-Propylaniline, 571
 n-Propylbenzene, 511, 516
 iso-Propylbenzene, 509, 512
 n-Propyl benzoate, 780, 782
 n-Propyl benzyl ketone, 727, 736
 n-Propyl bromide, 277, 279, 282
 iso-Propyl bromide, 270, 277
 n-Propyl formate, 385
 n-Propylglutaric acid, 915, 917
 n-Propyl iodide, 287
 iso-Propyl iodide, 285, 287
 iso-Propyl lactate, 381, 387
 n-Propylmalonic acid, 488
 n-Propyl β -phenylethyl ketone, 727, 736
 n-Propyl thiocyanate, 305
 n-Propyl *n*-valerate, 381, 387
 Protection of amino group, 577
 Prussian blue, 1039*
 Pseudo-saccharin chloride, 978
 Pseudo-saccharin ethers, 266*, 684*
 Pumps, oil, 110
 water, 104, 110
 Purification of common organic sol-
 vents, 163–179
 Purification of solids by crystallisation,
 122–130
 by distillation, 107
 P.V.C., 1015, 1016
 Pycnometer, 1029
 Pyridine, purification of, 175, 176
 Pyrrole, 837
 Pyruvic acid, 1010

 Qualitative organic analysis, 1027*;
 see also End papers
 basis of, 1027*
 for the elements, 1038*–1045*
 preparation of derivatives for, 1027*,
 1081*–1083*
 Qualitative organic analysis of mixtures,
 1090*–1100*
 separations, 1091*, 1092*
 preliminary examination of, 1093*,
 1094*
 separation of water-insoluble, 1095*–
 1097*

- Qualitative organic analysis of mixtures
— *cont.*
 separation of water-soluble, 1098*–1100*
 tables for, 1097*. 1100*
- Quinaldine, 831 †, 832
- Quinaldinic acid, 975, 976
- Quinhydrone, 745, 747
- Quinoline, 828
- Quinoline - sulphur poison, 700
- Quinones, 745
 reactions and characterisation of, 747*, 1068*
 table of, and derivatives of, 750*
- Quinoxalines, 749*
- Radt-Elsevier Encyclopædia of Organic Chemistry, 1129
- Raney nickel catalyst, 560, 566, 870
- Raoult's law, 5, 6, 7
- Raschig rings, 92
- Rast camphor method, for molecular weights, 1037
- Reactions under pressure, apparatus for, 866–870
- Receiver adapters, 212 †
- Recrystallisation, 122–125
 common solvents for, 124
 choice of solvent for, 125, 232
 difficulties encountered in, 129, 130
 exercises in, 232, 233
 experimental details for, 125–127
 filtration of hot solutions in, 126
 less common solvents for, 124
 in an atmosphere of inert gas, 135
 purification of solid compounds by, 232, 233
 solvent pairs for, 125
 treatment of "oil" in, 129, 130
- Rectified spirit, 166
 dehydration by quicklime, 166
- Red phosphorus, purification of, 193
- Reduction adapters, 212 †
- Reference works in organic chemistry, 1128–1130
- Reflux ratio, 92, 95
- Reformatsky reaction, 874 †, 875, 876
- Refractive index, determination of, 1031
- Refractivity, molecular, 1034
 atomic and structural constants, 1035
 bond refractions, 1036
- Refractometer, Abbe, 1033
- Reimer-Tiemann reaction, 691, 692 †, 703–705
- Resolution of a racemic compound, 503
 of *sec.*-octyl alcohol, 505
- β-Resorcylaldehyde, 690, 702
- β-Resorcyclic acid, 754, 775
- Rimini test, 420*
- Ring enlargement with diazomethane, 946 †, 947
- Rosenmund reduction, 691, 699
- Rotation, molecular, 505
 specific, 505
- Rotatory power, determination of, 504
- Rubber, natural unvulcanised, 1022
 synthetic, 1022
- Rubber stoppers, 55
 boring of, 56
- Saccharic acid, 453
- Saccharin, 821, 824, 987
- Safety precautions, 205, 206
- Salicylaldehyde, 691, 703
 purification of commercial, 704
- Salicylaldoxime, 957, 958
- Salicylic acid, 754, 775
- Salting out, 260, 548
 effect, 151
- Sandmeyer reaction, 591, 592 †, 594, 600–603, 751
- Saponification ; *see* Hydrolysis
- Saponification equivalent of an ester, determination of, 392*, 1065*
- Saturated aliphatic hydrocarbons, 233
 reactions and characterisation of, 234*, 1058*
 table of, 235*
- Schiemann reaction, 594 †, 595, 600–603, 751
- Schiff's bases, 653*
- Schiff's reagent, 330*, 1061*
- Schmidt reaction or rearrangement, 917, 918 †, 919
- Schotten-Baumann reaction, 582, 584, 780, 784 ; *see* also Benzoates
- Sebacic acid, 469, 938, 939
- Secondary aliphatic amines, 413
 crystalline derivatives of, 422*
 reactions of, 421*, 1072*
 table of and derivatives of, 424*
- Secondary alkaryl amines, 562, 570, 571
- Secondary aromatic amines, 559, 562
 crystalline derivatives of, 652*
 reactions and characterisation of, 649*, 1173*
 table of and derivatives of, 659*
- Secondary sources of chemical information, 1127, 1128
- Seeding, 27, 129
- Selenium dioxide, 200
 oxidation with, 866, 974, 975, 993, 995
- Semicarbazide hydrochloride, 954
- Semicarbazones, 333*, 342*, 344*, 1075*
- Semimicro apparatus :
 centrifuge tube, 1101
 clamp, 1104
 "cold finger" condenser, 1103

- Semimicro apparatus—*cont.*
 distillation flask, 1102
 distillation tube, 1103
 dropper pipette, 1102
 "filtration nail," Willstätter, 1107
 fractionating column, 1104, 1105, 1110
 Schwinger filter, 1107
 still head, 1103, 1105
 with interchangeable ground glass joints, 1109, 1110
- Semimicro operations :
 distillation at atmospheric pressure, 1102, 1103, 1109
 distillation under diminished pressure, 1104
 filtration, 1106, 1107, 1108
 fractional distillation at atmospheric pressure, 1104, 1105, 1110
 fractional distillation under diminished pressure, 1105, 1110
 heating under reflux, 1105
 recrystallisation, 1106, 1107
 separation of liquids, 1102
 steam distillation, 1106, 1109
 stirring, 1108, 1110
 sublimation, 1108
 transfer of liquids, 1102
- Semimicro technique, 1101–1110
 Setting point, determination of, 81
- Side chains, oxidation of, 520*
 529*, 544*, 672*, 714
- Silicone, fluids, 59, 1020
 resins, 1020
 stopcock greases, 225
- Silver maleate, 388
 Silver nitrite, 201
 Simon's test, 421*
- Skraup reaction, 828†, 829, 830, 991, 992
- Small scale preparations, 1110–1114
 advantages of, 1110, 1111
 apparatus for, 1111
 basis of an elementary course, 1111–1114
- Small scale preparations, experimental details for :
 aniline, 1102
 cinnamic acid, 1113
- Soaps, 445
- Soda lime, distillation with, 777*
- Sodamide, 195–197, 467, 845, 846, 895, 896, 898, 899, 1008
 small quantities of highly reactive, 197
- Sodium, 143
 as desiccant, 143, 144
 precautions in handling, 143, 236, 482, 1040
- Sodium, granular, "molecular," powder or sand, 193, 933
 wire, 164
- Sodium acetate, anhydrous, 197
 Sodium acetylde, 896, 899
 Sodium amalgam, 194, 769, 964
 Sodium anthraquinone- β -sulphonate, 981
 Sodium azide, 918, 919
 Sodium benzenesulphonate, 548, 549
 Sodium bicarbonate solution test, 360*, 1071*
 Sodium bisulphite reagent, 332
 Sodium borohydride, reductions with, 881–882
 Sodium *p*-bromobenzenesulphonate, 550
 Sodium carbonate - zinc mixture, 1042*
 Sodium cyanide, precautions in the use of, 409
 Sodium ethoxide, 863
 solution, 859
 Sodium fusion, 1039*, 1040*
 Sodium hydride, precautions in the use of, 922
 Sodium hyposulphite (dithionite), 621, 625
 Sodium β -naphthalenesulphonate, 548, 551
 Sodium nitroprusside, 1041*
 Sodium plumbite solution, 1041*
 Sodium press, 164
 Sodium sulphide, anhydrous, 197
 use of, 574, 587
 Sodium *p*-toluenesulphinate, 821, 826
 Sodium *p*-toluenesulphonate, 548, 550
 Sodium triphenylmethide, 477, 479
 Solid carbon dioxide, *see* Dry Ice
 Solid solution, 32, 34
 Solidus, 26, 33
 Solubilities, of alcohols in water, 1046
 of stereoisomers in water and in alcohol, 1047
 Solubilities of organic compounds, 1045*–1050*
 determination of, for group tests, 1055*, 1056*
 in reaction solvents, 1048*–1050*
 Solubility groups, 1050*–1054*
 classification of, 1054*
 outline of solubility classification procedure, 1054*
 table of, 1052*
 Solutions, conjugate, 17–20
 Solutions of liquids in liquids, 17
 Solvents, 123, 124
 evaporation of, 135, 136
 for recrystallisation, 123–125
 purification of, 163–179
 Sommelet reaction, 692, 693†, 700, 701
 Sorbic acid, 466
 Sorbose, 450
 Soxhlet extraction apparatus, 153, 154, 223†
 Spatulas, 252

- Specimens, preserving of, 205
 Splash head, 214†
 Stannous chloride, anhydrous, 197; *see*
 also Stephen reaction
 Starch, 458*
 Steam distillation, 12, 228†, 1109*
 continuous, of liquids heavier than
 water, 148, 149
 of large quantities, 149
 of small quantities of material, 149,
 1109
 technique of, 145-149
 theory of, 12-15
 use of, 145
 with superheated steam, 15, 16
 Stem correction, 72
 Stephen reaction, 318†, 324, 691, 698
 Sticking of ground glass joints, 225, 226
 Still heads for fractionating columns,
 102
 Stirrers, 64, 67, 219†
 glycerine-sealed, 66, 67, 219†
 Hershberg, 64, 69
 Kyrides, 67
 magnetic, 70
 mercury-sealed, 66, 68, 219†
 precision-ground, 219†
 "vibro mixer," 65
 vortex, 64
 Teflon, 64
 Stirring, 67
 in an inert atmosphere, 69
 magnetic, 70
 mechanical, 62-70
 Stobbe condensation, 919, 920†, 922,
 923
 Stoppers, 55, 212†
 Styphnates, 519*
 Styrene, 1015, 1024
 Styrene dibromide, 896, 900
 Styrene oxide, 893, 894
 Suberic acid, 893, 894
 Sublimation, 37
 in a stream of an inert gas, 155
 technique of, 154-156, 1108
 theory of, 37
 under reduced pressure, 156
 Substituted aliphatic monobasic acids,
 427
 N-Substituted phthalimides, 423*
 Succinamide, 401, 403*
 Succinamic acid, 377*
 Succinic acid, 473, 494
 Succinic anhydride, 371, 375
 Succinimide, 840
 Sugars, 1069*, 1070*; *see* also Carbo-
 hydrates
 Sulphaguanidine, 1009, 1010
 Sulphanilamide, 1005, 1006, 1007
 Sulphanilic acid, 585, 586
 Sulphanilylguanidine, 1009
 Sulphapyridine, 1007, 1008
 Sulphides, 496, 497, 498, 500*, 1078*
 Sulphinic acids, 826, 1078*
 o-Sulphobenzoic acid, acid ammonium
 salt, 988
 o-Sulphobenzoic anhydride, 987, 988
 Sulphonacetamides, 554*
 Sulphonamides, 543*, 553*, 671*, 1076*
 hydrolysis of, 1077*
 Sulphonanilides, 553*
 Sulphonation of aromatic hydrocarbons,
 548, 549†
 Sulphones, 500*, 1078*
 Sulphonophthaleins, 989, 990
 Sulphonic acids, 548, 557, 1077*; *see*
 also under Aromatic sulphonic acids
 alkyl esters of, 1079*
 Sulphoxides, 500, 1078*
 Sulphur compounds, miscellaneous,
 table of, 1088*
 Sulphur, detection of, 1041*, 1045*
 Sulphur dioxide, 185, 607
 test reagent, 553*
 Sulphuric acid, 188
 esters of, 303, 1078*
 fuming, 188
 Sulphuryl chloride, purification of, 189
 Supercooled liquid, 22, 23
 Superheated steam, 15, 16
 Superheaters, 15, 16
 Superheating, 3
 Synthetic polymers, 1014-1025
 Synthetic rubbers, 1021, 1022
 Tautomeric substance, 475, 1147
 Teflon, 5, 64, 1015
 Terephthalic acid, 751, 760
 Tertiary amines, 414, 559, 1073*
 table of, and derivatives of, 661*
 Tertiary aromatic amines, crystalline
 derivatives of, 650*
 reactions of, 649*, 1073*
 Tetrabromophenolsulphonophthalein,
 989, 990
 s-Tetrachloroethane, purification of, 176
 Tetradeconoic acid, 938, 940, 941
 n-Tetradecyl bromide, 283
 1 : 2 : 3 : 4-Tetrahydrocarbazole, 852
 Tetrahydrofuran, 271
 Tetrahydrofurfuryl chloride, 896, 901
 Tetrahydropyran, 271
 Tetralin, dehydrogenation of, 948, 949
 purification of, 949
 α-Tetralone, 728, 737
 "Tetramethyl base," 987
 pp'-Tetramethyldiaminodiphenyl-
 methane, 987
 Tetramethylene glycol, 250
 Thaw-melt method, 28
 Thaw point, 29

- Thermometers, 72**
 calibration curve for, 231
 calibration of, 72-74
 reference substances for calibration of, 73, 74
 stem correction, 72
- Thermometers, use in apparatus with interchangeable ground glass joints, 213†, 227†**
- Thermostat, notes on construction of, 1031**
- Theoretical plate, 94**
 height equivalent of, H.E.T.P., 95
- Thioamide, 923**
- Thiocarbanilide, 642**
- isoThiocyanates, 1079***
- Thio-*p*-cresol, 827**
- Thioethers, 496, 497, 498, 500, 1078***
- Thiokol A, 1021, 1024**
- Thiols, 496, 497**
 reactions and characterisation, of 500*, 1077*
 table of, and derivatives of, 502*
- Thiomorpholides, 924**
- Thionyl chloride, 367, 791, 792, 901, 974**
 purification of, 189
- Thiophene, 837**
 removal from benzene, 172, 173
- Thiophenol, 821, 827**
- Thiophenols, 1077***
- Thiourea, 442, 965**
- Thioureas, substituted, 1079***
- Thoria catalyst, 735**
- Tischenko reactions, 318**
- Tollen's ammoniacal silver nitrate reagent, 330*, 1061*, 1074***
- p*-Tolualdehyde, 689, 697**
- o*-Toluamide, 798**
- Toluene, 510, 516, 615**
 purification of, 173, 174
 separation from benzene, 231
- p*-Toluenesulphinic acid, 821, 826**
- o*-Toluenesulphonamide, 821, 824**
- p*-Toluenesulphonamide, 820, 823**
- p*-Toluenesulphonates, 422*, 437*, 650*, 684***
- p*-Toluenesulphonic acid, 548, 552**
- o*-Toluenesulphonyl chloride, 820, 823, 824**
- p*-Toluenesulphonyl chloride, 820, 822**
 purification of, 653
- o*-Toluic acid, 752, 760**
- p*-Toluic acid, 594, 608, 752, 761, 929, 930, 933, 934**
- p*-Toluidides, 361*, 394***
- p*-Toluidine, 565**
- o*-Tolunitrile, 609**
 conversion into *o*-toluamide, 798
- p*-Tolunitrile, 594, 607**
 hydrolysis to *p*-toluic acid, 608
- p*-Toluyyl-*o*-benzoic acid, 718, 740**
- p*-Tolyl carbinol, 811, 812**
- p*-Tolyl cyanide, 594, 607**
- p*-Tolyl mercaptan, 827**
- p*-Tolyl-sodium, 933, 934**
- p*-Tolylsulphonylmethylnitrosamide, 960, 970**
- p*-Tolyl urea 645, 646**
- Transition point, 32**
- Transmittance, 1136**
- Traps, gas absorption, 71**
 for oil pumps, 111
- Tri-*n*-amyl carbinol, 259**
- 2 : 4 : 6-Tribromoacetanilide, 576, 579**
- 2 : 4 : 6-Tribromoaniline, 576, 579**
- sym.*-Tribromobenzene, 596, 615**
- 1 : 2 : 3-Tribromopropane, 301**
- Tri-*n*-butyl carbinol, 259**
- Tricarballic acid, 912, 913**
- Trichloroacetic acid, 427, 431**
- Trichloroethyl alcohol, 882**
- Triethyl carbinol, 248, 258**
- 3 : 4 : 5-Triiodobenzoates, 265***
- 3 : 4 : 5-Triiodobenzoic acid, 973**
- 3 : 4 : 5-Triiodobenzoyl chloride, 973, 974**
- Triketohydrindene hydrate, 436*, 993, 995**
- Trimethylacetic acid, 350, 351**
- Trimethylamine hydrochloride, 414, 416**
- Trimethylene dibromide, 279**
- Trimethylene dicyanide, 407, 409**
- Trimethylene-di-iodide, 288**
- 1 : 3 : 5-Trinitrobenzene, 965**
 addition compounds of, 519*
- 2 : 4 : 6-Trinitrobenzoic acid, 751, 758**
- 2 : 4 : 6-Trinitrophenol, 666, 678**
- Trioxane, 319**
- Triphenylcarbinol, 811, 813, 814, 816**
- Triphenylchloromethane, 811, 815, 952**
- Triphenylguanidine, 643**
- Triphenylmethane, 509, 515**
- Triphenylmethyl sodium, 477, 479**
- Triple point, 37, 38**
- Tri-*n*-propyl carbinol, 259**
- Trityl chloride, 815**
- Ullmann reaction, 524, 527**
- Ultraviolet and visible spectra, 1134, 1143-1149**
 applications of, 1147-1149
 and keto-enol tautomerism, 1147-1148
 and *cis-trans* tautomerism, 1148
 solvents for, 1144
 survey of data, 1144-1148
 technique of, 1143-1144
- Undecylenic acid, 468**
- 10-Undecynoic acid, 468, 469**
 oxidation to sebacic acid, 469

- Unsaturated (ethylenic) hydrocarbons,
 reactions of, 241*, 1057*, 1058*
 table of, 242*
 Unsaturation, tests for, 360*, 1058*
 Unsymmetrical diaryls, synthesis of,
 927-928
 Uramil, 851
 Urea, 441, 1001, 1002, 1003
 reactions of, 441*, 442*
 xanthhydrol, reaction for, 442*
 Urea - formaldehyde polymers, 1017
- Vacuum desiccators, 137-139
 charge for, 138
 exhaustion of, 138
 guard for, 138
 Vacuum distillation, *see* Distillation
 under diminished pressure
 Vacuum receivers, 103, 108, 109, 118,
 218†
 Kon, 109
 Perkin, 108
n-Valeraldehyde, 322
n-Valeric acid, 354, 355, 357, 359, 487
iso-Valeric acid, 354, 355
n-Valeronitrile, 408
 Vanadium pentoxide catalyst, 463
 Vapour pressure, 1, 2
 of mixtures, 6-11
 Veratraldehyde, 803, 804
 Veratronitrile, 803, 804
 Veronal, 1002, 1003
 Vibro mixer, 65
 Vinylacetic acid, 463, 465
- Washing, 131
 theory of, 44
 Water, density and vapour pressure of,
 1162
 Water bath, 57
 electrically-heated, 58
- Water pumps, 104, 110
 Wax, 445
 Willgerodt reaction, 923, 924†, 925,
 Kindler modification of, 923
 Williamson synthesis, 309, 665, 670, 671
 Witt plate, 51
 Wohl-Ziegler reaction, 926, 927
 Wolff-Kishner reduction, 510, 511†, 516
 Huang-Minlon modification of, 510,
 516
 Wolff rearrangement, 903, 904†, 905, 906
 Woods metal, 59
 Wurtz-Fittig reaction, 508†, 511, 512
 Wurtz reaction, 236, 237
- Xanthates, 496, 499, 597
 Xanthhydrol, 405, 442*, 964
 Xanthogenates, 496, 499, 597
 Xanthone, 964
 Xanthylenes, 405*
 N-Xanthylenesulphonamides, 558*
p-Xylene, 934, 935
- Yield, 201
 actual, 201
 calculation of, 201-204
 factors influencing, 202, 203
 percentage, 201
 theoretical, 201
- Zeo-Karb 225/H, 381, 387, 952
 Zinc, amalgamated, 198, 199; *see also*
 Clemmensen reduction
 Zinc cyanide, 201, 661, 662, 670, 671
 Zinc powder, 630
 distillation with, 748*
 Zinc powder - sodium carbonate method
 for detection of elements, 1043*-
 1045*
 Zwitterions, 435, 585