

---

M A N U A L

---

O F B A S I C

---

T E C H N I Q U E S

---

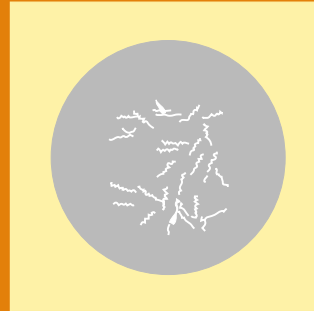
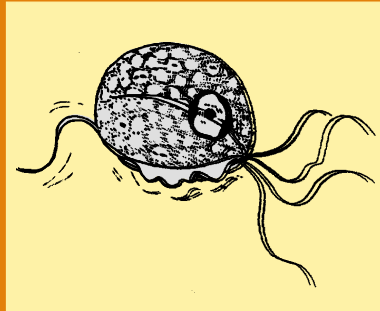
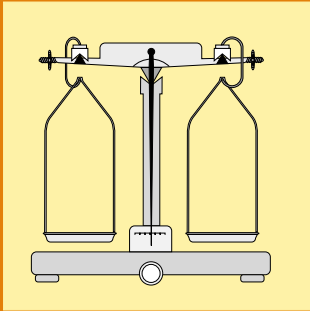

---

F O R A H E A L T H

---

L A B O R A T O R Y

---

2nd edition



World Health Organization  
Geneva

The World Health Organization was established in 1948 as a specialized agency of the United Nations serving as the directing and coordinating authority for international health matters and public health. One of WHO's constitutional functions is to provide objective and reliable information and advice in the field of human health, a responsibility that it fulfils in part through its extensive programme of publications.

The Organization seeks through its publications to support national health strategies and address the most pressing public health concerns of populations around the world. To respond to the needs of Member States at all levels of development, WHO publishes practical manuals, handbooks and training material for specific categories of health workers; internationally applicable guidelines and standards; reviews and analyses of health policies, programmes and research; and state-of-the-art consensus reports that offer technical advice and recommendations for decision-makers. These books are closely tied to the Organization's priority activities, encompassing disease prevention and control, the development of equitable health systems based on primary health care, and health promotion for individuals and communities. Progress towards better health for all also demands the global dissemination and exchange of information that draws on the knowledge and experience of all WHO's Member countries and the collaboration of world leaders in public health and the biomedical sciences.

To ensure the widest possible availability of authoritative information and guidance on health matters, WHO secures the broad international distribution of its publications and encourages their translation and adaptation. By helping to promote and protect health and prevent and control disease throughout the world, WHO's books contribute to achieving the Organization's principal objective – the attainment by all people of the highest possible level of health.

# Manual of basic techniques for a health laboratory

---

Second edition

---



World Health Organization  
Geneva  
2003

WHO Library Cataloguing-in-Publication Data

Manual of basic techniques for a health laboratory. — 2nd ed.

1.Clinical laboratory techniques — handbooks 2.Technology, Medical — handbooks 3.Manuals

ISBN 92 4 154530 5

(NLM classification: QY 25)

© World Health Organization 2003

All rights reserved. Publications of the World Health Organization can be obtained from Marketing and Dissemination, World Health Organization, 20 Avenue Appia, 1211 Geneva 27, Switzerland (tel.: +41 22 791 2476; fax: +41 22 791 4857; e-mail: [bookorders@who.int](mailto:bookorders@who.int)). Requests for permission to reproduce or translate WHO publications – whether for sale or for noncommercial distribution – should be addressed to Publications, at the above address (fax: +41 22 791 4806; e-mail: [permissions@who.int](mailto:permissions@who.int)).

The designations employed and the presentation of the material in this publication do not imply the expression of any opinion whatsoever on the part of the World Health Organization concerning the legal status of any country, territory, city or area or of its authorities, or concerning the delimitation of its frontiers or boundaries. Dotted lines on maps represent approximate border lines for which there may not yet be full agreement.

The mention of specific companies or of certain manufacturers' products does not imply that they are endorsed or recommended by the World Health Organization in preference to others of a similar nature that are not mentioned. Errors and omissions excepted, the names of proprietary products are distinguished by initial capital letters.

The World Health Organization does not warrant that the information contained in this publication is complete and correct and shall not be liable for any damages incurred as a result of its use.

Design by minimum graphics

Typeset in Hong Kong

Printed in Malta

99/12670 — SNPBest-set/Interprint — 15000

---

# Contents



Preface	x
<b>1. Introduction</b>	<b>1</b>
1.1 Aim of the manual	1
1.2 Reagents and equipment	1
1.2.1 Reagents	1
1.2.2 Equipment	1
1.3 The responsibility of laboratory workers	2
1.4 Units of measurement	2
1.4.1 Quantities and units in the clinical laboratory	2
1.4.2 SI units and names for quantities	2
<hr/>	
<b>PART I</b>	<b>9</b>
<hr/>	
<b>2. Setting up a peripheral health laboratory</b>	<b>11</b>
2.1 Plan of a peripheral medical laboratory	11
2.1.1 A one-room laboratory	11
2.1.2 A two-room laboratory	12
2.2 Electricity	12
2.2.1 Sources of electricity	13
2.2.2 Setting up simple electrical equipment	15
2.2.3 What to do in case of failure of electrical equipment	17
2.3 Plumbing: simple procedures	20
2.3.1 Tools and materials	20
2.3.2 Taps	20
2.3.3 Sink traps	22
2.4 Water for laboratory use	23
2.4.1 Clean water	24
2.4.2 Distilled water	24
2.4.3 Demineralized water	27
2.4.4 Buffered water	29
2.5 Equipment	32
2.5.1 Essential laboratory instruments	32
2.5.2 Additional items	33
2.5.3 Equipment and supplies	33
2.5.4 Making glass equipment	33
2.5.5 Specimen containers	42
2.5.6 Storage, stocktaking and ordering supplies	45
2.6 Registration of specimens and preparation of monthly reports	46
2.6.1 Registration of specimens	46

2.6.2	Preparation of monthly reports	47
<b>3.</b>	<b>General laboratory procedures</b>	<b>53</b>
3.1	Use of a microscope	53
3.1.1	Components of a microscope	53
3.1.2	Setting up the microscope	58
3.1.3	Focusing the objective	61
3.1.4	Use of an ocular micrometer	63
3.1.5	Dark-field microscopy	64
3.1.6	Routine maintenance	64
3.2	Weighing: use of laboratory balances	66
3.2.1	Sensitivity of a balance	67
3.2.2	Open two-pan balance	67
3.2.3	Analytical balance	68
3.2.4	Dispensary balance	69
3.3	Centrifugation	69
3.3.1	Principle	69
3.3.2	Types of centrifuge	70
3.3.3	Instructions for use	71
3.4	Measurement and dispensing of liquids	73
3.4.1	Pipettes	73
3.4.2	Volumetric flasks	75
3.4.3	Burettes	77
3.4.4	Graduated conical glasses	77
3.5	Cleaning, disinfection and sterilization	77
3.5.1	Cleaning glassware and reusable syringes and needles	77
3.5.2	Cleaning non-disposable specimen containers	81
3.5.3	Cleaning and maintenance of other laboratory equipment	83
3.5.4	Disinfectants	83
3.5.5	Sterilization	85
3.6	Disposal of laboratory waste	90
3.6.1	Disposal of specimens and contaminated material	90
3.6.2	Incineration of disposable materials	90
3.6.3	Burial of disposable materials	91
3.7	Dispatch of specimens to a reference laboratory	91
3.7.1	Packing specimens for dispatch	91
3.7.2	Fixation and dispatch of biopsy specimens for histopathological examination	95
3.8	Safety in the laboratory	96
3.8.1	Precautions to prevent accidents	97
3.8.2	First aid in laboratory accidents	98
3.9	Quality assurance in the laboratory	101
3.9.1	Specimen collection	102

---

**PART II** **103**

---

<b>4.</b>	<b>Parasitology</b>	<b>105</b>
4.1	Introduction	105
4.2	Examination of stool specimens for parasites	107

---

4.2.1	Collection of specimens	107
4.2.2	Visual examination	107
4.2.3	Microscopic examination	107
4.2.4	Dispatch of stools for detection of parasites	109
4.3	Intestinal protozoa	111
4.3.1	Identification of motile forms (trophozoites)	111
4.3.2	Identification of cysts	118
4.4	Intestinal helminths	125
4.4.1	Identification of eggs	126
4.4.2	Identification of adult helminths	146
4.5	Techniques for concentrating parasites	152
4.5.1	Flotation technique using sodium chloride solution (Willis)	152
4.5.2	Formaldehyde–ether sedimentation technique (Allen & Ridley)	153
4.5.3	Formaldehyde–detergent sedimentation technique	154
4.5.4	Sedimentation technique for larvae of <i>Strongyloides stercoralis</i> (Harada–Mori)	156
4.6	Chemical test for occult blood in stools	157
4.6.1	Principle	157
4.6.2	Materials and reagents	157
4.6.3	Method	158
4.6.4	Results	159
4.7	Parasites of the blood and skin	159
4.7.1	Filariae	159
4.7.2	<i>Plasmodium</i> spp.	172
4.7.3	<i>Trypanosoma</i> spp.	182
4.7.4	<i>Leishmania</i> spp.	194
<b>5.</b>	<b>Bacteriology</b>	<b>197</b>
5.1	Introduction	197
5.2	Preparation and fixation of smears	197
5.2.1	Principle	197
5.2.2	Materials and reagents	197
5.2.3	Preparation of smears	198
5.2.4	Fixation of smears	199
5.3	Staining techniques	199
5.3.1	Gram staining	199
5.3.2	Staining with Albert stain (for the detection of <i>Corynebacterium diphtheriae</i> )	201
5.3.3	Staining with Ziehl–Neelsen stain (for the detection of acid-fast bacilli)	202
5.3.4	Staining with Wayson stain (for the detection of <i>Yersinia pestis</i> )	203
5.3.5	Staining with Loeffler methylene blue (for the detection of <i>Bacillus anthracis</i> )	204
5.4	Examination of sputum specimens and throat swabs	204
5.4.1	Materials and reagents	205
5.4.2	Method	205
5.4.3	Microscopic examination	206
5.4.4	Dispatch of specimens for culture	206

---

5.5	Examination of urogenital specimens for gonorrhoea	207
5.5.1	Materials and reagents	207
5.5.2	Method	207
5.5.3	Microscopic examination	208
5.5.4	Dispatch of specimens for culture	209
5.6	Examination of genital specimens for syphilis	209
5.6.1	Materials and reagents	210
5.6.2	Method	210
5.6.3	Microscopic examination	211
5.7	Examination of semen specimens	211
5.7.1	Materials and reagents	211
5.7.2	Method	212
5.7.3	Macroscopic examination	212
5.7.4	Microscopic examination	212
5.8	Examination of vaginal discharge	215
5.8.1	Materials and reagents	215
5.8.2	Method	215
5.8.3	Microscopic examination	215
5.9	Examination of watery stool specimens	216
5.9.1	Materials and reagents	216
5.9.2	Method	216
5.9.3	Microscopic examination	216
5.9.4	Dispatch of specimens for culture	216
5.10	Examination of aspirates, exudates and effusions	218
5.10.1	Materials and reagents	218
5.10.2	Method	218
5.10.3	Microscopic examination	219
5.11	Examination of pus for <i>Bacillus anthracis</i>	219
5.11.1	Materials and reagents	219
5.11.2	Method	220
5.11.3	Microscopic examination	220
5.12	Examination of skin smears and nasal scrapings for <i>Mycobacterium leprae</i>	220
5.12.1	Materials and reagents	220
5.12.2	Method	221
5.12.3	Microscopic examination	223
<b>6.</b>	<b>Mycology</b>	<b>225</b>
6.1	Examination of skin and hair for fungi	225
6.1.1	Materials and reagents	225
6.1.2	Method	225
6.2	Examination of pus for mycetoma	226
6.2.1	Materials and reagents	227
6.2.2	Method	227
6.3	Examination of skin for pityriasis versicolor	227
6.3.1	Materials and reagents	227
6.3.2	Method	228



---

<b>PART III</b>	<b>231</b>
<b>7. Examination of urine</b>	<b>233</b>
7.1 Collection of urine specimens	233
7.1.1 Types of urine specimen	233
7.1.2 Preservation of urine specimens	234
7.2 Examination of urine specimens	234
7.2.1 Appearance	234
7.2.2 Testing for the presence of blood	234
7.2.3 Measuring the pH	235
7.2.4 Detection of glucose	236
7.2.5 Detection and estimation of protein	236
7.2.6 Detection of ketone bodies	239
7.2.7 Detection of abnormal elements	240
7.2.8 Detection of <i>Schistosoma haematobium</i> infection	249
7.2.9 Detection of bacteria	251
<b>8. Examination of cerebrospinal fluid (CSF)</b>	<b>255</b>
8.1 Common reasons for investigation of CSF	255
8.2 Collection of CSF specimens	255
8.3 Examination of CSF specimens	255
8.3.1 Precautions	255
8.3.2 Direct examination	256
8.3.3 Microscopic examination	257
8.3.4 Determination of glucose concentration	261
8.3.5 Determination of protein concentration	262
8.3.6 Summary	263
8.4 Dispatch of CSF specimens for culture	263
8.4.1 Materials and reagents	263
8.4.2 Method using Stuart transport medium (for the isolation of <i>Neisseria meningitidis</i> )	264
<b>9. Haematology</b>	<b>265</b>
9.1 Types of blood cell	265
9.1.1 Erythrocytes	265
9.1.2 Leukocytes	265
9.1.3 Thrombocytes	266
9.2 Collection of blood specimens	267
9.2.1 Principle	267
9.2.2 Materials and reagents	267
9.2.3 Method	267
9.3 Estimation of the haemoglobin concentration	271
9.3.1 Haemiglobincyanide photometric method	271
9.3.2 Alkaline haematin D method	276
9.4 Estimation of the erythrocyte volume fraction	279
9.4.1 Micro-scale method	280
9.4.2 Macro-scale method	286
9.5 Estimation of the erythrocyte number concentration	287

---

9.6	Estimation of the leukocyte number concentration	288
9.6.1	Principle	288
9.6.2	Materials and reagents	288
9.6.3	Method	289
9.6.4	Results	291
9.7	Measurement of the erythrocyte sedimentation rate	292
9.7.1	Principle	292
9.7.2	Materials and reagents	292
9.7.3	Method	292
9.7.4	Results	293
9.8	Measurement of the bleeding time: Duke method	295
9.8.1	Principle	295
9.8.2	Materials and reagents	295
9.8.3	Method	295
9.8.4	Results	296
9.9	Observation of clot retraction and measurement of lysis time	297
9.9.1	Principle	297
9.9.2	Materials	297
9.9.3	Method	297
9.9.4	Results	298
9.10	Preparation and staining of thin blood films	299
9.10.1	Principle	299
9.10.2	Materials and reagents	299
9.10.3	Method	300
9.10.4	Microscopic examination	305
9.11	Test for sickle-cell anaemia	314
9.11.1	Principle	314
9.11.2	Materials and reagents	314
9.11.3	Method	315
9.11.4	Microscopic examination	315
9.12	Determination of the reticulocyte number concentration/fraction	316
9.12.1	Principle	316
9.12.2	Materials and reagents	316
9.12.3	Method	317
9.12.4	Microscopic examination	318
9.13	Determination of the leukocyte type number fraction	319
9.13.1	Principle	319
9.13.2	Materials	319
9.13.3	Microscopic examination	320
9.14	Determination of the thrombocyte number concentration	321
9.14.1	Materials	321
9.14.2	Microscopic examination	321
<b>10.</b>	<b>Blood chemistry</b>	<b>322</b>
10.1	Estimation of glucose concentration in blood: <i>o</i> -toluidine method	322
10.1.1	Principle	322
10.1.2	Materials and reagents	322

---

10.1.3	Method	322
10.1.4	Results	324
10.2	Estimation of urea concentration in blood: diacetyl monoxime/ thiosemicarbazide method	325
10.2.1	Principle	325
10.2.2	Materials and reagents	325
10.2.3	Method	326
10.2.4	Results	327
<b>11.</b>	<b>Immunological and serological techniques</b>	<b>328</b>
11.1	Introduction to immunology	328
11.1.1	Antibodies	328
11.1.2	Antigens	329
11.1.3	Antigen–antibody interactions	330
11.2	Principle of immunochemical techniques	330
11.2.1	Primary binding tests	330
11.2.2	Secondary binding tests	332
11.3	Determination of rheumatoid factors by the latex-agglutination technique	336
11.3.1	Materials and reagents	336
11.3.2	Method	336
11.4	Tests for the determination of anti-streptolysin O antibodies	336
11.4.1	Anti-streptolysin O test (ASOT)	336
11.4.2	Latex agglutination	338
11.5	Determination of $\beta$ -human chorionic gonadotropin ( $\beta$ -hCG) in urine by the agglutination inhibition technique	339
11.5.1	Materials and reagents	339
11.5.2	Method	339
11.6	Quantitative determination of IgA, IgG and IgM by radial immunodiffusion	339
11.6.1	Materials and reagents	339
11.6.2	Method	340
11.7	Tests for the determination of HIV antibodies	341
11.7.1	ELISA	341
11.7.2	Dipstick test	342
11.8	Tests for hepatitis virus infection	342
11.8.1	ELISA for hepatitis B surface antigen	343
11.8.2	Dipstick test for hepatitis B surface antigen	344
11.9	Dipstick test for falciparum malaria	344
11.9.1	Materials and reagents	344
11.9.2	Method	345
11.10	Tests for syphilis infection	346
11.10.1	RPR test	347
11.10.2	TPHA test	348
<b>Annex:</b>	<b>Reagents and their preparation</b>	<b>350</b>
<b>Index</b>		<b>369</b>

---

# Preface



This book is a revised edition of the *Manual of basic techniques for a health laboratory* (WHO, 1980), major revisions having been carried out by Dr K. Engbaek, Dr C.C. Heuck and Mr A.H. Moody. The revision was necessary because of new procedures and technology that have been developed since the previous edition and that have proved to be useful to small laboratories in developing countries. The procedures have been included in the relevant sections of the manual, and some obsolete procedures have been replaced by more up-to-date techniques.

The original objective of the manual remains unchanged. It is intended mainly for the use of laboratory personnel in developing countries during their training and thereafter in their work. In the selection of techniques, particular attention has been paid to the low cost, reliability and simplicity of the methods and to the availability of resources in small laboratories.

WHO expresses its thanks to all those who have assisted in the revision of this manual.

---

# 1. Introduction



## 1.1 Aim of the manual

This manual is intended for use mainly in medical laboratories in developing countries. It is designed particularly for use in peripheral laboratories in such countries (i.e. in small or medium-sized laboratories attached to regional hospitals) and in dispensaries and rural health centres where the laboratory technician often has to work alone. The language used has been kept as simple as possible although common technical terms are employed when necessary.

The manual describes examination procedures that can be carried out with a microscope or other simple apparatus. Such procedures include the following:

- the examination of stools for helminth eggs;
- the examination of blood for malaria parasites;
- the examination of sputum for tubercle bacilli;
- the examination of urine for bile pigments;
- the examination of blood for determination of the white cell (leukocyte) type number fraction (differential leukocyte count)
- the examination of blood for determination of the glucose concentration.

The intention is to provide an account of basic laboratory techniques that are useful to peripheral laboratories and can be carried out with a limited range of basic equipment.

Some laboratories may not be able to perform all the procedures described. For example, a laboratory in a rural health centre may not be able to carry out certain blood chemistry or serological tests.

## 1.2 Reagents and equipment

### 1.2.1 Reagents

Each reagent has been given a number. The reagents required and their numbers are indicated in the description of each technique. An alphabetical list of all the reagents used, with the numbers assigned to them, their composition, methods of preparation and storage requirements appears in the Annex at the end of the manual. For example, one of the reagents needed for Gram staining is crystal violet, modified Hucker (reagent no. 18). The composition of crystal violet and the method of preparing it are given in the alphabetical list of reagents (see Annex).

### 1.2.2 Equipment

The items required for each technique are listed at the beginning of the corresponding section. A list of the apparatus needed to equip a laboratory capable of carrying out all the examinations described in this manual can be found in section 2.5.

When certain articles are not available, the technician should find an appropriate substitute; for example, empty bottles that formerly contained antibiotics for injection (“penicillin bottles”) and other drug containers can be kept; racks for test-

tubes and slides can be made locally; and empty tins can be used to make water-baths.

### 1.3 The responsibility of laboratory workers

Laboratory workers carry out laboratory examinations to provide information for clinical staff in order to benefit patients. They therefore play an important role in helping patients to get better. At the same time, in the course of their work, they gain a lot of information about patients and their illnesses. Laboratory workers, like clinical staff, must regard this information as strictly confidential; only the clinical staff who request the examinations should receive the reports on them. When patients enquire about test results they should be told to ask the clinical staff.

In most countries there are high moral and professional standards of behaviour for clinical staff and qualified laboratory personnel. Every laboratory worker handling clinical materials must maintain these standards.

### 1.4 Units of measurement

In the laboratory you will work extensively with both quantities and units of measurement, and it is important to understand the difference between them.

Any measurable physical property is called a *quantity*. Note that the word “quantity” has two meanings; the scientific meaning just defined and the everyday meaning “amount of”. In scientific usage height, length, speed, temperature and electric current are quantities, whereas the standards in which they are measured are *units*.

#### 1.4.1 Quantities and units in the clinical laboratory

Almost all your work in the laboratory will involve making measurements of quantities and using units for reporting the results of those measurements. Since the health — and even the life — of a patient may depend on the care with which you make a measurement and the way in which you report the results, you should thoroughly understand:

- the quantities you measure;
- the names that are given to those quantities;
- the units that are used to measure the quantities.

#### 1.4.2 SI units and names for quantities

A simple standardized set of units of measurement has been the goal of scientists for almost two centuries. The metric system was introduced in 1901. Since then this system has been gradually expanded, and in 1960 it was given the name “Système international d’Unités” (International System of Units) and the international abbreviation “SI”. Units of measurement that form part of this system are called “SI units”. These units have been used to an increasing extent in the sciences, especially chemistry and physics, since 1901 (long before they were called SI units), but most of them were introduced into medicine only after 1960.

To accompany the introduction of SI units, medical scientists prepared a systematic list of names for quantities. Some of these names are the same as the traditional ones; in other cases, however, the traditional names were inaccurate, misleading or ambiguous, and new names were introduced to replace them.

This manual uses SI units and the currently accepted names for quantities. However, since traditional units and names for quantities are still used in some laboratories, these are also included and the relationship between the two is explained.

The following section gives a brief description of the SI units and of the quantity names that are used in this manual.

### SI units used in this manual

All SI units are based on seven *SI base units*. Only four of them are used in this manual; they are listed in Table 1.1.

**Table 1.1 SI base units used in this manual**

Quantity	Unit name	Symbol
Length	metre	m
Mass	kilogram	kg
Time	second	s
Amount of substance	mole	mol

The first three of these units will be familiar to you, although the quantity names “mass” and “amount of substance” and the unit name “mole” may need explanation.

*Mass* is the correct term for what is commonly called “weight”. (There is a technical meaning of the term “weight”: it is a measure of the force with which the earth’s gravity attracts a given mass. Mass, on the other hand, is independent of the earth’s gravitational attraction. The two terms are mixed up in everyday usage; furthermore, we speak of measuring a mass as “weighing”.) “Amount of substance” and its unit, *mole*, are important terms in medicine and they will affect your work in the laboratory more than any other quantities or SI units. When two or more chemical substances react together, they do not do so in relation to their mass. For example:

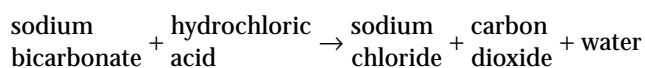

In this reaction 1 kg (1 kilogram) of sodium bicarbonate does not react with 1 kg of hydrochloric acid; in fact, 1 mol (1 mole) of sodium bicarbonate reacts with 1 mol of hydrochloric acid. Whenever chemical substances interact, they do so in relation to their relative molecular mass (the new name for what used to be called “molecular weight”). Use of the mole, which is based on the relative molecular mass, therefore gives a measure of equivalent amounts of two or more different substances (use of mass units does not).

Most of the SI units are called *SI derived units*. These are obtained by combining the SI base units (by multiplication or division) as appropriate. Some common SI derived units are shown in Table 1.2.

**Table 1.2 SI derived units used in this manual**

Quantity	Unit name	Symbol
Area	square metre	m <sup>2</sup>
Volume	cubic metre	m <sup>3</sup>
Speed	metre per second	m/s or ms <sup>-1</sup>

The unit of area is metre × metre = metre squared or square metre; the unit of volume is metre × metre × metre = metre cubed or cubic metre; and the unit of speed is metre divided by second = metre per second. All the SI derived units are obtained in this simple way. In some cases, however, it is necessary to multiply and

divide several times, and the resulting expression becomes very cumbersome; for example, the unit of pressure is kilogram divided by (metre  $\times$  second  $\times$  second). To avoid this difficulty such units are given special names. For example, the unit of pressure is called the pascal.

If the SI base units and derived units were the only ones available, measurements would be difficult because these units are too large or too small for many purposes. For example, the metre is far too large to be convenient for measurement of the diameter of a red blood cell (erythrocyte). To overcome this difficulty, the SI incorporates a series of prefixes, called *SI prefixes*, which when added to the name of a unit multiply or divide that unit by a certain factor, giving decimal multiples or submultiples of the unit. The SI prefixes used in this manual are listed in Table 1.3.

**Table 1.3 SI prefixes**

Factor	Prefix	Symbol
Multiply by 1 000 000 or 1 million ( $\times 10^6$ )	mega	M
Multiply by 1000 ( $\times 10^3$ )	kilo	k
Divide by 100 ( $\times 0.01$ or $10^{-2}$ )	centi	c
Divide by 1000 ( $\times 0.001$ or $10^{-3}$ )	milli	m
Divide by 1 000 000 ( $\times 0.000 001$ or $10^{-6}$ )	micro	$\mu$
Divide by 1000 million ( $\times 0.000 000 001$ or $10^{-9}$ )	nano	n

For example, 1 kilometre (1 km) = 1000 metres (1000 m); 1 centimetre (1 cm) = 0.01 metre (0.01 m or  $10^{-2}$  m); 1 millimetre (1 mm) = 0.001 metre (0.001 m or  $10^{-3}$  m); and 1 micrometre (1  $\mu$ m) = 0.000 001 metre (0.000 001 m or  $10^{-6}$  m). These prefixes have the same meaning when they are applied to any other unit.

### Quantity names used in this manual

Certain names for quantities were introduced to accompany the change to SI units. Most of these names are used to describe concentration and related quantities.

#### *Units for measurement of concentration*

The difficulty with concentration is that it can be expressed in different ways. Traditionally all of these were called simply “concentration”, which was misleading. Now each different way of expressing concentration has its own special name. Before these names can be described, it is necessary to explain the unit of volume called the “litre” (l). You are probably familiar with this unit of volume, and may have been surprised that it has not already been mentioned. This is because the litre is not an SI unit.

The SI derived unit of volume is the cubic metre, but this is far too large to be convenient for measurements of body fluids. A submultiple of the cubic metre is therefore used; the cubic decimetre. The prefix “deci” was not listed above because it is not used in this manual, but it means division by 10 (or multiplication by 0.1 or  $10^{-1}$ ). A decimetre is therefore 0.1 m, and a cubic decimetre is  $0.1 \times 0.1 \times 0.1 \text{ m}^3 = 0.001 \text{ m}^3$  (or  $10^{-3} \text{ m}^3$ ; that is, one-thousandth of a cubic metre). The name “litre”, although not part of the SI, has been approved for use as a special name for the cubic decimetre. The litre and its submultiples, such as the millilitre (ml), are used mainly for measuring relatively small volumes of liquids and sometimes gases; volumes of solids and large volumes of liquids and gases are usually measured in terms of the cubic metre or one of its multiples or submultiples. The litre is the unit used in the clinical laboratory for reporting all concentrations and related quantities. However, you may encounter (for example, on graduated glassware) volumes



**Table 1.4 SI derived units of volume**

Unit name	Symbol	Equivalent in cubic metres (m <sup>3</sup> )	Unit name	Symbol	Equivalent in litres (l)	Equivalent in millilitres (ml)
Cubic decimetre	dm <sup>3</sup>	0.001	litre	l	1	1000
—	100 cm <sup>3</sup>	0.0001	decilitre <sup>a</sup>	dl	0.1	100
—	10 cm <sup>3</sup>	0.000 01	centilitre <sup>a</sup>	cl	0.01	10
Cubic centimetre	cm <sup>3</sup>	0.000 001	millilitre	ml	0.001	1
Cubic millimetre	mm <sup>3</sup>	0.000 000 001	microlitre	μl	0.000 001	0.001

<sup>a</sup>Seldom used in the laboratory.

marked in terms of submultiples of the cubic metre. The equivalent submultiples of the cubic metre and of the litre are listed in Table 1.4.

Having explained the litre, we can now return to the names for different ways of expressing concentration. First, suppose that we have a solution of salt. The mass of dissolved salt divided by the volume of solution is called the *mass concentration*. A more general definition of mass concentration is “the mass of a given component (e.g. a dissolved substance) divided by the volume of solution”. The unit in which it is measured is gram (or milligram, microgram, etc.) per litre. In the SI mass concentration is rarely used; it is used only for substances such as proteins whose relative molecular mass is uncertain.

Now suppose that we have another solution of salt, only this time the amount of dissolved salt is expressed in terms of the “amount of substance”. The amount of substance of salt (that is, the number of moles of salt) contained in the solution divided by the volume of the solution is called the amount of substance concentration, or, for short, the *substance concentration*. The unit in which substance concentration is measured is mole (or millimole, micromole, etc.) per litre. When SI units are used all concentrations are expressed in terms of substance concentration wherever possible.

This use of substance concentration instead of mass concentration is the most important difference between the use of SI units and the use of traditional units.

In the traditional system mass concentration was used almost exclusively. However, mass concentration was not, in the traditional system, always expressed in terms of “per litre”. Sometimes “per litre” was used, sometimes “per 100 ml” (0.1 litre), and sometimes “per millilitre”. Different countries (and even different laboratories in the same country) followed different practices, making for considerable confusion.

For particles or entities that are not dissolved, a different quantity must be used. For example, the blood contains many different kinds of cell. These cells are suspended in the blood, and we must have a way of expressing the number of cells in each litre of blood. In this case the quantity name is the *number concentration*, which is defined as “the number of specified particles or entities in a mixture divided by the volume of the mixture”. The unit in which number concentration is measured is number per litre.

In the traditional system number concentration was called a “count” and it was expressed in the unit “number per cubic millimetre”.

Sometimes the quantity that is of concern is not the actual number of cells per litre (number concentration) but the proportion of cells of a given type — that is, the fraction of the total number that is accounted for by cells of that type. This quantity is called the *number fraction*, and it is expressed as a fraction of 1.0 (unity). At first sight this may seem a little confusing, but it is really very simple. Unity or 1.0 represents the whole, 0.5 represents one-half, 0.2 one-fifth, 0.25 one-quarter, 0.1 one-tenth, and so on. For example, five kinds of leukocyte occur in the blood. The

number fraction of each type might be 0.45, 0.35, 0.10, 0.08 and 0.02. (If you add these fractions, you will find that the total is 1.0 — the whole.)

In the traditional system this quantity had no name and results were reported as percentages instead of fractions. For example, a number fraction of 0.5 was reported as 50%, and a number fraction of 0.08 was reported as 8%. From this you will see that percentage divided by 100 gives the number fraction.

Another quantity that is expressed as a fraction of 1.0 is the *volume fraction*. This is defined as the volume of a specified component of a mixture divided by the total volume of the mixture. For example, if the total volume occupied by all the erythrocytes in 1 litre (1000 ml) of blood is 450 ml, the erythrocyte volume fraction is  $450/1000 = 0.45$ . The erythrocyte volume fraction is important for the diagnosis of many diseases and you will often measure it in the laboratory.

In the traditional system volume fraction had no special name: instead, each different volume fraction had a different name. Erythrocyte volume fraction, for example, was called “packed cell volume” (which was misleading because it did not specify what kind of cell was measured and because it was reported as a percentage, not as a volume).

From the above explanation you will see that number fraction is “number per number” and volume fraction is “volume per volume” — that is, they are both ratios.

Table 1.5 lists metric and traditional quantity names and units, with conversion factors.

**Table 1.5 Metric and traditional quantity names and units**

Quantity name	SI unit	Traditional quantity name	Traditional unit	Conversion factors and examples <sup>a</sup>
Erythrocyte number concentration (see section 9.5)	no. $\times 10^{12}/l$	erythrocyte count	million/ $mm^3$	No conversion factor: $4.5 \text{ million}/mm^3 = 4.5 \times 10^{12}/l$ $5.0 \times 10^{12}/l = 5.0 \text{ million}/mm^3$
Erythrocyte volume fraction (see section 9.4)	1	packed cell volume (haematocrit)	%	Packed cell volume $38\% \times 0.01 =$ erythrocyte volume fraction 0.38 Erythrocyte volume fraction $0.4$ $\times 100 =$ packed cell volume 40%
Leukocyte number concentration (blood) (see section 9.6)	no. $\times 10^9/l$	leukocyte count (blood)	no./ $mm^3$	$8000/mm^3 \times 0.001 = 8.0 \times 10^9/l$ $7.5 \times 10^9/l \times 1000 = 7500/mm^3$
Leukocyte number concentration (CSF) (see section 8.3.3)	no. $\times 10^6/l$	leukocyte count (CSF)	no./ $mm^3$	No conversion factor: $27/mm^3 = 27 \times 10^6/l$ $25 \times 10^6/l = 25/mm^3$
Leukocyte type number fraction (blood and CSF) (e.g. lymphocyte number fraction; see sections 9.13 and 8.3.3)	1	differential leukocyte count (e.g. lymphocytes)	%	Lymphocytes $33\% \times 0.01 =$ lymphocyte number fraction 0.33 Lymphocyte number fraction $0.33 \times 100 =$ lymphocytes 33%
Reticulocyte number concentration (see section 9.12)	no. $\times 10^9/l$	reticulocyte count	no./ $mm^3$	$86\,000/mm^3 \times 0.001 = 86.0 \times 10^9/l$ $91.5 \times 10^9/l \times 1000 = 91\,500/mm^3$
Reticulocyte number fraction <sup>b</sup> (see section 9.12)	no. $\times 10^{-3}$	reticulocyte count	%  ‰	$0.5\% \times 10 = 5 \times 10^{-3}$ $12 \times 10^{-3} \times 0.1 = 1.2\%$  $5\text{‰} = 5 \times 10^{-3}$ $12 \times 10^{-3} = 12\text{‰}$

Table 1.5 (cont.)

Quantity name	SI unit	Traditional quantity name	Traditional unit	Conversion factors and examples <sup>a</sup>
Thrombocyte number concentration (see section 9.14)	no. × 10 <sup>9</sup> /l	platelet count	no./mm <sup>3</sup>	220 000/mm <sup>3</sup> × <u>0.001</u> = 220 × 10 <sup>9</sup> /l 250 × 10 <sup>9</sup> /l × <u>1000</u> = 250 000/mm <sup>3</sup>
Glucose, substance concentration (blood and CSF) (see sections 10.1 and 8.3.4)	mmol/l	glucose, mass concentration <sup>c</sup> (blood and CSF)	mg/100 ml	81 mg/100 ml × <u>0.0555</u> = 4.5 mmol/l 4.2 mmol/l × <u>18.02</u> = 75.7 mg/100 ml
Haemoglobin (Fe), substance concentration (see section 9.3)	mmol/l	haemoglobin, mass concentration <sup>c</sup>	g/100 ml	Hb 13.7 g/100 ml × <u>0.621</u> = Hb(Fe) 8.5 mmol/l Hb(Fe) 9 mmol/l × <u>1.61</u> = Hb 14.5 g/100 ml
Haemoglobin, mass concentration (see section 9.3)	g/l	haemoglobin, mass concentration <sup>c</sup>	g/100 ml	14.8 g/100 ml × <u>10</u> = 148 g/l 139 g/l × <u>0.1</u> = 13.9 g/100 ml
Mean erythrocyte haemoglobin (Fe) substance concentration (see section 9.4)	mmol/l	mean corpuscular haemoglobin concentration (i.e. mass concentration) <sup>d</sup>	% <sup>e</sup>	35% × <u>0.621</u> = 21.7 mmol/l 22 mmol/l × <u>1.611</u> = 35.4%
Mean erythrocyte haemoglobin mass concentration (see section 9.4)	g/l	mean corpuscular haemoglobin concentration (i.e. mass concentration)	% <sup>e</sup>	35% × <u>10</u> = 350 g/l 298 g/l × <u>0.1</u> = 29.8%
Protein, mass concentration (CSF) (see section 8.3.5)	g/l	protein, mass concentration <sup>c</sup>	mg/100 ml g/l	25 mg/100 ml × <u>0.01</u> = 0.25 g/l 0.31 g/l × <u>100</u> = 31 mg/100 ml No change
Urea, substance concentration (blood) (see section 10.2)	mmol/l	urea, mass concentration <sup>c</sup> urea nitrogen, <sup>e</sup> mass concentration	mg/100 ml mg/100 ml	15 mg/100 ml × <u>0.167</u> = 2.5 mmol/l 2.9 mmol/l × 6.01 = 17.4 mg/100 ml urea nitrogen 7 mg/100 ml × <u>0.357</u> = urea 2.5 mmol/l

CSF: cerebrospinal fluid.

<sup>a</sup>The examples show first the conversion of actual numerical values in traditional units into values in SI units, and then the conversion from SI into traditional units. The conversion factor is underlined.

<sup>b</sup>In this case, the number fraction is reported not as a fraction of 1, but as a fraction of 1000, in order to avoid inconveniently small numerical values.

<sup>c</sup>Mass concentration is what was measured, but the term "mass concentration" was not usually used.

<sup>d</sup>Mean corpuscular haemoglobin concentration was sometimes expressed as a decimal fraction rather than a percentage, e.g. 0.35 instead of 35%. In this case, each of the conversion factors listed must be multiplied or divided by 100, as in the following examples:

$$\begin{aligned} 0.35 \times 62.1 &= 21.7 \text{ mmol/l} \\ 22 \text{ mmol/l} \times 0.01611 &= 0.354 \\ 0.35 \times 1000 &= 350 \text{ g/l} \\ 298 \text{ g/l} \times 0.001 &= 0.298 \end{aligned}$$

<sup>e</sup>In the traditional system urea was sometimes reported in terms of urea and sometimes in terms of urea nitrogen (i.e. the nitrogen content of the urea).



# Part I





## 2. Setting up a peripheral health laboratory



### 2.1 Plan of a peripheral medical laboratory

#### 2.1.1 A one-room laboratory

Figure 2.1 sets out the possible arrangement of a peripheral medical laboratory attached to a health centre. It shows a laboratory suitable for carrying out some or all of the techniques described in the manual. The plan is limited to one room, since often this is all the space that is available for the laboratory. The room should measure at least 5 m × 6 m.

Figure 2.2 indicates another possible arrangement of a peripheral laboratory. It can obviously be modified to suit different circumstances.

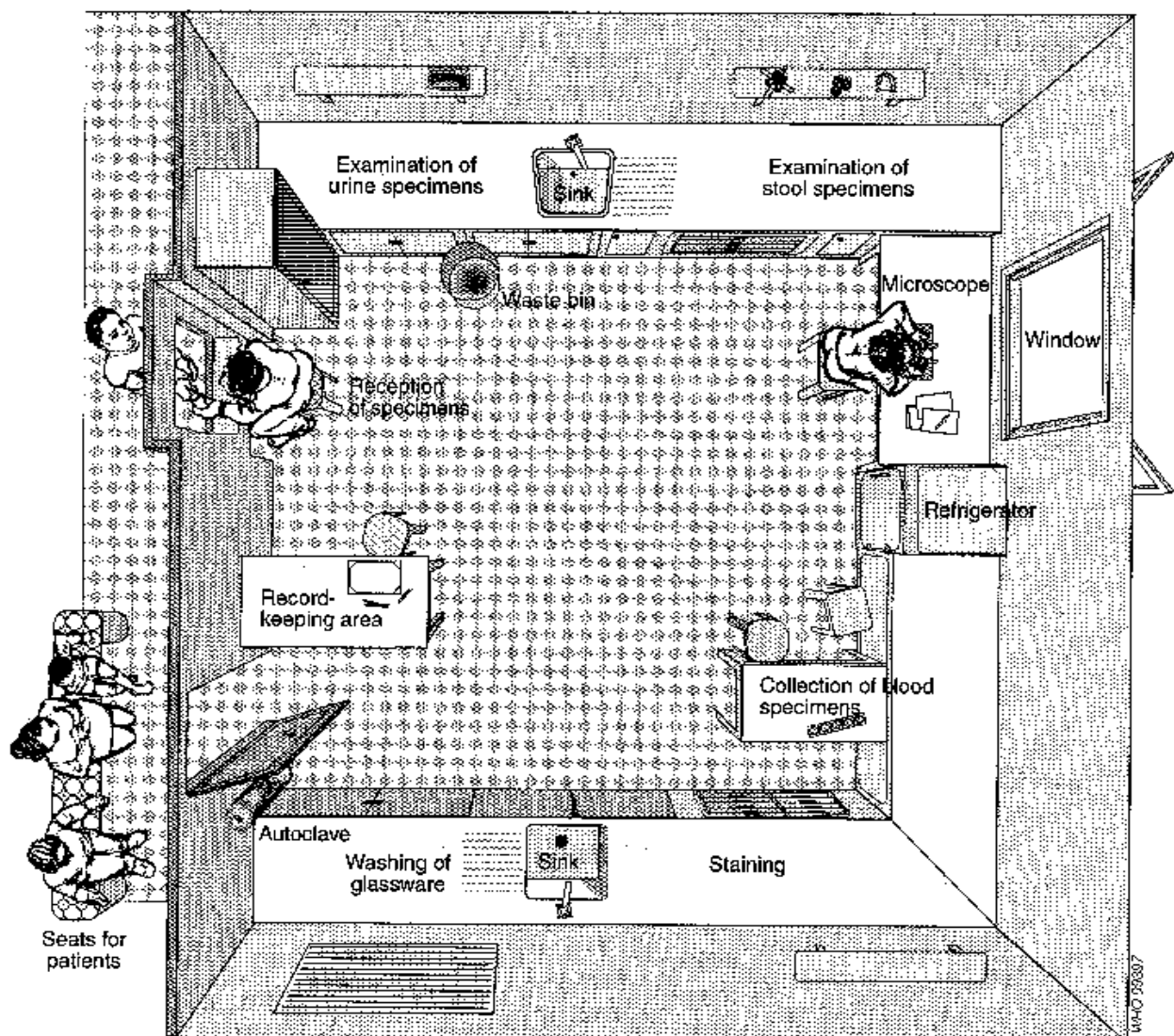

Fig. 2.1 Plan for a one-room laboratory

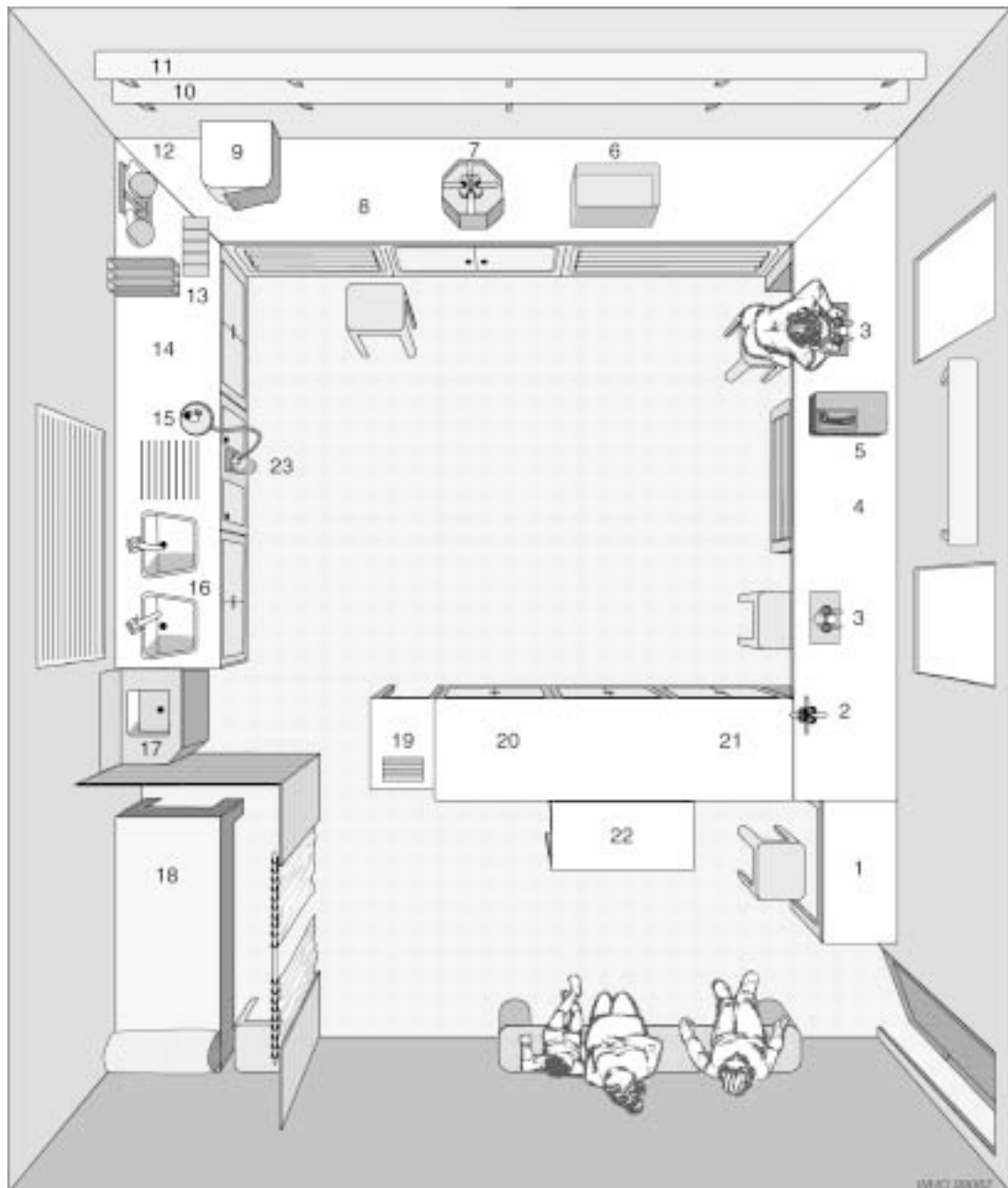

Fig. 2.2 **Alternative plan for a one-room laboratory**  
 1: outpatient's table; 2: hand-operated centrifuge; 3: microscopes; 4: haematology area; 5: colorimeter; 6: water-bath; 7: electric centrifuge; 8: syphilis serology and biochemistry area; 9: reagent refrigerator; 10: reagent shelf; 11: glassware shelf; 12: balance; 13: staining box; 14: area for examination of sputum specimens; 15: Bunsen burner; 16: sinks; 17: waste sink; 18: bed for patients; 19: record-keeping area; 20: area for examination of stool specimens; 21: area for examination of urine specimens; 22: area for reception of specimens; 23: gas bottle.

### 2.1.2 A two-room laboratory

If two rooms are available, it is recommended that the second be used for washing and sterilization. Dirty and/or contaminated material should be removed from the laboratory working area as quickly as possible, both for the safety of the workers and to avoid errors and cross-contamination.

## 2.2 Electricity

A reliable energy supply should be available to ensure continuity of the work in a laboratory. The energy can be provided from the following sources:



- mains electricity supply
- generators
- solar energy supply system.

Remote laboratories often have problems in ensuring a continuous supply of electrical power and may need to generate electricity by using a local generator or a solar energy supply system.

### 2.2.1 Sources of electricity

#### Generators

Electrical energy can be provided by a fuel generator. It is possible to use the combustion engine of a motor car or a purpose-built generator. A purpose-built generator produces an alternating current of 110 volts (V) or 220 V and can usually generate more energy than a car engine. A car engine provides a direct current of 12 V or 24 V, which can be fed into rechargeable batteries (see below).

The type of current available will limit the selection of laboratory equipment; for example, an instrument that requires direct current can be supplied with energy from:

- batteries
- a direct current network with a transformer
- an alternating current network with a converter.

The installation of a direct current network is simple and it is safe to operate. However, for instruments that require a low-voltage (6 V, 12 V or 24 V) direct current, the high voltage produced from the direct current network must be converted by means of a transformer. Alternatively, for instruments that require alternating current (110 V, 220 V or 240 V), the direct current must be converted into alternating current by means of an inverter. Inverters are heavy and expensive and significant energy losses occur in the conversion process. It is therefore preferable to use either direct current or alternating current appliances, depending on your supply, and avoid the need for conversion.

If no generator is available or if a mains power supply is accessible, but the electrical current fluctuates or is prone to frequent breakdowns, a solar energy supply may be preferable (see below).

#### Solar energy supply systems (photovoltaic systems)

A laboratory with a few instruments with low energy requirements can work with a small energy supply. For laboratories located in remote areas, a solar energy supply system may be more suitable than a generator since there are no problems of fuel supplies and it can be easily maintained.

A solar energy supply system has three components:

- solar panel(s)
- an electronic charge regulator
- batteries.

#### *Solar panels*

Two different types of solar panel are commercially available:

- panels with cells of crystalline silicon
- panels with cells of amorphous silicon.

Amorphous silicon panels are less expensive, but produce solar energy less efficiently than crystalline silicon panels.

Solar panels must be installed so that they are exposed to direct light, since shade reduces the efficiency of energy production. They should be inclined at an angle of 15°. The underside of the panel must be freely ventilated. The minimum distance of the underside of the panel from the surface of the supporting construction must be more than 5 cm to avoid heating of the panel, which would reduce the efficiency of energy production.

### *Electronic charge regulators*

A charge regulator controls the charging and discharging of the batteries automatically. When the battery voltage falls below a threshold value during discharge, the laboratory instrument will be disconnected from the battery. On the other hand, if the voltage increases above a threshold value (e.g. when the battery is recharged), the solar panel will be disconnected from the battery. A good charge regulator adapts the maximal voltage of the battery to the change in the temperature of the ambient environment. This prevents the loss of water in the battery by evaporation. It is important to keep a spare charge regulator in stock in case of breakdown. The charge regulator chosen should be stable under tropical conditions. It is advisable to choose a charge regulator with an integrated digital display that allows the battery charge to be monitored easily.

### *Batteries*

#### *Lead batteries*

Solar energy systems require rechargeable batteries, which may be either lead or nickel-cadmium (Ni-Cd) batteries. Lead batteries are preferred and many types are available commercially (see Table 2.1). High-efficiency batteries have practical advantages, although they are more expensive than normal batteries.

When purchasing batteries choose 12 V batteries with the highest capacity (1000 ampere-hours (Ah)).

Several types of maintenance-free lead batteries are commercially available, but they are expensive and less efficient than those that require maintenance. The development of this type of battery is still in progress; it has not been thoroughly tested in tropical climates. Therefore, the maintenance-free batteries are not recommended.

#### *Transport of lead batteries*

Lead batteries should be emptied before being transported. It is important to remember that if lead batteries are to be transported by air they *must* be empty of electrolyte solution, which should be replaced on arrival at the destination.

**Table 2.1 Specifications for batteries used for solar power supply**

Specification	Type of battery			
	Nickel-cadmium	Lead-calcium antimony (2%)	Lead-calcium antimony (6%)	Lead-calcium
Type of electrolyte	liquid	liquid	liquid	liquid
Maximum discharge	100%	80%	80%	50%
Discharge during normal operation	20%	20%	20%	20%
Voltage/cell	1.2V	2V	2V	2V
Self-discharge rate	high	low	medium	low
Topping up required	minimal	infrequent	frequent	infrequent
Capital costs	high	mid-range	mid-range	low
Suitability for photovoltaic use	highly recommended	highly recommended	recommended	not recommended

### *Maintenance of lead batteries*

The daily discharge of lead batteries should not exceed 20% of the batteries' capacity, otherwise the lifetime of the batteries (normally about 1100 recharge cycles), will be shortened. If the batteries are repeatedly discharged to 40% of their capacity, they will last for only about 600 cycles. (There are some special lead batteries available that can be discharged by 40%, but will last for about 3000 recharge cycles.) For maintenance the level of fluid must be checked regularly and when necessary refilled with the distilled water that is used for car batteries.

High-efficiency batteries cannot be replaced by normal car batteries in case of a breakdown. When only car batteries are available to replace a defective high-efficiency battery, all the batteries in the energy storage system must be replaced with car batteries.

### Nickel–cadmium (Ni–Cd) batteries

Ni–Cd batteries can be recharged by a solar panel. Some Ni–Cd batteries are the same size, but have different capacities. The AA-size Ni–Cd battery is available with a capacity from 0.5 Ah up to 0.7 Ah. Choose the batteries with the highest capacity. The small Ni–Cd batteries, type AAA to D, for use in laboratory instruments should be recharged in advance to enable continuous operation in a laboratory. The lifespan of Ni–Cd batteries may be 1000 recharging cycles, depending on their quality.

### *Maintenance of Ni–Cd batteries*

Ni–Cd batteries appear to work unreliably in tropical countries. This apparent unreliability is caused by an increased rate of discharge rather than inefficient recharging of the battery at high ambient temperatures (see below). Such problems may be partially overcome as follows:

- Ni–Cd batteries should be recharged at a low ambient temperature (e.g. in a refrigerator or in a specially constructed recharging box) shortly prior to being used. (For example, only 62% of the energy can be made available from a Ni–Cd battery that was charged at 40 °C.)
- Recharged Ni–Cd batteries should be stored under cool, dry conditions to minimize their rate of self-discharge. (For example, a Ni–Cd battery stored for 2 weeks at 40 °C will have a residual capacity of only 32%.) High humidity will also accelerate the self-discharge of the battery.

## 2.2.2 **Setting up simple electrical equipment**

If the laboratory has an electricity supply the following equipment can be used:

- an electric lamp for the microscope (stable illumination makes adjustment easier);
- an electric centrifuge (much faster than the manually operated type);
- a microhaematocrit centrifuge (for detection of anaemia);
- a spectrophotometer or colorimeter (allows accurate estimation of haemoglobin);
- a water-bath, refrigerator etc.

You may have to make simple connections or repairs to this equipment in the laboratory. The explanations given below are intended to help the laboratory technician to do this and are limited to the steps to follow in each case. Inexperienced persons should start by carrying out the procedures in the presence of an instructor.

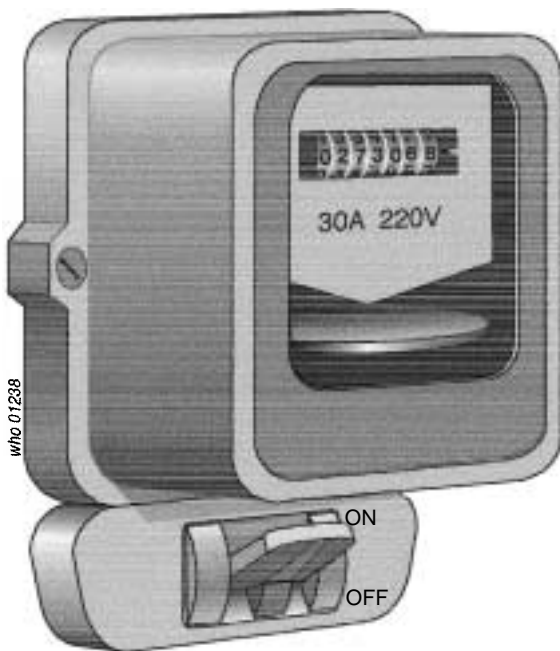

Fig. 2.3 An electricity meter

### The electricity meter (Fig. 2.3)

An electricity meter measures and records the amount of electricity used. It indicates:

- the voltage, measured in volts (220V, 110V, etc.);
- the strength of the current, measured in amperes (A);
- the frequency of the alternating current, e.g. 50 hertz (Hz) (cycles per second).

Some types of meter have switches or buttons:

- a flip-switch that can be flipped one way to cut off the electricity supply to the whole building (the mains fuse) and the other way to restore it;
- a button marked “OFF” that can be pushed to cut off the electricity supply;
- a button marked “ON” that can be pushed to restore the electricity supply.

The flip-switch or “OFF” button also acts as a circuit-breaker, automatically cutting off the current when the circuit is overloaded. When this happens, first find and correct the fault that caused the cut-off, then press the “ON” button or flip the switch to restore the current.

## Setting up new electrical equipment

### Voltage

Check that the voltage marked on the instrument is the same as that of your electricity supply. The instrument has a label on it stating the voltage with which it must be used. The voltage of your electricity supply is marked on your electricity meter.

### Dual-voltage equipment

Dual-voltage instruments can be used with two different voltage supplies.

There is a device on the instrument that enables you to select the appropriate voltage, i.e. the voltage marked on your electricity meter. Depending on the instrument, this device may be:

- a lever or switch that can be moved to the 110V position or the 220V position (Fig. 2.4(a));
- an unwired plug that can be transferred from the 110V position to the 220V position (Fig. 2.4(b));
- a screw that can be turned to the 110V position or the 220V position (Fig. 2.4(c)).

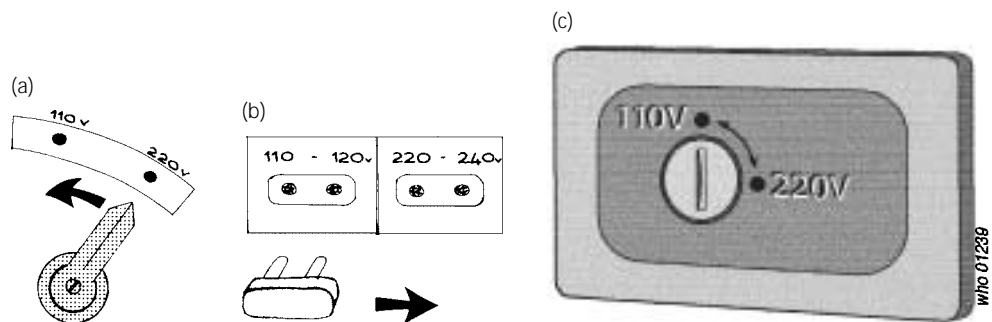

Fig. 2.4 Dual-voltage instruments

### *The electrical power of the instrument*

The electrical power is measured in watts (W) and is marked on the plate that shows the correct voltage for the instrument. Each piece of electrical equipment in the laboratory uses a certain amount of power. The total power used at any one time must not exceed the power of your electricity supply. You can work out how much power is available from the figures shown on the meter: multiply the voltage (V) by the current (A). For example, if the voltage is 220 V and the current is 30 A, the electrical power supplied will be  $220 \times 30 = 6600$  watts or 6.6 kW.

### *Using a transformer*

If an instrument is intended for use with a voltage different from that of the laboratory electricity supply, it can be used with a transformer. For example, if the centrifuge provided only works at 110 V and the voltage of your electricity supply is 220 V, ask for a 110–220 V transformer, indicating the wattage of the centrifuge. Plug the centrifuge into the 110 V connection of the transformer supplied, then plug the 220 V lead from the transformer into the laboratory electricity supply (wall socket).

### *Switching off electrical equipment*

After an instrument has been switched off, it must be unplugged from the wall socket. If left plugged in, it is a fire risk.

## 2.2.3 What to do in case of failure of electrical equipment

If an instrument does not work, check the following:

- the fuses
- the plug at the end of the cable
- the cable
- the wall socket
- the voltage of the instrument and that of the electricity supply.

*Before doing anything, cut off the electricity supply:*

- either by pressing the button or the switch marked “OFF” on the meter
- or by removing the mains fuse (Fig. 2.5).

### **Tools** (Fig. 2.6)

- Screwdriver
- Wire-cutters
- Flat-nose or taper-nose pliers
- Fuse wire
- Various spare parts: plugs, switches, etc.

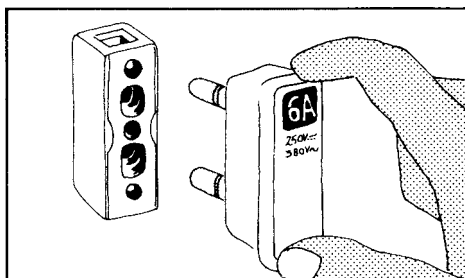

Fig. 2.5 Removing the mains fuse

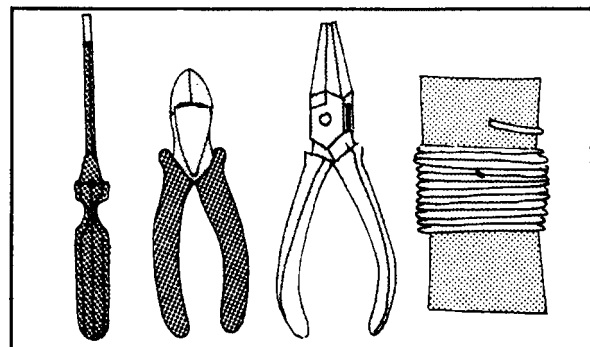

Fig. 2.6 Tools for electrical work

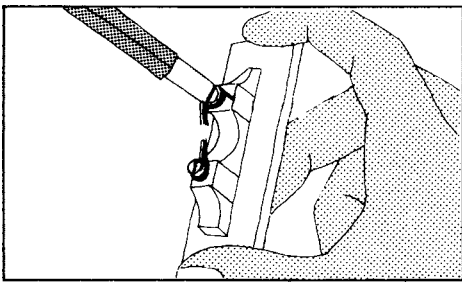

Fig. 2.7 Removing fuse wire from a blown fuse

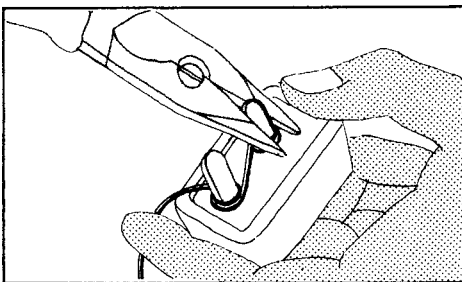

Fig. 2.8 Changing a two-pin fuse

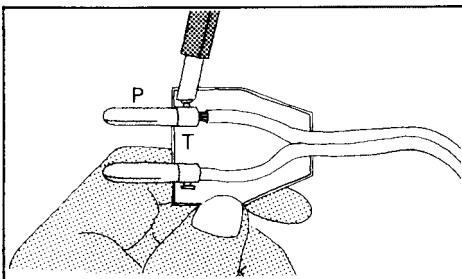

Fig. 2.9 A two-pin plug

### Changing the fuse

Remove the cover from the fuse box.

If it is a screw-type fuse, the fuse wire is stretched between two screws. If the wire is broken or melted, the current no longer passes: the fuse has blown. Loosen the two screws (Fig. 2.7). Remove the old fuse wire. Replace it with new fuse wire of the same gauge (thickness), or with thinner wire if the same size is not available. Fix the wire in an “S” shape, with a loop at either end. The wire must pass beneath the small washers under the screws.

If it is a two-pin fuse, fix the fuse wire to the base of the pins, and then tighten the pins with pliers (Fig. 2.8).

Once the fuse has been repaired, check the whole circuit before switching on the electricity supply.

### Checking the plug

If a fault is suspected in a plug, it must be repaired or replaced. There are many different types of plug; some have a screw on the outside that can be unscrewed so that the cover can be removed.

#### *Two-pin plug* (Fig. 2.9)

Inside the plug, the two wires of the cable are fixed to the terminal screws (T) of the contact pins (P). Check that the terminal screws are tightened. Sometimes this is all that is needed to repair the plug.

#### Fitting a new plug

To fit a new plug, remove the insulating material along a length of 1.0–1.5 cm from the end of each of the two wires making up the cable. This can be done by scraping with a knife but take care not to damage the wire inside. Twist the exposed ends of both wires to allow them to fit neatly into the terminal once the screw has been loosened (Fig. 2.10).

Insert one exposed end into each of the terminals of the plug. Tighten the terminal screws and replace the terminals (Fig. 2.11). The screws should hold the wires firmly; check by pulling the wires gently.

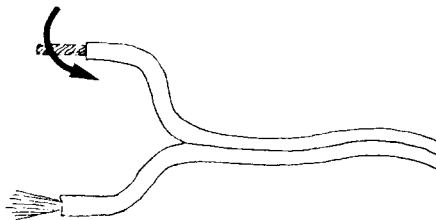

Fig. 2.10 Twist the exposed ends of both wires

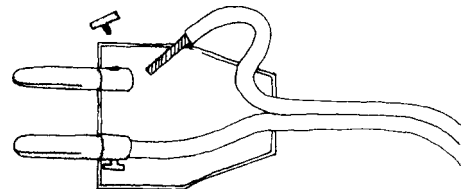

Fig. 2.11 After inserting the wires into the plug terminals, tighten the terminal screws

#### *Three-pin plug* (Fig. 2.12)

Two of the pins are connected to the electricity supply; one is “live” and one is “neutral”. The third (usually the middle) pin is connected to the “ground” or “earth”. It is most important to connect each of the three wires in the cable to the correct pin, and the plug usually contains instructions that should be strictly followed. If there is the slightest doubt, consult an electrician.

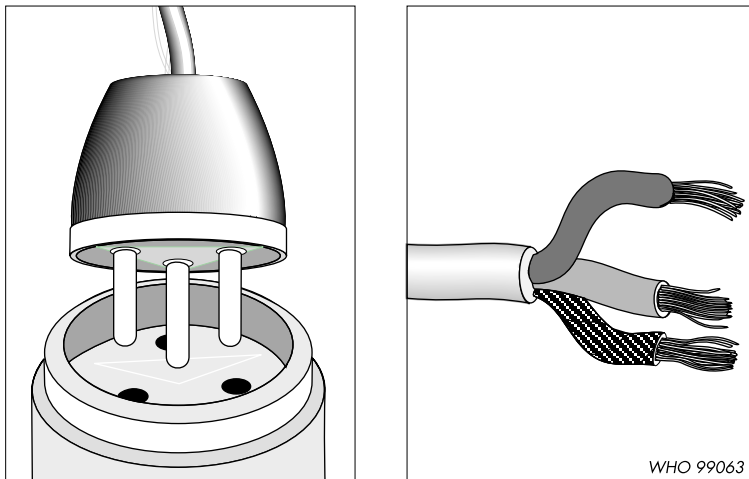

Fig. 2.12 A three-pin plug

The ground or earth wire is covered in *green* or *green and yellow* insulating material. It provides an escape for the electric current in case of poor insulation, thus avoiding passage of the current through the human body.

### Checking the cable or switch

Check to see whether the cable is burned or broken. If so, it should be replaced.

There are many different types of switch. They have to be unscrewed and opened if you want to check that they are working properly. Make sure that the two incoming wires and the two outgoing wires are firmly fixed in their respective terminals (Fig. 2.13).



Fig. 2.13 A switch

### Extension lead

An extension lead is a cable with a male plug (M) on one end and a female plug (F) on the other (Fig. 2.14). The female plug is fixed to the cable by two terminals inside the plug, just as in the normal male plug.

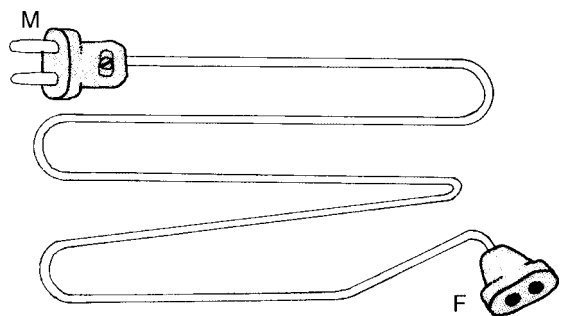

Fig. 2.14 An extension lead

### Checking the wall socket

To check a wall socket, plug in a lamp that you know to be working. Some sockets are fitted with a small replaceable fuse. If this is not the case, it is usually wise to call in an electrician to repair a wall socket.

### Precautions

- Never take electrical equipment apart without first disconnecting the electricity supply.
- Never touch electrical equipment with wet hands (water is a good conductor of electricity).

- Never plug a new piece of equipment into the electricity supply without first checking the plate to see whether the voltage marked is the same as that of the laboratory supply (110V, 220V, etc.).
- Never remove a plug from a socket by pulling the cable.
- Never replace fuse wire with wire that is thicker.

### 2.3 Plumbing: simple procedures

A fault in the plumbing of the laboratory (a dripping tap, a blocked sink, etc.) can hamper laboratory work considerably. Some simple remedies are described below, in case a plumber is not readily available.

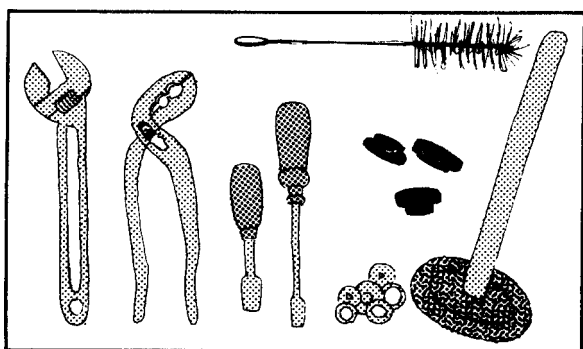

Fig. 2.15 Tools and materials for plumbing repairs

#### 2.3.1 Tools and materials (Fig. 2.15)

- Adjustable wrench
- Pipe wrench
- Set of screwdrivers
- Bottle brush
- Rubber washers for taps
- Rubber stoppers such as those used in penicillin bottles
- Plunger for clearing blocked pipes
- Tow and jointing compound for sealing joints, if available.

*Important:* Before starting any plumbing operation, cut off the water at the mains.

#### 2.3.2 Taps

A tap is made up of two parts (Fig. 2.16):

- the body (B), through which the water flows
- the head (H), which controls the flow of water by means of a rubber washer (W).

Between the head and the body, there is a joint (J) of rubber or tow.

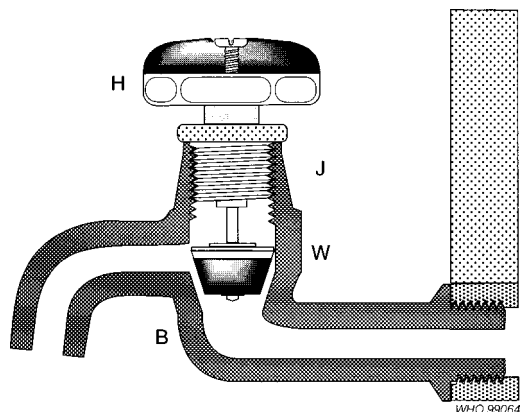

Fig. 2.16 Components of a tap  
B: body; H: head; J: joint; W: washer.



Fig. 2.17 Removing the head of a tap



### What to do if water flows when the tap is turned off

If water continues to flow when the tap is turned off, the washer needs to be replaced.

1. Unscrew the head of the tap using an adjustable wrench (turn in an anticlockwise direction) (Fig. 2.17).
2. Remove the worn washer from the base of the head (B). If the washer is embedded (Fig. 2.18(a)), pull it out. If it is screwed on (Fig. 2.18(b)), unscrew it.
3. Replace it with a new washer of the same type.
4. If the tap continues to leak after the washer has been replaced, the seating (S) that receives the washer (Fig. 2.19(a)) is probably faulty. In this case place a rubber stopper in the hole (Fig. 2.19(b)).

This will act as a temporary seal until a plumber can be called in.

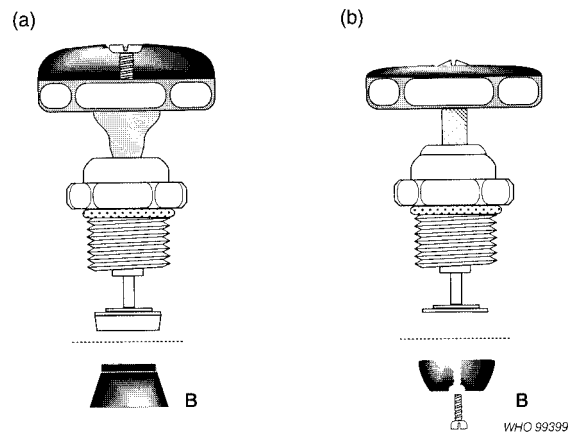

Fig. 2.18 Removing the washer  
B: base of the head of the tap.

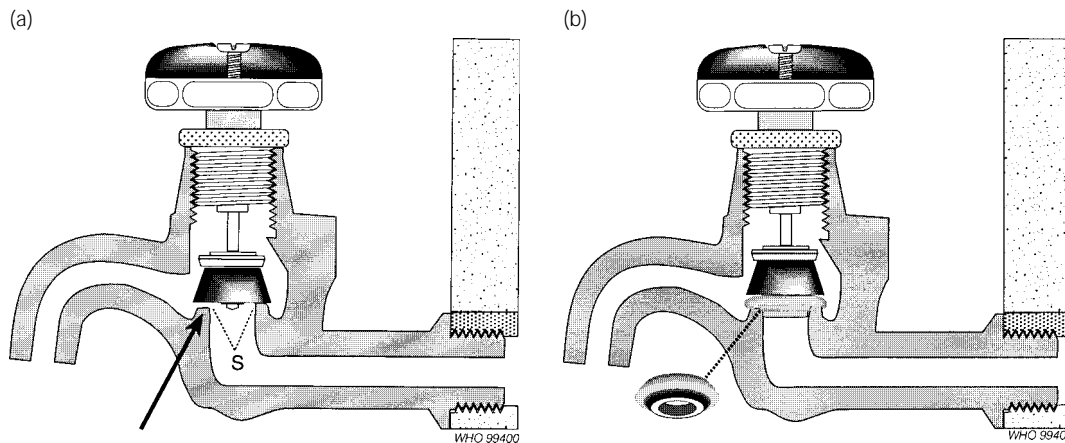

Fig. 2.19 Repairing the seating for the washer  
S: seating.

### What to do if water leaks out of the head of the tap

If water leaks out of the head of the tap, the joint needs to be replaced.

1. Unscrew the head of the tap using an adjustable wrench.
2. Replace the joint with a new one of the same type.

If the joint is made of tow:

1. Remove the old joint, scraping the screw thread with a pointed knife (Fig. 2.20).
2. Wind new tow around the screw thread, starting at the top and winding in a clockwise direction (Fig. 2.21).
3. Smear jointing compound over the tow (Fig. 2.22).
4. Replace the head of the tap on the body and screw down as far as it will go.

### Replacing the whole tap

Unscrew the faulty tap, using a pipe wrench (turn in an anticlockwise direction).

Take the new tap; the body ends in a large screw (S) (Fig. 2.23(a)). Wind tow around the thread and smear with jointing compound as described above.

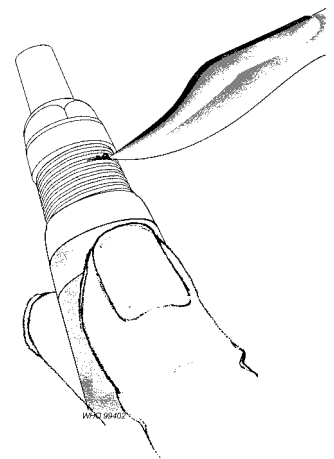

Fig. 2.20 Removing the tow from around the screw thread

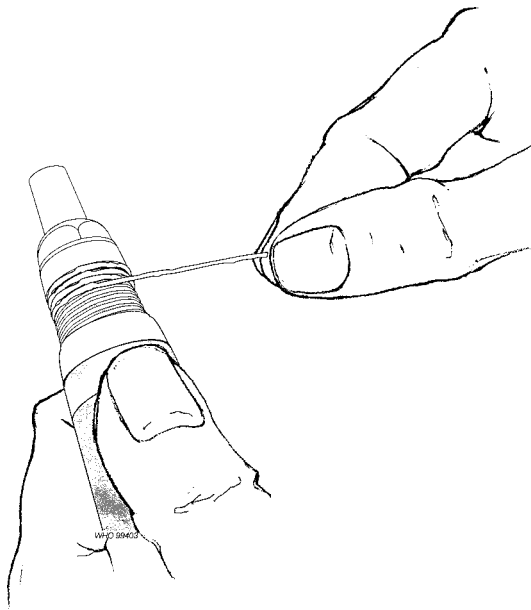

Fig. 2.21 Winding new tow around the screw

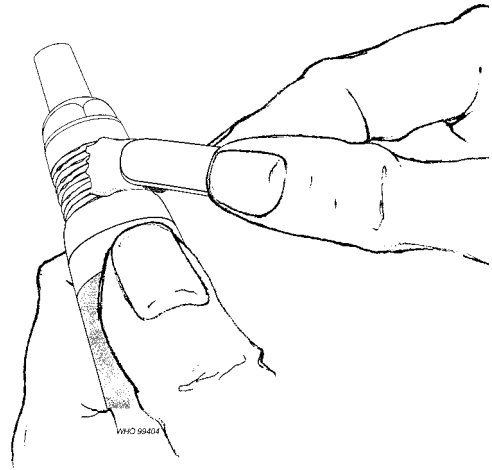

Fig. 2.22 Applying jointing compound to the tow

(a)

(b)

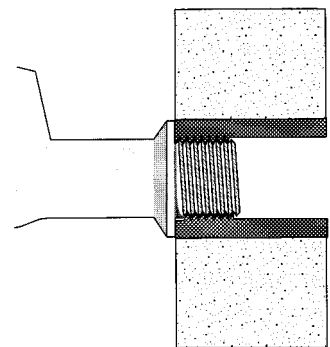
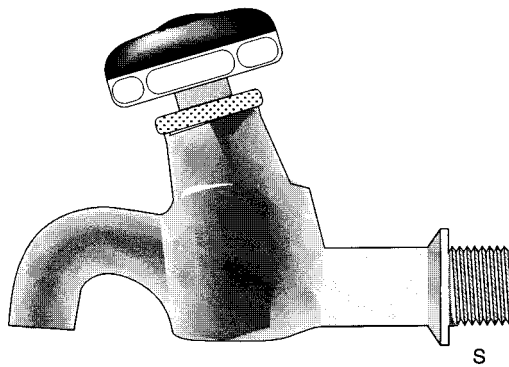

Fig. 2.23 Replacing a tap  
S: screw.

Screw the new tap into the water pipe in the wall in place of the old one (Fig. 2.23(b)). Tighten with the wrench.

### 2.3.3 Sink traps

#### Components of a sink trap (Fig. 2.24)

The sink trap consists of:

- the body, fixed to the sink outflow by a joint (J1);
- the swan neck of the U-shaped trap, fixed to the body by a joint (J2).

The whole trap is attached to the waste pipe by a joint (J3).

The wastewater flows into the trap, which is permanently filled with water (the seal). This prevents foul air from the waste pipes and sewers from coming up into the sink. Sink traps may become blocked so that wastewater from the sink or basin cannot drain away.

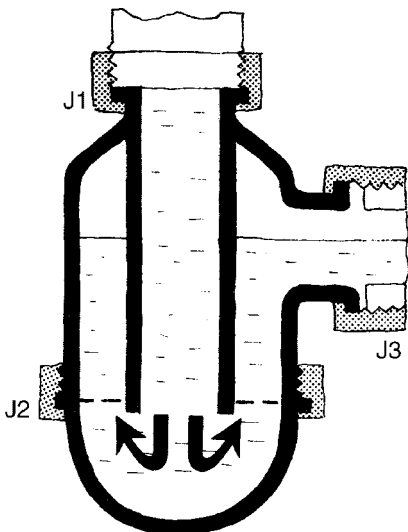

Fig. 2.24 Components of a sink trap  
J1, J2, J3: joints.

### Unblocking with a plunger

Place the plunger over the waste pipe. Let a little water flow around it to help it stick. Press down on the wooden handle to flatten the plunger (Fig. 2.25).

Pull it up and then push it down hard again. Repeat this procedure several times, as fast as you can. The suction caused may break up whatever is blocking the sink.

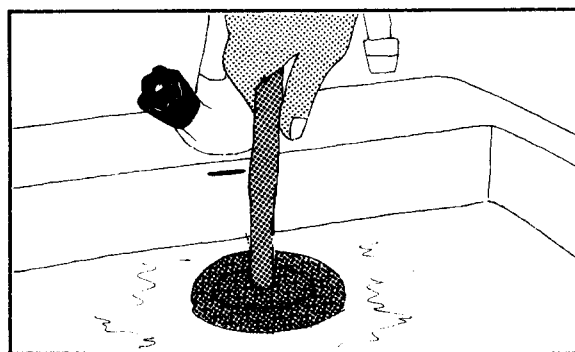

Fig. 2.25 Unblocking a sink with a plunger

### Unblocking with chemicals

Use a commercial product intended for the purpose. Alternatively, use 250 g of sodium hydroxide pellets. Put the pellets in the bottom of the sink or basin, over the waste pipe. Pour 2 litres of boiling water on to the pellets (avoid splashing). Leave for 5 minutes, then rinse the sink thoroughly with cold water from the tap.

*Warning:* Sodium hydroxide solution is highly corrosive and should be used with extreme care. If it is splashed on the skin or in the eyes, wash the affected areas immediately with large quantities of water.

### Unblocking by emptying the sink trap

Place a bucket beneath the trap. Unscrew joint J2 using an adjustable spanner (Fig. 2.26).

Clean the trap with a bottle brush or piece of wire. Clear away all waste material. If there is a white deposit (limescale) in the trap, take it apart completely. Heat the components in diluted acetic acid (20 ml of acid per litre of water).

Reassemble the sink trap.

### What to do if the sink trap is leaking

If foul smells come up through the waste pipe of the sink, the permanent reservoir of water (the seal) at the bottom of the trap must have leaked because of a fault in joint J2. Screw the joint down tightly, or replace it with a new one (Fig. 2.27).

*Important:* Never pour strong acids down a sink, since they can cause corrosion.

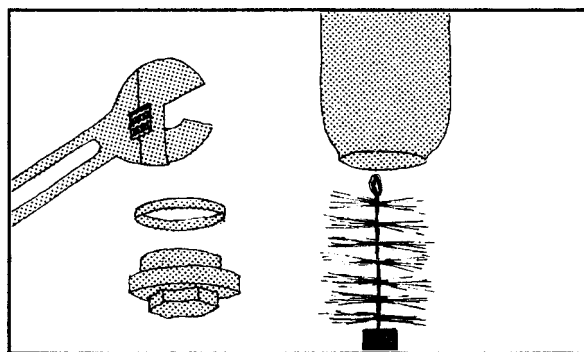

Fig. 2.26 Unblocking a sink by emptying the sink trap

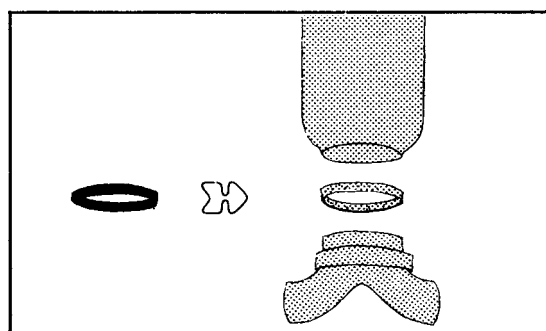

Fig. 2.27 Replacing the seal at the bottom of a sink

## 2.4 Water for laboratory use

The medical laboratory needs an adequate water supply for its work. It requires:

- clean water
- distilled water
- demineralized water (if possible)
- buffered water (if possible).

### 2.4.1 Clean water

To check whether the water supply is clean, fill a bottle with water and let it stand for 3 hours. Examine the bottom of the bottle. If there is a deposit, the water needs to be filtered.

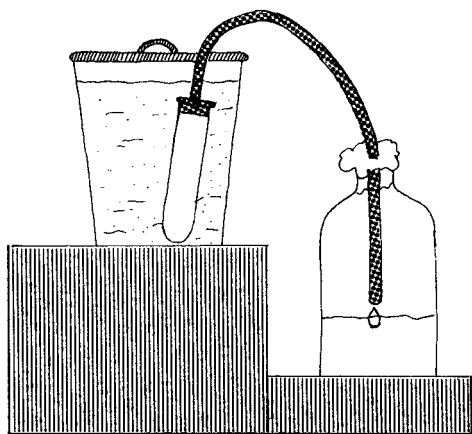

Fig. 2.28 Filtering water using a porous unglazed porcelain or sintered glass filter

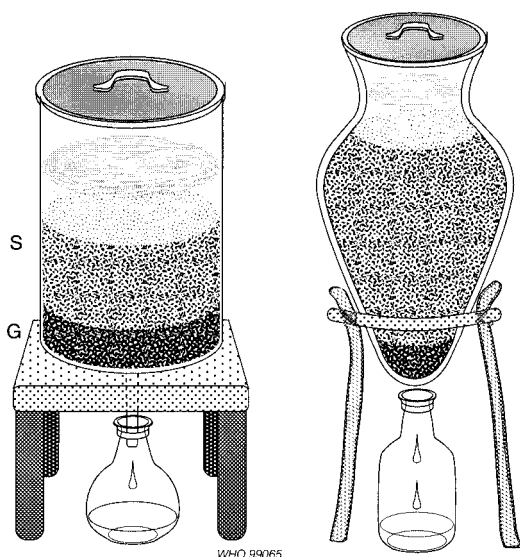

Fig. 2.29 Filtering water using a sand filter  
G: gravel; S: sand.

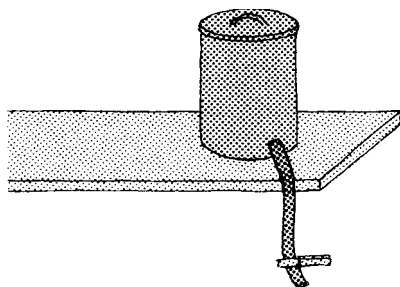

Fig. 2.30 A water distributor

#### Filtering

##### Using a porous unglazed porcelain or sintered glass filter

This type of filter can be attached to a tap. Alternatively, it can be kept immersed in a container of the water to be filtered (Fig. 2.28).

*Important:* Filters of this type must be dismantled once a month and washed in boiling filtered water.

##### Using a sand filter

A sand filter can be made in the laboratory. You will need the following (see Fig. 2.29):

- a filter reservoir (a large container such as a metal drum, a big earthenware pot or a perforated bucket)
- sand (S)
- gravel (G).

*Note:* Water that has been filtered through a sand filter is almost free of particles, but it may contain water-soluble chemical compounds and bacteria.

#### Storage of water

If water is scarce or comes from a tank or well, always keep a large supply in reserve, *preferably in glass or plastic containers*.

Decant water that has been stored before filtering it.

#### Water supply

If there is no running water in the laboratory, set up a distributor as follows (see Fig. 2.30):

1. Place the container of water on a high shelf.
2. Attach a length of rubber tubing to the container so that the water can flow down.
3. Clamp the rubber tubing with a Mohr clip or a small screw clamp.

### 2.4.2 Distilled water

Distilled water is free from nonvolatile compounds (e.g. minerals) but it may contain volatile organic compounds.

#### Preparation

Distilled water is prepared using a still, in which ordinary water is heated to boiling point, and the steam produced is cooled as it passes through a cooling tube where it condenses to form distilled water.

The following types of still are available:

- copper or stainless steel stills (alembics)
- glass stills
- solar stills.

They are heated by gas, kerosene, electricity or solar energy, depending on the type of still.

***Copper or stainless steel alembics*** (Fig. 2.31)

1. Fill the reservoir (R) with the water to be distilled.
2. Connect the cold-water tube (T) to a tap.
3. Heat the reservoir with a Bunsen burner (B) or kerosene heater.

The still can produce 1 or 2 litres of distilled water per hour, depending on the efficiency of the heating system.

Fig. 2.31 **Components of a copper or stainless steel alembic**  
**B: Bunsen burner; C: cooling column; R: reservoir; T: cold-water tube.**

***Glass stills*** (Fig. 2.32)

Glass stills are more fragile, but almost always produce purer water than metal stills. The distillation method is the same. Make sure that the running water circulates freely round the condenser (C). The water can be heated in the flask by the electric element (E).

Fig. 2.32 **Components of a glass still**  
**C: condenser; D: distillate; E: electric element.**

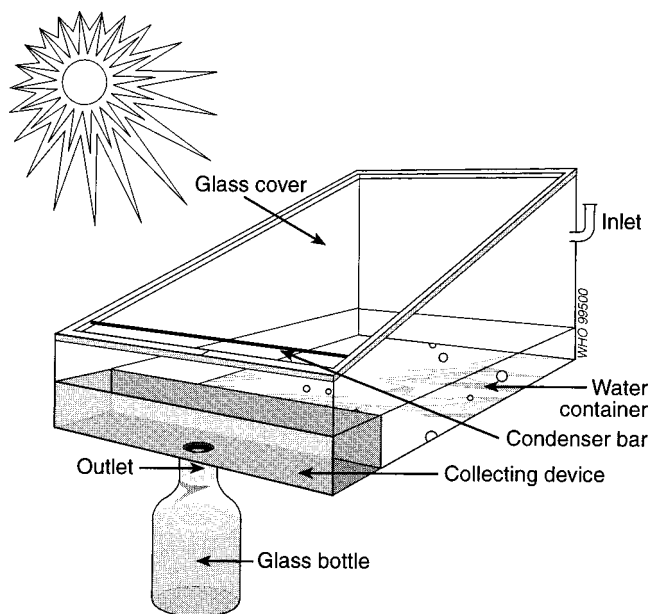

Fig. 2.33 **Components of a solar still**

### **Solar stills** (Fig. 2.33)

For laboratories in remote areas and with limited resources, a simple solar-powered water still can be easily constructed using a clean plastic container with two compartments (one large and one small) and a large surface area, over which is placed a glass cover in a sloping position.

The water is poured into the large compartment from which it is evaporated by the sun. It condenses on the glass cover and drops into the small compartment. The small compartment has an outlet at the bottom through which the distilled water can pass into a glass bottle placed underneath the container.

In tropical climates 2–7 litres of distilled water can be produced daily from a solar still with a surface area of 1 m<sup>2</sup>.

*Important:*

- Collect the distilled water in a glass or plastic container.
- Do not distil the last quarter of the water heated; it contains residues.

### Quality control

The pH of distilled water is normally between 5.0 and 5.5 (i.e. it is acid).

Use a 1.7% solution of silver nitrate (AgNO<sub>3</sub>) (reagent no. 49) to check for the absence of chloride compounds (e.g. calcium chloride).

Put in a beaker:

- 10 ml of distilled water;
- 2 drops of nitric acid;
- 1 ml of silver nitrate solution.

The water should remain perfectly clear.

If a slight whitish turbidity appears, the distillation process should be repeated.

### Uses

Distilled water is used for the preparation of reagents and as a final rinse for some glassware before drying.

*Important:*

- Do not use commercial distilled water (the type sold for filling car batteries) for the preparation of laboratory reagents.
- Freshly prepared distilled water is preferable; if this is not available, use distilled water stored in glass or plastic containers, which should be washed periodically.
- Always use distilled water prepared the same week.

### 2.4.3 Demineralized water

#### Principle

Demineralized water is free from ions but not necessarily free from organic compounds.

#### Preparation

Demineralized water is prepared by passing ordinary water through a column of ion-exchange resin. The apparatus consists of a long cartridge filled with ion-exchange resin granules. The water filters through the column of granules, which retain all the mineral ions (i.e. all the dissolved mineral salts). Some demineralizers have two cartridges through which the water passes successively (Fig. 2.34).

1. Check that the cartridge is completely filled with ion-exchange resin granules.
2. Connect the inlet tube of the apparatus to the water supply (a tap or a small tank placed above the apparatus). In some models the water flows in at the top of the column, in others it flows in at the bottom.
3. Let the water flow in slowly.
4. Collect the demineralized water in a closed container.

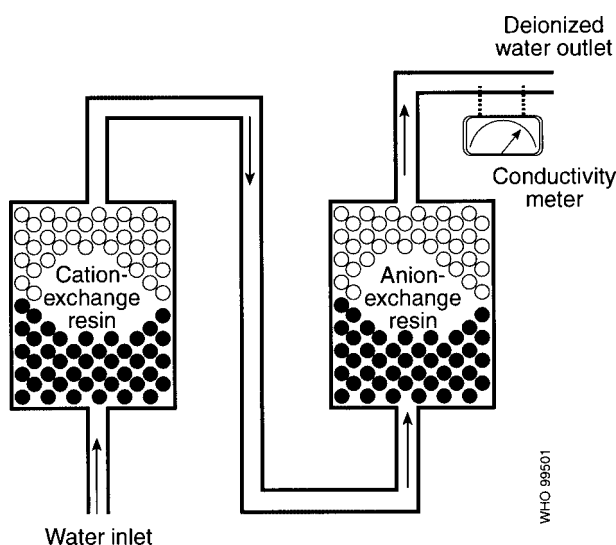

Fig. 2.34 A demineralizer

### Quality control

#### *Apparatus with a control dial*

The dial registers the resistivity of the water resulting from the presence of ions. The more complete the demineralization, the higher the electrical resistivity of the water.

1. Check that the control system is fitted with a battery in good working order.
2. To check that the battery is charged, press the button marked "zero test"; the needle on the dial should swing to zero (Fig. 2.35(a)).
3. Let water flow into the cartridge.
4. When demineralized water begins to flow out at the other end, press the button marked "water test". The needle should register a resistivity of over 2 megaohms/cm ( $2\text{ M}\Omega/\text{cm}$ ) (Fig. 2.35(b)).
5. If the needle stops at a point below  $2\text{ M}\Omega/\text{cm}$  or stays at zero, the cartridge of ion-exchange resin granules has been used for too long and must be replaced or reactivated.

The apparatus may indicate the resistivity ( $\text{M}\Omega/\text{cm}$ ) or the reciprocal value, the conductivity ( $\text{cm}/\text{M}\Omega$  or Siemens, S).

#### *Apparatus without a control dial*

Using an indicator paper, determine:

- the pH of the water supply flowing into the apparatus, and
- the pH of the demineralized water that flows out at the other end.

If the pH remains the same (usually below 6.5), the resin is no longer active. Demineralized water should have a pH between 6.6 and 7.0.

An additional check can be made using a 1.7% solution of silver nitrate (reagent no. 49). Pass a weak solution of sodium chloride (cooking salt) through the resin, then carry out the test described in section 2.4.2 for the quality control of distilled water. If a slight whitish cloudiness appears, the resin must be replaced.



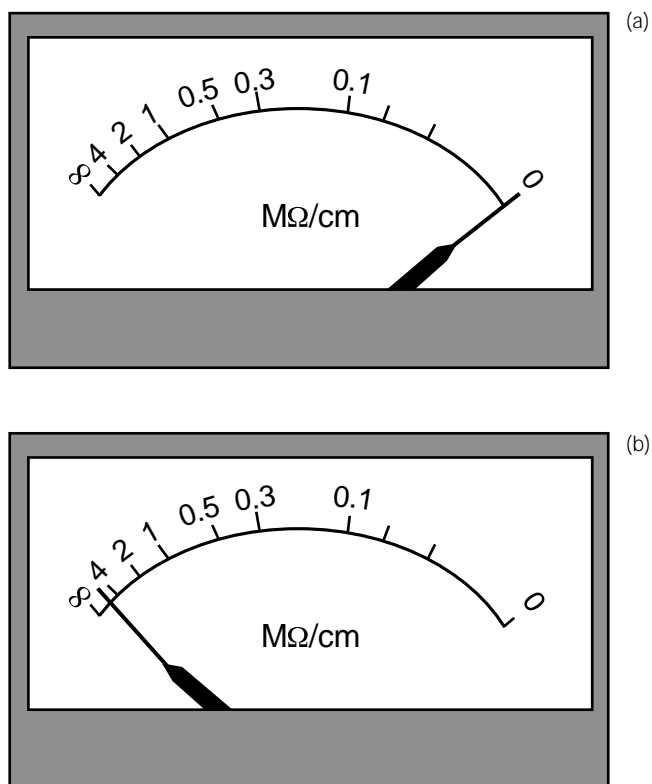

WHO 01.203

Fig. 2.35 Measuring the resistivity of demineralized water

**Change of colour in resin**

If the resin changes colour (e.g. it turns black), consult the instructions for use supplied by the manufacturer.

It may need to be reactivated or replaced, as described below.

**Replacement or reactivation of ion-exchange resin**

This can be done in one of the following ways, depending on the model:

- The cartridge is replaced by another filled with ion-exchange resin granules.
- The column of the apparatus is refilled with ion-exchange resin or a mixture of two resins.
- The exhausted ion-exchange resin is reactivated by passing a solution of ammonia through the apparatus. Follow the instructions supplied by the manufacturer.

**Uses**

Demineralized water can be used for:

- rinsing glassware before drying;
- preparing almost all the reagents used in medical laboratories, including stains.

**2.4.4 Buffered water**

Distilled water is usually acid and demineralized water becomes acid on exposure to the air. For a number of laboratory procedures (preparation of stains, etc.) the

pH of the water has to be around 7.0 (neutral water) and has to be kept neutral. This is achieved, if possible, by dissolving buffer salts in the water (buffered water).

### Materials and reagents

- Measuring cylinders, 10 ml and 1000 ml
- Volumetric flask, 1000 ml
- Universal indicator paper (for measuring pH from 1 to 10)
- Indicator paper of limited pH range: for the 5.0–7.0 range and for the 6.0–8.0 range
- Distilled (or demineralized) water
- Acetic acid, 5% solution (reagent no. 1), diluted 1:10 with distilled water
- Disodium hydrogen phosphate ( $\text{Na}_2\text{HPO}_4 \cdot 2\text{H}_2\text{O}$ ), hydrated
- Phenol red, 1% solution (reagent no. 42)
- Potassium dihydrogen phosphate ( $\text{KH}_2\text{PO}_4$ ), anhydrous
- Sodium carbonate, 0.2% solution (reagent no. 51).

### Method

1. Weigh out accurately 3.76 g of disodium hydrogen phosphate.
2. Transfer the chemical to a 1000-ml volumetric flask through a funnel (Fig. 2.36).
3. Rinse out the weighing container into the volumetric flask several times with water. Rinse the funnel into the flask.
4. Weigh out accurately 2.1 g of potassium dihydrogen phosphate and proceed as in steps 2 and 3.
5. Add a little more water and mix the solution until the chemicals are dissolved.
6. Fill the flask to the 1000-ml mark with water.
7. Replace the flask stopper and mix the solution well.
8. Store the solution in a white glass reagent bottle and keep in a refrigerator.



Fig. 2.36 Transferring disodium hydrogen phosphate into a volumetric flask

9. Dip a strip of the universal indicator paper into the buffer solution and compare the colour obtained with that shown on the standard chart (Fig. 2.37). Read off the pH unit given for the colour that matches the test paper most closely.
10. According to the result obtained, select a strip of indicator paper for the corresponding limited range. For example, if the pH is 6, use indicator paper for the range 5.0–7.0. If the pH is 7.5, use indicator paper for the range 6.0–8.0.
11. Repeat the test, using the paper for the corresponding limited range. Read off the pH of the buffer solution on the standard chart.
12. If the pH is between 7.0 and 7.2, the buffered water is satisfactory. If it is below 7.0, the water is acidic. If the water is acidic, make a fresh solution, using distilled water that has been boiled for 10 minutes in an uncovered round flask (this gets rid of the carbon dioxide).
13. If the water is still acidic after boiling:
  - add five drops of phenol red solution for every litre of water;
  - neutralize by adding sodium carbonate solution, one drop at a time, until the water turns pink (Fig. 2.38).
14. If the water is alkaline (pH above 7.2):
  - add five drops of phenol red solution for every litre of water;
  - neutralize by adding acetic acid solution, one drop at a time, until the water turns orange (Fig. 2.39).

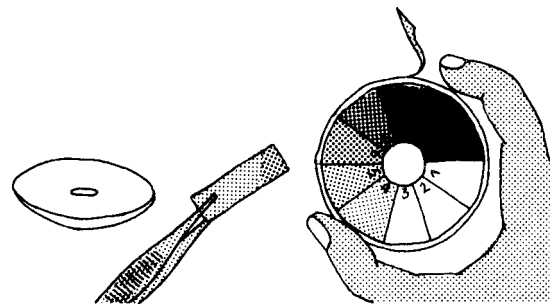

Fig. 2.37 Checking the pH using universal indicator paper

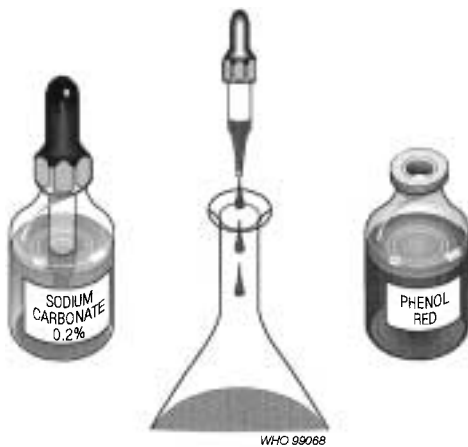

Fig. 2.38 Correcting the pH of acidic buffered water

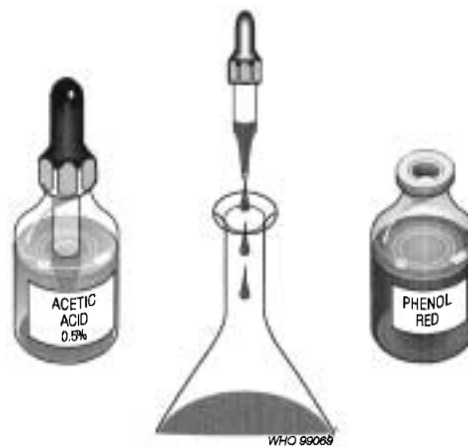

Fig. 2.39 Correcting the pH of alkaline buffered water

If neither disodium hydrogen phosphate nor potassium dihydrogen phosphate is available, neutralize distilled or demineralized water directly, as shown in steps 12–14 above.

*Note:* The pH can also be corrected by adding small quantities of the buffer salts:

- Disodium hydrogen phosphate can be used to increase the pH if the water is acidic (pH below 7.0).
- Potassium dihydrogen phosphate can be added to reduce the pH if the water is alkaline (pH above 7.2).

## 2.5 Equipment

The following is a list of the apparatus needed to equip a laboratory capable of carrying out all the examinations described in this manual. Such a laboratory would usually be located in a small rural hospital (district level) which might have between 60 and 100 beds.

### 2.5.1 Essential laboratory instruments

#### Microscopes<sup>1</sup>

The laboratory should be equipped with two microscopes.

- One microscope is for use in haematology. It should have an inclined binocular tube, a mechanical stage, three objectives ( $\times 10$ ,  $\times 40$ ,  $\times 100$ ), two eyepieces ( $\times 5$ ,  $\times 10$ ), a condenser and an electric lamp that can be connected to the mains electricity supply or a battery.
- The second microscope is for use in other laboratory procedures (parasitology, urine analysis, bacteriology, etc.) and should have an inclined binocular tube and accessories as listed above.

At the health centre level one binocular microscope is sufficient.

#### Centrifuges<sup>2</sup>

It is useful to have two centrifuges:

- an electric centrifuge with a microhaematocrit head attachment and a reader;
- a hand-operated or an electric centrifuge with four buckets.

#### Balance<sup>3</sup>

An analytical balance with a set of weights is necessary if reagents are to be prepared in the laboratory.

If the laboratory is required to prepare a wide range of reagents, a two-pan balance with a corresponding set of weights (see section 3.2.2) is useful.

#### Refrigerator

Reagents (such as those required for pregnancy tests, etc.) and materials (such as certain transport media, specimens, etc.) should be kept in the refrigerator.

#### Water-bath

A water-bath equipped with a thermostat for temperature control is required when samples or materials must be kept at a certain temperature and when measurements must be made at a given temperature.

#### Differential counter

Although a hand tally counter can be used, a differential counter saves time.

#### Photometer or colorimeter

It is necessary to have a photometer or colorimeter for blood chemistry tests and for accurate determination of haemoglobin levels. Battery-powered models are commercially available.

<sup>1</sup> For further information, see section 3.1.

<sup>2</sup> For further information, see section 3.3.

<sup>3</sup> For further information, see section 3.2.3.

### 2.5.2 Additional items

#### Autoclave

If the laboratory is in a hospital, the hospital sterilization service can be used. If the laboratory is in a health centre one of the following is needed (see section 3.5.5):

- a small autoclave (electric or heated by an oil stove or with butane gas)
- a pressure cooker.

#### Hot-air oven

If the laboratory is fairly large, a small hot-air oven is useful for drying glassware and for sterilization in conjunction with the autoclave (see section 3.5.5).

#### Deionizer or water still

A deionizer is an apparatus for demineralizing water by means of cartridges filled with ion-exchange resin (see section 2.4.3).

If a deionizer is not available, a water still can be used (see page 25).

### 2.5.3 Equipment and supplies

A list of equipment and supplies for a peripheral-level health laboratory is given in Table 2.2. The quantities proposed are sufficient to enable a laboratory with one or two technicians to perform 20–50 examinations per day for a period of 6 months. Glassware and small items of equipment for laboratory use are shown in Fig. 2.40.

### 2.5.4 Making glass equipment

Glass is produced by the fusion at a very high temperature of sand and potassium (or sodium). This forms a silicate (ordinary soda-lime glass). Sometimes boric acid is added to the ingredients to produce borosilicate glass, which is less brittle and more resistant to heat than ordinary glass. Certain pieces of equipment can be made in the medical laboratory by heating ordinary glass.

#### Materials

- Hollow glass tubing with an external diameter of 4–8 mm and 0.9–1.0 mm thick
- Glass rods with a diameter of 4–8 mm
- File, glass cutter or diamond pencil
- Cloth
- Bunsen burner (or a small gas or petrol blowlamp).

#### Making a Pasteur pipette

1. Take a piece of glass tubing 4–6 mm in diameter. Using the file, mark off the required lengths of tubing:

- 14–15 cm for small pipettes;
- 18–25 cm for large pipettes.

Etch the mark right round the tube, forming a circle (Fig. 2.41).

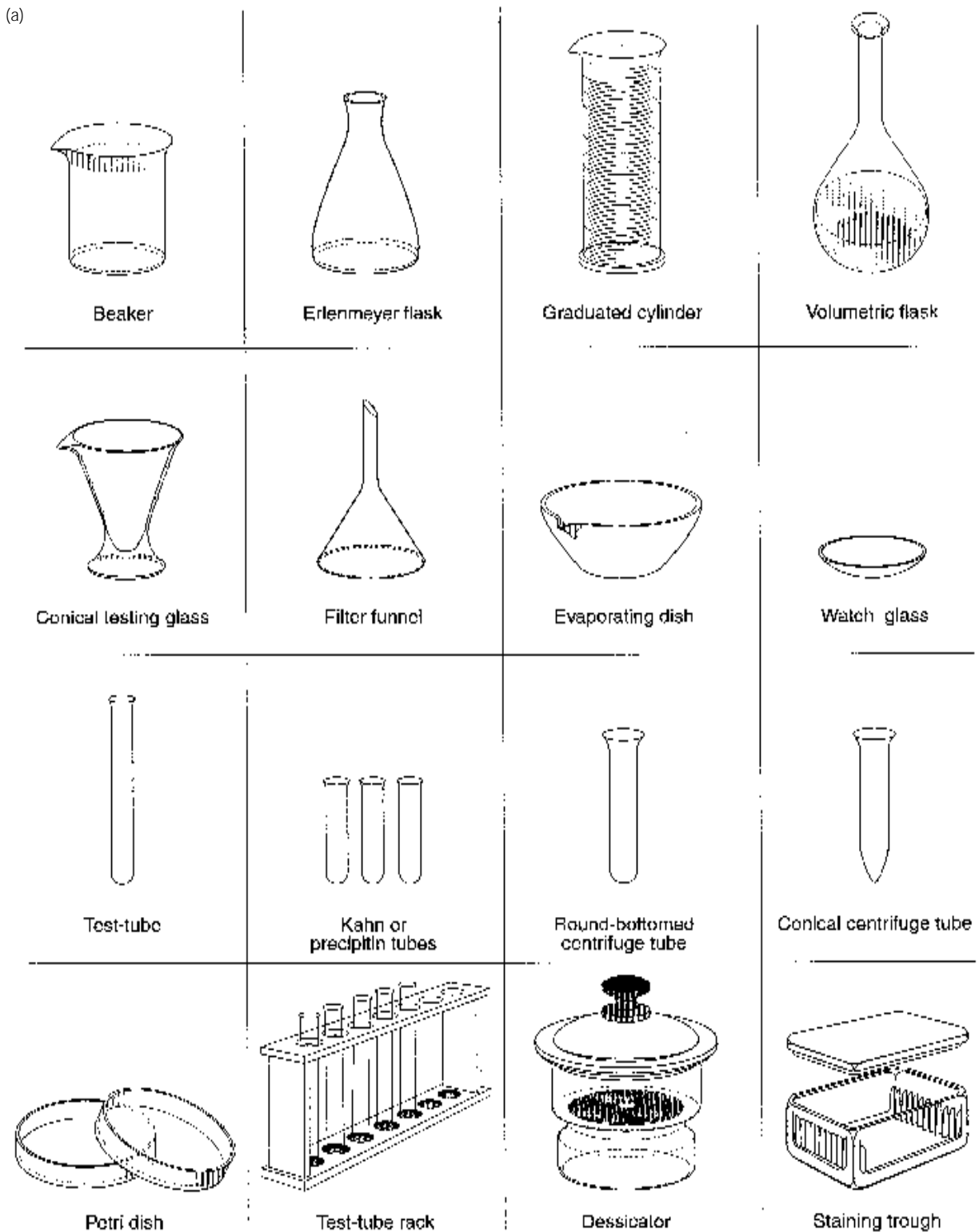

Fig. 2.40 Glassware and equipment for laboratory use

(b)



Bunsen burner



Spirit lamp



Meker burner

Asbestos gauze  
and tripod

Rubber safety bulb



Wooden test-tube holder



Side forceps



Pestle and mortar



Timer



Drop bottles



Wash bottle



Thermometer

MHO 8607

**Table 2.2 Equipment and supplies for a peripheral-level health laboratory**

Item	Quantity required
<b>Equipment for collection of specimens</b>	
<i>Essential equipment</i>	
Syringes, graduated, disposable, 20 ml	as needed
Syringes, graduated, disposable, 10 ml	as needed
Syringes, graduated, disposable, 5 ml	as needed
Needles, disposable, 18-gauge (1.2 mm) × 40 mm	as needed
Needles, disposable, 19-gauge (1.0–1.1 mm) × 40 mm	as needed
Needles, disposable, 20-gauge (0.9 mm) × 40 mm	as needed
Needles, disposable, 22-gauge (0.7 mm) × 40 mm	as needed
Needles, disposable, 23-gauge (0.6 mm) × 32 mm	as needed
Needles, disposable, 23-gauge (0.6 mm) × 90 mm	as needed
Rubber tubing for tourniquet, 2–5 mm bore	2 pieces
Lancets for taking capillary blood	as needed
Cotton wool, white, absorbent	2 × 500 g
Cotton wool, non-absorbent	2 × 500 g
Bottles, previously containing antibiotics, reagents, etc. for injection (5, 10, 20 ml)	as many as possible
<i>Additional equipment</i>	
Scalpel with disposable blades for taking slit skin smear specimens (for leprosy)	1
Curved clamp forceps without teeth for taking slit skin smear specimens (for leprosy)	1
Boxes, plastic or cardboard, disposable, for stool collection	50
Applicators, wooden (12 cm × 1 mm) (can be made locally)	50
Bottles, 2.5 ml and 5 ml, preferably plastic	50
Bottles, white glass, wide-mouthed, 50 ml, with metal screw cap and rubber washer, for collection of sputum specimens	25
Bottles, white glass, 25 ml, with metal screw cap and rubber washer, for various specimens	25
Bottles, wide-mouthed, all sizes, for collection of urine specimens	20–40
Forceps, punch, for taking skin biopsies (for onchocerciasis)	1
Tongue depressors, wooden	50
<b>Glassware</b>	
<i>Essential items</i>	
Glass rods, solid, 6 mm diameter	3
Beakers, plastic, flat, 50 ml	4
Beakers, plastic, flat, 100 ml	4
Beakers, plastic, flat, 250 ml	4
Staining troughs, rectangular, for 20 slides	4
Funnel, glass, 60 mm diameter	1
Funnels, glass, 90 mm diameter	2
Funnel, plastic, 200 mm diameter	1
Measuring cylinders, graduated, glass, 25 ml	3
Measuring cylinders, graduated, glass, 50 ml	3
Measuring cylinders, graduated, glass, 100 ml	3
Measuring cylinders, graduated, glass, 250 ml	2
Measuring cylinder, graduated, glass, 500 ml	1
Measuring cylinder, graduated, glass, 1000 ml	1
Flasks, Erlenmeyer, heat-resistant, wide-mouthed, 250 ml	3



**Table 2.2 (cont.)**

<b>Item</b>	<b>Quantity required</b>
Flasks, Erlenmeyer, heat-resistant, wide-mouthed, 500 ml	3
Flasks, Erlenmeyer, heat-resistant, wide-mouthed, 1000 ml	3
Drop bottles, plastic or glass, 100 ml	12
Drop bottles, brown glass, 100 ml	3
Reagent bottles, plastic or glass, 100 ml	20
Reagent bottles, plastic or glass, 500 ml	10
Reagent bottles, plastic or glass, 1000 ml	10
Flasks, volumetric, glass, with stoppers, 100 ml	4
Flasks, volumetric, glass, with stoppers, 250 ml	2
Flasks, volumetric, glass, with stoppers, 500 ml	2
Flask, volumetric, glass, with stoppers, 1000 ml	1
Microscope slides, 25 mm × 75 mm	2 × 1000
Coverslips, 20 mm × 20 mm	20 × 100
Wash bottles, plastic, 500 ml	2
Wash bottles, plastic, 1000 ml	2
Watch glasses, 50 mm diameter	2
Pipettes, graduated from the top (and not to the tip), 1 ml (0.01-ml subdivisions)	12
Pipettes, graduated from the top (and not to the tip), 2 ml (0.01-ml subdivisions)	10
Pipettes, graduated from the top (and not to the tip), 5 ml (0.1-ml subdivisions)	10
Pipettes, graduated from the top (and not to the tip), 10 ml (0.1-ml subdivisions)	6
Pipettes, Pasteur	2 × 144
Test-tubes, heat-resistant, 150 mm × 16 mm	50
Test-tubes, heat-resistant, 85 mm × 15 mm (Kahn tubes)	100
Test-tubes, heat-resistant, 50 mm × 6 mm (cross-matching tubes)	20
Centrifuge tubes, conical, 15 ml	40
Centrifuge tubes, conical, graduated, 15 ml (0.1-ml subdivisions)	50
Glass tubing, 1.0–1.5 mm thick, 7–8 mm diameter	1 kg
<b>Additional items</b>	
Petri dishes, glass, 112 mm diameter	4
Petri dishes, glass, 156 mm diameter	4
Evaporating dishes, 75 mm diameter (75 ml)	2
Dessicator	1
<b>Equipment for haematology tests</b>	
Pipettes, Sahli, 0.02 ml, with rubber tubing	30
Pipettes, blood, 0.05 ml	20
Counting chambers, improved Neubauer (bright line if possible)	3
Counting chamber, Fuchs–Rosenthal	1
Coverslips, optically plane, for counting chambers	12
Tally counter	1
Tubes, Westergren, for determination of erythrocyte sedimentation rate	30
Stands for Westergren tubes	2
Microhaematocrit centrifuge	1
Microhaematocrit capillary tubes, heparinized	1000
Wax, for sealing microhaematocrit tubes	1 roll
<b>Equipment for bacteriological and biochemical tests</b>	
Nichrome wire, 1 mm diameter	1 m

**Table 2.2 (cont.)**

<b>Item</b>	<b>Quantity required</b>
Loop holders	4
Wooden block for loop holders	1
Protein standard tubes	1 set
Test-tube racks, large, for 12 tubes	4
Test-tube racks, small, for 12 tubes	4
Wooden test-tube holders	2
Forceps, stainless steel, for slides	2
Bunsen burner for use with butane gas	1
Butane gas cylinder	as needed
Tripod with asbestos gauze	1
Spatulas, various sizes, for weighing reagents	3
<b>Laboratory records and reports</b>	
Record books, hardbacked, large	6
Glass-marking pencils, wax, red	12
Glass-marking pencils, wax, blue	12
Glass marker, diamond point	1
Pencils, lead	12
Pens, ballpoint, red ink (for recording positive specimens)	2
Pens, ballpoint, black or blue ink	3
Cellophane tape	3 rolls
Adhesive tape, white	3 rolls
Labels for specimen bottles	1000
Laboratory request forms (preferably standardized centrally)	as needed
<b>Miscellaneous equipment</b>	
Microscopes	2
Colorimeter	1
Water bath	1
Refrigerator	1
Hot-air oven	1
Centrifuge	1
Balance	2
Deionizer or water still	1
Timer, 0–60 min, with alarm	1
Spirit lamp	1
Hammer	1
Pliers	1 pair
Pliers, electrician's	1 pair
Screwdriver, small	1
Screwdriver, medium	1
Screwdriver, large	1
Round metal file, 5 mm	1
Small ampoule files	12
Saucepan, flat-bottomed with lid, 30 cm diameter	1
Hot plate	1
Pestle (10 cm diameter) and mortar	1
Bowls, plastic, 50 cm × 30 cm	3
Bucket, plastic, 12 litres	1
Rubber safety bulb	4
Micropipette, 20 µl	1

**Table 2.2 (cont.)**

Item	Quantity required
Micropipette, 50µl	1
Micropipette, 100µl	1
Micropipette, 200µl	1
Micropipette, 500µl	1
Micropipette tips, plastic, disposable, 20µl	as needed
Micropipette tips, plastic, disposable, 50µl	as needed
Micropipette tips, plastic, disposable, 100µl	as needed
Micropipette tips, plastic, disposable, 200µl	as needed
Micropipette tips, plastic, disposable, 500µl	as needed
Scissors, medium	1
Scissors, large	1
Vacuum pump, metal	1
Thermometer, 0–100 °C	1
Stoppers, rubber	1 set
Stoppers, cork	1 set
Corkscrew	1
Test-tube and bottle cleaning brushes (various sizes)	6
Filter-paper, 15cm diameter (Whatman's No. 1 or equivalent)	4 boxes
pH paper, narrow range (6.8–7.2)	6 books
pH paper, wide range (0–12)	6 books
Lens paper	2 packets
Fine paintbrush, soft camel-hair brush or blower (for cleaning lenses)	1
Small rubber bulb (for cleaning lenses)	1
Toilet tissue	10 rolls
Towels and clean rags	as needed
Immersion oil	6 bottles (10ml each)

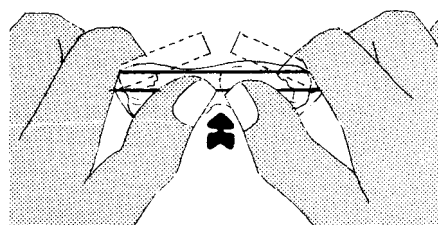
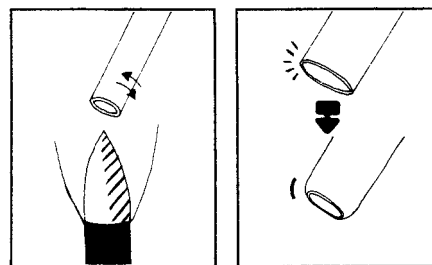
**Fig. 2.41 Marking off the required length of glass tubing using a file****Fig. 2.42 Breaking the glass tubing by hand****Fig. 2.43 Rounding off the ends of the glass tubing by flaming**

2. Wrap the part to be broken in a cloth. Hold the tube with both hands, one thumb on either side of the etched mark (Fig. 2.42). Snap by pressing with your thumbs.
3. Round off the end of each piece of tubing as shown in Fig. 2.43:
  - heat the end, holding the tube almost vertical just above the blue flame of the burner;

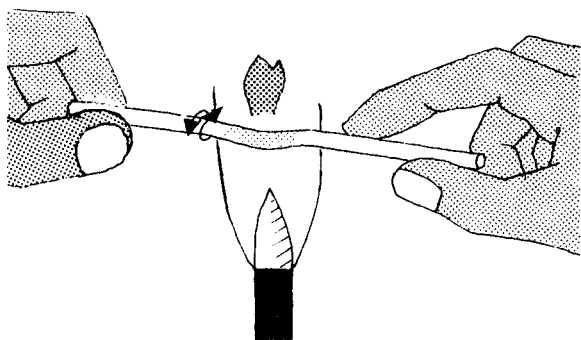

Fig. 2.44 Heating the glass tubing before pulling the pipette

- keep turning slowly;
  - stop when the glass becomes red hot.
4. Stand the tubes in a beaker or a can, heated ends up, and leave to cool.

Wash all the pieces of tubing prepared (following the instructions given in section 3.5.1). Rinse and dry.

5. Pulling the pipette is carried out as follows:
- heat the middle of the length of tubing over the blue flame (Fig. 2.44);
  - keep rotating the tubing until the glass becomes red.

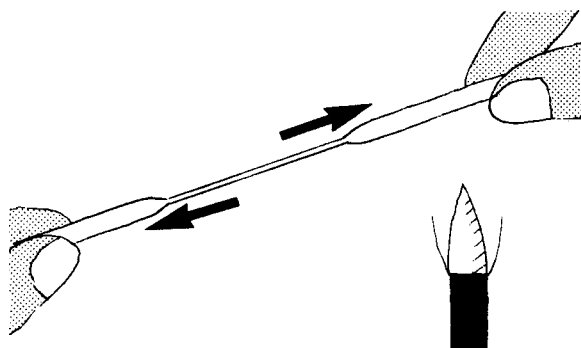

Fig. 2.45 Pulling the pipette

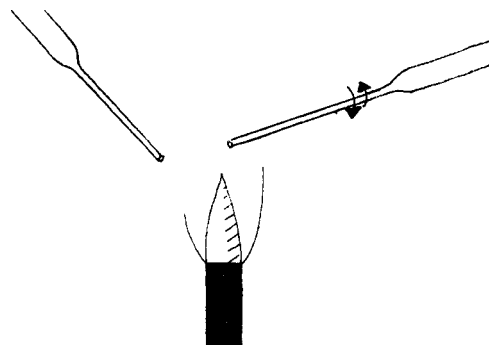

Fig. 2.46 Rounding off the ends of the pipette by flaming

6. Remove the tubing from the flame, still rotating it continuously, and pull the two ends apart slowly, keeping your hands perfectly level (Fig. 2.45). Pull the glass to the length required (10–20 cm).

7. Leave to cool. Cut off the drawn portion at the exact length required. Round off the sharp edges by holding them for a few seconds in the flame (Fig. 2.46).

Alternatively, separate and seal the two pipettes by heating the pulled-out portion in the flame.

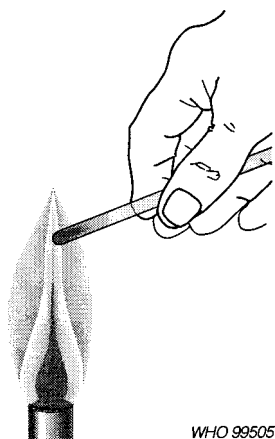

Fig. 2.47 Rounding off the ends of the glass rod by flaming

WHO 99505

### Making a stirring rod

1. Use a glass rod about 5 mm in diameter. Cut the rod into lengths of 15, 20 or 25 cm according to requirements, using a file (see Fig. 2.41).
  2. Round off the ends by rotating them over the blue flame of the burner, until about 1 cm of the rod is bright red (Fig. 2.47).
  3. Flatten the heated end against the (dry) tiled working surface with a 500-g or 1-kg weight (Fig. 2.48).
  4. Heat the other end and press it gently down on the tiled surface (Fig. 2.49).
- Glass rods can be used to decant liquids or to pour them slowly (see Fig. 3.52).

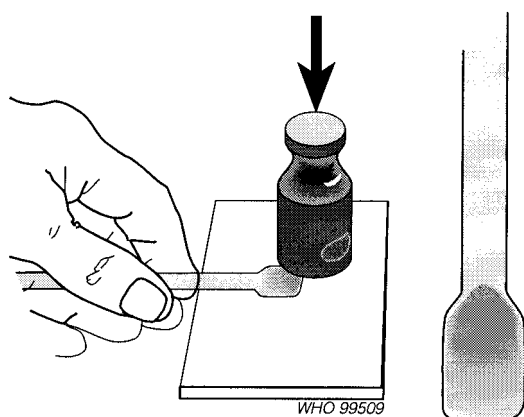

Fig. 2.48 Flattening the heated end of the glass rod using a weight

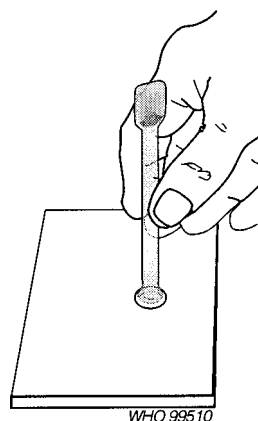

Fig. 2.49 Pressing the heated end of the glass rod down on a tiled surface

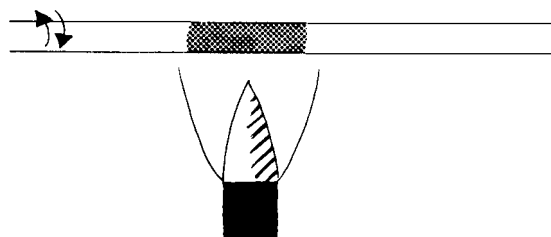

Fig. 2.50 Heating glass tubing before bending

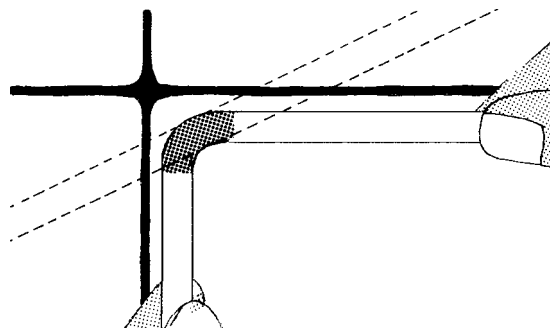

Fig. 2.51 Bending glass tubing to make a right angle

### Bending glass tubing

1. Heat the spot where the bend is to be made, rotating the tubing over the flame until the glass turns pale red (Fig. 2.50) and sags.
2. Bend the heated tubing slowly to make a right angle (follow the corner of a tile; Fig. 2.51).

### Poor bends (Fig. 2.52)

Poor bends may result if:

- the glass was too hot (a)
- the glass was not hot enough (b).

### Making a wash bottle

#### Materials

- Erlenmeyer flask, 1000ml
- Two pieces of glass tubing
- Cork or rubber stopper.

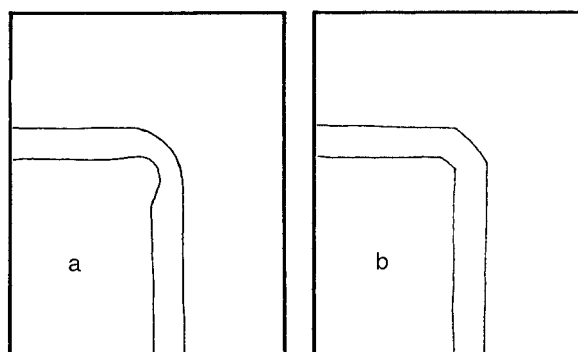

Fig. 2.52 Common problems with bending glass tubing

**Method**

Pierce the stopper with a cork borer. Moisten the ends of the tubing with a few drops of water (for cork) or glycerol (for rubber) before inserting them in the holes (Fig. 2.53). Protect your hands with a cloth.

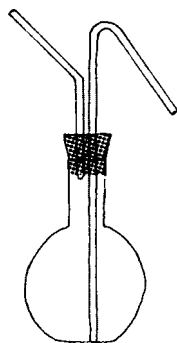

Fig. 2.53 Components of a wash bottle

**2.5.5 Specimen containers**

Different types of containers are used for the collection of specimens such as stools, blood, urine and sputum in the laboratory.

**Containers for stool specimens**

The following types of container are suitable for the collection of stool specimens (Fig. 2.54):

- waxed cardboard box
- empty tin with a lid
- light plastic box
- glass jar specially designed for stool collection, with a spoon attached to the stopper.

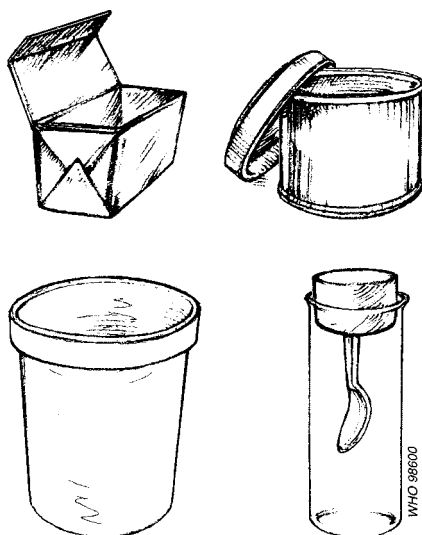

Fig. 2.54 Containers for stool specimens

**Bottles and test-tubes for collecting blood specimens****Without anticoagulant**

The best type of test-tube to use for blood specimens is one that can be centrifuged: this avoids excessive handling of the specimen.

- Use clean dry test-tubes of 5–20 ml capacity, depending on requirements.

**With anticoagulant for haematological tests****EDTA<sup>1</sup> dipotassium salt**

Put 0.5 ml of EDTA dipotassium salt, 10% solution (reagent no. 22) into each of a series of 5-ml bottles (Fig. 2.55) (or use 0.2 ml in 2-ml bottles). Place the open bottles in an incubator at 37°C or leave them to dry at room temperature, if no incubator is available.

Use these bottles for:

- blood cell counts
- haemoglobin estimation.

**Heparinized tubes**

Heparin is an expensive anticoagulant that is not very stable in hot climates. Heparinized tubes are usually obtained commercially or prepared by central laboratories and are already marked to show the level to which the blood should be added.

**Trisodium citrate**

Trisodium citrate, 3.2% solution (reagent no. 60) is used for the determination of the erythrocyte sedimentation rate.

Use 1 ml of trisodium citrate solution per 4 ml of blood (or 0.4 ml per 1.6 ml of blood).

<sup>1</sup> Ethylene diamine tetraacetic acid; also known as edetic acid.



Fig. 2.55 Dispensing EDTA solution into bottles for collection of blood specimens

*Important:* Never carry out a blood cell count on citrated blood.

#### *With anticoagulant for biochemical tests*

Sodium fluoride (NaF) is the anticoagulant normally used for biochemical tests. Use 10 mg of sodium fluoride powder per 10 ml of blood, or 2 mg per 2 ml of blood. Use for:

- blood glucose estimation
- blood urea estimation (certain techniques).

*Warning:* Sodium fluoride is a poison.

#### *Precautions to be taken when using anticoagulants*

- Mix as soon as the blood is collected by inverting the bottle several times gently and evenly. Do not shake.
- Use clean bottles. Dry before adding anticoagulant.  
*Warning:* Traces of detergent will dissolve the erythrocytes. Ensure that the bottles are rinsed thoroughly before drying.
- Store bottles containing anticoagulants in a dry place. EDTA dipotassium salt solution and sodium fluoride are stable at room temperature but trisodium citrate solution and heparin must be kept in the refrigerator.
- Use the correct proportions. Use bottles and tubes with a graduation mark, or stick on a label so that its upper edge corresponds to the required amount of blood (2 ml, 5 ml, etc.).

### Bottles and tubes for collecting other specimens

- Urine — use clean, dry, wide-mouthed Erlenmeyer flasks of 250-ml capacity or clean wide-mouthed bottles.
- Cerebrospinal fluid (CSF) — use test-tubes measuring 150 mm × 16 mm. See section 8.2.

### Boxes and jars for collecting sputum specimens

Glass screw-top jars or disposable plastic jars with lids can be used for collecting sputum specimens, or small cartons can be made in the laboratory using cardboard and a stapler. These cartons can be used once only for sputum collected in the laboratory.

1. Cut out pieces of thin cardboard 18 cm square and fold them as shown in Fig. 2.56:
  - first from corner to corner
  - then into nine equal squares.
2. Fold the diagonal creases in each corner square inwards (Fig. 2.57).
3. Fold two of the corners back against one side, and the other two against the other side (Fig. 2.58).
4. Staple the two folded corners on each side of the box (Fig. 2.59), which is now ready to receive the specimen.
5. Burn these cartons and plastic jars after use, as described in section 3.6.2.

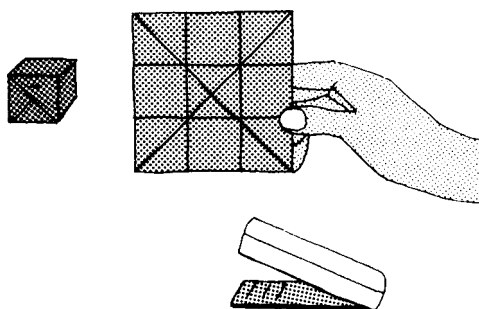

Fig. 2.56 Folding cardboard to make cartons for sputum collection

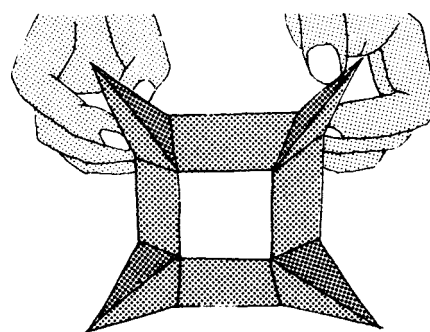

Fig. 2.57 Folding the corners inwards

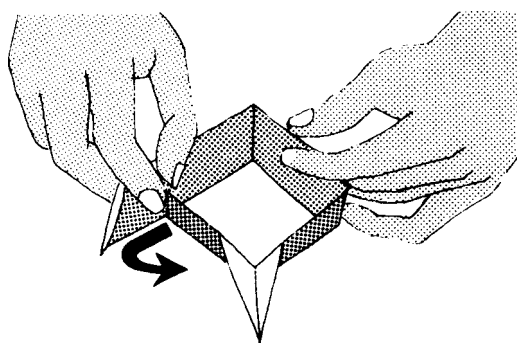

Fig. 2.58 Folding two of the corners back against one side of the carton

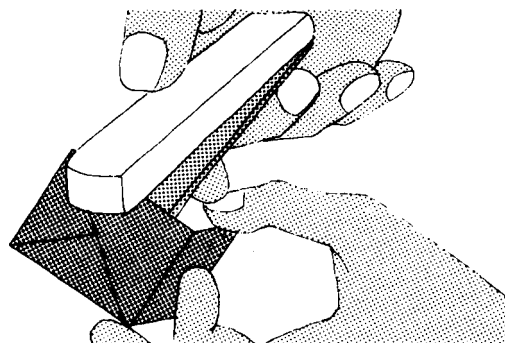

Fig. 2.59 Securing the folded corners



## 2.5.6 Storage, stocktaking and ordering supplies

### Storage

#### *Glassware*

Keep glassware on the shelves of a cupboard away from dust. Erlenmeyer flasks should be plugged with non-absorbent cotton wool or covered with brown paper (or preferably with thin sheets of paraffin wax or clinging plastic, if available) and arranged by type and size. Graduated pipettes should be kept in drawers divided into sections.

#### *Chemicals and reagents*

Arrange chemicals and reagents in *strict alphabetical order*. Acids and inflammable and dangerous chemicals (indicated by appropriately coloured labels) should be stored separately in a special section. Unopened stocks can be kept in crates filled with sawdust.

Poisons (also indicated by appropriately coloured labels) should be stored separately in a locked cupboard.

#### *Instruments*

Some instruments, e.g. spectrophotometers, should be kept in an air-conditioned room if the climate is hot and humid. For storage of microscopes see section 3.1.6.

### Stocktaking

#### *Stock cards*

A stock card should be prepared for every chemical, stain, piece of glassware, etc. A sample stock card is shown in Table 2.3.

When you order an item, indicate:

- in the column headed “Ordered from”: where you sent the order
- in the column headed “Ordered”: the date and the quantity ordered.

When you receive an item, indicate:

- in the column headed “Received”: the date of receipt and the quantity received
- in the column headed “In stock”: the total in stock in the laboratory after the item has been received.

When an item has been used up (or broken), indicate:

- in the column headed “Issued”: the date of issue and the amount issued
- in the column headed “In stock”: the total left in stock after the item has been issued.

**Table 2.3 A sample stock card**

Item: Giemsa stain (250-ml bottle)							Item no.: 29
Ordered from	Ordered		Received		Issued		In stock
	Date	Quantity	Date	Quantity	Date	Quantity	
							2 bottles
Company A	1.8.01	2 bottles	20.8.01	2 bottles			4 bottles
					10.10.01	1 bottle	3 bottles
					3.12.01	1 bottle	2 bottles
Company A	15.11.01	2 bottles	10.12.01	2 bottles			4 bottles

**Table 2.4 Estimating the quantity of supplies required**

Year	Quantity used per month											
	Jan.	Feb.	March	April	May	June	July	Aug.	Sept.	Oct.	Nov.	Dec.
2000												
2001												
2002												

Classify the stock cards in strictly alphabetical order and keep them in a box or filing drawer. Each item can be given a number, which is then entered on the stock card after the heading "Item no."

### *Inventory*

Make an inventory of all laboratory supplies every 6 months. Count the quantity of each item in stock and check that the figure corresponds to the one shown in the "In stock" column of the stock card.

### **Ordering supplies**

A well-organized laboratory should submit an order to the central supply stores every 3 months. To draw up the order, check the stock cards one by one.

It makes it easier to estimate the quantities required if a table summarizing the stock used each month (see Table 2.4) is added to the bottom of each stock card.

In the case of chemicals, stains and reagents, order the quantity used in a 3-month period, taking into account any recent increase or decrease in the amount used. For example:

- Eight bottles of Giemsa stain have been used in a year.
- This gives an average of two bottles used every 3 months.
- Order two bottles every 3 months (or four bottles every 6 months if orders are submitted twice a year).

### *Expiry dates*

Reagents (e.g. blood group antisera, antigens, etc.) have to be used before a certain date. This expiry date should be marked on the container by the supplier. Make a note of the expiry date on the stock card in the column headed "In stock".

## **2.6 Registration of specimens and preparation of monthly reports**

### **2.6.1 Registration of specimens**

All specimens must be registered and given numbers when they arrive at the laboratory and the results of all investigations must be recorded. This will:

- prevent the specimens from getting mixed up;
- make it possible to look up a result;
- make the results available for the promotion of public health.

The laboratory should have:

- examination request forms that accompany the specimens;
- a register for recording details concerning the specimens and the results obtained;
- monthly report forms.

### Numbering the specimens (Fig. 2.60)

Give each specimen a number as soon as it is received. Write this number immediately:

- on the request form
- on the specimen container (use a grease pencil)
- on every test-tube used for the specimen
- on every microscope slide used for the specimen.

This will prevent any mistakes.

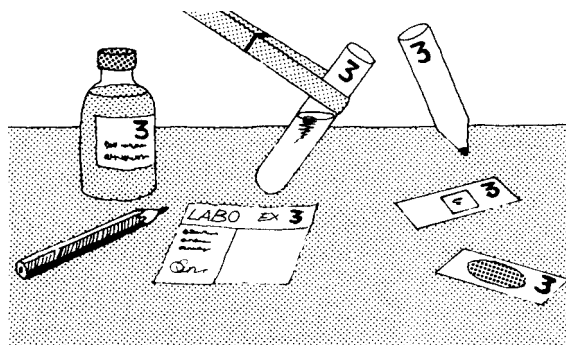

Fig. 2.60 Numbering the specimens

### Laboratory registers

Each numbered specimen should be recorded in a register for that type of specimen. The following registers are suggested:

- haematology
- blood chemistry
- urine analysis
- CSF examination
- pregnancy tests
- bacteriology
- parasitology
- mycology
- serology (if the samples are few, incorporate in the bacteriology register; otherwise keep a separate register)
- histopathology
- water analysis.

Tables 2.5–2.11 show examples of some of these registers, which should be modified according to your requirements.

It is both helpful and time-saving to have rubber stamps for the most common tests and results. For example:

- For parasitology: no. of ova or parasites seen.
- For bacteriology: no. of leukocytes
  - no. of erythrocytes
  - no. of epithelial cells
  - no. and type of organisms.

#### 2.6.2 Preparation of monthly reports

At the end of every month the laboratory should submit a report to the director of laboratory services at the central level or, if there is none, to the department of public health at both the provincial and the central level. The report is valuable for two main reasons.

Firstly, it helps to keep a check on the laboratory's activities and is useful for ensuring adequate staffing, for the ordering of supplies by the central stores, and for the preparation of the budget for laboratory services at the national level. Reports based on the number of tests done are the most suitable.

Secondly, a monthly report is an aid in public health surveillance of the area covered by the laboratory since it reports the number of positive results obtained for various communicable diseases. An example of a monthly report is given in Table 2.12.

Table 2.5 Haematology register<sup>a</sup>

Date	Specimen no.	Patient	Sent by	Hb concentration <sup>b</sup> (g/l)	Erythrocytes			Reticulocyte no. fraction <sup>c</sup>	MEHC <sup>d</sup> (g/l)	Leukocytes					Malaria	Other tests	Results sent (date)
					Volume fraction	ESR (mm/h)	No. concentration			Morphology	No. concentration	Type no. fraction					
										N	L	M	E	O			
2.1.01	1	Mr R	Dr M	117	—	23	—	124 × 10 <sup>-3</sup>	—	0.48	0.35	0.13	0.04	—	Many P. falciparum trophozoites	—	2.1.01
2.1.01	2	Mrs L	Dr H	58	0.21	52	—	0.071 × 10 <sup>-3</sup>	276	0.32	0.56	0.04	0.08	—	Moderate no. of P. falciparum trophozoites	—	2.1.01

Hb: haemoglobin; ESR: erythrocyte sedimentation rate; ANS: anisocytosis; POIK: poikilocytosis; PMN: polymorphonuclear erythrocytes; HC: hypochromic erythrocytes; MEHC: mean erythrocyte haemoglobin mass concentration; N: neutrophils; L: lymphocytes; M: monocytes; E: eosinophils; O: other.

<sup>a</sup> For explanation of the column headings, see the relevant sections of the text.

<sup>b</sup> Haemoglobin may also be reported in terms of the substance concentration; the column heading would then be "Hb (Fe), substance concentration (mmol/l)". In that case, the values quoted in the two examples would be 7.3 and 3.6 mmol/l, respectively.

<sup>c</sup> The reticulocyte concentration may also be reported in terms of the number concentration, i.e. the number per litre. In that case the column heading would read "reticulocyte no. concentration" and the values would depend on the erythrocyte number concentration (not reported in the examples given).

<sup>d</sup> MEHC may also be reported in terms of the substance concentration; the column heading would then be "mean erythrocyte haemoglobin (Fe) concentration (MEH(Fe)C (mmol/l)". In that case the example quoted (no. 2) would have a value of 17.1.

Table 2.6 Blood chemistry register

Date	Specimen no.	Patient	Sent by	Urea, substance concentration (mmol/l)	Glucose concentration (mmol/l)	Other tests (specify)	Results sent (date)
2.1.01	1	Mrs W	Ward 1	12.8	—	—	2.1.01
2.1.01	2	Mr G	Dr W	—	5.3	—	2.1.01

Table 2.7 Urine analysis register

Date	Specimen no.	Patient	Sent by	pH	Direct microscopic examination	Test for glucose	Test for protein	Test for bile pigments	Test for urobilinogen	Test for ketones	Chemical test for blood	Other tests (specify)	Results sent (date)
2.1.01	1	Mr C	Dr R	7.0	Leukocytes (20–30 per high-power field), few hyaline cysts	Negative	Negative	ND	ND	ND	ND	ND	2.1.01
2.1.01	2	Mrs E	Dr A	6.8	Leukocytes (5–10 per high-power field), few epithelial cells	+++	Negative	ND	ND	+	ND	Pregnancy test: positive	2.1.01

ND: test not done; —: negative; +: weakly positive; ++: moderately positive; +++: strongly positive.

Table 2.8 CSF examination (in urine analysis register or separate)

Date	Specimen no.	Patient	Sent by	Macroscopic appearance	Direct microscopic examination	Leukocyte no. concentration	Glucose concentration (mmol/l)	Total protein concentration (g/l)	Pandy test for globulin	Other tests (specify)	Results sent (date)
2.1.01	1	Ms W	Dr G	Cloudy	Gram-staining shows many leukocytes and a few Gram-negative intracellular diplococci	30	1.5	0.45	+	Leukocyte type no. fraction: neutrophils 0.94, lymphocytes 0.06	2.1.01
17.1.01	2	Mr L	Dr C	Clear	ND	4	3.3	0.25	Negative	ND	17.1.01

Table 2.9 Bacteriology register

Date	Specimen no.	Patient	Sent by	Specimen	Examination requested	Results	Results sent (date)
2.1.01	1	Mr J	Dr R	Sputum	Microscopic examination of smear for tuberculosis	No acid-fast bacilli seen	2.1.01
2.1.01	2	Mrs A	Medical ward 2	Pus from wound	Microscopic examination of Gram-stained smear	Many leukocytes, few epithelial cells, moderate no. of Gram-negative rods	2.1.01
3.1.01	3	Mr L	Dr M	Urethral pus	Microscopic examination of Gram-stained smear	Moderate no. of intracellular Gram-negative diplococci seen, including gonococcal cocci	3.1.01
3.1.01	4	Mrs R	Medical ward 1	CSF	Microscopic examination of Gram-stained smear	Occasional leukocytes and epithelial cells, no erythrocytes or organisms seen	3.1.01

**Table 2.10 Parasitology register**

Date	Specimen no.	Patient	Sent by	Specimen provided	Examination requested	Results	Results sent (date)
2.1.01	1	Mr F	Dr A	Stool	Intestinal parasites	Direct microscopy: moderate no. of <i>Ascaris lumbricoides</i> ova seen	2.1.01
2.1.01	2	Ms M	Dr C	Stool	Intestinal parasites	Direct microscopy: no ova or parasites seen Concentration technique: no ova or parasites seen	2.1.01
2.1.01	3	Mrs L	Medical ward 1	Skin snips	Onchocerciasis	No parasites seen	3.1.01
3.1.01	4	Mr S	Dr R	Stool	Parasites	Occult blood: positive Direct microscopy: many trophozoites of <i>Entamoeba histolytica</i> and a few hookworm ova seen	3.1.01

**Table 2.11 Serology register**

Date	Specimen no.	Patient	Sent by	Specimen	Examination requested	Results	Results sent (date)
3.1.01	1	Mrs P	Prenatal clinic	Blood	ELISA for determination of antibodies to HIV	Non-reactive	3.1.01
3.1.01	2	Mrs T	Dr M	Blood	ELISA for determination of antibodies to HIV	Reactive, 1:8	3.1.01

ELISA: enzyme-linked immunosorbent assay; HIV: human immunodeficiency virus.

**Table 2.12 Sample monthly report for a health laboratory**

<b>Name of laboratory:</b> _____	
<b>Report for the month ending:</b> _____	
LABORATORY RECORD	
<b>Number of examinations carried out</b>	
Haematology (general)	1235
Blood chemistry	27
Urine analyses:	
— direct examination	287
— chemistry	43
Pregnancy tests	17
CSF examinations:	
— direct examination	3
— chemistry	3
Parasitology:	
— examination of stools	162
— examination of blood	802
— other examinations (e.g. examination of lymph glands for trypanosomes)	2
Bacteriology:	
— Gram stains	63
— acid-fast stains	41
— Wayson stains	11
Mycology	3
Serology:	
— qualitative	114
— quantitative	16
<b>Number of specimens sent to specialized laboratories</b>	
Water for bacteriological analysis	8
Specimens for bacteriological culture	32
Sera for serology	0
Tissue biopsies	2
Other specimens	0
COMMUNICABLE DISEASES RECORD <sup>a</sup>	
<b>Number of cases reported</b>	
Gonorrhoea	11
Leprosy	0
Plague	0
Tuberculosis	7
Amoebiasis	14
Ascariasis	22
Filariasis	1
Hookworm	80
Malaria	253
Onchocerciasis	0
Schistosomiasis	2

<sup>a</sup>The list of notifiable diseases varies from country to country. It is established by the central public health authority on the basis of:

- international regulations on reporting communicable diseases
- diseases prevalent in the area.



---

## 3. General laboratory procedures



### 3.1 Use of a microscope

The microscope is an essential instrument for the diagnosis of disease. It is a precision instrument and requires careful maintenance to prevent damage to the mechanical and ocular parts and also to stop fungi from obscuring the lenses.

#### 3.1.1 Components of a microscope

The various components of the microscope can be classified into four systems:

- the support system
- the magnification system
- the illumination system
- the adjustment system.

#### Support system (Fig. 3.1)

This consists of:

- the foot (1)
- the limb (2)
- the revolving nosepiece (objective changer) (3)
- the stage (4)
- the mechanical stage (5), which gives a slow controlled movement to the object slide.

#### Magnification system (Fig. 3.2)

This consists of a system of lenses. The lenses of the microscope are mounted in two groups, one at each end of the long tube — the body tube.

- The first group of lenses is at the bottom of the tube, just above the preparation under examination (the object), and is called the objective.
- The second group of lenses is at the top of the tube and is called the eyepiece.

#### Objectives

##### Magnification

The magnifying power of each objective is shown by a figure engraved on the sleeve of the lens (Fig. 3.3):

- the  $\times 10$  objective magnifies 10 times;
- the  $\times 40$  objective magnifies 40 times;
- the  $\times 100$  objective magnifies 100 times.

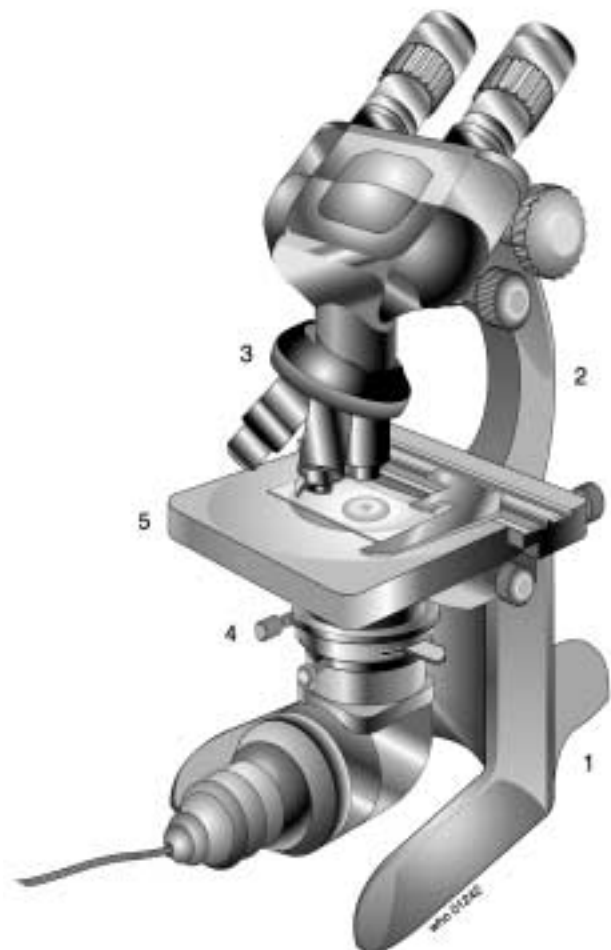

Fig. 3.1 Components of the support system of a microscope  
1: foot; 2: limb; 3: revolving nosepiece; 4: stage; 5: mechanical stage.

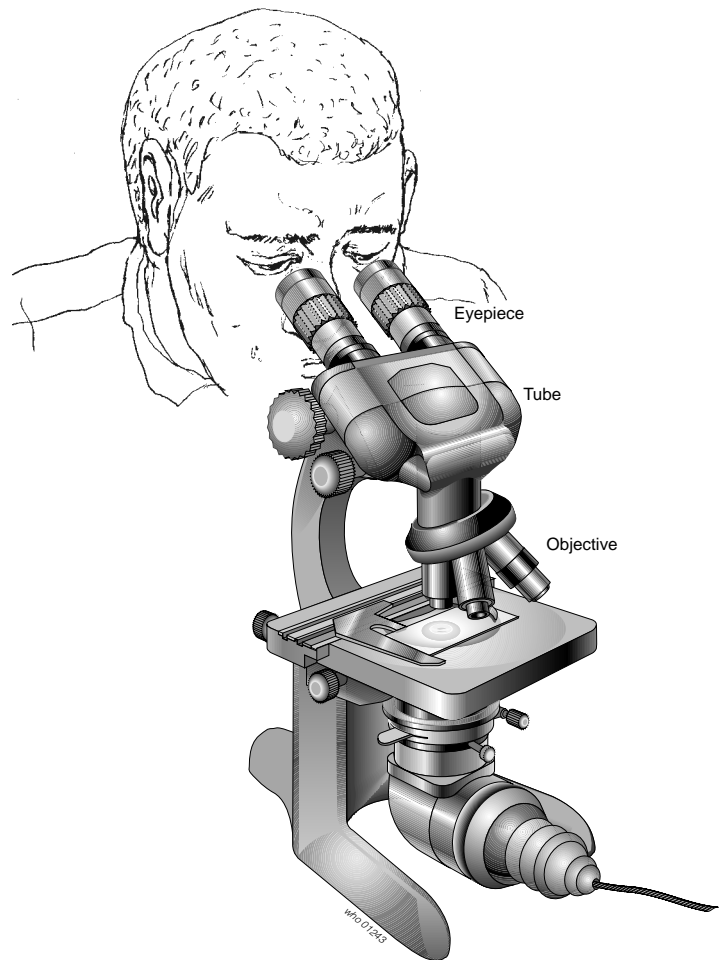

Fig. 3.2 Components of the magnification system of a microscope

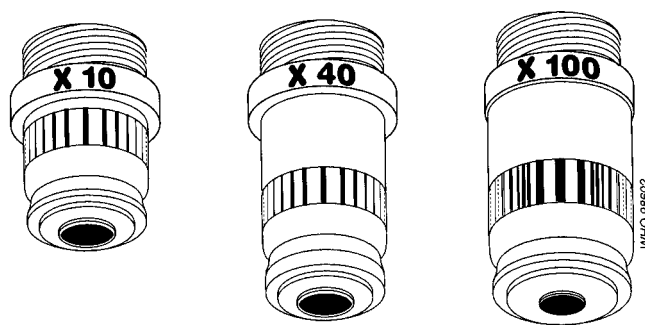
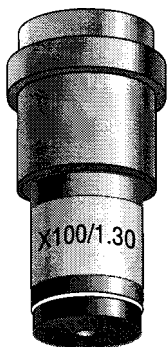

Fig. 3.3 Objective lenses



WHO 0088

Fig. 3.4 Numerical aperture

(The  $\times 100$  objective is usually marked with a red ring to show that it must be used with immersion oil.)

Some microscopes are fitted with a  $\times 3$  or  $\times 5$  objective instead of a  $\times 10$  objective.

#### Numerical aperture

The numerical aperture is also engraved on the sleeve, next to the magnification (Fig. 3.4), for example:

- 0.30 on the  $\times 10$  objective
- 0.65 on the  $\times 40$  objective
- 1.30 on the  $\times 100$  objective.

The greater the numerical aperture, the greater the resolving power (see below). Moreover, the greater the numerical aperture, the smaller the front lens mounted at the base of the objective. The front lens of the  $\times 100$  objective is the size of a pinhead, so handle it with care.

Other figures that may be marked on the sleeve

The sleeve may also display:

- the recommended length in millimetres of the tube (between the objective and the eyepiece) — usually 160 mm;
- the recommended thickness in millimetres of the coverslip used to cover the object slide — e.g. 0.16 mm.

The screw threads of all objectives are standard, so the objectives in the revolving nosepiece are interchangeable.

Working distance

The working distance of an objective is the distance between the front lens of the objective and the object slide when the image is in focus. The greater the magnifying power of the objective, the smaller the working distance (Fig. 3.5):

- $\times 10$  objective: the working distance is 5–6 mm
- $\times 40$  objective: the working distance is 0.5–1.5 mm
- $\times 100$  objective: the working distance is 0.15–0.20 mm.

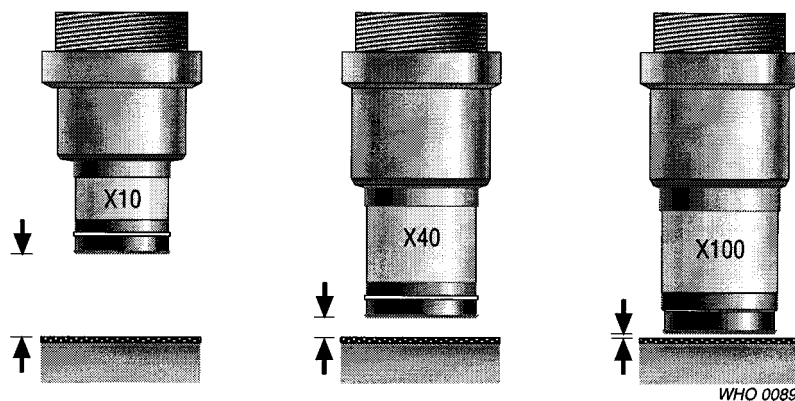

Fig. 3.5 Working distance of an objective

Resolving power

The resolving power of an objective is its ability to reveal closely adjacent details as separate and distinct. The greater the resolving power of the objective, the clearer the image.

The maximum resolving power of a good medical laboratory microscope is about  $0.25\ \mu\text{m}$  (the resolving power of the normal human eye is about 0.25 mm).

Immersion oil increases the resolving power by conserving many light rays that would be lost by refraction if a dry objective were used.

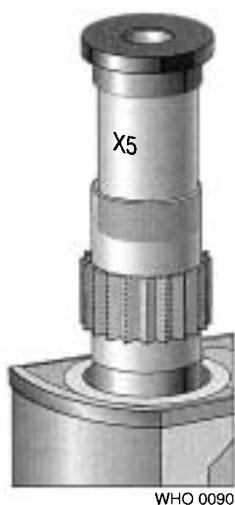

Fig. 3.6 An eyepiece

### *Eyepiece*

#### *Magnification*

The magnifying power of the eyepiece is marked on it (Fig. 3.6):

- a  $\times 5$  eyepiece magnifies the image produced by the objective five times;
- a  $\times 10$  eyepiece magnifies the image 10 times.

If the object is magnified 40 times by the  $\times 40$  objective, then by five times by the  $\times 5$  eyepiece, the total magnification is:  $5 \times 40 = 200$ . To calculate the total magnification of the object observed, multiply the magnifying power of the objective by that of the eyepiece. Microscopes used in medical laboratories have a magnifying power of between  $\times 50$  and  $\times 1000$ .

Certain eyepieces have a calibrated graticule. These eyepieces are used to measure the size of an object under the microscope (e.g. protozoan cysts).

### *Binocular microscopes*

Binocular microscopes (two eyepieces but using only one objective at a time) are generally recommended. They are less tiring for the eyes than monocular microscopes when long examinations have to be made. Electric illumination is, however, essential for using the  $\times 100$  objective.

## **illumination system**

### *Light source*

An electric light source is preferable, since it is easy to adjust. It is provided either by a lamp built into the microscope beneath the stage, or by an external lamp placed in front of the microscope.

### *Mirror*

The mirror reflects rays from the light source onto the object. One side has a plane surface, the other a concave surface (Fig. 3.7). The concave side forms a low-power condenser and is not intended to be used if the microscope already has a condenser.

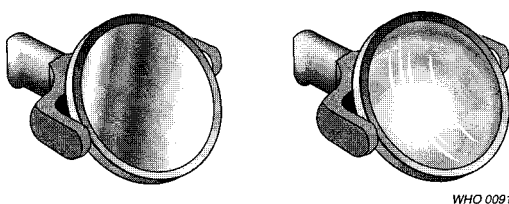

Fig. 3.7 A microscope mirror

### *Condenser*

The condenser (Fig. 3.8) brings the rays of light to a common focus on the object to be examined. It is situated between the mirror and the stage.

The condenser can be raised (maximum illumination) and lowered (minimum illumination). It must be centred and adjusted correctly.

### *Diaphragm*

The diaphragm (Fig. 3.9), which is inside the condenser, is used to reduce or increase the angle and therefore also the amount of light that passes into the condenser.

The wider the diaphragm the greater the numerical aperture and the smaller the detail seen. But the contrast is correspondingly diminished.



Fig. 3.8 A condenser

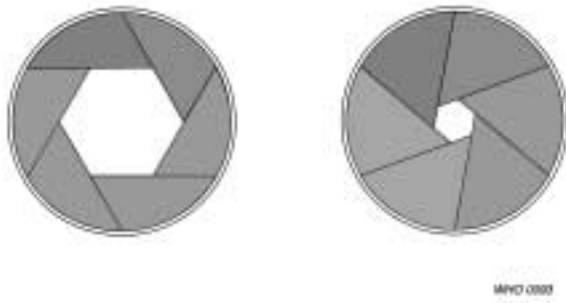

Fig. 3.9 A diaphragm

**Filters**

In some microscopes coloured filters (particularly blue filters) are fitted below the condenser. These can be left in place or removed according to the type of preparation being examined.

**Adjustment system** (Figs. 3.10 and 3.11)

This consists of:

- a coarse adjustment screw
- a fine adjustment screw
- a condenser adjustment screw
- condenser centring screws
- an iris diaphragm lever
- mechanical stage controls.

**Coarse adjustment screw**

This is the largest screw. It is used first to achieve an approximate focus.

**Fine adjustment screw**

This moves the objective more slowly. It is used to bring the object into perfect focus.

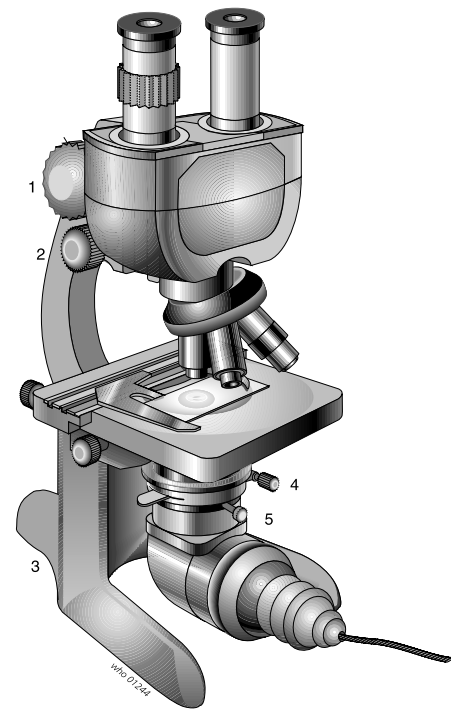

Fig. 3.10 Microscope adjustment system  
 1: coarse adjustment screw;  
 2: fine adjustment screw;  
 3: condenser adjustment screw;  
 4: condenser centring screws;  
 5: iris diaphragm lever.

Fig. 3.11 Mechanical stage controls

### *Condenser adjustment screw*

This is used to raise the condenser for greater illumination or to lower it to reduce the illumination.

### *Condenser centring screws*

There may be three screws placed around the condenser: one in front, one on the left and one on the right. They are used to centre the condenser exactly in relation to the objective.

### *Iris diaphragm lever*

This is a small lever fixed to the condenser. It can be moved to close or open the diaphragm, thus reducing or increasing both the angle and the intensity of the light.

### *Mechanical stage controls*

These are used to move the object slide on the stage: one screw moves it backwards and forwards and the other screw moves it to the left or right (see Fig. 3.11).

## 3.1.2 Setting up the microscope

When a new microscope is received in the laboratory, it is important to know how to set it up correctly.

### **Positioning the microscope**

Place it on a firm level bench (check with a spirit level) of adequate size but not too high. The microscope must be placed in the shade away from the window. Place a square felt pad under the microscope. If no felt is available, use a piece of heavy cloth.

### **Setting up a lamp for the microscope**

If the microscope has a mirror, you can make a lamp to provide illumination. A porcelain holder for a light bulb is fixed on a wooden base and the whole is encased in a wooden or tin box with an opening for the light (Fig. 3.12). Cut slits in the top of the box to enable the bulb to cool.

Alternatively, a flap can be fitted above the opening to serve as a shutter (Fig. 3.13). Use a 100W opaque electric bulb of the “daylight” type (blue–white).

### **Fitting the accessories**

Screw the objectives into the revolving nosepiece, following this order in a clockwise direction:

- $\times 3$ ,  $\times 5$  or  $\times 10$  objective;
- $\times 40$  objective;
- $\times 100$  oil-immersion objective.

The screw threads are standard. After you have screwed in the objectives:

- Put the eyepiece(s) in place.
- Fix the condenser under the stage.
- Fix the mirror on the foot.

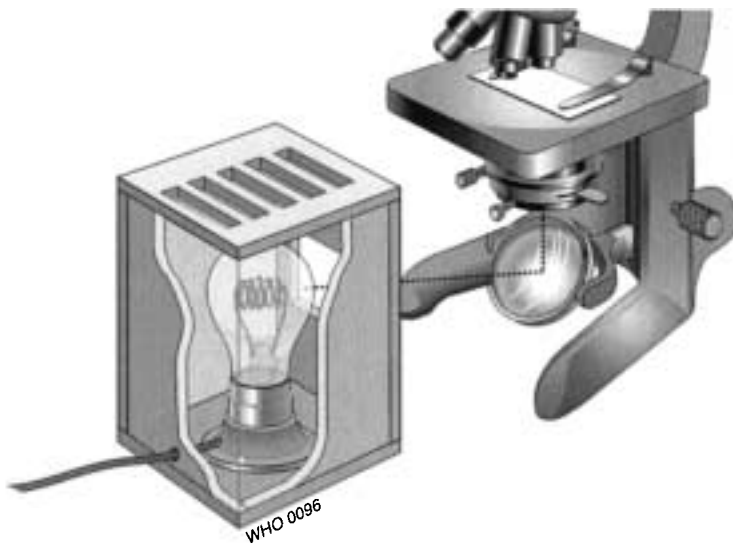

Fig. 3.12 Setting up a lamp for the microscope

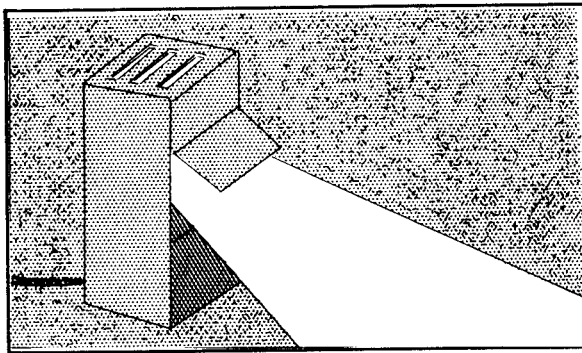

Fig. 3.13 Alternative light source for the microscope

### Positioning the lamp

If electric illumination is to be used, place the lamp 20 cm in front of the microscope facing the mirror. Adjust the position of the lamp so that it shines on the centre of the mirror (Fig. 3.14).

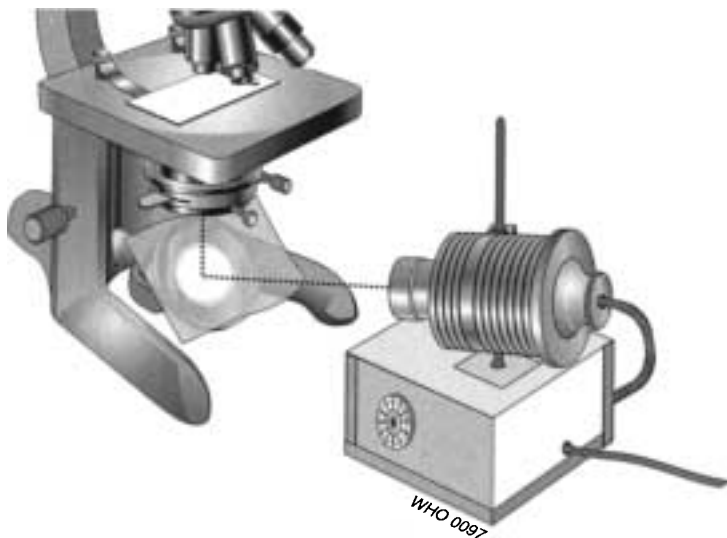

Fig. 3.14 Positioning the light source

If the lamp is fitted with a lens, the filaments of the bulb are projected on to a piece of paper covering the mirror. This makes it possible to centre the beam more precisely. In some models the bulb is turned until a clear image of the filament is obtained.

### Preliminary adjustment of the mirror

Use the plane side of the mirror. Remove any coloured filters. Open the iris diaphragm to the maximum. Raise the condenser. Place a piece of thin white paper over the lens at the top of the condenser (Fig. 3.15).

The piece of paper should show an image of the electric bulb, surrounded by a circle of light. Adjust the mirror so that the image of the bulb is in the exact centre of the circle of light (Fig. 3.16). If daylight is being used, adjust the mirror so as to maximize the amount of light passing through the condenser.

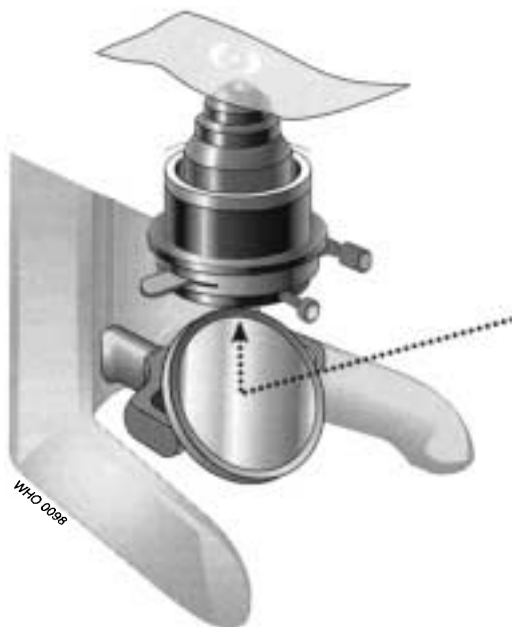

Fig. 3.15 Adjusting the mirror

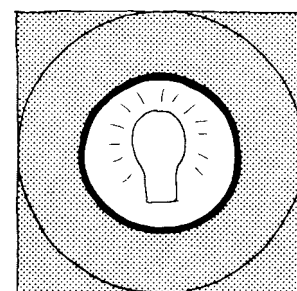

Fig. 3.16 Image of the light source, as seen through the condenser

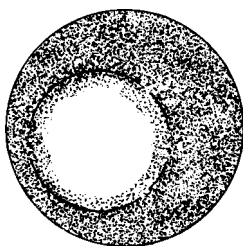

Fig. 3.17 To centre the condenser, first close the diaphragm

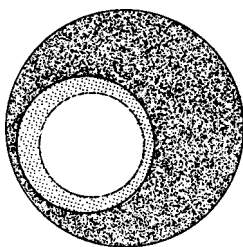

Fig. 3.18 Raise the condenser until the edges of the circle of light are in focus

### Centring the condenser (if centring is provided for)

It is very important to centre the condenser correctly. This is often overlooked.

1. Place a slide preparation without a coverslip on the stage. Lower the condenser. Open the iris diaphragm. Examine with the lowest-power objective ( $\times 3$ ,  $\times 5$  or  $\times 10$ ). Look through the eyepiece and bring the slide into focus.
2. Close the diaphragm. A blurred circle of light surrounded by a dark ring appears in the field (Fig. 3.17).
3. Raise the condenser slowly until the edges of the circle of light are in sharp focus (Fig. 3.18).
4. Adjust the position of the mirror (if necessary) so that the circle of light is in the exact centre of, or superimposed upon, the bright area surrounded by the dark zone (Fig. 3.19).
5. Adjust the centring screws of the condenser so that the circle of light is in the exact centre of the field (Fig. 3.20). Then check with the other objectives.



### Adjusting the diaphragm

Open the diaphragm completely. Remove the eyepiece and look down the tube: the upper lens of the objective will be seen to be filled with a circle of light. Close the diaphragm slowly until the circle of light takes up only two-thirds of the surface (Fig. 3.21). Do this for each objective as it is used.

### Adjusting the eyepieces

#### Selecting the eyepiece

The  $\times 5$  and  $\times 10$  eyepieces give good results in the medical laboratory. The high-power eyepiece increases magnification but there may be no great increase in detail. The eyepiece to use is a matter of individual choice.

#### Binocular adjustment

When a binocular microscope is used, the interpupillary distance (the distance between the pupils of the eyes) can be adjusted to suit the operator.

#### Focusing the eyepieces

One of the eyepiece holders (usually the left) has a focusing collar (Fig. 3.22). If the collar is on the left eyepiece holder, close your left eye and, using the  $\times 40$  objective, bring the image into focus for your right eye with the right eyepiece.

Then close your right eye and look through the left eyepiece. If the image is in focus, no adjustment is needed. If the image is not clear, turn the focusing collar until it is in focus. The microscope is now adjusted to suit your own binocular vision.

### 3.1.3 Focusing the objective

#### Low-power objective ( $\times 10$ )

Rack the condenser down to the bottom. Lower the objective until it is just above the slide preparation. Raise the objective, using the coarse adjustment screw, until a clear image is seen in the eyepiece.



Fig. 3.21 Adjusting the diaphragm

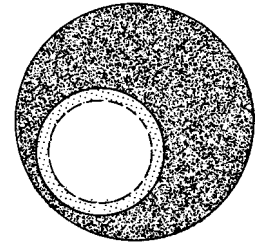

Fig. 3.19 Adjust the position of the mirror to centre the light source

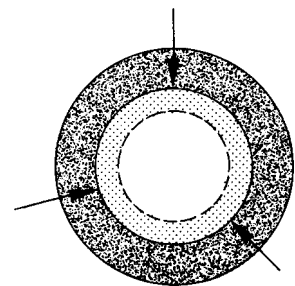

Fig. 3.20 Use the centring screws of the condenser to centre the light source



Fig. 3.22 Focusing the eyepieces

Occasionally a clear image cannot be obtained although the objective has been lowered as far as possible. This is because the fine adjustment screw has been turned right to the end. Turn it back as far as it will go in the other direction and then focus by raising the objective. Rack the condenser up slightly if there is insufficient illumination.

### High-power objective ( $\times 40$ )

Rack the condenser half-way down. Lower the objective until it is just above the slide preparation (the working distance is very short — about 0.5 mm). Using the coarse adjustment screw, raise the objective very slowly until a blurred image appears in the field. Bring into focus using the fine adjustment screw. Raise the condenser to obtain sufficient illumination. If the microscope has no condenser, use the concave side of the mirror.

### Oil-immersion objective ( $\times 100$ )

Perfectly dry, stained preparations must be used. Place a tiny drop of immersion oil on the part to be examined (use synthetic oils, which do not dry, in preference to cedarwood oil, which dries quickly). Rack the condenser up as far as it will go, and open the iris diaphragm fully. Lower the  $\times 100$  objective until it is in contact with the oil. Bring it as close as possible to the slide, but avoid pressing on the preparation (modern objectives are fitted with a damper). Look through the eyepiece and turn the fine adjustment screw very slowly upwards until the image is in focus. If the illumination is inadequate, use the concave side of the mirror as recommended for the  $\times 40$  objective.

*Important:* In most modern microscopes, it is not the objective holder but the stage which is moved up and down by the coarse and fine adjustment screws to bring the image into focus.

### Depth of the microscope field

The image is seen in depth when a low-power objective is used. When the high-power objectives ( $\times 40$ ,  $\times 100$ ) are used, the depth of focus is small and the fine adjustment screw must be used to examine every detail from the top to the bottom levels of focus of the object observed (e.g. the different nuclei in a spherical amoeba cyst).

### Images seen under the microscope

Remember that the circle of light seen in the eyepiece is called “the microscopic field”.

#### *How to establish the position of images seen*

Images observed in the microscopic field can be placed in relation to the hands of a clock. For example, a schistosome egg is placed at “2 o'clock” in Fig. 3.23.

#### *Inversion of images*

The image seen is inverted by the lenses:

- Objects seen at the bottom of the microscopic field are actually at the top.
- Objects seen on the left side of the microscopic field are actually on the right.

#### *Moving the object*

If you move the slide in one direction, the object examined moves in the opposite direction (Fig. 3.24).

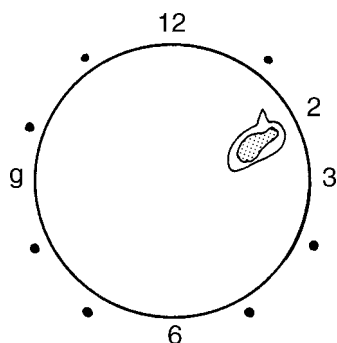

Fig. 3.23 Establishing the position of images seen under the microscope

### Changing the objective

Modern microscopes are made so that the object remains more or less in focus when you change from a low-power objective to a more powerful one. If this is not the case for your microscope, raise the nosepiece before changing to the more powerful objective and refocus. Before changing objectives, make sure that the object examined is in the middle of the field, so that it is not lost after changing the objective.

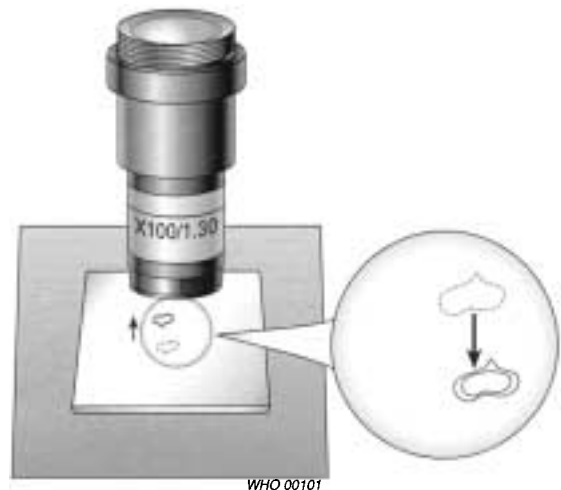

Fig. 3.24 Moving the object

#### 3.1.4 Use of an ocular micrometer

The size of microorganisms or substructures of organisms can be measured by microscopy using an ocular with a calibrated micrometer disc. The micrometer disc has a scale that is usually divided into 0.1-mm and 0.01-mm subdivisions (Fig. 3.25).

A stage micrometer is used to calibrate the ocular micrometer.

#### Materials

- Binocular microscope
- Ocular with a  $\times 10$  magnification
- Ocular micrometer disc
- Stage micrometer
- Lens paper
- Immersion oil.

#### Method

1. Unscrew the eye lens of the ocular.
2. Place the micrometer with the engraved scale face-down in the ocular. Use lens paper to handle the disc.
3. Replace the lens carefully.
4. Place the ocular with the micrometer in the ocular tube of the microscope.
5. Put the calibrated stage micrometer on the stage of the microscope and focus on the scale. You should be able to clearly distinguish the 0.1-mm and 0.01-mm subdivisions.
6. Adjust the stage micrometer so that the 0-mm line coincides with the 0-mm line of the ocular micrometer.
7. Look for another set of lines where the scale of the stage micrometer coincides with that of the ocular micrometer. This set of lines should be as far away from the 0-mm line as possible (Fig. 3.26). The distance between the two coinciding sets of lines varies, depending on the magnification of the objective of the microscope.
8. Count the number of 0.1-mm subdivisions of the stage micrometer scale between the 0-line and the second set of coinciding lines.
9. Count the number of subdivisions of the ocular micrometer scale between the 0-line and the second set of coinciding lines.
10. Calculate the proportion of a millimetre that is measured by a single ocular unit using the following formula:

$$\frac{\text{stage reading (mm)} \times 1000 \mu\text{m}}{\text{ocular reading} \times 1\text{mm}} = \text{ocular units } (\mu\text{m})$$

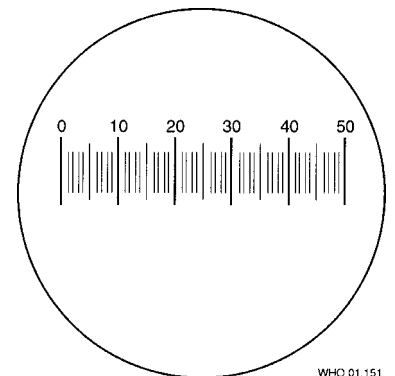

Fig. 3.25 An ocular micrometer disc

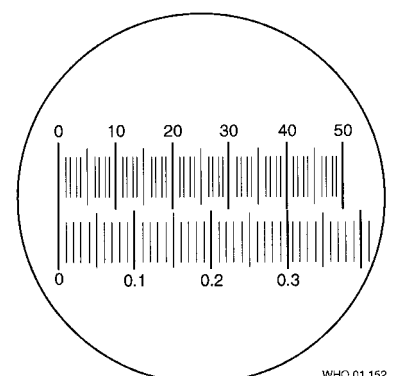

Fig. 3.26 Calibration of an ocular micrometer with a stage micrometer

### *Example*

For a microscope with a high-power objective ( $\times 40$ ), the calculation is as follows:

$$\frac{0.1 \text{ mm} \times 1000 \mu\text{m}}{50 \text{ units} \times 1 \text{ mm}} = 2 \mu\text{m}$$

*Important:* Corresponding objectives should not be exchanged for a calibrated objective, but must be separately calibrated. The ocular containing the micrometer disc should be stored until required. Each microscope that is to be used for measuring the size of organisms must be individually calibrated.

### 3.1.5 Dark-field microscopy

To obtain a dark field a special condenser with a blacked-out centre is used. If this is not available it is possible to obtain a dark field under the  $\times 10$  and  $\times 40$  objectives by inserting a disc or stop in the filter holder below the condenser.

The stops must be made of a material through which light cannot pass and must be the correct size for the objective in use. If the stop is too small, too much light will pass into the objective and a dark field will not be obtained.

If the stop is too large, insufficient light will be available to illuminate the specimen.

### 3.1.6 Routine maintenance

Microscopes must be installed in a clean environment, away from chemicals.

Workplaces should be well ventilated or permanently air-conditioned (intermittent use of air conditioners produces condensed water). The microscope needs daily attention to keep it in good working order and thus to ensure reliable laboratory results. Optical instruments should not be kept for long periods in closed compartments since these conditions also favour fungal growth which can corrode optical surfaces. Special care is required in hot and humid climates.

### **Cleaning the microscope**

Microscopes are used to investigate biological tissues and fluids and must therefore be decontaminated at regular intervals.

#### *Materials*

- Clean pieces of old cloth and a fine linen handkerchief
- Special lens tissue paper or, if unavailable, white absorbent paper or medical-grade cotton wool
- A piece of chamois leather, if possible (otherwise a non-fluffy rag)
- A small bottle of cleaning solution (see below)
- A plastic cover
- A small rubber bulb and, if possible, a soft camel-hair brush (or a fine paintbrush or blower for cleaning lenses)
- A desiccator 15–20 cm in diameter containing not less than 250 g of dry blue silica gel (which indicates humidity by turning pink).

#### *Method*

Cleaning the optical surfaces

The optical surfaces (condenser, objectives, eyepieces) must be kept free of dust with a fine paintbrush, a soft camel-hair brush (Fig. 3.27) or a blower. If dust is found inside the eyepiece, unscrew the upper lens and clean the inside.

Oil residues on the lenses should be removed with special lens tissue paper, absorbent paper or medical-grade cotton wool. The optical surfaces may be finally cleaned with a special solution, consisting of the following:

- 80% petroleum ether (boiling point 60–80°C)
- 20% 2-propanol.

*Note:* Do not use 95% ethanol, xylene or toluene for cleaning the lenses, since these substances dissolve the cement. They can, however, be used for cleaning mirrors.

#### Cleaning the instrument

Heavy contamination can be removed with mild soapy solutions. Grease and oil can be removed with the special cleaning solution described above. The instrument should then be cleaned with a 50:50 mixture of distilled water and 95% ethanol. This mixture is *not* suitable for cleaning the optical surfaces.

The mechanical parts (coarse adjustment screw, fine adjustment screw, condenser focusing and mechanical stage) should be periodically cleaned and lubricated with machine oil to make them run freely.

#### Maintaining the microscope

When you carry out repair and maintenance procedures, take care not to confuse the condenser centring screws with the condenser clamp screws. To maintain the microscope proceed as follows:

- Check the mechanical stage.
- Check the focusing mechanism.
- Remove any fungal growth.
- Check the diaphragm.
- Clean all mechanical parts.
- Lubricate the microscope according to the manufacturer's instructions.
- Check the spring load on the specimen clamp. Too high a tension may result in breakage of slides and damage to the clamp.
- Check the optical alignment. A dim appearance of the specimen is often due to misalignment of the optical parts rather than to insufficient light.

#### Precautions

- Never dip the objectives in xylene or ethanol, as this may cause the lenses to become detached.
- Never use ordinary paper to clean the lenses.
- Never touch the lenses with your fingers.
- Never clean the support or the stage with xylene or acetone.
- Never clean the inside lenses of the eyepieces and objectives with cloth or paper (this might remove the anti-reflective coating); use a soft camel-hair brush, a fine paintbrush or a blower instead.
- Never leave the microscope without the eyepieces unless the openings are plugged.
- Never keep the microscope in a closed wooden box in hot humid countries.
- Never press the objective on to the slide, since both the slide and the objective may break. Take care when focusing the microscope.

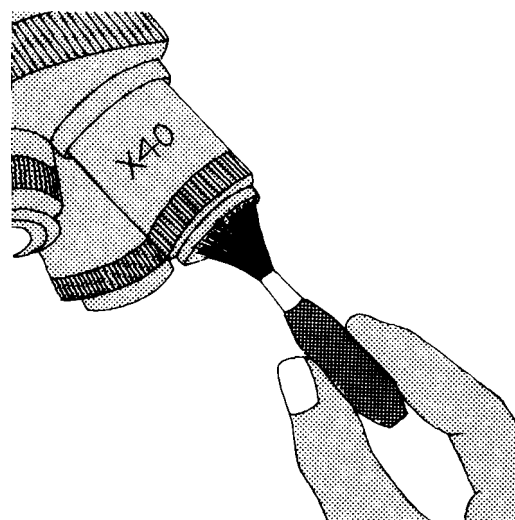

Fig. 3.27 Cleaning the objective lenses using a soft camel-hair brush

- Keep the mechanical stage clean.
- Do not dismantle the optical components, as this may cause misalignment. The optical surfaces should be cleaned with lens cleaning tissue or soft tissue paper.
- Never put the microscope away with immersion oil on the objective. Remove any oil daily. Mild soap solution is suitable for most cleaning.
- Use organic solvents only in accordance with the manufacturer's recommendations.
- Never carry the microscope by the limb with one hand; use both hands, one under the foot, the other holding the limb.
- When changing a bulb, avoid touching the glass with your fingers, as fingerprints reduce the intensity of illumination.
- To maximize the lifespan of bulbs, adjust the voltage with a dimmer switch to give the lowest required light intensity.
- If the mains voltage fluctuates excessively, use a voltage stabilizer.

### **Additional precautions to be taken in hot climates**

#### *Dry climates*

In hot, dry climates the main problem is dust. Fine particles work their way into the threads of the screws and under the lenses. This can be avoided as follows:

- Always keep the microscope under an airtight plastic cover when not in use.
- At the end of the day's work, clean the microscope thoroughly by blowing air over it with a rubber bulb.
- Finish cleaning the lenses with a soft camel-hair brush, a fine paintbrush or a blower. If dust particles remain on the surface of the objective, clean it with special lens tissue paper.

#### *Humid climates*

In hot, humid climates and during the wet season in hot, dry climates, fungi may grow on the microscope, particularly on the surface of the lenses, in the grooves of the screws and under the paint, and the instrument will soon be useless. This can be prevented as described below.

Always keep the microscope under an airtight plastic cover when not in use, together with a dish filled with blue silica to dry the air under the cover. (The silica will turn red when it has lost its capacity to absorb moisture from the air. It can be simply regenerated by heating in a hot-air oven or over a fire.) The microscope must be cleaned daily to get rid of dust.

These procedures must be carried out regularly, and are essential in conjunction with repair and maintenance procedures.

### **3.2 Weighing: use of laboratory balances**

Balances may be either electrically or manually operated. All types should be positioned on a firm level bench away from vibrations, draughts and direct sunlight.

The balance is used to weigh chemicals for production of reagents, and cleanliness is essential if accurate results are to be obtained:

- Remove dust by blowing or using a soft brush.
- Remove stains or chemicals using a soft brush.
- Use a plastic weigh boat or filter-paper to weigh chemicals on the balance; never place chemicals directly on to the pan.

*Important:* If water has been used to clean the balance, make sure that it is thoroughly dry before weighing. Always set the balance to zero before weighing. Check the accuracy of the balance regularly according to the manufacturer's recommendations. Handle loose weights with forceps.

### 3.2.1 Sensitivity of a balance

The sensitivity corresponds to the smallest mass that makes the pointer move over one division on the scale. For example, if the sensitivity of a balance is 1 mg, this means that a mass of at least 1 mg is needed to move the pointer.

For routine laboratory purposes, the sensitivity of a balance can be considered to be the *smallest mass* that it will measure accurately.

### 3.2.2 Open two-pan balance (Fig. 3.28)

The two-pan balance has two pans supported by shafts. It may be designed for use with separate weights, as illustrated in Fig. 3.29, or may incorporate a graduated arm with a sliding weight. It is used to weigh large amounts (up to several kilograms) when a high degree of accuracy is not required, e.g. 22.5 g, 38 g, 8.5 g, 380 g. Sensitivity: 0.5 g.

If the pans are made of easily scratched or corroded material, protect them with circles cut out of strong plastic or old X-ray films; the two circles should be of equal weight.

#### Instructions for use

1. Place the bottle containing the substance to be weighed to the left of the balance.
2. Place on the left-hand pan the receptacle (folded paper or dish) in which the substance will be weighed.
3. Place on the right-hand pan the weights equivalent to the weight of the receptacle plus the amount of the substance to be weighed.
4. To measure out the substance to be weighed, hold the bottle tilted in your left hand (label upwards) and tap the neck of the bottle gently with your right hand, so that the powder or crystals to be weighed fall little by little into the receptacle (Fig. 3.30). (Use a clean spatula to dispense small amounts of substances for weighing.)

When the substance has been weighed, move the bottle to the right-hand side of the balance (Fig. 3.31).

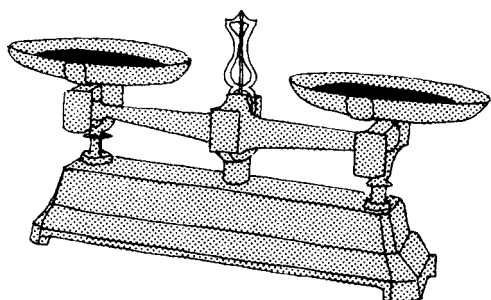

Fig. 3.28 An open two-pan balance

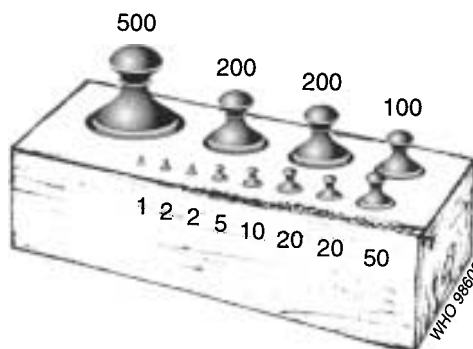

Fig. 3.29 Set of weights (in grams) for use with an open two-pan balance

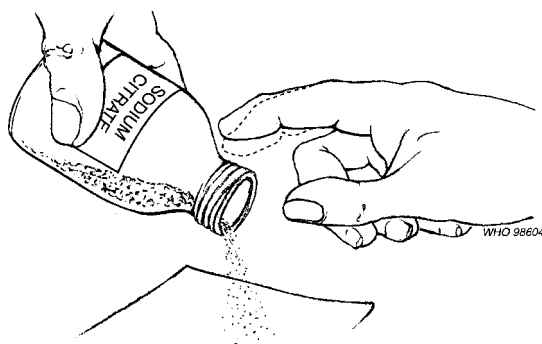

Fig. 3.30 Measuring out the substance to be weighed

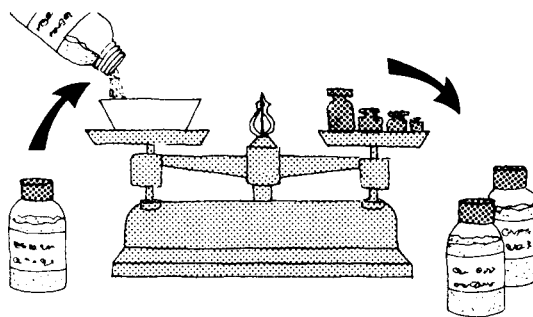

Fig. 3.31 Keep weighed and unweighed substances apart to avoid confusion

Thus place:

- the weighed substances on the right
- the unweighed substances on the left.

This avoids confusion.

Read the label three times:

- before taking the bottle off the shelf;
- while weighing the substances (label facing upwards);
- after weighing, when you move the bottle to the right of the balance.

### 3.2.3 Analytical balance

This balance has two pans suspended from a cross-beam inside a glass case.

Use the balance:

- to weigh small quantities (up to 20 or 200 g, depending on the model);
- when great accuracy is required: e.g. 3.85 g, 0.220 g, 6.740 g.

Sensitivity: 0.1–0.5 mg, depending on the model.

#### Components (Fig. 3.32)

- Cross-beam (CB). This is the structure from which the pans are suspended.
- Knife edges (KE1, KE2, KE3). These support the beam at the fulcrum during the weighing and give sensitivity to the balance. Those on the beam support the suspended pans.
- Stirrups (S1, S2).
- Pointer (Pt).
- Pans (P).
- Beam release screw (or pan lock control) (B). Locks the pan so that the sudden addition of weights or chemicals will not damage the delicate knife edges.
- Adjusting screws (AS1, AS2). Used only for initial adjustment of the unloaded balance to a reading of zero.

Figure 3.33 shows a set of weights for use with an analytical balance.

#### Instructions for use

- Always ensure that the cross-beam is at rest (beam release screw tightened) before placing the weights and the substance to be weighed on the pans.



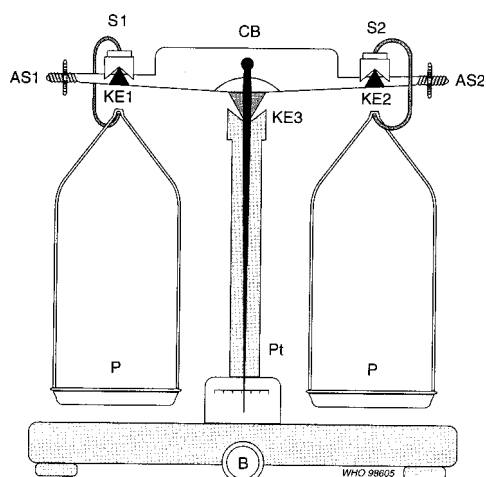

Fig. 3.32 Components of an analytical balance  
AS1, AS2: adjusting screws; B: beam release screw; CB: cross-beam; KE1, KE2, KE3: knife edges; P: pans; Pt: pointer; S1, S2: stirrups.

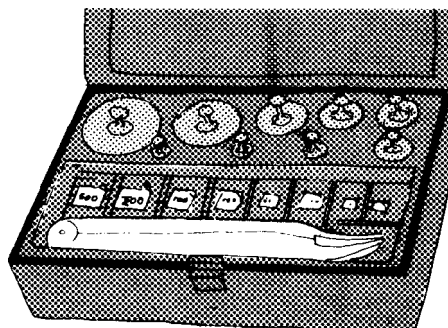

Fig. 3.33 Set of weights for use with an analytical balance  
Single pieces: 1 g, 2 g, 5 g, 10 g, 20 g, 50 g, 100 g, 200 g and 500 g.  
Single fractional pieces: 2 mg, 5 mg, 10 mg, 20 mg, 50 mg, 100 mg, 200 mg and 500 mg.

- Check that the pans are balanced (after closing the glass case) by unscrewing the beam release screw.
- Always place the substance to be weighed on a piece of paper folded in four, or in a watch glass or porcelain dish.
- Use the adjusting screws (AS1 and AS2) to obtain a perfect balance when compensating for the weight of the receptacle in which the substance will be weighed.
- Always use forceps to pick up the weights.
- Always put the cross-beam back at rest before removing the weights and the substance that has been weighed from the pans.

### 3.2.4 Dispensary balance (Fig. 3.34)

This balance also has two suspended pans, but it has no glass case and no supports.

Sensitivity: 5–10 mg.

The dispensary balance is more accurate than the open two-pan balance, but weighs only up to 50 g.

After using the dispensary balance, put it away in a closed cupboard.

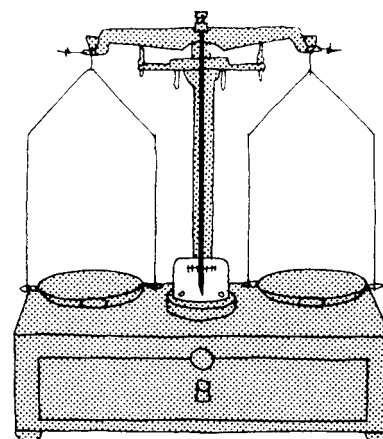

Fig. 3.34 A dispensary balance

## 3.3 Centrifugation

### 3.3.1 Principle

A body is rotated in a circular movement at speed. This creates a force that drives the body away from the centre of the circular movement (Fig. 3.35). To calculate the relative centrifugal force (rcf) for an individual centrifuge, measure the radius ( $r$ ) of the rotor arm (in cm) and the number of revolutions per minute (rpm) and use the formula below:

$$\text{rcf} = 1.118 \times 10^{-6} \times r \times (\text{rpm})^2$$

For example, if the radius is 25 cm and the rpm is 1300 rev/min, the rcf is about 50g.

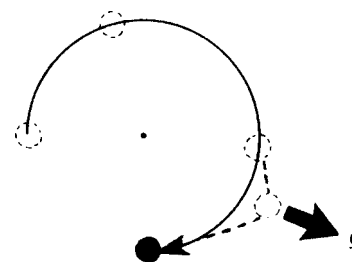

Fig. 3.35 Principle of centrifugation

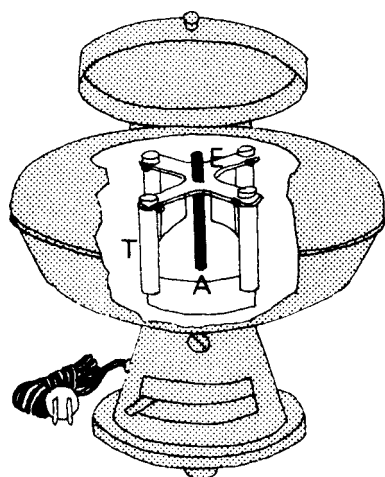

Fig. 3.36 Components of a centrifuge  
A: central shaft or spindle;  
E: centrifuge head;  
T: centrifuge tubes.

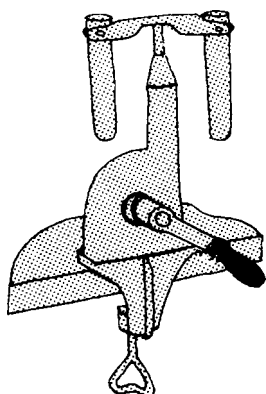

Fig. 3.37 A hand-operated centrifuge

### Components of a centrifuge (Fig. 3.36)

A centrifuge consists of:

- a central shaft or spindle (A) that rotates at high speed;
- a head (E), fixed to the shaft, with buckets for holding the centrifuge tubes;
- tubes (T) containing the liquid to be centrifuged.

When the spindle rotates the tubes are subjected to centrifugal force. They swing out to the horizontal and the particles in suspension in the liquids in the tubes are thrown to the bottom of the tubes. The particles are compacted at the bottom of the centrifuge tubes. These particles form the centrifuge deposit which can be separated from the supernatant fluid and examined. The deposit may contain, for example:

- blood cells;
- parasite eggs (in diluted stools);
- cells from the urinary tract (in urine).

### 3.3.2 Types of centrifuge

#### Hand-operated centrifuge (Fig. 3.37)

This is operated manually by turning a handle. It takes two or four tubes.

The hand-operated centrifuge can be used:

- to examine urinary deposits;
- to concentrate certain parasites in stools.

The speed is insufficient for satisfactory separation of erythrocytes from plasma in blood.

*Important:*

- Clamp the centrifuge firmly on a stable support (edge of a table).
- Balance the two diametrically opposite tubes perfectly as described in the instructions for use, section 3.3.3.
- Keep your distance while operating the centrifuge.
- To stop the centrifuge, do not slow down the turning of the handle. Pull the handle out of the machine with a sharp movement.
- Remove the tubes slowly and carefully (so as not to disturb the deposit).
- Lubricate the spindle of the centrifuge regularly.

*Warning:* The hand-operated centrifuge can cause serious injury, so follow the instructions above carefully.

#### Electric centrifuges

Electric centrifuges are more accurate than hand-operated centrifuges and should be used whenever possible. Electric centrifuges are used with two types of head — the “swing-out” head and the “angle” head.

##### “Swing-out” head (Fig. 3.38)

The head is designed to swing the tubes out to a horizontal position during centrifuging. This is the type most frequently needed.

##### “Angle” head (Fig. 3.39)

The “angle” head holds the tubes at an angle of about 45° during centrifuging. It is useful for certain techniques, e.g. agglutination tests in blood-grouping by the test-tube method.

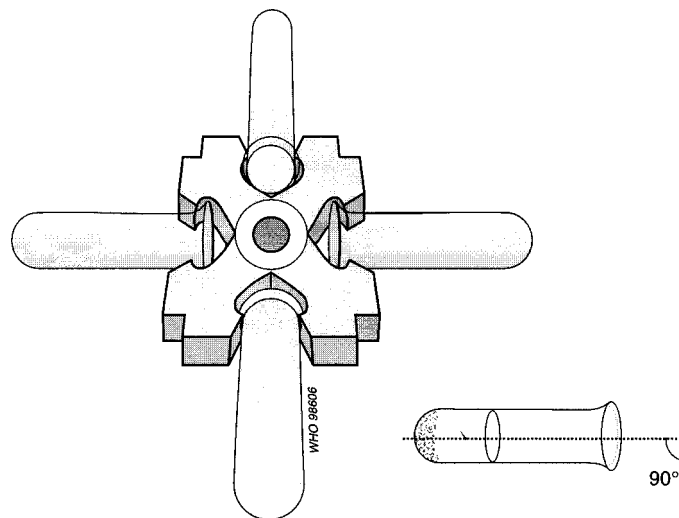

Fig. 3.38 A centrifuge with a swing-out head

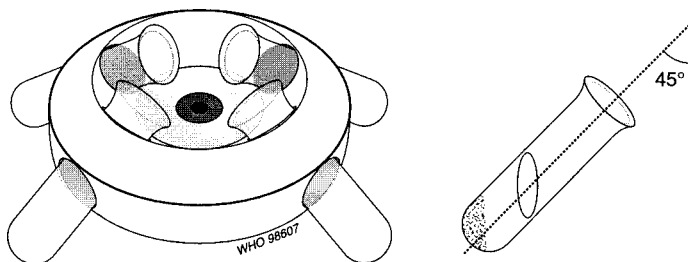

Fig. 3.39 A centrifuge with an angle head

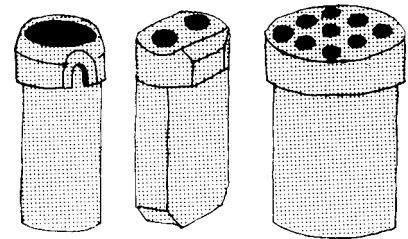

Fig. 3.40 Types of bucket for a centrifuge

### **Buckets (tube holders)**

There are several types of bucket for use with electric centrifuges (Fig. 3.40). The choice depends on the model of centrifuge:

- buckets designed to hold one round-bottomed or conical tube only;
- buckets that hold two round-bottomed or conical tubes;
- buckets that hold nine small (precipitin) tubes, etc.

Some models are also fitted with:

- a timer that stops the centrifuge automatically when the time is up (e.g. after 5 or 10 minutes);
- a cooling chamber that prevents heating of the specimen during centrifuging;
- a revolution counter, i.e. a dial with a needle that indicates the speed of the machine during centrifuging (this is useful for some methods of concentration of parasites).

### **Battery-operated centrifuges**

Small battery-operated centrifuges are sometimes used to measure the packed cell volume in haematology.

#### **3.3.3 Instructions for use**

You should always follow the manufacturer's instructions when using the centrifuge.

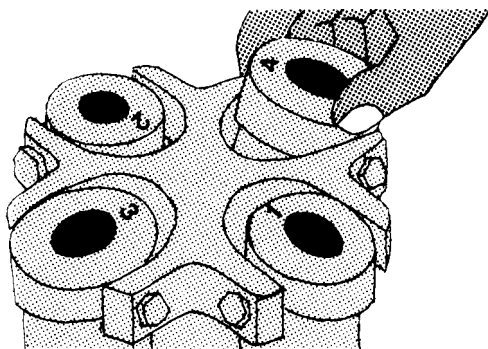

Fig. 3.41 Balancing centrifuge tubes

### Installing the centrifuge

The centrifuge must be placed on rubber pads or a mat on a flat level surface.

### Balancing the tubes

If the tubes are numbered, place them as shown in Fig. 3.41:

- tube 1 opposite tube 2;
- tube 3 opposite tube 4.

Balance the tubes that are opposite each other by weighing them in their buckets on the open two-pan balance.

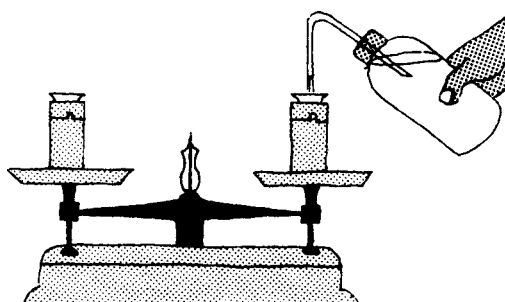

Fig. 3.42 Balancing centrifuge tubes by adding liquid to the lighter tube

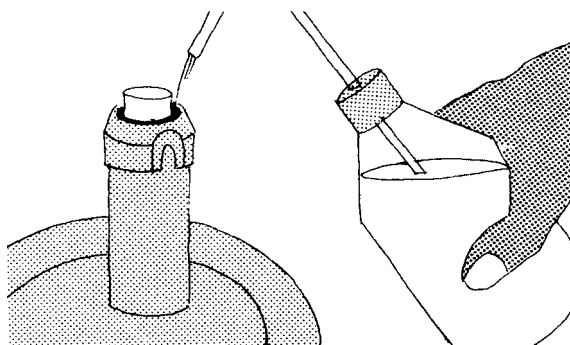

Fig. 3.43 Balancing centrifuge tubes by adding water to the bucket containing the lighter tube

To balance: *either* add more of the liquid to be centrifuged to the lighter tube (Fig. 3.42); *or* add water to the bucket containing the lighter tube (using a wash bottle; Fig. 3.43).

If only one tube of liquid is to be centrifuged, balance it with an identical tube filled with water.

### Preventing breakage of tubes

Always pad the bottom of the buckets with the rubber cushions provided with the machine. This protects the bottom of the centrifuge tubes.

Using a wash bottle, add a little water between each tube and its bucket.

### Safety precautions

- Check that the tubes are the correct size for the centrifuge. Tubes that are too long or too small may break.
- Fill the tubes to no more than three-quarters full to prevent spillage in the bowl.
- Always balance the centrifuge buckets before starting the centrifuge. Failure to do this can cause excessive wear or the centrifuge may move.
- Ensure that the lid is closed before starting the centrifuge.
- When starting the centrifuge, gradually increase the speed, turning the knob slowly, until the desired speed is reached.
- Stop the centrifuge gradually (some models have a brake that can be applied). Never try to slow the centrifuge down with your hand.
- Never open the centrifuge until it has come to a complete stop.
- Remove the tubes slowly and carefully.

## Cleaning and maintenance

For details of cleaning and maintenance of centrifuges, see section 3.5.3.

## 3.4 Measurement and dispensing of liquids

Many of the liquids handled in the laboratory are either infectious, corrosive or poisonous. It is important for the prevention of accidents that the correct procedures for the measurement and dispensing of these liquids are clearly understood and are followed conscientiously.

Many of the new procedures for analysis require very small volumes of fluid and various pipetting and dispensing devices are available to enable small volumes to be measured with great precision.

Large volumes can be measured using a measuring cylinder or a volumetric flask.

A measuring cylinder measures various volumes of fluid but is not very accurate. A volumetric flask measures a single volume of fluid, e.g. 1 litre, accurately.

Small volumes of fluid (0.1–10 ml) can be dispensed rapidly and accurately using one of the following methods:

- A fixed or variable volume dispenser attached to a reservoir made of glass or polypropylene. Various volumes from 0.1 to 1.0 ml and from 2.0 to 10.0 ml can be dispensed.
- A calibrated pipette with a rubber safety bulb.

### 3.4.1 Pipettes

#### Types of pipette

##### Graduated pipettes

Graduated pipettes have the following information marked at the top (Fig. 3.44):

- the total volume that can be measured;
- the volume between two consecutive graduation marks.

There are two types of graduated pipette (Fig. 3.45):

- A pipette with graduations to the tip (A). The total volume that can be measured is contained between the 0 mark and the tip.
- A pipette with graduations not extending to the tip (B). The total volume is contained between the 0 mark and the last mark before the tip (this type is recommended for quantitative chemical tests).

Various volumes can be measured using graduated pipettes. For example:

- a 10-ml pipette can be used to measure 8.5 ml;
- a 5-ml pipette can be used to measure 3.2 ml;
- a 1-ml pipette can be used to measure 0.6 ml.

##### Volumetric pipettes

Volumetric pipettes are intended to measure a precise volume with a high degree of accuracy.

There are two types of volumetric pipette (Fig. 3.46):

- A pipette with a single graduation mark (A), which is intended to be filled to the mark. After discharge of the contents, the pipette is allowed to drain for 15–45 seconds, according to its size (marked on the bulb) and the last drop is expressed against the side of the recipient container. It should not be expelled.



Fig. 3.44 A graduated pipette

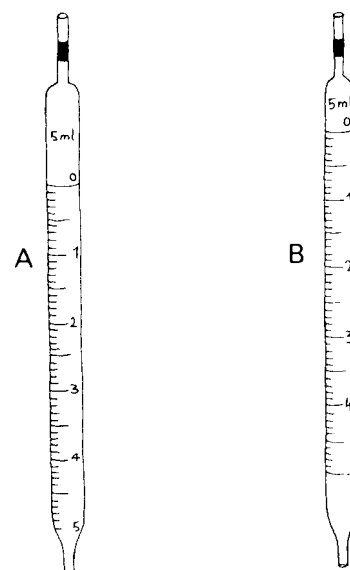

Fig. 3.45 Types of graduated pipette  
A: pipette with graduations to the tip;  
B: pipette with graduations not extending to the tip.

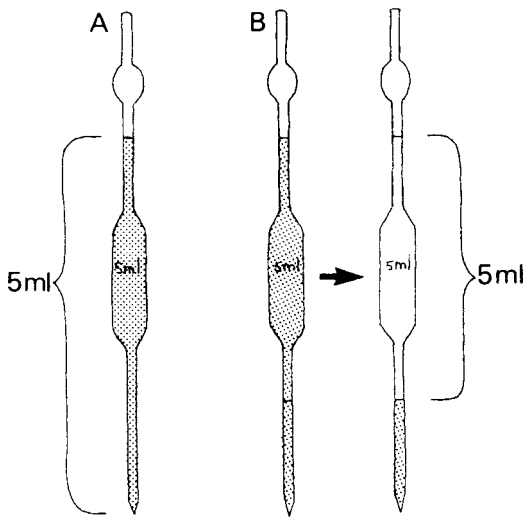

Fig. 3.46 Types of volumetric pipette  
A: pipette with a single graduation mark; B: pipette with two graduation marks.

- A pipette with two graduation marks (B) may be more accurate in skilled hands. It is less reliable when used by an inexperienced person because it is easy to overrun the lower graduation mark when discharging the contents.

Hold the pipette vertically to check that the liquid reaches the desired graduation mark (G in Fig. 3.47). This mark should be level with the bottom of the meniscus formed by the liquid. The tip of the pipette should be held against the side of the receptacle while the fluid is discharged.

#### Plastic bulb pipettes

Plastic bulb pipettes are cheap and very useful for transferring volumes of liquid such as serum or disinfectant. They are available with different tips and can be obtained with calibrations marked on the stem.

They can be reused after disinfection and washing but cannot be autoclaved.

#### Micropipettes

Micropipettes with disposable tips are frequently used to measure small volumes. They are available in a variety of volumes, ranging from  $5\mu\text{l}$  to  $1000\mu\text{l}$ . Used tips are disposed of directly into disinfectant using an ejector mechanism. The micropipettes have two positions of the plunger operated by thumb (Fig. 3.48). The first position is used to pick up the sample and the second to expel the sample from the tip into a tube or well.

Fig. 3.47 How to hold a pipette  
G: graduation mark;  
S: safety bulb.

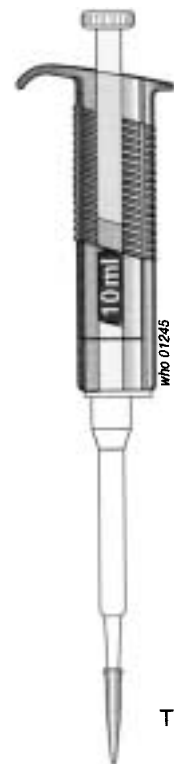

Fig. 3.48 A micropipette with a disposable tip  
T: disposable tip.

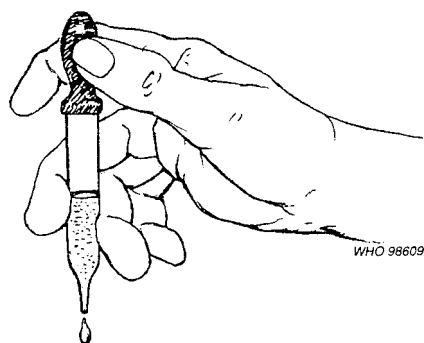

Fig. 3.49 Using a dropping pipette

Fig. 3.50 Calibrating a dropping pipette  
S: safety bulb.

Micropipettes must be calibrated and maintained according to the instructions of the manufacturer.

#### *Calibrated dropping pipettes*

Ordinary calibrated dropping pipettes often deliver 20 drops per ml of distilled water, thus 1 drop = 0.05 ml. Hold the dropping pipette absolutely vertical to expel the drops (Fig. 3.49).

#### Calibration of dropping pipettes (Fig. 3.50)

Using a volumetric pipette (see page 74), measure 1 ml of water into a small tube. Draw the water into the dropping pipette to be calibrated. Count the number of drops delivered from the millilitre of water. Repeat the procedure three times to check the accuracy.

#### **Precautions**

Pipetting by mouth is dangerous and should not be done. It can cause the following:

- infection
- burns
- poisoning
- cuts.

Always use a rubber safety bulb (see Fig. 3.50) with the pipette instead.

#### 3.4.2 Volumetric flasks

Volumetric flasks are graduated to measure a certain volume when filled to the graduation mark.

They have various capacities:

- 2000 ml
- 1000 ml
- 500 ml
- 250 ml
- 200 ml
- 100 ml
- 50 ml
- 25 ml.

Volumetric flasks are more accurate than measuring cylinders. They should be used for the preparation of reagents.

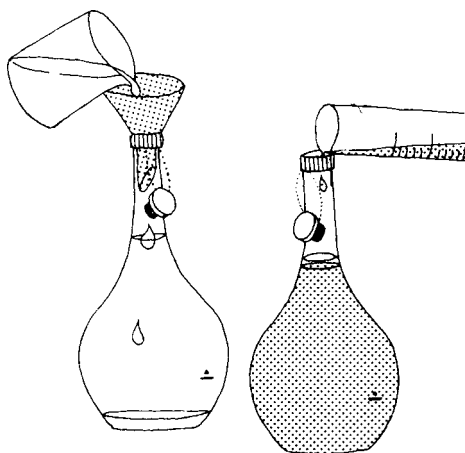

Fig. 3.51 Preparing sodium chloride solution in a volumetric flask

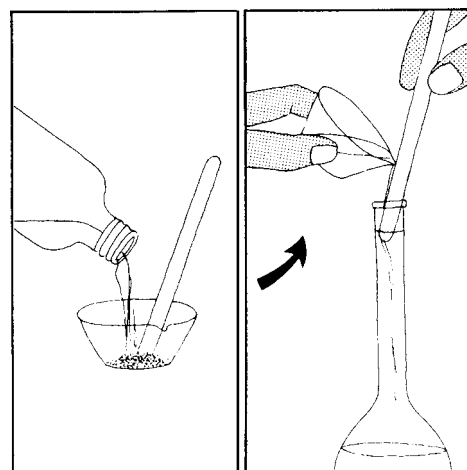

Fig. 3.52 Alternative method for preparing reagents using a volumetric flask

For example: 1 litre of sodium chloride, 0.85% solution (reagent no. 53), is prepared by washing 8.5 g of sodium chloride, dissolved in 100 ml of distilled water in a beaker, into a 1000-ml flask through a funnel and diluting to the 1000-ml mark (Fig. 3.51). The solution should be shaken before use.

Alternatively, the substance(s) can be dissolved in a small container and the solution poured into the flask along a glass rod (Fig. 3.52). Fill to the graduation mark. (This method is recommended for the preparation of titrated chemical reagents.)



Fig. 3.53 Mark the temperature at which the reagent should be measured on the flask

### Temperature of the liquid

The temperature at which liquids should be measured is etched on the flask (after the capacity figure; Fig. 3.53).

Liquids expand with heat and contract with cold. Never measure hot liquids, or cold liquids just taken from the refrigerator.

### Stoppers

Volumetric flasks should have plastic stoppers; if these are not available use ground glass ones. Be careful not to lose them.

### Cost

Volumetric flasks are very expensive, so use them with great care.



### 3.4.3 Burettes

These are graduated glass tubes with a glass stopcock at the lower end. Burettes are filled from the top with the liquid to be measured (Fig. 3.54). They are of 10 ml, 20 ml, 25 ml and 50 ml capacity.

#### Maintenance of burettes

The stopcock and tap should be kept well greased. To grease a clean stopcock properly, apply the tiniest smear of petroleum or silicone jelly with a finger tip down the two sides of the stopcock away from the capillary bore. Then insert the stopcock in the burette and rotate it until a smooth covering of the whole stopcock is obtained. Keep the top plugged or covered (Fig. 3.55).

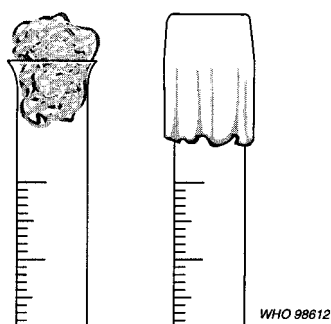

Fig. 3.55 Keep the top of the burette plugged or covered

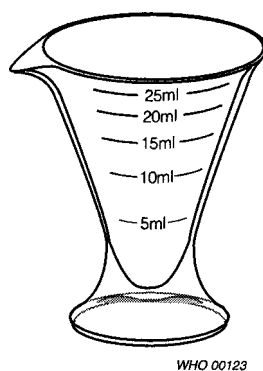

Fig. 3.56 A graduated conical testing glass

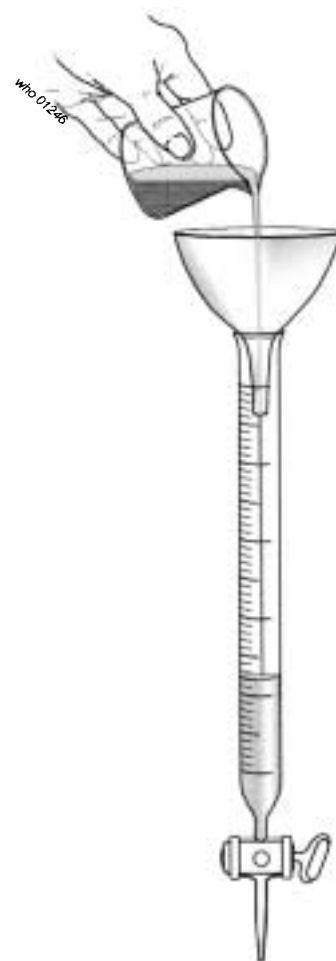

Fig. 3.54 Filling a burette

### 3.4.4 Graduated conical glasses (Fig. 3.56)

These are not accurate. Avoid using them for laboratory tests.

## 3.5 Cleaning, disinfection and sterilization

### 3.5.1 Cleaning glassware and reusable syringes and needles

Instructions for cleaning:

- glass containers (Erlenmeyer flasks, beakers, test-tubes)
- pipettes
- microscope slides
- coverslips
- reusable syringes and needles.

#### Glass containers

##### *New glassware*

Glassware that has never been used may be slightly alkaline.

In order to neutralize it:

- Prepare a bowl containing 3 litres of water and 60 ml of concentrated hydrochloric acid (i.e. a 2% solution of acid).
- Leave the new glassware completely immersed in this solution for 24 hours.
- Rinse twice with ordinary water and once with demineralized water.
- Dry.

### **Dirty glassware**

#### **Preliminary rinsing**

Rinse twice in cold or lukewarm water (never rinse bloodstained tubes in hot water).

If the glassware has been used for fluids containing protein, it should be rinsed immediately and then washed (never allow it to dry before rinsing).

#### **Soaking in detergent solution**

Prepare a bowl of water mixed with washing powder or liquid detergent. Put the rinsed glassware in the bowl and brush the inside of the containers with a test-tube brush (Fig. 3.57). Leave to soak for 2–3 hours.

#### **Rinsing**

Remove the articles one by one. Rinse each one thoroughly under the tap, then soak them all in a bowl of ordinary water for 30 minutes.

Rinse each article in a stream of clean water. (Do not forget that traces of detergent left on glassware can lead to false laboratory results.)

#### **Draining**

Place containers (beakers, flasks, measuring cylinders) on the pegs of a draining rack. Place test-tubes upside-down in a wire basket.

#### **Drying**

Place the glassware in wire baskets and dry in a hot-air oven at 60 °C. Alternatively, place the baskets in a sunny spot in the laboratory and cover them with a fine cloth.

#### **Plugging**

The clean dry glassware should be put away in a cupboard to protect it from dust. It is recommended that glass containers be plugged with non-absorbent cotton wool or their mouths covered with small caps made from newspaper (Fig. 3.58) or, preferably, thin sheets of paraffin wax or clinging plastic, if available.

### **Pipettes**

#### **Immediate rinsing**

Once a pipette has been used, rinse it immediately in a stream of cold water to remove blood, urine, serum, reagents, etc.

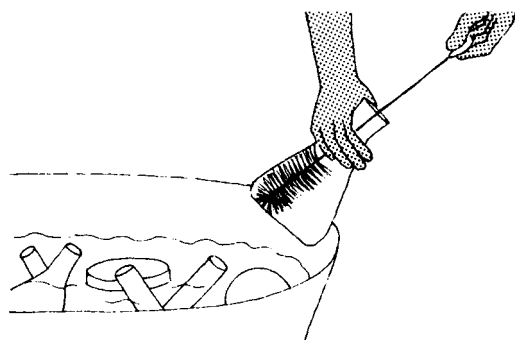

Fig. 3.57 Cleaning dirty glassware

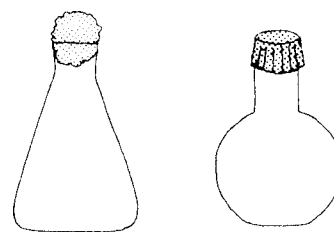

Fig. 3.58 Plug or cover glassware to protect it from dust

### *Soaking in water*

After rinsing, place the pipettes in a large, plastic measuring cylinder (or bowl) full of water. If the pipettes have been used to measure infected material, leave them in a cylinder full of disinfectant solution (e.g. a quaternary ammonium compound or 1% bleach solution; see pages 84 and 85) for 4 hours.

### *Soaking in detergent and rinsing*

Follow the instructions given above for soaking and rinsing of laboratory glassware.

### *Blocked pipettes*

1. Put blocked pipettes in a cylinder filled with dichromate cleaning solution (reagent no. 20). Slide them carefully into the solution and leave for 24 hours.
2. The next day, pour the dichromate solution into another cylinder (it can be used four times).
3. Hold the cylinder containing the pipettes under the tap and rinse thoroughly.
4. Remove the pipettes one at a time. Check that the obstruction has been washed away. Rinse again.
5. Leave to soak in ordinary water for 30 minutes, then change the water and soak for a further 30 minutes.

*Warning:* Dichromate cleaning solution is highly corrosive and should be used with extreme care. If it is accidentally splashed on the skin or clothing or into the eye(s), wash at once with large quantities of water.

### *Drying*

Dry heat-resistant glass pipettes in a hot-air oven at 60°C and ordinary pipettes in an incubator at 37°C. Alternatively, leave pipettes to air-dry.

### *Using the vacuum pump*

This is a small instrument made of metal, plastic or glass that is attached to the water tap.

1. Turn the water on hard to drive a strong jet through the pump. This causes air to be sucked into the side arm of the pump and the rubber tubing attached to it.
2. Fit this rubber tubing over the tip of the pipette.
3. Dip the other end of the pipette into the rinsing liquid (water or detergent solution), which is sucked through the pipette and discharged by the pump into the sink (Fig. 3.59).

### **Microscope slides**

#### *New slides*

#### *Soaking in detergent solution*

Prepare a bowl of water mixed with washing powder or liquid detergent. Use the amounts recommended by the manufacturer. Place the slides in the bowl one by one and leave to soak overnight.

#### *Rinsing in water*

Rinse each slide with tap water and then soak in clean water for 15 minutes.

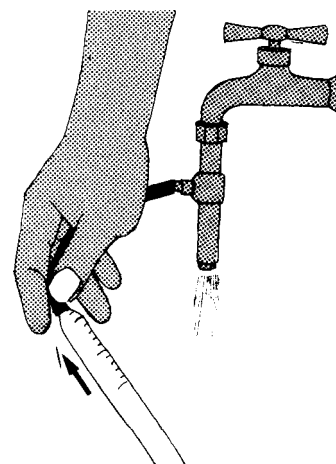

Fig. 3.59 Using a vacuum pump to rinse a pipette

### Wiping and drying

Wipe the slides, one at a time, with a soft, non-fluffy cloth. Place them on a sheet of filter paper, one by one. Leave to dry. Examine each slide. Discard any slides that are stained, scratched or yellow or that have dull patches on them, or try to clean them again.

### Wrapping up

Divide the slides into piles of 10 or 20 and wrap each pile in a small sheet of paper.

### Numbering

In some laboratories the slides are numbered in advance in series of five packets with a diamond pencil. (For example, for packets containing 20 slides each, the slides are numbered 1–20, 21–40, 41–60, 61–80 and 81–100, respectively.)

### *Dirty slides*

#### Slides covered with immersion oil

Take the oily slides one by one and rub them with newspaper to remove as much of the oil as possible.

#### Slides with coverslips

Using the tip of a needle or forceps, detach the coverslips and drop them into a beaker of water (Fig. 3.60) (for cleaning of coverslips, see overleaf).

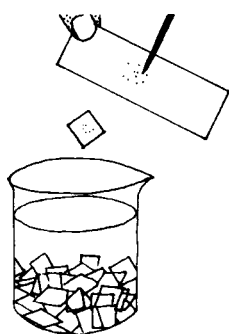

Fig. 3.60 Removing coverslips from a slide for cleaning

#### Soaking in detergent solution

Prepare a bowl of cold or lukewarm water mixed with detergent. Use the amount recommended by the manufacturer to produce a strong detergent solution.

Leave the slides to soak for 24 hours.

*Note:* Detergents containing enzymes are excellent for removing blood films.

When slides have been used for infected specimens (e.g. urine, stools), they should be placed in disinfectant solution before cleaning.

### Cleaning

After the slides have soaked for 24 hours, prepare another bowl containing a weak detergent solution (15 ml of household detergent per litre of water).

Remove the slides one by one from the strong detergent solution.

Rub each one with cotton wool dipped in the strong detergent solution, then drop into the bowl of weak detergent solution and leave to soak for 1 or 2 hours.

### Rinsing

#### *Preferred method*

Remove the slides one by one from the weak detergent solution using forceps. If you must use your fingers, pick the slides up by their edges. Rinse each slide separately under the tap, then soak for 30 minutes in a bowl of water.

#### *Quick method*

Empty the bowl of weak detergent solution and fill with clean water. Change the water three times, shaking the bowl vigorously each time.

### Wiping, drying and wrapping up

Follow the instructions given above for new slides.

### Coverslips

Used coverslips can be cleaned and reused.

1. Make up the following solution in a large beaker:
  - 200 ml of water
  - 3 ml of detergent
  - 15 ml of bleach or 5 ml of a quaternary ammonium disinfectant (see pages 84 and 85).
2. Put the coverslips into the beaker one by one.
3. Leave the coverslips to soak for 2–3 hours, shaking gently from time to time.
4. Rinse out the beaker containing the coverslips with tap water four times, shaking gently.
5. Give a final rinse with demineralized water.
6. Drain the coverslips by tipping them out carefully on to a pad of gauze.
7. Dry in a hot-air oven at 60 °C, if possible.

Keep clean, dry coverslips in a small Petri dish. If possible, use special coverslip forceps for taking them out.

### Reusable syringes and needles

As soon as a sample has been collected, remove the plunger from the used syringe and rinse both the barrel and the plunger. Fill the barrel with water, insert the plunger and force the water through the needle. Finally remove the needle and rinse the hub cavity.

#### *Reusable syringe with blocked piston*

To loosen the piston, choose one of the following methods:

- Soak for 2 hours in hot water (about 70 °C).
- Stand the syringe on its end, piston down. Pipette 50% acetic acid solution (reagent no. 3) into the nozzle of the syringe with a fine Pasteur pipette (Fig. 3.61). Leave for 10 minutes.

After loosening the piston, soak the syringe for several hours in a bowl of 1 mmol/l hydrogen peroxide.

#### *Rinsing and soaking needles*

As soon as the needle has been used, rinse it while it is still attached to the syringe, then remove it and leave it to soak in hot water.

#### *Blocked needles*

To remove the blockage, use a nylon thread dipped in 50% acetic acid solution (reagent no. 3); alternatively, you can use a stylet.

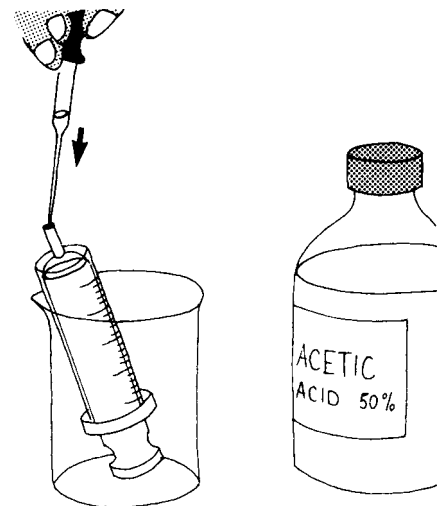

Fig. 3.61 Cleaning a blocked (reusable) syringe using acetic acid

### 3.5.2 Cleaning non-disposable specimen containers

Non-disposable containers, such as jars and bottles, may contain stools, sputum, pus, CSF, blood or urine, all of which may harbour potentially infectious organisms.

### Containers for stool specimens

If the lavatory is not connected to a septic tank, fill the jars containing stools with a 5% solution of cresol (see page 83) or a similar disinfectant. Leave for 6 hours. Empty into the lavatory.

If the lavatory is connected to a septic tank, cresol or other disinfectants should not be added to the stools before disposal. Clean the jars with detergent and water, as described on page 80.

### Sputum pots and tubes containing pus or CSF specimens

There are several possible methods.

#### *Using an autoclave*<sup>1</sup>

This is the best method.

1. Place the containers in the autoclave and sterilize for 30 minutes at 120 °C.
2. After the containers have cooled, empty the contents into the sink or lavatory.
3. Clean with detergent and water, as described on page 80.

#### *Boiling in detergent*

Keep a large pan especially for this purpose.

Boil sputum pots for 30 minutes in water containing washing powder (60 g per litre of water) (Fig. 3.62).

#### *Using formaldehyde solution or cresol*

Pour into each sputum pot either:

- 10 ml of undiluted formaldehyde, 10% solution (reagent no. 28), or
- 5 ml of 5% cresol (see page 83).

Leave for 12 hours.

#### **Urine bottles**

Empty the bottles into the lavatory.

Fill them with either:

- a 10% solution of household bleach (see page 84), or
- a 5% solution of cresol (see page 83).

Leave for 4 hours.

### Test-tubes containing blood specimens

Test-tubes of *fresh blood collected on the same day* should be:

- rinsed in cold water
- left to soak in a detergent solution (see page 80).

Test-tubes of *“old” blood kept for several days* at room temperature may contain large numbers of microorganisms. They should be:

- filled with a 10% solution of household bleach (see page 84)
- left for 12 hours and then
- rinsed and cleaned.

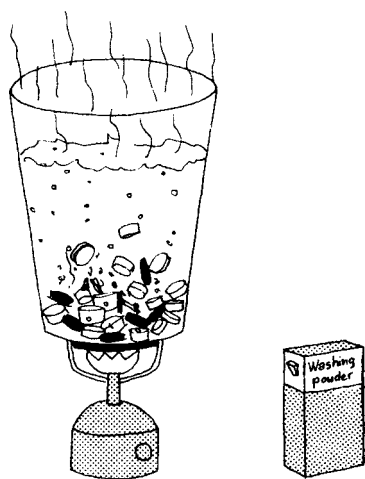

Fig. 3.62 Cleaning sputum pots by boiling in detergent

<sup>1</sup> For further information, see section 3.5.5.

### 3.5.3 Cleaning and maintenance of other laboratory equipment

#### Centrifuges<sup>1</sup>

Clean the bowl of the centrifuge daily or after any spillage occurs. Use 70% ethanol for metal bowls and 1% bleach (see page 84) for plastic ones. (Do not use bleach for metal bowls as it may cause corrosion.)

Rinse the centrifuge buckets after use and remove any traces of blood, etc.

Check the wiring for fraying and loose connections at regular intervals. If the centrifuge is sparking or running irregularly, the carbon brushes may need replacing.

Lubrication of the centrifuge should be carried out by a specialist, according to the manufacturer's instructions.

#### Water-baths

If possible fill the water-bath with distilled water or rainwater to prevent deposits forming inside. A crystal of thymol will help to prevent algal growth.

Change the water and clean the inside of the water-bath at least once a month or whenever it looks dirty. Use a thermometer to check the water temperature each time the water is changed as scale on the heating element may cause the thermostat to malfunction.

#### Incubators

Incubators are used for bacterial culture by laboratories working in microbiology. The incubator must maintain a constant average temperature of 35 °C (range 33–37 °C). The actual temperature must correspond to the thermostat setting when the instrument is used.

In carbon dioxide incubators used for microbial culture, the concentration of carbon dioxide should be maintained at 5–10% and the humidity at 50–100%.

The temperature in the incubators should be recorded daily. Like all laboratory instruments, incubators must be cleaned at regular intervals (at least every fortnight) and also after spillage of any material, whether infectious or non-infectious.

#### Westergren tubes

Rinse in water, then leave to soak in clean water for 12 hours. Dry completely (in an incubator at 37 °C, if possible). Do not use washing powder, acids or ethanol.

### 3.5.4 Disinfectants

There are many disinfectants that have various different chemical actions on infective agents. Table 3.1 lists the disinfectants that are most commonly used in health laboratories.

#### Cresols

Cresols may be solid or liquid; they are less water-soluble than phenol, but a 5% aqueous solution can be kept as a stock solution. Cresols emulsify well in soap solutions.

#### Lysol

Lysol is an emulsion of 50% cresol in an aqueous solution of soap. Cresol can be replaced by phenol, but since phenol is a less powerful disinfectant the time of

<sup>1</sup> For further information, see section 3.3.3.

**Table 3.1 Commonly used disinfectants**

Intended object of disinfection	Disinfectant	Recommended dilution for disinfection (v/v)	Minimum duration of treatment	Stock preparation of disinfectant
Blood	Cresol, 5% solution	2:1	6 h	crystals or liquid
	Calcium hypochlorite solution (1% available chlorine)	2:1	6 h	powder
Stool	Cresol, 5% solution	2:1	6 h	crystals or liquid
	Calcium or sodium hypochlorite solution (1% available chlorine)	3:1	6 h	powder
	Calcium hydroxide, 20% solution	2:1	6 h	powder
	Chloramine (4% available chlorine)	undiluted	6 h	powder
Urine	Cresol, 5% solution	1:1	4 h	crystals or liquid
Sputum	Cresol, 5% solution	1:1	4 h	crystals or liquid
Skin	Cresol, 50% solution	undiluted	2 min	50% cresol in soap solution
	Ethanol, 80% solution	undiluted	2 min	95% solution
	Iodine, 1% solution	undiluted	2 min	5% solution
	Polyvidone iodine, 1% solution	undiluted	2 min	pure
	Isopropanol, 70% solution	undiluted	2 min	pure
	<i>n</i> -Propanol, 60% solution	undiluted	2 min	pure
	Chloramine (1% available chlorine)	undiluted	2 min	powder
	Quaternary ammonium compounds	undiluted	2 min	solution
	Chloramine, 0.25% solution	undiluted	16 min	powder
Drinking-water	Cresol, 50% solution	undiluted	4 h	50% cresol in soap solution
	Cresol, 5% solution	undiluted	4 h	crystals or liquid
	Chloramine (5% available chlorine)	undiluted	4 h	powder
	Sodium hypochlorite (1% available chlorine)	undiluted	4 h	powder
Laboratory instruments <sup>a</sup>	Sodium hypochlorite (0.1% available chlorine)	undiluted	4 h	5%, 10%, 15% solution
Glassware	Sodium hypochlorite (1% available chlorine)	undiluted	12 h	5%, 10%, 15% solution

<sup>a</sup>Chemical disinfection for skin-cutting and invasive instruments should be employed only as the last resort, if neither sterilization nor high-level disinfection by boiling is possible, and then only if the appropriate concentration of the chemical is available and if the instruments have been thoroughly cleaned to remove gross contamination before soaking in the chemical disinfectant.

exposure of material to phenol solution must be longer than for cresol. Phenol and cresol solutions cause irritation of the skin and eyes.

### Sodium and calcium hypochlorite

Sodium and calcium hypochlorite solutions (household bleaches) are very strong disinfectants. They are used in a number of laboratory, household and industrial applications. Hypochlorites are rapidly inactivated by particles of dust and organic materials and must be freshly prepared from stock solutions every day. Hypochlorites cause irritation of the skin, eyes and lungs.

Strong, undiluted solutions should contain 10% available chlorine.

For preparing working dilutions, the following dilutions are recommended:

- For jars and containers in which used pipettes, slides or other glassware are discarded and for swabbing bench surfaces: 10 ml of concentrated hypochlorite solution in 990 ml of water (0.1% available chlorine). Place the used glassware into the jars of hypochlorite solution and leave for at least 12 hours. Do not overfill the containers. Change the containers daily.



- For decontamination of blood spills and other specimens with a high protein content: 40 ml of concentrated hypochlorite solution in 360 ml of water (1% available chlorine).

Strong hypochlorite solutions are corrosive and can cause burns. Handle solutions of bleach carefully: wear rubber gloves to protect the hands, and eye shields to prevent splashing in the eyes.

Calcium hypochlorite is available in its solid form as powder or granules. It decomposes at a slower rate than sodium hypochlorite. A solution of 1% available chlorine is obtained by dissolving 14 g of calcium hypochlorite in 1 litre of water.

### Chloramine

Chloramine (tosylchloramide sodium) is a crystalline powder which, like the hypochlorites, releases chlorine as the active disinfectant agent, although at a slower rate. It is also used for water disinfection: chlorinated water has a concentration of 0.05% chloramine. Note that chlorinated water can interfere with laboratory tests. Distilled water must therefore be used.

### Calcium hydroxide

Calcium hydroxide solution is prepared from quicklime (calcium oxide) powder or granules dissolved in water (1 part : 3 parts w/v). Calcium hydroxide solution is not suitable for disinfecting stools from patients with tuberculosis.

### Quaternary ammonium compounds

Quaternary ammonium compounds (QUATS) are effective against vegetative bacteria and some fungi. They are not effective against spores, viruses and mycobacteria; they are not toxic and are harmless to the skin.

### Alcohols

Alcohols (e.g. ethanol, isopropanol, *n*-propanol) are fast-acting, but relatively expensive disinfectants that are usually used for skin disinfection. They kill bacteria and some viruses, but not fungi.

### Iodine

Iodine is an excellent, fast-acting disinfectant with a wide range of action. It kills bacteria, many spores, viruses and fungi. At low temperatures iodine is more active than other disinfectants. Some people are hypersensitive to iodine and suffer a rash on areas of skin that have been exposed to iodine solution. Their sensitivity is much less when iodophores (polymer solutions that bind iodine) such as polyvidone iodine are used.

### 3.5.5 Sterilization

Sterilization is defined as the destruction of all microorganisms in or about an object. In the medical laboratory sterilization is achieved either by moist heat (autoclaving, boiling) or by dry heat (hot-air oven, flaming). Materials are sterilized for three main purposes in the medical laboratory:

- in preparation for taking specimens (needles, syringes, tubes, etc. must be sterile);
- to disinfect contaminated materials;
- to prepare the equipment used for bacteriological cultures (Petri dishes, Pasteur pipettes, tubes, etc.).

## Sterilization by steam

### Using an autoclave

Clinical samples and other contaminated waste materials are placed in a special autoclave bag or into a metal or plastic bucket for autoclaving. Use the autoclave sterilizing indicators to control the sterilizing cycle.

### Principle

Water is heated in a closed container. This produces saturated steam under pressure, with a temperature of over 100 °C. Most types of microorganism, including all bacteria (but not all viruses) are killed when apparatus is heated for 20 minutes at 120 °C in this steam under pressure.

Components of an autoclave (Fig. 3.63)

#### 1. Boiler

A large deep cylinder in which the items to be sterilized are placed.

#### 2. Basket

A big wire basket that holds the materials to be sterilized.

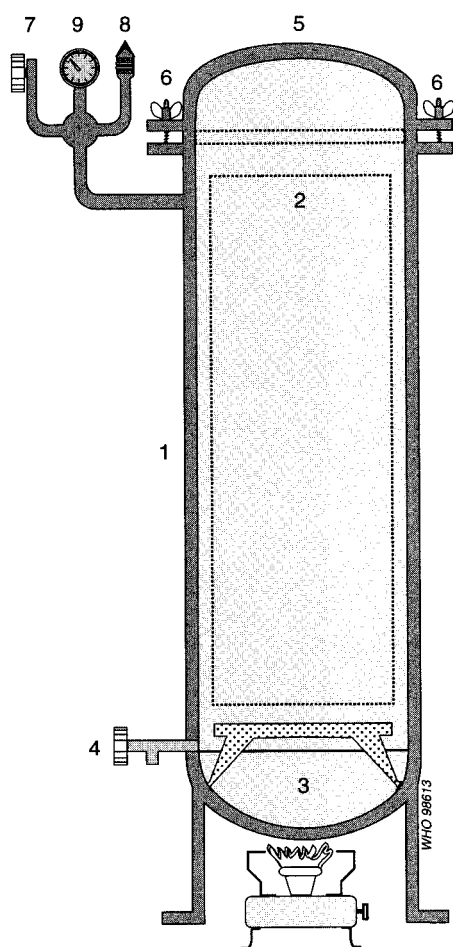

#### 3. Basket support

A support in the bottom of the autoclave that holds the basket above the water level.

#### 4. Drainage tap

A tap fitted at the base of the boiler to drain off excess water.

#### 5. Lid

The lid covers and seals the boiler and is fitted with a rubber washer.

#### 6. Lid clamps

These clamps, together with the rubber washer, seal the lid and prevent steam from escaping.

#### 7. Air outlet valve

A valve at the top of the boiler or on the lid that is used to let air out when the water is first heated.

#### 8. Safety valve

A valve at the top of the boiler or on the lid that lets steam escape if the pressure becomes too high and so prevents an explosion.

#### 9. Temperature gauge or pressure gauge

All gauges indicate the temperature in degrees Celsius (°C); some also have a second set of figures indicating the pressure.

### Heating system

The heating system may be built into the autoclave in the form of:

- electric elements
- gas burners
- a paraffin oil stove.

Fig. 3.63 Components of an autoclave  
1: boiler; 2: basket; 3: basket support; 4: drainage tap; 5: lid; 6: lid clamps; 7: air outlet valve; 8: safety valve; 9: temperature gauge or pressure gauge.

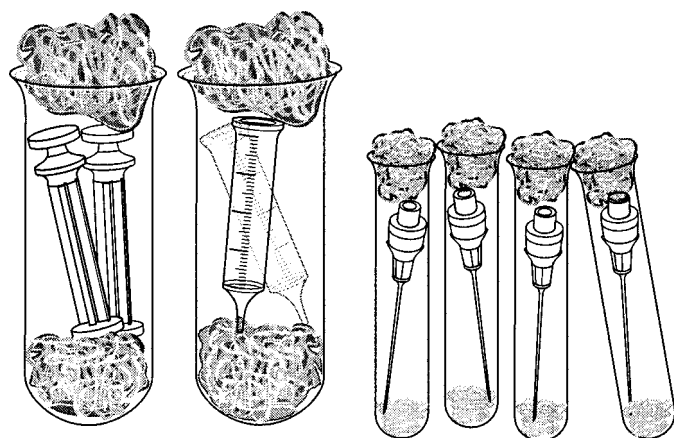

WHO 98614

Fig. 3.64 Autoclaving syringes and needles

### Installation

Autoclaves should be installed away from the main working area, as they are noisy. If gas or a paraffin oil stove is used for heating, it should be kept away from flammable materials and chemicals.

### Preparation of material for sterilization

#### *Reusable syringes*

Reusable syringes are placed in large glass test-tubes plugged with non-absorbent cotton wool (the pistons and barrels in separate tubes; Fig. 3.64), or they are wrapped in gauze and placed in metal trays.

#### *Reusable needles*

Reusable needles should be placed separately in small test-tubes that are then plugged (see Fig. 3.64). Place a pad of non-absorbent cotton wool at the bottom of each tube to protect the tip of the needle.

Otherwise, arrange the needles in metal trays with their points stuck into a folded gauze pad (Fig. 3.65).

The metal trays are placed uncovered in the autoclave.

#### *Glassware*

Specimen tubes, Petri dishes, etc. should be wrapped in autoclavable polyethylene bags and tied with string.

#### *Pasteur pipettes* (Fig. 3.66)

Pasteur pipettes should be placed in large tubes which are then plugged. Alternatively they may be placed in autoclavable polyethylene bags.

### Sterilization procedure

1. Fill the bottom of the autoclave with water (up to the basket support). Make sure that the water does not touch the basket. If necessary, drain off excess water by opening the drainage tap.
2. Put the basket containing the material to be sterilized in the autoclave together with sterilization indicator papers. The indicator papers turn black when the correct temperature is reached.

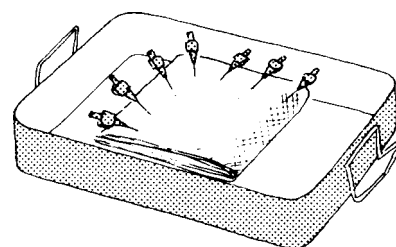

Fig. 3.65 Alternative method for autoclaving needles

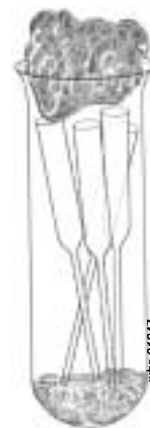

Fig. 3.66 Autoclaving Pasteur pipettes

3. Close the lid, making sure that the rubber washer is in its groove. Screw down the lid clamps evenly and firmly, but not too tightly.
4. Open the air outlet valve.
5. Begin heating the autoclave.
6. Watch the air outlet valve until a jet of steam appears. Wait 3 or 4 minutes until the jet of steam is uniform and continuous. This shows that all the air has been driven out of the autoclave.
7. Close the air outlet valve. Tighten the lid clamps and reduce the heat slightly.
8. Watch the temperature gauge. When the desired temperature is reached (i.e. 120 °C) the heat must be regulated to maintain it. Reduce the heat until the needle on the dial remains at the temperature selected. Start timing at this point.

#### *Sterilization times*

- Materials for collecting specimens (reusable syringes and needles, tubes): 20 minutes at 120 °C.
- Containers of infected material (sputum pots, tubes of pus): 30 minutes at 120 °C.
- Bacteriological culture media: follow the instructions of the bacteriologist or the chief laboratory technician.

#### Turning off the heat

1. Turn off the heat as soon as the required time is up.
2. When the temperature falls below 100 °C, open the air outlet valve to equalize the pressures inside and outside the autoclave.
3. When the hissing sound stops, unscrew the lid clamps. Take off the lid. Leave the autoclave to cool, then carefully remove the basket of sterile equipment. If drops of water have formed, dry the sterile equipment in an incubator at 37 °C, if possible.

#### Cleaning

Wipe the inside of the autoclave daily or whenever spillages occur.

#### Precautions

- Never touch the drainage tap, outlet valve or safety valve of the autoclave while heating it under pressure.
- Never heat the autoclave too quickly to bring up the pressure once the outlet valve is closed.
- Never leave the autoclave unattended while the pressure is rising.
- Never open the lid before the pressure has dropped to normal, as you may be scalded with steam.
- During sterilization make sure the lid is secured and no steam escapes as if it does, neither the pressure nor the temperature will be correct.
- Never leave the autoclave to cool for too long, because if it is left for several hours without the outflow valve being opened, a vacuum forms.

#### *Using a pressure cooker*

Pressure cookers are large saucepans designed to cook food very quickly, using steam under pressure. They are used in some small laboratories to sterilize equipment used for specimen collection.

**Pressure cooker with revolving valve**

1. Fill the bottom of the pressure cooker with water. Place the material or object to be sterilized in the basket (which is held above the water level by a support). The wrapped articles should be placed upright (never lay them flat; Fig. 3.67).
2. Fit on the lid. Screw it down with its knob. Place the revolving valve ( $V_1$ ) on its shaft in the lid (Fig. 3.68).
3. Start heating the pressure cooker on the stove. The valve soon begins to turn, letting a jet of steam escape.
4. Wait until the jet of steam is continuous, then lower the heat so that the valve keeps turning slowly. Leave the pressure cooker on moderate heat for 20 minutes.
5. Turn off the heat. Leave the pressure cooker to cool (or cool it in cold water).
6. Pull off the revolving valve so that air can enter. Remove the lid. Take out the sterilized material or object and leave the pressure cooker to dry.

*Warning:* Never touch the safety valve ( $V_2$  in Fig. 3.68), which is fixed to the lid.

**Pressure cooker with fixed valve**

1. Put the water and material or object to be sterilized in the pressure cooker as described above.
2. Open the valve in the lid. Start heating the pressure cooker.
3. As soon as a continuous jet of steam escapes from the valve, close the valve.
4. Wait until the valve begins to whistle. When it does, reduce the heat. Leave the pressure cooker on moderate heat for 20 minutes.
5. Turn off the heat. Leave the pressure cooker to cool (or cool it in cold water).
6. Open the valve so that air can enter. Remove the lid. Take out the sterilized material or object and leave the pressure cooker to dry.

*Warning:* Never touch the safety valve.

**Sterilization by boiling**

This method should be used only where there is no alternative. Use a special boiling pan or, if not available, a saucepan. Fill the pan with water (preferably demineralized) and heat over the stove. Glassware (reusable syringes) should be put in while the water is still cold. Metal articles (reusable needles, forceps) should be put in when the water is boiling. Leave the articles to boil for 30 minutes.

**Sterilization by dry heat***Using a hot-air oven*

This method should be used only for glass or metal articles (reusable syringes and needles, pipettes, etc.) when an autoclave is not available. It must not be used for culture media used in microbiology, which should be autoclaved (see page 86).

1. Prepare the object to be sterilized in the same way as for the autoclave method. Cotton-wool plugs should not be too thick, otherwise the hot air cannot penetrate. Raise the lids of the metal boxes slightly and arrange them so that they face the back of the oven.
2. Set the thermostat to 175 °C and switch on the oven. If there is a fan, check that it is working.
3. Watch the thermometer. When the temperature reaches 175 °C, continue heating at this temperature for a further 60 minutes. If the object to be sterilized is heavy or bulky or if it includes powders, oils or petroleum jelly, heat at 175 °C for 2 hours.

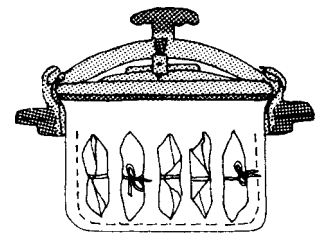

Fig. 3.67 Sterilizing equipment using a pressure cooker

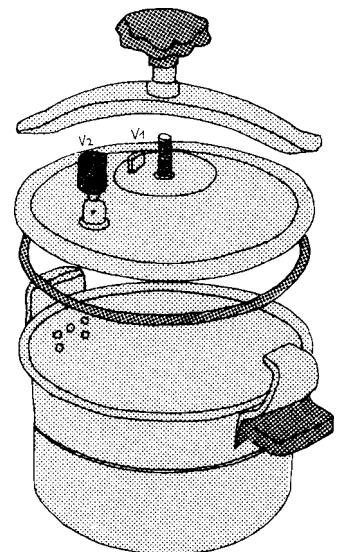

Fig. 3.68 Components of a pressure cooker

4. Switch off the heat. Wait until the temperature falls to 40°C. Open the oven door. Close the lids of the metal boxes. Remove the sterile object.

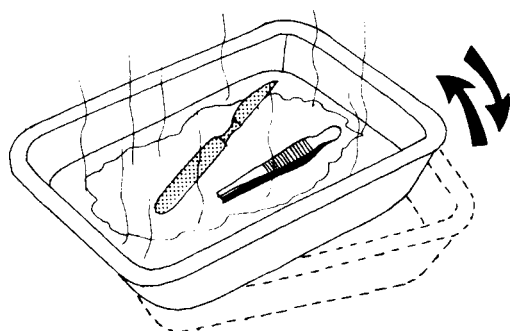

Fig. 3.69 Sterilization by flaming

#### **By flaming**

This method should be used only for metal articles such as forceps and scalpels. It is not suitable for general use.

1. Place the articles in a metal tray.
2. Add about 10 drops of ethanol and ignite.
3. During flaming tilt the tray first one way, then the other (Fig. 3.69).

To sterilize bacteriological loops, heat them in the flame of a gas burner or spirit lamp until they are red hot.

### **3.6 Disposal of laboratory waste**

#### **3.6.1 Disposal of specimens and contaminated material**

Any clinical material brought into the laboratory and any apparatus used to handle this material must be considered as infectious. To avoid laboratory accidents, make sure that priority is given to correct handling and disposal of specimens and contaminated material (see section 3.8).

#### **3.6.2 Incineration of disposable materials**

##### **Making an incinerator (Fig. 3.70)**

An old metal drum is suitable for this purpose.

1. Fix a strong metal grating (G) firmly about one-third of the way up the drum.
2. Cut a wide opening or vent (V) below the level of the grating.
3. Find a removable lid (L) for the drum.

##### **Using an incinerator**

- At the end of each morning's and each afternoon's work, place all used stool and sputum boxes on the grating of the incinerator (Fig. 3.71).

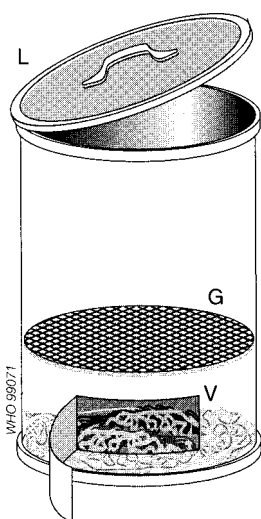

Fig. 3.70 Components of an incinerator  
G: metal grating; L: lid; V: vent.

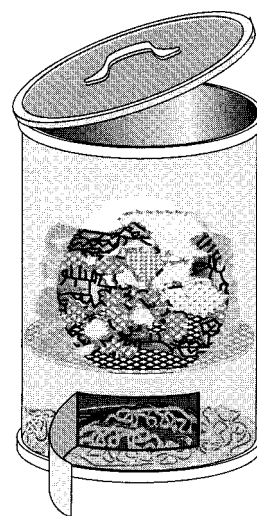

Fig. 3.71 Using an incinerator

- Always keep the metal drum tightly closed (both lid and vent), except during incineration.
- Incinerate once a week, or more often if necessary. Fill the bottom of the drum with paper, sticks, wood shavings, etc.
- Remove the lid. Light the fire and keep it burning until all the infected material has been reduced to ashes.
- The ash produced is not dangerous and can be thrown on the refuse heap.

### 3.6.3 Burial of disposable materials

Dig a pit 4–5 metres deep and 1–2 metres wide at a location where neither groundwater nor surface water can enter and where leaching of waste liquids into the groundwater cannot occur (Fig. 3.72). A pit must never be constructed near a water source.

Make a lid that fits tightly over the pit. It is advisable to strengthen the upper rim of the pit by lining it with bricks or stones.

- The pit must be protected from animals, birds and humans.
- Throw stool or sputum boxes and other infected material into the pit twice a day. Replace the lid immediately.
- Once a week, cover the refuse with a layer (about 10 cm thick) of dried leaves.
- If possible, instead of using dry leaves add a layer of quicklime (calcium oxide) once a week.

## 3.7 Dispatch of specimens to a reference laboratory

The peripheral laboratory sends specimens to reference laboratories or more specialized laboratories for examinations that cannot be carried out locally. For example, serological examinations for treponemal infection or typhoid; culture of stools for detection of cholera vibrio; and histological examination of biopsy material.

Table 3.2 shows, for each type of specimen and each examination:

- which container and preservative (where necessary) to use;
- how much of the specimen to send;
- how long the specimen will keep.

### 3.7.1 Packing specimens for dispatch

Always observe the regulations in force in your country.

Double pack specimens. Place the specimen in the bottle or tube and seal hermetically (fixing the stopper with sticking-plaster; see Fig. 3.73).

Check that the bottle is labelled with the patient's name and the date of collection of the specimen. Then place the sealed bottle in an aluminium tube with a screw cap. Wedge it in the tube with absorbent cotton wool.

Wrap the request form around the metal tube (Fig. 3.74).

It should show:

- the patient's name (written in capital letters) and date of birth;
- the nature of the specimen;
- the date of collection of the specimen;

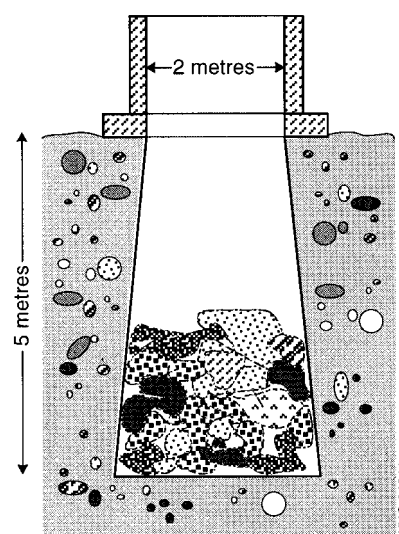

Fig. 3.72 Disposal of materials by burying

**Table 3.2 Dispatch of specimens to a reference laboratory**

Type of specimen	Type of laboratory examination	Container and preservative	Amount of specimen to send	Preservation time
Sputum	Culture of tubercle bacilli (see section 5.4)	45-ml bottle containing 25 ml of cetylpyridinium bromide, 0.6% solution	—	10 days
	Culture of other organisms	No preservative	—	2 hours
Throat swabs	Culture of diphtheria bacilli (see section 5.4)	Tube containing coagulated serum	—	24 hours
		Cotton-wool swab	—	4 hours
CSF (see section 8)	Culture of meningococcus	Special bottle containing Stuart transport medium, modified (reagent no. 56) (see section 8.4.2)	—	24–48 hours
		Sterile airtight bottle sent in a vacuum flask filled with water at 37 °C	2 ml	12 hours
	Culture of other organisms	Sterile bottle	2 ml	2 hours
	Chemical tests (for glucose, protein, chloride, etc.; see sections 8.3.4 and 8.3.5)	Sterile bottle	2–4 ml	2 hours
Urethral pus	Culture of gonococcus (see section 5.5)	Special bottle of Stuart transport medium, modified (reagent no. 56)	Swab of pus	24 hours
Pus from other sources	Bacteriological culture (see section 5)	Sterile tube	1 ml	2 hours
Blood (see sections 9–11)	Erythrocyte and leukocyte cell counts (see sections 9.5 and 9.6)	EDTA dipotassium salt, 10% solution (reagent no. 22)	5 ml	12 hours
	Serological tests for syphilis (see section 11.10)	Sterile tube without anticoagulant; send serum or dried drops of blood as appropriate	10 ml	3 days
	Serological tests for HIV and hepatitis B virus (see sections 11.7 and 11.8)	Send successive specimens of serum: <ul style="list-style-type: none"> <li>● taken at the onset of the disease</li> <li>● taken after 2–4 weeks (to detect increase in antibodies)</li> </ul>	5 ml	24 hours
	Tests for glucose (see section 10.1)	5 mg of sodium fluoride	5 ml	2 hours
	Other biochemical tests: <ul style="list-style-type: none"> <li>● bilirubin</li> <li>● cholesterol</li> <li>● serum iron</li> <li>● serum lipids</li> <li>● proteins</li> <li>● liver function</li> <li>● uraemia</li> </ul>	Bottle without anticoagulant (send serum)	10 ml	48 hours
	Enzyme estimations: <ul style="list-style-type: none"> <li>● amylase phosphatase</li> <li>● transaminases</li> </ul>	Bottle without anticoagulant	5 ml	2 hours
	Culture	Special sterile flask containing 50 ml of broth raised to 37 °C as quickly as possible after adding the specimen	5 ml	24 hours
Stools	Culture of all organisms, including <i>Vibrio cholerae</i> (see section 5.9)	Cary–Blair transport medium (reagent no. 17)	—	4 weeks
	Culture of all organisms, except <i>Vibrio cholerae</i>	Buffered glycerol saline (reagent no. 14)	—	2 weeks
	Examination for parasite ova, larvae and cysts (see section 4.2.4)	30-ml bottles containing 15 ml of formaldehyde, 10% solution (reagent no. 28)	about 5 ml	Keeps almost indefinitely
	Examination for vegetative forms of amoebae (see section 4.2.4)	10-ml tube containing thiomersal–iodine–formaldehyde (TIF) fixative (reagent no. 58) or polyvinyl alcohol (reagent no. 44)	—	Keeps almost indefinitely



Table 3.2 (cont.)

Type of specimen	Type of laboratory examination	Container and preservative	Amount of specimen to send	Preservation time
Urine (see section 7)	Biochemical tests (for glucose, protein, acetone, etc.; see sections 7.2.4–7.2.6)	Clean dry bottle (sealed)	20–50 ml, depending on number of tests to be performed	2 hours
	Urinary deposit (see section 7.2.7)	Clean dry bottle	30 ml	2 hours
		Bottle containing 8 drops of formaldehyde, 10% solution (reagent no. 28)	30 ml	2 days
	Schistosome eggs (see section 7.2.8)	For concentration: 2 ml of household bleach and 1 ml of hydrochloric acid	100 ml	Keeps almost indefinitely
	Bacteriological culture (see section 5)	Sterile bottle	20 ml	1 hour
Pregnancy test (see section 11.5)	Sterile bottle	20 ml (first urine of day)	12–24 hours (or 4 days in refrigerator)	
Biopsy tissue (from an organ)	Histological examination (see section 3.7.2)	The following fixatives are used: ● formaldehyde saline (reagent no. 27) ● Zenker fixative (reagent no. 66)	—	—
Hair, nails, cutaneous tissue	Examination for fungi (mycoses) (see sections 6.1 and 6.3)	Paper envelope or screw-capped bottle (do not use tubes with rubber stoppers or plugged with cotton-wool)	—	At least a week (sometimes longer)

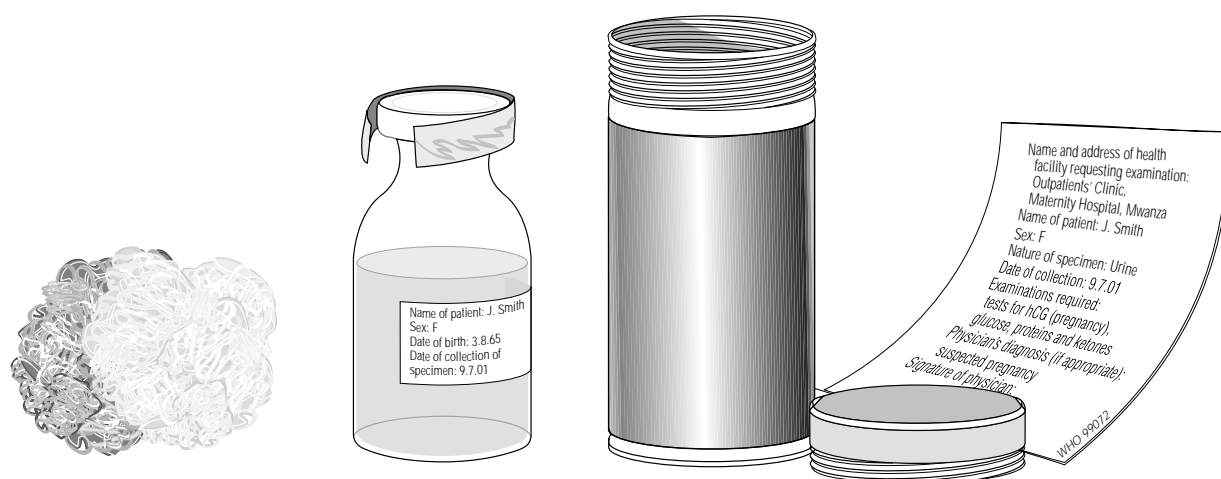

Fig. 3.73 Packing specimens for transport

- the address of the health facility where the specimen was collected;
- the examinations required (with the physician's diagnosis, where appropriate).

It should also be signed by the physician.

Place the metal tube in a strong cardboard or wooden box for dispatch. Wedge the tube in tightly with non-absorbent cotton wool. Label the outside of the box: URGENT, FRAGILE and, if appropriate, INFECTIOUS MATERIAL (Fig. 3.75).

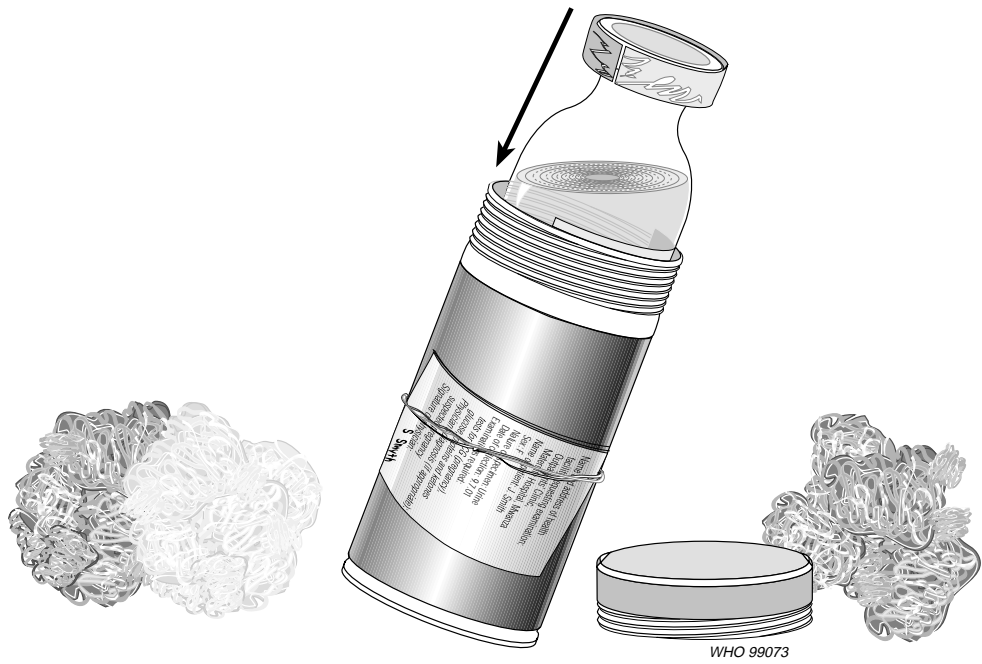

Fig. 3.74 Wrap the request form around the metal tube containing the specimen

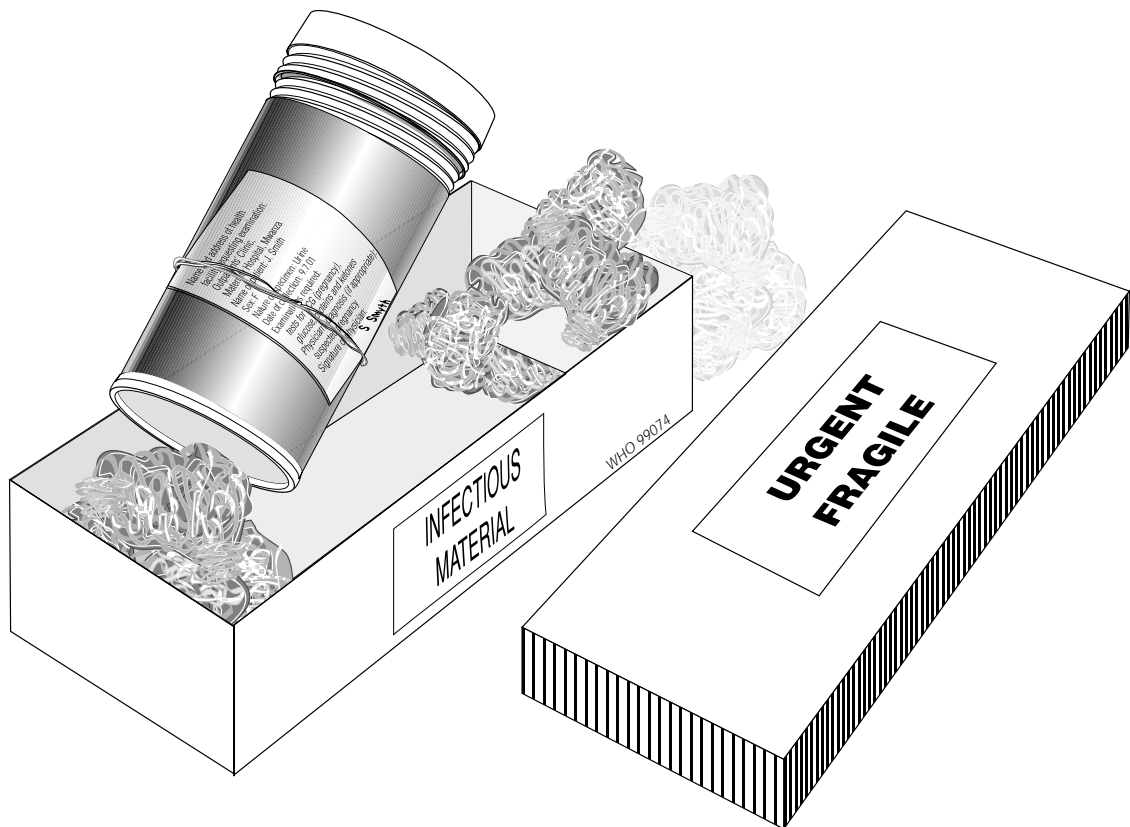

Fig. 3.75 Label the box containing the specimen

### 3.7.2 Fixation and dispatch of biopsy specimens for histopathological examination

#### *Biopsy specimens*

To diagnose certain diseases of the organs, the physician removes a piece of tissue with forceps or a special scalpel. This piece of tissue is called a *biopsy specimen*. It is examined under the microscope after a thin section has been cut and treated with a special stain.

#### *Histopathology*

The cells of biopsy specimens from tissues and organs can be studied under the microscope. This type of examination is called *histopathology* and can be most important, particularly for the diagnosis of cancer.

The laboratory technician must be able to fix the biopsy specimen and to ensure that it is properly dispatched and arrives at the pathology laboratory in a good state of preservation.

#### **Fixation of biopsy specimens**

The piece of tissue is immersed in a fixative fluid. This procedure should preserve the tissue in a state as close to the living state as possible, by protecting it against bacterial action, autolysis, shrinkage, etc.

The most suitable type of bottle for biopsy specimens is a plastic-capped bottle with a wide mouth (pill bottle). Such bottles are obtainable in 60-ml, 45-ml, 30-ml and 15-ml sizes.

#### *Fixatives*

Fixatives that are simple to prepare are:

- formaldehyde saline (reagent no. 27);
- Zenker fixative (reagent no. 66). Just before use, add 5 ml of glacial acetic acid per 100 ml of Zenker solution.

#### *Technique*

Amount of fixative

The volume of fixative required is about 50 times the volume of the biopsy tissue. Biopsy tissue is normally 3–5 mm thick (if it is thicker, fixation is difficult or impossible).

The area of the specimen, however, can vary and this is what determines the amount of fixative to be used (see Table 3.3).

**Table 3.3 Calculating the amount of fixative to use for biopsy material**

Dimensions of specimen (cm)	Amount of fixative (ml)
0.5 × 0.5	6–10
0.5 × 1	10–15
1 × 1	20–25
2 × 1	30–40
2 × 2	90

#### Preparation

It is essential to act quickly on receipt of a biopsy specimen. Never leave it until later. First pour the fixative into the bottle. Then pick up the biopsy specimen on a piece of stiff paper (do not use forceps, which may damage the tissue).

Drop the specimen into the bottle.

#### Labelling

Cut out a small rectangle (about 3 cm × 1 cm) of stiff paper. Using a lead pencil, write on it the name of the patient, the nature of the specimen and the date of collection. Place the slip of paper in the bottle with the fixative.

#### Fixation time

This will vary according to the fixative used. With the two fixatives mentioned above, the specimen can be left in the liquid for at least a week before it is cut and stained. Fixed material should be dispatched to the pathology laboratory without delay, but a long transit period will not result in the deterioration of specimens.

#### Dispatch of biopsy specimens

Secure the cap or stopper of the bottle with adhesive plaster. Place the bottle in an aluminium tube with a screw cap, together with the request form (see section 3.7.1). Then place the tube and the request form in a small wooden or cardboard box and dispatch immediately.

### 3.8 Safety in the laboratory

- Each laboratory should have a written manual of safe laboratory practices which should be followed at all times.
- The laboratory should have a first-aid box (see section 3.8.2) and at least one staff member trained in first aid.
- The laboratory should be a work area only; visitors should be restricted.
- No food or drink should be consumed in the laboratory.
- Wear protective clothing and remove it before leaving the laboratory.
- Always consider any laboratory specimen as potentially infectious and handle it carefully; wear protective gloves.
- Place all specimens safely on a bench or in a rack to prevent spillage or breakage.
- Take great care when collecting and processing blood samples as they may harbour infective agents (e.g. hepatitis B virus, parasites, etc.).
- Do not contaminate yourself or the work areas with any specimen.
- Do not pipette blood or other body fluids or any reagents by mouth.
- Cover all cuts with an impervious dressing (plaster).
- Dispose of used needles and lancets safely in a “sharps” container. (Sharps containers can be made from plastic bottles with a screw top in which a hole is made.) Once filled, containers should be autoclaved or soaked in disinfectant before burning or burying in a deep pit (see sections 3.6.2 and 3.6.3).
- Cover any spilled material or broken culture tubes with a cloth soaked in disinfectant (see section 3.5.4) and leave for 30 min. Then use a stiff brush or sheet of cardboard to sweep it into a disposable specimen container.
- At the end of the day swab the benches with a cloth soaked in disinfectant (see section 3.5.4).

- Wash your hands well after handling infective material and before leaving the laboratory.

Specimens may be disposed of:

- in cardboard cartons or plastic pots that can be destroyed (stools, sputum);
- in glass jars and bottles that can be cleaned, sterilized and used again (see sections 3.5.1, 3.5.2 and 3.5.5).

Disposable containers must not be reused.

### 3.8.1 Precautions to prevent accidents

#### Handling acids and alkalis

##### *Diluting concentrated sulfuric acid with water*

Always add the concentrated sulfuric acid to the water drop by drop, stirring the mixture after each drop. Do this in a sink whenever possible. *Never pour the water into the sulfuric acid* because of the danger of splashing due to the explosive evaporation of water while mixing.

##### *Bottles of acids and alkalis*

Keep bottles of acids and alkalis on the lower shelves of the cupboards. When you take a bottle out make sure your hand is dry and hold the bottle firmly upright. Do not keep acids and alkalis in bottles with ground glass stoppers (they may get stuck).

##### *Pipetting*

Use small measuring cylinders for measuring acids and alkalis. If more accurate measurement is required, use a pipette with a rubber safety bulb attached. Pipette slowly, watching the level of the liquid.

#### Heating glassware and liquids

##### *Test-tubes*

Never heat the bottom of a test-tube; the liquid inside might sputter. Heat the middle of the tube, shaking gently. The mouth of the tube should be facing away from you and any other person, towards an empty work space or a sink.

##### *Heat-resistant glass*

Only heat-resistant glassware and porcelain receptacles can be heated over a Bunsen flame. Ordinary glass will break.

##### *Flammable liquids*

Only small quantities of flammable liquids such as ether, ethanol, acetone, benzene and toluene should be kept in the laboratory.

*Warning:* Ether will ignite at a distance of several metres from a flame. Never place a bottle of ether on a workbench where there is an open flame.

##### *Propane and butane gas burners*

When lighting a gas burner, always light the match and hold it to the burner before turning on the gas tap. Turn off the main valves of all bottles of butane gas every evening. Replace the rubber connecting pipes once a year.

### 3.8.2 First aid in laboratory accidents

Accidents in the medical laboratory may have various causes:

- Acids or alkalis: splashes on the skin or in the eyes, swallowing.
- Toxic substances.
- Heat: naked flames, hot liquids, flammable liquids, explosions.
- Injuries involving infectious material, electric shocks, etc.

#### First-aid equipment

- First-aid box (see below)
- Sodium carbonate, 5% solution (reagent no. 52)
- Sodium bicarbonate, 2% solution (reagent no. 50) (in an eyedrop bottle)
- Boric acid, saturated solution (reagent no. 12) (in an eyedrop bottle)
- Acetic acid, 5% solution (reagent no. 1)
- Cotton wool and gauze
- Mercurochrome and tincture of iodine.

The above items should be readily available in the laboratory. They must not be kept in a locked cupboard. The solutions should be kept in plastic bottles.

#### *First-aid box*

The first-aid box should contain the following:

- An instruction sheet giving general guidance
- Individually wrapped sterile adhesive dressings in a variety of sizes
- Sterile eye-pads with bandages for attachment
- Triangular bandages
- Sterile dressings for serious wounds
- A selection of sterile unmedicated dressings for minor wounds
- Safety-pins
- A bottle containing eye drops
- A first-aid manual.

The contents of the first-aid box should be replenished immediately after use and inspected regularly to ensure that they remain in satisfactory condition.

#### **Corrosive injuries from acids**

Acids such as nitric acid, sulfuric acid, chromic acid, hydrochloric acid, acetic acid and trichloroacetic acid can cause corrosive injuries. It is therefore essential to take immediate action in the event of an accident.

*In all cases:* Wash the affected area immediately with large quantities of water.

#### *Acid splashes on the skin*

- Wash the affected area thoroughly and repeatedly with large quantities of water.
- Bathe the affected skin with cotton wool soaked in a 5% solution of sodium carbonate.

### Acid splashes in the eye

- Wash the eye immediately with large quantities of water sprayed from a polyethylene bottle (or rubber bulb) for 15 min (Fig. 3.76); squirt the water into the corner of the eye near the nose. Alternatively, wash the eye with running water from a tap (Fig. 3.77). Ask the patient to close the eye that is not affected.
- After washing, put 4 drops of a 2% solution of sodium bicarbonate into the eye.
- Send for a physician. Continue to apply bicarbonate solution to the eye until the physician arrives.

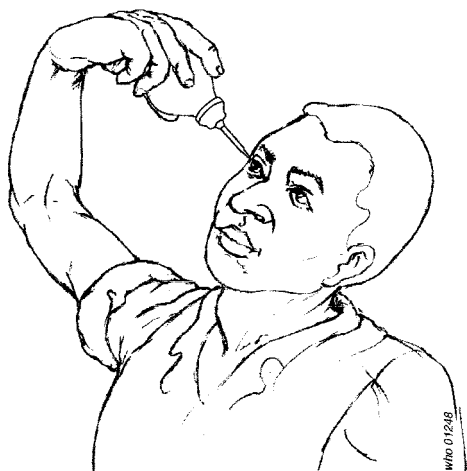

Fig. 3.76 Rinsing the eye using a polyethylene bottle

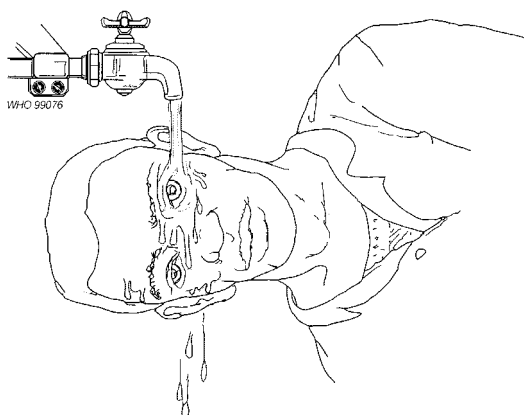

Fig. 3.77 Rinsing the eye under the tap

### Swallowing acids

If acid is accidentally swallowed:

- Send for a physician.
- Make the patient drink some milk immediately (alternatively, two egg whites mixed with 500ml of water may be given). If neither of these is available, the patient should drink ordinary water.
- Make the patient gargle with the milk.
- Give the patient three or four glasses of ordinary water.
- If the lips and tongue are burned by the acid:
  - rinse thoroughly with water, then
  - bathe with a 2% solution of sodium bicarbonate.

*Note:* Always pipette acids using a rubber safety bulb, *never* by mouth.

### Corrosive injuries from alkalis

Alkalis such as sodium hydroxide, potassium hydroxide and ammonium hydroxide can also cause corrosive injuries. Such injuries may be more serious than those caused by acids.

*In all cases:* Wash the affected area immediately with large quantities of water.

***Alkali splashes on the skin***

- Wash the affected area thoroughly and repeatedly with water.
- Bathe the affected skin with cotton wool soaked in a 5% solution of acetic acid (or undiluted vinegar or lemon juice).

***Alkali splashes in the eye***

- Wash the eye immediately with large quantities of water sprayed from a polyethylene bottle (or rubber bulb); squirt the water into the corner of the eye near the nose (see Fig. 3.76). Alternatively, wash the eye with running water from a tap (see Fig. 3.77).
- After washing the eye with water, bathe it with a saturated solution of boric acid.
- Send for a physician. Continue to apply boric acid solution to the eye until the physician arrives.

***Swallowing alkalis***

If alkali is accidentally swallowed:

- Send for a physician.
- Immediately make the patient drink a 5% solution of acetic acid (or lemon juice or vinegar diluted 1 part vinegar to 3 parts water).
- Make the patient gargle with the same acid solution.
- Give the patient three or four glasses of ordinary water.
- If the lips and tongue are burned by the alkali:
  - rinse thoroughly with water, then
  - bathe with a 5% solution of acetic acid.

**Poisoning**

This can be caused by:

- inhaling toxic vapours or gases (e.g. chloroform)
- accidental swallowing of a poisonous solution.

*In all cases:*

- Send for a physician or qualified nurse, specifying the toxic substance involved.
- Place the victim in the open air while waiting for the physician or nurse.

**Burns caused by heat**

These fall into two categories:

- *Severe burns* (e.g. burns caused when burning ether or boiling water is spilled over the victim).
- *Minor burns* (e.g. burns caused by hot glassware or a Bunsen flame).

***Severe burns***

- If the victim is on fire (e.g. splashed with burning ether or other flammable solvents), roll him or her in a blanket to extinguish the flames.
- Inform the physician on duty at the casualty department immediately, specifying that a patient with severe burns will have to be moved.
- Lay the victim on the ground. Do not remove any clothing. Cover the patient if he or she is cold.
- Do not apply any treatment to the burns: this must be left to the physician.



### **Minor burns**

- Plunge the affected part into cold water or a mixture of ice and water to soothe the pain.
- Apply mercurochrome or tincture of iodine to the burn.
- Apply a dry gauze dressing loosely.
- If the burn becomes infected or does not heal, refer the patient to a physician.

*Note:* Never tear off blisters that form over burns!

### **Injuries caused by broken glass**

#### **Clean glass**

- Disinfect the skin in the normal way (using, for example, mercurochrome or tincture of iodine).
- If the cut is minor, cover it with a sterile adhesive dressing (ready-made type).
- If the cut bleeds profusely, stop the bleeding by pressing down on it with a sterile compress. Refer the patient to the casualty department.
- If the cut bleeds heavily with the blood spurting out at intervals, try to stop the bleeding by pressing down on it with a sterile compress and send for a physician or qualified nurse.
- Continue to press on the covered wound while waiting for the physician or nurse. (He or she will decide whether a tourniquet should be applied.)

#### **Glass containing infected material**

Glassware containing stools, pus, bacterial cultures, etc.:

- Check whether the cut is bleeding; if not, squeeze hard to make it bleed for several minutes.
- Bathe the whole area (the edges of the cut and inside the cut) with tincture of iodine or a surgical antiseptic (see Table 3.1, page 84).
- Wash the whole area thoroughly with soapy water.
- Bathe the area again with tincture of iodine.
- Refer the victim to the physician if the material involved is known to be infective (e.g. bacterial cultures, pus).

### **Electric shocks**

Alternating electric current (120 V or 220 V) is usually used in the laboratory. Electric shocks may occur when faulty equipment is being handled, particularly with wet hands. The symptoms are fainting, asphyxia and cardiac arrest.

- *Before doing anything else*, cut off the electricity at the main fuse.
- Send for a physician.
- In case of a cardiac arrest, massage the heart externally if necessary and begin giving artificial respiration.

## **3.9 Quality assurance in the laboratory**

Quality assurance in the laboratory includes all aspects of the analytical work, from correct identification and preparation of the patient to ensuring that the laboratory result goes back to the doctor.

The prime objective of quality assurance is to ensure that the laboratory provides results that are correct and relevant to the clinical situation of the patient.

The stages at which quality assurance should be applied include:

- preparing the patient
- collecting the specimen
- handling and dispatch of the specimen (see sections 2.6.1 and 3.7)
- control of methods and reagents (see individual methods)
- calibration of equipment (see section 2.5)
- reporting results (see section 2.6.2).

### 3.9.1 Specimen collection

The appropriate collection of specimens is of utmost importance if the laboratory results are to be relevant to the clinical situation of a patient. When material is collected for the purpose of monitoring and control of treatment of patients, the following factors should be considered:

- the physiological state of the patient (e.g. the reference ranges of certain indicators vary with age and sex);
- the appropriate preparation of patients for specimen collection (e.g. blood for the measurement of glucose and lipids should be taken in the morning from a patient who has fasted for 12 hours, because their concentrations are elevated after a meal);
- the appropriate tools for specimen collection (e.g. blood for cell counting should be collected in tubes containing EDTA dipotassium salt to avoid plasma coagulation and platelet aggregation);
- the appropriate site for specimen collection (e.g. the concentration of glucose is different in arterial and venous blood).

Specific aspects of specimen collection, including those for the detection of infective organisms (bacteria and parasites), are outlined in the relevant sections of this manual.

To ensure that the most useful specimen is obtained, it should always be collected at the appropriate time. Random collection should be limited to emergency situations. For example, sputum specimens for the detection of tubercle bacilli should be collected in the early morning, while urine for the diagnosis of schistosomiasis and other conditions should be collected as a “terminal” urine specimen (see section 7.2.8).

# Part II





---

## 4. Parasitology



### 4.1 Introduction

A parasite is an organism that lives in or on another living organism of a different species. The organism from which the parasite takes its food is called the host. A parasite such as a tick that lives *on* its host is called an *ectoparasite*. A parasite that lives *in* its host, such as a hookworm or an amoeba, is called an *endoparasite*.

Many diseases are caused by infection with parasites. They are an important cause of diarrhoea (see Table 4.1), which is a major health problem in developing countries.

If acute diarrhoea is caused by parasitic infection, this can be determined by examination of a stool specimen.

**Table 4.1 Common causes of diarrhoeal disease**

Type of cause	Specific cause
<b>Infectious</b>	
Protozoa	Amoebae <i>Giardia</i> spp. <i>Balantidium coli</i> <i>Isoospora belli</i> <i>Cryptosporidium</i> spp. <i>Plasmodium</i> spp.
Bacteria	<i>Salmonella</i> spp. <i>Shigella</i> spp. <i>Escherichia coli</i> <i>Vibrio cholerae</i> <i>Staphylococcus</i> spp. <i>Campylobacter</i> spp.
Viruses	Rotaviruses
Helminths	<i>Fasciolopsis</i> spp. <i>Strongyloides stercoralis</i> <i>Trichuris trichiura</i> <i>Hymenolepis nana</i> <i>Heterophyes heterophyes</i>
<b>Non-infectious</b>	
Malabsorption syndromes	Tropical sprue Crohn disease Whipple disease
Intoxications	Food poisoning Chemicals Drugs
Inborn errors of metabolism	Carbohydrate intolerance Gluten enteropathy
Metabolic disorders	Adrenal disease

It is useful for laboratory technicians to understand the ways in which people can become infected by intestinal parasites (see Table 4.2). They can then give advice on hygiene to members of the community and avoid infection themselves, particularly in the laboratory.

**Table 4.2 Routes of transmission of intestinal parasites**

Scientific name	Common name	How infection is contracted
<b>Helminths</b>		
<i>Ancylostoma duodenale</i>	Hookworm	Walking barefoot on ground contaminated by stools; playing on contaminated ground (children)
<i>Ascaris lumbricoides</i>	Roundworm, ascaris	Eating unwashed raw vegetables and salads; playing on ground contaminated by stools (children)
<i>Clonorchis sinensis</i>	Chinese liver fluke	Eating undercooked infected meat
<i>Dicrocoelium dendriticum</i> , <i>D. hospes</i>	Lancet fluke	Swallowing infected ants (in unwashed salad or while playing in grass (children))
<i>Diphyllobothrium latum</i>	Fish tapeworm	Eating raw or undercooked freshwater fish
<i>Dipylidium caninum</i>	Dog tapeworm	Swallowing dog fleas (children)
<i>Enterobius vermicularis</i>	Pinworm, threadworm	Walking barefoot on ground contaminated by stools; autoinfection; contact with infected persons with dirty hands; failure to observe safety regulations relating to cleanliness in the laboratory
<i>Fasciola gigantica</i>	Giant liver fluke	Eating unwashed salads
<i>Fasciola hepatica</i>	Liver fluke	Eating unwashed salads
<i>Fasciolopsis buski</i>	Giant intestinal fluke	Eating unwashed salads
<i>Heterophyes heterophyes</i>	Dwarf fluke	Eating undercooked infected meat
<i>Hymenolepis diminuta</i>	Rat tapeworm	Swallowing rat fleas
<i>Hymenolepis nana</i>	Dwarf tapeworm	Eating contaminated vegetables; autoinfection
<i>Metagonimus yokogawai</i>	Japanese fluke	Eating undercooked infected meat
<i>Necator americanus</i>	Hookworm	Walking barefoot on ground contaminated by stools; playing on contaminated ground (children)
<i>Paragonimus westermani</i>	Oriental lung fluke	Eating undercooked infected freshwater crabs
<i>Schistosoma haematobium</i>	Schistosome (vesical)	Bathing in streams or ponds contaminated by infected stools or urine
<i>Schistosoma intercalatum</i>	Schistosome (rectal)	Bathing in streams or ponds contaminated by infected stools or urine
<i>Schistosoma japonicum</i>	Schistosome (Asiatic or Oriental)	Bathing in streams or ponds contaminated by infected stools or urine
<i>Schistosoma mansoni</i>	Schistosome (intestinal)	Bathing in streams or ponds contaminated by infected stools or urine
<i>Taenia saginata</i>	Beef tapeworm	Eating undercooked infected meat
<i>Taenia solium</i> :	Pork tapeworm	
— adults		Eating undercooked infected meat
— larval form (cysticercus)		Eating unwashed raw vegetables; autoinfection
<i>Trichostrongylus</i> spp.	—	Eating unwashed salads (Asia)
<i>Trichuris trichiura</i>	Whipworm	Eating unwashed raw vegetables and salads
<b>Protozoa</b>		
<i>Balantidium coli</i>	—	Eating unwashed vegetables; contact with infected pigs (on farms)
<i>Entamoeba histolytica</i>	—	Drinking contaminated water; eating unwashed raw vegetables and salads; contact with infected persons with dirty hands; failure to observe safety regulations relating to cleanliness in the laboratory
<i>Giardia intestinalis</i>	—	Drinking contaminated water; eating unwashed raw vegetables and salads; contact with infected persons with dirty hands; failure to observe safety regulations relating to cleanliness in the laboratory

## 4.2 Examination of stool specimens for parasites

### 4.2.1 Collection of specimens

Collect approximately 100 g of faeces in a clean, dry container without preservatives. A screw-top container is most suitable (see section 2.5.5). Make sure that any adult worms or segments passed are included.

For collection of stool specimens for bacteriological examination (e.g. for culture of cholera and other bacteria that cause dysentery), see section 5.9.4.

#### Precautions

- Never leave stool specimens exposed to the air in containers without lids.
- Never accept stool specimens mixed with urine (e.g. in a bedpan).
- Never examine stool specimens without first putting on gloves.
- Always examine stool specimens within 1–4 hours after collection. If several specimens are received at the same time, examine the liquid stools and those containing mucus or blood first, as they may contain motile amoebae (which die quickly).

### 4.2.2 Visual examination

Faecal samples are best described by their colour, consistency and presence or absence of macroscopic blood or exudate.

#### Colour

The colour can be described as:

- black (occult blood)
- brown, pale yellow (fat)
- white (obstructive jaundice).

#### Consistency (Fig. 4.1)

The consistency can be described as:

- formed (normal shape)
- soft formed
- unformed or liquid (watery).

The presence of external blood or mucus, usually seen as streaks of red or white, should be noted. Blood may be present in certain medical conditions (e.g. ulcerative colitis, schistosomiasis).

### 4.2.3 Microscopic examination

Direct microscopic examination of faeces in saline or iodine suspension is useful for the following reasons:

- to detect motile trophozoites;
- to detect ova and cysts present in moderate numbers;
- to detect erythrocytes, cellular debris or excess fat.

Select unformed or liquid faeces when using direct microscopy for detection of trophozoites. Formed stools rarely contain motile trophozoites. Also perform a direct examination of any external blood or mucus.

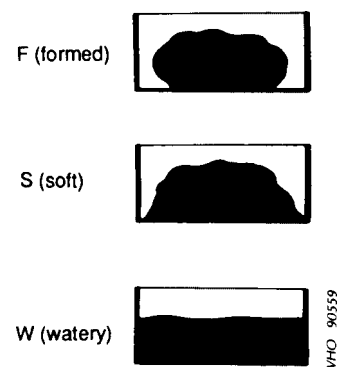

Fig. 4.1 Assessing the consistency of faecal specimens

### Materials and reagents (Fig. 4.2)

- Microscope
- Microscope slides
- Coverslips
- Wooden applicators or wire loops (0.45 mm, nickel–chromium alloy wire)
- Grease pencils
- Sodium chloride, 0.85% solution (reagent no. 53)
- Lugol iodine, 0.5% solution (reagent no. 37)
- Acetic acid, 50% solution (reagent no. 3), diluted 1:1 with distilled water
- Methylene blue solution (reagent no. 39)
- Eosin, 2% solution in saline (reagent no. 24).

### Method

1. Prepare a 1:1 mixture of Lugol iodine solution and acetic acid solution (diluted as above). Dilute the mixture with four volumes of distilled water and stir.
2. Take a dry microscope slide and label it with the name or number of the patient.
3. Put:
  - one drop of sodium chloride solution warmed to 37 °C in the middle of the left half of the slide; and
  - one drop of the iodine–acetic acid solution in the middle of the right half of the slide (Fig. 4.3).
4. Using an applicator or wire loop, take a small portion (about 2–3 mm diameter) of the stool.
  - (a) If the stools are formed, take the portion from the centre of the sample (Fig. 4.4) and from the surface to look for parasite eggs.
  - (b) If the stools contain mucus or are liquid, take the portion from the mucus on the surface or from the surface of the liquid to look for amoebae.
5. Mix the sample with the drop of sodium chloride solution on the slide.
6. Using the applicator or wire loop, take a second portion of stool from the specimen as described above and mix it with the drop of iodine–acetic acid solution. Discard the applicator (or flame the wire loop) after use.
7. Place a coverslip over each drop (apply the coverslips as shown in Fig. 4.5 to avoid the formation of air bubbles).
8. Examine the preparations under the microscope. For the saline preparation use the  $\times 10$  and  $\times 40$  objectives and a  $\times 5$  eyepiece. As the eggs and cysts are



Fig. 4.2 Materials and reagents for direct microscopic examination of faeces for parasites



Fig. 4.3 Adding a drop of saline and a drop of iodine suspension to the slide



colourless, reduce the amount of light using the condenser aperture or lower the condenser to increase the contrast.

Examine the first preparation with the  $\times 10$  objective, starting at the top left-hand corner as indicated in Fig. 4.6. Focus on the edge of one coverslip using the  $\times 10$  objective and examine the whole area under each coverslip for the presence of ova and larvae of *Strongyloides stercoralis*. Then switch to the  $\times 40$  objective and again examine the whole area of the coverslip over the saline for motile trophozoites and the area of the coverslip over the iodine for cysts.

9. Lugol iodine–acetic acid solution causes the trophozoite forms to become non-motile. The nucleus is clearly stained but it may be difficult to distinguish between trophozoite and cystic forms.
10. Using a fine Pasteur pipette, allow a drop of methylene blue solution to run under the coverslip over the saline preparation (Fig. 4.7). This will stain the nuclei of any cells present and distinguish the lobed nuclei of polymorphs from the large single nuclei of mucosal cells.
11. If a drop of eosin solution is added, the whole field becomes stained except for the protozoa (particularly amoebae), which remain colourless and are thus easily recognized.

#### 4.2.4 Dispatch of stools for detection of parasites

Stools may be sent to a specialized laboratory for the identification of rare parasites that are difficult to recognize. In such cases a preservative should be added to the specimens before they are dispatched for examination. The following preservatives are used:

- formaldehyde, 10% solution (reagent no. 28), for wet mounting;
- Lugol iodine, 0.5% solution (reagent no. 37);
- polyvinyl alcohol (PVA) fixative (reagent no. 44);
- thiomersal–iodine–formaldehyde (TIF) fixative (reagent no. 58), for wet mounting.

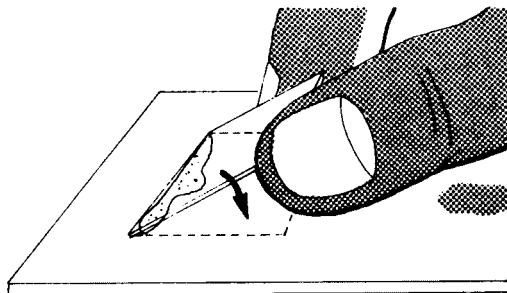

Fig. 4.5 Technique for applying a coverslip to avoid the formation of air bubbles

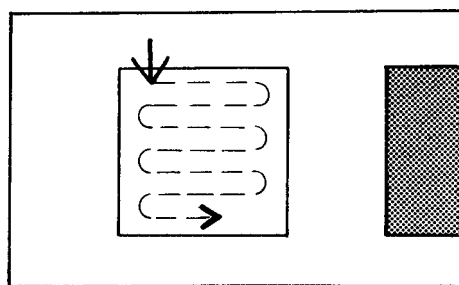

Fig. 4.6 Examining the area under the coverslip for parasites

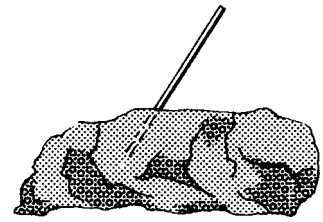

Fig. 4.4 Sampling a faecal specimen for parasite eggs



Fig. 4.7 Staining the saline preparation with methylene blue



Fig. 4.8 Preserving a faecal specimen in formaldehyde solution

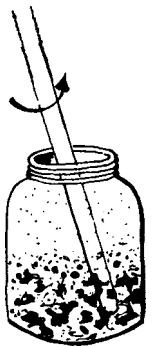

Fig. 4.9 Crushing the faecal specimen with a glass rod

### Using 10% formaldehyde solution

1. Prepare a mixture containing about one part of stool to three parts of formaldehyde solution (Fig. 4.8).
2. Crush the stool thoroughly with a glass rod (Fig. 4.9).

Formaldehyde solution preserves eggs and cysts of parasites indefinitely if the specimen container is tightly closed. It does not preserve vegetative forms of protozoa, which are destroyed after a few days.

### Using polyvinyl alcohol fixative

#### *In a bottle*

1. Pour about 30 ml of PVA fixative into a 40-ml bottle.
2. Add enough *fresh* stools to fill the last quarter of the bottle.
3. Mix thoroughly with a glass rod.

PVA fixative preserves all forms of parasites indefinitely.

#### *On a slide*

1. To examine for amoebae and flagellates, place a small portion of the stool on one end of the slide.
2. Add three drops of PVA fixative to the stool.
3. Using a glass rod, carefully spread the specimen over about half of the slide (Fig. 4.10). Leave to dry for 12 hours (preferably at 37 °C).

Specimens preserved in this way can be kept for about 3 months. They can be stained on arrival at the specialized laboratory.

### Using thiomersal<sup>1</sup>-iodine-formaldehyde fixative

1. Just before dispatch, mix 4.7 ml of TIF fixative and 0.3 ml of Lugol iodine solution in a tube or a small bottle.
2. Add approximately 2 ml (2 cm<sup>3</sup>) of stool and crush well with a glass rod.

The above-mentioned mixture preserves all forms of parasites indefinitely, including vegetative forms of amoebae (those of flagellates deteriorate slightly).

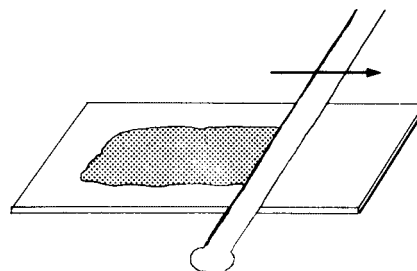

Fig. 4.10 Spreading a faecal specimen on a slide

<sup>1</sup>Also known as thimerosal and mercuriothiolate.

**Table 4.3 Pathogenicity of intestinal protozoa**

Species	Pathogenicity
<b>Amoebae</b>	
<i>Entamoeba histolytica</i>	Only amoeba that is commonly pathogenic to humans. May cause dysentery or abscesses
<i>Entamoeba coli</i>	Non-pathogenic, but very common
<i>Entamoeba hartmanni</i> , <i>Endolimax nanus</i> , <i>Iodamoeba butschlii</i> , <i>Dientamoeba fragilis</i>	Non-pathogenic. Differentiation is difficult but not really necessary; it is enough to be able to distinguish these species from <i>Entamoeba histolytica</i>
<b>Flagellates</b>	
<i>Giardia intestinalis</i>	Pathogenic
<i>Trichomonas hominis</i>	Non-pathogenic
<i>Chilomastix mesnili</i>	Non-pathogenic
<b>Ciliates</b>	
<i>Balantidium coli</i>	Pathogenic

### 4.3 Intestinal protozoa

Protozoa are microorganisms consisting of a single cell. Intestinal protozoa may be found in stools in their motile form (trophozoites) or as cysts. Some intestinal protozoa are pathogenic (see Table 4.3); others are harmless. All these protozoa are found throughout the world.

#### 4.3.1 Identification of motile forms (trophozoites)

The trophozoites of protozoa are motile (Fig. 4.11):

- either because of slow movements of the cell (amoebae);
- or because they have rapidly moving flagella (long whip-like threads) or cilia (numerous short hairs).

Trophozoites are chiefly found in:

- watery stools
- stools containing mucus
- soft formed stools.

The following features are useful for the identification of motile forms of intestinal protozoa (Fig. 4.12):

- size
- cytoplasm
- pseudopodia
- nuclei
- ectoplasm
- endoplasm
- vacuoles
- inclusion bodies containing erythrocytes, bacteria, yeast cells, debris, etc.
- nuclear membrane (chromatin)
- nuclear karyosome
- flagella
- undulating membrane.

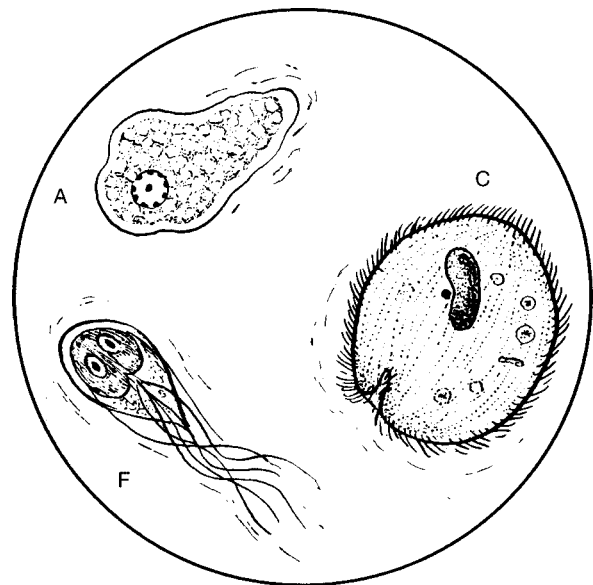

Fig. 4.11 Motile forms of protozoa  
A: amoeba; F: flagellate; C: ciliate.

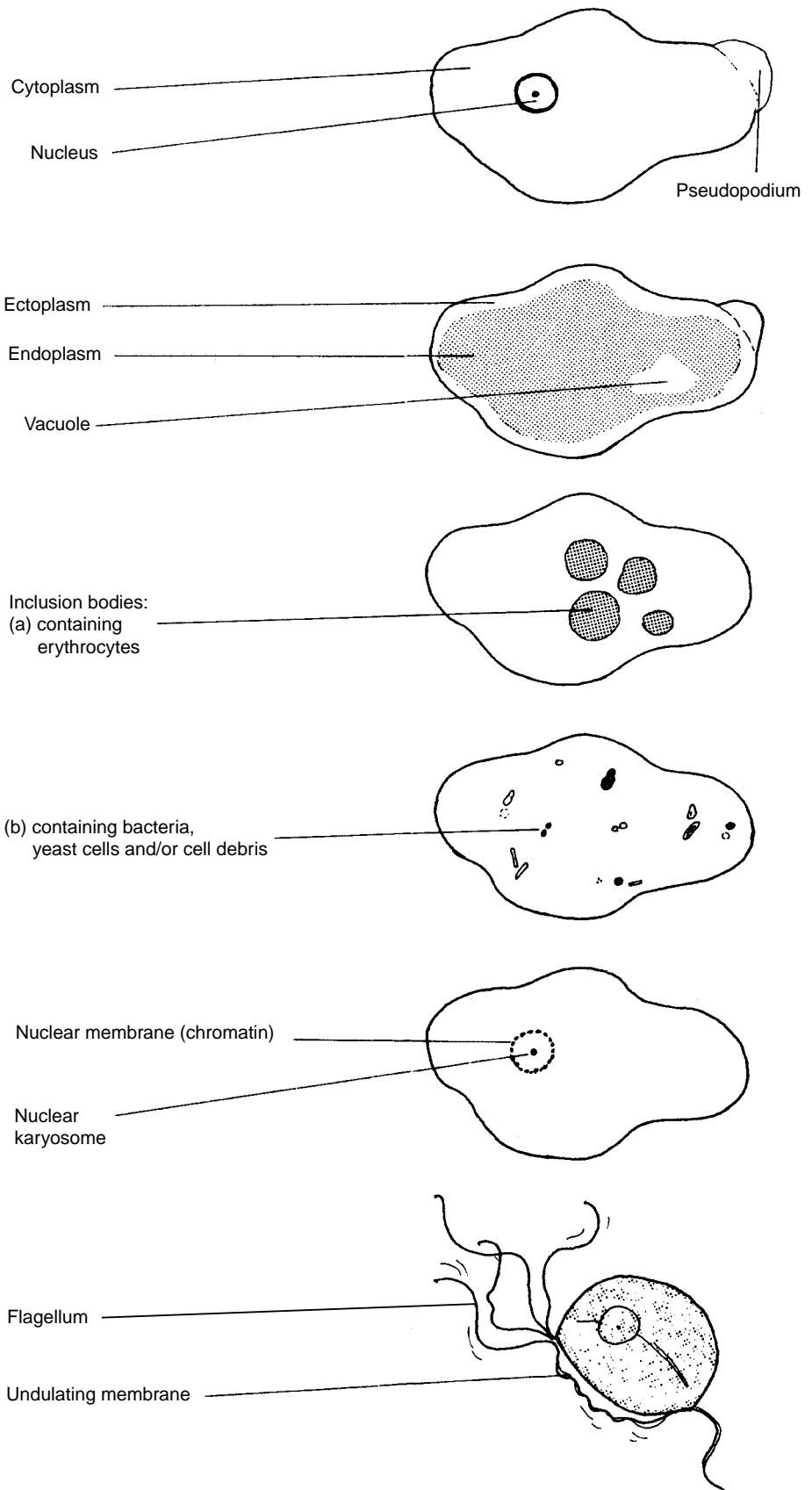

Fig. 4.12 Features for the identification of motile forms of protozoa

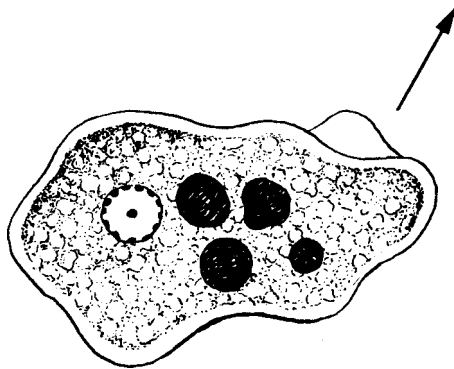

Fig. 4.13 Invasive form of *Entamoeba histolytica* trophozoite

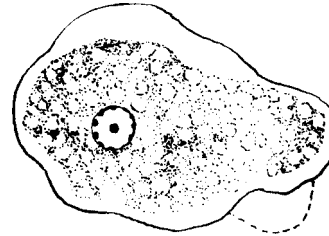

Fig. 4.14 Non-invasive form of *Entamoeba histolytica* trophozoite

### Identification of motile forms of amoebae

*Entamoeba histolytica* (Figs 4.13 and 4.14)  
(dysentery amoeba)

**Size:** 12–35  $\mu\text{m}$  (usually the size of 3–4 erythrocytes).

**Shape:** when moving, elongated and changing; when not moving, round.

**Motility:** moves in one direction; a pseudopodium pushes forward and the endoplasm flows quite rapidly into it.

**Cytoplasm:** the ectoplasm is transparent, quite different from the fine granular texture of the endoplasm (greyish with yellowish-green streaks), which may contain vacuoles.

**Nucleus:** not visible in the motile form, but when stained with iodine solution clearly seen to have a regular membrane and a small dense central karyosome (a black dot).

Two motile forms of *E. histolytica* can be found in liquid or diarrhoeal faeces: an invasive form and a non-invasive form.

Invasive form (see Fig. 4.13)

The invasive form measures 20–35  $\mu\text{m}$ . It has vacuoles containing more or less digested erythrocytes (1–20 of different sizes) indicating haematophagous (blood-eating) activity and so pathogenic capability.

Non-invasive form (see Fig. 4.14)

The non-invasive form measures 12–20  $\mu\text{m}$ . It thrives in the intestinal cavity where it eats bacteria or other material that can be seen inside the vacuoles. It is non-pathogenic.

*Entamoeba coli* (Fig. 4.15)

**Size:** 20–40  $\mu\text{m}$  (usually bigger than *E. histolytica*).

**Shape:** oval or elongated, rather irregular, often non-motile or moving very slowly, putting out blunt pseudopodia in all directions.

**Cytoplasm:** both the ectoplasm and the endoplasm are granular and difficult to differentiate.

**Inclusion bodies:** numerous and varied (bacteria, yeast cells, cell debris), but never erythrocytes.

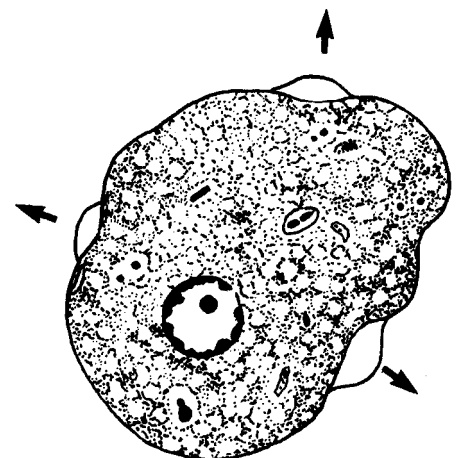
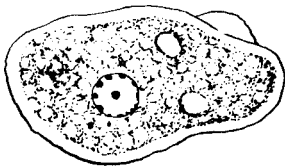

Fig. 4.15 *Entamoeba coli* trophozoite

**Table 4.4 Features for the differential diagnosis of *Entamoeba histolytica* and *E. coli***

Feature	<i>E. histolytica</i>	<i>E. coli</i>
Motion	In a definite direction	Haphazard
Motility	Fairly motile	Non-motile or barely motile
Ectoplasm	Transparent, quite different from endoplasm	Little or no differentiation from endoplasm
Inclusion bodies	Erythrocytes if haematophagous	Bacteria, yeast cells and varied debris, no erythrocytes
Nucleus (fresh state)	Invisible	Visible (nuclear membrane is like a bead necklace)
Nuclear membrane (after staining with iodine solution)	Regular membrane	Irregular membrane
Karyosome	Small, dense, central	Large, eccentric

Fig. 4.16 *Entamoeba hartmanni* trophozoite

**Nucleus:** visible in the fresh state, without staining. The membrane is irregular and granular (like a bead necklace), the karyosome large and eccentric.

Table 4.4 summarizes the features used for the differential diagnosis of *Entamoeba histolytica* and *E. coli*. If a trophozoite moves quickly in one direction and projects pseudopodia rapidly, it is probably *Entamoeba histolytica*. Other species of amoeba do not usually move like this. If the trophozoite moves as described and if erythrocytes are present in the cytoplasm, it can be assumed that it is *E. histolytica*. If necessary, buffered methylene blue can be used to stain the nucleus for confirmation.

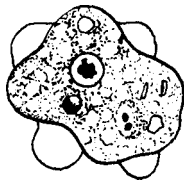
Fig. 4.17 *Endolimax nanus* trophozoite

***Entamoeba hartmanni*** (Fig. 4.16)

**Size:** always less than 10µm (about the size of an erythrocyte).

All characteristics similar to those of *E. histolytica* but never contains erythrocytes. There may be distinct vacuoles.

***Endolimax nanus*** (Fig. 4.17)

**Size:** 6–10µm.

**Motility:** many small rounded pseudopodia moving slowly in all directions.

**Cytoplasm:** very granular with small vacuoles.

**Inclusion bodies:** various (mainly bacteria).

**Nucleus:** karyosome similar to an ink-spot, visible after staining with iodine solution.

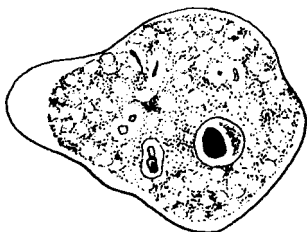
Fig. 4.18 *Iodamoeba butschlii* trophozoite

***Iodamoeba butschlii*** (Fig. 4.18)

**Size:** 10–15µm.

**Shape:** compact, leaf-like.

**Motility:** very slow; clear, rounded or finger-shaped pseudopodia.

**Inclusion bodies:** bacteria, large vacuoles.

**Nucleus:** a large oval karyosome next to a group of granules, visible after staining with iodine solution.

*I. butschlii* amoebae are rarely seen in stools.

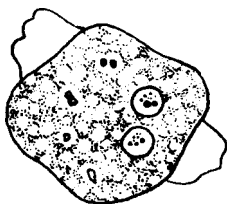
Fig. 4.19 *Dientamoeba fragilis* trophozoite

***Dientamoeba fragilis*** (Fig. 4.19)

**Size:** 6–15µm.

**Shape:** round.

**Motility:** either non-motile (most often) or very motile (in very fresh fluid stools), with pseudopodia similar to the blades of an electric fan; quickly becomes non-motile under the coverslip.

**Cytoplasm:** clear ectoplasm.

**Inclusion bodies:** bacteria.

**Nucleus:** one or two nuclei, visible after staining with iodine solution; karyosomes split into 4–6 granules (membrane hardly visible).

### Identification of motile forms of flagellates

All of these parasites, with the exception of *Trichomonas hominis*, can appear in an active flagellate vegetative form or as inactive cysts.

***Giardia intestinalis*** (Fig. 4.20)

**Size:** 10–18 μm (size of two erythrocytes).

**Shape:** rather elongated

*front view:* similar to a pear

*side view:* spoon-shaped.

**Motility:** either moves forward in small rapid jerks in a definite direction, sometimes turning in a loop (fluid stools), or is hardly motile.

**Nuclei:** two large oval nuclei, faintly visible.

**Important:**

- The characteristic movement is seen only in fresh liquid stools.
- Flakes of mucus in fluid stools often contain clusters of large numbers of *G. intestinalis*.
- The vegetative and cystic forms of *G. intestinalis* are often found together in soft stools.

***Trichomonas hominis*** (Fig. 4.21)

**Size:** 10–15 μm (slightly smaller than *G. intestinalis*).

**Shape:** oval with two pointed poles.

**Motility:** whirls and turns in all directions, seeming to vibrate.

**Undulating membrane:** present on one side only; extremely motile (a rapid wavy movement).

**Nucleus:** one nucleus, difficult to see.

**Flagella:** usually four.

*T. hominis* is the most resistant flagellate. It remains motile even in old stools.

***Chilomastix mesnili*** (Fig. 4.22)

**Size:** 10–15 μm.

**Shape:** triangular and tapered at one end, appears twisted.

**Motility:** moves in one definite direction, in a spiral.

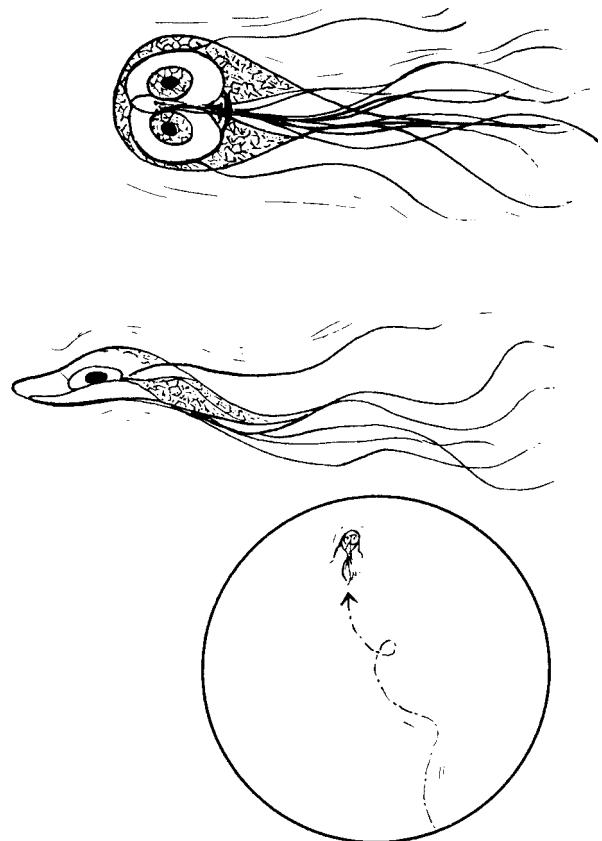
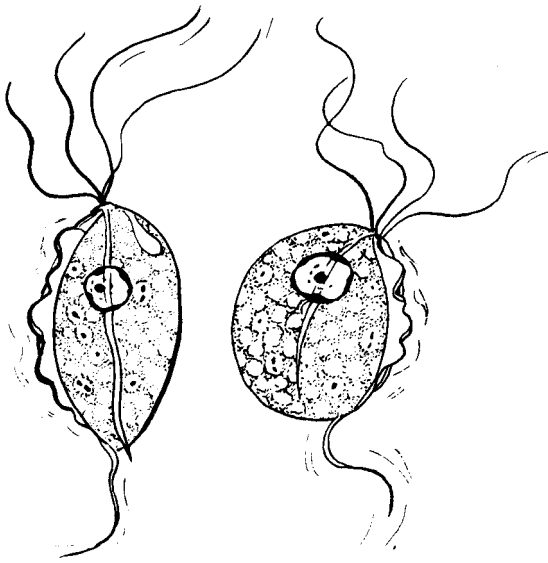
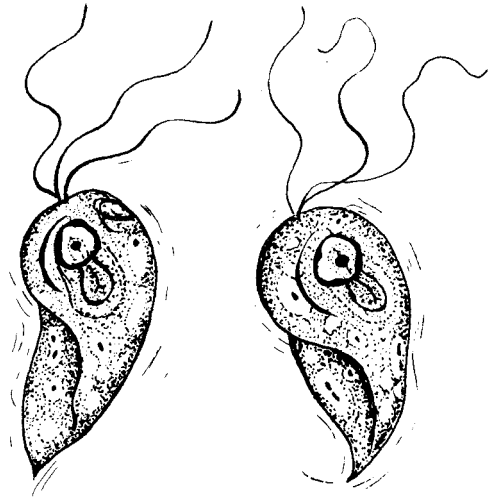
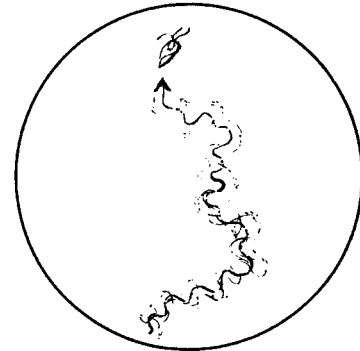
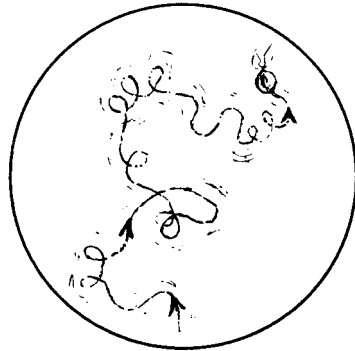

Fig. 4.20 *Giardia intestinalis* trophozoite

Fig. 4.21 *Trichomonas hominis* trophozoitesFig. 4.22 *Chilomastix mesnili* trophozoites

*Cytoplasm*: greyish-green with:

- towards the tapered end: a distinct spiral marking, around which the flagellate turns (figure-of-eight)
- near the rounded end: a mouth-like cleft (faintly visible cytostome).

*Nucleus*: one nucleus, easily visible in unstained preparations.

### Identification of motile forms of ciliates

*Balantidium coli* (rare) (Fig. 4.23)

*Size*: about 50  $\mu\text{m}$ .

*Shape*: oval, with one pole more rounded than the other.

*Cilia*: covered with many small cilia, which move with rapid strokes.

*Motility*: moves very rapidly in stools, crossing the field in a definite direction and sometimes turning in circles.

*Cytoplasm*: transparent.

*Nuclei*: a large kidney-shaped nucleus next to a small round nucleus.

“*Mouth*”: the cytostome; a sort of mouth that contracts and expands, drawing in cell debris.

*Important*: If stools are left exposed to the air, without a lid, organisms of the infusoria type may fall on to them from the atmosphere. These may be confused with *Balantidium coli*.



### Rapid Field stain for faecal trophozoites

#### Materials and reagents

- Microscope
- Microscope slides
- Slide rack
- Field stain (reagent no. 25):
  - Field stain A (undiluted)
  - Field stain B (diluted one part of stain in four parts of distilled water)
- Sodium chloride, 0.85% solution (reagent no. 53)
- Methanol.

#### Method

1. Prepare a thin faecal smear in sodium chloride solution on a clean slide.
2. Once the smear is dry, fix it by covering the slide with methanol for 3 minutes.
3. Tip off the methanol.
4. Pipette 1 ml of diluted Field stain B onto the slide, followed by 1 ml of undiluted Field stain A.
5. Mix well by tilting the slide and allow to stain for 1 minute.
6. Wash the slide in water and allow it to air-dry.
7. Examine the slide using the  $\times 100$  oil-immersion objective. Scan the smear, particularly around the edges.

The cytoplasm and flagella of trophozoites of *Giardia intestinalis* stain blue and their nuclei stain red. Cysts of *G. intestinalis* also stain blue and their nuclei stain red.

#### Note:

- Leave freshly prepared stains for 3 days before use.
- Use rainwater to prepare the stains if the local well-water supply is too salty.
- Cover the jars containing the staining solutions to prevent evaporation and absorption of dust.
- Avoid carrying over one staining solution to another.

### Eosin stain for faecal trophozoites and cysts

#### Materials and reagents

- Microscope
- Microscope slides
- Slide rack
- Coverslips
- Eosin, 1% solution (reagent no. 23).

#### Method

1. Emulsify a small portion of stool in 1% eosin solution on a clean slide. Spread over an area of approximately 2 cm  $\times$  1 cm.
2. Put a coverslip on the slide and place it on the microscope stage.
3. Use the  $\times 10$  objective to examine the smear systematically for unstained trophozoites and cysts. Examine in more detail with the  $\times 40$  objective.

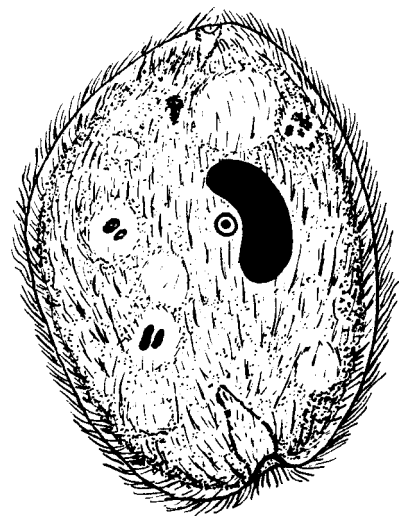
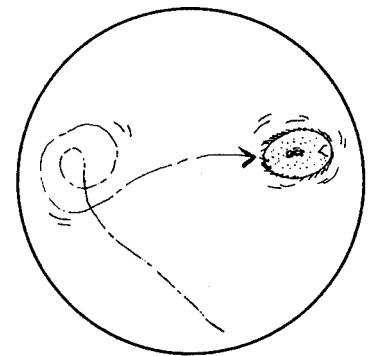

Fig. 4.23 *Balantidium coli* trophozoite

The eosin stain provides a pink background against which unstained trophozoites and cysts are clearly visible.

*Note:* If 1% eosin solution is not available, use a drop of Field stain B (see above).

#### 4.3.2 Identification of cysts

Cysts are the resistant forms of certain intestinal amoebae, flagellates and ciliates. They are small, round and non-motile and may have one or several nuclei.

Measurement of cysts is useful for the correct identification of species.

#### Importance of cysts

The clinical importance of cysts varies from country to country. The cyst is the infective form of the organism. Healthy persons may be asymptomatic carriers of cysts and are, therefore, a public health hazard.

The most important problem in the laboratory is the precise identification of cysts of *Entamoeba histolytica*, *Giardia intestinalis* and *Balantidium coli*. Some of the features used in the identification of these cysts and those of other intestinal protozoa are illustrated in Fig. 4.24.

#### Identification of cysts of amoebae

*Entamoeba histolytica* (Fig. 4.25)

*Size:* 12–15 µm (1–2 erythrocytes).

*Shape:* round.

*Nuclei:* 1–4 nuclei:

*membrane* — thin, regular, circular

*karyosome* — small, compact, central (like a black dot).

*Cytoplasm:* yellowish-grey after staining with iodine solution, granular; “dirty” appearance.

*Chromatoid bodies:* oblong, rounded at ends (sausage-shaped); not found in all cysts.

*Vacuole:* sometimes a large glycogen vacuole (stained reddish-brown by iodine solution) in young cysts with one or two nuclei.

*E. histolytica* may cause dysentery. Identification of cysts of other amoebae that do not cause disease may be difficult. The main thing is to differentiate between them and the cysts of *E. histolytica*.

*Entamoeba coli* (Fig. 4.26)

*Size:* 12–20 µm (1–2 erythrocytes; slightly larger than the cyst of *E. histolytica*).

*Shape:* round or slightly oval, sometimes irregular.

*Nuclei:* 1–8 nuclei:

*membrane* — irregular, thick in parts, not a perfect circle

*karyosome* — large, diffuse, often eccentric.

*Cytoplasm:* pale yellow after staining with iodine solution, bright (as compared with *E. histolytica*).

*Chromatoid bodies:* sharp or jagged ends (dagger-shaped or needle-shaped); not found in all cysts.

*Vacuole:* sometimes a very large vacuole (stained reddish-brown by iodine solution) compressing two nuclei, one at either pole.

Fig. 4.24 Features for the identification of cysts of intestinal protozoa

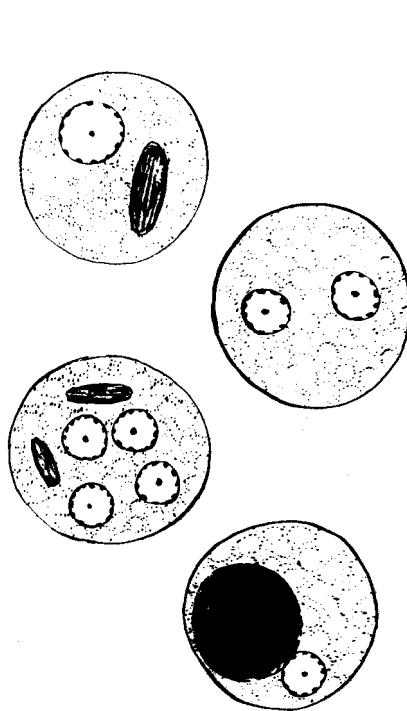
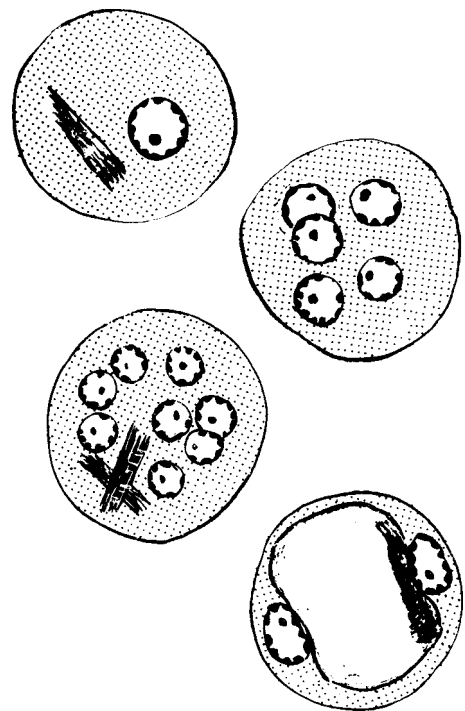
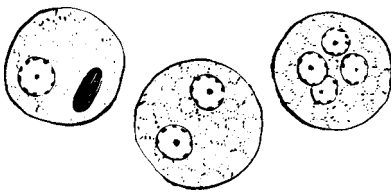
Fig. 4.25 *Entamoeba histolytica* cystsFig. 4.26 *Entamoeba coli* cystsFig. 4.27 *Entamoeba hartmanni* cysts

*Entamoeba hartmanni* (Fig. 4.27)

*Size:* 4–8  $\mu\text{m}$  (same diameter as an erythrocyte).

*Nuclei:* 1–4 nuclei, identical to those of *E. histolytica* (see above).

*Endolimax nanus* (Fig. 4.28)

*Size:* 8–10  $\mu\text{m}$ .

*Shape:* more or less oval.

*Nuclei:* 1–4 nuclei:

*membrane* — cannot be seen

*karyosome* — large, irregular outline.

*Cytoplasm:* clear, without granules, stained yellow by iodine solution.

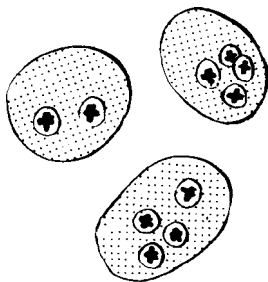
Fig. 4.28 *Endolimax nanus* cysts

*Iodamoeba butschlii* (Fig. 4.29)

*Size:* 8–10  $\mu\text{m}$ .

*Shape:* varies (round, oval or irregular).

*Nucleus:* almost always a single nucleus:

*membrane* — cannot be seen

*karyosome* — very large, oval, pressed against a cluster of granules.

*Vacuole:* a very large glycogen vacuole (stained reddish-brown by iodine solution, hence the name *Iodamoeba*), often taking up half of the cyst.

*Dientamoeba fragilis*

Not found in cyst form.

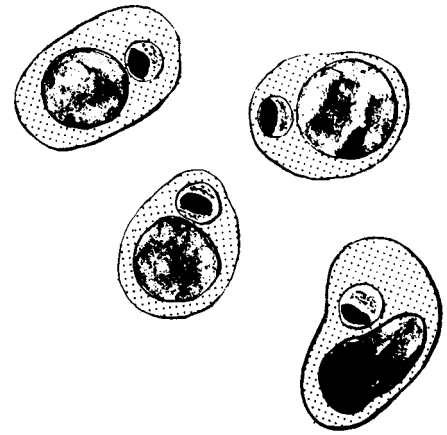
**Identification of cysts of flagellates***Giardia intestinalis* (Fig. 4.30)*Size:* 8–12 µm.*Shape:* oval, one pole more rounded than the other.*Shell:* often appears to be thick with a double wall; the second wall is the membrane of the cytoplasm.*Nuclei:* 2–4 oval nuclei (not clearly seen):*membrane* — very fine*karyosome* — small, central, faintly coloured.*Cytoplasm:* clear, shiny when unstained; pale yellowish-green or bluish after staining with iodine solution.*Fibril:* shiny, hair-like line, folded in two or S-shaped, placed lengthwise in the centre of the cyst (adjust the microscope).Fig. 4.29 *Iodamoeba butschlii* cysts*Chilomastix mesnili* (Fig. 4.31)*Size:* 6–8 µm.*Shape:* round, one pole tapered (similar to a pear).*Nucleus:* a single, large nucleus:*membrane* — clearly seen, thick in parts*karyosome* — small and central.*Fibril:* twisted, like a curled hair.**Identification of cysts of ciliates***Balantidium coli* (Fig. 4.32)*Size:* 50–70 µm (the size of an *Ascaris lumbricoides* egg).*Shape:* round.*Shell:* thin, double wall.*Nuclei:* a large kidney-shaped nucleus next to a small round nucleus.*Cytoplasm:* granular, greenish, filled with inclusion bodies.

Often the trophozoite form (see page 119) can be seen faintly inside.

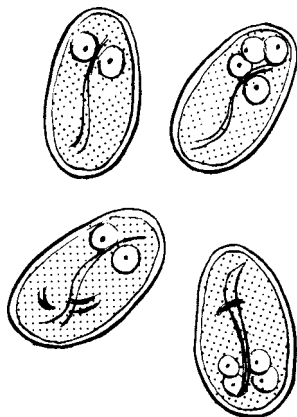
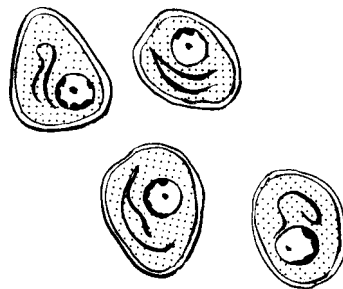
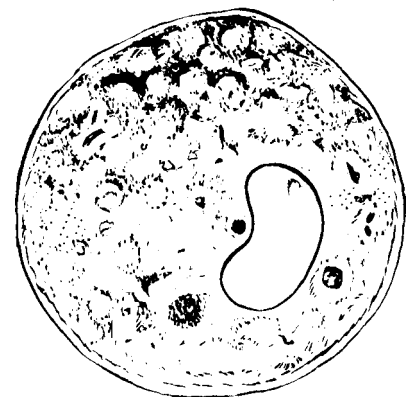
Fig. 4.30 *Giardia intestinalis* cystsFig. 4.31 *Chilomastix mesnili* cystsFig. 4.32 *Balantidium coli* cyst

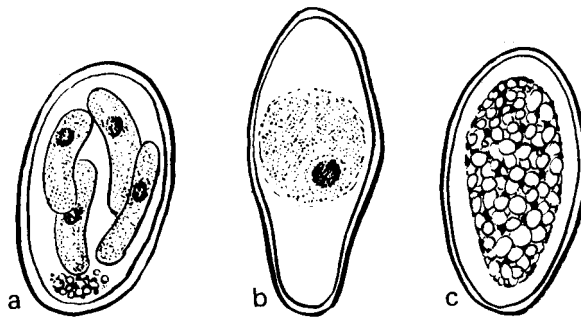

Fig. 4.33 Types of coccidia

a: Containing four sporozoites and occasionally a few large granules clustered at one pole; b: containing one large round granular cell; c: containing refractive granules completely filling the interior.

### Coccidia (Fig. 4.33)

Coccidia are protozoa that may be parasites of humans (without causing any significant pathogenic effects) or may be found in transit in the stools of people who have consumed infected food (fish, rabbit, etc.). They appear in the stools in a form resembling cysts (and are called oocysts or sporocysts).

*Size:* 15–20  $\mu\text{m}$ , depending on the species.

*Shape:* an elongated oval, sometimes tapered at one pole.

*Colour:* colourless and transparent (or occasionally pale yellow).

*Shell:* a quite distinct, slightly shiny double line; sometimes an operculum is present at one pole.

There are three types of coccidia (see Fig. 4.33):

- (a) containing four sporozoites (small banana-shaped rods), each with a small round nucleus; sometimes a few large granules are clustered at one pole;
- (b) containing one large round granular cell;
- (c) containing shiny granules completely filling the interior.

### Microscopic examination of cysts

#### Preparation in saline wet mount

Cysts can be seen as transparent shiny globules standing out clearly against a grey background. They have well-defined shells.

Using the  $\times 40$  objective, look for shiny round objects with a diameter roughly equal to 1–3 erythrocytes.

#### Chromatoid bodies

Look also for chromatoid bodies (rod-shaped structures). Chromatoid bodies are more distinct in saline mounts than in iodine mounts. These bodies are characteristic in appearance and occur in cysts of *Entamoeba histolytica* and *E. coli*. The rod-shaped chromatoid bodies of *E. histolytica* have blunt rounded ends; those of *E. coli* have pointed ends. These chromatoid bodies are seen less frequently in cysts of *E. coli* than in those of *E. histolytica*.

#### Nuclei

Nuclei are not easily visible in saline mounts but are clearly seen in iodine mounts. The appearance of the nucleus is important in differentiating between species of amoeba. Therefore, if cysts (or cyst-like bodies) are seen in the saline mount, examine an iodine mount.

#### Measurement

Accurate measurement of cysts is essential for their correct identification. Measure any cysts you find; if possible use a calibrated graticule in the eyepiece (see section 3.1.1, page 56).

#### *Preparation in iodine wet mount*

Iodine mounts are used to detect cysts of amoebae and flagellates. Cysts can be detected with the  $\times 10$  objective. Use the  $\times 40$  objective to see the characteristics of the cysts and measure them to ensure correct identification.

Iodine stains the cytoplasm of the cysts yellow or light brown; nuclei are stained dark brown. When cysts of *Entamoeba* spp. are stained with iodine, the arrangement of the peripheral chromatin and the position of the karyosome can be seen. (If the peripheral chromatin is absent, the cyst is not a species of *Entamoeba*.) These peripheral chromatoid bodies stain light yellow and may not be very clear. Sometimes, young cysts contain glycogen; this stains dark brown with iodine. Staining flagellate cysts with iodine enables the fibrils (filaments) to be seen.

Cysts of several different species may be found in the same stool specimen.

#### Concentration

If necessary, use the formaldehyde–ether sedimentation technique (see section 4.5.2) to examine a larger number of cysts for more certain identification.

#### *Eosin stain for faecal trophozoites and cysts*

See section 4.3.1, page 117.

#### *Modified Ziehl–Neelsen technique for staining oocysts of Cryptosporidium spp.*

Infections with *Cryptosporidium* spp. cause fever, abdominal cramps, diarrhoea and weight loss with an associated eosinophilia. In severe cases, a malabsorption syndrome may develop.

Cryptosporidiosis causes self-limiting diarrhoea in children. It is a recognized cause of chronic diarrhoea in adults with lowered immunity, e.g. patients with acquired immunodeficiency syndrome (AIDS). Cryptosporidiosis should be suspected in patients with chronic diarrhoea and weight loss, for which no other cause can be found.

#### Materials and reagents

- Microscope
- Microscope slides
- Slide rack
- Petri dish
- Cotton wool
- Sodium chloride, 0.85% solution (reagent no. 53)
- Formaldehyde, 37% solution (formalin)
- Carbol fuchsin for Ziehl–Neelsen stain (reagent no. 16)
- Acid–ethanol for Ziehl–Neelsen stain (reagent no. 5)
- Malachite green, 1% solution (see reagent no. 31)
- Methanol.

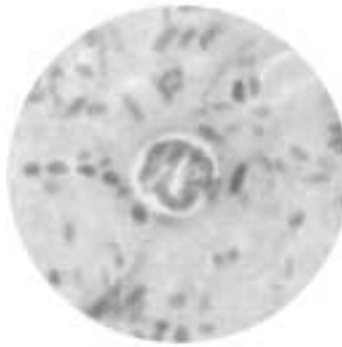

Fig. 4.34 *Cryptosporidium* spp. oocysts

#### Method

1. Emulsify a small amount of faeces in saline on a clean slide. Spread over an area of approximately 2 cm × 1 cm.
2. Allow the smear to dry before fixing in absolute methanol for 5 minutes. If the patient is known to be, or suspected of being, positive for human immunodeficiency virus (HIV), fix the smear in formalin vapour for 15 minutes by placing the slide in a Petri dish with a cotton wool ball soaked in formalin.
3. Flood the slide with carbol fuchsin for 5 minutes. Wash the stain off with water.
4. Flood the slide with acid-ethanol solution to decolorize until faint pink. Wash the slide in water.
5. Counterstain the slide with malachite green solution for 2 minutes. Wash in water and place in a slide rack to drain and dry.

Examine the slide under the microscope using the ×40 objective.

Oocysts of *Cryptosporidium* spp. stained by this method may show a variety of stain reactions from pale pink to deep red. The oocysts measure 4–6 μm. The sporozoites within the oocysts have an outer rim of deep stained material with a pale centre (Fig. 4.34). This differentiates oocysts from some yeasts which may stain red but have a homogeneous smooth appearance.

*Note:* *Cryptosporidium* spp. belong to a group of parasites called coccidia (see page 122). Other parasites of this group are:

- *Isospora belli*
- *Toxoplasma gondii*
- *Plasmodium* spp.

The oocysts of *Cryptosporidium* spp. are highly resistant to disinfecting agents.

#### **Features not to be mistaken for cysts**

Fungi (Fig. 4.35)

*Size:* 5–8 μm.

*Shape:* oval, often with buds.

*Colour:* reddish-brown after staining with iodine solution.

*Content:* often an eccentric cluster of 3–6 small granules.

Some forms of fungi (arthrospores) are rectangular, with a very clear oval cytoplasm inside.

*Blastocystis hominis* (yeast) (Fig. 4.36)

*Size:* 5–20 μm (average 10 μm).



*Shape:* round or oval, sometimes with angular irregular edges.

*Colour:* very shiny when unstained; the vacuole is not stained by iodine solution, but the periphery is pale yellow.

*Content:* one large vacuole taking up almost the whole cell; the compressed cytoplasm forms a granular ring round it.

Some physicians request that the presence of *B. hominis* be reported, particularly in children's stools.

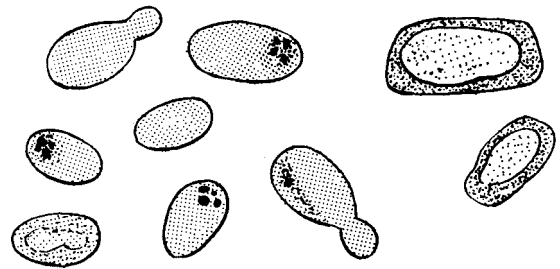

Fig. 4.35 Fungi

Leukocytes (white blood cells) (Fig. 4.37)

*Size:* 10–20 μm.

*Shape:* round or slightly elongated, with an irregular outline.

*Nucleus:* indistinct, sometimes with a star-shaped “false karyosome”.

*Content:* shiny cytoplasm, clear and granular with tiny vacuoles.

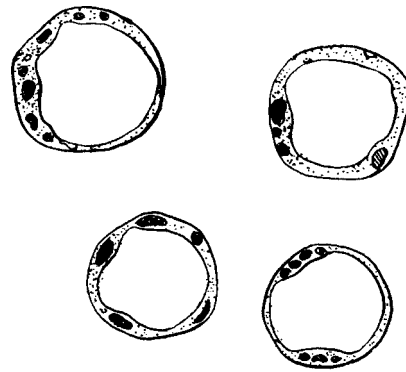

Fig. 4.36 *Blastocystis hominis*

Pus (Fig. 4.38)

Pus appears to the naked eye as opaque, greyish streaks (not transparent like mucus). Under the microscope it appears as a mass of degenerated leukocytes.

The presence of pus should be reported as it is a sign of infection.

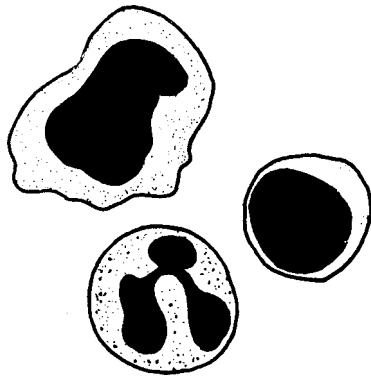

Fig. 4.37 Leukocytes

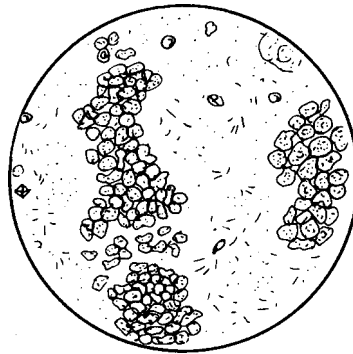

Fig. 4.38 Pus

#### 4.4 Intestinal helminths

Helminth infections cause a variety of clinical symptoms including abdominal cramps, fever, weight loss, vomiting, appendicitis, blood loss, anaemia and eosinophilia. There are three groups of medically important helminths:

- nematodes (roundworms)
- cestodes (tapeworms)
- trematodes (flukes).

Helminth infections are usually diagnosed by detecting eggs and larvae. Less frequently, infections are diagnosed by detecting adult worms (e.g. *Ascaris lumbricoides* and *Enterobius vermicularis*) or proglottids (segments) of adult worms (e.g. *Taenia saginata* and *T. solium*). However, for most helminth infections, eggs are used for identification.

#### 4.4.1 Identification of eggs

The characteristics used to identify eggs of helminth species are as follows:

##### *Size*

The length and width are measured and are generally within a specific range.

##### *Shape*

Each species has its own particular shape.

##### *Stage of development when passed*

The eggs of some species consist of a single cell, some eggs have several cells, and some eggs are usually embryonated, i.e. they contain a larva.

Occasionally, if stool specimens are 1–2 days old, eggs may develop to more advanced stages. *Ascaris lumbricoides* (roundworm) eggs usually have only one cell when passed in the faeces; however, the single cell may divide and, in specimens over 12 hours old, eggs with two or four cells may be seen.

*Ancylostoma duodenale* or *Necator americanus* (hookworm) eggs present in specimens that are several hours old may contain 16, 32 or more cells. After 12–24 hours, the eggs may be embryonated and later still the larvae may hatch.

When observing the stage of development of helminth eggs, be sure that the stool specimen is freshly passed. If it is several hours or a day old, expect to see changes in the stage of development of some species. Ideally only fresh samples should be accepted for diagnosis.

##### *Thickness of the egg shell*

The eggs of some species such as *Ascaris lumbricoides* have thick shells, whereas others such as *Ancylostoma duodenale* or *Necator americanus* have thin shells.

##### *Colour*

The eggs of some species such as *Ancylostoma duodenale*, *Necator americanus* and *Enterobius vermicularis* are colourless, whereas others such as *Ascaris lumbricoides* and *Trichuris trichiura* are yellow or brown.

##### *Other characteristics*

The presence of characteristics such as opercula (lids), spines, plugs, hooklets or mammilated outer coats can also be aids to identification.

If an egg or an object that looks like an egg is found, the above-mentioned characteristics should be carefully observed in order to make a specific identification. Occasionally, atypical or distorted eggs are seen. In such cases, it is necessary to look for more typical forms in order to make a reliable diagnosis. Remember that more than one species of helminth may be present in a patient.

##### *Measurement of eggs*

- 1 micrometre (1  $\mu\text{m}$ ) = 0.001 mm.

The size in  $\mu\text{m}$  given in this manual is that of the long side of the egg.

The size can be estimated by comparison with that of an erythrocyte, which measures 7.5–8  $\mu\text{m}$ .

- The size can be assessed in relation to the microscope field:
  - if a  $\times 10$  objective is used, the egg takes up about one-tenth of the field
  - if a  $\times 40$  objective is used, the egg takes up about one-third of the field.
- The egg can be measured by inserting a micrometer scale slide in the eyepiece of the microscope. One division of the scale using the  $\times 10$  objective and the  $\times 10$  eyepiece =  $1\ \mu\text{m}$ .
- Another method of measuring is to compare the egg with one of another species common in the locality whose size under the microscope is known (e.g. *Ascaris lumbricoides*).

### *How to recognize eggs*

The method recommended is:

- Establish the probable identity of the egg from its general appearance.
- Make a systematic study of all the characteristics of the egg to confirm its identity. In order to gain experience (if possible, under the guidance of an instructor):
  - study the different eggs found in your locality;
  - identify, one by one, all the characteristics of each egg as described in this manual.

Table 4.5 lists the helminth species whose eggs are found in stools.

The terms used for the identification of helminth eggs and a key to their identification are given in Figs. 4.39 and 4.40, respectively. Fig. 4.41 shows the relative sizes of helminth eggs.

### *Ancylostoma duodenale*

*Size:* 50–80  $\mu\text{m}$ .

*Shape:* oval with rounded slightly flattened poles (one pole often more flattened than the other).

*Shell:* very thin; appears as a black line.

*Content:* varies according to the degree of maturity.

*Colour:* pale grey; dark brown after staining with iodine solution.

#### *Type A (in fresh stools)* (Fig. 4.42)

Four, eight or 16 grey granular cells, clear but not shiny (blastomeres).

#### *Type B (in stools a few hours old)* (Fig. 4.43)

A uniform mass of many small grey granular cells.

#### *Type C (in stools 12–48 hours old)* (Fig. 4.44)

The whole of the egg is filled by a small larva (the future worm), wrapped around itself. The egg is “embryonate”.

### *Ascaris lumbricoides*

There are four types of *Ascaris* egg:

- A: fertilized egg with double shell.
- B: unfertilized egg with double shell.

**Table 4.5 Helminth species whose eggs are found in stools**

Scientific name	Geographical distribution
<i>Ancylostoma duodenale</i>	Worldwide
<i>Ascaris lumbricoides</i>	Worldwide
<i>Clonorchis sinensis</i>	South-east Asia
<i>Dicrocoelium dendriticum</i> , <i>Dicrocoelium hospes</i>	Worldwide
<i>Diphyllobothrium latum</i>	Worldwide
<i>Dipylidium caninum</i>	Worldwide
<i>Enterobius vermicularis</i>	Worldwide
<i>Fasciola gigantica</i>	Worldwide
<i>Fasciola hepatica</i>	Worldwide
<i>Fasciolopsis buski</i>	Eastern and southern Asia
<i>Heterophyes heterophyes</i>	South-east Asia, eastern Mediterranean
<i>Hymenolepis diminuta</i>	Worldwide
<i>Hymenolepis nana</i>	Worldwide
<i>Metagonimus yokogawai</i>	Eastern and southern Asia, central and eastern Europe
<i>Necator americanus</i>	Worldwide
<i>Opisthorchis felineus</i>	Eastern and southern Asia, central and eastern Europe
<i>Paragonimus westermani</i> <sup>a</sup>	Central Africa, South America, eastern and southern Asia
<i>Schistosoma haematobium</i> <sup>b</sup>	Africa, eastern Mediterranean
<i>Schistosoma intercalatum</i>	Africa
<i>Schistosoma japonicum</i>	Eastern and southern Asia
<i>Schistosoma mansoni</i>	Africa (south of the Sahara), Central and South America, the Caribbean
<i>Schistosoma mekongi</i>	South-east Asia
<i>Strongyloides stercoralis</i> <sup>c</sup>	Worldwide
<i>Taenia saginata</i>	Worldwide
<i>Taenia solium</i>	Worldwide
<i>Trichostrongylus</i> (various species)	Asia
<i>Trichuris trichiura</i>	Worldwide

<sup>a</sup> Found mainly in sputum.

<sup>b</sup> Found mainly in urine.

<sup>c</sup> Found mainly as larvae in stools.

- C: semi-decorticated fertilized egg (less frequent).
- D: semi-decorticated unfertilized egg (very rare).

**Type A. Fertilized egg with double shell** (Fig. 4.45)

**Size:** 45–70 µm.

**Shape:** oval or sometimes round.

**Shell:** the two shells are distinct:

- the external shell is rough, brown and covered with small lumps (mamillated)
- the internal shell is smooth, thick and colourless.

**Content:** a single round granular central mass.

**Colour:** external shell — brown; content — colourless or pale yellow.

Fig. 4.39 Terms used for the identification of helminth eggs

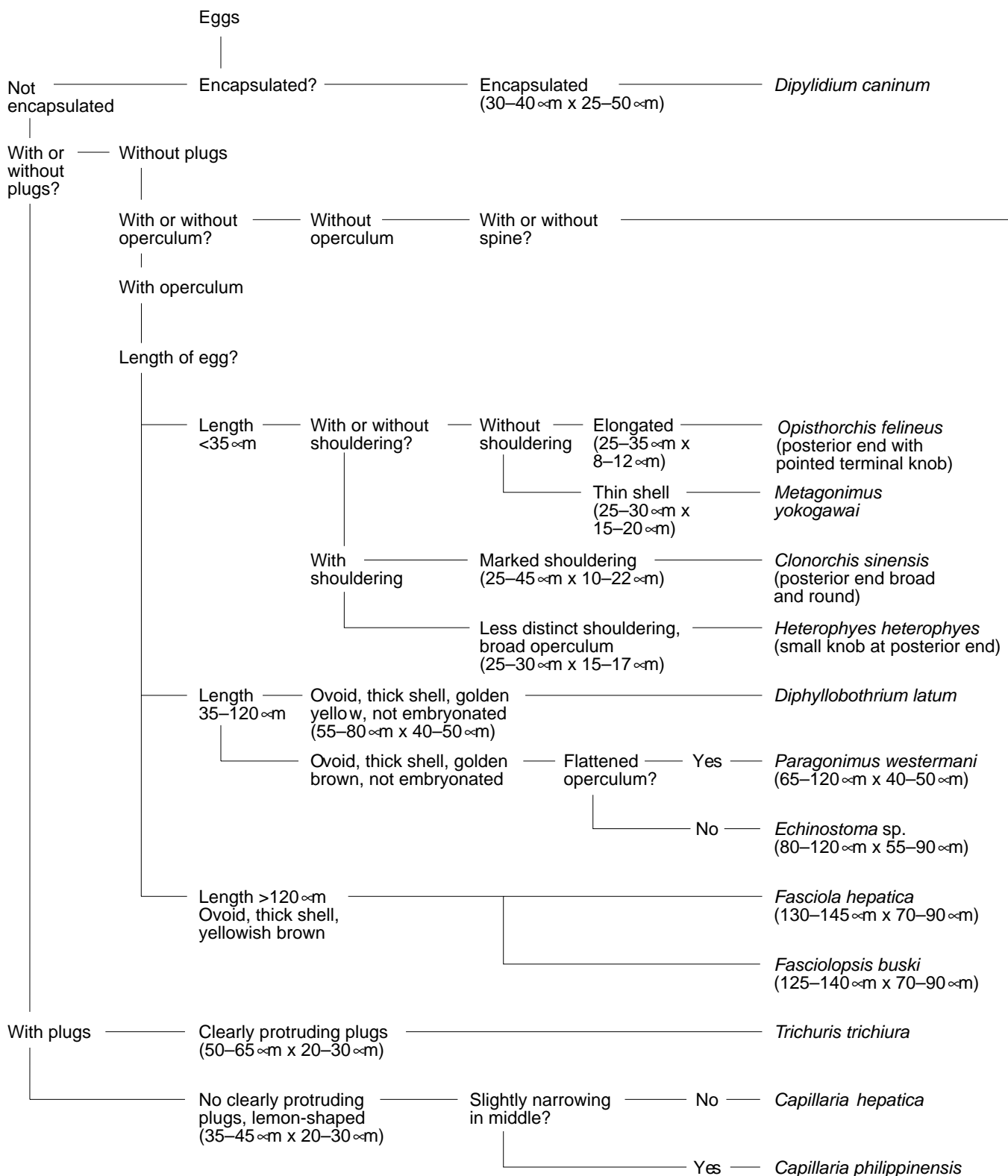
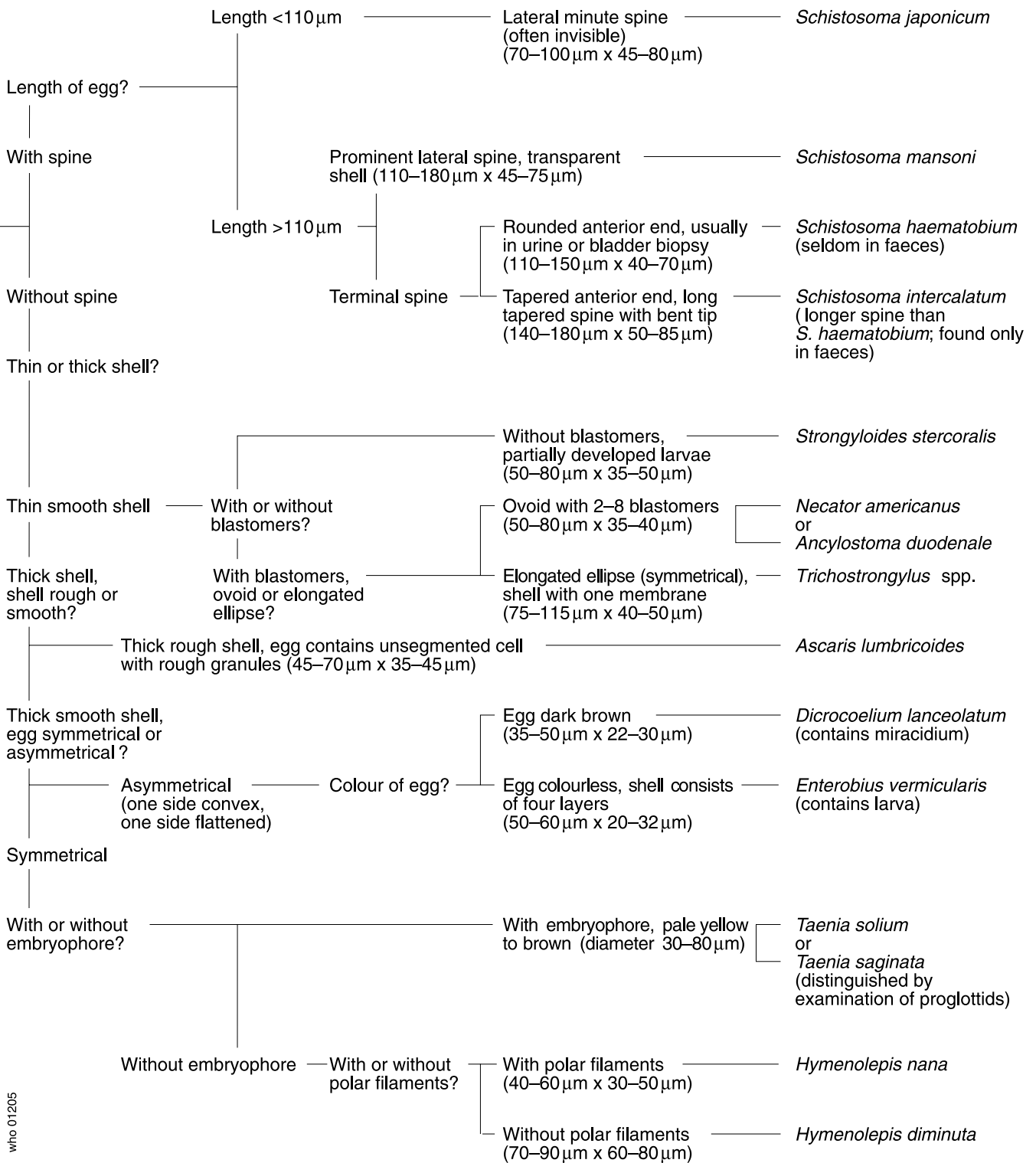

Fig. 4.40 Key to the identification of helminth eggs



who 01205

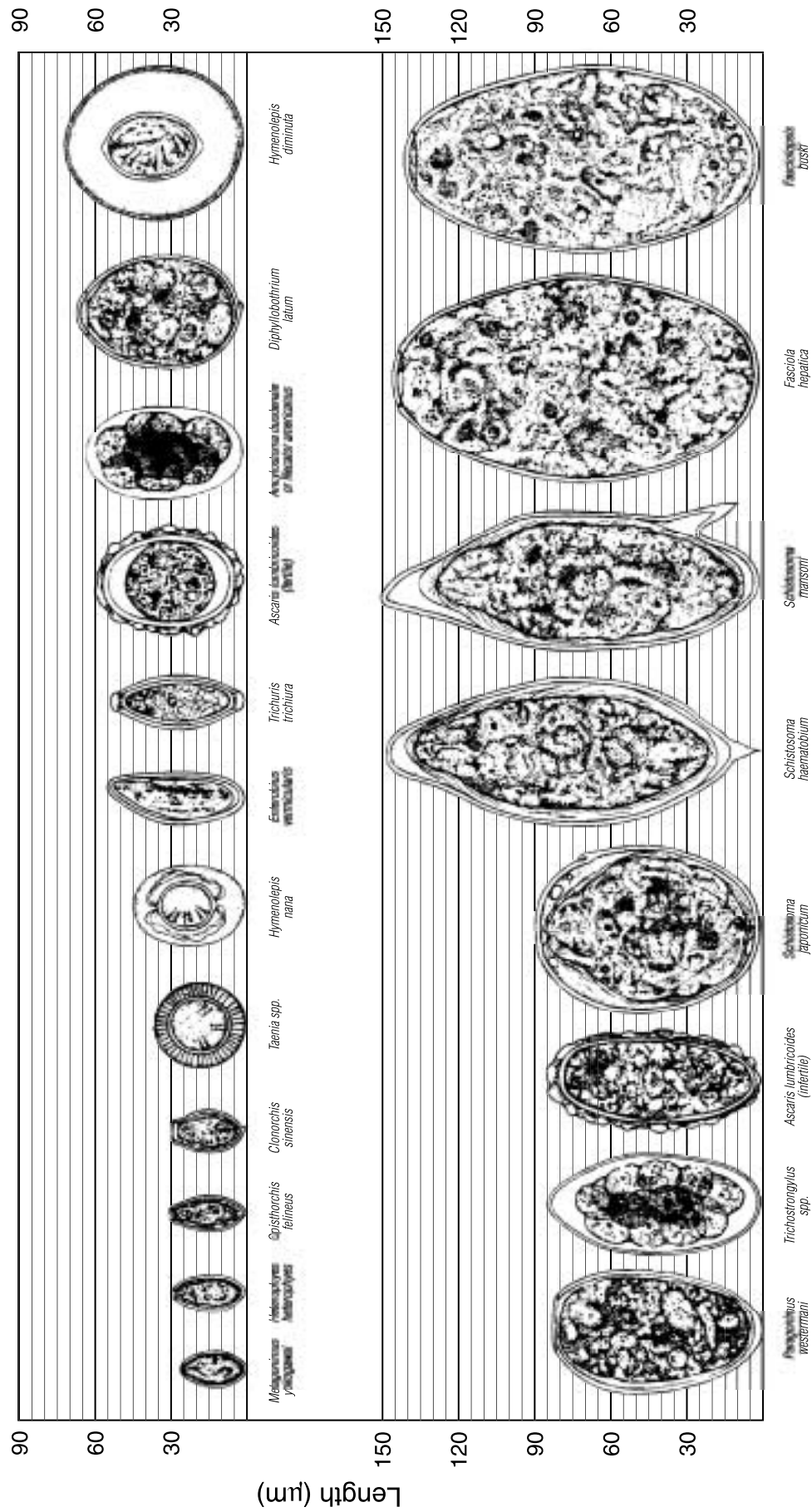

Fig. 4.41 Relative sizes of helminth eggs\*  
\*Schistosoma intercalatum and S. mekongi have been omitted.



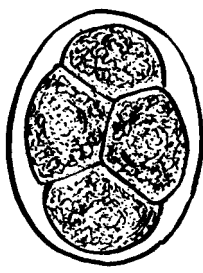

Fig. 4.42 *Ancylostoma duodenale* eggs in fresh stools

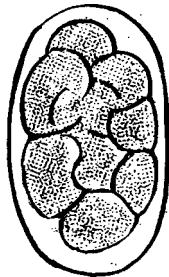

Fig. 4.43 *Ancylostoma duodenale* egg in stools a few hours old

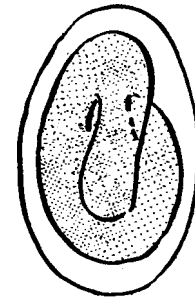
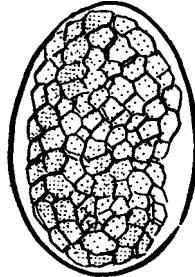

Fig. 4.44 *Ancylostoma duodenale* egg in stools 12–48 hours old

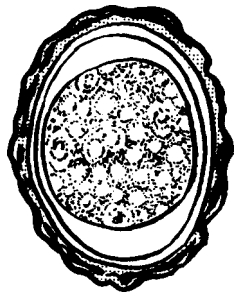

Fig. 4.45 Fertilized *Ascaris lumbricoides* egg with double shell

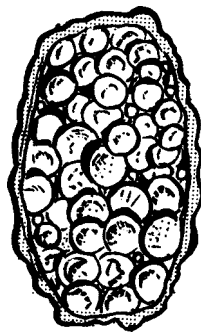

Fig. 4.46 Unfertilized *Ascaris lumbricoides* egg with double shell

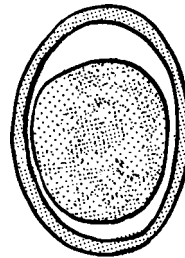

Fig. 4.47 Semi-decorticated fertilized *Ascaris lumbricoides* egg

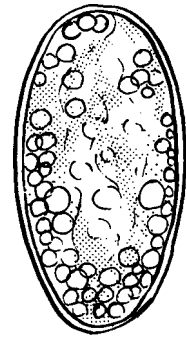

Fig. 4.48 Semi-decorticated unfertilized *Ascaris lumbricoides* egg

**Type B. Unfertilized egg with double shell** (Fig. 4.46)

**Size:** 45–90 μm (larger than type A).

**Shape:** more elongated than type A (elliptical or irregular).

**Shell:** the two shells are indistinct:

- the external shell is brown and puffy, with rather jagged lumps
- the internal shell is thin (one or two lines may be visible).

**Content:** the egg is full of large, round, very shiny granules.

**Type C. Semi-decorticated fertilized egg** (Fig. 4.47)

Similar to type A but without the external shell.

**Shell:** single, smooth, thick and colourless (or very pale yellow).

**Content:** a single round, colourless, granular central mass.

**Type D. Semi-decorticated unfertilized egg** (Fig. 4.48)

**Shell:** single, smooth, thin and colourless (double line).

**Content:** large, roundish, colourless, shiny granules.

**Caution:** Do not confuse type D with *Ancylostoma duodenale*, *Fasciola* spp. or *Fasciolopsis buski* eggs.

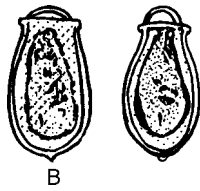

Fig. 4.49 *Clonorchis sinensis* eggs  
B: boss.

***Clonorchis sinensis*** (Fig. 4.49)

*Size:* 25–45  $\mu\text{m}$ .

*Shape:* distinctive.

*Shell:* fine and smooth but quite thick (double line).

*Operculum:* easily visible at the narrow end of the egg, fitting into a thickened rim of the shell.

*Boss:* a small knob at the wide end of the egg.

*Content:* a well-organized ciliated embryo.

*Colour:* shell — yellowish-brown, content — pale yellow.

***Dicrocoelium* spp.**

*Size:* 35–50  $\mu\text{m}$ .

*Shape:* oval, rather asymmetrical.

*Shell:* thick, smooth and yellow, orange or light brown.

*Operculum:* easily visible.

**Type A. Eggs in passage<sup>1</sup>** (form most often found; Fig. 4.50)

*Shell:* yellow, orange or light brown.

*Content:* an indistinct dark yellow oval mass, often with 1–4 shiny globules.

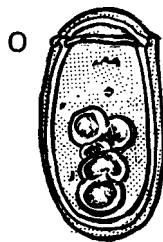

Fig. 4.50 *Dicrocoelium* sp. egg in passage  
O: operculum.

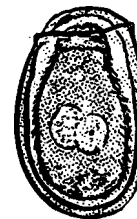

Fig. 4.51 *Dicrocoelium* sp. egg from infected patient

**Type B. Eggs from infected patient** (very rare; Fig. 4.51)

*Shell:* uniform dark brown.

*Content:* a ciliated embryo.

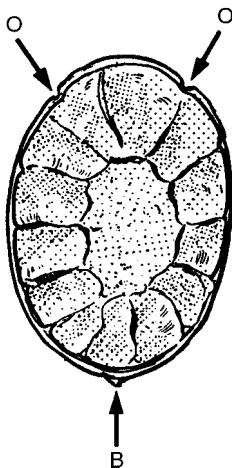

Fig. 4.52 *Diphyllobothrium latum* egg  
B: boss;  
O: operculum.

***Diphyllobothrium latum*** (Fig. 4.52)

*Size:* 55–80  $\mu\text{m}$ .

*Shape:* oval.

*Shell:* smooth and thick.

*Operculum:* scarcely visible when not raised.

*Boss:* very small, at the opposite end to the operculum.

*Content:* a mass of small cells around a large central cell.

*Colour:* pale yellow.

<sup>1</sup> Observed when the patient has eaten sheep or beef liver infected by the flukes. The eggs of the flukes are not digested and although they appear in the stools, the patient is not infected. Repeat the examination 8 days later. Tell the patient not to eat liver or liver products in the meantime.

***Dipylidium caninum*** (Fig. 4.53)

*Dipylidium caninum* eggs are found in clusters of 6–20 enclosed in a fine membrane.

**Size:** 30–40 µm (the cluster is 150–300 µm).

**Shape:** round.

**Shell:** thick and slightly granulated, without striations.

**Content:** a single uniform granular mass with three pairs of shiny hooklets arranged in the shape of a fan.

**Colour:** yellow or pale grey.

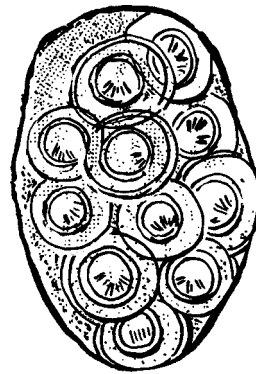

Fig. 4.53 *Dipylidium caninum* eggs

***Enterobius vermicularis*** (Fig. 4.54)

**Size:** 50–60 µm.

**Shape:** oval but clearly asymmetrical (flattened on one side, rounded on the other).

**Shell:** smooth and thin, but a double line is visible.

**Content:** either (a) a small, granular mass in the shape of an irregular oval, or (b) the embryo of the worm, a small curled-up larva.

**Colour:** colourless.

*E. vermicularis* eggs are usually more easily found in the folds of skin around the anus than in the faeces (see below).

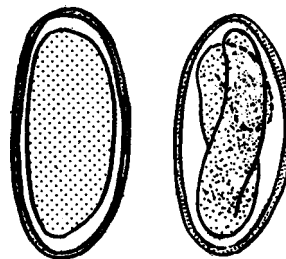

Fig. 4.54 *Enterobius vermicularis* eggs

**Technique for the collection and examination of eggs****Principle**

The eggs of *Enterobius vermicularis* (pinworm) are usually collected (particularly in children) from the folds of skin around the anus. They rarely appear in the stools.

**Materials and reagents**

- Microscope
- Microscope slides
- Test-tubes
- Pasteur pipette
- Adhesive cellophane tape
- Spoon 10 cm long or, better, a wooden tongue depressor
- Cotton wool
- Sodium chloride, 0.85% solution (reagent no. 53).

**Method<sup>1</sup>**

1. Place a strip of cellophane tape, sticky side down, on a slide, as shown in Fig. 4.55.
2. Place the spoon handle against the underside of the slide (Fig. 4.56).



who 01250

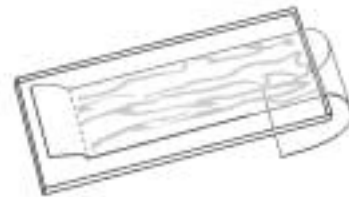

Fig. 4.55 Preparation of slide for collection of pinworm eggs



who 01251

Fig. 4.56 Positioning the spoon handle underneath the slide

<sup>1</sup>Based on Melvin D. Brooke M. *Laboratory procedures for the diagnosis of intestinal parasites*. Atlanta, GA, United States Department of Health, Education and Welfare, Centers for Disease Control, 1969:138.

3. Gently pull the tape away from the slide and loop it over the end of the spoon handle, as shown in Fig. 4.57.
4. Hold the completed tape swab in your right hand, pressing the slide firmly against the spoon.
5. Separate the patient's buttocks with your left hand. Press the end of the spoon covered with tape against the skin round the anus in several places (Fig. 4.58).
6. Take the slide and fold the tape back on to it, sticky side down (Fig. 4.59).
7. Make sure that the tape is firmly stuck flat to the slide by pressing it with a piece of cotton wool (Fig. 4.60).
8. Examine under the microscope with the condenser aperture reduced, using the  $\times 10$  objective. Look for eggs of *E. vermicularis* (see Fig. 4.54).

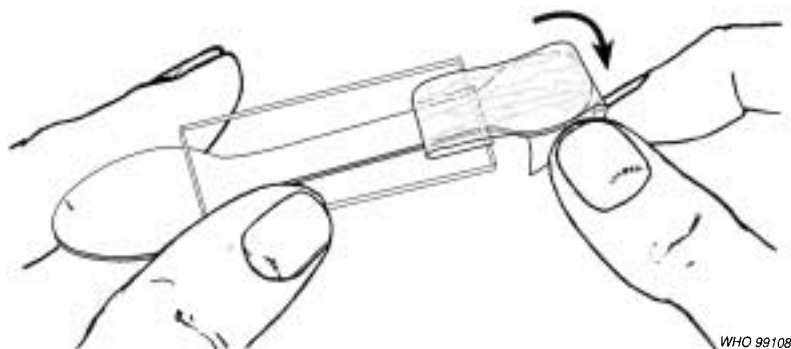

Fig. 4.57 Looping the tape over the end of the spoon handle



Fig. 4.58 Technique for collecting pinworm eggs from an infant



Fig. 4.59 Transferring the sample to the slide



Fig. 4.60 Making sure that the tape is firmly stuck to the slide



Fig. 4.62 Transferring the sample to a test-tube

Fig. 4.61 Alternative technique for collecting pinworm eggs from an infant

#### Alternative method

1. If no cellophane tape is available, use a cotton wool swab to wipe around (but not inside) the anus (Fig. 4.61).
2. Dip the swab into a test-tube containing about 0.5 ml (10 drops) of sodium chloride solution. Rinse the swab well in the solution (Fig. 4.62).
3. Draw up the liquid with a Pasteur pipette. Transfer it to a slide (Fig. 4.63), cover with a coverslip and examine under the microscope as described in step 8 above.



Fig. 4.63 Transferring the sample to a slide

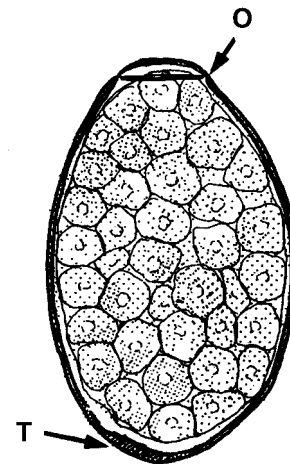

Fig. 4.64 *Fasciola hepatica* egg  
T: thickening; O: operculum.

***Fasciola hepatica*** (Fig. 4.64)

*Size:* 130–145  $\mu\text{m}$ .

*Shape:* oval with rounded poles.

*Shell:* smooth and fine with a double line.

*Content:* a mass of large indistinct cells with clear, granular nuclei (adjust the focus).

*Colour:* ranges from yellow to dark brown.

*Other features:* finely marked operculum at one pole; the cell wall may be visibly retracted. Thickening of a small part of the cell wall at the other pole.

Only small numbers of eggs are found in the stools (a search can be made by duodenal aspiration in doubtful cases).

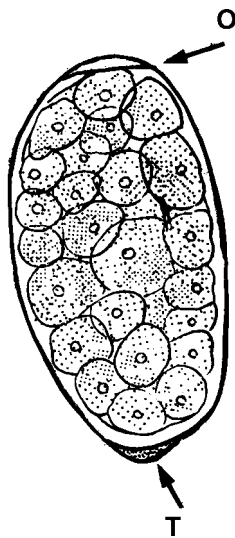

Fig. 4.65 *Fasciolopsis buski* egg  
T: thickening;  
O: operculum.

***Fasciolopsis buski*** (Fig. 4.65)

Very similar to the eggs of *Fasciola hepatica* (see Fig. 4.64), but usually present in greater numbers in the stools.

*Size:* 125–140  $\mu\text{m}$ .

*Shape:* oval.

*Shell:* thinner than *F. hepatica*, single line, with a marked thickening of the wall at the opposite pole to the operculum.

*Operculum:* slightly smaller than *F. hepatica*.

*Content:* cells may be shiny with one clear cell in the centre of the egg.

***Heterophyes heterophyes*** (Fig. 4.66)

Similar to the eggs of *Clonorchis sinensis* (see Fig. 4.49).

*Size:* 25–30  $\mu\text{m}$ .

*Shape:* more oval than *C. sinensis*; the operculum does not overlap.

*Shell:* slightly thicker than that of *C. sinensis*.

*Boss:* tiny and wart-shaped, at the wider end of the egg; not always visible.

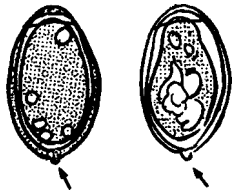

Fig. 4.66 *Heterophyes heterophyes* eggs



Fig. 4.67 *Hymenolepis diminuta* egg

**Content:** a mass of cells, sometimes with large shiny granules (unfertilized) or a ciliated embryo.

**Colour:** yellow to dark brown.

***Hymenolepis diminuta*** (Fig. 4.67)

Rare species (found in children's stools).

**Size:** 70–90  $\mu\text{m}$  (much larger than *H. nana*).

**Shape:** round.

**Shell:** external shell thin with transverse lines; internal shell very thick without filaments.

**Content:** a rounded embryo containing six hooklets arranged in fan shape.

**Colour:** transparent or pale yellow.

***Hymenolepis nana*** (Fig. 4.68)

**Size:** 40–60  $\mu\text{m}$ .

**Shape:** oval, almost round.

**Shell:** double; external membrane thin and internal membrane often thicker at the poles, with filaments coming away from both poles (reduce the intensity of the microscope light source to see them), mixed with granules occupying the space between the two membranes.

**Content:** rounded mass (embryo) with six shiny hooklets arranged in fan shape and often some well-defined granules in the centre.

**Colour:** very pale grey.

**Important:** Record whether there are many or few eggs present.

***Metagonimus yokogawai*** (Fig. 4.69)

Similar to the eggs of *Clonorchis sinensis* and *Heterophyes heterophyes* (see Figs. 4.49 and 4.66).

**Size:** 25–30  $\mu\text{m}$ .

**Shape:** oval, with no marked shouldering.

**Shell:** thicker than *C. sinensis* and *H. heterophyes*.

**Operculum:** more rounded than in *H. heterophyes*; overlapping less than in *C. sinensis*.

**Boss:** tiny or invisible, at the narrower end of the egg.

**Content:** a ciliated embryo.



Fig. 4.68 *Hymenolepis nana* egg

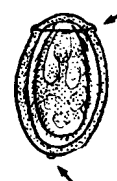

Fig. 4.69 *Metagonimus yokogawai* egg

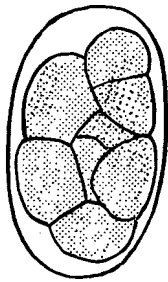

Fig. 4.70 *Necator americanus* egg

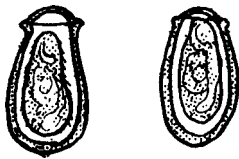

Fig. 4.71 *Opisthorchis felineus* eggs

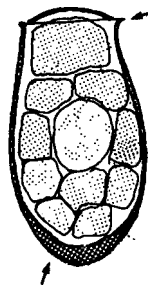

Fig. 4.72 *Paragonimus westermani* egg

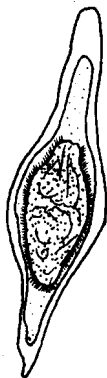

Fig. 4.73 *Schistosoma bovis* egg

***Necator americanus*** (Fig. 4.70)

Almost identical to the eggs of *Ancylostoma duodenale* (see Fig. 4.42).

*Size:* 60–80  $\mu\text{m}$  (slightly longer than *A. duodenale*).

*Shape:* oval with rounded flattened poles (more flattened than in *A. duodenale*).

*Content:* always contains at least eight cells (never four like *A. duodenale* in fresh stools).

***Opisthorchis felineus*** (Fig. 4.71)

Similar to the eggs of *Clonorchis sinensis* (see Fig. 4.49).

*Size:* 25–35  $\mu\text{m}$  (identical to *C. sinensis*).

*Shape:* slightly narrower at the base and with less shouldering than *C. sinensis*; some eggs are asymmetrical.

*Operculum:* less overlap than *C. sinensis*.

*Boss:* rarely visible.

*Content:* a ciliated embryo.

It is very difficult to differentiate between the eggs of *O. felineus*, *C. sinensis*, *Heterophyes heterophyes* and *Metagonimus yokogawai*:

- *O. felineus*: narrow, often asymmetrical, boss rarely visible.
- *C. sinensis*: squat shape, operculum with distinct overlap.
- *H. heterophyes*: squat shape, darker colour.
- *M. yokogawai*: thicker shell.

***Paragonimus westermani*** (Fig. 4.72)

Eggs mainly found in sputum (if swallowed they pass into the stools).

*Size:* 65–120  $\mu\text{m}$  (smaller than the eggs of *Fasciolopsis buski*).

*Shape:* oval, often slightly flattened on one side.

*Operculum:* quite distinct, with an obvious rim.

*Shell:* distinct thickening at the opposite end to the operculum.

*Content:* clear central space surrounded by squarish cells.

*Colour:* golden brown.

***Schistosoma bovis*** (Fig. 4.73)

Eggs found in the stools of patients who have eaten infected beef.

*Size:* about 200  $\mu\text{m}$ .

*Shape:* spindle-shaped, with narrowed extremities extending beyond the embryo.

*Spine:* long terminal spine.

*Content:* small round embryo lying in the centre of the egg but not filling it.

*S. bovis* does not cause disease in humans.

***Schistosoma haematobium*** (Fig. 4.74)

Eggs found in urine (for detection, see section 7.2.8) and occasionally in stools.

*Size:* 110–150  $\mu\text{m}$ .

*Shape:* oval, with one well-rounded pole.

*Spine:* terminal and situated at the other pole.



*Shell*: smooth, very thin.

*Content*: a well-formed broad ciliated embryo surrounded by a membrane (internal shell).

*Colour*: grey or pale yellow.

***Schistosoma intercalatum*** (Fig. 4.75)

Similar in appearance to *S. haematobium* (see Fig. 4.74), but found in stools.

*Size*: 140–180 µm (slightly larger than *S. haematobium*).

*Shape*: spindle-shaped; less broad than *S. haematobium* (sides particularly flattened towards the rounded pole).

*Spine*: terminal spine; longer and more tapered than *S. haematobium*.

*Content*: a ciliated embryo surrounded by a membrane with two depressions or indentations, one on each side near the middle.

***Schistosoma japonicum*** (Fig. 4.76)

*Size*: 70–100 µm.

*Shape*: oval, almost round.

*Spine*: difficult to see, lateral and very small; may be hidden by small granules often found on the surface of the egg.

*Content*: a broad ciliated embryo.

*Colour*: transparent or pale yellow.

***Schistosoma mansoni*** (Fig. 4.77)

*Size*: 110–180 µm.

*Shape*: oval, with one well-rounded pole and one conical pole.

*Spine*: lateral, near the rounded pole; large and triangular (if hidden underneath, adjust the focus of the microscope).

*Shell*: smooth, very thin.

*Content*: a broad ciliated embryo, surrounded by a membrane (internal shell) as in all *Schistosoma* spp.

*Colour*: pale yellow.

***Cellophane faecal thick-smear technique for diagnosis of Schistosoma mansoni infection (Kato–Katz technique)***

The Kato–Katz technique has proved to be an efficient means of diagnosing *S. mansoni* and certain other intestinal helminth infections. The slides can be prepared in the field, stored in microscope-slide boxes, and shipped great distances, for examination at a central laboratory if required. The technique is not suitable for diagnosing strongyloidiasis or infections with *Enterobius vermicularis* or protozoa.

**Materials and reagents**

- Flat-sided applicator stick, wooden
- Screen, stainless steel, nylon or plastic, 60–105 mesh
- Template, stainless steel, plastic or cardboard
- Microscope
- Microscope slides
- Cellophane, 40–50 µm thick, in strips 25 mm × 30 mm or 25 mm × 35 mm

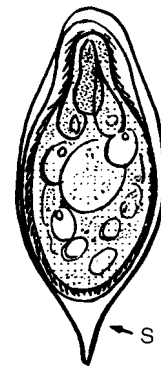

Fig. 4.74 *Schistosoma haematobium* egg  
S: spine.

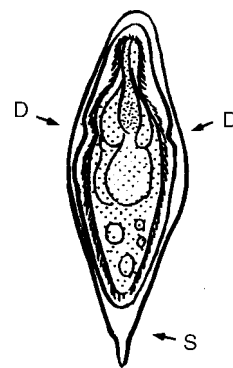

Fig. 4.75 *Schistosoma intercalatum* egg  
D: depression;  
S: spine.

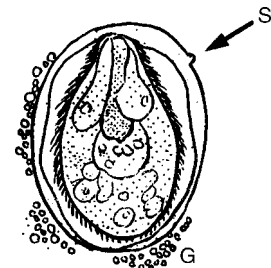

Fig. 4.76 *Schistosoma japonicum* egg  
G: granules;  
S: spine.

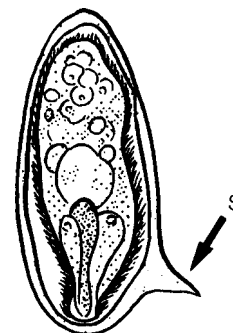

Fig. 4.77 *Schistosoma mansoni* egg  
S: spine.

- Flat-bottomed jar
- Forceps
- Toilet paper or absorbent tissue
- Scrap paper (e.g. newspaper)
- Glycerol–malachite green solution (reagent no. 31) or methylene blue solution (reagent no. 39).

#### Method

*Important:* Care must be taken to avoid contamination during collection of stool specimens. Always wear gloves.

1. Soak the cellophane strips in the glycerol–malachite green (or methylene blue) solution for at least 24 hours before use.
2. Transfer a small amount (approximately 0.5 g) of faeces on to a piece of scrap paper (newspaper is ideal).
3. Press the screen on top of the faecal sample.
4. Using the applicator stick, scrape across the upper surface of the screen to sieve the faecal sample (Fig. 4.78).
5. Place the template on a clean microscope slide. Transfer the sieved faecal material into the hole of the template and level with the applicator stick (Fig. 4.79).
6. Remove the template carefully so that all the faecal material is left on the slide and none is left sticking to the template.
7. Cover the faecal sample on the slide with a glycerol-soaked cellophane strip (Fig. 4.80).
8. If any glycerol is present on the upper surface of the cellophane, wipe it off with a small piece of absorbent tissue.
9. Invert the microscope slide and press the faecal sample against the cellophane on a smooth surface (a piece of tile or flat stone is ideal) to spread the sample evenly.

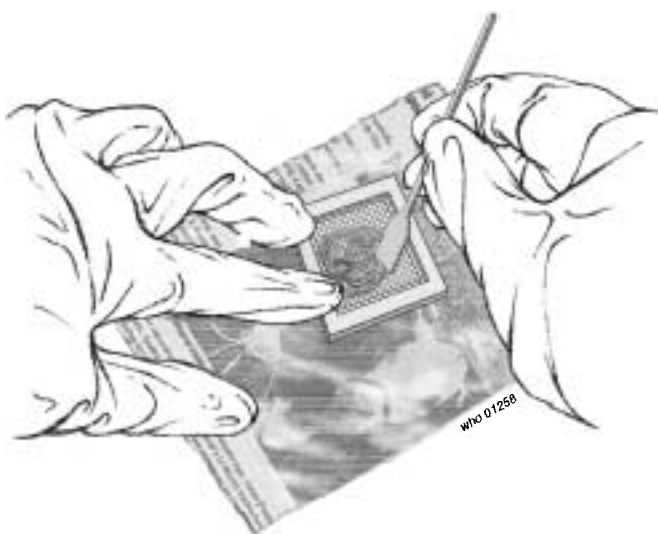

Fig. 4.78 Using an applicator stick, scrape across the upper surface of the screen to sieve the faecal sample

Fig. 4.79 Filling the template with the sieved faecal sample

10. Do not lift the slide straight up or it may separate from the cellophane. Gently slide the microscope slide sideways while holding the cellophane.

Preparation of the slide is now complete. Wipe off any excess glycerol with a piece of absorbent tissue to ensure that the cellophane stays fixed. With practice you can obtain perfect preparations.

#### ***Strongyloides stercoralis*** (Fig. 4.81)

*S. stercoralis* eggs are rarely seen in formed stools because they hatch before evacuation to produce larvae. They may, however, be found in liquid stools (and occasionally in the formed stools of carriers of certain strains).

*S. stercoralis* eggs are very similar to those of *Ancylostoma duodenale* (see Fig. 4.42).

**Size:** 50–80 µm (slightly smaller than *A. duodenale*).

**Shape:** oval with slightly flattened poles.

**Shell:** very thin; appears as a black line.

**Content:** a thick larva curved around itself one or more times and sometimes motile.

**Colour:** pale grey; dark brown after staining with iodine solution.

#### ***Taenia saginata* and *T. solium*** (Fig. 4.82(a))

The “eggs”<sup>1</sup> of these two tapeworms are practically identical. They may be found in stools and eggs of *T. saginata* can also be collected from the skin around the anus (see page 136).

**Size:** 30–80 µm.

**Shape:** round.

**Shell:** very thick, smooth, with transverse lines (reduce the illumination).

**Content:** a round granular mass enclosed by a fine membrane, with three pairs of shiny lancet-shaped hooklets (adjust the focus).

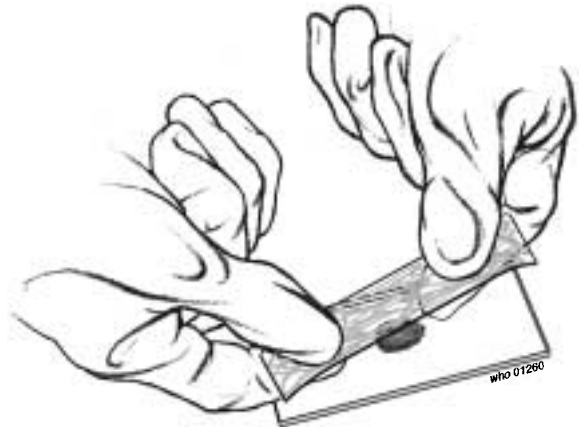

Fig. 4.80 Covering the faecal sample with a glycerol-soaked cellophane strip

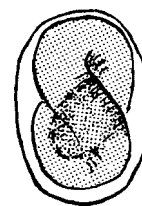

Fig. 4.81 *Strongyloides stercoralis* eggs

<sup>1</sup>The correct name for these “eggs” is “embryophores”, embryonated eggs that have lost their outer sac.

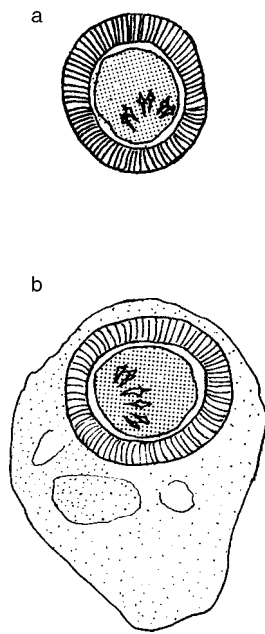

Fig. 4.82 *Taenia* spp. eggs  
a: Normal egg;  
b: egg enclosed  
in a floating  
transparent sac.

**Colour:** shell — dark yellowish-brown, content — light yellowish-grey.

**Other features:** sometimes the egg is enclosed in a floating transparent sac (Fig. 4.82(b)).

***Trichostrongylus* spp.** (Fig. 4.83)

Quite similar to eggs of *Ancylostoma duodenale* (see Fig. 4.42).

**Size:** 75–115  $\mu\text{m}$  (slightly larger than *A. duodenale*).

**Shape:** oval, asymmetrical, with one rounded pole and one narrower pole.

**Shell:** very thin and smooth (similar to *A. duodenale*).

**Content:** a mass of at least 20 small round granular cells (in fresh stools). The egg quickly develops into an embryo.

**Colour:** yellowish-brown.

***Trichuris trichiura*** (Fig. 4.84)

**Size:** 50–65  $\mu\text{m}$ .

**Shape:** barrel-shaped.

**Shell:** fairly thick and smooth, with two layers.

**Content:** a uniform granular mass (sometimes divided in old stools).

**Colour:** shell — orange; content — yellow.

**Other features:** a rounded, transparent plug at each pole.

**Important:** Specify whether there are many or few eggs present.

**Features not to be mistaken for eggs**

***Starch granules from plants*** (Fig. 4.85)

**Size:** 50–100  $\mu\text{m}$ .

**Shape:** round or oval and elongated.

**Shell:** thick in places, very irregular, with cracks.

**Content:** masses of starch packed closely.

**Colour:** whitish or greyish-yellow; violet after staining with iodine solution.

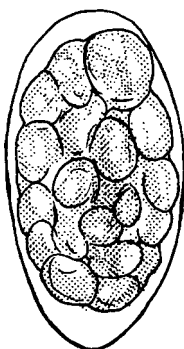

Fig. 4.83 *Trichostrongylus*  
sp. eggs



Fig. 4.84 *Trichuris trichiura*  
egg

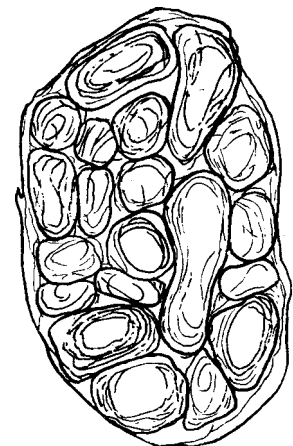

Fig. 4.85 Starch granules  
from plants

These granules are the residue of starchy foods such as potatoes, beans, yams and cassava.

**Digested meat fibres** (Fig. 4.86)

*Size:* 100–200  $\mu\text{m}$ .

*Shape:* oval or rectangular with rounded corners.

*Content:* transparent with no granulations or lines (or residual lines where meat is not properly digested).

*Colour:* yellow.

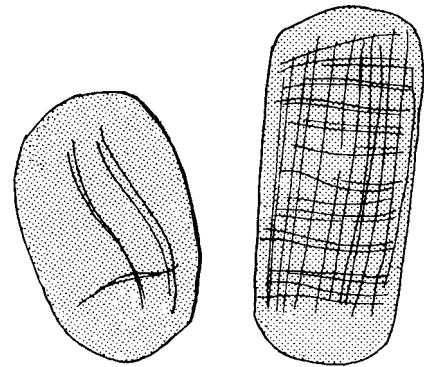

Fig. 4.86 Digested meat fibres

**Soaps** (Fig. 4.87)

*Size:* 20–100  $\mu\text{m}$ .

*Shape:* round, oval or irregular (like a section of a tree trunk).

*Content:* lines radiating from the centre and visible near the rim; nothing in the centre.

*Colour:* brownish-yellow or colourless.

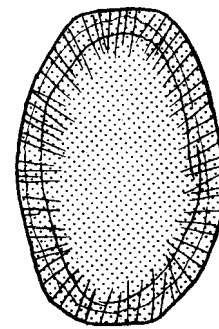

Fig. 4.87 Soap

**Air bubbles and oil droplets** (Figs. 4.88 and 4.89)

*Size:* variable (can be any size).

*Shape:* perfectly round.

*False shell:* a circular ring, very shiny (several layers in the case of oil).

*Content:* none.

**Plant hairs** (Fig. 4.90)

*Size:* very variable (50–300  $\mu\text{m}$ ).

*Shape:* rather rigid, often curved; wide and clean-cut at one end, tapered at the other.

*Content:* a narrow empty central canal between two transparent shiny layers.

*Colour:* pale yellow.

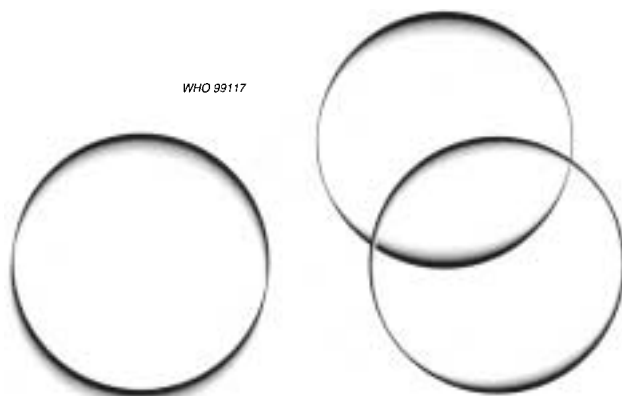

Fig. 4.88 Air bubbles



Fig. 4.89 Oil droplets

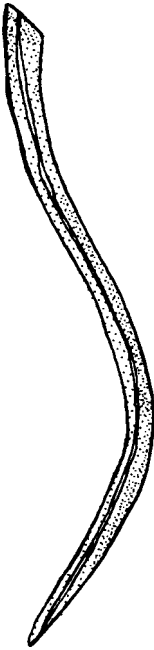

Fig. 4.90 Plant hairs

**Pollen grains and fungus spores** (Fig. 4.91)

*Size:* very variable, depending on the geographical area and the local diet.

*Shape:* distinctive geometrical shapes.

*Other features:* distinctive saw-like or rounded projections, etc.

**4.4.2 Identification of adult helminths**

Adult helminths brought to the laboratory for identification may have been found in stools, in clothing or bed linen, or during a surgical operation.

What to examine:

- their length
- their shape
- whether they are flat or segmented
- whether they are cylindrical (round)
- their internal structure.

**Common helminths*****Ascaris lumbricoides* (roundworm)** (Fig. 4.92)

*Length:* male — about 15 cm, with a curved tail; female — 20–25 cm, with a straight tail.

*Colour:* pinkish.

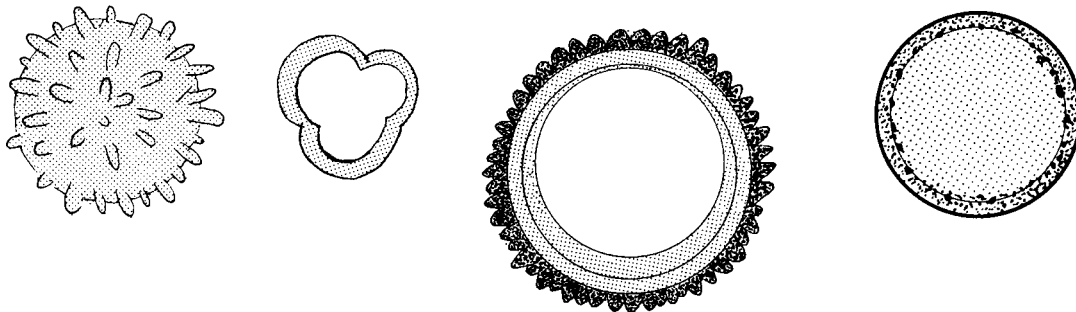

Fig. 4.91 Pollen grains and fungus spores

***Enterobius vermicularis* (pinworm or threadworm)** (Fig. 4.93)

*Length:* male — 0.5 cm; female — 1 cm, with a very pointed tail (males are less common).

*Colour:* white.

Pinworms or threadworms are found in large numbers, especially in children's stools, and are motile. They may also be found in the folds of skin around the anus, where they can be collected with a strip of adhesive cellophane (see section 4.4.1, page 135).

***Taenia saginata* (beef tapeworm) and *T. solium* (pork tapeworm)**

*Length:* total worm, 3–10 m, but single mature segments (1–3 cm long) or fragments of the chain (variable in length) are usually presented for examination.

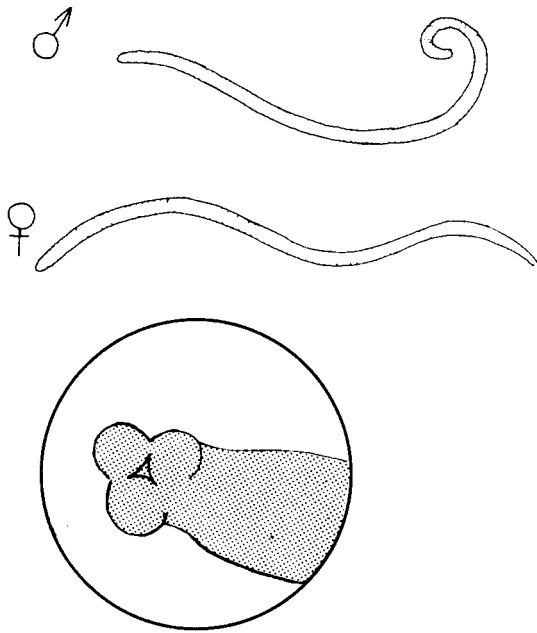
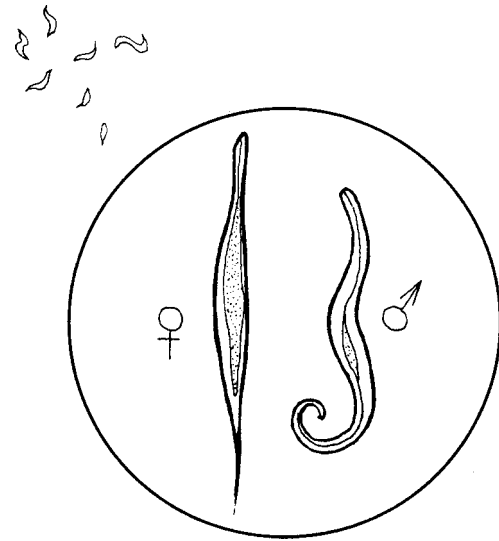
Fig. 4.92 Adult *Ascaris lumbricoides* (roundworm)Fig. 4.93 Adult *Enterobius vermicularis* (pinworm or threadworm)

**Colour:** ivory white (*T. saginata*) or pale blue (*T. solium*).

**Important:** If there is a delay in examination, separate pieces may dry out and roll up, making them look like roundworms. Moisten them with water to restore their shape.

### Examination

Materials and reagents

- Microscope or magnifying glass
- Microscope slides
- Petri dish
- Forceps.

Method

- Examine a chain of segments to observe the arrangement of the lateral pores (Fig. 4.94).
- Examine a single segment gently flattened between two slides (Fig. 4.95).

Hold the slide against the light to observe and count the uterine branches with the naked eye.

To examine the head (scolex):

1. Place the whole worm in a Petri dish (or on a plate) filled with water.
2. Using forceps, transfer the worm little by little into another dish (Fig. 4.96); untangle it, starting with the thicker end.
3. If at the end of a very narrow section (the neck) you find a swelling the size of a small pinhead, examine it under the microscope with the  $\times 10$  objective or with a magnifying glass. (The head is rarely found.)

Fig. 4.94 Segments of adult *Taenia* spp.

Fig. 4.95 Flattening a segment between two slides



Fig. 4.96 Using forceps to transfer a tapeworm

Figure 4.97 shows how to differentiate between *T. saginata* and *T. solium* and two less common tapeworms, *Hymenolepis nana* and *Dipylidium caninum*.

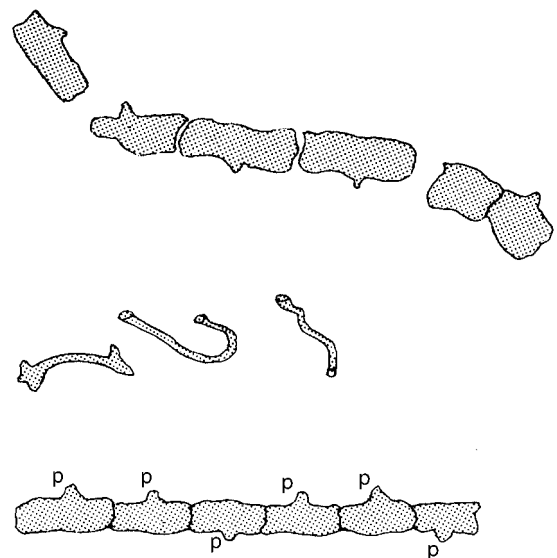
#### Other helminths found in stools

The helminths described below are rarely found in the stools. They are, however, occasionally found in a patient's organs during a surgical operation. Flukes are seen in the liver and intestines and hydatid cysts are observed in the liver and lungs.

#### *Ancylostoma duodenale* and *Necator americanus* (hookworm) (Fig. 4.98)

A roundworm (resembles a piece of thread) similar to *E. vermicularis* (see Fig. 4.93).

*Length:* 1.0–1.5 cm.

*Colour:* white, or red if it contains blood.

Examine the head (scolex) under the microscope with the  $\times 10$  objective.



Fig. 4.97 Features for the identification of tapeworms

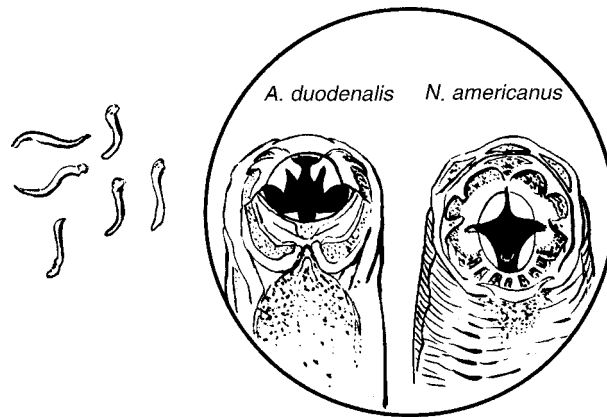

Fig. 4.98 Adult *Ancylostoma duodenale* and *Necator americanus* (hookworm)

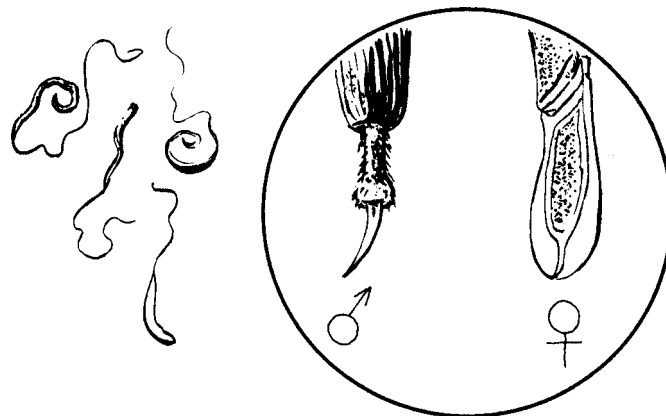

Fig. 4.99 Adult *Trichuris trichiura* (whipworm)

***Trichuris trichiura* (whipworm)** (Fig. 4.99)

A small thin worm that lives in the wall of the caecum or occasionally the rectum.

*Length:* 3–5 cm.

*Colour:* white.

**Flukes** (Fig. 4.100)

A flatworm with two suckers; it looks like a leaf.

Large fluke

*Length:* 2–3 cm.

*Width:* fairly broad.

*Colour:* reddish-brown or dull white.

Small fluke

*Length:* 0.5–1.0 cm.

*Width:* narrow.

*Colour:* transparent, greyish-red.

***Schistosoma spp.* (blood flukes)** (Fig. 4.101)

A small thin flatworm.

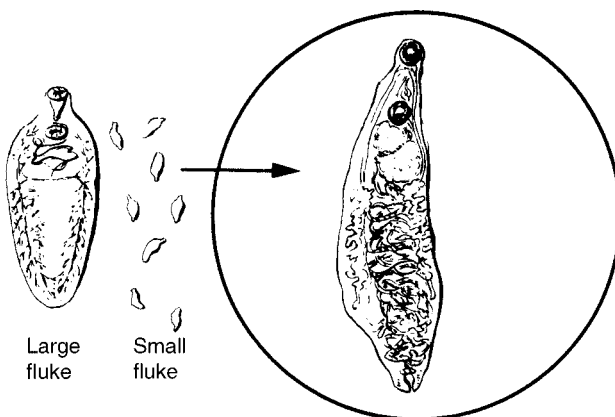

Fig. 4.100 Flukes

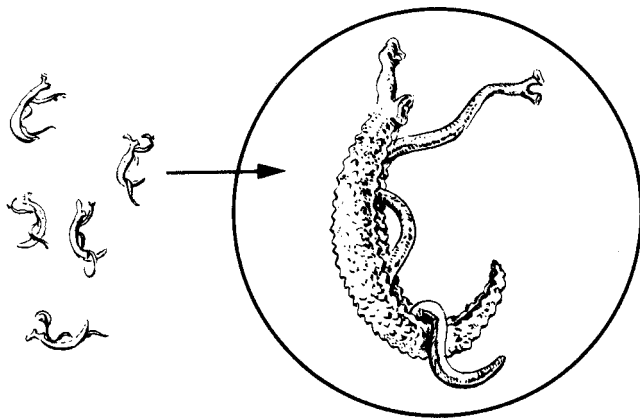

Fig. 4.101 Schistosomes

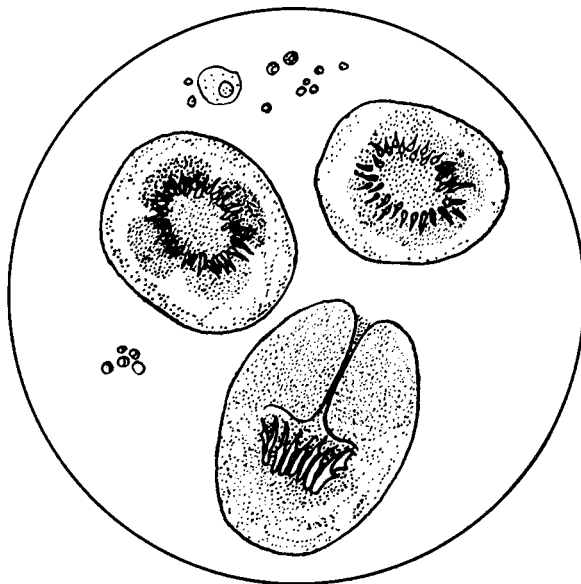

Fig. 4.102 Hydatid cysts

*Length:* 0.5–1.5 cm.

*Colour:* white.

The flat male is rolled around the thread-like female, which is slightly longer. Each schistosome has two suckers near the head.

#### *Echinococcus granulosus* (hydatid cyst)

*Echinococcus granulosus* worms are found in dogs. The worms are 3–6 mm long. Humans and livestock may become infected by accidental ingestion of the eggs, which then develop into hydatid cysts in the liver or lungs (Fig. 4.102).

*Size:* about 150 μm.

*Shape:* round, irregular or oval, with one pole slightly flattened.

*Content:* fine granules and a distinct ring of 10–30 hooklets.

*Colour:* colourless and transparent.

Hydatid disease occurs preferentially in areas where sheep are bred, such as East and North Africa, South America, the Arabian peninsula, Australia and New Zealand.

### *Diphyllobothrium latum* (fish tapeworm)

*Diphyllobothrium latum* is found mainly in cold climates. Infection occurs through eating raw or inadequately cooked fish and can result in intestinal obstruction, anaemia, pain and weight loss.

*Length:* up to 20 m.

## 4.5 Techniques for concentrating parasites

Concentration techniques are used when the number of helminthic ova or larvae, or protozoal cysts or trophozoites, is small. Four different concentration techniques are described in this book:

- the flotation technique using sodium chloride solution (Willis)
- the formaldehyde–ether sedimentation technique (Allen & Ridley)
- the formaldehyde–detergent sedimentation technique
- the sedimentation technique for larvae of *Strongyloides stercoralis* (Harada–Mori).

*Important:* Always make a direct microscopic examination of stools before preparing a concentration. (Motile forms of protozoa are not found in concentrated preparations.)

### 4.5.1 Flotation technique using sodium chloride solution (Willis)

This method is recommended for the detection of eggs of *Ancylostoma duodenale* and *Necator americanus* (best method), *Ascaris lumbricoides*, *Hymenolepis nana*, *Taenia* spp. and *Trichuris trichiura*.

It is not suitable for the detection of eggs of flukes and *Schistosoma* spp., larvae of *Strongyloides stercoralis*, or protozoal cysts or trophozoites.

#### Principle

The stool sample is mixed with a saturated solution of sodium chloride (increasing the specific gravity). The eggs are lighter in weight and float to the surface where they can be collected (Fig. 4.103).

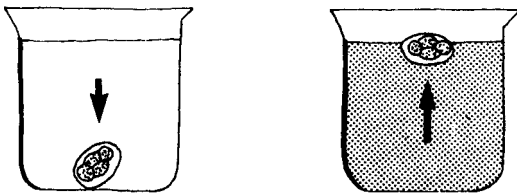

Fig. 4.103 Principle of the flotation technique

#### Materials and reagents

- Microscope
- Microscope slides
- Coverslips
- Wide-mouth bottle, 10 ml
- Wooden applicators
- Gauze
- Petri dishes
- 95% Ethanol
- Ether
- Willis solution (reagent no. 64)
- Petroleum jelly
- Wax.

## Method

### *Preparation of grease-free coverslips*

1. Mix in a cylinder: 10 ml of 95% ethanol and 10 ml of ether.
2. Pour into a Petri dish and in it place 30 coverslips, one by one; shake and leave for 10 minutes.
3. Take the coverslips out one by one and dry them with gauze.
4. Keep them in a dry Petri dish.

The above steps are summarized in Fig. 4.104.

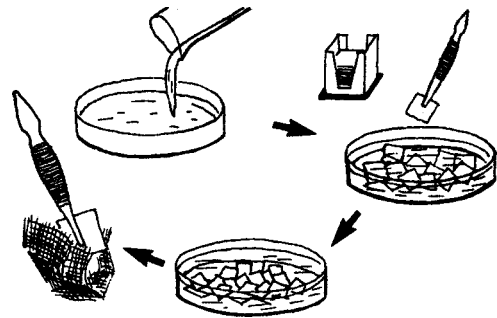

Fig. 4.104 Preparation of grease-free coverslips

### *Concentration of parasites*

1. Place approximately 0.5 g of stool in a wide-mouth bottle. Fill the bottle to the 2.5-ml mark with Willis solution.
2. Using an applicator, crush the portion of stool and mix it well with the solution. Then fill the bottle to the top with Willis solution; the suspension should be completely uniform.
3. Place a coverslip carefully over the mouth of the bottle.
4. Check that the coverslip is in contact with the liquid, with no air bubbles. Leave for 10 minutes.
5. Remove the coverslip with care; a drop of liquid should remain on it. Place the coverslip on a slide and examine under the microscope (using the  $\times 10$  objective) at once because the preparation dries very quickly. Otherwise seal the coverslip with petroleum jelly and wax.

Use the fine adjustment of the microscope to examine every object in the field (eggs tend to stick to the coverslip and are not immediately distinct).

## 4.5.2 Formaldehyde–ether sedimentation technique (Allen & Ridley)

### Principle

The stool specimen is treated with formaldehyde, which preserves any parasites present. Lumpy residues are removed by filtration. Fatty elements of the faecal suspension are separated by extraction with ether (or ethyl acetate), followed by centrifugation, which sediments any parasites present.

### Materials and reagents

- Microscope
- Microscope slides
- Coverslips
- Centrifuge
- Test-tubes
- Test-tube rack
- Centrifuge tubes
- Wooden applicators
- Brass wire filter, 40 mesh (425  $\mu\text{m}$ ), 7.2 cm diameter (nylon coffee strainers provide an inexpensive alternative)
- Small porcelain or stainless steel dish or beaker
- Pasteur pipette

- Formalin, 10% solution (100 ml of formaldehyde, 37% solution in 900 ml of distilled water)
- Ether (or ethyl acetate).

### Method

1. Using a wooden applicator, remove a small amount (approximately 0.5 g) of faeces from both the surface and the inside of the stool specimen.
2. Place the sample in a centrifuge tube containing 7 ml of 10% formalin.
3. Emulsify the faeces in the formalin and filter into the dish.
4. Wash the filter (with soapy water) and discard the lumpy residue.
5. Transfer the filtrate to a large test-tube. Add 3 ml of ether (or ethyl acetate).
6. Stopper the tube and mix well.
7. Transfer the resulting suspension back to the centrifuge tube and centrifuge at 2000 *g* for 1 minute.
8. Loosen the fatty plug with an applicator and pour the supernatant away by quickly inverting the tube (Fig. 4.105).
9. Allow the fluid remaining on the sides of the tube to drain on to the deposit and then mix well. Using the pipette, transfer a drop on to the slide and cover with a coverslip.
10. Use the  $\times 10$  and  $\times 40$  objectives to examine the whole of the coverslip for ova and cysts.

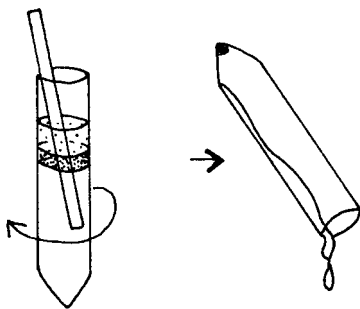

Fig. 4.105 After centrifuging the suspension, loosen the fatty plug and discard the supernatant

It is now common practice to perform all the above steps in a biological safety cabinet. If the extraction system of the cabinet is not fireproof, the steps involving ether should be done outside the cabinet. Ethyl acetate provides a less flammable alternative to ether.

### 4.5.3 Formaldehyde–detergent sedimentation technique

#### Principle

The formaldehyde–detergent sedimentation technique is an inexpensive, safe and simple quantitative sedimentation method in which a measured amount of faeces is mixed in formaldehyde–detergent solution of low specific gravity. The suspension is sieved and is then left undisturbed to allow the ova to sediment under their own weight. The detergent “clears” the faecal debris in a short time. Following sedimentation and clearing, the small amount of fine sediment which forms is examined under the microscope for ova and the eggs are counted to give a quantitative result.

#### Materials and reagents

- Microscope
- Microscope slides
- Commercial test kit, consisting of a conical-based container, a plastic strainer, a Pasteur pipette, a beaker and a commercial detergent, diluted 1:50 with distilled water
- Formalin, 2% solution (prepared by diluting formaldehyde, 37% solution 1:50 with distilled water).

#### Method

Details of the method as supplied with the kit are as follows:

1. Fill the conical-based container to the 10-ml mark with 2% detergent in 2% formalin.

2. Using the spoon attached to the lid of the container, transfer approximately 350 mg of faeces to the container and mix well in the formaldehyde–detergent solution.
3. Using the plastic strainer, strain the suspension into the beaker supplied with the kit (Fig. 4.106). Rinse the container and then add the filtrate.
4. Stand the container upright in the rack provided and leave for 1 hour (do not centrifuge). Under field conditions, the emulsified faeces can be transported back to the laboratory for examination. The schistosome eggs are fixed and will not become distorted.
5. Carefully remove and discard the supernatant fluid, taking care not to disturb the sediment which has formed in the base of the container (Fig. 4.107).
6. Add 10 ml of the formaldehyde–detergent solution; mix and allow to sediment for a further 1 hour. Further clearing of the faecal debris will take place.
7. Remove and discard the supernatant fluid, leaving approximately 0.5 ml of fine sediment.
8. Using the Pasteur pipette, transfer the entire sediment to a slide and cover with a 22 mm × 40 mm coverslip (supplied with the kit) (Fig. 4.108).
9. Examine the entire preparation under the microscope, using the ×10 objective with the condenser iris closed sufficiently to give good contrast.

Count all the ova present and multiply the number by 3 to give the approximate number per gram of faeces.

*Note:* If the supernatant fluid is not removed after 1 hour, but instead a further 10 ml of reagent is added and the suspension is remixed and allowed to sediment overnight, ova, cysts and larvae of other parasites will be sedimented. The technique is of particular value in laboratories without the facilities to perform the



Fig. 4.106 Straining the suspension



Fig. 4.107 Removing the supernatant



Fig. 4.108 Transferring the sediment to a slide

formaldehyde–ether sedimentation technique. The formalin preserves the parasites without distorting their morphology.

#### 4.5.4 Sedimentation technique for larvae of *Strongyloides stercoralis* (Harada–Mori)

##### Principle

A strip of filter-paper is partially submerged in a test-tube containing water. Any larvae of *Strongyloides stercoralis* present in the specimen migrate against the current of water that rises by capillary action and accumulate at the bottom of the tube.

##### Materials and reagents

- Microscope
- Cellophane tape
- Test-tubes
- Test-tube rack
- Strips of filter-paper (30 mm × 150 mm)
- Spatula
- Lugol iodine, 0.5% solution (reagent no. 37).

##### Method

1. Use the spatula to spread a small quantity of the faecal specimen along a strip of filter-paper (previously folded lengthwise to keep it straight), but leave the last 4 or 5 cm clean to be put into water.
2. Put the strip of filter-paper, clean end first, into a test-tube containing filtered or boiled water 2.5–3.0 cm deep; fold the strip at the top so that the bottom does not touch the bottom of the tube.
3. Record the serial number or name of the patient indelibly on the tube.
4. Plug the tube with cotton wool or, preferably, seal with cellophane tape and keep for 7–8 days at room temperature.
5. Look for the larvae at the bottom of the tube. Stain with iodine solution for 1 minute and then examine under the microscope, using the ×10 objective.

The larvae usually seen in fresh stool specimens are the rhabditiform (first-stage) larvae of *S. stercoralis*. However, if the stool was passed more than 12 hours earlier, the larvae may have hatched into filariform (infective-stage) larvae. These must be



differentiated from larvae of *Ancylostoma duodenale* and *Necator americanus* (hookworm), which may also hatch in stools 12–24 hours after passage. The appearance of filariform larvae of *S. stercoralis* may indicate a systemic hyperinfection.

The genital primordium will be more visible in preparations stained with iodine. The iodine kills the larvae and makes the features easier to see. You will need to use the  $\times 40$  objective to see these structures.

- If you see a larva with a short mouth opening and a prominent (clearly visible) genital primordium, it is *S. stercoralis*.
- If you see a larva with a long mouth opening and do not see a genital primordium, it is *A. duodenale* or *N. americanus*.

The main distinguishing features of *S. stercoralis* and *A. duodenale* or *N. americanus* larvae are summarized in Table 4.6 and illustrated in Fig. 4.109.

#### 4.6 Chemical test for occult blood in stools

This test is used for screening for parasitic infection, for example intestinal schistosomiasis, or for detection of bleeding in the intestine caused by polyps, tumours or inflammation. It was originally developed using benzidine. However, the use of benzidine is no longer recommended because it has been shown to be carcinogenic.

*Note:* For 1 day before the examination, the patient should not:

- eat any meat;
- take any drugs containing iron compounds;
- brush his or her teeth vigorously.

##### 4.6.1 Principle

Oxygen is produced when the haemoglobin in blood comes into contact with hydrogen peroxide. The liberated oxygen reacts with aminopyrine (aminophenazone) to yield a blue colour.

##### 4.6.2 Materials and reagents

- Centrifuge
- Conical centrifuge tube

**Table 4.6 Characteristics of larvae of *Strongyloides stercoralis* and *Ancylostoma duodenale* or *Necator americanus***

Larval stage	<i>S. stercoralis</i>	<i>A. duodenale</i> or <i>N. americanus</i>
Rhabditiform	Buccal cavity short (4 $\mu\text{m}$ )	Buccal cavity long (15 $\mu\text{m}$ )
	Oesophagus one-third of body length with 2 swellings	Oesophagus one-third of body length with 2 swellings
	Genital primordium large (22 $\mu\text{m}$ )	Genital primordium small (7 $\mu\text{m}$ )
	Anal pore 50 $\mu\text{m}$ from posterior end	Anal pore 80 $\mu\text{m}$ from posterior end
Filariform	Size 200–500 $\mu\text{m}$ $\times$ 15–20 $\mu\text{m}$	Size 200–500 $\mu\text{m}$ $\times$ 14–20 $\mu\text{m}$
	Unsheathed	Sheathed
	Tail forked or blunt	Tail tapered
	Oesophagus half of body length with no swelling	Oesophagus one-third of body length with no swelling

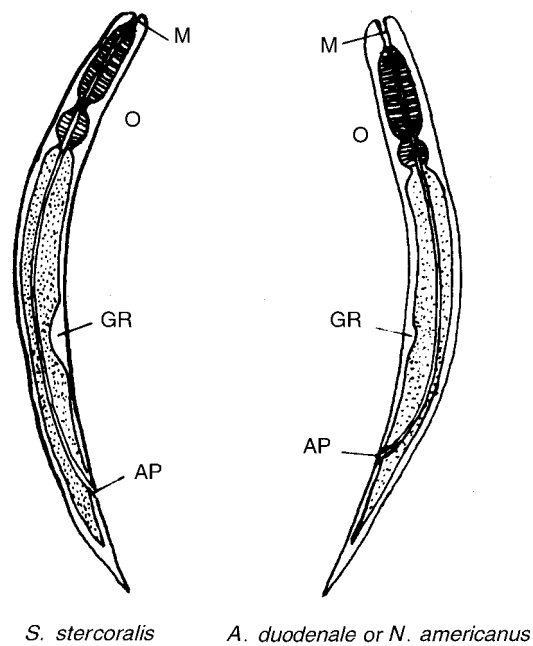

Fig. 4.109 Features for the identification of larvae of *Strongyloides stercoralis* and *Ancylostoma duodenale* or *Necator americanus*  
M: mouth; O: oesophagus; GR: genital rudiment; AP: anal pore.

- Applicators
- Measuring cylinder, 20 ml
- Test-tubes
- Test-tube rack
- Positive control tube (containing a 1% solution of blood in water)
- Negative control tube (containing distilled water)
- Acetic acid, 10% solution (reagent no. 2)
- Hydrogen peroxide (fresh 10% solution)
- 95% Ethanol
- Aminopyrine, crystalline.

*Note:* The glassware used for the test must be clean, with no traces of blood (see section 3.5.1).

#### 4.6.3 Method

1. Immediately before carrying out the test, prepare a solution of aminopyrine:
  - put about 0.25 g of aminopyrine in the bottom of a test-tube
  - add 5 ml of 95% ethanol.
2. Put a portion of stool (approximately 4 ml) in a centrifuge tube. Add 7 ml of distilled water and mix thoroughly (Fig. 4.110).
3. Centrifuge at low speed (1000g) for about 5 minutes, or until the solids are precipitated (a hand-operated centrifuge can be used).
4. Decant the supernatant fluid into another test-tube and keep it.

5. Add to the test-tube containing the supernatant fluid, without mixing:
  - 10 drops of 10% acetic acid solution
  - 5 ml of the aminopyrine solution.

To prevent mixing, hold the tip of the pipette containing the aminopyrine solution against the inside wall of the test-tube and allow the liquid to run down the wall.

6. Add 10 drops of the 10% hydrogen peroxide solution. Do not mix. Let it stand for 1 minute.

The results must be read within 5 minutes of adding the hydrogen peroxide solution.

#### 4.6.4 Results

If the reaction is positive a red colour appears between the two layers of liquid (Fig. 4.111). Report the results as follows:

- pale red = positive reaction (+)
- red = strong positive reaction (++)
- dark red = very strong positive reaction (+++)
- no change in colour = negative reaction (-).

### 4.7 Parasites of the blood and skin

Parasites that spend all or part of their life cycle in blood or tissue are known as haemoparasites. They include:

- species belonging to the genera *Brugia*, *Diriofilaria*, *Loa*, *Mansonella*, *Meningonema*, *Onchocerca* and *Wuchereria* — responsible for filariasis;
- *Trypanosoma* spp. — responsible for trypanosomiasis;
- *Plasmodium* spp. — responsible for malaria.

Infection by these parasites and *Borrelia* spp. can be diagnosed by examination of stained blood specimens under the microscope.

#### 4.7.1 Filariae

There are many species of filariae, but most are parasites of animals and rarely affect humans. Only eight filarial species have adapted to humans, and are transmissible between them. Of these, the most important is subperiodic *Brugia malayi*.

The filarial worms inhabit the lymphatic system. The larvae of the adult worms — the microfilariae — invade the blood, and they can be identified in a blood film. The microfilariae of *Onchocerca volvulus* are normally confined to the skin (see below), but sometimes migrate to the eyes (which may result in blindness); they may also be found in the blood. The main clinical symptoms of lymphatic filariasis are lymphadenopathy and lymphangitis. Attacks of lymphadenopathy lasting several days occur at regular intervals, with headache, nausea, swelling of one leg, hydrocoele and sterile abscesses. In advanced cases, elephantiasis of the lower extremities may occur due to obstruction of the lymphatic circulation. Elephantiasis of the scrotum, such as is seen in bancroftian filariasis (caused by *Wuchereria bancrofti*), is rare in brugian filariasis (caused by *Brugia malayi*). Infections among populations in regions where bancroftian and brugian filariasis are endemic may remain asymptomatic.

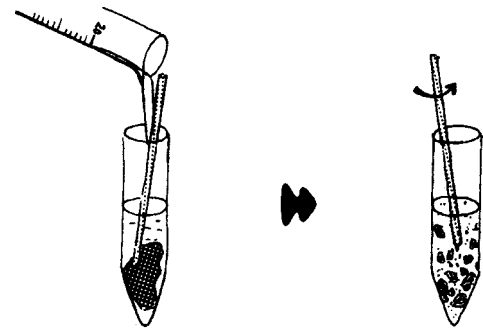

Fig. 4.110 Mixing the stool specimen with distilled water

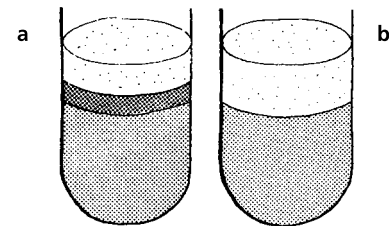

Fig. 4.111 Chemical test for occult blood in stools  
a: Positive reaction; b: negative reaction.

Microfilariae of the following species are found in human blood: *Brugia malayi*, *Brugia timori*, *Loa loa*, *Mansonella perstans*,<sup>1</sup> *Mansonella ozzardi* and *Wuchereria bancrofti*. Table 4.7 shows the geographical distribution of these species.

Infections with *Loa loa* among populations of areas where it is endemic are often asymptomatic. Non-residents visiting these areas are susceptible to symptomatic infection. The initial infection is characterized by a transient, localized, subcutaneous swelling, known as a “Calabar swelling”. Adult worms may migrate across the conjunctiva of the eyes, causing inflammation, but the infection does not cause blindness. Chronic infection may lead to complications such as renal disease, encephalopathy and cardiomyopathy.

Infections with *Mansonella perstans* generally seem to be asymptomatic, but have been associated with pruritus, abdominal pain, urticaria and Calabar-like swellings (see above). Infections with *Mansonella ozzardi* are also generally asymptomatic, but have been associated with lymphadenopathy, pruritus, fever, and pains in the knees and ankles.

Microfilariae are transmitted by mosquitoes, flies and midges, which feed on the blood of infected humans. The microfilariae develop into infective larvae which invade the mouth parts of the insect.

#### Examination of skin for microfilariae of *Onchocerca volvulus*

A very small piece of the patient’s skin is collected. To see the highly motile microfilariae, it is examined as a wet preparation between a slide and coverslip under the microscope.

#### Materials and reagents

- Microscope
- Microscope slides
- Coverslips
- Pasteur pipette
- Needle (for intramuscular or subcutaneous injection), 22-gauge
- Scalpel or razor blade
- Sodium chloride, 0.85% solution (reagent no. 53)
- 70% Ethanol.

**Table 4.7 Geographical distribution of filarial worms**

Species	Geographical distribution
<i>Brugia malayi</i>	Asia
<i>Brugia timori</i>	Parts of Indonesia
<i>Loa loa</i>	Central and West Africa
<i>Mansonella ozzardi</i>	Central and South America, Caribbean
<i>Mansonella perstans</i>	Central and West Africa, Central and South America
<i>Onchocerca volvulus</i>	Tropical Africa, Central and South America, parts of Arabia
<i>Wuchereria bancrofti</i>	Endemic in many tropical countries

<sup>1</sup> Previously known as *Dipetalonema perstans*.

### Method

Collection of specimens

Look for nodules (see Fig. 4.112):

- on the chest (over the ribs) (1);
- on the hips (2);
- on the legs (tibia) (3);
- on the back (shoulder-blades) (4).

The nodules are round and hard, 1–5 cm in diameter; when pushed with the fingertips they slide about under the skin. Take the specimen from the skin in the centre of the nodule.

If the patient does not have nodules, take the skin specimen from the top of the buttocks (the upper outer part where intramuscular injections are given — 1 in Fig. 4.113). If the examination gives a negative result, take specimens from:

- the calf (upper outer part — 2 in Fig. 4.113);
- the back (centre of the shoulder-blade — 3 in Fig. 4.113).

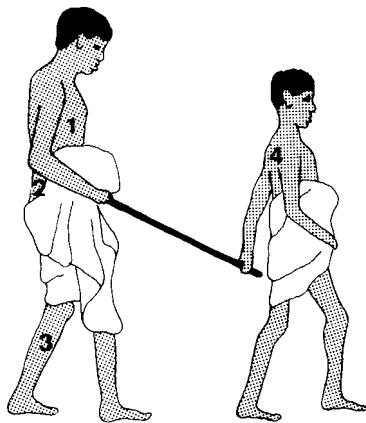

Fig. 4.112 Sites for collection of slit skin specimens from patients with nodules  
1: chest (over the ribs);  
2: hips; 3: legs (tibia);  
4: back (shoulder blades).

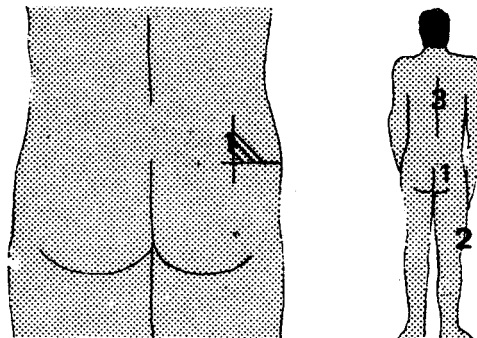

Fig. 4.113 Sites for collection of slit skin specimens from patients without nodules  
1: top of the buttocks; 2: calves (upper outer part); 3: back (shoulder blades).

It is recommended that six specimens (two from the buttocks, two from the calves and two from the shoulder-blades) be examined before reporting a negative result.

1. Flame the scalpel (or razor blade) and the needle with ethanol.
2. Place one drop of sodium chloride solution on a slide.
3. Disinfect the chosen area with a gauze pad dipped in ethanol.
4. Using your left hand, pierce the skin with the point of the needle to a depth of 2–3 mm.
5. Pull the skin away from the flesh with the point of the needle (Fig. 4.114).
6. Place the cutting edge of the scalpel or razor blade on the stretched skin above the point of the needle (using your right hand; see Fig. 4.115).
7. Cut with a quick stroke the piece of skin pulled up by the point of the needle, as close to the needle as possible (Fig. 4.116).

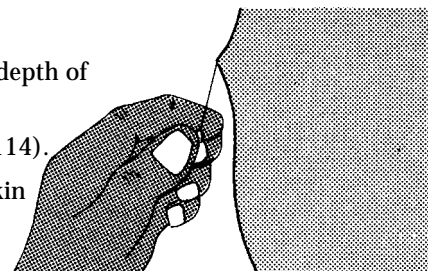

Fig. 4.114 Lifting the skin with a needle

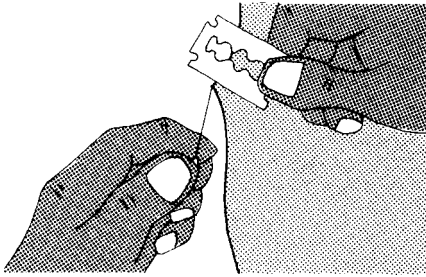

Fig. 4.115 Place the blade above the point of the needle

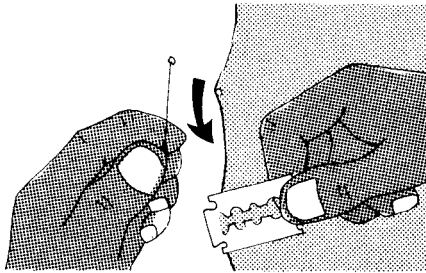

Fig. 4.116 Collecting a slit skin specimen

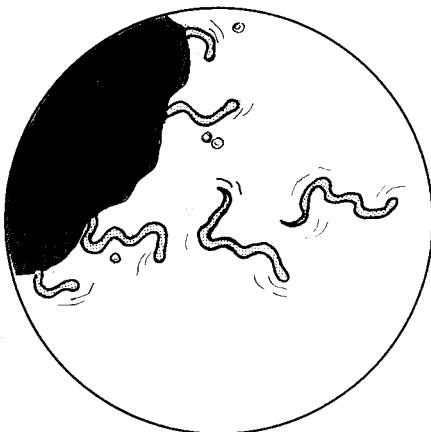

Fig. 4.117 *Onchocerca volvulus* microfilariae in wet preparation

The specimen should be about this size: ● (2–3 mm in diameter).

It should remain attached to the tip of the needle. The specimen should not be bloodstained; the biopsy must be bloodless.

8. Place the fragment of skin in the drop of sodium chloride solution on the slide (using the scalpel or razor blade if necessary). Do not flatten the piece of skin; if only one microfilaria is present, it might be damaged.
9. Cover with a coverslip. If any part of the specimen is not in contact with the liquid, add more solution, injecting it under the coverslip with a Pasteur pipette, until the whole area underneath the coverslip is wet.
10. Wait 2–3 minutes. Meanwhile, clean the spot from which the specimen was taken with ethanol. Apply an adhesive dressing.

Collection of specimens in the field

If no microscope is available, or during mass epidemiological surveys:

1. Place the piece of skin in a small bottle containing 2 ml of sodium chloride solution.
2. Wait 15 minutes for the microfilariae to leave the skin.
3. Fix the specimen by adding 2 ml of 10% formaldehyde solution (reagent no. 28). Mix and replace the cap on the bottle.
4. When you return to the laboratory, shake the bottle well.

Centrifuge the liquid (after removing the piece of skin) at medium speed (2000g) for 5 minutes.

5. Transfer the deposit from the centrifuge tube to a slide and cover it with a coverslip.

#### Microscopic examination

Examine the wet preparation under the microscope using the  $\times 10$  objective. Microfilariae are highly motile. If any are present, they will be seen moving towards the sodium chloride solution (Fig. 4.117). Microfilariae of *Onchocerca volvulus* have the following features:

*Length:* 200–315  $\mu\text{m}$ .

*Width:* 5–9  $\mu\text{m}$  (the same as an erythrocyte).

*Curvature of the body:* angular.

*Front end:* slightly broader than an erythrocyte.

*Tail:* curved and tapered.

If no microfilariae emerge, wait for 10 minutes and look at the centre of the piece of skin; you may see one or two microfilariae moving. If you are in any doubt, take a fresh blood specimen from the patient's finger and prepare a smear on a slide. Cover it with a coverslip and examine it under the microscope. If you see any microfilariae, prepare a stained skin smear (see below) and a stained thick blood film (see page 170) to identify the species.

If microfilariae are present, they will be clearly visible. Staining is not necessary, as the microfilariae can be identified by their characteristic angular curves.

Procedure for obtaining a stained specimen

Examine the deposit using the  $\times 10$  objective. A smear is made on a slide by crushing the skin specimen. It is fixed using methanol and stained with Giemsa stain (see page 170).

Stained microfilariae of *Onchocerca volvulus* show the following features (Fig. 4.118):

- they have no sheath;
- the front end is broad;
- the body shows rigid curves;
- the tail tapers gradually and ends in a sharp curve;
- the nuclei are large and oval and stain blue-black; they are well separated and do not extend to the tip of the tail.

Other microfilariae found in skin biopsies

*Mansonella streptocerca* causes an itchy dermatitis of the infected area. Its microfilariae are found in the skin and differ from *Onchocerca volvulus* in the following ways (Fig. 4.119):

- they are slightly shorter (180–240  $\mu\text{m}$ );
- they are less broad (5–6  $\mu\text{m}$  — half the width of an erythrocyte);
- the front end is not broad;
- the tail ends in a rounded crook;
- the nuclei are smaller and reach the tip of the tail.

#### Recommended procedures for the detection and identification of microfilariae in blood

The microfilariae of some species (e.g. *Loa loa*) and the most common strain of *Brugia malayi* appear in the blood with a marked nocturnal or diurnal periodicity (Table 4.8). Other species and strains of *B. malayi* do not show the same degree of periodicity; they are nocturnally subperiodic or diurnally subperiodic (e.g. *Wuchereria bancrofti*). Other species show no periodicity (e.g. *Mansonella ozzardi*).

The times for collection of blood specimens should be selected in accordance with the patient's clinical symptoms and travel history. Table 4.9 shows the recommended times for collecting blood specimens for testing for periodic and subperiodic species of microfilariae.

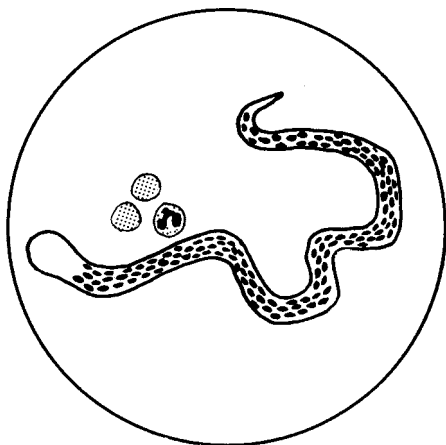

Fig. 4.118 *Onchocerca volvulus* microfilaria in Giemsa-stained smear

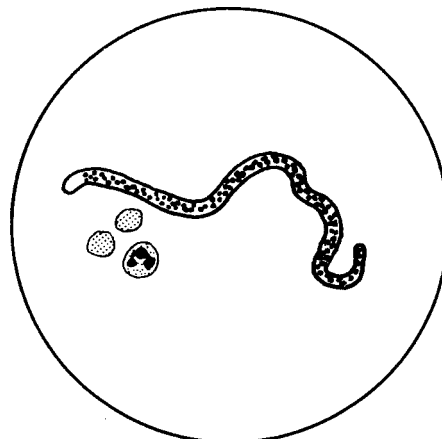

Fig. 4.119 *Mansonella streptocerca* microfilaria in wet preparation

*Note:* Although microfilariae are not directly infectious to humans, all pathological specimens should be treated as potentially hazardous.

An absolute minimum of one “day blood” specimen (taken around 13:00) and one “night blood” specimen (taken around 24:00) should be examined. This is usually sufficient to detect mixed infections and infections with subperiodic strains.

A blood sample for microfilariae is best examined immediately. If a “night blood” sample will not be examined until the following morning, leave it at room temperature.

For each specimen, collect 5–10 ml of blood into a 2% solution of trisodium citrate in saline (reagent no. 59) or heparin anticoagulant. Direct finger-prick samples may give adequate results in areas where filariasis is endemic.

### *Microscopic examination of capillary blood*

Materials and reagents

- Microscope
- Microscope slides
- Coverslips
- Blood lancets
- Cotton wool swabs
- Sodium chloride, 0.85% solution (reagent no. 53)
- 70% Ethanol.

Method

1. Sterilize the third finger with ethanol. Dry well. Prick with the lancet.
2. Collect the *first drop* of blood that appears (it contains most microfilariae) directly on to the middle of the slide (Fig. 4.120).
3. Add an equal-sized drop of sodium chloride solution to the slide.
4. Mix the blood and sodium chloride solution using the corner of a slide. Cover the preparation with a coverslip.
5. Examine the smear systematically under the microscope using the  $\times 10$  objective with the condenser aperture reduced. The first sign of the presence of microfilariae is rapid movement among the erythrocytes.
6. To identify the species of microfilariae, prepare two smears on another slide using two more drops of blood and stain them as described on page 170.

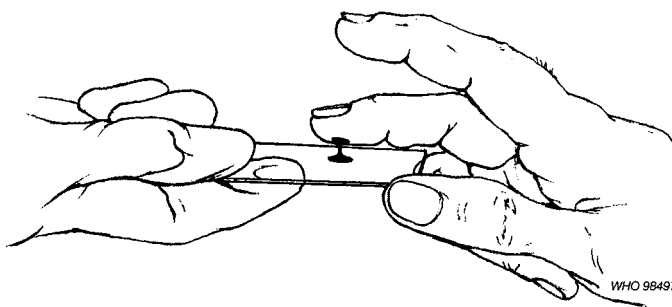

Fig. 4.120 Collecting a capillary blood sample



Table 4.8 Characteristics of common human filarial parasites

Characteristic	B. malayi	B. timori	L. loa	M. ozzardi	M. perstans	M. streptocerca	O. volvulus	W. bancrofti
Geographical distribution	South-east Asia, Indian subcontinent	Lesser Sunda islands, Timor	Central and West Africa	Central and South America, Caribbean	Central and West Africa, South America	Central and West Africa	Africa, Central and South America	Tropical and subtropical countries
Vectors	Mosquitoes (Anopheles and Mansonia spp.)	Mosquitoes (Anopheles spp.)	Tabanid flies (Chrysops spp.)	Biting midges (Culicoides spp.) and blackflies (Simulium spp.)	Biting midges (Culicoides spp.)	Biting midges (Culicoides spp.)	Blackflies (Simulium spp.)	Mosquitoes (Culex, Aedes, Anopheles and Mansonia spp.)
<b>Habitat</b>								
Adults	Lymphatic system	Lymphatic system	Subcutaneous tissues, orbit	Subcutaneous tissues	Mesentery	Dermis	Subcutaneous tissues	Lymphatic system
Microfilariae	Blood	Blood	Blood	Blood	Blood	Skin	Skin	Blood
Periodicity of microfilariae	Nocturnal <sup>a</sup>	Nocturnal	Diurnal	Aperiodic	Aperiodic	NA	NA	Nocturnal <sup>b</sup>
<b>Morphology of microfilariae</b>								
Sheath	Present	Present	Present	Absent	Absent	Absent	Absent	Present
Length (µm)	175–230 in smears; 240–300 in 2% formalin	265–325 in smears; 330–385 in 2% formalin	230–250 in smears; 270–300 in 2% formalin	160–205 in smears; 205–250 in 2% formalin	190–200 in smears; 180–225 in 2% formalin	180–240 in skin snips	300–315 in skin snips	240–300 in smears; 275–320 in 2% formalin
Width (µm)	5.0–6.0	4.4–6.8	5.0–7.0	3.0–5.0	4.0–5.0	5.0–6.0	5.0–9.0	7.5–10.0
Tail	Tapered; subterminal and terminal nuclei widely separated	Tapered; subterminal and terminal nuclei widely separated	Tapered; nuclei irregularly spaced	Long, slender, pointed; anucleate	Bluntly rounded; nuclei to end	Bluntly rounded, bent into a hook; nuclei to end	Typically flexed; tapered to point; anucleate	Tapered; anucleate
Key features	Long head space; sheath stains pink in Giemsa; terminal and subterminal nuclei	Long head space; sheath unstained in Giemsa; terminal and subterminal nuclei	Sheath unstained in Giemsa; single row of nuclei to end of tail	Small size; long slender tail; aperiodic	Small size; blunt tail filled with nuclei; aperiodic	Slender shape; hooked tail filled with nuclei; occur in skin	Flexed tail; occur in skin and occasionally in urine or blood after treatment	Short head space; sheath unstained in Giemsa; body in smooth curves; dispersed nuclei

<sup>a</sup>Nocturnally subperiodic in Indonesia, Malaysia, parts of the Philippines and Thailand.<sup>b</sup>Diurnally subperiodic in New Caledonia and Polynesia; nocturnally subperiodic in rural areas of Thailand.

**Table 4.9 Recommended times for collection of blood specimens for testing for microfilariae**

Species <sup>a</sup>	Recommended collection time
Periodic (nocturnal)	23:00–01:00 (peak 24:00)
Periodic (diurnal)	12:00–14:00 (peak 13:00)
Subperiodic (nocturnal)	20:00–22:00 (peak 21:00)
Subperiodic (diurnal)	15:00–17:00 (peak 16:00)
Aperiodic	any time (day or night)

<sup>a</sup>See Table 4.8.

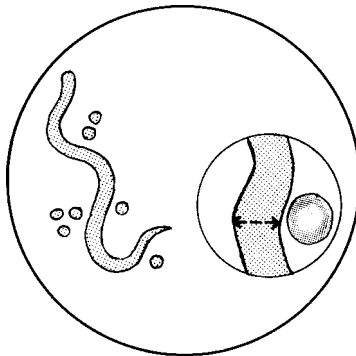

Fig. 4.121 **A pathogenic microfilaria**  
Length: 250–300  $\mu\text{m}$ ;  
thickness: 6–8  $\mu\text{m}$  (diameter  
of an erythrocyte).  
e.g. *Wuchereria bancrofti*,  
*Loa loa*, *Brugia malayi*.

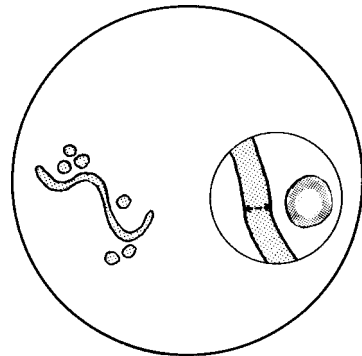

Fig. 4.122 **A microfilaria of doubtful pathogenicity**  
Length: about 150  $\mu\text{m}$ ;  
thickness: about 4  $\mu\text{m}$  (half  
the diameter of an  
erythrocyte).  
e.g. *Mansonella ozzardi*,  
*M. perstans*.

Staining is generally required to identify microfilariae in blood smears. It is possible, however, to gain some indication of the species seen and its pathogenicity from a fresh smear (Figs. 4.121 and 4.122).

#### *Microscopic examination of venous blood concentrated by centrifugation*

##### Materials and reagents

- Microscope
- Microscope slides
- Syringes (5 ml or 10 ml)
- Needles for venepuncture
- Centrifuge or microhaematocrit centrifuge
- Conical centrifuge tubes or microhaematocrit capillary tubes
- Plastic modelling clay
- Adhesive tape
- Anticoagulant: trisodium citrate, 2% solution in saline (reagent no. 59)
- Formalin, 2% solution (prepared by diluting 37% formaldehyde solution 1:50 with distilled water) or saponin, 1% solution (reagent no. 48)
- Ether
- 70% Ethanol.

### Method

1. Collect 4 ml of venous blood. Expel into a bottle containing 1 ml of trisodium citrate solution. Mix.
2. Measure into a conical centrifuge tube 10 ml of 2% formaldehyde solution. Add 1 ml of citrated blood. Mix. Wait 5 minutes for the erythrocytes to lyse.
3. Centrifuge for 5 minutes at 10 000*g*. Pour off the supernatant fluid. Tap the tube to mix the deposit.
4. Place one drop of the deposit on a slide. Spread the drop to form a thin smear and leave to air-dry.
5. Fix the smear using a 1:1 mixture of ethanol and ether. Leave to dry for 2 minutes, then stain immediately as described on page 170 to identify the species of microfilaria.

### Alternative method using a microhaematocrit centrifuge

1. Collect 4 ml of venous blood. Expel into a bottle containing 1 ml of trisodium citrate solution. Mix.
2. Three-quarters fill a microhaematocrit capillary tube with the citrated blood. Seal one end of the tube with plastic modelling clay or by heating.
3. Centrifuge in a microhaematocrit centrifuge at 10 000*g* for 2 minutes.
4. Lay the capillary tube on a slide and secure the two ends with adhesive tape.
5. Examine the dividing line between the blood cells and the plasma under the microscope (Fig. 4.123), using the  $\times 10$  objective with the condenser aperture reduced.

Motile microfilariae will be seen at the bottom of the column of plasma, just above the layer of leukocytes and erythrocytes (Fig. 4.124).

The tube can be snapped at the bottom of the column of plasma (see Fig. 4.124). Use the first drop from each piece of the broken tube to prepare a thick film. Stain the film as described on page 170 to identify the species.

Capillary blood can also be examined by this method. Collect two drops of capillary blood from the finger on to a slide and mix with one drop of 2% trisodium citrate solution.



Fig. 4.123 Examining the microhaematocrit capillary tube under the microscope

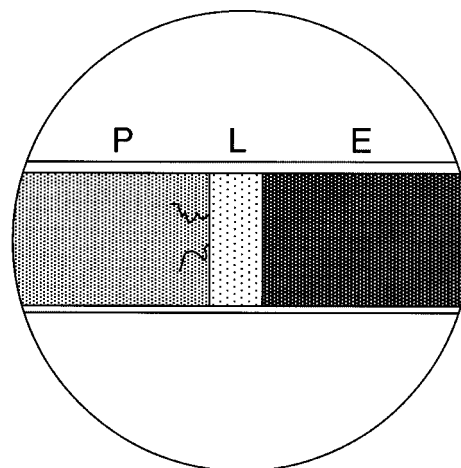

Fig. 4.124 Motile microfilariae  
E: erythrocytes; L: leukocytes;  
P: plasma.

Alternative method using saponin lysing solution

1. Add 10 ml of citrated blood (see above) to 10 ml of saponin lysing solution.
2. Mix the blood gently and leave for 15 minutes to allow the erythrocytes to lyse.
3. Centrifuge at 2000g for 15 minutes.
4. Remove the supernatant with a pipette and discard it into a dish containing disinfectant.
5. Transfer the deposit to a slide and cover with a coverslip.
6. Examine the entire deposit for motile microfilariae using the  $\times 10$  objective. (Microfilariae will still be motile in a "night blood" sample examined the following morning.)
7. Count the number of microfilariae in the preparation and divide by 10 to give the number of microfilariae per ml of blood.

Considerable experience is required to identify unstained microfilariae. It is recommended that identification be performed on stained preparations (see page 170).

#### ***Microscopic examination of venous blood concentrated by filtration***

Materials and reagents

- Microscope
- Microscope slides
- Coverslips
- Syringe, 15 ml
- Swinnex-type filter holder
- Polycarbonate membrane filter (25 mm diameter, 5  $\mu$ m pore size)<sup>1</sup>
- Filter-paper pad (25 mm diameter)
- Shallow dish, 15 ml, with lid
- Blunt forceps
- Sodium chloride, 0.85% solution (reagent no. 53)
- Absolute methanol
- Distilled water.

Method

1. Draw up 10 ml of distilled water into a syringe.
2. Draw 1 ml of fresh blood or citrated blood into the syringe (Fig. 4.125). Rotate gently to mix the contents. Wait for 2–3 minutes, for the erythrocytes to lyse.
3. Moisten the filter-paper pad with a few drops of distilled water and cover with the membrane filter. Place the filter on the filter holder.
4. Connect the syringe to the filter holder. Gently push the blood through the filter into a dish containing disinfectant solution (Fig. 4.126).
5. Remove the syringe from the filter holder (taking care to avoid disturbing the filter) and draw up 10 ml of distilled water.
6. Reconnect the syringe to the filter holder and gently push the water through the filter into the dish containing disinfectant solution, to remove the debris from the filter (Fig. 4.127).

<sup>1</sup> In areas endemic for *Mansonella perstans*, a membrane filter with a pore size of 3  $\mu$ m should be used.

7. Remove the syringe from the filter holder and draw up approximately 5 ml of air.
8. Reconnect the syringe to the filter holder and push the air through the filter over the dish containing disinfectant, to remove excess water from the filter. Discard the disinfectant solution into a sink.
9. Remove the syringe from the filter holder. Dismantle the filter holder and remove the membrane filter using forceps.
10. Place the membrane filter, top side facing up, on a slide. Add a drop of sodium chloride solution and cover with a coverslip.
11. Examine the entire membrane for motile microfilariae, using the  $\times 10$  objective. (Microfilariae will still be motile in a "night blood" specimen examined the following morning.)
12. Count the number of microfilariae in the preparation and divide by 10 to give the approximate number of microfilariae per ml of blood.

Considerable experience is required to identify unstained microfilariae. It is recommended that identification be performed on stained preparations (see below). To prepare a stained preparation, follow the method described above, with the following modifications:



Fig. 4.125 Drawing up citrated blood into a syringe



Fig. 4.126 Filtering the blood sample

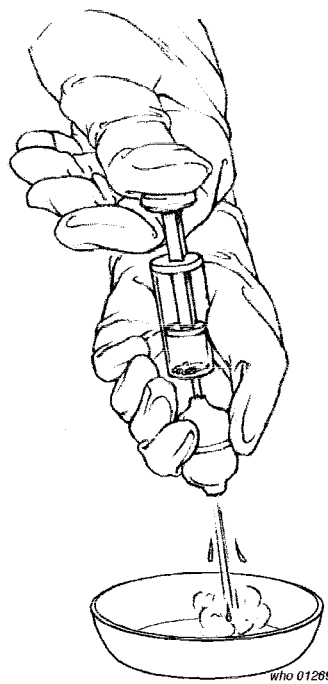

Fig. 4.127 Rinsing the filter

8. Reconnect the syringe to the filter holder and push the air through the filter over the dish containing disinfectant, to remove excess water from the filter.
9. Remove the syringe from the filter holder and draw up approximately 7 ml of air and 3 ml of methanol.
10. Reconnect the syringe to the filter holder and push the methanol and air through the filter over the dish containing disinfectant, to fix the microfilariae and remove excess methanol from the filter, respectively.
11. Remove the syringe from the filter holder. Dismantle the filter holder and remove the membrane filter using forceps.
12. Place the membrane filter, top side facing up, on a slide. Allow to air-dry.
13. Stain with Giemsa stain as for thick films (see page 175) and examine the entire filter membrane using the  $\times 10$  objective.

#### *Technique for staining microfilariae*

##### Materials and reagents

- Microscope
- Microscope slides
- Giemsa stain (reagent no. 29)
- Delafield's haematoxylin stain (reagent no. 19)
- Methanol
- Buffered water (reagent no. 15).

##### Method

1. Prepare a thick blood smear of the deposit as described on page 174. Allow the smear to air-dry.
2. Fix in methanol for 1 minute.
3. Stain with Giemsa stain (diluted 1 in 20 with buffered water, pH 6.8) for 30 minutes.
4. Examine the preparation under the microscope using the  $\times 10$  objective. If it is difficult to distinguish the nuclei of the microfilariae, return the slide to the Giemsa stain solution for another 5–10 seconds.
5. Stain with Delafield's haematoxylin stain (diluted 1 in 10 with buffered water, pH 6.8) for 5 minutes. Wash in buffered water, pH 6.8. (This second stain is required because Giemsa stain alone does not stain the sheath of *Loa loa* very well.)
6. Examine the preparation under the microscope. Use the  $\times 10$  objective first to locate the microfilariae; then identify the filarial species using the  $\times 40$  and  $\times 100$  objectives.

##### Results

Under the light microscope microfilariae appear (after appropriate staining) as primitive organisms, serpentine in shape, often enclosed in a sheath and filled with the nuclei of many cells (Fig. 4.128).

Not all species have a sheath. In those that do, the sheath may extend a short or long distance beyond either extremity. In some species, depending on the stain used, the sheath displays a unique staining quality which aids in species identification.

The nuclei of the cells which fill the body are usually darkly stained and may be crowded together or dispersed (see Fig. 4.128). The anterior extremity is charac-

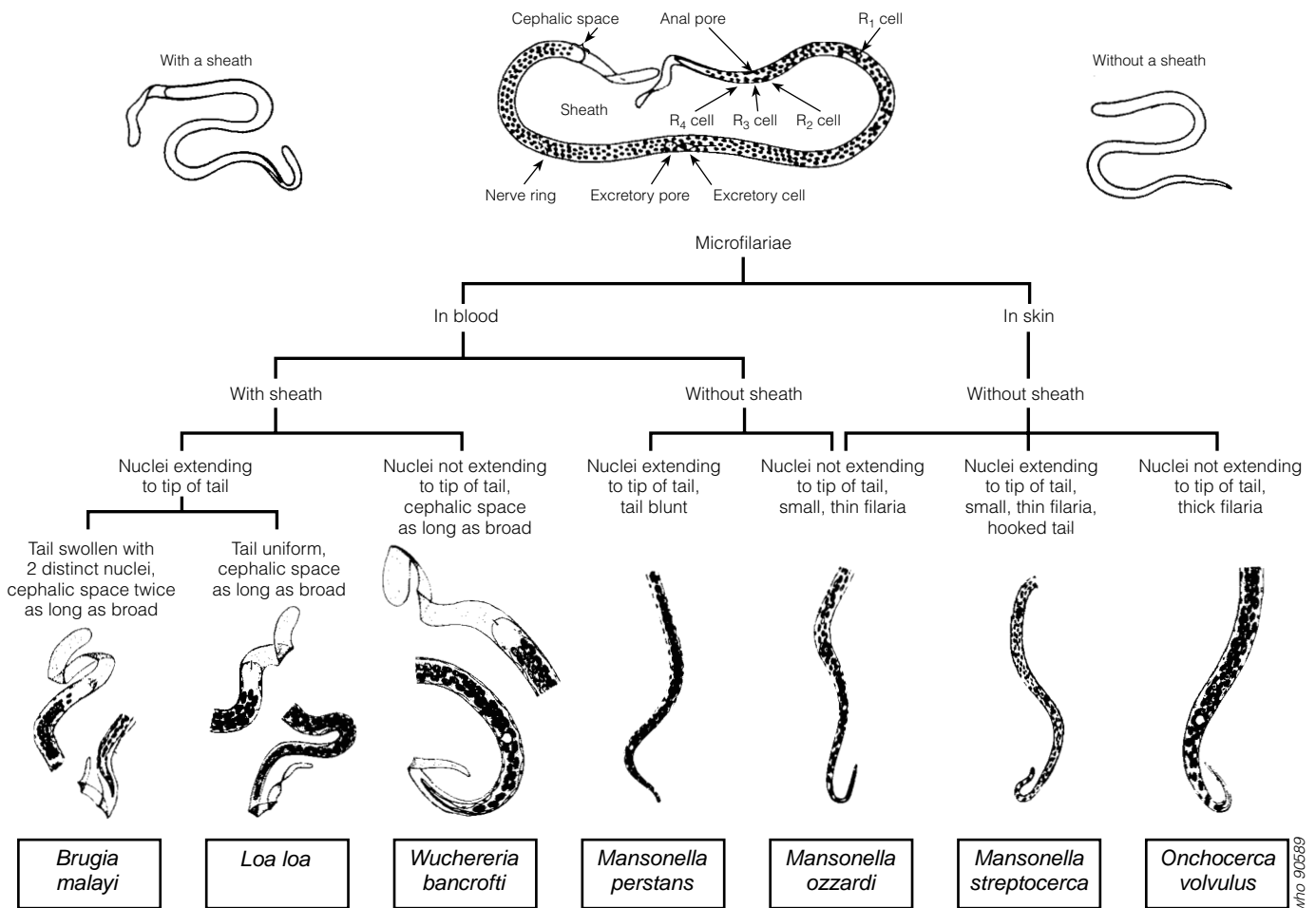

Fig. 4.128 Microfilariae found in humans  
 R<sub>1</sub>, R<sub>2</sub>, R<sub>3</sub>, R<sub>4</sub>: rectal cells.

teristically devoid of nuclei and is called the cephalic or head space; it may be short or long.

As you look from the anterior to the posterior end of the body you will see additional spaces and cells that serve as anatomical landmarks. These include the nerve ring, excretory pore, excretory cell and anal pore. In some species an amorphous mass called the inner body and four small cells (known as rectal cells) can be seen. Some of these structures and their positions are useful in identifying the species. Other useful features include the shape of the tail and the presence or absence of nuclei within it.

Table 4.8 summarizes the features of common human filarial parasites that are used in their identification.

*Note:*

- Sometimes the microfilariae of the periodic strain of *Brugia malayi* lose their sheath.
- Identification of species can be difficult and mistakes are frequently made. The guidelines for the identification of microfilariae given above and those that appear in most textbooks make identification seem deceptively simple. Sometimes it is difficult to see the sheath. At other times, the nuclei do not appear in their characteristic position at the tip of the tail. It is good practice to examine several microfilariae carefully, before deciding on their species. If a systematic study is made of all the characteristics mentioned above, it should be possible to identify with certainty the species observed. The identification must not be based on a single characteristic, but on all the features taken together.

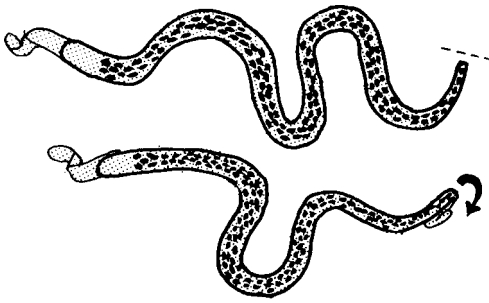

Fig. 4.129 Possible cause of misidentification of *Wuchereria bancrofti*: broken or folded tail

#### Possible causes of misidentification

**Broken or folded tail.** If the tail of *Wuchereria bancrofti* is broken or folded over (Fig. 4.129), it appears to have nuclei extending to the tip like *Loa loa*.

**Torn or colourless sheath.** The sheath is sometimes torn or almost colourless. In *Loa loa*, for example, the sheath appears as a colourless space between the tail and the blood cells.

**Unusually large or small microfilariae.** Some *Mansonella perstans* are very long (e.g. 200 µm), and some *Wuchereria bancrofti* and *Loa loa* are small (e.g. 250 µm).

**Badly made smears (or films).** If it is damaged when the smear (or film) is being made, *Wuchereria bancrofti* may appear twisted and *Loa loa* may show a few curves.

**Geographical origin of the patient.** Always bear in mind where the patient is from or which countries the patient has visited recently.

If the patient is from:

- Cameroon, eastern Nigeria or the Democratic Republic of the Congo river basin, the parasite is probably *Loa loa*;
- Ghana, India, Senegal or the West Indies, the parasite is probably *Wuchereria bancrofti*;
- Thailand, the parasite is probably *Brugia malayi*;
- Guyana, the parasite is probably *Mansonella ozzardi*.

**Examination of thin films.** Identification of microfilariae in stained thin films is not recommended; the microfilariae are shrunken, distorted and difficult to recognize.

#### 4.7.2 *Plasmodium* spp.

Malaria, which is caused by infection with protozoa of the genus *Plasmodium*, is the most important parasitic disease in tropical countries. It is transmitted to humans through the inoculation of *Plasmodium* sporozoites by female *Anopheles* mosquitoes or by blood transfusion. The sporozoites travel through the blood to the liver, where they transform into large tissue schizonts containing considerable numbers of merozoites (tissue schizogony). These begin to rupture after 5–20 days, according to the species, and the released merozoites invade circulating erythrocytes. The replication cycle is repeated at regular intervals.

#### Clinical symptoms

The first clinical symptoms of infection are low-grade fever, headaches, muscle aches and malaise. These symptoms are often misinterpreted as being the result of a viral influenza infection. The influenza-like symptoms are followed by recurrent, periodic attacks of high fever and shivering. If high temperatures are accompanied by mental disturbances marked by hallucinations and cerebral excitation, this may indicate cerebral malaria, which is often fatal.

In areas in which malaria is endemic and where the population has developed partial immunity to the disease, the clinical symptoms may be more moderate.

#### *Plasmodium* species infective to humans

There are four different species of *Plasmodium* infective to humans. These are *P. falciparum*, *P. malariae*, *P. ovale* and *P. vivax*.



**Table 4.10 Geographical distribution of *Plasmodium* spp. infective to humans**

Country or area	<i>P. falciparum</i>	<i>P. malariae</i>	<i>P. ovale</i>	<i>P. vivax</i>
Central Africa	Predominant	Rare	Rare	Rare
East Africa	Predominant	Rare	Rare	Common
North Africa	Very rare	Very rare	Absent	Predominant
West Africa	Predominant	Rare	Rare	Very rare
Central America	Common	Rare	Absent	Predominant
South America	Common	Common	Absent	Predominant
Central and south-west Asia	Common	Common	Absent	Predominant
South-east Europe	Very rare	Very rare	Absent	Predominant
Indian subcontinent	Common	Rare	Very rare	Predominant
Indochina	Predominant	Rare	Rare	Common
Indonesia	Predominant	Very rare	Very rare	Common
Madagascar, Indian Ocean	Predominant	Rare	Rare	Common
Pacific Islands	Predominant	Very rare	Rare	Common

The geographical distribution of these species is summarized in Table 4.10.

#### Identification of *Plasmodium* spp. in blood films

Malaria parasites are usually detected in blood films stained with Field or Giemsa stains. They may also be detected using an immunological procedure known as a dipstick test (see section 11.9).

It is important for the prognosis and treatment of the disease that the species involved are identified in the laboratory. If you cannot identify the species, always report the presence of any malaria parasites you see. Do not mistake thrombocytes superimposed upon erythrocytes for malaria parasites.

#### *Preparation of a thick and a thin blood film on the same slide*

For routine malaria microscopy, a thin and a thick film are made on the same slide. The thick film is used for the detection of parasites, while the thin film is used in identifying the species of parasite.

#### Materials and reagents

- Microscope
- Clean glass microscope slides (see section 3.5.1)
- Sterile blood lancets
- Cotton wool
- Grease pencil
- Methanol
- 70% Ethanol.

#### Method

Blood to be examined for malaria parasites is usually collected at a health centre. The most suitable time for collection is at the height of an episode of fever, when the parasites are most numerous in the blood. Blood specimens should always be collected *before* antimalarial drugs are given.



Fig. 4.130 Cleaning the finger before collecting a capillary blood sample

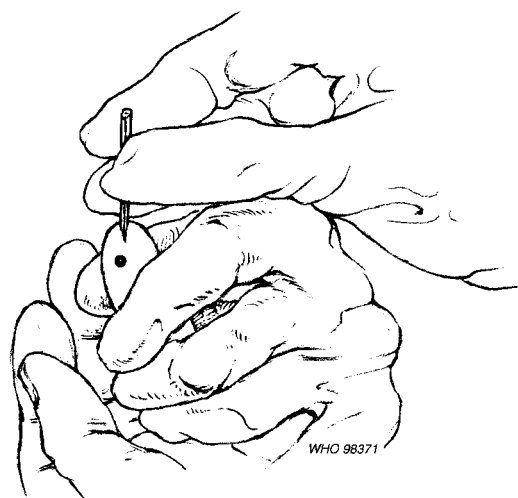

Fig. 4.131 Using a lancet to puncture the ball of the finger

1. With the patient's left hand palm upwards, select the third or fourth finger. (The big toe can be used with infants. The thumb should never be used for adults or children.) Use cotton wool lightly soaked in ethanol to clean the finger — using firm strokes to remove dirt and grease from the ball of the finger (Fig. 4.130). Dry the finger with a clean piece of cotton wool (or lint).
2. With a sterile lancet, puncture the ball of the finger (Fig. 4.131), using a quick rolling action. By applying gentle pressure to the finger, express the first drop of blood and wipe it away with dry cotton wool. Make sure that no strands of cotton wool remain on the finger.
3. Working quickly and handling clean slides only by the edges, collect the blood as follows:
  - Apply gentle pressure to the finger and collect a single small drop of blood, about this size ●, on to the middle of the slide. This is for the thin film.
  - Apply further pressure to express more blood and collect two or three larger drops, about this size ●●, on to the slide about 1 cm from the drop intended for the thin film (see Fig. 4.132).

Wipe the remaining blood away with cotton wool.
4. *Thin film.* Using another clean slide as a "spreader", and with the slide with the blood drops resting on a flat, firm surface, touch the small drop with the spreader and allow the blood to run along its edge. Firmly push the spreader along the slide, away from the largest drops, keeping the spreader at an angle of 45° (Fig. 4.133). Make sure that the spreader is in even contact with the surface of the slide all the time the blood is being spread.
5. *Thick film.* Always handle slides by the edges, or by a corner, to make the thick film as follows:
 

Using the corner of the spreader, quickly join the larger drops of blood and spread them to make an even, thick film (Fig. 4.134).
6. Allow the thick film to dry in a flat, level position protected from flies, dust and extreme heat. Label the dry film with a grease pencil by writing across the thicker portion of the thin film the patient's name or number and date (as shown in Fig. 4.135).

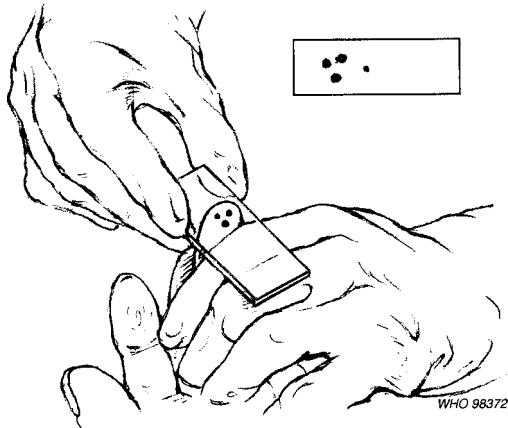

Fig. 4.132 Collecting the blood sample

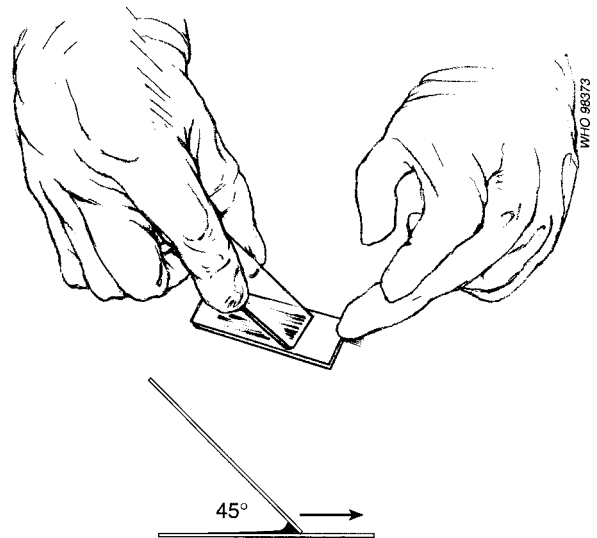

Fig. 4.133 Preparing a thin blood film

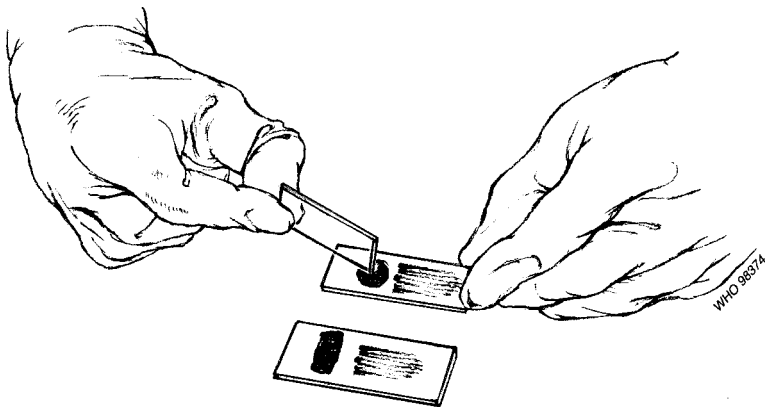

Fig. 4.134 Preparing a thick blood film



Fig. 4.135 Labelling the slide

### *Staining blood films with Giemsa stain*

#### Principle

During staining of the blood film, the haemoglobin in the erythrocytes dissolves (dehaemoglobinization) and is removed by the water in the staining solution. All that remain are the parasites and the leukocytes, which can be seen under the microscope.

#### Materials and reagents

- Microscope
- Measuring cylinders, 10, 50 and 100 ml
- Beakers, 50 and 250 ml
- Staining troughs
- Glass rods
- Wash bottle
- Slide forceps
- Slide racks

- Timer
- Giemsa stain (reagent no. 29)
- Methanol in a drop bottle
- Buffered water, pH 7.2 (reagent no. 15) or distilled water.

#### Routine method for staining thick and thin blood films

Ideally, for optimum staining, thick and thin films should be made on separate slides. This is often not possible and thick and thin films are generally made on the same slide. When this is done, good-quality staining of the thick film is of primary importance. Best results are obtained if the blood films have dried overnight.

This method is suitable for staining 20 or more slides.

1. Fix the thin film by adding three drops of methanol, or by dipping it into a container of methanol for a few seconds. With prolonged fixation it may be difficult to detect Schüffner's dots and Maurer's clefts. To permit dehaemoglobinization, the thick film should not be fixed; therefore avoid exposure of the thick film to methanol or methanol vapour.

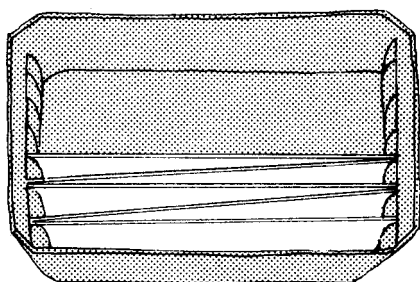

Fig. 4.136 Placing the slides in a staining trough

2. Using forceps, place the slides back to back in a staining trough (Fig. 4.136).
3. Prepare a 3% Giemsa solution in buffered or distilled water, pH 7.2, in sufficient quantity to fill the number of staining troughs being used. Mix the stain well.
4. Pour the stain gently into the staining trough, until all the slides are totally covered. Stain for 30–45 minutes out of sunlight.
5. Pour clean water gently into the trough to remove the deposit on the surface of the staining solution (Fig. 4.137).
6. Gently pour off the remaining stain (Fig. 4.138), and rinse again in clean water for a few seconds. Pour the water off.

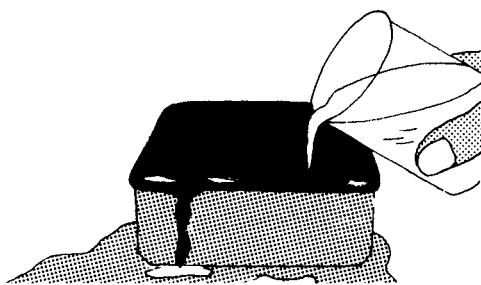

Fig. 4.137 Pouring clean water into the staining trough to remove the deposit

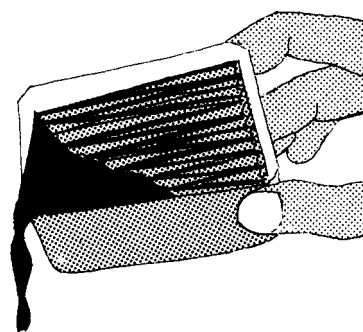

Fig. 4.138 Pouring off the remaining stain

In some laboratories with limited supplies the diluted Giemsa stain is reused; in such cases it must be used on the same day.

7. Using forceps, remove the slides one by one. Place them in a slide rack to drain and dry, film side downwards, making sure that the film does not touch the slide rack.

#### Rapid method for staining thick and thin blood films

This method is suitable for rapid staining of thick films when urgent results are required. It uses much more stain than the regular method.

1. Allow the thick film to dry thoroughly; if results are required urgently, drying may be hastened by fanning, or briefly exposing the slide to gentle heat such as that from a microscope lamp. Care should be taken to avoid overheating, otherwise the thick film will be heat-fixed.
2. Fix the thin film by adding three drops of methanol, or by dipping it into a container of methanol for a few seconds. To permit dehaemoglobinization, the thick film should not be fixed; therefore avoid exposure of the thick film to methanol or methanol vapour.
3. Prepare a 10% Giemsa solution in buffered or distilled water, pH 7.2; if a small quantity is being used, three drops of stain per ml of buffered water will give the correct concentration of Giemsa solution. One slide requires about 3 ml of made-up stain. Mix the stain well with a glass rod.
4. Gently pour the stain on to the slides or use a pipette. Stain for 5–10 minutes.
5. Gently flush the stain off the slides by adding drops of clean water. Do not tip off the stain and then wash, as this will leave a deposit of scum over the smears.
6. Place the slides in the slide rack to drain and dry, film side downwards, making sure that the film does not touch the slide rack.

#### *Staining blood films with Field stain*

Staining with Field stain allows rapid detection of malaria parasites (but it does not always stain Schüffner's dots).

#### Materials and reagents

- Microscope
- Glass jars
- Slide racks
- Methanol
- Field stain (reagent no. 25)
- Buffered water, pH 7.2 (reagent no. 15).

#### Method for staining thick films

1. Dip the unfixed film into a jar containing Field stain A solution for 3 seconds.
2. Wash gently by dipping (once) into a jar of clean water for 5 seconds.
3. Dip the slide into a jar containing Field stain B solution for 3 seconds.
4. Wash the slide gently as in step 2.
5. Place the slide upright in a slide rack to air-dry.

#### Method for staining thin films

1. Fix the film in methanol for 1 minute.
2. Wash off the methanol with buffered water.
3. Using a pipette, cover the film with diluted Field stain B (one volume of stain plus four volumes of buffered water).
4. Immediately add an equal volume of Field stain A solution and mix well by tilting the slide.
5. Allow to stain for 1 minute.
6. Wash off the stain with clean water.
7. Place the slide upright in a slide rack to air-dry.

***Microscopic examination***

Examine the slide under the microscope using the  $\times 100$  objective. Malaria parasites found in the blood are at different stages of development (Fig. 4.139). Some malaria parasites have granules of pigments in their cytoplasm (Fig. 4.140).



**Thin blood films**

In thin blood films, the infected erythrocytes may remain unchanged or have a different colour or shape, or may contain pink ("Schüffner's") or red ("James")

Fig. 4.139 Stages of development of malaria parasites

Fig. 4.140 Malaria parasites containing pigment

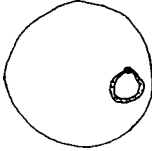
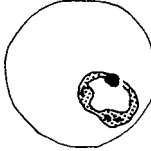
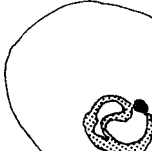
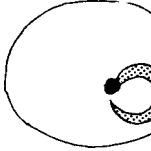
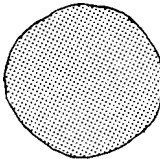
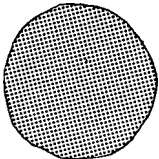
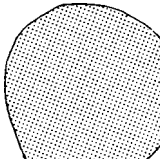
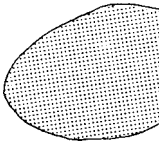
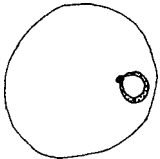
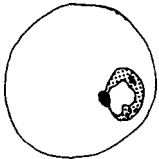
**Table 4.11 Comparison of infected erythrocytes in thin blood films**

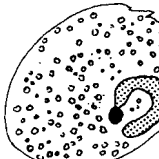
	<i>P. falciparum</i>	<i>P. malariae</i>	<i>P. vivax</i>	<i>P. ovale</i>
Size of young trophozoite in comparison with diameter of an erythrocyte (at the same stage of development)	 One-fifth to one-third of diameter	 One-quarter to two-thirds of diameter	 One-quarter to two-thirds of diameter	 One-quarter to two-thirds of diameter
Appearance of infected erythrocyte	 Remains unchanged	 Remains unchanged or becomes smaller and sometimes more deeply coloured	 Enlarged and often pale-staining	 Enlarged, oval, with torn jagged edges
Dots in the infected erythrocyte	 Often none <sup>a</sup>	 None	 Small pink dots (Schüffner's dots)	 Large red dots (James dots) always present
Stages found (see Fig. 4.139)	Trophozoites and/or gametocytes; many trophozoites can be found in one cell	All stages found in the same film	All stages found in the same film	All stages found in the same film

<sup>a</sup>In some erythrocytes infected with adult trophozoites of *P. falciparum*, a few large pink granules ("Maurer's clefts") can be found.

dots (see Table 4.11). Thin films can be used to identify the species of malaria parasite (see Table 4.12).

*Note:* In patients who have been suffering from malaria for a long time, monocytes may be seen in the thin blood film; the cytoplasm often contains brown or greenish-black bodies (siderophils). In patients who have recently received an injection of an antimalarial drug, the parasites stain poorly and appear distorted and indistinct.

#### Thick blood films

In thick blood films, the background should be clean and free from debris, as the infected erythrocytes are lysed. The malaria parasites should have deep red chromatin and blue or pale purplish-blue cytoplasm. In thick films stained with Giemsa, the nuclei of leukocytes should be stained dark purple. Schüffner's dots may be seen around the malaria parasites.









Thick blood films are used for estimating the parasite density, as described below.

#### Parasite density

The parasite density is the number of parasites counted in each microscope field. It usually varies according to the species.

Two methods can be used to count malaria parasites in thick blood films: determination of the number of parasites per microlitre ( $\mu\text{l}$ ) of blood, and the plus system.

**Table 4.12 Identification of *Plasmodium* spp. infective to humans in blood films**

	<i>P. falciparum</i>		<i>P. malariae</i>	
Young trophozoite	(Stage frequently found) <i>Cytoplasm</i> : small, fine, pale blue ring <i>Chromatin</i> : one or two small red dots		(Stage frequently found) <i>Cytoplasm</i> : thick, dense, blue ring with some granules of black pigment <i>Chromatin</i> : one large red dot	
Mature trophozoite	(Stage frequently found) <i>Cytoplasm</i> : rather thin, blue ring, or shaped like a comma or an exclamation mark <i>Chromatin</i> : one or two medium-sized red dots		(Stage frequently found) <i>Cytoplasm</i> : either (a) round, compact, dark blue, with many black particles of pigment, or (b) in band form (in thin films only) <i>Chromatin</i> : a round dot or red band	
Schizont	(Very rare) Hardly ever found in blood films (except in very serious cases) <i>Merozoites</i> : 18–32 <i>Pigment</i> : dark brownish-black		(Fairly frequently found) <i>Merozoites</i> : 8–10 large red granules surrounded by pale cytoplasm and arranged irregularly (young form) or in a rosette <i>Pigment</i> : always seen	
Gametocyte	(Fairly frequently found) <i>Shape</i> : similar to a banana or sickle <i>Colour</i> : pale blue (male) or dense blue (female) <i>Nucleus</i> : reddish-pink <i>Pigment</i> : a few blue-black granules in the centre of the cytoplasm or scattered through it		(Fairly frequently found) <i>Shape</i> : large, oval or rounded <i>Colour</i> : pale blue (male) or dense blue (female) <i>Nucleus</i> : one round spot of red chromatin against one edge <i>Pigment</i> : large black granules in the cytoplasm	
Erythrocytes	Normal in size May show crenation cells containing mature trophozoites; often contain a few red dots, irregular in size and shape		Normal in size and shape No red dots usually seen	
Parasite density <sup>b</sup>	Often very high density		Low density	









<sup>a</sup> The identity of *P. ovale* must be confirmed by examination of a thin blood film.

<sup>b</sup> The parasite density in any area depends mainly on whether the malaria is seasonal or endemic. Adults living in endemic areas often develop immunity to the disease and have a low parasite density.

1. Determination of the number of parasites/ $\mu$ l of blood is accomplished by counting the number of parasites in relation to a standard number of leukocytes/ $\mu$ l (8000). Initially, the blood film is examined for the presence of parasite species and their stages of development. Using two hand tally counters, one for counting leukocytes and the other for parasites, follow one of these two procedures:

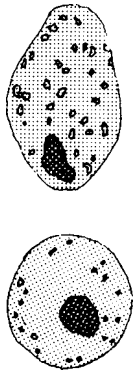
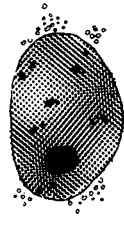

Table 4.12 (cont.)

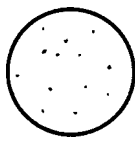
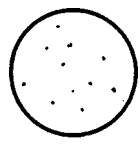
	<i>P. vivax</i>		<i>P. ovale</i> <sup>a</sup>	
Young trophozoite	(Stage frequently found) <i>Cytoplasm</i> : blue, irregular, quite thick ring <i>Chromatin</i> : one large red dot		<i>Cytoplasm</i> : regular, dense blue ring <i>Chromatin</i> : one medium-sized red dot	
Mature trophozoite	(Not frequently found) <i>Cytoplasm</i> : large, blue, irregular (sometimes divided into 2-4); small particles of brownish-orange pigment <i>Chromatin</i> : 1 red dot		<i>Cytoplasm</i> : round, compact, very blue with a few particles of brown pigment <i>Chromatin</i> : one large red dot	
Schizont	(Quite frequently found) <i>Merozoites</i> : 12-18 large compact red granules surrounded by pale blue cytoplasm		<i>Merozoites</i> : 8-14 large red granules in a rosette, round a central mass of particles of brown pigment	
Gametocyte	(Frequently found) <i>Female</i> : oval or rounded, dense blue A dense red triangular nucleus, often at one end; many particles of orange pigment in the cytoplasm <i>Male</i> : rounded, pale blue A round central pale red nucleus; some particles of orange pigment in the cytoplasm		<i>Shape</i> : large, oval or round, dense blue <i>Nucleus</i> : one round red spot <i>Pigment</i> : a few brown particles in the cytoplasm <i>Differentiated from</i> : — <i>P. vivax</i> by its brown pigment — <i>P. malariae</i> by the presence of Schüffner's dots	
Erythrocytes	Enlarged, often pale-staining Schüffner's dots, especially around mature trophozoites	See Table 4.11	May appear oval with jagged ends Easily seen large red James dots	
Parasite density <sup>b</sup>	Medium density		Medium density	

- (i) if, after counting 200 leukocytes, 10 or more parasites are found, record the results on the record form in terms of the number of parasites/200 leukocytes;
- (ii) if, after counting 200 leukocytes, the number of parasites is 9 or fewer, continue counting until you reach 500 leukocytes and then record the number of parasites/500 leukocytes.

After procedure (i) or (ii), use a simple mathematical formula, multiplying the number of parasites by 8000 and then dividing this figure by the number of leukocytes (200 or 500). The result is the number of parasites/ $\mu\text{l}$  of blood. It is normal practice to count all the species present and to count and record separately the gametocytes of *P. falciparum* and the asexual parasites. This is particularly important when monitoring the response to antimalarial drugs that are active against the schizont stage, which would not be expected to have any effects on gametocytes.

$$\begin{aligned} & \text{number of parasites counted/number of leukocytes} \\ & = \text{number of parasites}/\mu\text{l of blood} \end{aligned}$$

Example:

If 200 leukocytes are counted:

$$(50 \text{ parasites} \times 8000 / 200 \text{ leukocytes}) = 2000 \text{ parasites}/\mu\text{l of blood}$$

If 500 leukocytes are counted:

$$(5 \text{ parasites} \times 8000 / 500 \text{ leukocytes}) = 80 \text{ parasites}/\mu\text{l of blood}$$

2. A simpler method of counting parasites in thick blood films is to use the plus system. This system is less satisfactory, however, and should be used only when it is not possible to carry out the more acceptable count of parasites/ $\mu\text{l}$  of blood. In this system, a code of between one and four plus signs is used:

- + = 1–10 parasites per 100 thick film fields
- ++ = 11–100 parasites per 100 thick film fields
- +++ = 1–10 parasites per single thick film field
- ++++ = more than 10 parasites per single thick film field.

**Remember:** For proper identification and reliable parasite counting, use clean slides and well-made and well-stained thick films.

**Note:** Patients with very high parasite densities (over 10 parasites per thick film field) require urgent treatment. Therefore, if you find a high parasite density, state the result clearly in your report and send it immediately to the patient's physician.

#### Reporting results

If the result of the examination of the stained blood films is positive, specify:

- the species of parasite found;
- the stage of development of the parasite;
- the parasite density.

Blood films containing *P. ovale* and *P. vivax* may contain few parasites and therefore take more time to examine under the microscope. However, it is necessary to differentiate the two species, since they may reappear in the blood without reinfection. Patients infected with *P. ovale* or *P. vivax* require additional treatment to eradicate the liver stages of these parasites.

A patient can harbour more than one species of malaria parasite at the same time (e.g. *P. falciparum* and *P. malariae* or *P. falciparum* and *P. vivax*).

If the result is negative, report as “no parasites found”.

#### 4.7.3 *Trypanosoma* spp.

Trypanosomiasis is caused by infection with parasitic protozoa of the genus *Trypanosoma*. It occurs in southern and western Africa, where it is known as sleeping sickness or African trypanosomiasis, and in Central and South America, where it is called Chagas disease.

### African trypanosomiasis

African trypanosomiasis occurs in three phases:

- the acute phase
- the parasitaemic phase
- the neurological phase.

Two or 3 days after the bite of an infected tsetse fly, a chancre appears at the inoculation site; it disappears within 2–3 weeks. From the site of the chancre, the trypanosomes invade the bloodstream, giving rise to occasional episodes of intermittent fever. The most common symptoms of the first or acute phase are headache, sleeplessness, pain in the joints and posterior lymph nodes of the neck, swelling of the eyelids and joints, weight loss and generalized intense itching, especially in the region of the breast bone. Invasion of the central nervous system causes irritability, paraesthesia, sleeplessness and eventually severe headaches and blurred vision, as well as epileptic attacks, psychotic phenomena, drowsiness, mental lethargy and coma.

Trypanosomiasis caused by *Trypanosoma brucei gambiense* generally has a slow and chronic course. Between the first and second phases, weeks or months can pass, and months or years may elapse between the second and third phases. Trypanosomiasis caused by *T.b. rhodesiense* follows a more acute course and the phases are less marked. It may cause death within a few months. Heart complications are more frequent in trypanosomiasis caused by *T.b. rhodesiense*, and some patients die before reaching the neurological phase.

Sources of infection and modes of transmission

African trypanosomiasis is transmitted by tsetse flies (*Glossina* spp.) and humans are the main reservoir of infection. Pigs, dogs and possibly other animal species can also harbour the parasite, but their role in spreading the disease is secondary.

Transmission occurs when tsetse flies ingest the blood of infected humans or animals.

#### *Examination of lymph node aspirates for Trypanosoma brucei gambiense and T.b. rhodesiense*

In patients with African trypanosomiasis trypanosomes are found in the lymph glands in the early stage, i.e. 2–3 weeks after infection. They disappear from the glands within 2–6 months. At a later stage the parasites may infect the central nervous system.

The standard method of diagnosis of African trypanosomiasis in the early stage is to search for trypanosomes in aspirates from enlarged cervical lymph nodes.

Principle

A drop of fluid from the lymph node is collected with a needle and examined immediately as a wet preparation. The trypanosomes, which are motile flagellate protozoa, are easily seen under the microscope.

Materials and reagents

- Microscope
- Microscope slides
- Coverslips
- Needle (for subcutaneous injection), 25-gauge
- Syringe, 5 or 10 ml (both syringe and needle must be perfectly dry)
- Tincture of iodine

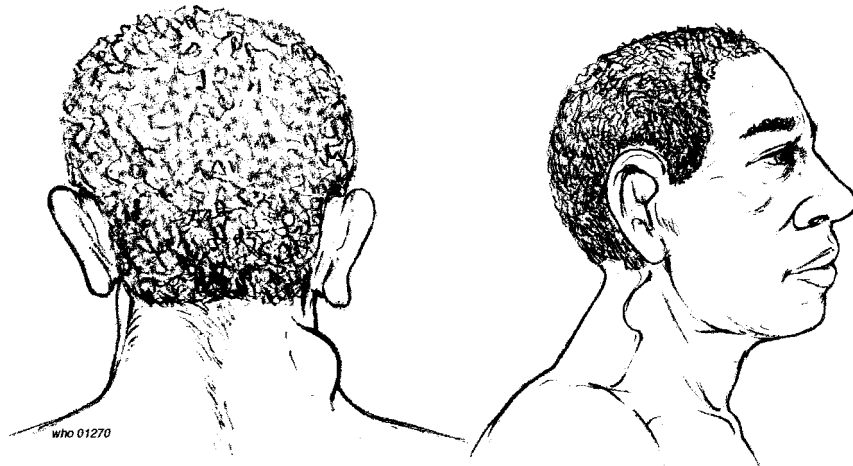

Fig. 4.141 Finding a lymph gland infected with trypanosomes

- 70% Ethanol
- Sodium chloride, 0.85% solution (reagent no. 53).

#### Method

##### *Finding a lymph gland*

Lymph nodes are found among the cervical glands of the neck. Feel both the right and the left sides of the neck, from the base of the neck up to the ears.

Affected glands are swollen and form a round lump 2–4 cm in diameter (Fig. 4.141). They are elastic and slide under the skin, offering little resistance to pressure. They do not become hard (except in chronic cases).

##### *Collection of samples*

1. Ask the patient to sit down. Disinfect the chosen site on the neck with ethanol.
2. With the left hand, take the gland between the thumb and the index finger and make it stand out (Fig. 4.142). Hold your hand steady.
3. Holding the needle between your thumb and forefinger, introduce it at right angles into the centre of the gland (Fig. 4.143). First pierce the skin, then penetrate the centre of the gland. Avoid the jugular vein and the arteries.
4. With the *left hand*, gently knead the gland.  
With the *right hand* revolve the needle in both directions (Fig. 4.144).
5. The glandular fluid will ooze into the needle. The operation should take about 1 minute.



Fig. 4.142 Making the lymph gland stand out



Fig. 4.143 Introducing a needle into the lymph gland



Fig. 4.144 Twist the needle in both directions



Fig. 4.145 Collecting a sample of fluid from the lymph node

6. Attach the needle to the syringe, with the piston pulled back (Fig. 4.145). Push the piston gently halfway down the barrel to discharge a drop of the glandular fluid in the needle on to a slide.

#### Microscopic examination

Examine the slide first using the  $\times 10$  objective, then change to the  $\times 40$  objective to examine the parasites in greater detail. Close the condenser iris diaphragm sufficiently to give a sharp image.

Wait until the convection currents stop. It is impossible to see the movement of trypanosomes among moving cells.

Begin by examining the periphery of the preparation, near the edges of the coverslip, as shown in Fig. 4.146, as the trypanosomes tend to make their way to the edges. Then examine the rest of the preparation.

The preparation will contain erythrocytes and leukocytes. Trypanosomes are about  $20\mu\text{m}$  long and are often hidden by cellular elements which are disturbed by the flagella of the trypanosomes as they move (Fig. 4.147).

#### Examination of blood films for *Trypanosoma brucei gambiense* and *T.b. rhodesiense*

##### Principle

Trypanosomes belonging to the species *Trypanosoma brucei* are detected in the blood:

- in wet preparations
- in thick films after staining
- following concentration by repeated centrifuging
- in serological tests.

**Important:** In African trypanosomiasis trypanosomes appear in the blood at intervals for a period of a few days, mainly during the first 3 months of the disease and especially during bouts of fever.

#### Microscopic examination of capillary blood

##### Materials and reagents

- Microscope
- Microscope slides

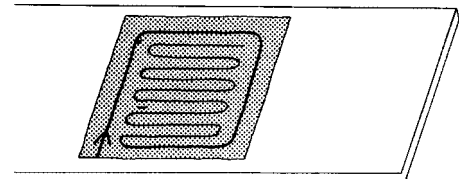

Fig. 4.146 Examining a lymph node sample under the microscope

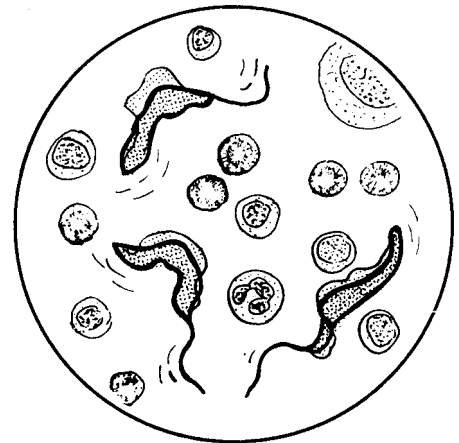

Fig. 4.147 Appearance of trypanosomes in a lymph node preparation

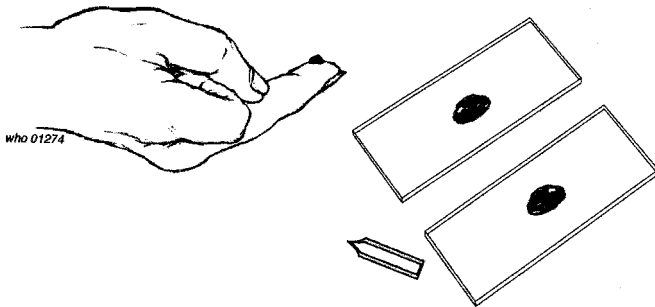

Fig. 4.148 Collecting a capillary blood sample on each of two slides

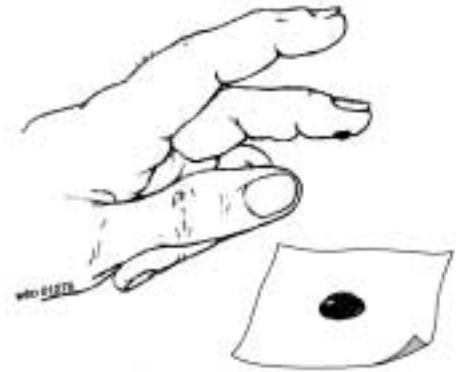

Fig. 4.149 Collecting a capillary blood sample on filter-paper

- Coverslips
- Blood lancets
- Filter-paper
- Sodium chloride, 0.85% solution (reagent no. 53)
- Giemsa stain (reagent no. 29) or Field stain (reagent no. 25)
- Buffered water, pH 7.2 (reagent no. 15)
- 70% Ethanol.

#### Method

1. Sterilize the pad of the third finger then prick with the blood lancet. Wipe away the first drop of blood with filter-paper. Collect two drops of blood (Fig. 4.148):
  - one drop on one slide
  - one drop on a second slide.
2. Collect two drops of blood on a piece of filter-paper (Fig. 4.149). Leave to dry.
3. On the first slide, place one drop of sodium chloride solution beside the drop of blood.
 

Mix, using the corner of a slide (Fig. 4.150). Cover with a coverslip.
4. On the other slide, spread the blood to make a thick film (see page 174).
 

Stain with Giemsa stain (see page 175) or Field stain (see page 177).

*Note:* Blood films must be stained and examined immediately after collection of blood samples, since trypanosomes lyse and disappear within a few hours.

#### Microscopic examination

**Wet preparation.** Examine the first slide (with the wet preparation) under the microscope, using the  $\times 40$  objective and reducing the condenser aperture.

Examine the edges of the smear first. Look for movement among the erythrocytes; trypanosomes will displace them with their flagellum as they move forward.

Make sure that the organisms are trypanosomes:

*Length:* 15–25  $\mu\text{m}$  (2–3 erythrocytes).

*Width:* 3  $\mu\text{m}$  (half an erythrocyte).

*Shape:* like an elongated fish.

*Motility:* trypanosomes move rapidly, advancing and contracting like a snake, and have an undulating membrane extending from a motile flagellum at the anterior end (Fig. 4.151).

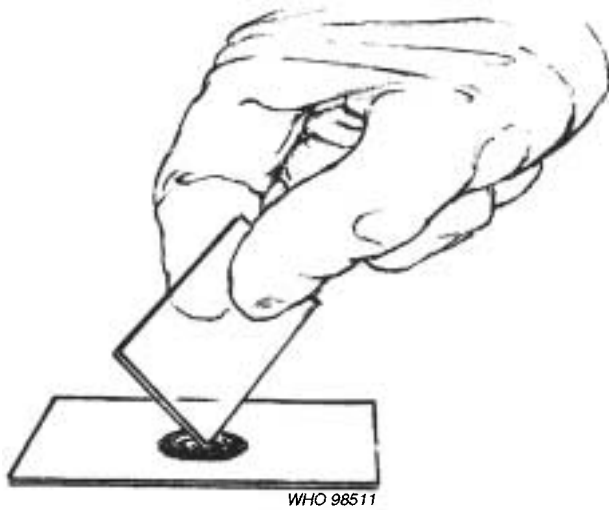

Fig. 4.150 Using a slide, mix the blood sample with saline solution

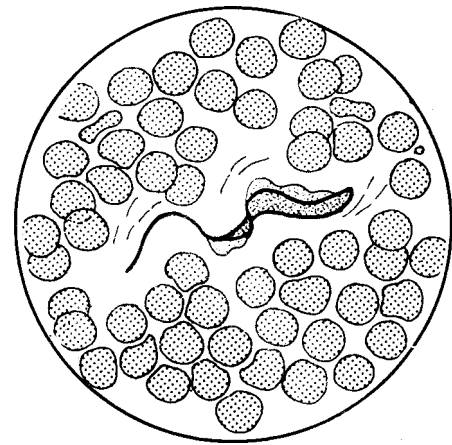

Fig. 4.151 Appearance of trypanosomes in a wet preparation

Do not confuse trypanosomes with microfilariae, which are much bigger (100–300  $\mu\text{m}$  or 10–40 erythrocytes).

**Thick films.** Thick films must always be examined, even if the examination of the wet preparation seems positive, to make sure that the motile organisms seen are trypanosomes.

Trypanosomes of *T.b. gambiense* and *T.b. rhodesiense* are identical in appearance in stained preparations (Fig. 4.152):

*Length:* 15–25  $\mu\text{m}$ .

*Cytoplasm:* pale blue.

*Nucleus:* large central nucleus, stained reddish-purple.

*Granules:* one compact red body at the posterior end: the kinetoplast.

*Undulating membrane:* reddish-pink, starting at the kinetoplast.

*Flagellum:* pink, extending 5  $\mu\text{m}$  beyond the undulating membrane.

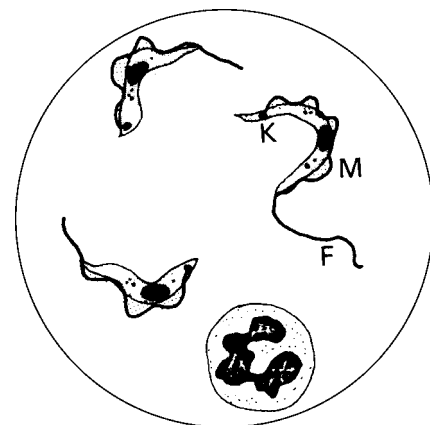

Fig. 4.152 Appearance of trypanosomes in a stained thick blood film  
F: flagellum; K: kinetoplast; M: undulating membrane.

If both slides are negative, repeat the tests for up to 7 days.

Send the dried drops of blood on the strip of filter-paper to an immunological reference laboratory for testing for immunoglobulin M (IgM) and specific antibodies.

Microscopic examination of venous blood concentrated by centrifugation

*Materials and reagents*

- Microscope
- Microscope slides
- Coverslips
- Centrifuge or microhaematocrit centrifuge
- Conical centrifuge tubes with a mark at 10ml or microhaematocrit capillary tubes
- Pasteur pipette
- Trisodium citrate, 3.2% solution (reagent no. 60).

*Method*

1. Pour 1 ml of trisodium citrate solution into a conical centrifuge tube.
2. Collect 9 ml of venous blood and add it to the trisodium citrate (i.e. fill the tube up to the 10-ml mark).
3. Mix and immediately centrifuge at 3000g for 3 minutes.
4. Draw off all the supernatant plasma and the layer of leukocytes above the deposit of erythrocytes.  
Expel this supernatant liquid into another tube (tube 2). Centrifuge at 3000g for 5 minutes.
5. Draw off all the supernatant fluid (but keep the deposit from tube 2).  
Expel the supernatant fluid into a third tube (tube 3). Centrifuge at 3000g for 10 minutes.
6. Examine the deposits of tubes 2 and 3 between a slide and a coverslip under the microscope.  
The trypanosomes will appear in the deposit from tube 3 (and occasionally in that from tube 2).

*Alternative method*

If a microhaematocrit centrifuge is available, venous (or capillary) blood with anti-coagulant can be collected into a microhaematocrit capillary tube. The method of collection and examination is as for microfilariae (see page 164). Motile trypanosomes, if present, can be found in the plasma just above the layer of leukocytes. First use the  $\times 10$  objective with reduced condenser aperture to detect any movement, then use the  $\times 40$  objective to see the trypanosomes more clearly.

***Card agglutination trypanosomiasis test (CATT) for African trypanosomiasis***

The card agglutination trypanosomiasis test (CATT) is a serological test that is used for the diagnosis of African trypanosomiasis.

## Materials and reagents

- Jar
- Tissue paper or cloth
- Glass stirring rods
- Dispensing vial droppers
- Rubber bulb for microhaematocrit tubes
- Syringes, 2.5 ml, with needles
- Blood lancets
- Heparinized microhaematocrit tubes
- Test cards
- Microhaematocrit tube holders with cover
- Manual or electric (12/220 V) rotator with cover
- Lyophilized antigen
- Lyophilized positive control serum
- Lyophilized negative control serum
- Buffer to reconstitute reagents.



The above materials and reagents are available commercially as a test kit. The quantities supplied are sufficient to carry out 250 tests. Before carrying out the test, prepare your materials and reconstitute the amount of reagents required for the day's work. Read and follow carefully the instructions provided in the kit.

#### Method

##### *Collection of samples*

1. Using a blood lancet, make a small puncture wound in the first, second or third finger of the patient. Collect the blood into a heparinized microhaematocrit tube (Fig. 4.153) until it is three-quarters full.
2. Immediately rotate the tube gently so that the blood runs from one end of the tube to the other (Fig. 4.154). Repeat the movement twice. This ensures that the blood and the heparin are mixed together, and prevents the sample from clotting in the tube.

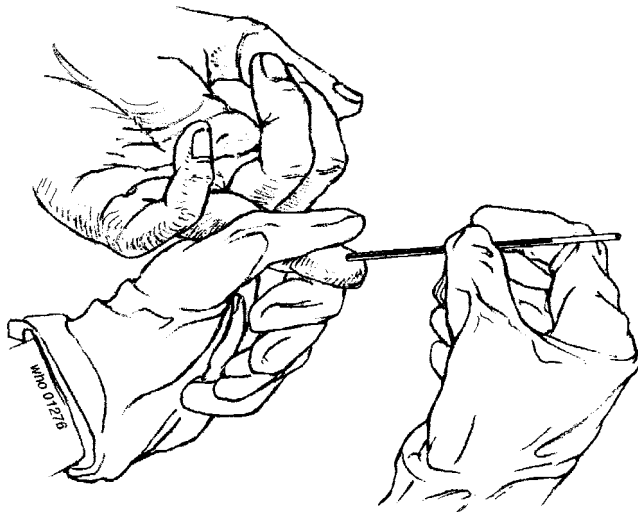

Fig. 4.153 Collecting a blood sample using a microhaematocrit tube

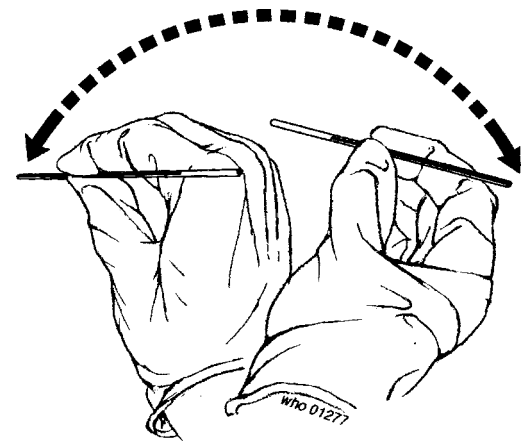

Fig. 4.154 Rotating the tube to mix the sample

3. Place the microhaematocrit tube in the special holder (supplied with the kit; Fig. 4.155). Keep the holder covered as much as possible to avoid dust and to prevent the blood sample from drying in the tube.

Microhaematocrit tube holders have 10 numbered slits. Make sure that you place the first tube in the first slit, etc.

Once the holder is full, pass it to the person performing the test.

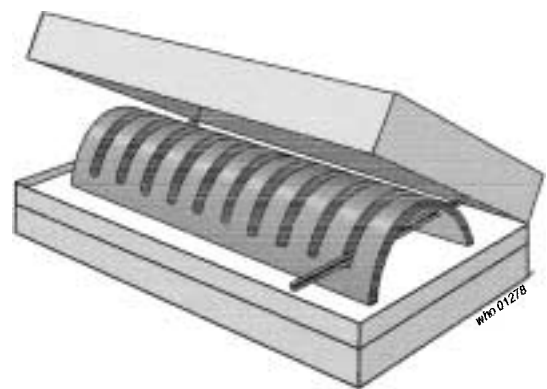

Fig. 4.155 A microhaematocrit tube holder

##### *Performing the test*

1. Prepare two test cards. Place one drop of the reconstituted antigen in wells 1 and 2 of the first card and in all the wells of the second card. Hold the vial vertically to have constant calibrated drops (Fig. 4.156).
2. Using the first card, check the quality of the reagent. Place one drop of the reconstituted positive control in well 1 and one drop of the reconstituted negative control in well 2 (Fig. 4.157).

*Note:* It is only necessary to do this once at the beginning of each day in a field survey.

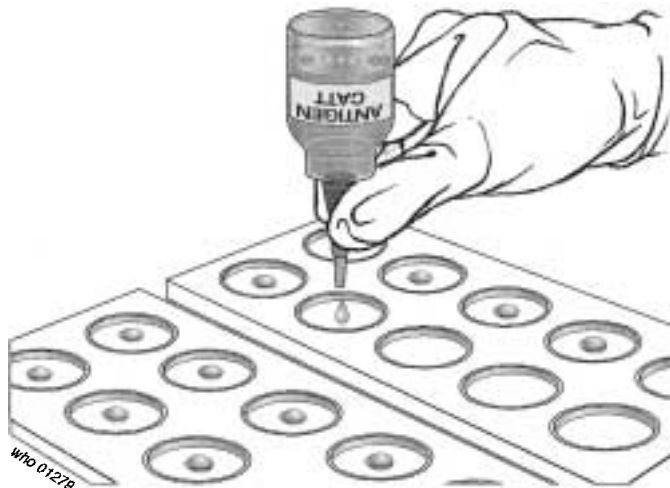

Fig. 4.156 Applying antigen to the test card

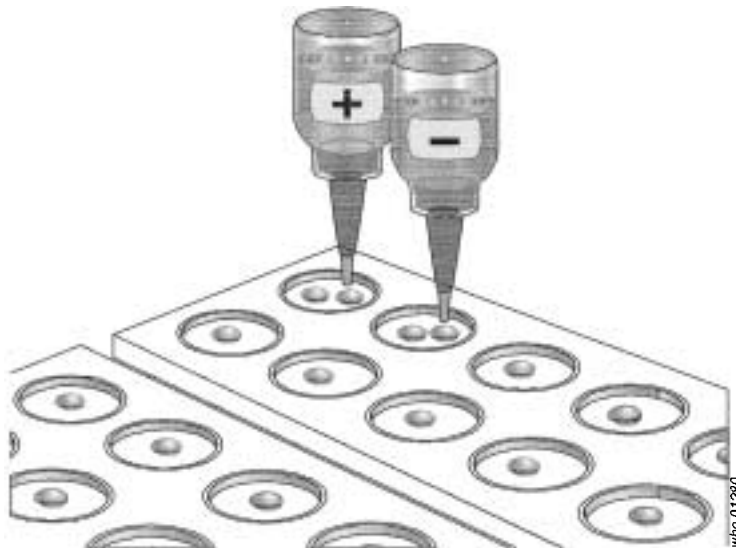

Fig. 4.157 Preparation of controls for the CATT

3. Using the second card, test the collected blood. Place one drop of blood from the first microhaematocrit tube in well 1, from the second tube in well 2, etc. (Fig. 4.158). Discard the microhaematocrit tube in a jar containing water with detergent.
4. Using a stirring rod, mix the reagents in each well of the first card and the reagents and blood samples in each well of the second card. Spread the mixture so that it covers the well (Fig. 4.159). Use a separate stirring rod for each well or clean the rod with a piece of tissue paper or a cloth between each well to avoid contamination of the samples.
5. Place both cards on the rotator, cover and set the timer to 5 minutes. If it is a manual rotator, check the time with your watch. The rotation speed should be slow, approximately 100g. If the rotation speed is too fast, clumps will settle at the edge of the wells; if it is too slow, the reaction will be weak.
6. After 5 minutes, examine the plates and record the reactions in each well. Do not allow the samples to dry out. If any samples have dried out, the test should be repeated.

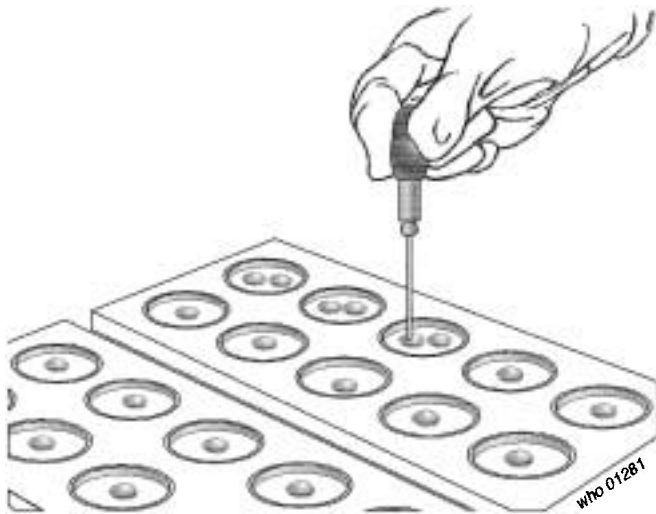

Fig. 4.158 Applying test samples to the test card



Fig. 4.159 Mixing the samples in each well of the test card

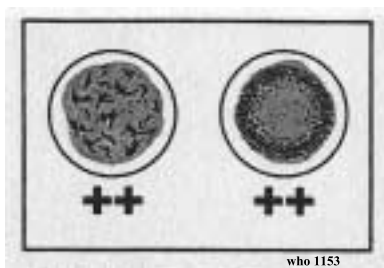

Fig. 4.160 Strong positive reaction in the CATT

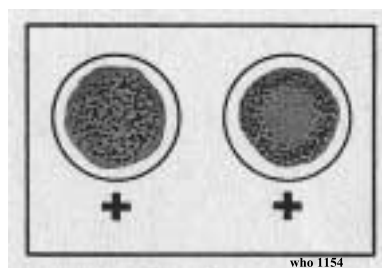

Fig. 4.161 Weak positive reaction in the CATT

### Results

Strongly positive reactions (Fig. 4.160)

Small or large clumps of particles are visible over the whole well or form a circle around the edge of the well.

Weak positive reactions (Fig. 4.161)

Very small clumps of particles are spread throughout the well or form a circle around the edge of the well. Repeat the test using serum or plasma.

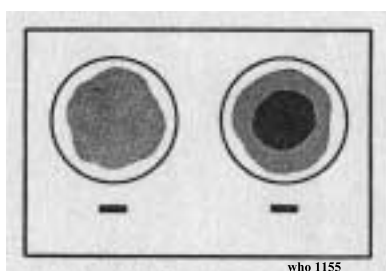

Fig. 4.162 Negative reaction in the CATT

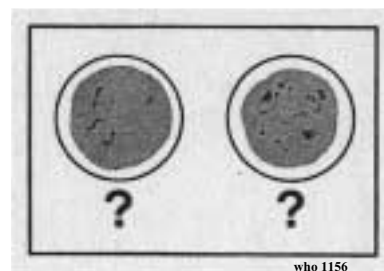

Fig. 4.163 Nonspecific reaction in the CATT

#### Negative reactions (Fig. 4.162)

No agglutination is visible. The reaction remains uniform or occasionally slightly denser in the centre.

#### Nonspecific reactions (Fig. 4.163)

A dried-up ring is observed around the edge of the well or small dots or fine threads are seen.

This type of reaction is usually negative. If you are in any doubt about it, repeat the test using serum or plasma.

*Note:* Discard any unused reconstituted reagents at the end of the day, unless they have been refrigerated. They will not keep and may give false results if used the next day.

#### *Other diagnostic tests for African trypanosomiasis*

In addition to the tests described above, African trypanosomiasis is also diagnosed in the laboratory by:

- examining lymph node aspirates for trypanosomes (see page 183);
- testing dried blood collected on filter-paper for IgM and specific antibodies (see page 187);
- inoculation of rats or mice with heparinized blood samples (only in specialized laboratories);
- examining CSF specimens for trypanosomes (see section 8.3.3, page 259).

#### **Chagas disease**

Chagas disease primarily affects children and is characterized by intermittent or continual high fever. About 50% of children manifest unilateral swelling of the eyelids (Romaña's sign). On other areas of the face or body, cutaneous lesions (chagomas) that resemble furuncles occur near the inoculation site. There may be generalized oedema of the entire body. Enlargement of the liver is common in children but not often seen in adults. The fever can be accompanied by myocarditis and meningitis. The infection of the digestive tract causes vomiting and diarrhoea. Primary infections can often pass unnoticed, but severe infections may be fatal.

After the acute phase, a period of latent infection follows (indeterminate phase); this phase is characterized by a low level of parasitaemia and absence of clinical symptoms. It can either persist indefinitely or may lead to the chronic form of the disease. The indeterminate phase is characterized by the presence of specific antibodies which can be detected by serological tests, but not by clinical symptoms.

Patients suffering from the chronic form of the disease exhibit signs of cardiac insufficiency. Abnormalities in the electrocardiogram are often apparent although

clinical symptoms are absent. Patients with the chronic form of the disease may deny having ever experienced the acute form, possibly because it passed asymptotically or because it occurred in childhood and has been forgotten.

Sources of infection and modes of transmission

In Chagas disease the parasite (*Trypanosoma cruzi*) is transmitted by bugs of the genus *Triatoma* that become infected by ingesting the blood of infected humans or animals. The parasite multiplies in the intestine of the triatomine bug. Humans are infected when the wound at the site of a triatomine bite is contaminated with the infected faeces of the bug.

There is a serious risk that Chagas disease may be transmitted via blood transfusion if proper precautions are not taken.

#### **Diagnostic tests for Chagas disease**

*Trypanosoma rangeli* infects humans in almost the same areas as *T. cruzi*. Although *T. rangeli* is not pathogenic, it must be identified and distinguished from *T. cruzi* for the diagnosis of Chagas disease.

**Important:** Motile trypanosomes are found in the blood during the acute phase of the disease, and rarely thereafter. During the chronic stage the diagnosis is based essentially on immunological methods.

The trypanosomes that cause Chagas disease are difficult to find in the blood. The same techniques are used as for African trypanosomiasis:

- examination of a wet preparation (see page 186; rarely positive during the chronic stage of the disease);
- examination of thick films (see page 187) repeated several days in succession;
- examination of blood films prepared from centrifuged blood samples (see pages 187–188);
- examination of dried blood samples for IgM and specific antibodies (see page 187).

Identification of *Trypanosoma cruzi* in thick blood films (Fig. 4.164)

**Length:** about 15  $\mu\text{m}$  in broad forms and 20  $\mu\text{m}$  in slender forms.

**Shape:** broad forms are C-shaped; slender forms are generally S-shaped.

**Cytoplasm:** pale blue.

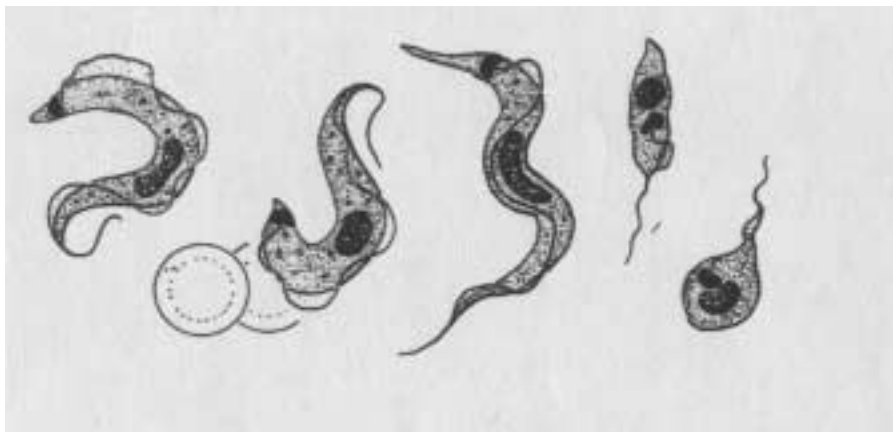

Fig. 4.164 Appearance of *Trypanosoma cruzi* in thick blood films

*Nucleus*: large, central and red.

*Kinetoplast*: large and round granule, dark red or purple, near the posterior extremity.

*Undulating membrane*: narrow, reddish-pink.

*Flagellum*: pink, extending beyond the undulating membrane.

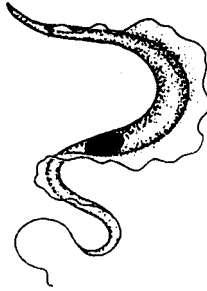

Fig. 4.165 Appearance of *Trypanosoma rangeli* in thick blood films

Identification of *Trypanosoma rangeli* in thick blood films (Fig. 4.165)

*Length*: 25–35  $\mu\text{m}$ .

*Shape*: only slender forms, with tapering extremities.

*Nucleus*: red, near the central part of the cell body.

*Kinetoplast*: small, like a dark red dot, far away from the posterior extremity.

*Undulating membrane*: visible, narrow.

*Flagellum*: extending beyond the undulating membrane.

#### 4.7.4 *Leishmania* spp.

Leishmaniasis is a group of diseases caused by infection with parasitic protozoa of the genus *Leishmania*. It can affect the skin (cutaneous leishmaniasis), mucous membranes (mucocutaneous leishmaniasis) and the reticuloendothelial system (visceral leishmaniasis or kala-azar).

The incubation period is generally from 2 to 6 months, but can vary from 10 days to several years. In some patients a primary lesion forms several months before the other symptoms appear. Amastigotes of the *Leishmania* spp. multiply slowly in macrophages near the site of inoculation. Some infected macrophages enter the bloodstream and reach the viscera, where the amastigotes multiply rapidly.

Clinically, the early phases of visceral leishmaniasis are characterized by chronic irregular fever, cough, diarrhoea and bleeding of the mucous membranes and secondary infections. Later, progressive enlargement of the spleen, liver and, occasionally, the lymph nodes, weight loss and — in some patients — patchy hypopigmentation of the skin occur.

Cutaneous leishmaniasis is characterized by skin ulcers, which may be single or multiple. In certain forms of cutaneous leishmaniasis plaques, papules or nodules may appear in different parts of the body.

The clinical symptoms of leishmaniasis may be similar to those found in schistosomiasis, chronic malaria and chronic leukaemia.

#### *Sources of infection and modes of transmission*

The epidemiology of the disease has unique features in each region and varies from one geographical area to another.

- In the Americas, infection is spread to humans by the bite of the phlebotomine fly *Lutzomyia longipalpis*. The vector feeds on dogs, wild animals and, less frequently, humans; it can be found both outside in the countryside and inside dwellings. The disease occurs mainly in rural areas.
- In India, humans are the main reservoir.
- In the Mediterranean basin and the Gulf area, dogs are the main reservoir, and the vectors are various species of the genus *Phlebotomus*.
- In Sudan, wild rodents and carnivores have been found to be reservoirs.

Transmission can take place inside dwellings, which constitute microfoci of infection.

## Examination of slit skin smears for diagnosis of cutaneous leishmaniasis

### Principle

Cutaneous leishmaniasis is diagnosed by demonstrating the typical amastigote stage of the organism from slit skin smears of ulcers.

Typical leishmaniasis ulcers are cratered with a raised edge. Slit skin specimens are collected from the edge of the ulcer.

### Materials and reagents

- Microscope
- Microscope slides
- Scalpel
- Gauze
- Slide rack
- Diamond pencil
- 70% Ethanol
- Methanol
- Giemsa stain (reagent no. 29)
- Phosphate-buffered water, pH 6.8 (reagent no. 43).

For use, dilute the Giemsa stain in phosphate-buffered water (1 volume of stain to 19 volumes of buffered water).

### Method

Collection of specimens

1. Clean the edge of the ulcer using a swab soaked in ethanol. Using the gauze pad compress the edge of the ulcer as firmly as possible to present a bloodless area.
2. Use the scalpel to make a superficial incision along the edge of the ulcer about 0.5 cm long and 2–3 mm deep. Still squeezing, turn the scalpel on to the flat side and gently scrape the base of the incision with the point of the blade. Collect tissue cells, but avoid drawing blood.
3. Spread the material collected from the tip of the blade on to a slide in a circular motion to cover an area of 5–7 mm in diameter. Allow the smear to air-dry and label the slide with a diamond pencil.

Staining of smears

1. Fix the air-dried smears by flooding the slide with methanol for 2 minutes.
2. Tip off the methanol and flood the slide with the diluted Giemsa stain for 20 minutes.
3. Rinse the slide in phosphate-buffered water and place it upside-down in a slide rack to drain and dry.

### Microscopic examination

Examine the slide under the microscope using the  $\times 100$  oil-immersion objective.

The amastigotes of *Leishmania* spp. may be found intracellularly in the macrophage cells or lying separately between the cells. They measure 2–4  $\mu\text{m}$  and have a prominent nucleus and a rod-shaped kinetoplast (Fig. 4.166). Both the nucleus and the kinetoplast stain red and the cytoplasm stains pale blue.

Report the result as “amastigotes of *Leishmania* spp. present” or “not found”.

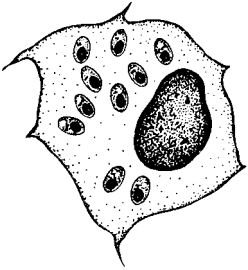

Fig. 4.166 *Leishmania* spp.  
amastigotes

### Formol gel test for visceral leishmaniasis

This test is a non-specific indicator for the increased serum levels of gamma globulin that are seen in most patients with visceral leishmaniasis.

#### *Materials and reagents*

- Test-tubes
- Test-tube rack
- Centrifuge
- Centrifuge tubes
- Formalin (37% formaldehyde).

#### *Method*

1. Collect 2–5 ml of blood into a centrifuge tube and allow it to clot.
2. Separate the serum by centrifuging the tube for 3 minutes at 5000g or by leaving the tube overnight in a refrigerator or on the bench.
3. Pipette 1 ml of clear serum into a test-tube.
4. Add two or three drops of formalin to the serum. Allow the tube to stand for 30 minutes.

#### *Results*

A positive result is shown by gelling of the serum — it becomes solid and turns white, usually after about 5 minutes.

A negative result is recorded when there is no gelling or whitening of the serum.

*Note:* Increased gamma globulin concentrations in serum are also seen following hepatitis B infection (see section 11.8) and in certain malignant diseases, such as multiple myeloma and Waldenström macroglobulinaemia.



---

# 5. Bacteriology



## 5.1 Introduction

Direct microscopic examination of smears is generally not sufficient to identify a bacterial species; precise identification can only be obtained by culture. The collection and dispatch of specimens to referral laboratories is, therefore, of utmost importance. Nevertheless, direct microscopic examination of stained smears is an efficient way of studying the presence of bacteria in biological fluids that are normally sterile and in specimens from other sources. It may provide information of great value for the diagnosis, immediate treatment and control of the disease. For example:

- Specimens from male patients with urethritis at an early stage can be used to diagnose gonococcal infection with reasonable certainty (in females it is much more difficult).
- Microscopic examination of sputum smears is a practical and effective technique for the detection of infectious cases of tuberculosis.
- Microscopic examination of CSF is used in identifying the bacteria or fungi that cause meningitis (see section 8.3.3).

The diagnosis of some diseases is also possible through serology; an example is syphilis (see section 11.10). Serological techniques are also important for epidemiological surveillance and early detection of diseases caused by bacteria that are difficult to culture (e.g. *Mycobacterium tuberculosis*).

## 5.2 Preparation and fixation of smears

### 5.2.1 Principle

The sample to be examined (pus, sputum, urine centrifugate, CSF, etc.) is prepared as follows:

- The specimen is spread in a thin layer on a glass slide.
- It is allowed to dry completely.
- It is fixed with 70% methanol or by heating before being stained.

### 5.2.2 Materials and reagents

- Inoculating loop: this is a metal wire (usually made of nickel–chromium alloy) fixed on to a handle and bent into a loop at the other end. Make the loop with forceps, taking care that it is centred (Fig. 5.1). The actual diameter of the loop should be 2 mm.
- Microscope
- Microscope slides
- Coverslips
- Bunsen burner or spirit lamp
- 70% Methanol.

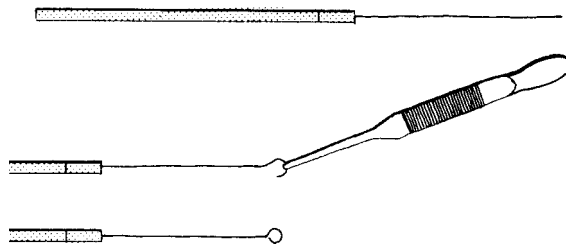

Fig. 5.1 Making an inoculating loop

### 5.2.3 Preparation of smears

1. Flame the loop until it is red-hot: hold the loop just above the blue part of the flame, as close to the vertical as possible (Fig. 5.2). Allow it to cool (count to 20).
2. Take a portion of the specimen to be examined by placing the loop *flat* on the surface of the liquid (Fig. 5.3).
3. Number a slide, then press the loop flat on to the centre of the slide (Fig. 5.4).
4. Still holding it flat against the slide, move the loop in an oval spiral, outwards from the centre (Fig. 5.5).

Leave a space between the specimen and each of the four sides of the slide. Let the slide dry completely in the air.

5. Repeat step 1.

Unmarked smears are sometimes received in the laboratory from outside sources.

To find out on which side of an unmarked slide the smear has been made, turn the slide so that it reflects the light from the window:

- The side without the smear will shine.
- The side with the smear will not reflect the light.

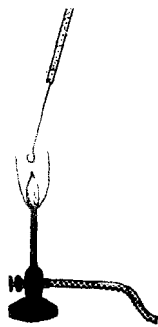

Fig. 5.2 Flaming an inoculating loop

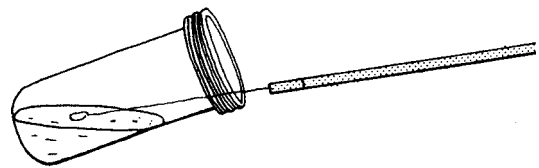

Fig. 5.3 Collecting a sample using an inoculating loop

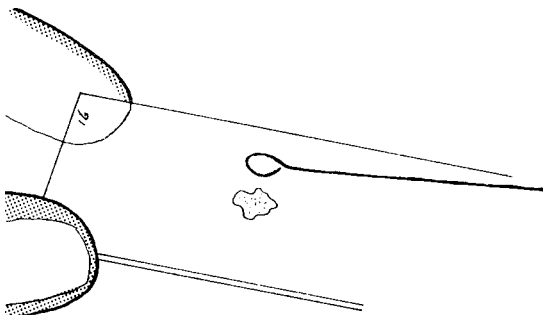

Fig. 5.4 Transferring a sample to a slide

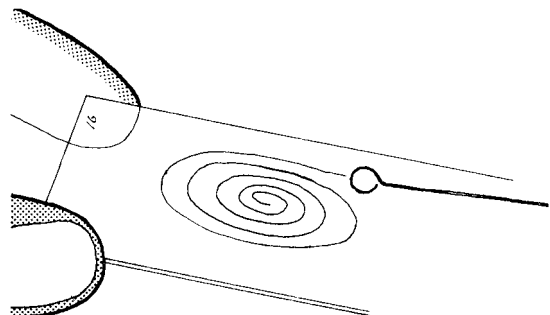

Fig. 5.5 Preparing a smear

### 5.2.4 Fixation of smears

When the smear has dried completely, fix it by covering the slide with a few drops of 70% methanol for 2 minutes or by quickly passing the back of the slide through the flame three times (Fig. 5.6).

The fixed smear can be stained as described in section 5.3.

It is sometimes useful to draw a circle around the smear with a grease pencil, so that it can be seen more easily.

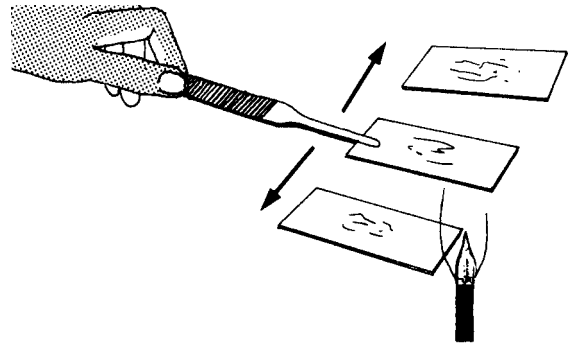

Fig. 5.6 Fixing a smear over a flame

## 5.3 Staining techniques

### 5.3.1 Gram staining

Gram stain will enable the smear to be examined by microscopy for the presence of bacteria, pus cells, Vincent's bacilli and *Candida albicans*. Commensal bacteria, which are always present, are not important. They do not need to be considered for further examination or reported.

#### Principle

- Crystal violet stains all bacteria deep violet (Fig. 5.7).
- Iodine solution fixes the violet colour more or less strongly in the bacteria (Fig. 5.8).
- 95% Ethanol:
  - decolorizes certain bacteria when the crystal violet is not strongly fixed by iodine solution (Fig. 5.9 (a));
  - does not decolorize other bacteria when the crystal violet is strongly fixed by iodine solution (Fig. 5.9 (b)).
- Carbol fuchsin, neutral red or safranin solution (pink):
  - re-stains (pink) the bacteria discoloured by ethanol (Fig. 5.10 (a))
  - has no effect on the other bacteria, which remain dark violet (Fig. 5.10 (b)).

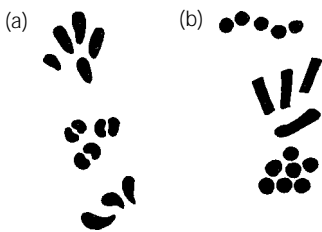

Fig. 5.7 Gram staining reaction: staining with crystal violet  
a: Gram-negative bacteria;  
b: Gram-positive bacteria.

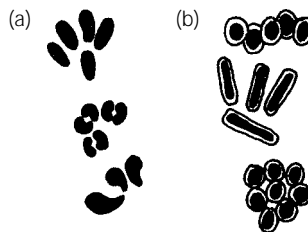

Fig. 5.8 Gram staining reaction: fixation using iodine  
a: Gram-negative bacteria;  
b: Gram-positive bacteria.

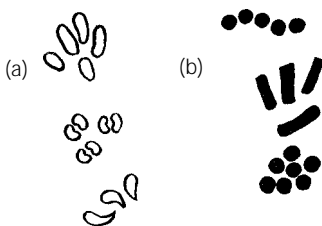

Fig. 5.9 Gram staining reaction: decolorization with ethanol  
a: Gram-negative bacteria;  
b: Gram-positive bacteria.

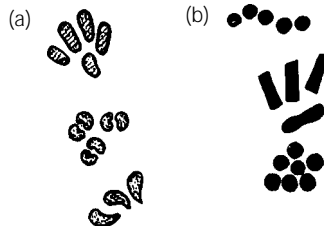

Fig. 5.10 Gram staining reaction: re-staining with carbol fuchsin, neutral red or safranin solution  
a: Gram-negative bacteria;  
b: Gram-positive bacteria.

### Materials and reagents

- Microscope
- Slide rack
- Crystal violet, modified Hucker (reagent no. 18)
- Lugol iodine, 0.1% solution (reagent no. 36)
- Acetone–ethanol decolorizer (reagent no. 4)
- Carbol fuchsin solution for Ziehl–Neelsen stain (reagent no. 16) (diluted 10-fold with 95% ethanol), neutral red, 0.1% solution (reagent no. 40) or safranin solution (reagent no. 47).

### Method

1. Fix the smear as described in section 5.2.4.
2. Cover the smear with crystal violet stain for 60 seconds.
3. Wash off the stain with clean water. Drain the slide and cover the smear with iodine for 60 seconds.
4. Wash off the iodine with clean water. Decolorize rapidly with acetone–ethanol. Only 2–3 seconds are needed.
5. Cover the smear with carbol fuchsin for 2 minutes.
6. Wash off the stain with clean water and place the slide upright in a slide rack to drain and air-dry.

### Microscopic examination

First examine the slide using the  $\times 40$  objective to see how the smear is distributed and then use the  $\times 100$  oil-immersion objective.

#### Gram-positive organisms

Gram-positive organisms appear dark purple (Fig. 5.11) (e.g. staphylococci, streptococci, micrococci, pneumococci, enterococci, diphtheria bacilli, anthrax bacilli).



Fig. 5.11 Gram-positive organisms



Fig. 5.12 Gram-negative organisms

#### Gram-negative organisms

Gram-negative organisms appear red (Fig. 5.12) (e.g. gonococci, meningococci, coliform bacilli, shigellae, salmonellae, cholera vibrios).

#### Identification of specific organisms

*Candida albicans* appears as large (2–4  $\mu\text{m}$  in diameter) oval or round Gram-positive spores (Fig 5.13(a)) with mycelium-like filaments of varying length with rounded ends (Fig. 5.13(b)).

“*Actinomycetes*” are seen as large granules, sometimes visible to the naked eye (white to yellow colour). The centre is Gram-negative, the periphery Gram-positive (Fig. 5.14). They are found in pus from skin, sputum, etc.

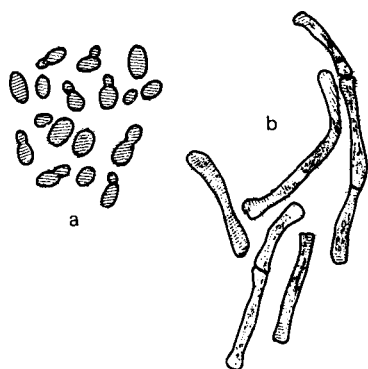

Fig. 5.13 *Candida albicans*

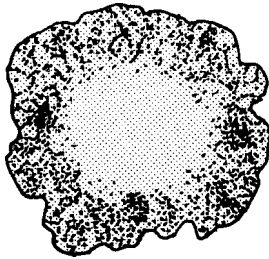

Fig. 5.14 "Actinomycetes"

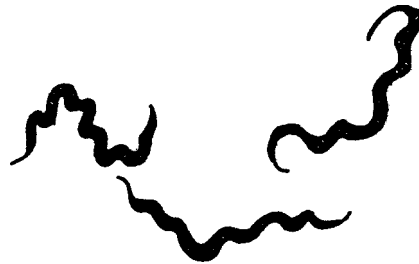

Fig. 5.15 Vincent's bacilli

*Vincent's bacilli* are seen as Gram-negative spirochaetes and fusiform rods (Fig. 5.15).

No other bacteria should be reported as there are many commensal bacteria which may be confused with pathogens.

#### Sources of error

A false Gram-positive reaction may occur because:

- The smear was fixed before it was dry.
- The smear was too thick.
- There was sediment in the bottle of crystal violet (filter before using).
- The iodine solution was not thoroughly washed off the slide.
- The acetone-ethanol was not left on the slide long enough.
- The carbol fuchsin (or safranin or neutral red) solution was too strong or left on the slide too long.

A false Gram-negative reaction may occur because:

- The iodine solution was not left on the slide long enough.
- The acetone-ethanol was left on too long or not washed off properly.

#### 5.3.2 Staining with Albert stain (for the detection of *Corynebacterium diphtheriae*)

If diphtheria is suspected a sputum smear should be stained with Albert stain. This stain is used to show the dark-staining volutin granules that appear in *Corynebacterium diphtheriae* bacilli (see Fig. 5.16).

#### Materials and reagents

- Microscope
- Slide rack
- Albert stain (reagent no. 7).

#### Method

1. Fix the smear as described in section 5.2.4.
2. Cover the smear with Albert stain for 3–5 minutes.
3. Wash off the stain with clean water and place the slide upright in a slide rack to drain and air-dry.

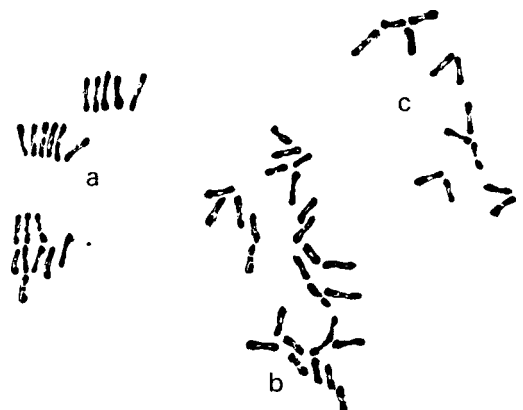

Fig. 5.16 *Corynebacterium diphtheriae*  
*C. diphtheriae* rods may be arranged in rows (a) or in V-formation (b) or joined at angles, giving the appearance of Chinese characters (c).

### Microscopic examination

First examine the slide using the  $\times 40$  objective to see how the smear is distributed and then use the  $\times 100$  oil-immersion objective.

*Corynebacterium diphtheriae* appears as green rods (Fig. 5.16) containing green–black volutin granules. The rods may be arranged in rows (a) or in V-formation (b), or joined at angles, giving the appearance of Chinese characters (c). The presence of slender rods containing volutin granules is sufficient evidence for starting treatment for diphtheria.

If diphtheria is suspected, a specimen should be sent to the bacteriology laboratory for culture (see section 5.4.4).

### 5.3.3 Staining with Ziehl–Neelsen stain (for the detection of acid-fast bacilli)

Ziehl–Neelsen stain is used to identify mycobacteria and oocysts of *Cryptosporidium* spp. (see section 4.3.2, page 123).

#### Principle

When mycobacteria and oocysts of *Cryptosporidium* spp. are stained with a hot strong solution of carbol fuchsin, they resist decolorization with a solution of acid or acid–ethanol and stain red. Tissues and other organisms are decolorized by the acid–ethanol solution and are demonstrated by a counterstain such as methylene blue, which stains them blue.

*Mycobacterium leprae* and oocysts of *Cryptosporidium* spp. only resist decolorization with weak solutions of acid or acid–ethanol. They are demonstrated using the modified Ziehl–Neelsen technique (Table 5.1).

*Mycobacterium* spp. and oocysts of *Cryptosporidium* spp. are referred to as “acid-fast” due to their resistance to decolorization with acid solution. They do not stain well with Gram stain or simple stains such as methylene blue.

#### Materials and reagents

- Microscope
- Spirit lamp or Bunsen burner
- Slide rack
- Forceps
- Carbol fuchsin solution for Ziehl–Neelsen stain (reagent no. 16) (filtered before use)

**Table 5.1 Organisms stained by Ziehl–Neelsen stain**

Sample	Organism
Sputum	<i>M. tuberculosis</i>
	<i>M. bovis</i>
Skin	<i>M. leprae</i>
	<i>M. ulcerans</i>
Urine	<i>M. tuberculosis</i>
	<i>M. bovis</i>
Stool	<i>Cryptosporidium</i> spp.
Gastric lavage	<i>M. tuberculosis</i>
	<i>M. bovis</i>

**Table 5.2 Reporting the number of acid-fast bacilli present**

Number of acid-fast bacilli present per microscope field	Result
< 0.1 (< 10 per 100 fields)	Specify number present per 100 fields
0.1–1 (10–100 per 100 fields)	+
1–10	++
> 10	+++

- Acid-ethanol for Ziehl-Neelsen stain (reagent no. 5)
- Malachite green, 1% solution (see reagent no. 31), diluted 1:1 with distilled water, or methylene blue solution (reagent no. 39).

### Method

1. Fix the smear as described in section 5.2.4.
2. Cover the smear with filtered carbol fuchsin stain. Using forceps, gently heat the slide over a spirit lamp or Bunsen burner until the stain starts to evaporate (at about 60 °C — do not overheat).
3. Leave the stain on the slide for 5 minutes.
4. Wash off the stain with clean water and cover the smear with acid-ethanol for 5 minutes or until the smear is pale pink.
5. Wash the slide well in clean water and cover the smear with malachite green or methylene blue for 1–2 minutes.
6. Wash off the stain with clean water and place the slide upright in a slide rack to drain and air-dry. Do not blot the smear.

### Microscopic examination

Examine the slide under the microscope; first use the  $\times 40$  objective to see how the smear is distributed. Then systematically examine the slide with the  $\times 100$  oil-immersion objective to look for acid-fast bacilli (red bacilli). Examine the slide from end to end in steps until the whole smear is covered. Count the number of acid-fast bacilli present per microscope field (or per 100 microscope fields, if very few acid-fast bacilli are present).

Before moving to another slide, wipe the objective clean with lens tissue to prevent transfer of acid-fast bacilli to another slide.

If red bacilli can be seen, report as “acid-fast bacilli present”. Report the numbers of acid-fast bacilli present as described in Table 5.2.

If no acid-fast bacilli are seen, report as “no acid-fast bacilli found”.

#### 5.3.4 Staining with Wayson stain (for the detection of *Yersinia pestis*)

Wayson stain is used to identify *Yersinia pestis* in bubo aspirates (see section 5.10).

### Materials and reagents

- Microscope
- Slide rack
- 70% Methanol
- Wayson stain (reagent no. 63).

### Method

1. Fix the smear with methanol for 2 minutes.
2. Cover the smear with Wayson stain for 15 seconds.
3. Wash the slide in clean water and place it upright in a slide rack to drain and air-dry.

### Microscopic examination

First examine the slide using the  $\times 40$  objective to check the distribution of the material and then use the  $\times 100$  oil-immersion objective.

*Yersinia pestis* appears as bipolar organisms which stain blue with pink ends.

### 5.3.5 Staining with Loeffler methylene blue (for the detection of *Bacillus anthracis*)

Loeffler methylene blue is used to stain *Bacillus anthracis*, which causes anthrax (see section 5.11).

*Note:* Anthrax is a highly contagious disease. Gloves and protective clothing should therefore be worn when specimens suspected of being infected with anthrax are handled. The staining procedure should be carried out in a safety cabinet.

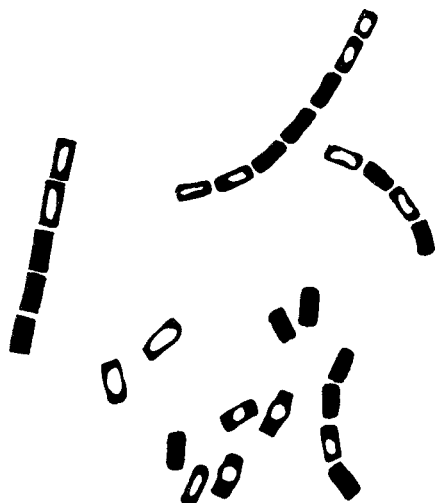

Fig. 5.17 *Bacillus anthracis*

### Materials and reagents

- Microscope
- Slide rack
- Potassium permanganate, 4% solution (reagent no. 46)
- Loeffler methylene blue (reagent no. 35).

### Method

1. Cover the slide with potassium permanganate for 10 minutes.
2. Wash the slide in clean water and cover the smear with Loeffler methylene blue for 1 minute.
3. Wash off the stain with clean water and place the slide upright in a slide rack to drain and air-dry.

### Microscopic examination

First examine the slide using the  $\times 40$  objective and then use the  $\times 100$  oil-immersion objective.

*Bacillus anthracis* appears as large blue rods surrounded by a mauve capsule; the bacilli appear in chains (Fig. 5.17).

## 5.4 Examination of sputum specimens and throat swabs

The presence of pathogenic organisms is revealed by microscopic examination of sputum specimens and throat swabs. The organisms include:

- Bacteria: Gram-positive and Gram-negative acid-fast bacilli.
- Fungi or yeasts: filaments of mycelium with or without pores. They may be pathogenic or saprophytes that have multiplied in the sample after collection (correct identification by a specialized laboratory necessary).
- Actinomycetes: granules, see page 200.



- Parasites: eggs of pulmonary flukes and, very rarely, eggs of schistosomes and adult worms of *Mammomonogamus laryngeus*.

Culture is often necessary for the identification of the infective agents.

#### 5.4.1 Materials and reagents

- Microscope
- Microscope slides
- Wide-necked, leakproof containers for sputum specimens, such as jars or stiff paper boxes (see section 2.5.5)
- Sterile cotton wool swabs
- Tongue depressor or spatula
- Test-tubes
- Sodium chloride crystals
- *N*-cetylpyridinium chloride
- Distilled water.

If possible, sterile cotton wool swabs should be prepared at a central-level laboratory; otherwise, the following technique may be used.

1. Prepare some thin sticks of wood (or aluminium wire), 18 cm long and 2 mm in diameter. Prepare strips of cotton wool, 6 cm long by 3 cm wide and as thin as possible.
2. Roll the cotton wool round one end of the stick (or wire).
3. Mould the swab into a conical shape.
4. Place in a glass test-tube. Plug with non-absorbent cotton wool. Sterilize (see section 3.5.5).

#### 5.4.2 Method

##### Collection of specimens

##### *Sputum specimens*

Sputum specimens should be collected early in the morning.

1. Ask the patient to take a deep breath and then cough deeply, spitting what he or she brings up into the container (Fig. 5.18).

Secure the top and label the container with the name and number of the patient.

Check that a sufficient amount of sputum has been produced.

2. If the specimen is to be dispatched to a laboratory for culture of *Mycobacterium tuberculosis* (see section 5.4.4), ask the patient to expectorate directly into a wide-mouthed, screw-topped jar containing 25 ml of the following solution:

<i>N</i> -cetylpyridinium chloride	5 g
Sodium chloride	10 g
Distilled water to	1000 ml.

Screw on the top and label the jar with the patient's name and the date of collection of the specimen (see section 3.7.1).

**Important:** Liquid frothy saliva and secretions from the nose and pharynx are not suitable for bacteriological examination. Ask the patient to produce another specimen.



Fig. 5.18 Collecting a sputum sample

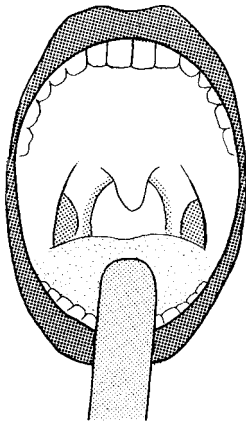

Fig. 5.19 Examining the back of the throat

### Throat specimens

1. Using a tongue depressor or a spatula to press the tongue down (Fig. 5.19), examine the back of the throat.
2. Look carefully for signs of inflammation and any exudate, pus, membraneous deposits or ulcers.
3. Use a sterile cotton wool swab to swab the infected area. Take care not to contaminate the swab with saliva. Return the swab to the sterile test-tube.

### Preparation of slides

Prepare two smears from each of the specimens (see section 5.2.3). Stain one smear with Albert stain (see section 5.3.2) and the other with Ziehl–Neelsen stain (see section 5.3.3).

### 5.4.3 Microscopic examination

Examine the sputum with the naked eye and then by microscopy.

The sputum of a person suffering from a bacterial infection usually contains:

- thick mucus with air bubbles
- threads of fibrin
- patches of pus
- occasional brownish streaks of blood.

After visual inspection report the appearance of the sputum as:

- purulent: greenish, containing pus;
- mucopurulent: greenish, containing both pus and mucus;
- mucoid: containing mostly mucus;
- mucosalivary: containing mucus with a small amount of saliva.

If there is blood present, this must also be reported.

A sputum sample composed mostly of saliva will not be useful either for culture or for direct examination.

Examine the smear stained with Albert stain as described in section 5.3.2. If green rods containing green-black volutin granules (see Fig. 5.16) are seen, report as “*Corynebacterium diphtheriae* present”.

Examine the smear stained with Ziehl–Neelsen stain as described in section 5.3.3. If red bacilli can be seen, report as “acid-fast bacilli present”. Report the numbers of acid-fast bacilli present as described in Table 5.2. If no acid-fast bacilli are seen, report as “no acid-fast bacilli found”.

### 5.4.4 Dispatch of specimens for culture<sup>1</sup>

#### Sputum specimens

Sputum specimens are sent to a bacteriology laboratory for culture of *Mycobacterium tuberculosis*, antimicrobial susceptibility testing and inoculation into guinea-pigs.

The specimen should be collected in a transport medium as described in section 5.4.2 and dispatched immediately to the laboratory.

Maximum preservation time: 10 days.

<sup>1</sup>See also section 3.7.1.

## Throat specimens

### *For routine investigation*

As soon as the specimen has been collected, replace the swab in the sterile test-tube (see section 5.4.2) and send it immediately to the bacteriology laboratory.

### *For confirmation of *Corynebacterium diphtheriae* infection*

If diphtheria is suspected, the specimen should be sent in a sterile tube containing coagulated serum (which must be stored in a refrigerator).

Rub the swab over the slanted surface of the serum, starting from the bottom and not applying pressure (Fig. 5.20). Send the same day.

Maximum preservation time: 24 hours.

### *For detection of meningococci*

This is seldom necessary, except for epidemiological surveys aimed at identifying carriers of meningococci. If possible, use a transport medium such as Stuart transport medium, modified (reagent no. 56).

Rub the swab over the surface of the medium from one side of the bottle to the other, starting from the bottom (Fig. 5.21). Send the same day.

Maximum preservation time: 3 days.

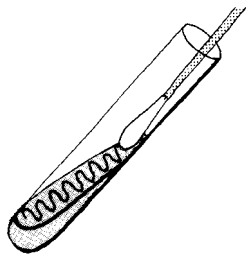

Fig. 5.20 Dispatching throat specimens in coagulated serum

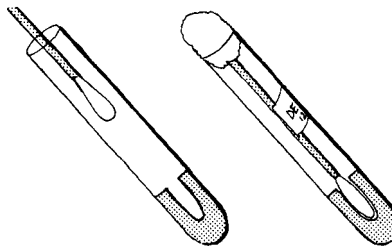

Fig. 5.21 Dispatching throat specimens in Stuart transport medium

## 5.5 Examination of urogenital specimens for gonorrhoea

### 5.5.1 Materials and reagents

- Microscope
- Microscope slides
- Bottle, 100 ml
- Pasteur pipette
- Cotton wool
- Amies transport medium (reagent no. 9).

### 5.5.2 Method

#### Collection of specimens

##### *From male patients*

1. If possible collect the specimen first thing in the morning before the patient passes urine.

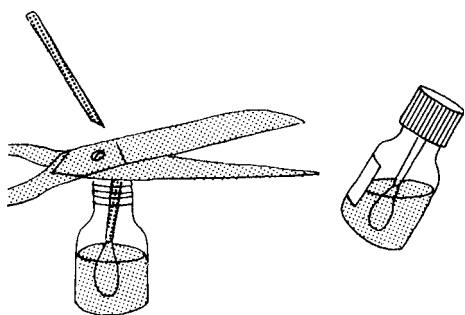

Fig. 5.22 Transferring a urogenital specimen to Amies transport medium

2. Clean around the urethral opening with sterile saline.
3. Apply gentle pressure on the penis so that a drop of pus appears on the meatus; if no pus appears, gently massage the urethra from above downwards.
4. Collect a sample of the pus using a sterile cotton wool swab on a stick (see section 5.4.1). Insert the swab into a small bottle containing Amies transport medium. Cut the stick to allow the top to be tightened (Fig. 5.22).
5. Use another swab to collect a drop of the pus for Gram staining (see section 5.3.1).

#### From female patients

The specimen should be taken from the cervical canal by a physician or specialist nurse. In cases of chronic gonorrhoea, the specimen should be taken just before or just after the menstrual period.

#### Preparation of slides

Prepare a smear from each of the specimens. Leave the smears to air-dry and then stain with Gram stain (see section 5.3.1).

#### 5.5.3 Microscopic examination

Microscopic examination is of great value in the diagnosis of gonorrhoea in males: it is much less so in females. Culture is therefore necessary to isolate and identify the gonococci in specimens from females.

Examine the slides using the  $\times 100$  oil-immersion objective. Pay particular attention to the edges of the smears, where the elements are spread more thinly and are easier to see and the stain is less concentrated.

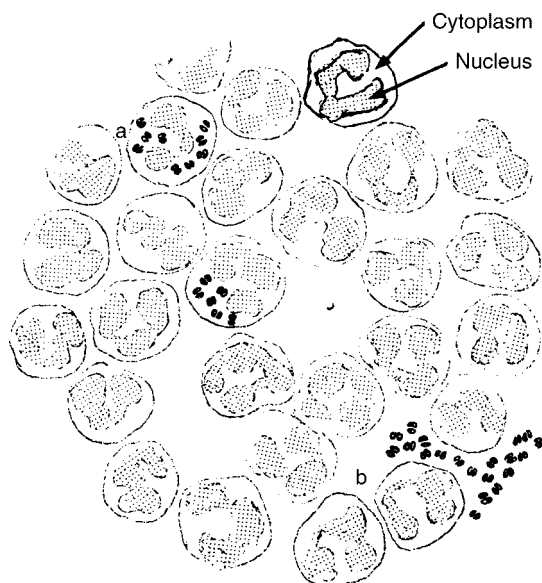

Fig. 5.23 Gonococci and pus cells  
a: Intracellular gonococci; b: extracellular gonococci.

#### Pus cells

Pus cells have a pink nucleus and a colourless cytoplasm. The nucleus may appear degenerated.

#### Gonococci

Gonococci appear as Gram-negative diplococci (in pairs) (Fig. 5.23 (a)). Cocci appear oval and kidney-shaped. Extracellular Gram-negative diplococci (Fig. 5.23 (b)) should also be reported.

A presumptive diagnosis of gonorrhoea can be made if Gram-negative intracellular diplococci are seen in smears from male patients. Extracellular Gram-negative diplococci may be seen if the pus cells are damaged.

Report as:

- Gram-negative intracellular diplococci present;
- Gram-negative extracellular diplococci present;
- no Gram-negative diplococci found.

### Other bacteria that cause infections in male patients

Numbers of the following may occasionally be seen in smears of urethral pus:

- Gram-positive cocci (e.g. staphylococci);
- Gram-positive bacilli (e.g. diphtheria bacilli);
- Gram-negative bacilli (e.g. coliform bacilli).

These organisms are described in section 5.3.1.

### Other bacteria that cause infections in female patients

All kinds of organisms are found in the smears, particularly:

- Gram-positive bacilli;
- Gram-negative cocci (saprophytes).

## 5.5.4 Dispatch of specimens for culture<sup>1</sup>

### Using Stuart transport medium

Sending the specimen in Stuart transport medium, modified (reagent no. 56) is the best method, if the medium can be obtained from a specialized laboratory. It is usually supplied in 30-ml flat bottles that contain 8 ml of solid medium (along one side of the bottle) and are filled with a mixture of air (90%) and carbon dioxide (10%). Round bottles may also be used. The bottle should remain open for as short a time as possible to prevent the escape of gas.

#### Method

1. Place the bottle of medium upright. Collect the pus specimen on a swab as described in section 5.5.2. Unscrew the bottle cap.
2. Holding the bottle as upright as possible (to prevent the gas escaping), rub the swab of pus over the whole surface of the solid medium, from one side of the bottle to the other, starting from the bottom (see Fig. 5.22).
3. Replace the cap on the bottle at once. Dispatch the bottle (at ambient temperature) immediately.

Maximum preservation time: 3 days, but the shorter the delay the better.

This transport medium is also suitable for meningococci.

### Using a Pasteur pipette

#### Method

1. Collect the pus specimen on a sterile cotton wool swab as described in section 5.5.2.
2. Draw the pus specimen into a sterile Pasteur pipette plugged with cotton wool.
3. Place the pipette in a sterile test-tube, padded and plugged with cotton wool, as shown in Fig. 5.24.

Maximum preservation time: 6 hours (at ambient temperature).

## 5.6 Examination of genital specimens for syphilis

Syphilis is a sexually transmitted disease caused by *Treponema pallidum* and occurs in three clinical stages.



Fig. 5.24 Dispatching urogenital specimens in a Pasteur pipette

<sup>1</sup> See also section 3.7.1.

The *primary stage* is characterized by a painless genital ulcer (syphilitic chancre), sometimes with enlargement of the lymph nodes in certain regions of the body. The chancre heals spontaneously, even when untreated.

In some patients the disease progresses to the *secondary stage*.

The secondary stage results in:

- skin rash
- mouth ulcers
- genital warts
- generalized enlargement of lymph nodes.

The *tertiary stage* is very rare and is characterized by central nervous system involvement and cardiac disease.

Secondary or tertiary syphilis may be transmitted to a fetus in utero (congenital syphilis).

### Yaws

Yaws is caused by a non-venereal treponeme (*Treponema pertenue*) and occurs in humid tropical climates. It is characterized by granular papillomas on the skin.

*T. pallidum* and *T. pertenue* are delicate, tightly-coiled spirochaetes measuring 6–12  $\mu\text{m}$   $\times$  0.2  $\mu\text{m}$ . They are indistinguishable under the microscope.

It is necessary to inspect samples suspected of being infected with spirochaetes by dark-field microscopy as they do not stain easily for viewing by transmitted light.

#### 5.6.1 Materials and reagents

- Microscope with dark-field attachment
- Microscope slides
- Coverslips
- Gloves
- Gauze
- Sterile lancet or scalpel
- Sodium chloride, 0.85% solution (reagent no. 53).

#### 5.6.2 Method

##### Collection of specimens

*Important:*

- Wear protective gloves for this procedure.
- The chancre area should be clear of any ointment before attempting to collect the specimens.

1. Collect the chancre specimen with gauze moistened with sodium chloride solution.
2. If there is no obvious serous fluid, gently scrape the edge of the ulcer with a sterile lancet or the flat edge of a scalpel blade (Fig. 5.25). Do not draw blood.
3. Compress the ulcer gently with a gauze pad.
4. Using a coverslip, collect a drop of the serous exudate and invert it immediately onto a slide.

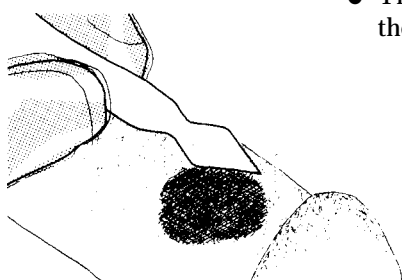
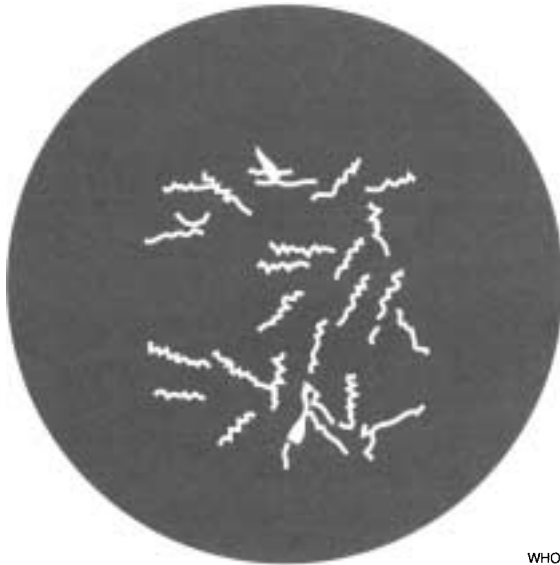

Fig. 5.25 Collecting a chancre specimen

### 5.6.3 Microscopic examination

Examine the slide using the dark-field microscope.

With experience of dark-field microscopy, the treponemes may be seen and can be distinguished from saprophytic treponemes by their size, characteristic movement and typical number of coils (Fig. 5.26).



WHO 01.157

Fig. 5.26 Treponemes

## 5.7 Examination of semen specimens

Semen is investigated in patients to exclude infertility. This is done by assessing the functional characteristics of spermatozoa in the seminal fluid.

### 5.7.1 Materials and reagents

- Microscope
- Microscope slides
- Coverslips
- Blood (Sahli) pipette
- Graduated cylinder, 10 ml
- pH indicator paper
- Improved Neubauer counting chamber
- Sodium bicarbonate
- Phenol or formalin (37% formaldehyde)
- Distilled water
- Petroleum jelly.

Before collecting the semen specimen, prepare the semen diluting fluid as follows:

- |                      |         |
|----------------------|---------|
| — sodium bicarbonate | 5 g     |
| — phenol or formalin | 1 ml    |
| — distilled water to | 100 ml. |

### 5.7.2 Method

#### Collection of specimens

The semen is collected by the patient in a clean, dry bottle and is brought to the laboratory as soon as possible after collection, preferably within 30 minutes. It cannot be examined immediately as semen is a highly viscous fluid and must “liquefy”. It does this within 15–30 minutes and should be examined as soon as possible after liquefaction has taken place.

#### Preparation of slides

After liquefaction has taken place, make a thin smear of semen on a slide (similar to a blood smear), let it dry in the air and then heat it very gently to fix. Remove the mucus (which will interfere with staining) by washing the slide with semen diluting fluid (see above). Then wash the slide gently with buffered distilled water.

Stain the sperm with Leishman stain or Giemsa stain (see section 9.10.3, page 303–304).

### 5.7.3 Macroscopic examination

#### Volume

Measure the volume in a small graduated cylinder — the amount varies from only a few drops up to 10 ml. The normal volume is 4–5 ml. Less than 1.5 ml is considered abnormal.

#### Viscosity

Freshly ejaculated semen should be completely liquefied within 30 minutes. Absence of liquefaction may interfere with sperm motility and fertilization.

#### Colour

Semen is normally an opaque grey colour. After an extended period of abstinence from sexual activity it may appear slightly yellow.

#### pH

The pH is usually noted though it is of little significance. Semen is always alkaline, with an average pH of about 7.6 (range 7.2–8.9).

### 5.7.4 Microscopic examination

Normal spermatozoa are 50–70  $\mu\text{m}$  in length, with a large oval head, a small neck and a long slender tail; the tail takes up about 90% of the total length (Fig. 5.27). The head is 3–6  $\mu\text{m}$   $\times$  2–3  $\mu\text{m}$ .

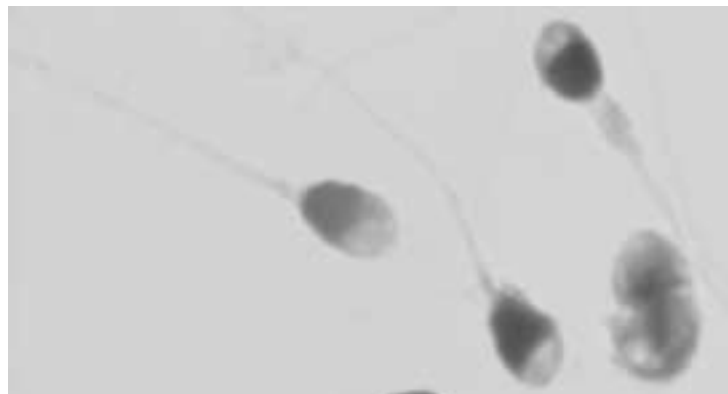

Fig. 5.27 Normal spermatozoa  
Source: Image House Medical, Sperm MORPH system. Used with permission.



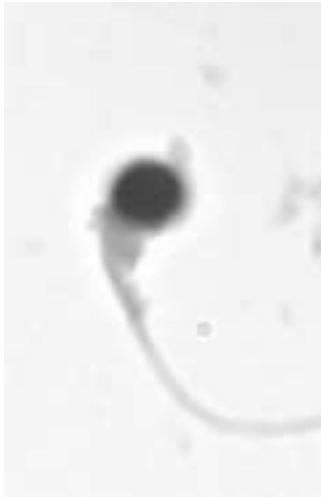

Fig. 5.28 Spermatozoan with an abnormally shaped head  
Source: Image House Medical, Sperm MORPH system. Used with permission.



Fig. 5.29 Spermatozoan with an abnormally small head  
Source: Image House Medical, Sperm MORPH system. Used with permission.

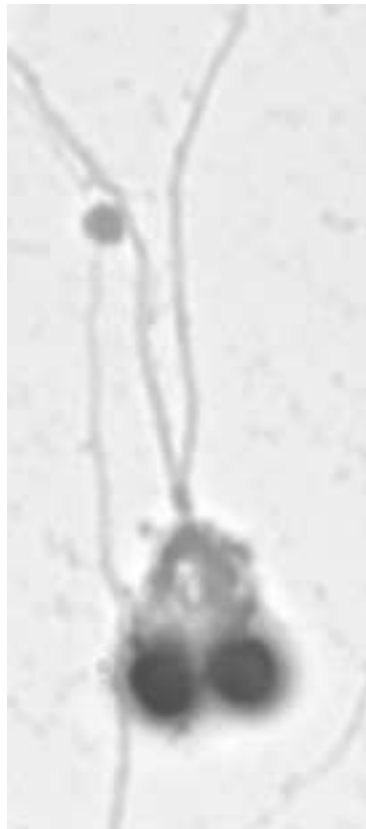

Fig. 5.30 Spermatozoan with a double head  
Source: Image House Medical, Sperm MORPH system. Used with permission.

The abnormalities of morphology to be looked for include:

- abnormally shaped heads (Fig. 5.28);
- abnormally sized heads (giant or minute) (Fig. 5.29);
- double heads (Fig. 5.30);



Fig. 5.31 Spermatozoan with a coiled tail  
Source: Image House Medical, Sperm MORPH system. Used with permission.

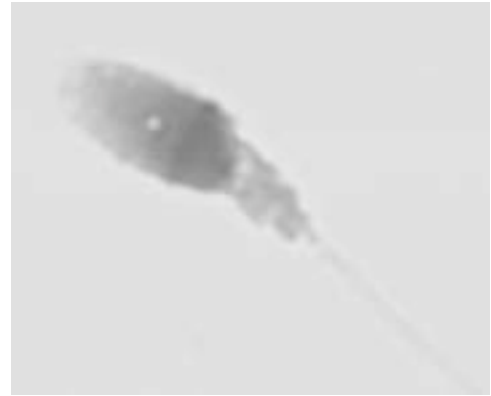

Fig. 5.32 Spermatozoan with swollen neck  
Source: Image House Medical, Sperm MORPH system. Used with permission.

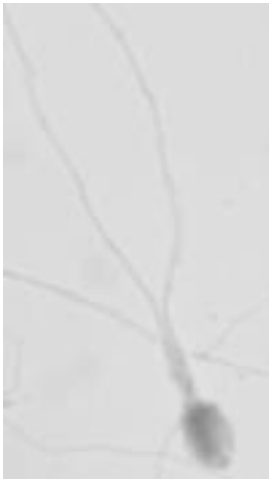

Fig. 5.33 Spermatozoan with double or rudimentary tails  
Source: Image House Medical, Sperm MORPH system. Used with permission.

- coiled tails (Fig. 5.31);
- absent, bifurcated or swollen necks (middle section) (Fig. 5.32);
- double, rudimentary or absent tails (Fig. 5.33).

In a normal smear there should not be more than 20% abnormal forms.

During the examination of semen note the presence of any other cells such as:

- erythrocytes;
- polymorphonuclear leukocytes;
- epithelial cells;
- immature cells from the testis, etc.

Various crystals may also be seen; their presence should also be noted.

### Motility

To check the motility, place a drop of semen on a slide, cover the drop with a coverslip and rim the edge with petroleum jelly to prevent evaporation. Examine under the  $\times 40$  objective of the microscope.

Estimate roughly the proportion of motile to non-motile sperm forms in several different microscope fields. Normally about 80% of the spermatozoa are actively motile and about 20% are sluggish or not moving at all. Observe the slide after 3 and 6 hours, and if convenient, also after 12 and 24 hours. For up to 3 hours there should be little or no reduction in motility, but after this there is an increasing loss of motility which at room temperature is often complete by 12 hours.

Decreased sperm motility may be a factor in infertility.

### Sperm count

1. After liquefaction has taken place, gently shake the specimen to mix.
2. Using a Sahli pipette, draw semen to the 0.5- $\mu$ l mark; then draw in the semen diluting fluid to the 11- $\mu$ l mark and place the pipette on a rotator to mix the contents.

3. Load an improved Neubauer counting chamber (see Fig. 9.40), allow the sperm to settle and then count in the four corner squares, as for a leukocyte count (see section 9.6.3). The formula for calculation is similar to that used for leukocytes, except that the sperm count is per ml instead of per mm<sup>3</sup>, so an additional multiplication factor of 1000 is needed.

$$\text{Number of sperm/ml} = \frac{n \times 10 \times 20 \times 1000}{4}$$

where  $n$  = number of sperm counted.

The normal sperm count is between 60 million and 150 million per ml (100–500 million/ml according to some sources). Patients with sperm counts below 60 million per ml definitely have low counts, though they may still be fertile.

## 5.8 Examination of vaginal discharge

Vaginal discharge is examined by microscopy to exclude infections with gonococci, *Candida albicans* and *Trichomonas vaginalis*, which cause bacterial vaginosis, vulvo-vaginal candidiasis and trichomoniasis, respectively.

### 5.8.1 Materials and reagents

- Microscope
- Microscope slides
- Coverslips
- Sodium chloride, 0.85% solution (reagent no. 53).

### 5.8.2 Method

#### Collection of specimens

The specimen should be collected by a physician or specialist nurse.

#### Preparation of slides

1. Make a smear of the discharge on a slide and allow it to air-dry. Stain the smear with Gram stain (see section 5.3.1) and examine for *Candida albicans*.
2. Transfer a small sample of discharge to a second slide, add a drop of saline solution and cover with a coverslip. Look for gonococci and *Trichomonas vaginalis* trophozoites in this preparation.

### 5.8.3 Microscopic examination

Examine the Gram-stained slide using the  $\times 40$  objective and the  $\times 100$  oil-immersion objective. *Candida albicans* appears as large Gram-positive yeasts, often with budding or short lengths of mycelium (see Fig. 5.13).

Examine the saline preparation as soon as possible using the  $\times 10$  and the  $\times 40$  objectives. Use a microscope with the iris diaphragm closed to give good contrast. Do not allow the specimen to dry out. Gonococci are Gram-negative and appear as small dots (see Fig. 5.12). *Trichomonas vaginalis* trophozoites appear as highly motile flagellates measuring 8–20  $\mu\text{m}$ , with an undulating membrane and a prominent nucleus.

## 5.9 Examination of watery stool specimens

Dark-field microscopy is used to identify *Vibrio cholerae* and *Campylobacter* spp. in watery stool specimens.

### 5.9.1 Materials and reagents

- Microscope with dark-field attachment
- Microscope slides
- Coverslips
- Inoculating loop
- Sodium chloride, 0.85% solution (reagent no. 53).

### 5.9.2 Method

1. Suspend 0.2 g of stool in 5 ml of sodium chloride solution. Allow the large particles to sediment.
2. Using an inoculating loop (sterilized by flaming), prepare a very thin smear on a slide. Carefully remove any large particles.
3. Cover with a coverslip. Place the slide on the microscope stage.
4. Open the iris diaphragm fully and place the dark-field attachment in position.

### 5.9.3 Microscopic examination

Use the  $\times 10$  objective for focusing. The background appears black, and all objects suspended in the saline solution appear bright.

Use the  $\times 40$  objective to search for bacteria with characteristic shapes and motility (see below).

*Vibrio cholerae* appears as motile rods, which may be short, curved, straight or involuted (Fig. 5.34).

*Campylobacter* spp. are Gram-negative spiral rods that rotate rapidly on a central axis.

### 5.9.4 Dispatch of specimens for culture<sup>1</sup>

It is often necessary to send stool specimens to a bacteriology laboratory for culture:

- for the detection of cholera vibrios
- for the detection of other bacteria that cause dysentery (species of *Salmonella*, *Shigella*, etc.).

### Using Cary–Blair transport medium

Cary–Blair transport medium (reagent no. 17) will preserve many kinds of enteric bacteria (cholera vibrios, other vibrios, salmonella, shigella, etc.) for up to 4 weeks. The uninoculated medium may be stored in a sealed bottle at room temperature for 8–12 weeks.

1. Dip a sterile cotton wool swab in the stool specimen (Fig. 5.35).
2. For infants or other patients who cannot produce a stool specimen, take a rectal swab. Moisten the swab with sodium chloride solution and introduce the swab into the rectum. Turn the swab several times with a circular movement (Fig. 5.36).

<sup>1</sup> See also section 3.7.1.

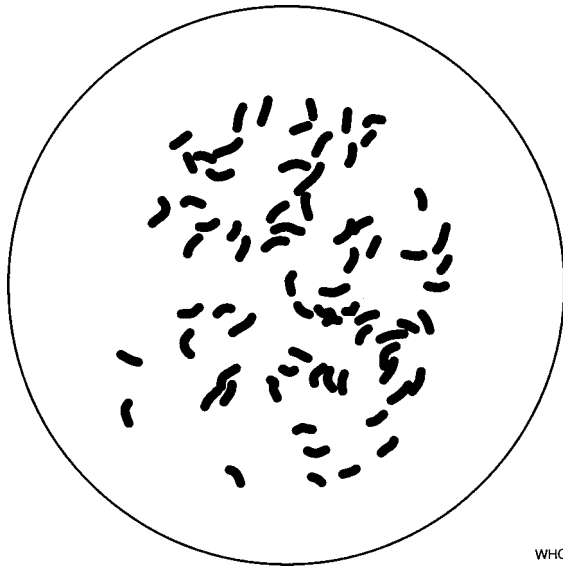

WHO 01.159

Fig. 5.34 *Vibrio cholerae*

3. Place the swab in a bottle containing Cary–Blair medium (three-quarters full) and send it to the bacteriology laboratory. If you cannot send the swab immediately, store it at room temperature.

*Important:*

- Never store the swab in the incubator.
- Never store the swab in the refrigerator.

**Using buffered glycerol saline**

When specimens are to be sent for culture of enteric organisms other than cholera vibrios and Cary–Blair transport medium is not available, buffered glycerol saline (reagent no. 14) may be used.

*Note:* If the buffered glycerol saline has changed colour from pink to yellow, discard it and prepare a fresh solution.

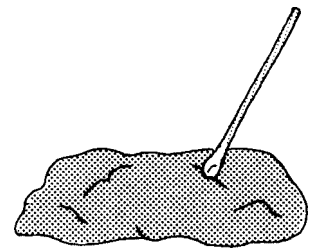

Fig. 5.35 Collecting a watery stool specimen

Fig. 5.36 Collecting a stool specimen from an infant

1. A bijou bottle with a capacity of 7.5 ml is recommended. Fill it to within 2 cm of the top with buffered glycerol saline.
2. Place the stool swab or rectal swab in the bottle and send it directly to the bacteriology laboratory.

### 5.10 Examination of aspirates, exudates and effusions

Aspirates, exudates and effusions are collected by inserting a sterile needle into the appropriate cavity. This can only be done by an experienced physician as there is a risk of introducing infection. The cavities from which effusions can be collected include the following:

- pleural (chest)
- peritoneal (abdominal)
- pericardial
- synovial joint
- bursa.

Bubo aspirates are examined for *Yersinia pestis*, which causes bubonic plague. The organism is carried from the sites of inoculation to the lymph glands in the axillae, groin and neck, where it causes localized swellings or buboes.

#### 5.10.1 Materials and reagents

- Microscope
- Microscope slides
- Centrifuge
- Centrifuge tubes
- Specimen containers (see section 3.7)
- Inoculating loop
- 70% Methanol
- Reagents for:
  - Giemsa stain (see section 9.10.3)
  - Gram stain (see section 5.3.1)
  - Wayson stain (see section 5.3.4)
  - Ziehl–Neelsen stain (see section 5.3.3).

#### 5.10.2 Method

##### Collection of specimens

###### *Aspirated cavity fluid*

Aspirated cavity fluid is collected into clean, dry, sterile containers.

Report the appearance of the fluid. Cavity fluid is normally straw-coloured (yellow), but can appear turbid or bloodstained.

##### Preparation of slides

###### *Aspirated cavity fluid*

1. Using an aseptic (sterile) technique, transfer 10 ml of the fluid to a centrifuge tube and centrifuge at moderate speed (2000g) for several minutes.

2. Remove the supernatant, resuspend the deposit and use an inoculating loop (sterilized by flaming) to prepare three smears. Spread the fluid thinly over each slide (see section 5.2.3).
3. Allow the smears to air-dry and fix with methanol.
4. Stain the slides with:
  - Gram stain (see section 5.3.1)
  - Ziehl–Neelsen stain (see section 5.3.3)
  - Giemsa stain (see section 9.10.3).

### ***Bubo aspirates***

1. Prepare a smear from the aspirated fluid as described in section 5.2.3.
2. Fix the smear in methanol for 2 minutes and stain with Wayson stain (see section 5.3.4).

## 5.10.3 Microscopic examination

### **Aspirated cavity fluid**

Examine each slide using the  $\times 40$  objective and the  $\times 100$  oil-immersion objective.

Look for any bacteria present on the slide stained with Gram stain.

Look for acid-fast bacilli (mycobacteria) on the slide stained with Ziehl–Neelsen stain.

When examining the slide stained with Giemsa stain, identify the predominant type of blood cell present — leukocytes, lymphocytes or mesothelial cells (from the lining of the cavity) and any atypical cells which may suggest cancer cells.

If there are more than a few cells present or if the fluid is bloodstained, send the slide to a bacteriology laboratory for culture.

### ***Bubo aspirates***

First examine the slide using the  $\times 40$  objective to check the distribution of the material and then use the  $\times 100$  oil-immersion objective to look for *Yersinia pestis*.

*Yersinia pestis* is seen as bipolar organisms which stain blue with pink ends.

## 5.11 Examination of pus for *Bacillus anthracis*

*Bacillus anthracis* is a pathogen of several types of animal. It is responsible for cutaneous anthrax where it shows in its early form as a blister on the skin often called a malignant pustule.

### 5.11.1 Materials and reagents

- Protective clothing
- Gloves
- Microscope
- Microscope slides
- Inoculating loop or sterile cotton wool swabs (see section 5.4.1)
- Loeffler methylene blue (reagent no. 35)
- Potassium permanganate, 4% solution (reagent no. 46).

### 5.11.2 Method

#### Collection of specimens

*Warning:* Anthrax is highly contagious. Gloves and protective clothing must therefore be worn when specimens are collected.

Using an inoculating loop or a cotton wool swab, collect a few drops of pus or fluid from malignant pustules. Leave the smear to air-dry in a safety cabinet.

#### Preparation of slides

1. Prepare a smear from the pus or fluid as described in section 5.2.3.
2. Fix the smear with potassium permanganate for 10 minutes, then stain with Loeffler methylene blue (see section 5.3.5).

### 5.11.3 Microscopic examination

First examine the smear using the  $\times 40$  objective to check the distribution of the material and then use the  $\times 100$  oil-immersion objective to look for *Bacillus anthracis*.

*Bacillus anthracis* is seen as large blue rods surrounded by a mauve capsule; the bacilli are arranged in chains (see Fig. 5.17).

## 5.12 Examination of skin smears and nasal scrapings for *Mycobacterium leprae*

Leprosy or Hansen disease is an infection of the peripheral nerve tissues by the bacterium *Mycobacterium leprae*. The bacilli can be present in large numbers in lepromatous lesions (multibacillary leprosy) and are usually sparse or absent in tuberculoid lesions (paucibacillary leprosy).

Diagnosis is made by examination of slit skin smears taken from various sites on the body, or from nasal scrapings taken from the septum of the nose. After fixation, smears are stained by the modified Ziehl–Neelsen method.

Slit skin smears are usually collected from six sites, which are chosen from areas where nerves run near to the skin surface. These sites should include any nodules or patches on the face or the body.

### 5.12.1 Materials and reagents

- Microscope
- Microscope slides
- Scalpel
- Forceps with rounded ends and no teeth, or curved clamp forceps with no teeth, or tissue forceps
- Diamond pencil
- Gauze
- Small plastic sheets or gloves
- Sterile cotton wool swabs (see section 5.4.1)
- Spirit lamp or Bunsen burner
- Reagents for Ziehl–Neelsen stain (see section 5.3.3)
- 95% Ethanol
- Sodium chloride, 0.85% solution (reagent no. 53).



### 5.12.2 Method

#### Collection of specimens

##### *Specimens from the ear and skin lesions*

1. Examine the ear and skin in good light, look for any lesions or small swellings with a shiny surface (Fig. 5.37).

From each ear select the most congested lesion or nodule. If no lesion is visible, use the edges of the ear lobe.

From the skin lesion choose one area just inside the edge of a patch of pigmented area.

2. Disinfect the area using a gauze swab moistened with ethanol. Flame the forceps and scalpel.
3. Squeeze the ear lobe or skin area hard using forceps (Fig. 5.38),

if available, or else use the forefinger and thumb to stop the flow of blood.

4. Use the scalpel to make a superficial incision about 0.5 cm long and 2–3 mm deep lengthwise in the middle of the lesion.

Still squeezing with the forceps, turn the scalpel on to the flat side and gently scrape the base of the incision with the point of the blade (Fig. 5.39). Collect the serous tissue fluid and a small amount of cellular material, but avoid drawing blood.

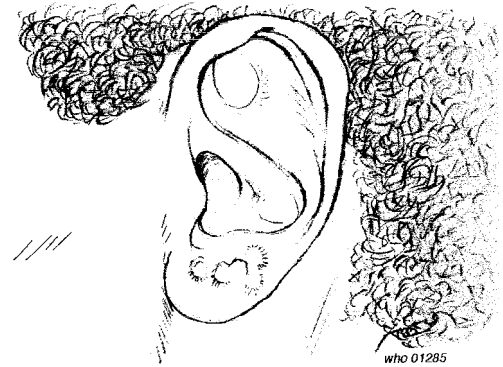

Fig. 5.37 Leprosy lesions on the ear

##### *Specimens from the body and face*

1. Examine the body and face for:

- lesions similar to those found on the ear, but often larger (Fig. 5.40);
- papules, flat patches (maculae) or plaques (Fig. 5.41); these are pale or thickened, infiltrated areas of skin which are similar in appearance to orange peel.

Choose the most acutely infiltrated lesion and select a site for collection of the specimen. This should be just inside the edge of the patch, where the skin

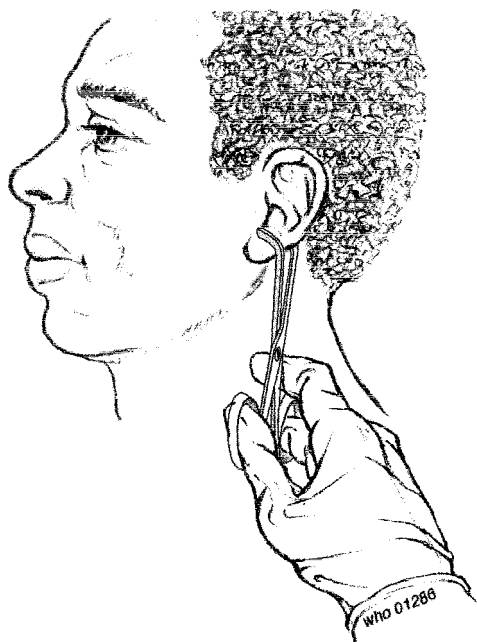

Fig. 5.38 Squeezing the ear lobe to stop the blood flow



Fig. 5.39 Collecting a specimen from an ear lesion

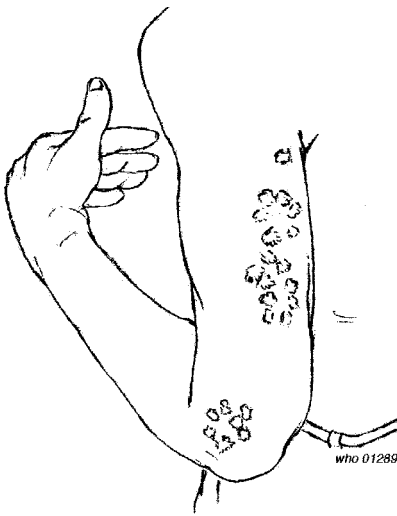

Fig. 5.40 Leprosy lesions on the arm

appears to be altering most rapidly. (This is important, to ensure that bacilli are detected.)

A sample can also be taken from an area of skin showing the first signs of leprosy infiltration.

2. Disinfect the area using a gauze swab soaked in ethanol. Flame the clamp forceps and scalpel.
3. Squeeze the site hard using the forceps and make an incision about 0.5 cm long and 2–3 mm deep with the tip of the scalpel (Fig. 5.42).
4. Still squeezing with the forceps, scrape the bottom and edges of the incision with the tip of the scalpel. Collect a small amount of pulp and serous material. Disinfect the incision with ethanol and apply a dressing if there is bleeding.

#### *Specimens from the nose*

Specimens are best prepared from an early morning “nose blow”. The patient blows his or her nose thoroughly into a small clean dry sheet of cellophane or plastic.

#### **Preparation of slides**

##### *Specimens from the ear and skin lesions*

1. Spread the serous material from the tip of the blade on to the slide in a circular motion until it covers an area of 5–7 mm in diameter (Fig. 5.43). Label the slide with a diamond pencil. Between two and four smears from the same patient may be prepared on a single slide.
2. Leave the slide to dry in a dust-free place and then fix the smears by passing the back of the slide through the flame of a spirit lamp or Bunsen burner several times.
3. Stain the smears using the modified Ziehl–Neelsen technique (see section 5.3.3).

##### *Specimens from the body and face*

1. Using the scalpel, spread the specimen in a circular motion over an area 5–7 mm in diameter on a glass slide labelled with a diamond pencil. Between three and six specimens from the same patient can be placed on the same slide.
2. Dry and fix the smears as for specimens from the ear or skin lesions (see above).
3. Stain the smears using the modified Ziehl–Neelsen technique (see section 5.3.3).



Fig. 5.41 Leprosy lesions on the face



Fig. 5.42 Collecting a specimen from a skin lesion

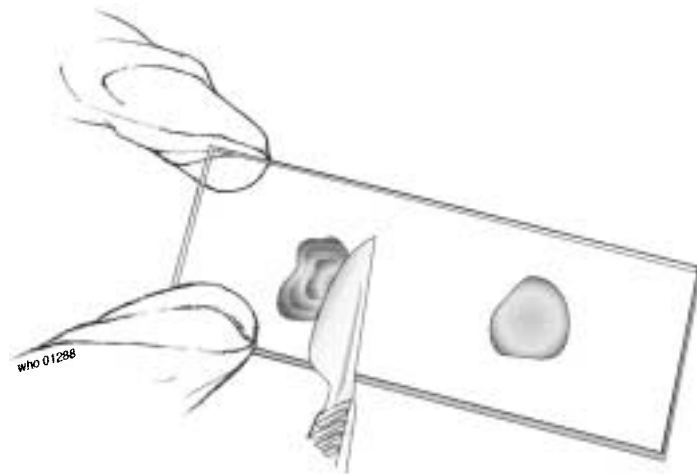

Fig. 5.43 Transferring the specimen to a slide

#### Specimens from the nose

1. Using a small cotton wool swab slightly moistened in sodium chloride solution, transfer some of the nasal mucus from the plastic sheet to a labelled slide.
2. Spread the material evenly on the slide and leave to dry.
3. When completely dry, fix the slide by passing the back of the slide quickly through the flame of a spirit lamp or Bunsen burner several times.
4. Stain the slide by the modified Ziehl–Neelsen technique (see section 5.3.3).

#### 5.12.3 Microscopic examination

Examine the slide using the  $\times 100$  oil-immersion objective.

*Mycobacterium leprae* are acid-fast bacilli. After staining by the modified Ziehl–Neelsen technique, they appear red on a blue background.

**Size:** 1–8  $\mu\text{m}$ .

**Shape:** Largish rods, straight or slightly curved with rounded ends; they may often appear granular with the rod being broken into several parts.

**Arrangement:** The rods are arranged either in groups of 2–5 lying in parallel (Fig. 5.44 (a)) or in larger groups or clusters (Fig. 5.44 (b)); occasionally large numbers in circular masses called “globi” can be seen (Fig. 5.44 (c)).

**Note:** Nasal smears sometimes contain non-pathogenic acid-fast bacilli that are not *M. leprae*.

#### Recording the results

Record the results as follows:

- acid-fast bacilli present, or
- no acid-fast bacilli seen.

The results of the examination can be graded as shown in Table 5.3.

#### Bacteriological index

The bacteriological index (BI) is a guide to the bacterial load and is calculated by adding all the positive findings from all the body sites where a sample has been taken and dividing the total number of positive specimens by the number of sites. For example:



Fig. 5.44 *Mycobacterium leprae*  
*M. leprae* rods arranged: (a) in groups of 2–5 lying in parallel; (b) in larger groups or clusters; and (c) in large numbers in circular masses (globi).

**Table 5.3 Reporting the results of the examination for *Mycobacterium leprae***

Number of bacilli per microscope field	Result
None (< 1 per 100 fields)	0
0.01–0.1 (1–10 per 100 fields)	1 +
0.1–1 (1–10 per 10 fields)	2 +
1–10	3 +
10–100	4 +
100–1000	5 +
> 1000	6 +

- right ear 3 +
- left ear 2 +
- left arm 2 +
- back 1 +

The total number of positive specimens is 8 + and the BI is  $8/4 = 2$ .

### Morphological index

The morphological index provides an indicator of the viability of the bacilli. It is determined as follows:

Examine 100 bacilli on the prepared slide using the  $\times 100$  objective. Count the numbers of bacilli that are uniformly stained red, with no break in the rod. These are considered as viable bacilli and if, for example, the number of viable bacilli is 8, the morphological index is 8%.

The morphological index is used for the initial diagnosis and follow-up of patients with multibacillary leprosy.

### Culture

There is no method available for the in vitro culture of *Mycobacterium leprae*. However, the organism can be cultured in vivo in the foot pads of mice or in the armadillo.

---

## 6. Mycology<sup>1</sup>



### 6.1 Examination of skin and hair for fungi

Ringworm or tinea is a fungal infection of the skin. It can be found on the surface of the body, the scalp and the nails and between the toes. Cross-infection between humans frequently occurs and infection can also be acquired from infected animals or soil.

The circular lesions on the skin consist of a mass of branching hyphae; infected hair and nails may also contain spores of fungi.

#### 6.1.1 Materials and reagents

- Microscope
- Microscope slides (or dark paper)
- Coverslips
- Scalpel
- Tweezers
- Petri dish
- Bunsen burner or spirit lamp
- Cotton wool swab
- Cotton wool
- 70% Ethanol
- Lactophenol cotton blue mounting solution (reagent no. 33)
- Potassium hydroxide, 20% solution (reagent no. 45).

#### 6.1.2 Method<sup>2</sup>

##### Collection of specimens

1. Clean the infected area with a cotton wool swab soaked in ethanol.
2. Use a sterile scalpel to gently scrape the edge of a lesion and collect some skin scales on to a glass slide or on to a piece of dark paper on which the scales can be more easily seen. Also collect a few broken or damaged hairs from the infected areas of the scalp using broad tweezers and place them on the slide.
3. Place a drop of lactophenol cotton blue mounting solution and a drop of 20% potassium hydroxide on to the scales and hair (Fig. 6.1). Cover with a coverslip. The strong alkali will dissolve the keratin in the tissue, enabling hyphae and spores to be seen.

*Note:* Potassium hydroxide is a corrosive fluid and should not be allowed to touch the skin.

---

<sup>1</sup> A description of the method used for the identification of *Candida albicans* in vaginal discharge is provided in section 5.8.

<sup>2</sup> Tinea infection can also be identified by examining the patient in a dark room illuminated with ultraviolet light. The hairs infected with tinea will appear fluorescent.

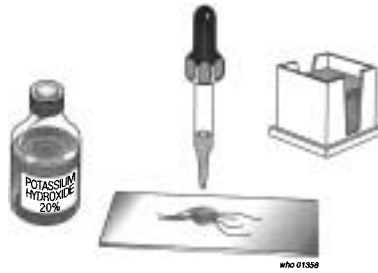

Fig. 6.1 Preparation of slides for microscopic examination of skin and hair for fungi



Fig. 6.2 Clearing the specimen above a flame

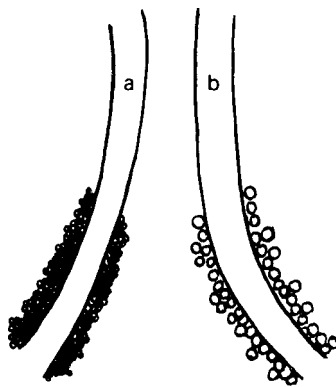

Fig. 6.3 Ectothrix  
a: Immature spores;  
b: mature spores.

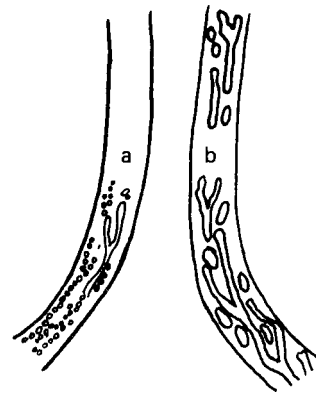

Fig. 6.4 Endothrix  
a: Immature spores;  
b: mature spores.

- Place the slide in a covered Petri dish with some damp cotton wool to prevent the specimen drying out. Leave the specimen to clear for 5–30 minutes, depending on the thickness. Alternatively, clear the specimen by holding the slide above a Bunsen burner or spirit lamp flame for 1 minute (Fig. 6.2).

### Microscopic examination

Examine the cleared specimen using the  $\times 10$  and  $\times 40$  objectives. Adjust the iris diaphragm of the condenser to give good contrast.

Branching hyphae and chains of angular rounded arthrospores may be seen. Fungal hyphae can be differentiated from other tissue structures by their branching and cross walls or septa. They stain blue with lactophenol cotton blue.

Spores (large round granules with transparent membranes) may be seen around the outside of the hairs (Fig. 6.3). These spores are known as ectothrix.

Spores found inside the hairs are called endothrix (Fig. 6.4).

Report as “fungal hyphae or spores present” or “not found”.

## 6.2 Examination of pus for mycetoma

Mycetoma is a chronic granulomatous disease of the subcutaneous and deep tissue. The most commonly infected site is the foot, where it is called “Madura foot”. Other possible sites of infection include the hands, the head and the chest wall.

Mycetoma produce small granules which are discharged through sinuses to the surface. These granules are used in the diagnosis of the disease.

### 6.2.1 Materials and reagents

- Microscope
- Microscope slides
- Coverslips
- Sterile needles
- Distilled water
- 70% Methanol
- Sodium chloride, 0.85% solution (reagent no. 53)
- Potassium hydroxide, 20% solution (reagent no. 45)
- Reagents for Gram staining (see section 5.3.1).

### 6.2.2 Method

#### Collection of specimens

1. Use a sterile needle to lift the surface crust over a sinus.
2. Carefully remove some of the discharging pus on to a slide.
3. Add a drop of saline or water, spread the pus gently and look for granules. Granules vary in colour, size, shape and degree of hardness.
4. Crush a few granules in some distilled water and place on two slides.
5. Allow one slide to air-dry, fix with methanol for 2–3 minutes and stain with Gram stain (see section 5.3.1).
6. Place a few drops of 20% potassium hydroxide on to the second slide and cover with a coverslip. Leave the specimen to clear for 10 minutes.

#### Microscopic examination

Examine the cleared specimen using the  $\times 10$  and  $\times 40$  objectives. Adjust the iris diaphragm of the condenser to give good contrast.

Look for branching and twisted hyphae or fragmented threads. Gram-stained granules may show thin or fragmented Gram-positive threads.

Report as:

- “pus from sinus containing granules [specify colour and size] present”;
- “Gram staining shows Gram-positive thin hyphae” or “Gram staining does not show Gram-positive thin hyphae”.

## 6.3 Examination of skin for pityriasis versicolor

Pityriasis versicolor is a common skin disease in hot climates; it is caused by the fungus *Pityrosporum furfur*. The face and body are covered with patches, which appear:

- pale and discoloured in dark-skinned patients;
- yellowish-brown in white-skinned patients.

### 6.3.1 Materials and reagents

- Microscope
- Microscope slides
- Adhesive cellophane tape
- Tongue depressor or glass rod

- Forceps
- Gauze pads
- Eosin, 1% solution (reagent no. 23), if possible (otherwise, examine without staining).

### 6.3.2 Method

#### Collection of specimens

1. Choose a rapidly developing patch of infected skin. Moisten it with a gauze pad dipped in the eosin solution (Fig. 6.5). Leave to dry for 1 minute. (Do not take the specimen if talcum powder has been used on the skin. Wash it off first.)
2. Cut a strip of adhesive tape about 5 cm long. Place it over the patch so that it overlaps one edge (Fig. 6.6).
3. Stick the tape on the skin and press firmly from one end to the other, passing a tongue depressor or glass rod over it several times (Fig. 6.7).

Pull the adhesive tape away with forceps. Place it immediately on a microscope slide, sticky side down (Fig. 6.8).



Fig. 6.5 Staining pityriasis versicolor-infected skin patches with eosin



Fig. 6.6 Applying adhesive tape to a skin patch



Fig. 6.7 Collecting a skin specimen





Fig. 6.8 Transferring a skin specimen to a slide

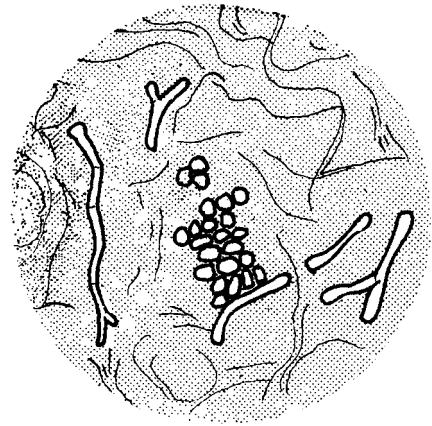

Fig. 6.9 *Pityrosporum furfur* (×40)

### Microscopic examination

Examine the whole slide under the microscope using the ×40 objective until a cluster of large granules (the spores) is seen (Fig. 6.9). The spores appear white on a pink background if the skin was treated with eosin, and are also visible in unstained preparations.

Change to the ×100 oil-immersion objective to examine the details (Fig. 6.10).

#### Spores

*Size:* 3–8 μm diameter.

*Shape:* round or slightly rectangular, thick-walled, arranged in a bunch or cluster. Budding is sometimes visible.

#### Mycelium filaments

*Size:* 20–40 μm long and 5 μm wide.

*Shape:* finger-shaped, bent and twisted rods, with branches.

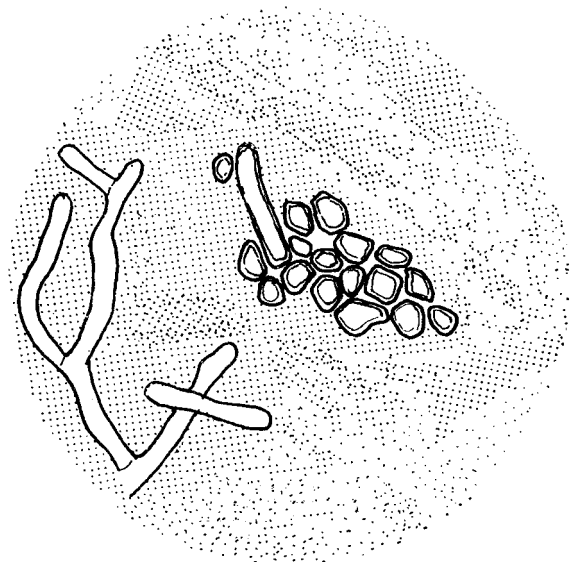

Fig. 6.10 *Pityrosporum furfur* (×100)



# Part III





## 7. Examination of urine



Examination of urine is a fundamental investigation in patients in whom kidney disorders or infections of the urinary tract are suspected. There are also many patients who exhibit no clinical symptoms, but in whom previously unrecognized urinary tract infections can be diagnosed by urine examination.

### 7.1 Collection of urine specimens

Containers for the collection of urine should be wide-mouthed, clean and dry. If the urine specimen has to be transported for any length of time it should contain an appropriate preservative to prevent bacterial overgrowth or hatching of viable ova.

#### 7.1.1 Types of urine specimen

##### **Early morning urine specimen**

Early morning urine provides the most concentrated sample.

##### **Random urine specimen**

A random urine sample, taken at any time of the day, will enable the laboratory to screen for substances which are indicators of kidney infection.

##### **24-Hour urine specimen**

The 24-hour urine specimen is collected in a clear 2-litre bottle with a stopper. On the first morning the patient gets up and urinates; this urine is not collected. All the urine passed during the rest of the day and night is collected in the bottle. The next morning the patient gets up and collects the first urine of the morning in the bottle. The bottle should then be taken immediately to the laboratory.

Measure the volume of urine with a measuring cylinder and record it.

##### **Midstream urine specimen**

While passing urine, the patient places an open container in the stream of urine and collects about 20ml of urine. The container should be covered immediately.

##### **Terminal urine specimen**

The patient urinates the last portion of urine into an open container.

##### **Urine specimens collected using a catheter**

Collection of urine using a catheter must be carried out by a qualified physician or nurse. The procedure is used for certain bacteriological tests, mainly in women. Usually, however, a specimen collected in the normal way following thorough cleansing is acceptable for this purpose.

### Urine specimens from infants

Urine can be collected into a plastic bag with an adhesive mouth. The bag is fixed around the genitalia and left in place for 1–3 hours, depending on the examination requested. Colostomy bags can be used.

#### 7.1.2 Preservation of urine specimens

- Urine passed at a clinic and examined immediately does not require preservation.
- If urine has been collected to check for the presence of *Schistosoma haematobium* ova but it may not be examined for several hours, it should be acidified with a few drops of 10% acetic acid (reagent no. 2).

## 7.2 Examination of urine specimens

### 7.2.1 Appearance

- Urine is normally clear straw-yellow in colour. More concentrated urine may appear dark yellow.
- The presence of blood cells or excess salts may make the urine appear cloudy.
- Pigments from bile substances may make the urine appear deep yellow or brown.
- Urine can occasionally appear colourless.

Report the appearance as:

- clear or cloudy;
- colourless, pale yellow, deep yellow or brown.

### 7.2.2 Testing for the presence of blood

Elevated erythrocyte counts and haemoglobin levels may occur in urine:

- after heavy physical exercise;
- in vaginal tract infections;
- in parasitic infections (e.g. schistosomiasis);
- in acute glomerulonephritis;
- in acute cystitis or urethritis;
- in patients suffering from certain tumours.

Blood cells are easily seen by microscopic examination after centrifugation (see section 7.2.7).

Lysed erythrocytes can be detected using a urine dipstick which has a segment for detection of blood. Urine dipsticks are available for detection of a single substance (e.g. blood, glucose or protein) or for detection of several substances (e.g. nitrite and leukocyte esterase).

### Method

The dipsticks are placed into the urine and immediately removed. They are then compared with a comparison chart after an appropriate time that is also specified on the chart.

The colour changes observed on the dipstick will give a semi-quantitative estimation of the amount of substance present. This can be reported as negative, +, ++, +++, ++++ or as an approximate value of the concentration of the substance tested for.

Dipsticks must be stored according to the manufacturer's instructions.

### 7.2.3 Measuring the pH

Normal freshly passed urine is slightly acid, with a pH of around 6.0.

In certain diseases the pH of the urine may increase or decrease.

#### Principle

- Coloured indicator paper is dipped in the urine (or placed in a watch glass and a few drops of urine are added to it).
- The colour changes according to the pH.
- The paper is then compared with a standard control chart giving the corresponding pH value.

#### Materials (Fig. 7.1)

- Watch glasses
- Dropper
- Forceps
- Universal indicator paper (for measuring pH from 1 to 10)
- Indicator paper of limited pH range: for the 5.0–7.0 range and for the 6.0–8.0 range.

The urine specimen must be tested within 1 hour of collection.

#### Method

1. Place a strip of universal indicator paper in a watch glass.

Let a few drops of fresh urine fall from the dropper on to the paper (Fig. 7.2).

Alternatively, dip the test paper directly into the urine in the receptacle.

2. Pick the strip of paper up with forceps.

Compare the colour obtained with those shown on the standard chart (Fig. 7.3). Read off the pH unit given for the colour that matches the test paper most closely.

3. According to the result obtained, select a strip of indicator paper for the corresponding limited range. For example, if the pH is 6, use indicator paper for the range 5.0–7.0. If the pH is 7 or more, use indicator paper for the range 6.0–8.0.

4. Repeat the test in another watch glass, using the paper for the corresponding limited range. Read off the pH of the urine on the standard chart (Fig. 7.4), e.g. pH = 6.2 or pH = 7.5.

The pH of urine is normally about 6.0 (range 5.0–7.0). Acid pH values (4.5–5.5) are observed in some forms of diabetes, muscular fatigue and acidosis. Alkaline pH values (7.8–8.0) are common in patients with infections of the urinary tract and in people on a vegetarian diet.

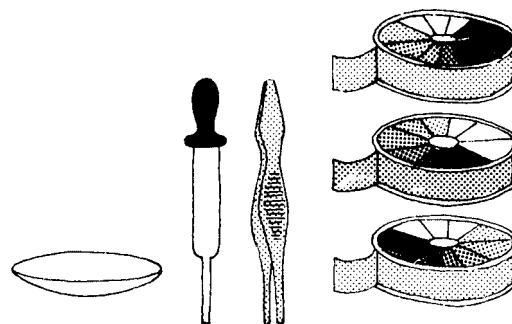

Fig. 7.1 Materials for measuring the pH of urine

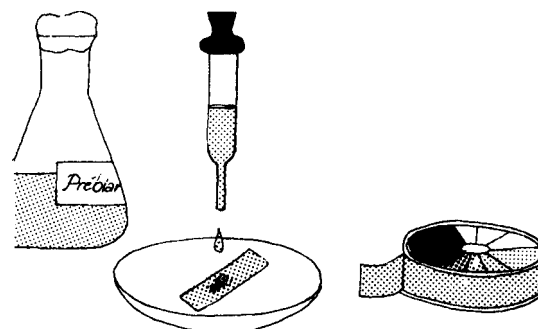

Fig. 7.2 Applying the urine specimen to universal indicator paper

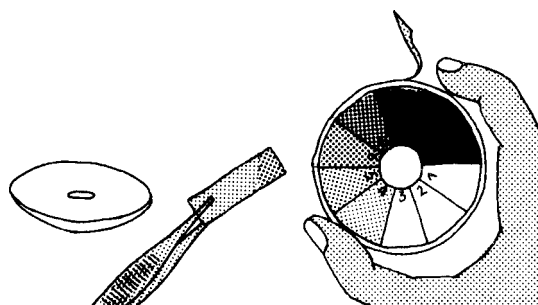

Fig. 7.3 Checking the pH using universal indicator paper

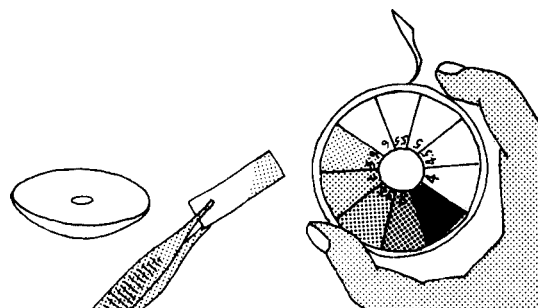

Fig. 7.4 Checking the pH using indicator paper of limited pH range

### *pH and crystalline deposits*

Determination of the pH of urine is useful for the identification of crystalline deposits (see section 7.2.7, pages 245–248).

Some crystals are deposited only in acid urine, others only in alkaline urine.

For example:

- acid urine: oxalates, uric acid;
- alkaline urine: phosphates, carbonates, urates.

Except in very rare diseases, crystalline deposits in urine have no diagnostic significance.

## 7.2.4 Detection of glucose

### Principle

Glucose is the most commonly found sugar substance in urine, particularly in diabetic patients and patients suffering from chronic renal failure. Glucose is a reducing substance. It reduces the blue copper sulfate in Benedict solution to red copper oxide, which is insoluble.

Lactose is also a reducing sugar and is occasionally seen in the urine of pregnant women.

### Materials and reagents

- Test-tubes
- Wooden test-tube holder
- Test-tube rack
- Beaker or can
- Bunsen burner or spirit lamp
- Dropper pipette
- Graduated pipette, 5 ml
- Benedict solution (reagent no. 10).

### Method

1. Pipette 5 ml of Benedict solution into a test-tube.
2. Add eight drops of urine and mix well.
3. Boil over a Bunsen burner or spirit lamp for 2 minutes (Fig. 7.5), or place the test-tube in a beaker or can of boiling water for 5 minutes.
4. Place the test-tube in the test-tube rack and allow to cool to room temperature.

Examine the colour change of the solution and any precipitate. Report the result as shown in Table 7.1.

Glucose in urine can also be detected using a urine dipstick (see section 7.2.2).

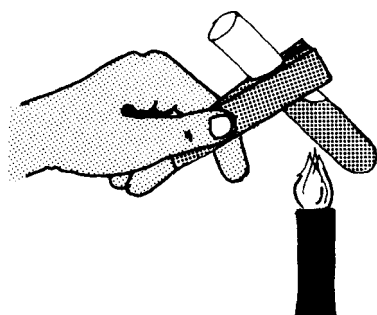

Fig. 7.5 Benedict method for detection of reducing substances in urine

## 7.2.5 Detection and estimation of protein

Elevated protein levels are observed in the urine of patients with:

- urinary schistosomiasis
- chronic renal disease



**Table 7.1 Reporting the results of the Benedict method for detection of reducing substances in urine**

Colour	Result
Blue	Negative
Green	Borderline
Green with yellow precipitate	+
Yellow/dark green	++
Brown	+++
Orange to brick red	++++

- pyelonephritis
- diabetes mellitus
- systemic disorders (lupus erythematosus)
- multiple myeloma.

However, orthostatic proteinuria, a form of functional proteinuria usually seen in young men, which occurs on standing up and disappears on lying down, has no pathological significance.

### Principle<sup>1</sup>

When trichloroacetic acid is added to urine containing protein, a precipitate is formed, which is measured by turbidimetry. This reaction occurs with almost all proteins, including albumin and globulins.

### Materials and reagents

- Spectrophotometer
- Test-tubes
- Test-tube rack
- Centrifuge
- Mechanical rotator
- Bovine or human serum albumin
- Trichloroacetic acid, 5% solution (see reagent no. 62), diluted 1:4 with distilled water
- Sodium chloride, 0.85% solution (reagent no. 53)
- Positive and negative controls
- Albumin working standard, 0.005% solution (prepared from albumin stock standard, 5.0% solution, diluted 1:100 with sodium chloride, 0.85% solution (reagent no. 53)).

The albumin working standard can be divided into aliquots and stored at  $-20^{\circ}\text{C}$  for up to 6 months.

If albumin stock standard is not available, commercial serum-based standards containing both albumin and globulin can be used to prepare a working standard solution of the appropriate concentration. As with the albumin standard, the working standard can also be divided into aliquots and stored at  $-20^{\circ}\text{C}$  for up to 6 months.

<sup>1</sup> Further details of the method described here are given in the following references: Shahangian S, Brown PI, Ash KO. Turbidimetric measurement of total urinary proteins: a revised method. *American journal of clinical pathology*, 1984, 81:651-654; Tietz NW, ed. *Textbook of clinical chemistry*, 2nd ed. Philadelphia, WB Saunders, 1994.

## Method

### *Collection of specimens*

Random, timed or 24-hour urine specimens should be used (see section 7.1.1). No preservatives should be added to the specimens. Specimens that are collected over 24 hours should be stored at 4–8°C during the period of collection, to prevent bacterial growth.

Collected specimens should be kept at 4°C until analysis. If analysis is likely to be delayed for more than 24 hours, however, the specimens should be stored at –20°C.

### *Technique*

1. Add 1.6 ml of the urine specimen to each of two test-tubes (test and test blank). Repeat the process with the working standard and the control.
2. Add 0.4 ml of trichloroacetic acid solution to all of the test-tubes and mix well. Leave to stand at room temperature for 10 minutes.
3. Centrifuge the test blanks at 2000*g* for 10 minutes.
4. Using the spectrophotometer, measure and record the optical density of the tests and blanks at 620 nm. The spectrophotometer should be set to zero with distilled water before any measurements are taken. It should also be calibrated, as described below. The analytical range of measurement using this method is 100–1000 mg/l.

## Calculation

Calculate the concentration of protein in the urine specimen using the following formula:

$$\frac{OD_T - OD_{TB} \times C}{OD_R - OD_{RB}}$$

where:

C = concentration of the calibration solution

OD<sub>R</sub> = optical density of the working standard

OD<sub>RT</sub> = optical density of the working standard test blank

OD<sub>T</sub> = optical density of the test specimen

OD<sub>TB</sub> = optical density of the test specimen blank.

*Note:*

- If a serum-based control is used for calibration purposes, an independent material must be used for the purpose of quality control.
- Because the amount of protein excreted in the urine may vary greatly, any positive results should always be confirmed by repeating the test on one or more separate samples.
- If this method is used to screen for microproteinuria (which may be correlated with microalbuminuria in the absence of tubular damage, urinary infections and treatment with certain drugs) in high-risk populations such as patients with diabetes, the following modifications should be applied to steps 2 and 4:
  2. Leave all the tubes to stand at room temperature for 35 minutes after mixing.
  4. Using the spectrophotometer, measure and record the optical density of the tests and blanks at 405 nm.

The analytical range of this modified method is 25–700 mg/l.

Protein in urine can also be detected using a protein dipstick (see section 7.2.2).

### 7.2.6 Detection of ketone bodies

Normal urine does not contain ketone bodies. Acetone and other ketone bodies may appear in urine:

- in severe or untreated diabetes;
- in certain other conditions (dehydration, vomiting, malnutrition, prolonged starvation and following strenuous exercise).

#### Principle

When sodium nitroprusside (sodium nitrosyl pentacyanoferrate (III)) is added to urine containing ketone bodies, a purple colour is produced.

#### Materials and reagents

- Test-tubes
- Test-tube rack
- Measuring cylinder, 10 ml
- Dropping pipette
- Sodium nitroprusside crystals
- Acetic acid
- Ammonia.

#### Method

1. Just before carrying out the test, place a sufficient number of sodium nitroprusside crystals into a test-tube to cover the bottom (Fig. 7.6).
2. Add 5 ml of distilled water. Shake well until the crystals are almost dissolved. (Not all the crystals are expected to dissolve as the solution is saturated.)
3. Measure 10 ml of urine into another test-tube.
4. Add four drops of acetic acid to the urine, followed by 10 drops of freshly prepared sodium nitroprusside solution. Mix well.
5. Holding the tip of the pipette against the side of the tube, let 20 drops (1 ml) of ammonia solution flow on to the surface of the liquid (Fig. 7.7). Wait for 5 minutes before reading — a positive result may be obvious before this time.

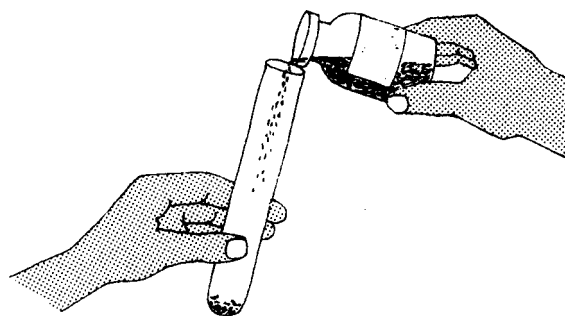

Fig. 7.6 Preparation of sodium nitroprusside solution

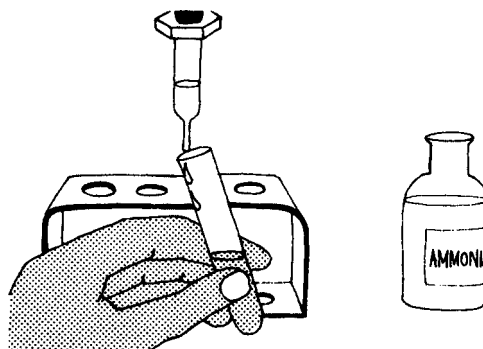

Fig. 7.7 Adding ammonia solution to the surface of the sodium nitroprusside solution

**Table 7.2 Reporting the results of the test for detection of ketone bodies in urine**

Colour change	Result
None	Negative
Pink ring	+
Red ring	++
Purple ring	+++

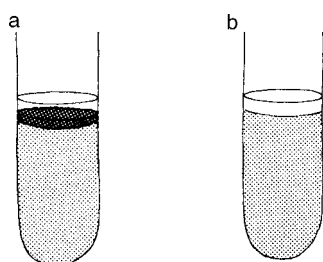

Fig. 7.8 Test for ketone substances in urine  
a: Positive reaction;  
b: negative reaction.

If the result is positive (Fig. 7.8), a purple ring appears on top of the urine. If the result is negative, no colour change occurs.

Report the result as shown in Table 7.2.

Ketone bodies in urine can also be detected using a urine dipstick (see section 7.2.2).

### 7.2.7 Detection of abnormal elements

#### Principle

Urine contains cells and crystals in suspension that can be collected by centrifugation or by allowing the urine to stand and the suspended particles to form a sediment. The resulting urinary deposit can be examined under the microscope.

In certain diseases of the urinary tract, the urinary deposits are considerably altered. The following abnormal elements may be found:

- leukocytes
- abnormal numbers of erythrocytes
- abnormal crystals (very rarely)
- parasitic trophozoites (e.g. *Trichomonas vaginalis*) or ova (e.g. *Schistosoma haematobium*,<sup>1</sup> *Enterobius vermicularis*)
- bacteria
- fungi
- abnormal casts.

#### Materials and reagents

- Microscope
- Microscope slides
- Centrifuge
- Conical centrifuge tube, 15 ml
- Pasteur pipette
- Coverslips
- Formaldehyde
- Distilled water.

<sup>1</sup> See also section 7.2.8.

## Method

### Collection of specimens

Urine to be examined under the microscope must be freshly passed into a clean dry vessel. A midstream urine specimen (see section 7.1.1) is the most useful. Urine stored in a refrigerator may contain an excess of precipitated salts and will not be suitable for microscopy.

The specimen can be preserved for microscopic examination of the deposit by adding 8–10 drops of formaldehyde, 10% solution (reagent no. 28) per 300 ml of urine. Urine preserved in this way is not suitable for other tests.

### Preparation of the deposit

1. Mix the urine specimen gently and pour approximately 11 ml into a centrifuge tube.
2. Centrifuge the specimen at medium speed (2000g) for 5 minutes.
3. Pour off the supernatant by quickly inverting the tube without shaking. (The supernatant may be used for biochemical testing.)
4. Resuspend the deposit in distilled water and mix by shaking the tube.
5. Transfer one drop of the deposit on to a slide using a Pasteur pipette and cover with a coverslip.
6. Label the slide with the patient's name or identification number.

### Microscopic examination

Using the  $\times 10$  objective and with the condenser lowered, scan the coverslip all over to look for ova of *Schistosoma haematobium* when indicated.

Using the  $\times 40$  objective and with the condenser lowered or aperture reduced, scan the coverslip area again and report any findings as a quantitative value for each high-power field.

The following may be found in urine:

- erythrocytes
- leukocytes
- epithelial cells
- casts
- fungi
- crystals
- parasite eggs and larvae
- *Trichomonas vaginalis*
- spermatozoa.

### Erythrocytes (Fig. 7.9)

Erythrocytes in urine may be:

- (a) intact: small yellowish discs, darker at the edges ( $8\mu\text{m}$ );
- (b) crenated: spiky edges, reduced diameter ( $5\text{--}6\mu\text{m}$ );
- (c) swollen: thin circles, increased diameter ( $9\text{--}10\mu\text{m}$ ).

The shape of the cells often changes during storage of urine and does not have any diagnostic importance.

There are normally very few erythrocytes in urine.

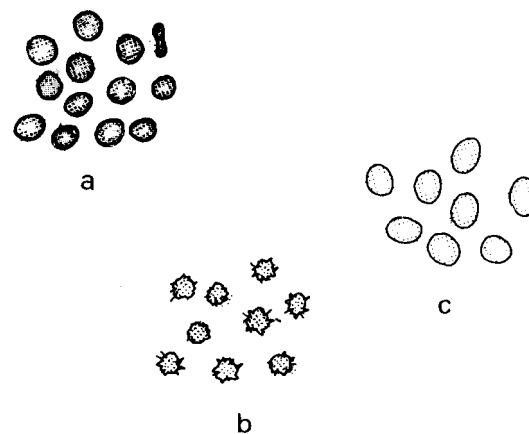

Fig. 7.9 Erythrocytes  
a: Intact cells; b: crenated cells; c: swollen cells.

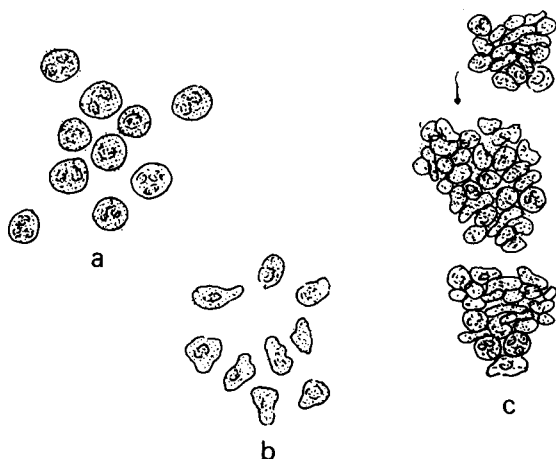

Fig. 7.10 Leukocytes  
a: Intact cells; b: degenerated cells; c: pus.

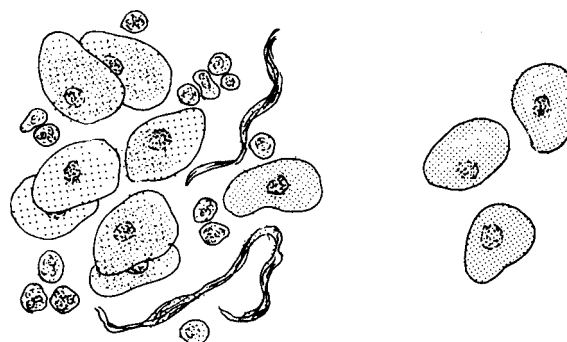

Fig. 7.11 Ureteral and renal pelvic cells

*Note:* Erythrocytes may be found in the urine of women if the specimen has been taken during the menstrual period.

#### **Leukocytes** (Fig. 7.10)

Leukocytes found in urine may be:

- (a) intact: clear granular discs, 10–15  $\mu\text{m}$  (the nuclei may be visible);
- (b) degenerated: distorted shape, shrunken, less granular;
- (c) pus: clumps of numerous degenerated cells.

The presence of many leukocytes, especially in clumps, indicates a urinary tract infection.

How to express the quantity of erythrocytes and leukocytes found in urine deposits

Place one drop of urine deposit on a slide and cover with a coverslip.

Using the  $\times 40$  objective, examine the deposit and count the number of erythrocytes and leukocytes per microscope field.

Report the results as described in Tables 7.3 and 7.4.

#### **Ureteral and renal pelvic cells** (Fig. 7.11)

Medium-sized oval cells with a distinct nucleus.

If many cells are present together with leukocytes and filaments, they may be from the ureter. If a few are present, with no leukocytes, they may be cells from the renal pelvis.

**Table 7.3 Reporting the results of microscopic examination of urine for erythrocytes**

Number of erythrocytes per microscope field	Result
0–10	few erythrocytes (normal)
10–30	moderate number of erythrocytes
> 30	many erythrocytes

**Table 7.4 Reporting the results of microscopic examination of urine for leukocytes**

Number of leukocytes per microscope field	Result
0–10	few leukocytes (normal)
10–20	moderate number of leukocytes
20–30	many leukocytes
20–30 (degenerated) in clumps	many leukocytes seen in clumps
> 30 (degenerated) in clumps	full field

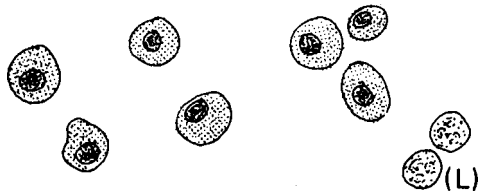

Fig. 7.12 Renal cells

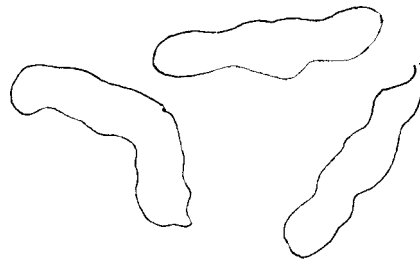

Fig. 7.13 Hyaline casts

**Renal cells** (Fig. 7.12)

Renal cells are smaller than renal pelvic cells (the size of 1–2 leukocytes) and are very granular. The nucleus is shiny and clearly visible.

Renal cells are almost always present with protein in the urine.

**Casts**

Casts are cylindrical in shape and long, crossing almost the whole field when examined under the  $\times 40$  objective.

*Hyaline casts* are transparent and slightly shiny; the ends are rounded or tapered (Fig. 7.13). They may be found in healthy persons after strenuous muscular effort and have no diagnostic significance.

*Granular casts* are rather short casts filled with large granules, pale yellow in colour, with rounded ends (Fig. 7.14). The granules come from degenerated epithelial cells from the tubules of the kidney and have no diagnostic significance.

*Fine granular casts* (Fig. 7.15) have smaller granules that do not fill the cast (a). Do not confuse with hyaline casts, partly covered by amorphous phosphate crystals (b).

*Blood casts* are filled with more or less degenerated erythrocytes, brownish in colour (Fig. 7.16). They are found in acute kidney disease.

*Pus casts* (Fig. 7.17) are completely filled with leukocytes (a). Do not confuse with hyaline casts, which may contain a few leukocytes (b). Pus casts are found in patients suffering from kidney infection.

*Epithelial casts* are filled with pale yellow epithelial cells (Fig. 7.18). (To make the cells more distinct, add a drop of 10% acetic acid (reagent no. 2) to the deposit.) Epithelial casts have no diagnostic significance.

*Fatty casts* are very shiny yellowish casts; the edges are indented and distinct and the ends are rounded (Fig. 7.19). They are soluble in ether but not in acetic acid. Fatty casts are found in patients with severe kidney disease.

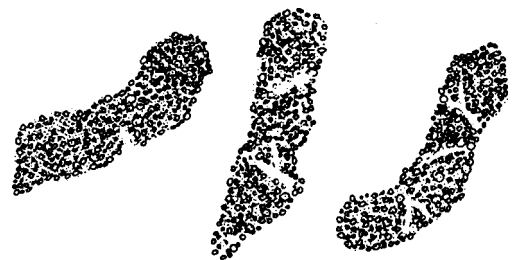

Fig. 7.14 Granular casts

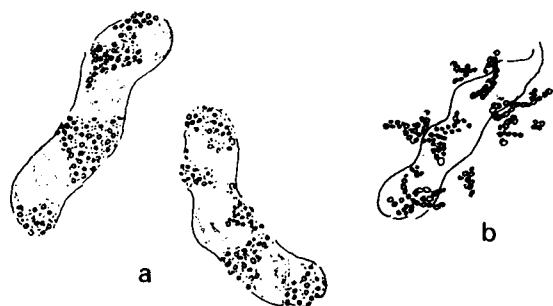

Fig. 7.15 Fine granular casts  
a: True fine granular casts; b: hyaline casts partly covered by amorphous phosphate crystals.

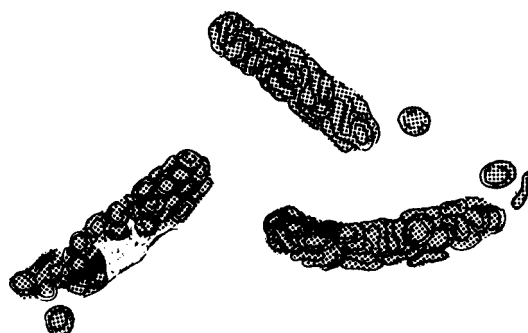

Fig. 7.16 Blood casts

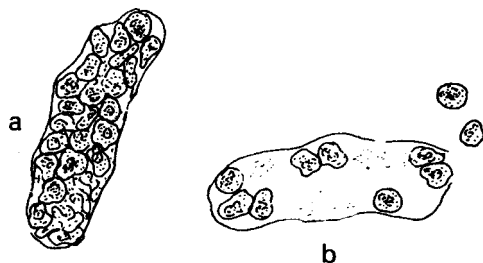

Fig. 7.17 Pus casts  
a: True pus casts; b: hyaline casts.

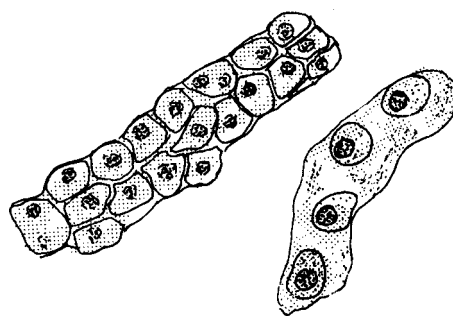

Fig. 7.18 Epithelial casts

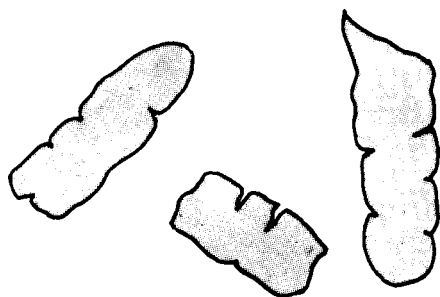

Fig. 7.19 Fatty casts



Fig. 7.20 False casts  
a: Phosphate crystals; b: translucent mucus.

*False casts* (Fig. 7.20). Do not mistake for casts:

- clumps of phosphate crystals, short and clear-cut (a);
- aggregations of translucent mucus, the ends tapering into threads (b).

#### *Miscellaneous foreign substances*

If dirty receptacles or slides are used or if the urine specimen is left exposed to the air, the following may be found (see Fig. 7.21):

- oil droplets (shiny) (a);
- starch granules (which will be stained blue-black with Lugol iodine, 0.5% solution (reagent no. 37)) (b);
- grains of pollen from flowers (c);
- hairs (d);



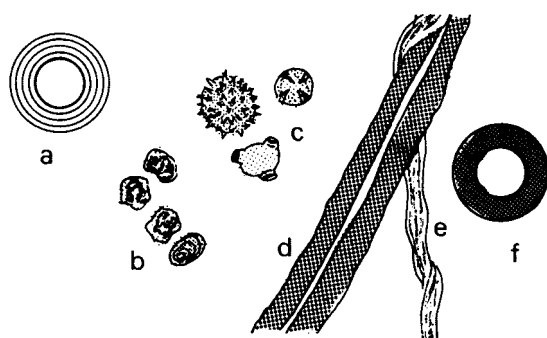

Fig. 7.21 Miscellaneous foreign substances  
a: Oil droplets; b: starch granules; c: pollen grains; d: hairs; e: cotton fibres; f: air bubbles.



Fig. 7.22 Crystals  
a: Crystals; b: amorphous debris.

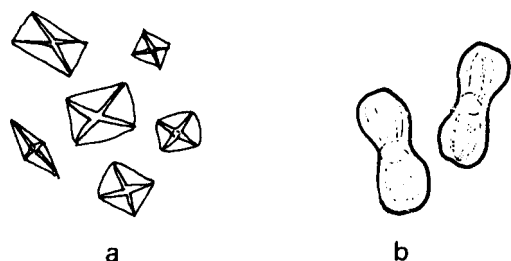

Fig. 7.23 Calcium oxalate crystals  
a: Envelope-shaped crystals; b: peanut-shaped crystals.

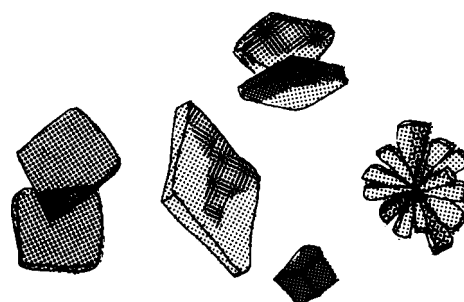

Fig. 7.24 Uric acid crystals

- cotton fibres (e);
- air bubbles (f).

### Crystals (Fig. 7.22)

Crystals have regular geometric shapes (a), unlike amorphous debris, which is made up of clumps of small granules with no definite shape (b). Except in very rare diseases, crystals in urine have no diagnostic significance.

#### Normal crystalline deposits

##### *Calcium oxalate (acid urine) (Fig. 7.23)*

*Size:* 10–20  $\mu\text{m}$  (a) or about 50  $\mu\text{m}$  (b).

*Shape:* envelope-shaped (a) or peanut-shaped (b).

*Colour:* colourless, very shiny.

##### *Uric acid (acid urine) (Fig. 7.24)*

*Size:* 30–150  $\mu\text{m}$ .

*Shape:* varies (square, diamond-shaped, cubical or rose-shaped).

*Colour:* yellow or brownish-red.

##### *Triple phosphates (neutral or alkaline urine) (Fig. 7.25)*

*Size:* 30–150  $\mu\text{m}$ .

*Shape:* rectangular (a) or like a fern leaf or star (b).

*Colour:* colourless, shiny.

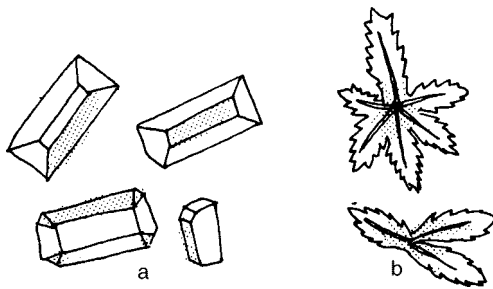

Fig. 7.25 Triple phosphate crystals  
a: Rectangular-shaped crystals; b: fern leaf-shaped crystals.

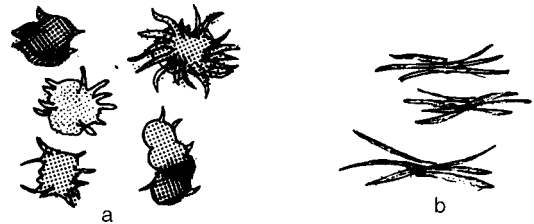

Fig. 7.26 Urate crystals  
a: Cactus-shaped crystals; b: needle-shaped crystals.

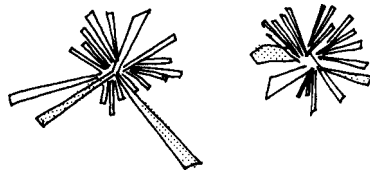

Fig. 7.27 Calcium phosphate crystals



Fig. 7.28 Calcium carbonate crystals

*Urates (alkaline urine)* (Fig. 7.26)

*Size:* about 20  $\mu\text{m}$ .

*Shape:* like a cactus (a) or a bundle of needles (b).

*Colour:* yellow, shiny.

Urates are often found together with phosphates.

*Calcium phosphate (neutral or alkaline urine)* (Fig. 7.27)

*Size:* 30–40  $\mu\text{m}$ .

*Shape:* like a star.

*Colour:* colourless.

*Calcium carbonate (neutral or alkaline urine)* (Fig. 7.28)

*Size:* very small.

*Shape:* similar to millet or corn grains, grouped in pairs.

*Colour:* colourless.

If acetic acid, 10% solution (reagent no. 2) is added, the crystals dissolve, giving off bubbles of gas.

*Calcium sulfate (acid urine)* (Fig. 7.29)

*Size:* 50–100  $\mu\text{m}$ .

*Shape:* long prisms or flat blades, separate or in bundles.

Calcium sulfate crystals can be distinguished from calcium phosphate crystals by measuring the pH of the urine.

Amorphous debris

*Amorphous phosphates (alkaline urine)* (Fig. 7.30)

Amorphous phosphates appear as small, whitish granules, often scattered.

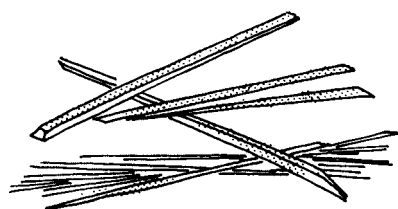

Fig. 7.29 Calcium sulfate crystals

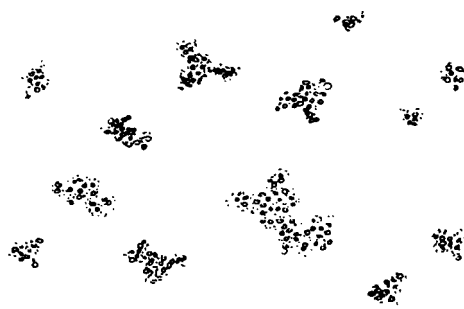

Fig. 7.30 Amorphous phosphates

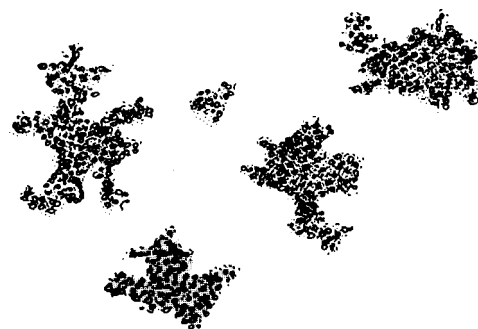

Fig. 7.31 Amorphous urates

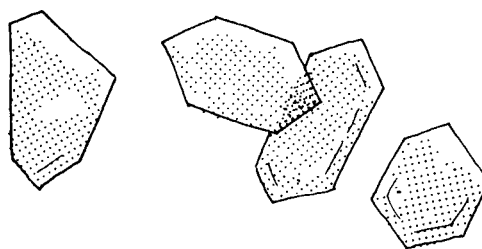

Fig. 7.32 Cystine crystals

They are soluble in acetic acid, 10% solution (reagent no. 2) (one drop per drop of deposit).

*Amorphous urates (acid urine)* (Fig. 7.31)

Amorphous urates appear as very small, yellowish granules, which are grouped in compact clusters.

They are not soluble in acetic acid, 10% solution (reagent no. 2), but dissolve if the urine is gently heated.

(Urine kept in the refrigerator often shows a heavy precipitate of urates.)

Other crystalline deposits

The following are rarely found in the urine. When present, however, they are found in large quantities in patients with certain diseases.

*Cystine (acid urine)* (Fig. 7.32)

*Size:* 30–60  $\mu\text{m}$ .

*Shape:* hexagonal plates.

*Colour:* colourless, very shiny.

Cystine crystals are found only in fresh urine as they are soluble in ammonia.

They are found in patients with cystinuria, a very rare hereditary disease.

*Cholesterol (acid urine)* (Fig. 7.33)

*Size:* 50–100  $\mu\text{m}$ .

*Shape:* squarish plates, with notches on one side.

*Colour:* colourless, shiny.

Cholesterol crystals are found in the urine of patients with nephrotic syndrome.

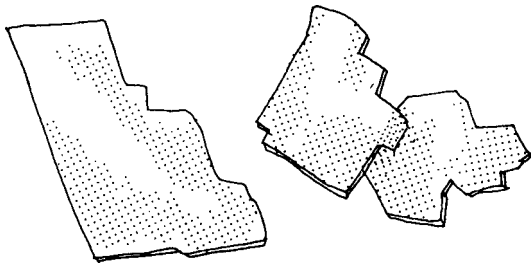

Fig. 7.33 Cholesterol crystals

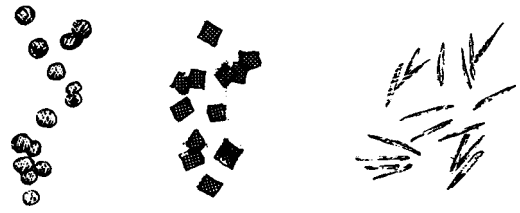

Fig. 7.34 Bilirubin crystals

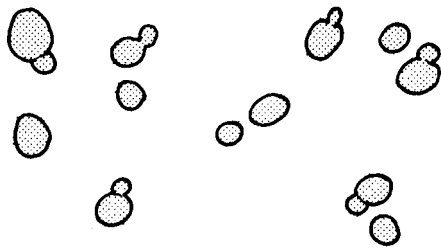
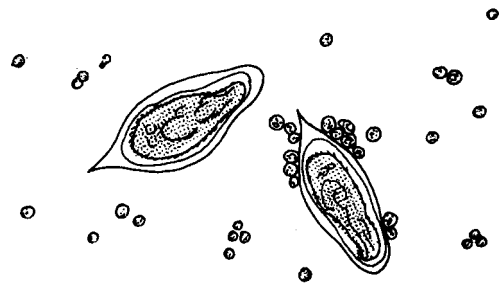

Fig. 7.35 Fungi

Fig. 7.36 *Schistosoma haematobium*

*Bilirubin (very rare)* (Fig. 7.34)

*Size:* about 5  $\mu\text{m}$ .

*Shape:* square or like beads or needles.

*Colour:* brown.

(The chemical test for bile pigments is positive.)

*Acetyl sulfonamides (neutral or acid urine)*

*Shape:* varied, but often similar to sheaves of needles.

Acetyl sulfonamide crystals are found in the urine following treatment with sulfonamide drugs. The presence of these crystals should be reported as they can cause kidney damage.

*Fungi* (Fig. 7.35)

*Size:* 5–12  $\mu\text{m}$ .

*Shape:* round or oval bodies of various sizes found together. Do not confuse with erythrocytes. Budding may be seen. Fungi are not soluble in acetic acid.

Fungi are occasionally present in urine containing glucose. Check that the urine specimen is fresh.

*Parasite eggs and larvae*

The following may be found:

- eggs of *Schistosoma haematobium*: found together with erythrocytes (Fig. 7.36);
- microfilariae of *Wuchereria bancrofti* (see Fig. 4.121): the urine appears white and cloudy.

### 7.2.8 Detection of *Schistosoma haematobium* infection

In countries where schistosomiasis is endemic, urine specimens are examined for eggs of *Schistosoma haematobium*. Trophozoites of *Trichomonas vaginalis* may also be seen. Microfilariae of *Wuchereria bancrofti* and *Onchocerca volvulus* may also be found in the centrifuged sediment of urine from patients in countries where filariasis is endemic.

The first indirect evidence of *Schistosoma haematobium* infection is haematuria and/or proteinuria, which is detectable using a urine dipstick (see section 7.2.2). Gross haematuria indicates heavy infection.

The two methods used for detection of ova of *Schistosoma haematobium* are sedimentation and filtration. The sedimentation method is less sensitive but is cheaper and simpler to perform. The filtration technique is used when quantitative information is required for epidemiological surveillance purposes.

#### Materials and reagents

- Microscope
- Microscope slides
- Coverslips
- Centrifuge (sedimentation method)
- Conical centrifuge tubes, 15 ml (sedimentation method)
- Filter holder, 13 or 25 mm diameter (filtration method)
- Membrane filter, 12–20 µm pore size (nylon or polycarbonate) or Whatman No. 541 (or equivalent) filter-paper (filtration method)
- Conical flask for urine collection
- Pasteur pipettes (sedimentation method)
- Plastic syringe, 10 ml (filtration method)
- Lugol iodine, 0.5% solution (reagent no. 37) (filtration method)
- Formaldehyde, 37% solution.

#### Method

##### *Collection of urine specimens*

The number of ova in the urine varies throughout the day; it is highest in urine obtained between 10:00 and 14:00. The specimen should therefore be collected between these times and should consist of a single terminal urine specimen (see section 7.1.1) of at least 10 ml. Alternatively, a 24-hour collection of terminal urine can be made (see section 7.1.1).

The whole specimen must be examined, as it may contain only a few ova. Ask the patient to collect the urine in a clean flask or bottle. Examine the specimen at once.

If the urine cannot be examined for an hour or longer, add 1 ml of undiluted formalin (37% formaldehyde solution) to each 100 ml of urine. This will preserve any eggs that might be present.

*Note:* If formalin is not available, 2 ml of ordinary household bleach can be added to each 100 ml of urine.

*Warning:* Formalin and bleach are corrosive and must not be swallowed.

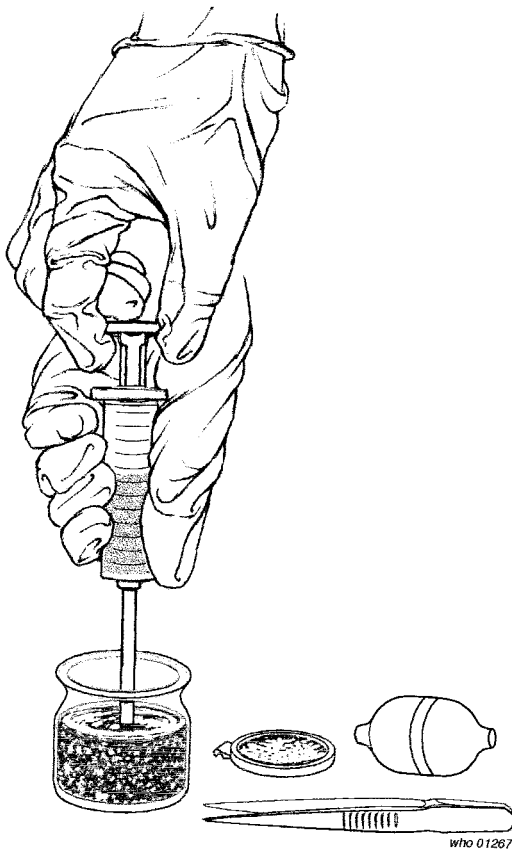

Fig. 7.37 Drawing urine into the syringe

#### **Sedimentation method**

1. Shake the urine specimen well and pour into the conical flask.
2. Allow the urine to sediment for 1 hour. Remove the supernatant and transfer the sediment into a centrifuge tube. Centrifuge at 2000g for 2 minutes.
3. Examine the deposit under the microscope for the presence of ova.

Do not increase the centrifugation time and do not exceed 2000g as this may disrupt the ova and release miracidia.

#### **Important:**

- process the specimen as soon as possible;
- shake the container before pouring the urine specimen into the conical flask;
- label slides and tubes carefully.

#### **Filtration method**

1. Place a filter in the filter holder.
2. Agitate the urine sample gently and draw 10 ml into the syringe (Fig. 7.37). Attach the syringe to the filter holder.
3. Expel the urine from the syringe through the filter over a bucket or sink (Fig. 7.38).
4. Disconnect the syringe from the filter holder. Draw air into the syringe (Fig. 7.39), reattach the syringe to the filter holder and expel the air through the filter (Fig. 7.40).



Fig. 7.38 Expelling the urine through the filter

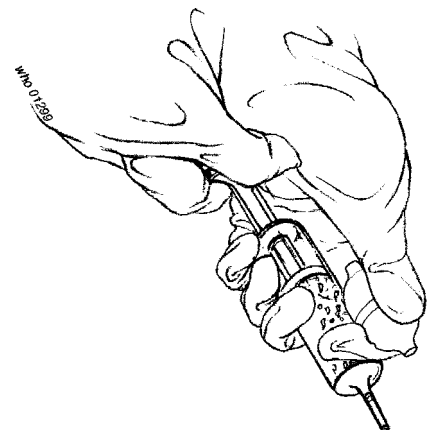

Fig. 7.39 Drawing air into the syringe

5. Disconnect the syringe from the filter holder. Using forceps, carefully remove the membrane filter or filter-paper and place it on a microscope slide. The nylon membrane and filter-paper should be placed face-up, while the polycarbonate membrane should be placed face-down.
6. Add one drop of Lugol iodine solution to improve the visibility of the eggs.
7. Examine the entire filter under the microscope at  $\times 10$  or  $\times 40$ . Record the results as the number of eggs per 10 ml of urine.

### Reuse of filters

If you have used a plastic filter, remove it immediately after use and soak it overnight in a 1% hypochlorite solution (domestic bleach). After soaking the filter, wash it thoroughly with detergent solution, then rinse it several times with clean water. Check the filter under the microscope to ensure that it is free of parasites before reusing it.

### Microscopic examination

The eggs of *Schistosoma haematobium* are large, about 120–150 µm long, and have a terminal spine at one end (Fig. 7.41 (a)). An embryo (the miracidium) can be seen inside the egg.

Sometimes it is necessary to determine whether the eggs are viable. This can be done if the specimen is fresh and no preservatives have been added.

Look carefully at the eggs to see if the embryos are moving. This is the best indication of viability. If no movement is seen, look for the “flame cells” (Fig. 7.41 (b)). There are four flame cells, one at each corner of the embryo. Use a ×100 objective with slightly reduced illumination to look for the rapid movement of cilia (short hairs) in the flame cells.

### Reporting the results

When the syringe filtration technique is used, the results may be reported according to egg count categories:

- Light infection: 1–49 eggs per 10ml of urine.
- Heavy infection: > 50 eggs per 10 ml of urine.

A third category, such as >500 eggs per 10 ml of urine, or >1000 eggs per 10 ml of urine, may be appropriate in areas where the intensity of infection frequently reaches this level (i.e. in more than 10% of cases).

### 7.2.9 Detection of bacteria

In healthy persons the urine contains practically no organisms. Bacteria may be found in patients who have an infection of some part of the urinary tract (e.g. urethritis, cystitis or nephritis), or where bacteria from an infection elsewhere in the body are excreted in the urine.

The urine is centrifuged at high speed and the resulting deposit is examined under the microscope (as described in section 7.2.7). This is the most important part of the analysis. However, the deposit may also be used to make smears that are stained by Gram and Ziehl–Neelsen stains and examined under the microscope.

Culture is always essential for precise determination of the identity of the organisms found and the quantity present.

### Materials and reagents

- Microscope
- Microscope slides
- Sterile 250-ml Erlenmeyer flask with stopper
- Centrifuge
- Sterile conical centrifuge tubes with stoppers
- Inoculating loop
- Bunsen burner or spirit lamp
- 70% Ethanol



Fig. 7.40 Expelling air from the syringe

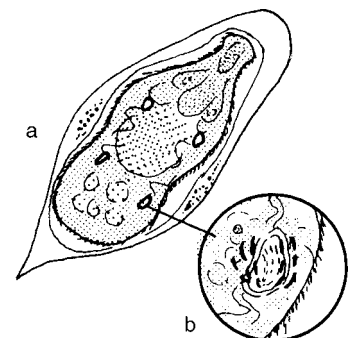

Fig. 7.41 *Schistosoma haematobium*  
a: Miracidium;  
b: flame cells.

- Reagents needed for Gram staining (see section 5.3.1) and Ziehl–Neelsen staining (see section 5.3.3).

## Method

### *Collection of specimens*

The genitals should be cleansed beforehand, using soap and water. Collect a mid-stream specimen (see section 7.1.1) in the sterile flask. Examine as quickly as possible. (Another way is to collect the urine in a conical tube rinsed only in boiling water and to examine it immediately.)

### *Preparation of slides*

1. Pour 10 ml of fresh urine into a sterile centrifuge tube. Seal the tube with either a screw-cap or a plug of sterile cotton wool fixed with gauze and string.
2. Centrifuge the specimen at 1500g for 10 minutes. If tuberculosis is suspected, centrifuge a further 10-ml specimen at 5000g for 20 minutes.
3. Pour off the supernatant from the two tubes (Fig. 7.42). Using an inoculating loop (sterilized by flaming) (Fig. 7.43), mix the deposit with distilled water until it forms a homogeneous suspension.

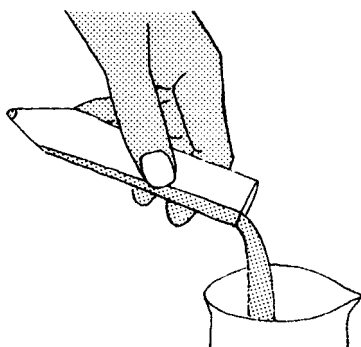

Fig. 7.42 Pouring off the supernatant fluid

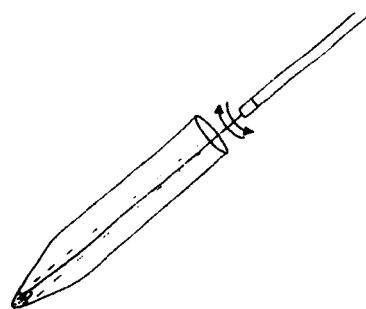

Fig. 7.43 Mixing the urinary deposit

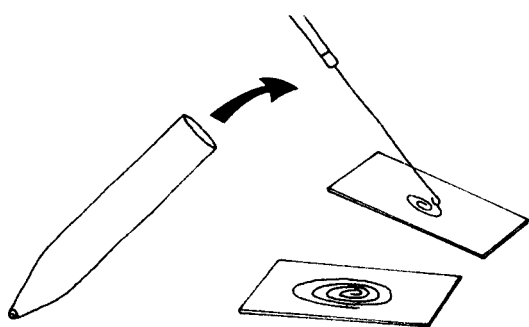

Fig. 7.44 Preparation of smears from the urinary deposit

4. Using an inoculating loop (sterilized by flaming), prepare a smear from each of the two suspensions (Fig. 7.44). Leave the slides to air-dry.
5. Fix the slides by flooding with ethanol and flaming or by heating.
6. Stain the first slide with Gram stain (see section 5.3.1) and the second with Ziehl–Neelsen stain (see section 5.3.3).

### Microscopic examination

Examine the slides under the microscope using the  $\times 100$  objective.

Examine the slide stained with Gram stain for the following (see section 5.3.1):

- pus (many leukocytes stained red by Gram stain)
- Gram-negative bacilli (Fig. 7.45(a))
- Gram-positive cocci (Fig. 7.45(b))
- Gram-positive diphtheroid bacilli (Fig. 7.45(c))
- Gram-positive fungi (Fig. 7.45(d)).



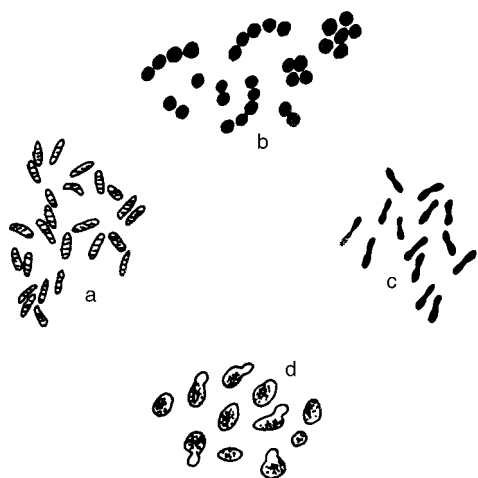

Fig. 7.45 Bacteriological examination of urine  
a: Gram-negative bacilli; b: Gram-positive cocci; c: Gram-positive diphtheroid bacilli; d: Gram-positive fungi.



Fig. 7.46 Tubercle bacilli

Examine the slide stained with Ziehl–Neelsen stain for tubercle bacilli. Tubercle bacilli appear dark red and are arranged in rows (Fig. 7.46).

### Reporting the results

State whether pus or leukocytes are present. Give a precise description of the organisms found.

#### Example

Organisms found:

- many leukocytes
- a few erythrocytes
- a few epithelial cells
- many Gram-positive cocci in clusters.

or

Organisms found:

- a few leukocytes
- occasional erythrocytes
- a few epithelial cells
- a few Gram-negative bacilli.

### Gonococci

Never diagnose a gonococcal infection on the basis of an examination of a urinary deposit. Look for gonococci in urethral pus (see section 5.5).

### Urine dipsticks

Bacteria in urine may also be detected using urine dipsticks (see section 7.2.2). A commercially available dipstick with reagents for the detection of nitrite (which is produced by certain pathogenic bacteria) and leukocyte esterase has been shown to have a high specificity and a high sensitivity for the detection of bacteria in urine.

***Urine cultures***

Urine cultures are indicated when very high levels of bacteria are detected by microscopy or using urine dipsticks. In such cases, a urine specimen should be dispatched to the bacteriology laboratory without delay for a semi-quantitative culture of the pathogenic organisms and for determination of their sensitivity to antimicrobials.

## 8. Examination of cerebrospinal fluid (CSF)



Cerebrospinal fluid (CSF) is contained in the cavity that surrounds the brain in the skull and the spinal cord in the spinal column (Fig. 8.1). It supplies nutrients to the tissues of the central nervous system and helps to protect the brain and spinal cord from injury.

The volume of the CSF in adults is 100–150 ml. The volume is less in children and varies according to the body length.

### 8.1 Common reasons for investigation of CSF

The most common reasons for investigating CSF are to exclude:

- meningitis
- bleeding into the central nervous system
- certain cancers.

Meningitis is an inflammation of the meninges, the membranes lining the skull and covering the brain and spinal column. It is often caused by infection (see Table 8.1).

Leukaemia, tumours with manifestations in the brain and lead poisoning have also been shown to cause meningitis.

*Note:* Immediate laboratory investigation of the CSF may be life-saving if meningitis is suspected.

### 8.2 Collection of CSF specimens

CSF specimens should be collected only by a physician or a specially trained nurse.

1. The sterile lumbar puncture needle is inserted between the fourth and fifth lumbar vertebrae to a depth of 4–5 cm. The stylet is withdrawn and the fluid flows freely through the needle (Fig. 8.2).
2. Between 6 and 7 ml of CSF are collected in each of two tubes, numbered 1 and 2.

Tube 1 is used for visual inspection, microscopic and chemical analysis.

Tube 2 is used for bacterial culture.

### 8.3 Examination of CSF specimens

#### 8.3.1 Precautions

- *Do not delay in testing the CSF.* Cells and trypanosomes are rapidly lysed in CSF samples. Glucose is also rapidly destroyed, unless preserved with fluoride oxalate (reagent no. 26; see section 10.1).

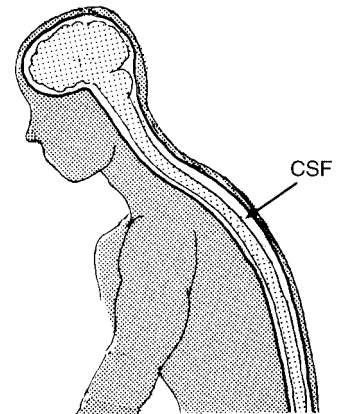

Fig. 8.1 Location of CSF



Fig. 8.2 Collecting a CSF specimen

**Table 8.1 Common causes of meningitis**

Type of infection	Specific organism
Bacterial	<i>Neisseria meningitidis</i>
	<i>Streptococcus</i> spp., especially <i>S. pneumoniae</i>
	<i>Staphylococcus</i> spp.
	<i>Haemophilus influenzae</i>
	<i>Escherichia coli</i>
	<i>Listeria monocytogenes</i>
	<i>Leptospira</i> spp.
	<i>Mycobacterium tuberculosis</i>
	<i>Treponema pallidum</i>
	<i>Pseudomonas</i> spp.
Protozoal	<i>Plasmodium</i> spp.
Viral	Coxsackieviruses
	Arboviruses
	Echoviruses
	Polioviruses
	Mumps virus
	Arenaviruses
	Human herpesviruses
	Hepatitis viruses
Fungal	<i>Candida albicans</i>
	<i>Cryptococcus neoformans</i>

- *Work carefully and economically.* Often only a small quantity of CSF is available for examination. The specimen is difficult to collect so do not waste any of it.
- *The CSF may contain virulent organisms.* Use pipettes plugged with non-absorbent cotton wool, or use a rubber safety bulb to draw up the fluid in the pipette. *Never* pipette CSF by mouth.

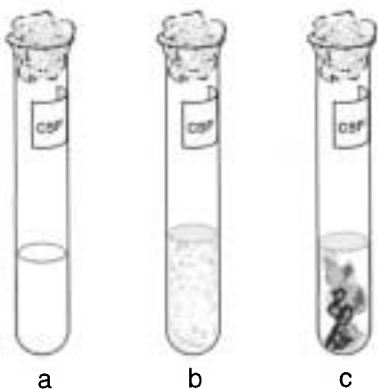

Fig. 8.3 Examining the appearance of CSF  
a: Clear (normal) CSF; b: cloudy CSF;  
c: bloodstained CSF.

### 8.3.2 Direct examination

Describe the appearance of the CSF specimen in the laboratory report.

#### Clear CSF

Normal CSF is clear and colourless (Fig. 8.3 (a)).

#### Cloudy CSF

If pus is present, the CSF may appear slightly cloudy or greyish-white (Fig. 8.3 (b)).

#### Bloodstained CSF

If blood is present, the CSF may appear cloudy and pink or reddish (Fig. 8.3 (c)). Blood is usually present in the CSF for one of two reasons:

- because of injury to blood vessels in the course of the lumbar puncture (in this case there is more blood in tube 1 than in tube 2);
- because of a subarachnoid haemorrhage (in this case both tubes are the same colour).

If only one tube of CSF is available, wait for the erythrocytes to settle (or centrifuge at 2000g for 5 minutes) and examine the supernatant fluid.

If the supernatant fluid is clear (Fig. 8.4), the blood is there because of accidental injury to a blood vessel.

If the supernatant fluid is bloodstained (Fig. 8.5), the blood is there because of a subarachnoid haemorrhage.

### Xanthochromia

Yellow discoloration of the CSF (xanthochromia; Fig. 8.6) may be caused by:

- an old haemorrhage
- severe jaundice
- constriction of the spine.

### Clot formation

Examine the tubes of CSF 10 minutes after collection to see whether clots have formed. Normal CSF has no clots, but clots may be found in the following diseases or conditions:

- tuberculous meningitis: single or numerous small fine clots that can easily be overlooked;
- purulent meningitis: a large clot;
- constriction of the spine: the CSF clots completely.

If clots are present, they should be described in the laboratory report.

### 8.3.3 Microscopic examination

Microscopic examination of CSF includes:

- examination of a wet preparation for blood cells;
- examination of a wet preparation for trypanosomes in areas where African trypanosomiasis occurs;
- examination of a Gram-stained smear for organisms that cause meningitis, such as *Neisseria meningitidis*, *Streptococcus pneumoniae* and *Haemophilus influenzae* (see Table 8.1);
- examination of a Ziehl-Neelsen-stained smear if tuberculous meningitis is suspected;
- examination for fungi such as *Cryptococcus neoformans* and *Candida albicans*, if suspected.

The above examinations are made using the deposit from centrifuged CSF.

### Blood cells in the CSF

The CSF may contain blood cells in varying quantities in certain diseases. The CSF is examined:

- to detect erythrocytes;
- to determine the total number of leukocytes (leukocyte number concentration);
- to determine the types of leukocyte present (differential leukocyte count).



WHO 99120

Fig. 8.4 CSF from a patient with a blood vessel injury



WHO 99121

Fig. 8.5 CSF from a patient with a subarachnoid haemorrhage



WHO 99122

Fig. 8.6 CSF from a patient with xanthochromia

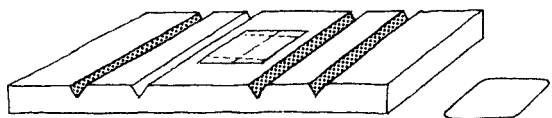
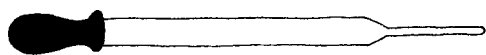

Fig. 8.7 Materials for determining the leukocyte number concentration

*Important:* The investigation of erythrocytes must be carried out as soon as possible after collection of the specimen, since they are rapidly lysed.

#### *Determination of the leukocyte number concentration*

Materials and reagents (Fig. 8.7)

- Microscope
- Fuchs–Rosenthal counting chamber (if not available, an improved Neubauer counting chamber may be used)

- Pasteur pipette with rubber teat
- Coverslips (supplied with the counting chamber)
- Bottle, 2–5 ml
- Türk solution (reagent no. 61).

#### Method

1. Cover the counting chamber with the coverslip supplied (Fig. 8.8).
2. Gently mix the CSF and fill the chamber with the fluid (Fig. 8.9):
  - undiluted, if the CSF appears clear;
  - diluted, if the CSF appears cloudy.

Make a 1 in 20 dilution using 0.05 ml of the CSF and 0.95 ml of Türk solution. Pipette into a small bottle and mix.

3. Leave the counting chamber on the bench for 5 minutes to allow the cells to settle. Place the chamber on the microscope stage.
4. Count the cells in 1 mm<sup>3</sup> of CSF, using the ×10 objective. When reporting in SI units, report as “number × 10<sup>6</sup>/l”; the value does not change.

Example: 150 cells per mm<sup>3</sup> are reported as “150 × 10<sup>6</sup>/l”.

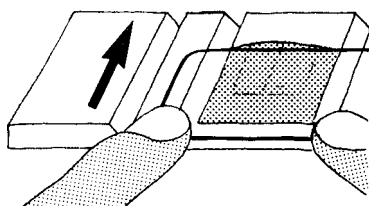

Fig. 8.8 Covering the counting chamber with a coverslip

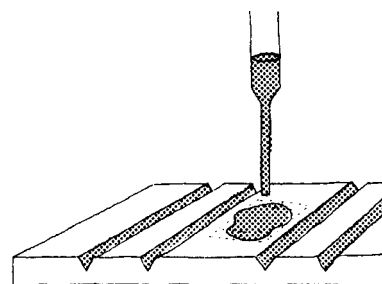

Fig. 8.9 Filling the counting chamber with CSF

*Important:* If undiluted CSF is used, examine the cells using the ×40 objective to make sure that the cells are leukocytes. If erythrocytes are present, make the count using the ×40 objective.

#### *Use of the Fuchs–Rosenthal counting chamber*

The Fuchs–Rosenthal ruled counting chamber has an area of 9 mm<sup>2</sup> (modified chamber) or 16 mm<sup>2</sup>. The depth of the chamber is 0.2 mm.

Count the cells in 5 mm<sup>2</sup> using squares 1, 4, 7, 13 and 16 (Fig. 8.10).

If undiluted CSF is used, no calculation is necessary; the number of cells counted gives the number per mm<sup>3</sup> of CSF.

If a 1 in 20 dilution of CSF is used, the number of cells counted is multiplied by 20 to give the number of cells per mm<sup>3</sup> of CSF.

*Use of the improved Neubauer counting chamber*

If you are using an improved Neubauer chamber, count the cells within the entire ruled area, which is  $9\text{ mm}^3$ .

If undiluted CSF is used, multiply the number of cells counted by 10 and divide by nine to give the number of cells per  $\text{mm}^3$  of CSF.

If a 1 in 20 dilution of CSF is used, multiply the number of cells counted by 20 and divide by nine to give the number of cells per  $\text{mm}^3$  of CSF.

**Results**

Normal CSF contains less than  $5 \times 10^6$  leukocytes per litre (less than 5 per  $\text{mm}^3$ ). An increased number of leukocytes can be found in:

- Bacterial meningitis (meningococcal, *Haemophilus influenzae*, pneumococcal): mostly neutrophils
- Tuberculous and viral meningitis: mostly lymphocytes
- African trypanosomiasis: mostly lymphocytes, but Mott cells may be seen, as well as trypanosomes.

**Determination of the leukocyte type number fraction (differential leukocyte count)****Materials and reagents**

- Microscope
- Microscope slides
- Centrifuge
- Centrifuge tubes
- Pipettes
- Romanowsky stain (see section 9.10.1)
- Methanol.

**Method**

If the CSF does not contain many cells (less than  $200 \times 10^6/\text{l}$ ):

1. Centrifuge the CSF at  $3000\text{ g}$  for 10 minutes. Pour off the supernatant fluid into another tube (to be used for other tests).
2. Mix the deposit by tapping the end of the tube. Spread on a clean slide and leave to dry.
3. Fix with methanol and stain with a Romanowsky stain as described in section 9.10.3. Examine the cells under the microscope using the  $\times 40$  objective.

If there are many cells in the CSF:

1. Pipette one drop of uncentrifuged, mixed CSF on to a slide.
2. Make a thin smear and leave to dry.
3. Fix with methanol and stain with a Romanowsky stain as described in section 9.10.3.

**Wet preparation for trypanosomes****Method**

Place one drop of CSF deposit on a slide and cover with a coverslip. Examine the preparation under the microscope using the  $\times 40$  objective.

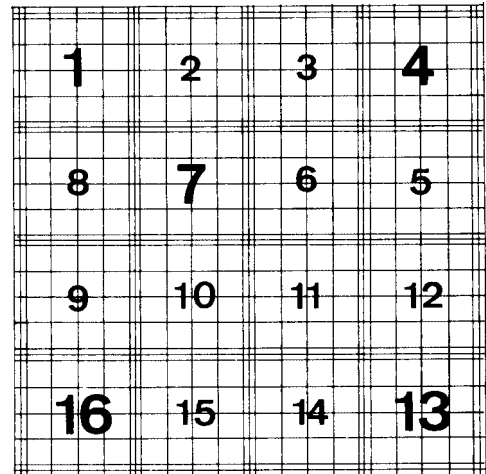

Fig. 8.10 Using the Fuchs–Rosenthal counting chamber

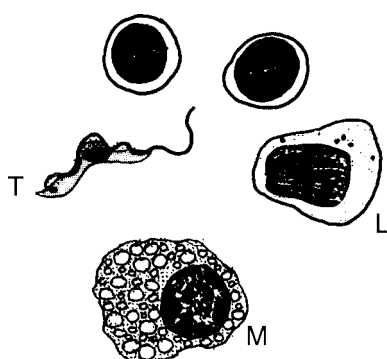

Fig. 8.11 Trypanosomes in a wet preparation stained with Romanowsky stain  
L: lymphocytes; M: Mott cells; T: trypanosomes.

The finding of motile trypanosomes in the CSF means that the later stage of trypanosomiasis has been reached, in which the central nervous system is infected (see section 4.7.3). The protein concentration of the CSF is raised and the Pandy test is positive (see section 8.3.5). The fluid also contains an increased number of white blood cells.

In a wet preparation stained with Romanowsky stain, the leukocytes can be identified as lymphocytes (L), and Mott cells (M) can often be seen (Fig. 8.11). These are large cells containing vacuoles and large amounts of immunoglobulin M (IgM) that stain dark with the eosin part of Romanowsky stains (see section 9.10.4).

### Gram-stained smear for meningitis

#### Method

Make a smear of the CSF deposit and allow it to dry in the air. Stain the smear with Gram stain as described in section 5.3.1.

Report any organisms seen in the Gram-stained smear by their:

- Gram reaction: positive or negative
- morphology: cocci, diplococci, bacilli, etc.
- numbers found.

A definite species identification cannot be made from a Gram-stained smear only. Culture of the organisms is necessary.

The organisms that commonly cause meningitis are described on the following pages.

*Neisseria meningitidis* (meningococci) (Fig. 8.12)

- Gram-negative
- Diplococci, lying side by side
- Intracellular, inside the neutrophils.

*Note:* Diplococci may occasionally be seen outside the cells and are usually few in number.

*Streptococcus pneumoniae* (pneumococci) (Fig. 8.13)

- Gram-positive
- Diplococci, lying end to end

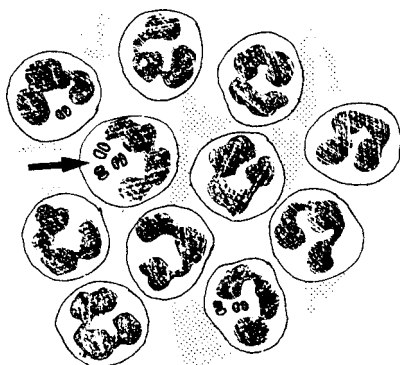

Fig. 8.12 *Neisseria meningitidis*



Fig. 8.13 *Streptococcus pneumoniae*



- Surrounded by a capsule, which is not visible with Gram stain
- Not intracellular
- Usually many in number.

*Haemophilus influenzae* (especially in young children) (Fig. 8.14)

- Gram-negative
- Small bacilli (cocci) bacilli
- Not intracellular
- Often numerous.

In all the above-mentioned forms of meningitis the leukocytes present are neutrophils.

Gram-positive bacilli

Very rarely found. May belong to the *Listeria* group. Culture is essential.

### Ziehl-Neelsen-stained smear for tuberculous meningitis

#### Method

If tuberculous meningitis is suspected, the CSF should be left to stand. If a clot forms, it should be removed, spread on a slide and stained with Ziehl-Neelsen stain, as described in section 5.3.3.

If organisms are seen (Fig. 8.15), report the smear as “acid-fast bacilli present”.

### Fungi in the CSF

Very rarely, fungi (*Cryptococcus neoformans* and *Candida albicans*) may be observed in a smear stained with Gram stain.

*Cryptococcus neoformans* may be found in cloudy CSF with lymphocytes.

#### Method

Mix on a microscope slide:

- one drop of CSF deposit
- one drop of Indian ink.

Examine the mixture between a slide and a coverslip.

*Cryptococcus neoformans* appears as follows (Fig. 8.16):

- round budding spores containing greyish granulations;
- each group of 1–3 spores is surrounded by a colourless capsule.

*Candida albicans* may be found in an unstained wet preparation of CSF deposit. It appears as follows (Fig. 8.17):

- oval budding spores
- short mycelium filaments.

### 8.3.4 Determination of glucose concentration

Glucose concentrations in the CSF are normally about 60% of those in blood, i.e. 2.5–4.2 mmol/l (45–75 mg/100 ml).

In patients with meningitis (especially purulent and tuberculous meningitis), the concentration of glucose in the CSF is greatly reduced.

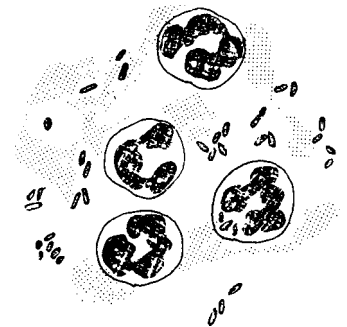

Fig. 8.14 *Haemophilus influenzae*



Fig. 8.15 Acid-fast bacilli

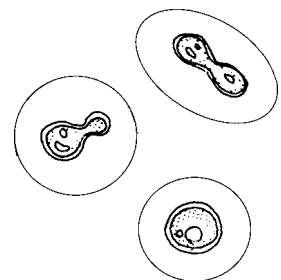

Fig. 8.16 *Cryptococcus neoformans*

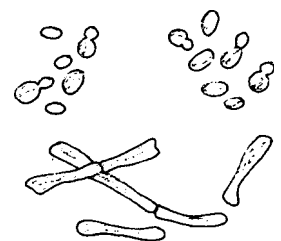

Fig. 8.17 *Candida albicans*

### Method

For determination of glucose concentrations in the CSF, all methods that are used for determination of blood glucose concentrations can be applied. When the orthotoluidine method (see section 10.1) is used, four times more CSF is needed than in the test on blood.

*Important:* As the glucose in the CSF is rapidly destroyed once the fluid is collected, it is important to carry out the estimation of glucose concentration as soon as possible. If there is likely to be a delay, the CSF should be preserved in fluoride oxalate (reagent no. 26).

### 8.3.5 Determination of protein concentration

#### Principle

The total protein concentration in the CSF is measured by diluting the CSF in sulfosalicylic acid and comparing the cloudiness produced against a set of protein standards.

A raised globulin level in the CSF is shown by adding the CSF to a phenol solution in the Pandy test (see below).

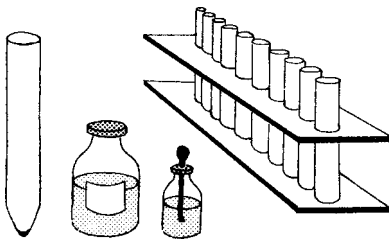

Fig. 8.18 Materials and reagents for determining the protein concentration of CSF

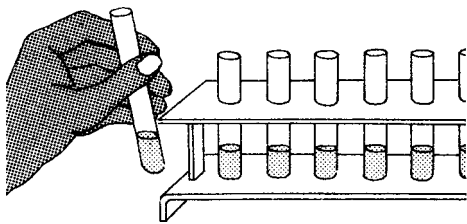

Fig. 8.19 Comparing a test sample against the protein standards

#### Materials and reagents (Fig. 8.18)

- CSF: centrifuge the CSF at 2000g for 5 minutes and use the supernatant fluid
- Graduated pipettes
- Dropping pipettes
- Test-tubes
- Test-tube rack
- Black cardboard
- Sulfosalicylic acid, 3% solution (reagent no. 57)
- Pandy reagent (reagent no. 41)
- Protein standards (see section 7.2.5).

#### Method for determination of total protein

1. Pipette 3 ml of sulfosalicylic acid into a test-tube that matches the standard tubes.
2. Add 1 ml of clear CSF supernatant fluid and mix. Leave the tube for 5 minutes.
3. Compare the cloudiness of the test sample against the protein standards (Fig. 8.19). Record the concentration of protein in the CSF in g/l.

The normal concentration of protein in the CSF is 100–450mg/l. The protein concentration is increased in:

- meningitis, subarachnoid haemorrhage or constriction of the spine;
- African trypanosomiasis.

#### Method for determination of globulin (Pandy test)

1. Measure 1 ml of Pandy reagent into a small test-tube.
2. Place the tube in front of a piece of black cardboard.

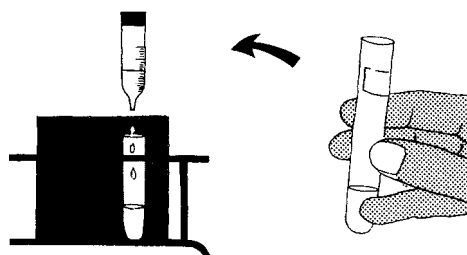
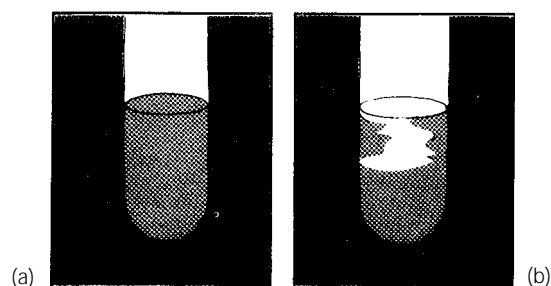

Fig. 8.20 Adding CSF to Pandy reagent

Fig. 8.21 Pandy test for globulin  
a: Positive result; b: negative result**Table 8.2 Typical findings on examination of CSF**

Disease or condition	Appearance	Blood cell concentration	Protein concentration	Glucose concentration	Other findings
Purulent meningitis	Cloudy, yellowish	> 3000 cells/ $\mu$ l, mainly granulocytes	Highly elevated, 1–10 g/l	Greatly reduced	Bacteria
Tuberculous meningitis	Clear or almost clear	30–300 cells/ $\mu$ l, mainly lymphocytes	Elevated	Greatly reduced	Bacteria, clotted proteins
Viral meningitis	Clear	10–300 cells/ $\mu$ l, mainly lymphocytes	Normal or slightly elevated	Normal	—
Malaria	Slightly cloudy	Elevated, mainly granulocytes	Elevated	Reduced	—
African trypanosomiasis	Clear or slightly cloudy	> 5 cells/ $\mu$ l, mainly lymphocytes	Elevated	Reduced	Trypanosomes, Mott cells
Subarachnoid haemorrhage	Red	Not interpretable	Not interpretable	Not interpretable	After centrifugation, red
Compression of the spine	Clear, yellowish	Normal or slightly elevated	Highly elevated	Normal	—

3. Using a dropping pipette, slowly add three drops of CSF (Fig. 8.20).

Examine the solution after the addition of each drop.

4. Read the results immediately.

If globulin is present, a white cloud forms as the drops of CSF mix with the reagent (Fig. 8.21 (a)).

If globulin is absent, no white cloud forms as the drops of CSF mix with the reagent, or there is a slight cloudiness that redissolves (Fig. 8.21 (b)).

Report the test as “Pandy test positive” or “Pandy test negative”.

### 8.3.6 Summary

Table 8.2 summarizes the typical findings on examination of CSF.

## 8.4 Dispatch of CSF specimens for culture

Before dispatch keep the CSF in the incubator at 37°C. Do not put it in the refrigerator.

### 8.4.1 Materials and reagents

- Flat bottles containing an appropriate transport medium, such as Stuart transport medium, modified (reagent no. 56).

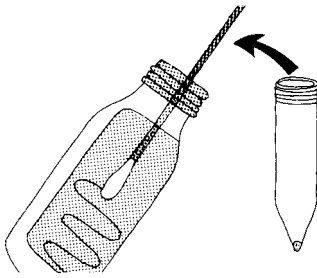

Fig. 8.22 Dispatching CSF specimens for culture using Stuart transport medium

#### 8.4.2 Method using Stuart transport medium (for the isolation of *Neisseria meningitidis*)

This is the best method. The medium is supplied in 30-ml bottles that contain 8 ml of solid medium (along one side of the flat bottle). The bottles are filled with a mixture of air (90%) and carbon dioxide (10%).

Follow the instructions given for gonococci in section 5.5.4.

If possible, sow centrifuged CSF deposit on the medium (Fig. 8.22); otherwise use uncentrifuged CSF.

Preservation time: up to 4 days at room temperature.

---

# 9. Haematology



Haematology is the study of the cells that are found in blood and the factors that affect their functioning.

## Volume of blood in the human body

An adult weighing 60 kg has about 4.5 litres of blood. There is therefore no danger involved in taking 0.5 litre of blood as a donation for transfusion, and no risk in taking two 10-ml tubes or more for analysis. Make this clear to anxious patients when you take their blood.

## 9.1 Types of blood cell

Three main classes of blood cell can be distinguished under the microscope: red cells (erythrocytes), white cells (leukocytes) and platelets (thrombocytes).

### 9.1.1 Erythrocytes (Fig. 9.1)

*Appearance:* round or slightly oval cells filled with haemoglobin. After staining with a Romanowsky stain (see section 9.10.4), they appear pink with a pale central area. From the side erythrocytes look like biconcave discs; they do not contain nuclei.

*Size:* 7–8  $\mu\text{m}$ .

*Number concentration:* normally around  $4\text{--}5 \times 10^{12}$  per litre ( $4\text{--}5 \times 10^6$  per  $\text{mm}^3$ ) of blood.

Erythrocytes carry haemoglobin which combines with and carries oxygen from the lungs to the tissues. They also carry carbon dioxide from the tissues to the lungs, thus removing the principal end-product to which most organic substances are metabolized in the body.

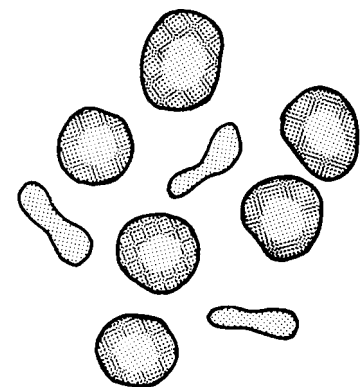

Fig. 9.1 Erythrocytes

### 9.1.2 Leukocytes (Fig. 9.2)

*Appearance:* round cells containing a nucleus and granules in the cytoplasm.

*Size:* 9–20  $\mu\text{m}$ .

*Number concentration:* normally about  $8 \times 10^9$  per litre (8000 per  $\text{mm}^3$ ) of blood.

The presence of a nucleus enables leukocytes to be readily distinguished from erythrocytes under the microscope. There are five types of leukocyte (neutrophils, eosinophils, basophils, lymphocytes and monocytes) which differ in size, shape of the nucleus, colour of the granules in the cytoplasm and other factors. They can be identified by microscopy after staining with a Romanowsky stain (see section 9.10.4).

Leukocytes play an important role in the defence or immune system.

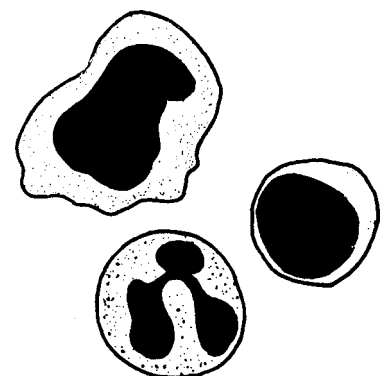

Fig. 9.2 Leukocytes



Fig. 9.3 Thrombocytes

### 9.1.3 Thrombocytes (Fig. 9.3)

Thrombocytes or platelets are fragments of megakaryocytes that are found in the peripheral blood, where they are involved in clot formation.

*Size:* 2–5  $\mu\text{m}$ .

*Cytoplasm:* very little visible, contains granules.

In healthy adults, the blood contains about  $150\text{--}300 \times 10^9$  thrombocytes per litre (150 000–300 000 per  $\text{mm}^3$ ).

#### Clotting of blood<sup>1</sup>

When blood is collected in a glass tube it solidifies within 5–10 minutes forming a clot; it has coagulated.

Clotted blood separates into two components (Fig. 9.4):

- the serum, a yellow liquid;
- the clot, a solid red mass.

If an anticoagulant is added to the blood as soon as it is collected, clotting is prevented and the blood remains fluid. Examples of anticoagulants include: fluoride oxalate (reagent no. 26), trisodium citrate, 3.2% solution (reagent no. 60) and EDTA dipotassium salt, 10% solution (reagent no. 22).

Blood treated with an anticoagulant separates into two liquid components (Fig. 9.5):

- the plasma, a yellow liquid;
- the blood cells, which sediment over time or following centrifugation to form a thin layer of leukocytes over a deposit of erythrocytes.

#### Difference between plasma and serum

- Plasma contains a soluble protein called fibrinogen in addition to a large number of other proteins.
- Serum does not contain fibrinogen, but all the other proteins are present. The fibrinogen is changed into insoluble fibrin, which together with the erythrocytes forms the clot.

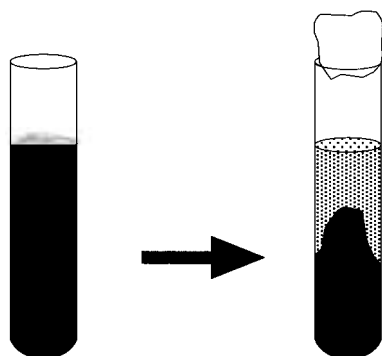

WHO 01.207

Fig. 9.4 Clotted blood

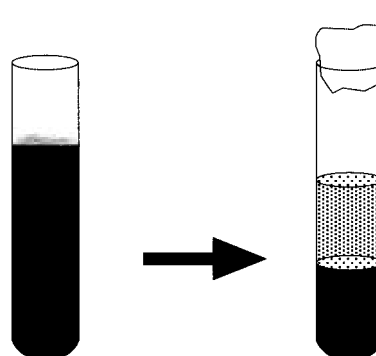

WHO 01.208

Fig. 9.5 Blood treated with an anticoagulant

<sup>1</sup> See section 9.9.

## 9.2 Collection of blood specimens

### 9.2.1 Principle

Venous blood is collected from a vein in the arm with a needle and syringe, as described below.

Capillary blood may be collected from the finger, the ear or the heel (in infants), as described in section 9.4.1.

### 9.2.2 Materials and reagents

- For disinfecting the skin:
  - cotton wool
  - 70% ethanol or tincture of iodine
- For the venepuncture (Fig. 9.6):
  - gloves
  - a tourniquet of soft rubber tubing, 2–3 mm bore
  - needles, 30–40 mm, 20 gauge, 19 gauge, 18 gauge, medium bevel
- For collection of blood:
  - syringes, 2 ml, 5 ml, 10 ml, 20 ml (check that the end of each syringe fits into the needle)
  - bottles or test-tubes (Fig. 9.7), either empty or containing an anticoagulant (see section 9.1.3) and bearing a mark corresponding to the required amount of blood (e.g. at the 5-ml level).

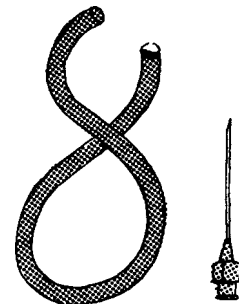

Fig. 9.6 Materials for venepuncture

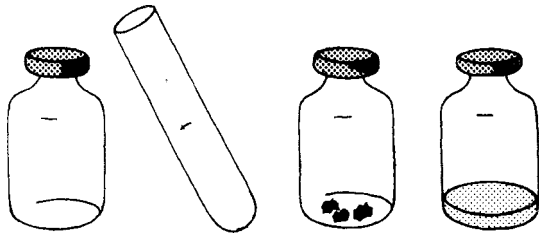

Fig. 9.7 Bottles and test-tubes for collection of blood specimens

If blood samples are to be taken from children under 5 years, 23 gauge or 25 gauge needles will also be required.

Keep a stock of sterile needles in a small glass tube: the point should rest on a pad of non-absorbent cotton wool and the tube should be plugged with the same material.

### 9.2.3 Method

#### Preparation

1. Read the patient's request form carefully:
  - (a) Decide how much blood is needed.
  - (b) Prepare the correct bottle or tube to be used for each test.
2. If blood is to be used for different laboratory investigations, plan the sequence in which blood samples must be taken. (For example, the first 1 ml of blood must be discarded when blood is taken for coagulation assays.)
3. Before taking the blood, wash your hands with soap and water.

Ask the patient to sit alongside the table used for taking blood.

Lay the patient's arm on the table, palm upwards, and support it by placing a small cushion under the elbow (Fig. 9.8).



Fig. 9.8 Taking blood from a patient in the laboratory



Fig. 9.9 Taking blood from a patient in bed

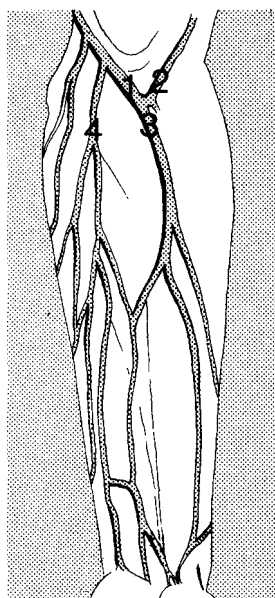

Fig. 9.10 Sites for taking venous blood  
1: Preferred site;  
2, 3, 4: alternative sites.

If the patient is in bed, lay his or her arm in an outstretched position (Fig. 9.9).

The correct site to take the blood is the vein in the bend of the elbow, at the point where the vein is thickest and most easily visible (Fig. 9.10). If possible, choose one of the branches forming a Y just above their junction (1). If necessary, points 2, 3 and 4 can be used as alternatives.

#### Procedure

1. Fix the needle on to the syringe, touching only the top of the needle. Test the needle and syringe to make sure that the needle is not blocked and the syringe is airtight.

Place the end of the needle in the sterile tube until ready for use.

2. Apply the tourniquet. With the right hand, wrap the tourniquet firmly round the arm and hold the ends.
3. With the left hand, pull one of the ends across (Fig. 9.11).
4. Loop the end under the main part of the tourniquet (Fig. 9.12). The tourniquet should be just tight enough to slow down the blood flow in and distend the veins, but it must not be so tight that the blood flow in the arteries is reduced.
5. Ask the patient to open and close his or her hand several times to swell the veins.

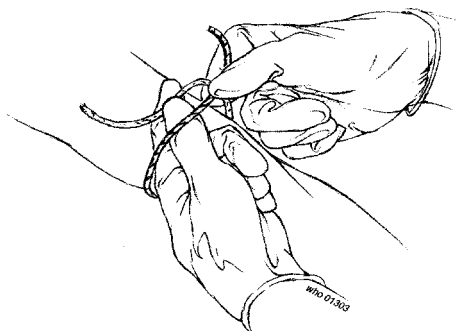

Fig. 9.11 Applying a tourniquet

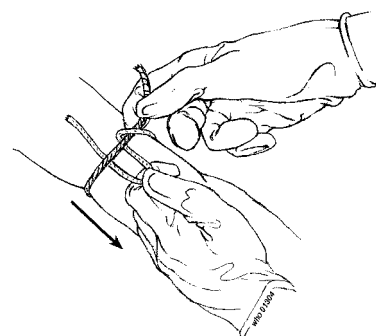

Fig. 9.12 Tying a tourniquet



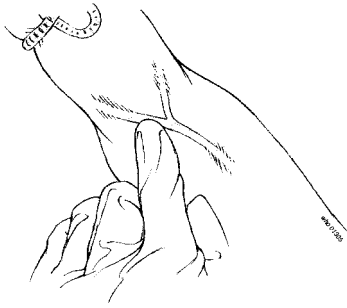

Fig. 9.13 Feeling for a vein



Fig. 9.14 Correct position for holding a syringe

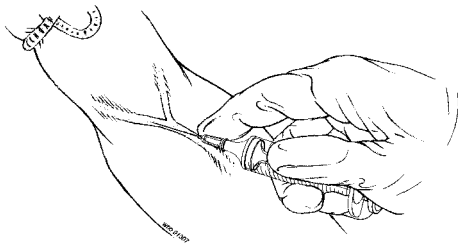

Fig. 9.15 Correct position for venepuncture

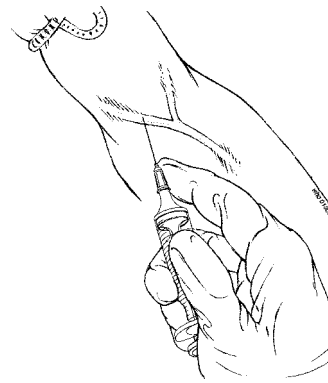

Fig. 9.16 Incorrect position for venepuncture

6. Using the index finger of your left hand, feel for the vein where you will introduce the needle (Fig. 9.13).
7. Disinfect the skin with a swab dipped in tincture of iodine or ethanol.
8. Take the syringe in your right hand, holding your index finger against the top of the needle (Fig. 9.14).
9. Position the needle with the bevel uppermost. Make the venepuncture entering the centre of the vein (Fig. 9.15) without hesitation.

*Important:*

Never approach a vein from the side (Fig. 9.16).

You will feel the needle going through:

- the layer of skin, which is resistant;
- then the wall of the vein, which is less resistant (more flexible).

10. Push the needle along the line of the vein to a depth of 1.0–1.5 cm.
11. With your left hand pull back the piston of the syringe slowly. Blood should appear in the syringe (Fig. 9.17).
12. Remove the tourniquet by pulling on the looped end. Then continue to withdraw the piston to fill the syringe with the required amount of blood (Fig. 9.18).
13. Apply a dry swab over the hidden point of the needle. Withdraw the needle in one rapid movement from under the swab (Fig. 9.19).

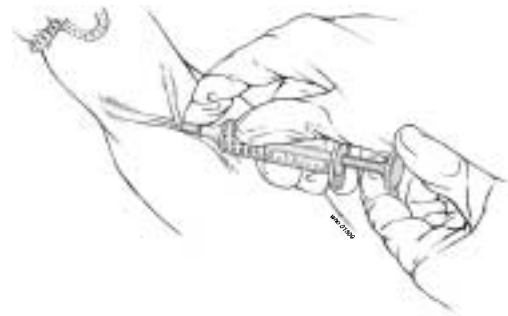

Fig. 9.17 Checking the needle is inserted correctly

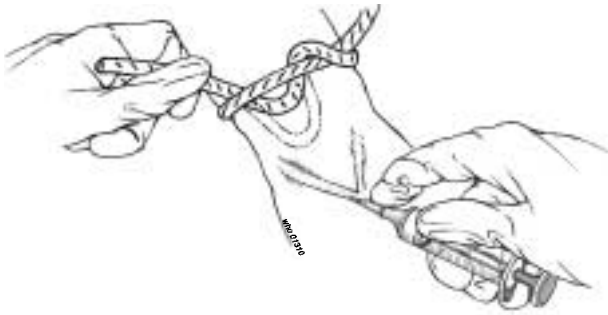

Fig. 9.18 Filling the syringe with blood

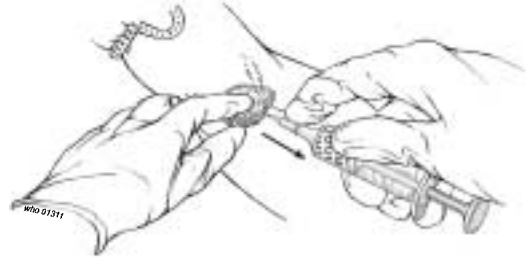

Fig. 9.19 Withdrawing the needle

14. Ask the patient to press firmly on the cotton wool swab for 3 minutes, keeping the arm outstretched (Fig. 9.20(a)). Bending the arm back over the swab (Fig. 9.20(b)) is not recommended (because of the risk of a haematoma).
15. Remove the needle from the syringe.
  - Fill the specimen tubes or bottles with the blood up to the mark (Fig. 9.21).
  - Immediately invert the tubes or bottles that contain anticoagulant several times.
16. Label the tubes or bottles clearly with:
  - the patient's name
  - the date
  - the patient's outpatient or hospital number if this is available.

Rinse the needle and syringe at once with cold water, then rinse in disinfectant (see section 3.5.4).

Place the rinsed needles and syringes in small glass tubes plugged with non-absorbent cotton wool and sterilize in the autoclave or the dry-heat sterilizer (see section 3.5.5). *Never* use a needle or syringe on another person before it has been resterilized. Disposable needles must only be used once, as they cannot be resterilized.

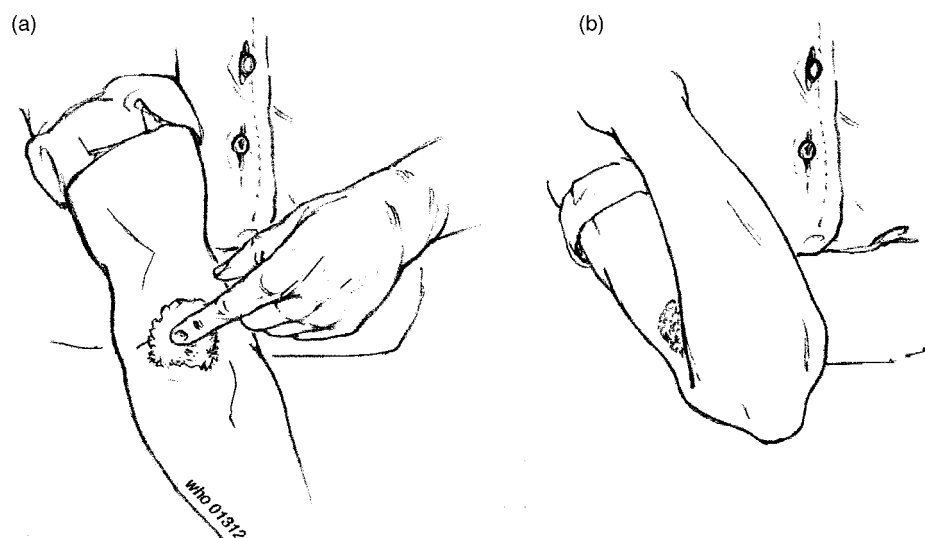

Fig. 9.20 Correct (a) and incorrect (b) positions for stopping blood flow

### 9.3 Estimation of the haemoglobin concentration

Haemoglobin is the red pigment contained in erythrocytes. It consists of protein chains and iron-containing molecules.

#### Units of measurement

The SI unit for expressing haemoglobin concentrations is millimole per litre (mmol/l). When this unit is used, it is necessary to specify the chemical structure to which it applies. In practice, this means that the term “haemoglobin(Fe)” should be used instead of the simple term “haemoglobin”. However, as an interim measure, before making the change to millimole per litre, some laboratories are using the unit “gram per litre” (g/l). When this unit is used, the simple term “haemoglobin” suffices, and it is not necessary to say “haemoglobin(Fe)”. Values in grams per litre may be converted into values in millimoles per litre by multiplying by 0.062.

*Example:*

$$\text{haemoglobin } 150 \text{ g/l} \times 0.062 = \text{haemoglobin(Fe) } 9.3 \text{ mmol/l}$$

In this manual calculations and values are usually expressed in both forms. It should be noted that if the unit “gram per litre” is used, the values are 10 times greater than values in the traditional unit “gram per 100 ml”. For example, 150 g/l = 15.0 g/100 ml.



Fig. 9.21 Transferring the blood to a specimen tube

#### 9.3.1 Haemiglobincyanide photometric method

##### Principle

The blood is diluted in Drabkin diluting fluid, which haemolyses the red cells and converts the haemoglobin into haemiglobincyanide (cyanmethaemoglobin). The solution obtained is examined in a spectrophotometer (or colorimeter). Its absorbance is proportionate to the amount of haemoglobin in the blood.

The haemiglobincyanide photometric method gives the most accurate haemoglobin estimations. It should be used wherever possible.

##### Materials and reagents

- Spectrophotometer<sup>1</sup> (or colorimeter)
- Spectrophotometer (or colorimeter) cuvettes
- Test-tubes
- Test-tube rack
- Blood (Sahli) pipettes, 0.2 ml
- Drabkin diluting fluid (reagent no. 21)
- Reference solution, which may be:
  - the fresh haemiglobincyanide reference solution used to calibrate the instrument,
  - a reference solution previously calibrated against the haemiglobincyanide reference solution, or
  - a blood sample of known haemoglobin concentration.

A calibration curve must be prepared before the spectrophotometer (or colorimeter) can be used for haemoglobin estimation. From such a curve a graph can be prepared and a table made for the haemoglobin values.

<sup>1</sup> Some spectrophotometers run either on mains electricity or on current from a motor car battery. One model is supplied by UNICEF: reference no. 09.309.98 (110 V battery) or 09.310.00 (220 V battery); it can be ordered from the following address: UNICEF, UNICEF Plads, Freeport, DK 2100 Copenhagen, Denmark.

**Important:**

At the beginning of each day:

- Clean the matched spectrophotometer (or colorimeter) cuvettes.
- Fill one of the cleaned tubes with fresh Drabkin diluting fluid, which is used to zero the spectrophotometer (or colorimeter).
- Read a reference solution (see above).

**Calibration of the spectrophotometer (or colorimeter) using haemiglobincyanide reference solution (or a reference solution previously calibrated against haemiglobincyanide reference solution)**

1. Calculate the haemoglobin value of the reference solution in grams per litre by using the following formula:

$$\frac{\text{concentration in mg/100 ml} \times 10^a}{1000^c} \times 251^b$$

where:

a = the factor for converting 100 ml to 1 litre;

b = the dilution factor when 0.02 ml of blood is diluted with 5 ml of Drabkin diluting fluid;

c = the factor for converting milligrams to grams.

Since  $10 \times 251/1000$  is very nearly 2.5, the above formula can be simplified as follows:<sup>1</sup>

haemoglobin value of reference solution in grams per litre = concentration in mg/100 ml  $\times$  2.5

**Example:**

concentration of reference solution = 60 mg/100 ml

haemoglobin value =  $60 \times 2.5 = 150$  g/l

2. Prepare a series of dilutions of the reference solution in four test-tubes (labelled 1–4) (Fig. 9.22). Pipette into each tube the amounts shown in Table 9.1.
3. Mix the contents of the tubes and allow to stand for 5 minutes (Fig. 9.23).
4. Read the dilutions in the spectrophotometer (or colorimeter):
  - (a) Set the wavelength to 540 nanometres (nm) or place a green filter in the spectrophotometer (or colorimeter).
  - (b) Fill a matched cuvette with Drabkin diluting fluid and place in the spectrophotometer (or colorimeter).

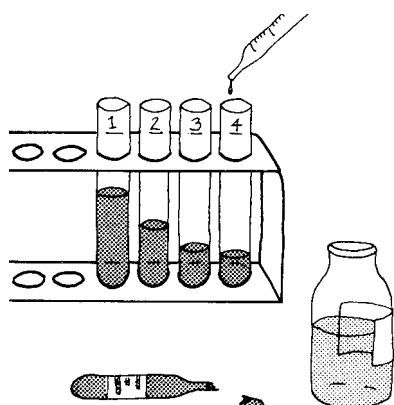

Fig. 9.22 Preparing serial dilutions of haemiglobincyanide reference solution

**Table 9.1 Preparing serial dilutions of reference solution**

Tube number	Volume of reference solution (ml)	Volume of Drabkin diluting fluid (ml)	Dilution
1	4.0	0.0	undiluted
2	2.0	2.0	1:2
3	1.3	2.7	1:3
4	1.0	3.0	1:4

<sup>1</sup> If a dilution of 1 in 200 is used (i.e. 0.02 ml of blood and 4 ml of Drabkin diluting fluid), multiply by 2.0 instead of 2.5.

**Table 9.2 Sample spectrophotometer readings for different dilutions of reference solution**

Dilution	Haemoglobin concentration (g/l)	Absorbance at 540nm
undiluted	150	35.0
1:2	$150/2 = 75$	17.5
1:3	$150/3 = 50$	11.5
1:4	$150/4 = 37.5$	8.5

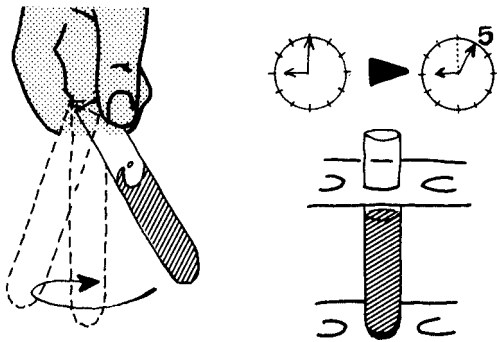

Fig. 9.23 After mixing the dilutions of reference solution, leave them to stand for 5 minutes

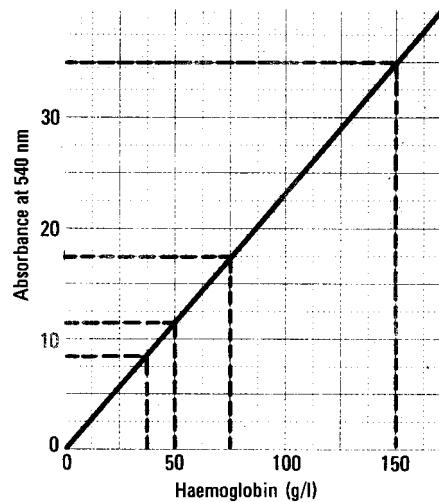

Fig. 9.24 Standard curve for determining the haemoglobin concentration of blood specimens

- (c) Zero the spectrophotometer.
- (d) Read the contents of tubes 1 to 4, using a cuvette.

Make sure the needle returns to zero between each reading with Drabkin diluting fluid.

5. Prepare a graph, plotting the readings of the diluted reference solutions against their respective haemoglobin concentrations (Table 9.2 and Fig. 9.24).
6. From the graph make a table of haemoglobin values from 20 to 180 g/l.

**Calibration of the spectrophotometer (or colorimeter) using a blood sample of known haemoglobin concentration**

1. Obtain a sample of blood of known haemoglobin concentration (e.g. 168 g/l).
2. Switch on the spectrophotometer (or colorimeter) and set to wavelength 540 nm.
3. Pipette 8 ml of Drabkin diluting fluid into a test-tube. Add 0.04 ml of well-mixed blood. Be sure to wipe the outside of the pipette beforehand to avoid adding excess blood. Mix the haemoglobinocyanide solution by inverting several times. Leave to stand for 10 minutes.
4. Zero the spectrophotometer using Drabkin diluting fluid.
5. Read and record the absorbance of the haemoglobinocyanide solution prepared above.
6. Prepare a series of dilutions of the haemoglobinocyanide solution in four test-tubes (labelled 1–4) as shown in Table 9.3.
7. Read and record the absorbances of the diluted solutions.

**Table 9.3 Preparing serial dilutions of haemiglobincyanide solution**

Tube number	Volume of haemiglobincyanide solution (ml)	Volume of Drabkin diluting fluid (ml)	Concentration of haemoglobin <sup>a</sup> (g/l)
1	4.0	1.0	13.4
2	3.0	2.0	10.1
3	2.0	3.0	6.7
4	1.0	4.0	3.4

<sup>a</sup>In this example, it is assumed that the haemoglobin concentration of the haemiglobincyanide solution is 168 g/l.

8. Plot a graph of absorbance against haemoglobin concentration, using ordinary graph paper. Draw a straight line starting at the origin passing as close to each point as possible. Extend the line so that you can read absorbances for haemoglobin values greater than 168 g/l.

A reference table of values is prepared using the graphs obtained from either of the above methods:

- Draw up a table of absorbance readings starting from 0.00, 0.01, 0.02 and ending at 1.50.
- Determine the haemoglobin concentrations for each of the absorbances from the graph.

#### *Precautions*

- Potassium cyanide is very poisonous. It must be kept in a locked cupboard at all times when not in use. Wash your hands immediately after handling it.
- Store Drabkin diluting fluid in a brown reagent bottle because it decomposes on exposure to light. If a brown reagent bottle is not available, use a clear glass bottle carefully wrapped in silver foil.
- Drabkin diluting fluid should be clear and pale yellow. If it becomes turbid, or loses its colour, it should be discarded. The clarity of the diluting fluid can be checked by measuring its absorbance in a spectrophotometer at 540 nm against water as a blank. The absorbance must read zero.
- Once the haemiglobincyanide solution has been prepared, the haemoglobin estimation must be carried out within 6 hours.
- Drabkin diluting fluid remains stable for several months when stored at cool temperatures. If the room temperature exceeds 30 °C, store it in a refrigerator at 4–6 °C. Do not freeze, as this may cause decomposition of the compound. Always allow the diluting fluid to warm to room temperature before use.

#### **Method**

1. Pipette 5 ml of Drabkin diluting fluid into a tube. Draw venous or capillary blood to the 0.02-ml mark of a blood (Sahli) pipette. Do not allow air bubbles to enter. With venous blood ensure that it is well mixed by inverting the bottle containing it and the anticoagulant repeatedly for about 1 minute immediately before pipetting it.
2. Wipe the outside of the pipette. Check that the blood is still on the 0.02-ml mark (Fig. 9.25). Squeeze the bulb of the pipette to expel the blood into the Drabkin diluting fluid and rinse the pipette by drawing up and expelling the fluid in the tube three times.
3. Mix the contents of the tube and leave for 5 minutes (see Fig. 9.23).

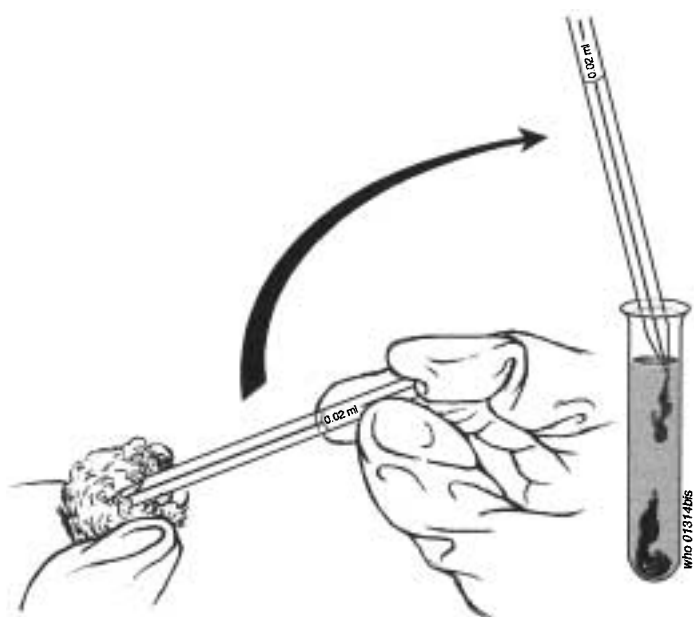

Fig. 9.25 Checking that the blood is still on the mark

4. Zero the colorimeter using Drabkin diluting fluid. Read the absorbance of the patient's diluted blood in the spectrophotometer test-tube or cuvette.

If cloudiness appears in the diluted blood, this may be attributable to abnormal plasma proteins or to a high concentration of white cells. Centrifuge the diluted blood at 2000g for 5 minutes before taking a reading.

Using the table prepared from the calibration curve, record the concentration of haemoglobin in g/l.

### Reference range

Table 9.4 shows the reference ranges for different age groups.

**Table 9.4 Normal haemoglobin concentrations, by age group**

Age group	Haemoglobin (Fe) concentration (mmol/l)	Haemoglobin concentration (g/l)
Newborn infants	8.4–12.1	136–196
Infants (1 year)	7.0–8.1	113–130
Children (10–12 years)	7.4–9.2	115–148
Women	7.4–9.9	120–160
Men	8.1–11.2	130–180

### 9.3.2 Alkaline haematin D method

#### Principle

When a blood sample is added to an alkaline solution containing a non-ionic detergent, the haemoglobin is converted to alkaline haematin D-575, which is a stable coloured compound. The absorbance of the alkaline haematin D-575 is measured using a haemoglobinometer or colorimeter. The spectrophotometer and haemoglobinometer directly determine the haemoglobin (Hb) concentration of the blood sample, whereas with a colorimeter, the haemoglobin concentration of the blood sample is obtained from the absorbance using a prepared calibration curve or table of values.

The alkaline haematin D (AHD) method offers several advantages over the haemoglobin cyanide method:

- It is as accurate, but less expensive.
- The calibration procedure uses chlorhaemin, a stable crystalline compound that is commercially available.
- The AHD reagent does not include potassium cyanide, which is highly toxic, in contrast to Drabkin diluting fluid for the haemoglobin cyanide method.
- The AHD reagent can be prepared using chemicals that are generally available locally.

#### Materials and reagents

- Spectrophotometer, haemoglobinometer or colorimeter
- Test-tubes
- Test-tube racks
- Corks or rubber stoppers
- Cuvettes
- Grease pencil
- Cotton wool or gauze
- AHD standard (supplied by the central laboratory)
- AHD reagent (reagent no. 8).

#### *Calibration of the spectrophotometer or haemoglobinometer*

1. Note the concentration of the AHD standard indicated on the label, e.g. 160 g/l at a 1:150 dilution.
2. Pipette 20 µl of AHD standard into a clean test-tube containing 3 ml of AHD reagent.
3. Stopper the test-tube using a clean cork or rubber stopper and mix by inversion. Leave the tube to stand for 2–3 minutes.
4. Fill a clean cuvette with the undiluted AHD reagent. Dry the outside of the cuvette with cotton wool or gauze and place it in the cuvette chamber. Adjust the spectrophotometer or haemoglobinometer to read zero (blank).
5. Replace the undiluted AHD reagent in the cuvette with the diluted AHD standard solution; repeat the measurement procedure and adjust the spectrophotometer or haemoglobinometer to read the correct haemoglobin concentration indicated on the label, e.g. 160 g/l.



**Calibration of the colorimeter**

1. Switch on the colorimeter and set the wavelength to 540 nm. Allow the colorimeter to warm up for the time recommended by the manufacturer.
2. Arrange six test-tubes in a test-tube rack. Label the test-tubes 1, 2, 3, 4, B and N.
3. Pipette 5 ml of AHD reagent into the test-tube marked B.
4. Pipette 3 ml of AHD reagent and 20  $\mu$ l of AHD standard into the test-tube marked N.
5. Dilute the reference solution in test-tube N as described in Table 9.5.
6. Pipette the indicated volumes of AHD reagent and reference solution into test-tubes 1–4. Stopper each tube and mix by inversion.
7. Calculate the haemoglobin concentrations in the test-tubes as follows:  

$$\text{haemoglobin concentration} = \text{concentration of reference solution} \times \text{dilution factor}$$

*For example:*

tube N: 160 gHb/l

tube 1:  $160 \text{ gHb/l} \times 4/5 = 128 \text{ gHb/l}$

tube 2:  $160 \text{ gHb/l} \times 3/5 = 96 \text{ gHb/l}$

tube 3:  $160 \text{ gHb/l} \times 2/5 = 64 \text{ gHb/l}$

tube 4:  $160 \text{ gHb/l} \times 1/5 = 32 \text{ gHb/l}$

tube B: 0 gHb/l

8. Pour the AHD reagent from test-tube B into a clean cuvette. Dry the outside of the cuvette with cotton wool or gauze. Place the cuvette into the cuvette chamber, close the cuvette chamber and adjust the colorimeter to read zero absorbance (blank).
9. Replace the AHD reagent in the cuvette with the reference solution from test tube 4. Record the absorbance. Pour the solution back into test-tube 4.
10. Repeat the procedure using test-tubes 3, 2, 1 and N, respectively in sequence.
11. Plot a graph of the absorbance values against the haemoglobin concentration (g/l) for the standard and test samples (N and tubes 1–4, respectively) (Fig. 9.26). Starting from the origin, draw a straight line joining through as many of the points as possible.

*Note:* Always prepare a new calibration curve whenever you use a different colorimeter, type of cuvette, or method for haemoglobin measurement.

**Method****Method using a spectrophotometer or haemoglobinometer**

1. Switch on the spectrophotometer or haemoglobinometer. Allow it to warm up for the time recommended by the manufacturer (usually 10 minutes).

**Table 9.5 Preparation of serial dilutions of AHD reference solution for calibration of a colorimeter**

Test-tube	1	2	3	4
AHD reagent (ml)	1	2	3	4
AHD reference solution (ml)	4	3	2	1
Total volume (ml)	5	5	5	5

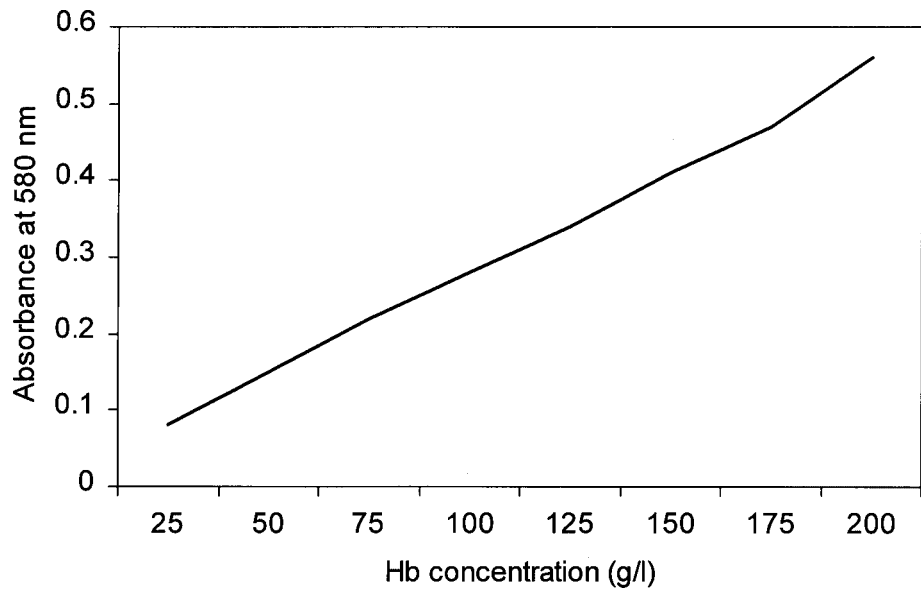

Fig. 9.26 Calibration curve for determining haemoglobin concentration

2. Arrange the test-tubes in a test-tube rack: one for each sample to be tested, one for the blank and two for the control samples.
3. Using a grease pencil, label the test-tubes with the appropriate laboratory numbers of the samples to be measured, B for the blank, and C1 and C2 for the control samples.
4. Pipette 3 ml of AHD reagent into each test-tube.
5. Pipette 20  $\mu$ l of blood collected in EDTA from a patient into the AHD reagent of the appropriate tube. Flush the pipette carefully five times with the AHD reagent.
6. Pipette 20  $\mu$ l of AHD standard into test-tubes C1 and C2.
7. Plug all the test-tubes with a clean cork or rubber stopper and mix by inversion. Leave the tubes to stand for 2–3 minutes.
8. Pour the AHD solution from test-tube B into a clean cuvette. Dry the outside of the cuvette with cotton wool or gauze. Make sure that there are no air bubbles in the solution. Place the cuvette in the cuvette chamber and adjust the spectrophotometer or haemoglobinometer to read zero.
9. Repeat the procedure with the solution in test-tubes C1 and C2, respectively. If the readings of the two controls differ by less than 2.5%, measure the haemoglobin concentration of all the test samples. Record all the results.

#### *Method using a colorimeter*

The AHD method is also applicable using a colorimeter. The measurement procedure is the same as that described for a spectrophotometer or haemoglobinometer. However, the absorbance in a colorimeter does not increase linearly with haemoglobin at elevated concentrations. Therefore, a calibration curve must be used to relate the absorbance readings to the haemoglobin concentration, as described above.

#### **Results**

Report the results in g/l. Example: “haemoglobin = 89 g/l”.

### *Errors in haemoglobin estimation*

Errors in sampling:

- inadequate flow of blood from the finger prick;
- excessive squeezing of the finger after pricking;
- prolonged use of a tourniquet when collecting venous blood, which leads to concentration of blood cells;
- insufficient mixing of venous blood, which has sedimented after collection;
- small clots in venous blood due to inadequate mixing with EDTA after collection;
- adding too little or excess blood to Drabkin diluting fluid;
- air bubbles trapped in pipettes.

Faulty or dirty equipment, such as:

- broken or chipped pipettes;
- dirty pipettes;
- dirty cuvettes;
- dirty filters;
- a defective spectrophotometer, haemoglobinometer or colorimeter.

Faulty technique:

- using a dilution factor different from the one for which the spectrophotometer, haemoglobinometer or colorimeter was calibrated;
- inadequate mixing of reagent;
- placing the cuvette in the chamber with the frosted sides facing the light path;
- air bubbles in the cuvette;
- using a standard filter from another spectrophotometer or haemoglobinometer for adjustment;
- using the wrong filter for the colorimeter.

*Note:*

If the spectrophotometer, haemoglobinometer or colorimeter requires frequent recalibration, e.g. every 2–3 days, change the bulb and repeat the procedure for internal quality control. If the problem of frequent recalibration persists, send the machine to a servicing agent.

## **9.4 Estimation of the erythrocyte volume fraction**

The total volume of erythrocytes in a given volume of blood divided by the volume of blood is called the erythrocyte volume fraction. For example, if the volume of erythrocytes in 1 litre (1000 ml) of blood is 450 ml, the erythrocyte volume fraction is  $450 \text{ ml}/1000 \text{ ml} = 0.45$  (since the fraction is millilitres divided by millilitres, the unit “ml” cancels out, and the result is a simple decimal fraction with no unit). The remainder of the blood is made up almost entirely of plasma, together with a small volume of leukocytes. If the latter are ignored, the plasma volume fraction in the above example would be  $550 \text{ ml}/1000 \text{ ml} = 0.55$  (note that  $0.45 + 0.55 = 1.0$ ; i.e. erythrocyte volume fraction plus plasma volume fraction = 1). The erythrocyte volume fraction is therefore a measure of the proportion of erythrocytes to plasma. It is of diagnostic value in patients suffering from anaemia, dehydration, shock or burns.

Before the introduction of SI units, the erythrocyte volume fraction was called either the “haematocrit” or the “packed cell volume”, and it was reported as a percentage rather than a decimal fraction. In the traditional system, the “packed cell volume” in the example given would be 45%. Note that, in using SI units, the numerical value does not change, but becomes 0.45 instead of 45%.

### 9.4.1 Micro-scale method

#### Principle

The blood (mixed with anticoagulant) is placed in a long capillary tube and centrifuged in a microhaematocrit centrifuge. The level reached by the column of erythrocytes is read with a scale reader. This method is preferable to that using a macro scale: it is quicker, and blood from the finger can be used.

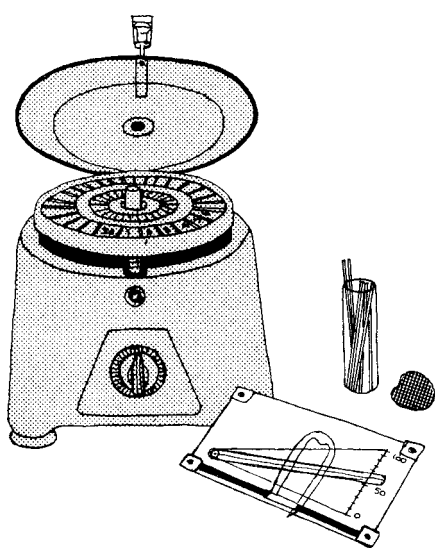

Fig. 9.27 Materials for estimating the erythrocyte volume fraction using the micro scale

#### Materials and reagents (Fig. 9.27)

- Microhaematocrit centrifuge
- Scale reader (usually provided with the centrifuge)
- Capillary tubes, 75 mm long with a 1.5-mm bore, containing dried heparin (if capillary blood is used; if venous blood mixed with EDTA dipotassium salt, 10% solution (reagent no. 22) is used, “heparinized” tubes are not required)
- Long fine capillary Pasteur pipettes (long enough to reach the bottom of the tubes) with rubber teat
- Filter-paper
- Soft wax or plastic modelling clay (or a Bunsen burner or spirit lamp)
- Sterile blood lancet
- 70% Ethanol.

If no scale reader is available, you can make one yourself using graph paper, 15–20 cm wide, ruled in millimetres. On the left-hand vertical edge, starting at the bottom, make a series of 10 marks at intervals of 4 mm. On the right-hand vertical edge, in the same manner, make 10 marks at intervals of 6 mm. Using a ruler, draw 10 sloping lines connecting each mark on the left margin to the corresponding mark on the right margin. In the left margin, opposite the bottom horizontal line of the graph paper, write “0”. Continue up the left margin, marking each sloping line you have drawn as follows: 0.1, 0.2, 0.3, etc.; the top sloping line will be marked 1.0. In the right margin, write the same numbers opposite the other ends of the sloping lines. Now, again using a ruler, draw a second series of sloping lines, but make them much lighter than the first set of lines. Each light line should be drawn exactly in the middle of the space between each pair of heavy lines. Finally, following the printed lines of the graph paper, draw a series of heavy vertical lines at intervals of about 3 cm. Your scale should look like the one in Fig. 9.28. Instead of making your own scale, you could use the one printed here for reading erythrocyte volume fractions. (Cover it with a sheet of plastic.)

#### Method

##### Collection of specimens

Capillary blood specimens

1. Using a blood lancet, draw blood by pricking either:

- the third or fourth finger (Fig. 9.29)
- the lobe of the ear
- the heel (infants)

after sterilizing the chosen area with ethanol.

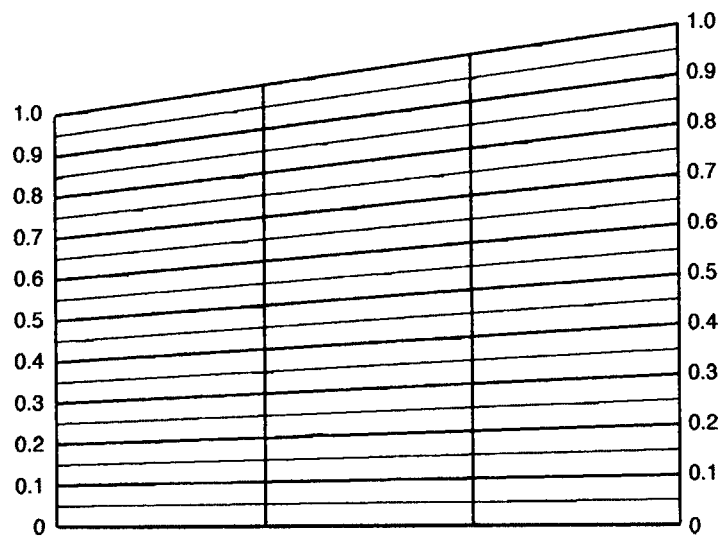

who 01216

Fig. 9.28 Micro scale for estimating the erythrocyte volume fraction

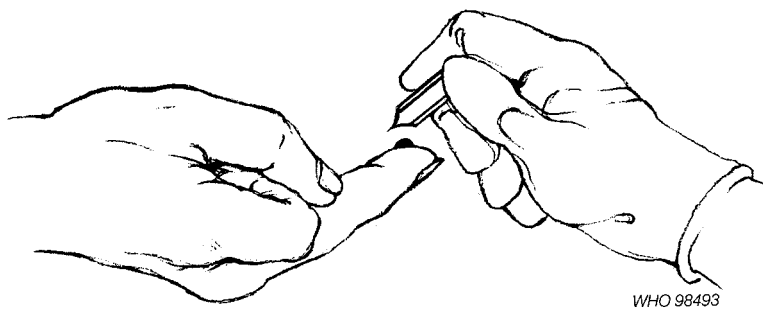

WHO 98493

Fig. 9.29 Taking a capillary blood sample

The blood should flow freely or with very little pressure to the area. Wipe away the first drop with filter-paper.

2. Apply the tip (circled with red) of a capillary tube containing dried heparin to the drop of blood (Fig. 9.30). The blood flows into the tube by capillarity. Fill about three-quarters of the tube.
3. Plug the other end of the tube (i.e. the end that has not come into contact with the blood) with soft wax or plastic modelling clay (Fig. 9.31). Check that it is completely plugged to a depth of about 2 mm.

Alternatively, seal the end of the tube by heating it carefully over a Bunsen burner or spirit lamp (Fig. 9.32).

Leave it to cool in a horizontal position.

It is useful to have ready a numbered stand containing plastic modelling clay, so that each patient's tube can be stuck upright next to the corresponding number.

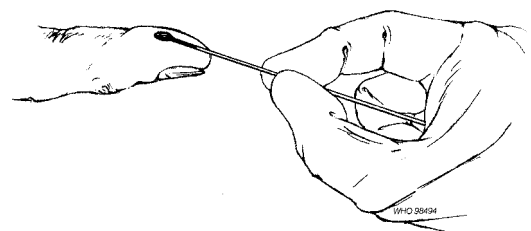

Fig. 9.30 Technique for drawing blood into a capillary tube

#### Venous blood specimens

1. Collect a venous blood specimen as described in section 9.2 and add it to a test-tube containing EDTA dipotassium salt solution.

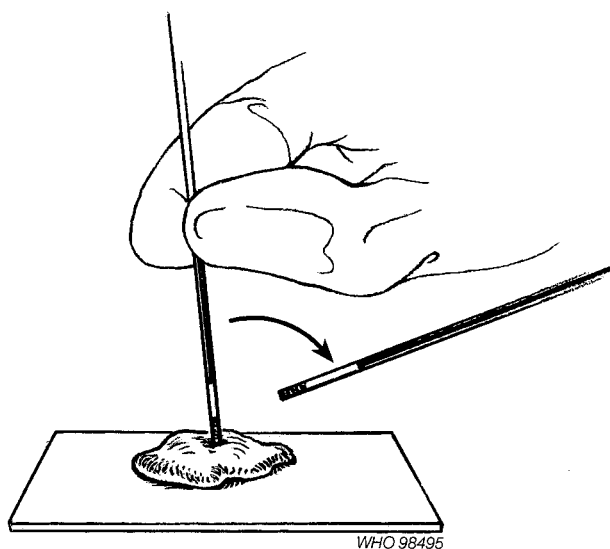

Fig. 9.31 Sealing the capillary tube with wax

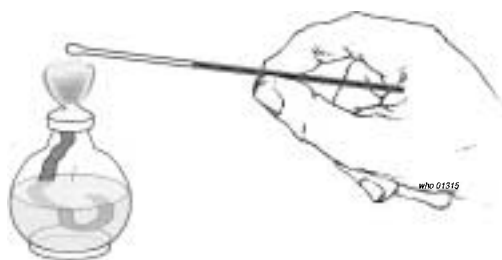

Fig. 9.32 Sealing the capillary tube by flaming

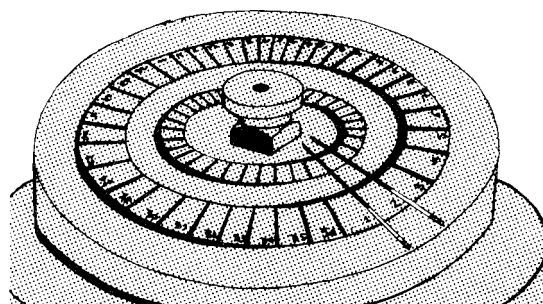

Fig. 9.33 Placing the capillary tubes in a centrifuge

2. Using a capillary pipette, fill about three-quarters of a capillary tube with blood.
3. Seal the tube as described in step 3 above.

#### *Measurement technique*

1. Place the capillary tubes in the numbered slots in the centrifuge head, making sure that the number on the slot corresponds to the specimen number. The sealed end of the tube should point *outwards*, away from the centre (Fig. 9.33).
2. Centrifuge at 3000g (for the period of time recommended by the manufacturer of the centrifuge — usually 10 minutes).

After centrifugation, the tubes will show three layers (Fig. 9.34):

- at the top, a column of plasma;
- in the middle, a very thin layer of leukocytes;
- at the bottom, a column of erythrocytes.

The erythrocyte volume fraction reading is made exactly at the top of the column of erythrocytes.

3. Hold the tube against the scale so that the bottom of the column of erythrocytes (*not* the bottom of the tube) is aligned with the horizontal zero line (see Fig. 9.35).
4. Move the tube across the scale until the line marked 1.0 passes through the top of the plasma column. Check to make sure that the bottom of the column of

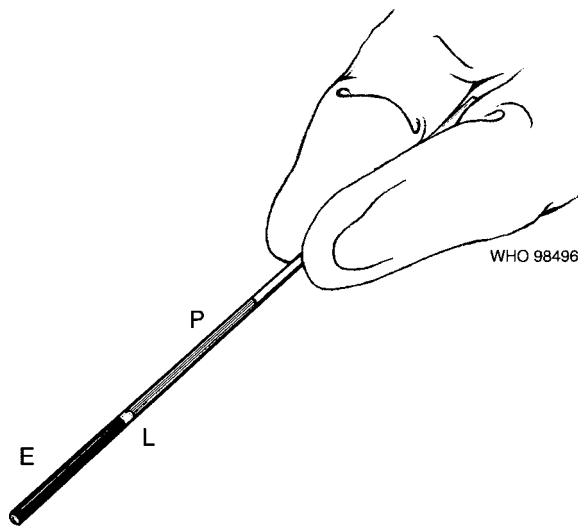

Fig. 9.34 Centrifuged capillary blood sample  
E: erythrocytes; L: leukocytes; P: plasma.

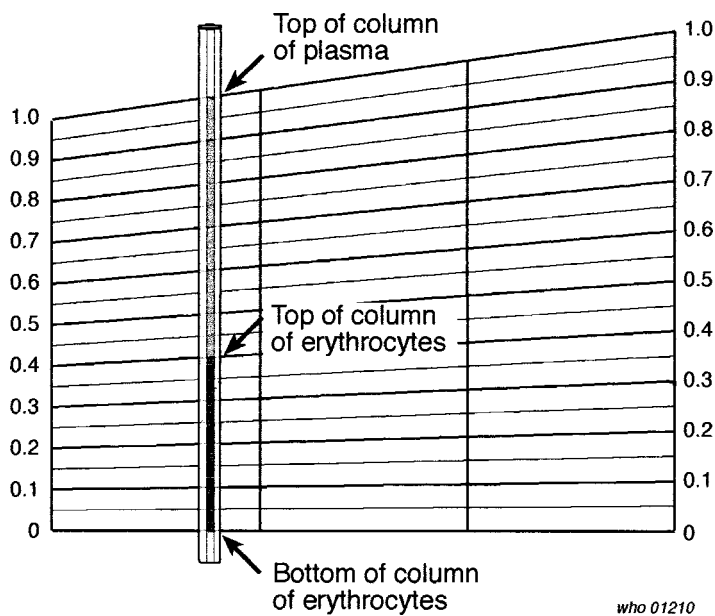

Fig. 9.35 Measuring the erythrocyte volume fraction using the micro scale

erythrocytes is still on the zero line; also check (by means of the heavy vertical lines) that the tube is vertical.

- The line that passes through the top of the column of erythrocytes gives the erythrocyte volume fraction (0.4 in Fig. 9.35). The light intermediate lines represent intervals of 0.05; if the top of the column of erythrocytes is not on a line, but between a heavy line and a light line, its position can be estimated to the nearest 0.01.

*Note:* If your laboratory has not yet changed to SI units and is still using the traditional system, the same chart can be used. Simply read the numbers as percentages instead of fractions. For example, instead of “erythrocyte volume fraction, 0.4” report the result as “packed cell volume, 40%”.

**Table 9.6 Normal erythrocyte volume fractions and packed cell volumes, by age group**

Age group	Erythrocyte volume fraction	Packed cell volume (%)
Newborn infants	0.50–0.58	50–58
Infants (3 months)	0.35–0.40	35–40
Children (5 years)	0.38–0.44	38–44
Women	0.37–0.43	37–43
Men	0.40–0.50	40–50

**Results****Reference range**

Table 9.6 shows the reference ranges for different age groups.

**Low values**

Low values are found in patients suffering from anaemia. In men with anaemia the erythrocyte volume fraction is lower than 0.4 and in women it is lower than 0.37 (packed cell volumes of 40% and 37%, respectively).

**High values**

High values are found in cases of loss of plasma, severe burns, dehydration (as in diarrhoeal diseases) and also (rarely) in polycythaemia.

**Relationship between the erythrocyte number concentration and the erythrocyte volume fraction**

Normally, there is a linear relationship between the erythrocyte number concentration and the erythrocyte volume fraction. If the erythrocyte number concentration is  $C \times 10^{12}$  per litre, the erythrocyte volume fraction will normally be in the range  $(C - 0.2)/10$  to  $(C - 0.4)/10$ .

**Example:**

If the erythrocyte number concentration is  $5 \times 10^{12}/l$ , the erythrocyte volume fraction will normally be in the range  $(5 - 0.2)/10$  to  $(5 - 0.4)/10$ ; i.e., 0.48 to 0.46.

In traditional units, the relationship is similar, but the formula for the calculation is slightly different: if  $C$  is the erythrocyte count, the packed cell volume (haematocrit), as a percentage, will normally be in the range  $(C \times 10) - 2$  to  $(C \times 10) - 4$ .

**Relationship between the erythrocyte volume fraction and the haemoglobin concentration**

Normally, there is a linear relationship between the erythrocyte volume fraction and the haemoglobin concentration. The erythrocyte volume fraction is about 0.003 times the haemoglobin concentration when the latter is expressed in grams per litre. If the haemoglobin concentration is expressed in terms of millimoles of haemoglobin(Fe) per litre, the erythrocyte volume fraction is *roughly* 0.05 times the figure for grams per litre.

**Example:**

A person with a haemoglobin concentration of 130 g/l will normally have an erythrocyte volume fraction of  $130 \times 0.003 = 0.39$ . In terms of haemoglobin(Fe), the



concentration is about 8.0 mmol/l, and the erythrocyte volume fraction will be about  $8.0 \times 0.05 = 0.4$ .

***Additional information provided by the erythrocyte volume fraction test***

Examine the layer of leukocytes just above the column of erythrocytes (see Fig. 9.34). It is normally very thin; if it seems thick, determine the leukocyte number concentration (see section 9.6). The layer will seem abnormally thick if the leukocyte number concentration is greater than  $20 \times 10^9/l$ . In cases of leukaemia, when the leukocyte number concentration may be  $100\text{--}200 \times 10^9/l$ , the layer may be several millimetres thick.

**Mean erythrocyte haemoglobin concentration**

The mean erythrocyte haemoglobin concentration is a measure of the *average* haemoglobin content of the erythrocytes. It is expressed either in grams of haemoglobin per litre or in millimoles of haemoglobin(Fe) per litre<sup>1</sup> and is calculated by dividing the haemoglobin concentration of the blood by the erythrocyte volume fraction.

*Example:*

- If the haemoglobin concentration is expressed in grams of haemoglobin per litre:

haemoglobin concentration = 150 g/l

erythrocyte volume fraction = 0.43

mean erythrocyte haemoglobin concentration =  $150/0.43 = 349 \text{ g/l}$  (or 34.9%).

- If the haemoglobin concentration is expressed in millimoles of haemoglobin(Fe) per litre:

haemoglobin(Fe) = 9.3 mmol/l

erythrocyte volume fraction = 0.43

mean erythrocyte haemoglobin concentration =  $9.3/0.43 = 21.6 \text{ mmol/l}$ .

*Note:* to convert values in g/l to values in mmol/l, multiply by 0.062 06. Thus, using the above example,  $349 \text{ g/l} \times 0.062 \text{ 06} = 21.6 \text{ mmol/l}$ .

**Reference values**

Normally the mean erythrocyte haemoglobin concentration lies between the following limits:

- lower limit: haemoglobin 322 g/l or haemoglobin(Fe) 20 mmol/l;
- upper limit: haemoglobin 371 g/l or haemoglobin(Fe) 23 mmol/l.

When the value falls within this range, the erythrocytes are said to be “normochromic” (i.e. of normal colour).

Values below the lower limit of the reference range indicate that the erythrocytes are “hypochromic” (i.e. less coloured than normal). Low values are found in patients with hypochromic anaemia.

If the value is higher than the upper limit of the reference range, the mean erythrocyte haemoglobin concentration should be determined again. Haemoglobin forms about 95% of the erythrocyte mass. Therefore, erythrocytes are never “hyperchromic” (i.e. more coloured than normal), but they may increase in volume and thus be capable of containing more haemoglobin than normal; in this case the mean

<sup>1</sup> See note about expression of haemoglobin concentration on page 284.

erythrocyte haemoglobin concentration may be as high as 380 g/l (haemoglobin(Fe) 23.6 mmol/l), but it never exceeds these values.

The mean erythrocyte haemoglobin concentration is usually called the “mean corpuscular haemoglobin concentration” (MCHC). It can also be expressed as a percentage. This is calculated by dividing the haemoglobin concentration of the blood in grams per 100 ml by the packed cell volume as a percentage and multiplying by 100.

*Example:*

haemoglobin concentration = 15.0 g/100 ml

packed cell volume = 43%

MCHC =  $(15.0/43) \times 100 = 35\%$ .

In this system, the reference range is 32–37%. The MCHC never exceeds 38%. If such a result is obtained, the test should be repeated.

#### 9.4.2 Macro-scale method

##### Principle

The blood (mixed with anticoagulant) is placed in a graduated tube and centrifuged to pack the erythrocytes. The level of the column of erythrocytes is then read directly in the graduated tube (Fig. 9.36).

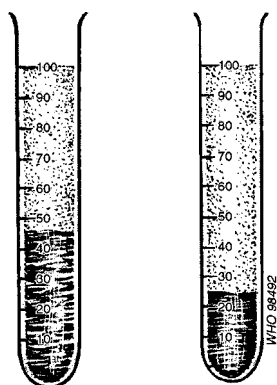

Fig. 9.36 Principle of the macro scale for estimating the erythrocyte volume fraction

##### Materials and reagents (Fig. 9.37)

- Centrifuge
- Special graduated tubes (Wintrobe tubes), 9.5 cm long with a 0.6-cm bore, calibrated from 0 to 100
- Long fine capillary Pasteur pipette (long enough to reach the bottom of the tube) with rubber teat
- Anticoagulant — EDTA dipotassium salt, 10% solution (reagent no. 22) or Wintrobe solution (reagent no. 65).

##### Method

###### Collection of specimens

1. Collect a venous blood specimen as described in section 9.2 and add it to a graduated tube containing anticoagulant (see above).
2. Using the capillary pipette, fill the graduated tube with blood up to the 100 mark, making sure that no air bubbles form (Fig. 9.38).

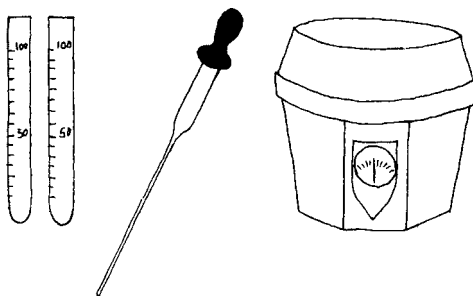

Fig. 9.37 Materials for estimating the erythrocyte volume fraction using the macro scale



Fig. 9.38 Using a capillary pipette to fill a graduated tube with blood

**Measurement technique**

1. Place the graduated tubes in the centrifuge and centrifuge for 30 minutes at 2300g. If the rotor arm of the centrifuge (measured from the axis of rotation to the base of the bucket holding the tube) is 15 cm long, 3600rpm will be needed to attain this force; with a 20-cm arm 3100rpm will be needed.

*Important:* a force of less than about 2300g will give a false result.

2. Read the level at which the erythrocytes meet the layer of leukocytes (Fig. 9.39). Make sure that the correct set of graduations is being used, upwards towards the 100 mark. The figure obtained is a percentage (the “packed cell volume”); divide by 100 to obtain the erythrocyte volume fraction.

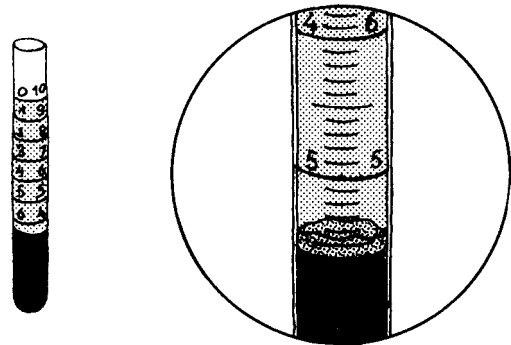

Fig. 9.39 Measuring the packed cell volume

**Results**

See page 282.

**9.5 Estimation of the erythrocyte number concentration**

The number of erythrocytes contained in 1 litre of blood is called the erythrocyte number concentration. (In traditional units, it is expressed as the number of erythrocytes per cubic millimetre and is called the erythrocyte or red cell “count”.) Accurate methods for counting erythrocytes require an electronic counter system. Unfortunately, such instruments are often not available in peripheral laboratories. A simple but far less accurate method uses a counting chamber in which erythrocytes are counted under the microscope. However, this method is of such low precision that it should not be used. It is recommended instead that the erythrocyte volume fraction (see section 9.4) or the haemoglobin concentration (see section 9.3) is measured and the erythrocyte number concentration calculated.

**Reference range**

Table 9.7 shows the reference ranges for different age groups.

**High values**

Patients who are dehydrated or have polycythaemia will have high erythrocyte number concentrations.

**Low values**

Patients with anaemia caused by insufficient production, loss or haemolysis of erythrocytes will have low erythrocyte number concentrations.

*Note:* Anaemia is a clinical syndrome that has many different underlying causes. The clinical picture is determined by the extent and duration of anaemia. The

**Table 9.7 Normal erythrocyte number concentrations, by age group**

Age group	Erythrocyte number concentration	
	SI units (per litre)	Traditional units (per mm <sup>3</sup> )
Newborn infants	5.0–7.0 × 10 <sup>12</sup>	5.0–7.0 × 10 <sup>6</sup>
Infants (1–6 months)	3.8–5.9 × 10 <sup>12</sup>	3.8–5.9 × 10 <sup>6</sup>
Children (4 years)	3.8–5.4 × 10 <sup>12</sup>	3.8–5.4 × 10 <sup>6</sup>
Women	4.0–5.4 × 10 <sup>12</sup>	4.0–5.4 × 10 <sup>6</sup>
Men	4.5–6.2 × 10 <sup>12</sup>	4.5–6.2 × 10 <sup>6</sup>

symptoms range from pallor and mild fatigue to headache, dizziness and irritability to uncontrolled behaviour and even shock and cardiac insufficiency.

Anaemia may result from:

- blood loss
- decreased production of erythrocytes
- increased destruction of erythrocytes.

The most common cause of anaemia worldwide is iron deficiency. Other common causes such as infection, malaria, malnutrition and vitamin deficiencies usually contribute to anaemia in association with iron deficiency. Other causes of anaemia are:

- trauma
- parasitic infections
- diseases of the endocrine system
- chronic diseases
- inborn errors of metabolism
- intoxication.

## 9.6 Estimation of the leukocyte number concentration

The number of leukocytes contained in 1 litre of blood is called the leukocyte number concentration or leukocyte count.

In certain diseases the number of leukocytes in the blood is altered. For example, in infectious mononucleosis and bacterial infections there is a marked increase, whereas in typhoid fever there is a marked decrease.

### 9.6.1 Principle

The blood is diluted in a leukocyte diluting fluid which haemolyses the erythrocytes, but leaves the leukocytes intact.

The leukocytes are then counted in a counting chamber under the microscope, and the number of cells per litre of blood is calculated.

### 9.6.2 Materials and reagents

- Microscope
- Ruled counting chamber — preferably the improved Neubauer chamber (Fig. 9.40; the Bürker chamber is rarely used)
- Blood (Sahli) pipette, graduated to the 50- $\mu$ l (0.05-ml) mark

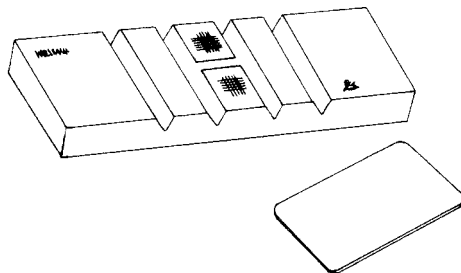

Fig. 9.40 Neubauer counting chamber

- Graduated pipette, 1 ml
- Pasteur pipette or capillary tube
- Hand tally counter or bead counter
- Diluting fluid (prepared by adding 2 ml of glacial acetic acid to 1 ml of gentian violet, 1% aqueous solution, and making up the volume to 100 ml with distilled water).

The dimensions of the Neubauer ruled chamber are as follows:

- area = 9 mm<sup>2</sup>;
- depth = 0.1 mm.

### 9.6.3 Method

1. Pipette 0.95 ml of diluting fluid into a small bottle using the 1-ml graduated pipette.
2. Draw venous or capillary blood to the 0.05-ml mark of the blood (Sahli) pipette. *Do not* allow air bubbles to enter. With venous blood ensure that it is well mixed by inverting the bottle containing it and the anticoagulant repeatedly for about 1 minute immediately before pipetting it.
3. Wipe the outside of the pipette with absorbent paper, check that the blood is still on the 0.05-ml mark (Fig. 9.41), and expel it into the bottle of diluting fluid. Rinse the pipette by drawing in and discharging fluid from the bottle three times. The dilution of the blood is 1 in 20. Label the bottle with the patient's name and/or number.
4. Attach the coverslip (supplied with the chamber) to the counting chamber, pressing it carefully into place.  
When the coverslip is properly attached, coloured bands called Newton's rings appear between the two glass surfaces.
5. Mix the diluted blood well. Use a Pasteur pipette or a capillary tube to fill the counting chamber (Fig. 9.42). Take care not to overfill beyond the ruled area.

Fig. 9.41 Checking that the blood is still on the mark

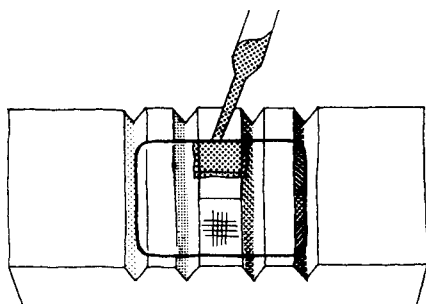

Fig. 9.42 Filling the counting chamber

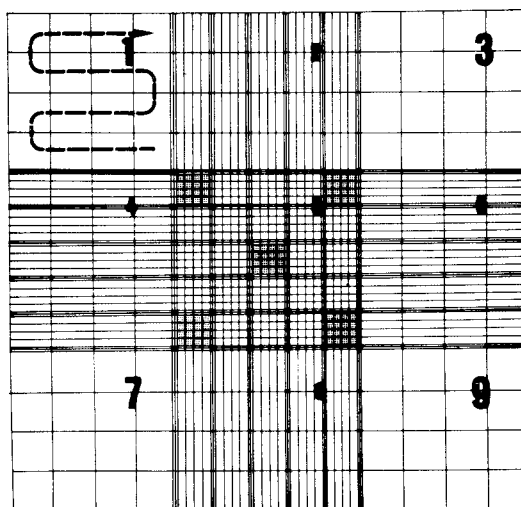

Fig. 9.43 Using the improved Neubauer ruled chamber

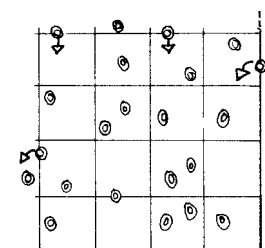

Fig. 9.44 Counting leukocytes using the improved Neubauer ruled chamber

*Important:* If the liquid overflows into the channel between the two chambers, you must start again: remove and clean the coverslip; clean the counting chamber; and refill with another drop.

6. Leave the counting chamber on the bench for 3 minutes to allow the cells to settle.
7. Place the chamber on the stage of the microscope. Use the  $\times 10$  objective and the  $\times 10$  eyepiece. Reduce the amount of light entering the condenser by adjusting the iris diaphragm. Focus the rulings of the chamber and the leukocytes. Do not mistake pieces of dust for leukocytes.
8. Count the leukocytes in an area of  $4 \text{ mm}^3$  of the chamber, using the corner squares numbered 1, 3, 7 and 9 as shown in Fig. 9.43. Include in the count the leukocytes seen on the lines of two sides of each square counted, as shown in Fig. 9.44. This square represents one of the four counted.
9. Calculate the number of leukocytes in 1 litre of blood by multiplying the number of leukocytes counted in the four squares by 0.05. Report the result as "number by  $10^9/l$ ".

*Example:*

number of leukocytes counted = 188

number of leukocytes per litre =  $(188 \times 0.05) \times 10^9$

Result reported:  $9.4 \times 10^9/l$

### Explanation of calculation

Each of the four squares in which leukocytes are counted has an area of  $1 \text{ mm}^2$ ; the total area is therefore  $4 \text{ mm}^2$ . The chamber depth is  $0.1 \text{ mm}$ , therefore the volume in which leukocytes are counted is  $4 \times 0.1 = 0.4 \text{ mm}^3$ . Thus division by four and multiplication by 10 will give the number of leukocytes in  $1 \text{ mm}^3$  of diluted blood. Since the dilution is 1 in 20, multiplication by 20 will give the number of leukocytes in  $1 \text{ mm}^3$  of undiluted blood. Finally, there are 1 million ( $10^6$ ) cubic millimetres in

1 litre, so multiplication by  $10^6$  will give the number of leukocytes per litre of undiluted blood. This can be summarized as follows:

$$\begin{aligned} \text{number of leukocytes per litre} &= \frac{\text{leukocytes counted} \times 10 \times 20}{4} \times 10^6 \\ &= \text{leukocytes counted} \times 50 \times 10^6 \\ &= \text{leukocytes counted} \times 0.05 \times 10^9 \end{aligned}$$

*Example:*

A total of 188 leukocytes are counted in the four squares. The number of leukocytes per cubic millimetre of undiluted blood is therefore:

$$\frac{188 \times 10 \times 20}{4} (= 188 \times 50 = 9400)$$

and the number per litre is:

$$9400 \times 10^6 = 9.4 \times 10^9$$

#### 9.6.4 Results

##### Reference range

The reference ranges for different age groups are given in Table 9.8.

##### High values

An increase in the total number of circulating leukocytes is called leukocytosis. This can occur with certain bacterial infections. In leukaemia, leukocyte number concentrations of  $50 \times 10^9/l$  to  $400 \times 10^9/l$ , or even higher values, can be found. In this case it is necessary, when determining the number concentration, to use a greater dilution of blood — for example 0.05 ml of blood and 1.95 ml of diluting fluid, which gives a dilution of 1 in 40. If this dilution is used, the number of cells counted is multiplied by 0.1 instead of by 0.05 in order to give the number  $\times 10^9$  per litre. (If traditional units are being used, multiply by 100 instead of 50 to give the number per cubic millimetre.)

##### Low values

A decrease in the total number of circulating leukocytes is called leukopenia. This can occur with certain infections including typhoid fever and malaria. Leukopenia is also seen following treatment with certain drugs. When the leukocyte number concentration is very low, it is necessary to dilute the blood less — for example 0.05 ml of blood and 0.45 ml of diluting fluid, which gives a dilution of 1 in 10. If this dilution is used, the number of cells counted is multiplied by 0.25 instead of by 0.05 to give the number  $\times 10^9$  per litre.

**Table 9.8 Normal leukocyte number concentrations, by age group**

Age group	Leukocyte number concentration (per litre) <sup>a</sup>
Newborn infants	$10\text{--}20 \times 10^9$
Infants (3–9 months)	$4\text{--}15 \times 10^9$
Children (3 years)	$4\text{--}11 \times 10^9$
Children (10 years)	$4\text{--}10 \times 10^9$
Adults	$4\text{--}10 \times 10^9$

<sup>a</sup>The reference range may be different in certain indigenous populations.

### Correction for nucleated erythrocytes

Nucleated erythrocytes or normoblasts (see Fig. 9.90) are early stages of erythrocytes. They are not normally present in the blood, but they may be present in the blood in certain diseases such as sickle cell anaemia or other haemolytic anaemias. Normoblasts are not haemolysed in the diluting fluid and are therefore counted with the leukocytes. When normoblasts are present in large numbers and the leukocytes are counted using a fully or semi-automated cell counter, the leukocyte number concentration must be corrected as follows.

Examine a thin Romanowsky-stained blood film (see section 9.10) and count the number of normoblasts seen for every 100 leukocytes.

*Calculation:*

The number concentration of normoblasts (per litre) is:

$$\frac{\text{number of normoblasts counted}}{100 + \text{number of normoblasts counted}} \times \text{leukocyte number concentration}$$

*Example:*

If 50 normoblasts are counted and the leukocyte number concentration is  $16 \times 10^9/l$ , the number concentration of normoblasts is:

$$\frac{50}{100 + 50} \times 16 = 5.3 \times 10^9/l$$

and the corrected leukocyte number concentration is:

$$(16 - 5.3) \times 10^9/l = 10.7 \times 10^9/l.$$

## 9.7 Measurement of the erythrocyte sedimentation rate

### 9.7.1 Principle

Blood collected into an anticoagulant is placed in a long graduated tube held in a vertical position. The erythrocytes settle to the bottom, leaving a layer of plasma above.

The height of the column of plasma after 1 hour indicates the sedimentation rate of the erythrocytes (erythrocyte sedimentation rate (ESR)).

### 9.7.2 Materials and reagents (Fig. 9.45)

- Westergren ESR tube: internal diameter 2.5 mm; graduated from 0 to 200 mm (often marked 1 to 20: 1 corresponds to 10 mm, 2 to 20 mm, etc.)
- Westergren stand
- Test-tubes
- Graduated syringe, 5 ml
- Graduated pipette, 5 ml
- Timer
- Anticoagulant: trisodium citrate, 3.2% solution (reagent no. 60) (keep in refrigerator) or EDTA dipotassium salt, 10% solution (reagent no. 22).

### 9.7.3 Method

1. Pipette 0.4 ml of trisodium citrate solution into a test-tube or bottle.
2. Collect a venous blood specimen (see section 9.2). Apply the tourniquet as loosely as possible; puncture the vein at once and release the tourniquet.  
Collect 2 ml of blood into a syringe.





Fig. 9.45 Materials for measuring the erythrocyte sedimentation rate

Fig. 9.46 Adding a blood sample to the trisodium citrate solution

3. Remove the needle from the syringe and add 1.6 ml of blood to the test-tube containing anticoagulant (marked to contain a total of 2.0 ml) (Fig. 9.46). Shake gently. Measurement of the ESR should begin within 2 hours of collection of the blood.
4. Draw the citrated blood into the Westergren tube (using a rubber safety bulb) up to the 0-mm mark (Fig. 9.47).
5. Place the tube in the Westergren stand, making sure that the tube is completely upright (Fig. 9.48).  
Check that there are no air bubbles in the tube.  
Check that the stand is level.
6. Leave on a bench away from vibration (e.g. not on the same bench as a centrifuge), free from draughts, not close to a central heating radiator and not in direct sunlight.
7. Wait 1 hour (set the timer to ring), then note the height of the column of plasma in mm graduations starting from the 0-mm mark at the top of the tube (Fig. 9.49).

#### 9.7.4 Results

The result is expressed in millimetres per hour (mm/h).

#### Reference range

Table 9.9 shows the reference ranges for adults.

*Note:* If a patient is dehydrated measurement of the ESR has little value.

#### High values

Any disease that produces plasma protein changes will increase the ESR. These include acute and chronic infections, myocardial infarctions and rheumatoid arthritis.

The ESR is also increased in patients suffering from anaemia (see page 285).

**Table 9.9 Erythrocyte sedimentation rates (ESR),<sup>a</sup> by age group**

Age group	ESR (mm/hour)
Adults (< 50 years)	
Men	< 15
Women	< 20
Adults (> 50 years)	
Men	≥ 20
Women	≥ 30

<sup>a</sup>At an ambient temperature of 25 °C.

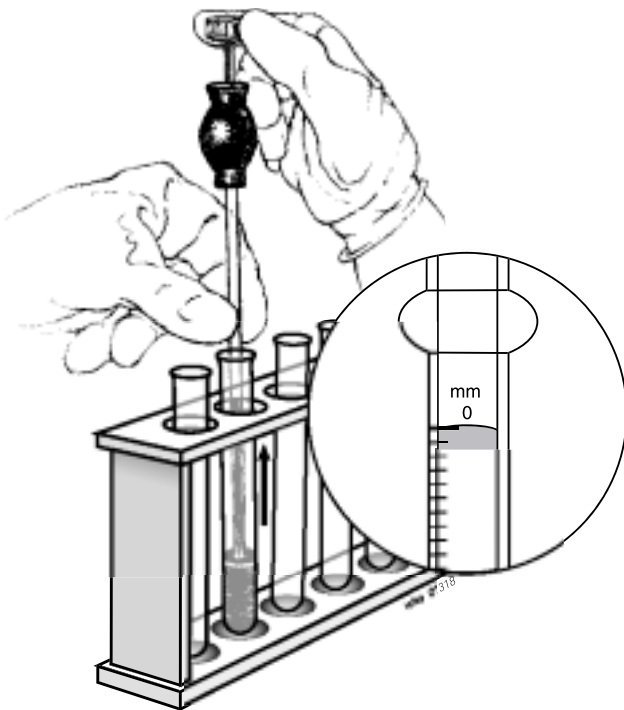

Fig. 9.47 Drawing citrated blood up to the 0-mm mark of the Westergren tube

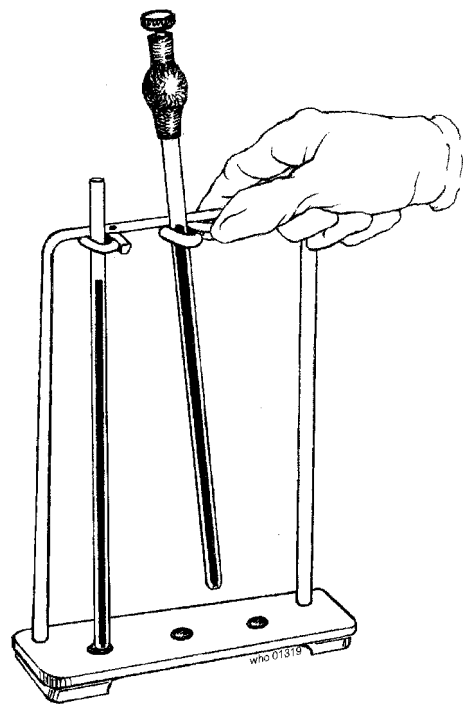

Fig. 9.48 Placing the Westergren tube in the stand

Fig. 9.49 Measuring the height of the plasma column

Very high ESR values occur in tuberculosis, trypanosomiasis and malignant diseases. The ESR is also raised in pregnancy.

## 9.8 Measurement of the bleeding time: Duke method

### 9.8.1 Principle

A small cut is made with a lancet in the lobe of the ear. Blood flows from the puncture and the time it takes for the bleeding to stop is measured.

The test is performed:

- for the diagnosis of certain haemorrhagic disorders;
- before surgical operations;
- before puncture of the liver or spleen.

### 9.8.2 Materials and reagents

- Sterile blood lancets
- Microscope slides
- Filter-paper (or blotting paper)
- Stopwatch, if available, otherwise a watch with a second hand
- Ether.

### 9.8.3 Method

1. Gently clean the lobe of the ear with cotton wool and ether (Fig. 9.50). Do not rub. Allow to dry.
2. Puncture the ear lobe (Fig. 9.51). The blood should flow freely, without any need to squeeze the ear lobe. Start the stopwatch.
3. After 30 seconds collect the first drop of blood on a corner of the filter-paper (or blotting paper) (Fig. 9.52). Do not touch the skin with the paper.
4. Wait 30 seconds more. Collect the second drop of blood in the same way, a little further along the strip of paper (Fig. 9.53).



Fig. 9.50 Cleaning the ear lobe with ether

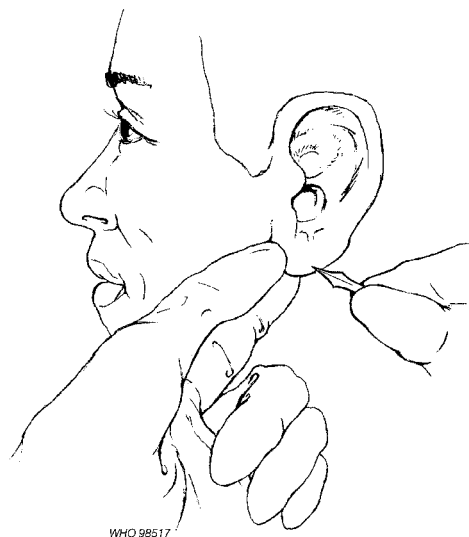

Fig. 9.51 Puncturing the ear lobe

5. Continue to collect one more drop of blood every 30 seconds. The drops become progressively smaller (Fig. 9.54).
6. When no more blood appears, stop the stopwatch (or note the time on the watch).  
Another method is to count the number of drops on the filter-paper (or blotting paper) and multiply by 30 seconds (Fig. 9.55).  
For example: there are seven drops. The bleeding time is  $7 \times 30$  seconds = 3.5 minutes.

#### 9.8.4 Results

Report the bleeding time to the nearest half minute.

Mention also the reference range for the method used. Example: bleeding time 3.5 minutes (normal range, Duke method: 1–5 minutes).

If the bleeding time is prolonged, examine a Romanowsky-stained thin blood film (see section 9.10) to see whether the number of thrombocytes appears to be less than normal (venous blood must be used).



Fig. 9.52 After 30 seconds, collect the first drop of blood



Fig. 9.53 After 1 minute, collect the second drop of blood



Fig. 9.54 Continue to collect one more drop of blood every 30 seconds

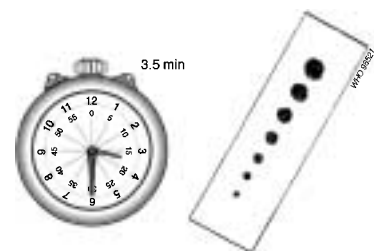

Fig. 9.55 Calculating the bleeding time

## 9.9 Observation of clot retraction and measurement of lysis time

### 9.9.1 Principle

The tubes with clotted blood are used:

- for observation of the retraction of the clot
- for measurement of the time it takes for the clot to dissolve (lysis).

These tests are carried out for the diagnosis of certain haemorrhagic disorders.

### 9.9.2 Materials

- Glass test-tubes, 75 mm × 10 mm, marked to hold 1 ml
- Timer
- Metal test-tube rack
- Water-bath
- Materials to carry out venepuncture (see section 9.2.2).

### 9.9.3 Method

#### Collection of specimens

Collect a venous blood specimen from patients as described in section 9.2. Do not add anticoagulant to the tubes in which you collect the blood.

#### Observation of clot retraction

1. Place the tube in the water-bath at 23°C (or leave it to stand at room temperature).
2. Examine the clot after 1, 2, 3 and 4 hours. The clot normally remains solid during the first 4 hours, although it begins to retract, usually in the first hour. After 4 hours the clot will have completely retracted, the red cell mass separating from the yellow serum (Fig. 9.56).

#### Measurement of lysis time

1. Place the tube containing the blood in the water-bath at 37°C (or leave it to stand at room temperature).
2. Examine the clot after 12, 24, 48 and 72 hours until lysis occurs; that is, until the clot dissolves completely and all the erythrocytes sink to the bottom of the tube (Fig. 9.57).



Fig. 9.56 After 4 hours, examine the clot

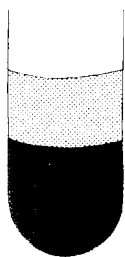

Fig. 9.57 Lysis

#### 9.9.4 Results

##### Normal clot retraction

The red clot is well separated and, at the surface, is attached to the sides of the tube (Fig. 9.58). There may be a small deposit of erythrocytes in the bottom of the tube; it should not be more than 5 mm thick.

##### Abnormal clot retraction

###### *Blood deficient in fibrinogen*

If blood is deficient in fibrinogen there is a small red clot at the bottom of the tube, not necessarily attached to the sides of the tube. It is surrounded by sedimented erythrocytes and covered by supernatant (Fig. 9.59).

###### *Blood deficient in thrombocytes*

If blood is deficient in thrombocytes there is a red clot that remains almost completely attached to the sides of the tube and that will have retracted very little, if at all (Fig. 9.60). Hardly any serum will have exuded.

(Examine a Romanowsky-stained thin blood film, using venous blood, see section 9.10.)

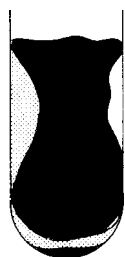

Fig. 9.58 Normal clot retraction

###### *Abnormal plasma proteins*

Abnormal plasma proteins cause coagulation of plasma. This appears as a yellow clot — clotted plasma. Beneath it is a poorly retracted red clot (Fig. 9.61).

###### *Haemophilia*

If there is no clot at all or a yellow clot that forms very slowly over the deposit of erythrocytes (Fig. 9.62), the cause is a serious clotting factor deficiency such as that which occurs in haemophilia.

Haemophilia is a hereditary haemorrhagic disease affecting males.



Fig. 9.59 Blood deficient in fibrinogen

Report the clot retraction as:

- “normal”
- “abnormal”, with a description of the clot.

##### Lysis time

A clot normally takes at least 48 hours to dissolve. However, the lysis time may be reduced in certain conditions. For example, in patients with acute fibrinolytic disease the clot may dissolve within 1–4 hours.

Report the lysis time of the clot in hours.



Fig. 9.60 Blood deficient in thrombocytes

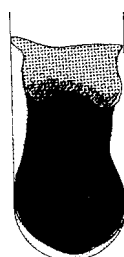

Fig. 9.61 Blood containing abnormal plasma proteins

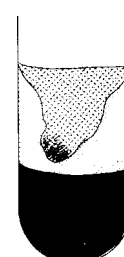

Fig. 9.62 Haemophilia

## 9.10 Preparation and staining of thin blood films

### 9.10.1 Principle

A thin blood film is prepared by spreading a small drop of blood evenly on a slide so that there is only one layer of cells.

Thin blood films are stained with Romanowsky stains, which contain essential azure B and eosin dyes.

The Romanowsky stains most widely used include:

- Leishman stain, which is used alone.
- May–Grünwald stain, which is used with Giemsa stain.
- Giemsa stain, which can be used alone or together with May–Grünwald or Jenner stain.
- Field stains A and B, which are prepared in water unlike the above-mentioned stains, which are made up in methanol. Field stains are used for both thin and thick blood films.

The Romanowsky stains prepared in methanol can be used to fix thin films before being diluted on the slides to stain the films. Better results are obtained by fixing first with methanol, then staining with pre-prepared diluted stains, as described below.

After staining, blood films are used for:

- determining leukocyte type number fractions (see section 9.13)
- detecting abnormal erythrocytes (see section 9.10.4)
- identifying certain parasites (see section 4.7)
- estimating the number of thrombocytes (see section 9.14).

### 9.10.2 Materials and reagents

- Microscope
- Microscope slides (should be well washed and, if necessary, cleaned with ethanol or ether using a piece of soft cloth (Fig. 9.63))
- Spirit lamp or Bunsen burner
- Glass spreader (see below)
- Blood lancet
- Two glass rods, either over a sink or over a staining tank
- Measuring cylinder, 50 ml or 100 ml
- Beakers or bottles containing clean tap water
- Wash bottle containing buffered water (reagent no. 15)
- Interval timer
- Rack for drying slides
- Field stain (reagent no. 25)
- Giemsa stain (reagent no. 29)
- Leishman stain (reagent no. 34)
- May–Grünwald stain (reagent no. 38)
- EDTA dipotassium salt, 10% solution (reagent no. 22)
- Methanol
- 70% Ethanol or ether.



Fig. 9.63 Cleaning slides to be used for thin blood films

To make a spreader, select a slide with a perfectly smooth edge. Make a diagonal mark across the two corners at one end of the slide with a file. Snap off the two filed corners (Fig. 9.64).

### 9.10.3 Method

#### Collection of specimens

Take the blood from the side of the third or fourth finger as shown in Fig. 9.29.

Let the blood flow freely. First take samples for determining the erythrocyte or leukocyte number concentrations, if possible (see sections 9.5 and 9.6).

#### *Important:*

Do not take blood from:

- the index finger or thumb
- an infected finger (e.g. paronychia)
- the ear (too many monocytes).

If it is not possible to prepare the film within 1–2 hours of collection of the blood specimen, EDTA dipotassium salt solution should be added. Other anticoagulants such as heparin alter the appearance of leukocytes and thrombocytes and should not be used.

#### Preparation of the film

1. Collect a drop of blood of about 4 mm diameter by touching it lightly with one end of the slide (Fig. 9.65).
2. Hold the slide with one hand. Using the other hand, place the edge of the spreader just in front of the drop of blood (Fig. 9.66).



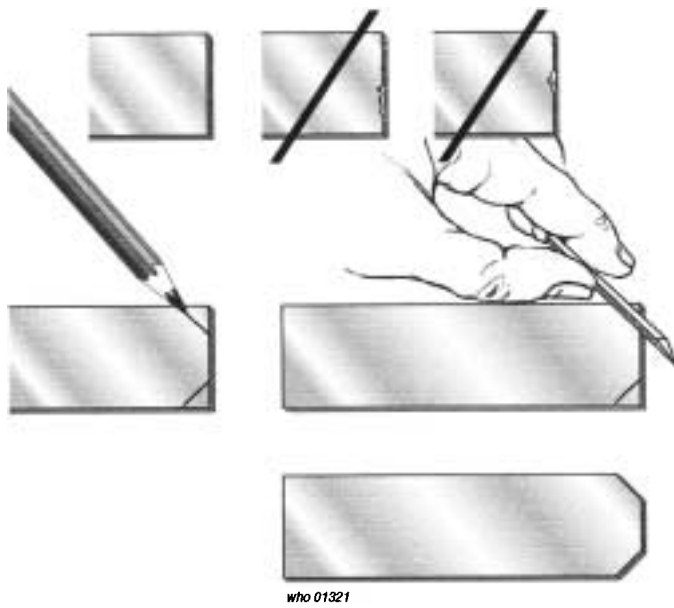

Fig. 9.64 Making a glass spreader

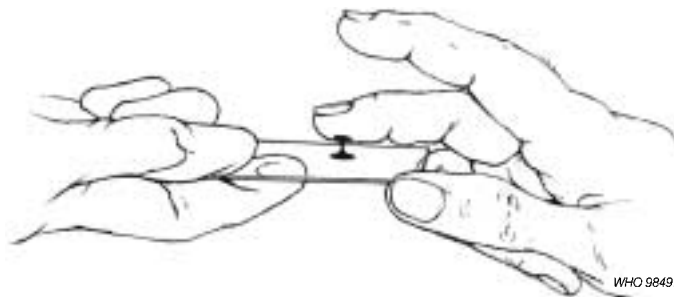

Fig. 9.65 Collecting a drop of blood on a slide

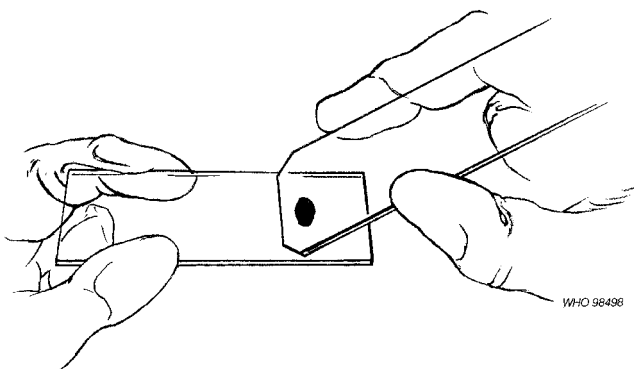

Fig. 9.66 Position the spreader in front of the drop of blood

3. Draw the spreader back until it touches the drop of blood (Fig. 9.67).
4. Let the blood run along the edge of the spreader (Fig. 9.68).
5. Push the spreader to the end of the slide with a smooth movement (Fig 9.69) (all the blood should be used up before you reach the end). Blood from patients with anaemia should be spread more rapidly.

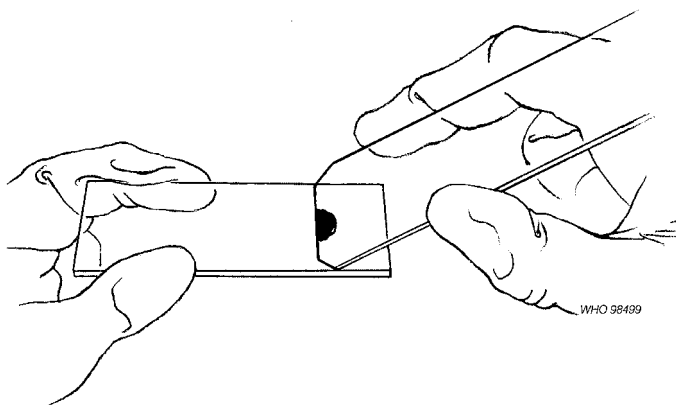

Fig. 9.67 Draw the spreader back until it touches the drop of blood

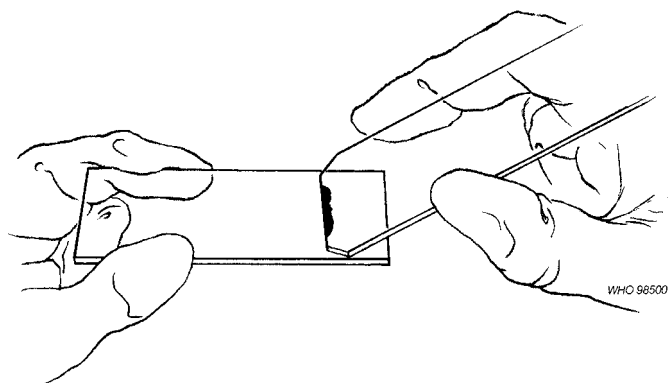

Fig. 9.68 Allow the blood to run along the edge of the spreader

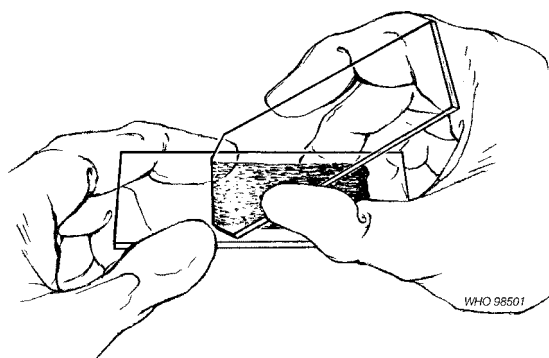

Fig. 9.69 Push the spreader to the end of the slide with a smooth movement

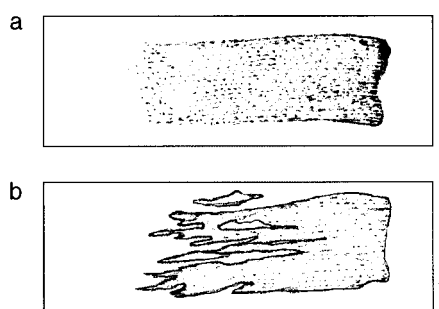

Fig. 9.70 Correctly (a) and incorrectly prepared (b) blood films

6. Check that the film is satisfactory as shown in Fig. 9.70 (a).

- There should be no lines extending across or down through the film.
- The film must be smooth at the end, not ragged and lined as shown in Fig. 9.70 (b).
- The film must not be too long.
- The film must not be too thick.
- The film must not contain holes because a greasy slide has been used.

A well-spread film is of great importance. A badly spread film will give the wrong leukocyte type number fractions and make it impossible to report erythrocyte morphology.

**Drying the film**

Adequate drying is essential to preserve the quality of the film, especially in humid climates. The film can be left to air-dry in dry climates.

In the wet season (in the tropics)

Dry the film by waving it rapidly about 5 cm away from the flame of a spirit lamp or Bunsen burner: hold the slide to the side and slightly above (but never directly over) the flame (Fig. 9.71). If necessary, protect the blood film from flies.

Mark the dry film with the patient's name or number. Write with a lead pencil on the thick part of the film not used for examination.



Fig. 9.71 Drying the blood film over a spirit lamp

**Fixation of the film**

If the film is intended for determining leukocyte type number fractions, it should be fixed with methanol before staining with May–Grünwald stain (see below).

If the film is intended for detection of parasites, it should be fixed with methanol before staining with Giemsa or Field stain (see below).

**Precautions**

Care is required to avoid the formation of deposits of stain, which appear on the film as masses of little black spots. A number of precautions are also required to avoid staining the films too blue, too pink or too dark; these are briefly described below.

- Use perfectly clean glassware. Wash it every day. *Do not* use acid. Remove stain deposits with methanol.
- Use neutral water (buffered if possible, except for Field stain). The preparation technique is described in section 2.4.4. Acid water produces a film that is too red; alkaline water one that is too blue. Neutral water must be freshly prepared as it becomes acid when exposed to air.

**Staining of the film****Method for Leishman stain**

1. Fix the thin blood film with methanol for 2–3 minutes.
2. Prepare a 1 in 3 dilution of Leishman stain using one volume of stain and two volumes of buffered water. Mix.

*Example:* Use 10 ml of stain and 20 ml of buffered water.

Prepare sufficient stain for 1 day's use only, as the diluted stain does not keep well.

3. Cover the slide with the diluted stain for 7–10 minutes.

*Important:* The staining time may need to be adjusted, especially when a new batch of stain is received or the stain has been stored for a long time.

4. Wash the stain off in a stream of buffered water. Do not tip the stain off as this will leave a deposit of stain on the film.
5. Leave clean water on the slide for 2–3 minutes to differentiate the film. (The time taken for differentiation will depend on the stain and the pH of the water used.)

The pH of the water is of vital importance in differentiating the different types of leukocyte with Leishman stain. It should be between 6.8 and 7.2, and preferably between 7.0 and 7.2.

6. Tip the water off and place the slide in a draining rack to dry.

**Method for May–Grünwald and Giemsa stains**

1. Fix the thin film with methanol for 2–3 minutes.
2. Prepare the stains as follows:
  - Dilute May–Grünwald stain 1 in 2 using equal volumes of stain and buffered water. Mix.  
*Example:* use 10 ml of stain and 10 ml of buffered water.
  - Dilute Giemsa stain 1 in 10 using one volume of stain and nine volumes of buffered water. Mix gently.  
*Example:* use 2 ml of stain and 18 ml of buffered water.

*Note:* Prepare only enough stain for 1 day's use, as the diluted stains do not keep well. Prepare the Giemsa mixture slowly and carefully. Shaking causes the stain to precipitate.
3. Cover the slide with diluted May–Grünwald stain for 5 minutes.
4. Tip the stain off and replace with diluted Giemsa stain for 10 minutes.  
*Important:* The staining time may need to be adjusted, especially when a new batch of stain is received or the stain has been stored for a long time.
5. Wash the stain off in a stream of buffered water. Do not tip the stain off as this will leave a deposit of stain on the film.
6. Leave clean water on the slide for 2–3 minutes to differentiate the film. The time for differentiation will depend on the stain and the pH of the water used. The pH should be between pH 6.8 and 7.0.
7. Tip the water off and place the slide in a draining rack to dry.

**Method (rapid) for Field stain**

1. Fix the thin film with methanol for 2–3 minutes.
2. Dip the slide into Field stain B (Fig. 9.72) and count up to five. Drain and wash the slide in the first container of tap water (Fig. 9.73).
3. Drain and dip the slide into Field stain A and count up to 10. Drain and wash the slide well in the second container of tap water.

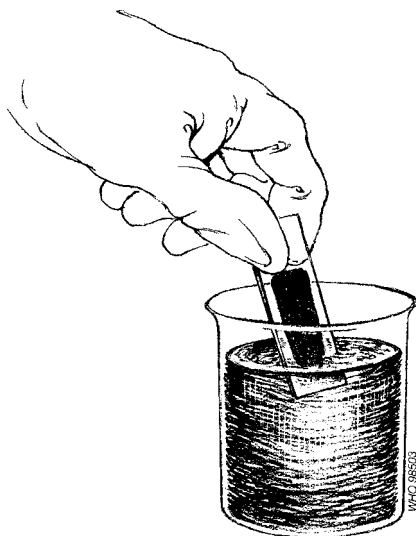

Fig. 9.72 Staining the blood film with Field stain

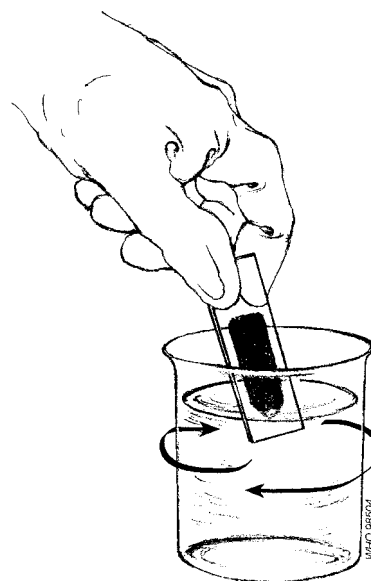

Fig. 9.73 Rinsing the slide in water

4. Examine the colour of the film. It should appear mauve, neither too blue nor too pink.

If the film is not satisfactory, return the slide either to the Field stain A or to the Field stain B for a few more seconds, as needed.

If the film is satisfactory, stand the slide in a draining rack to dry.

#### *How to remedy poor results*

Deposits of May-Grünwald stain or neutral water

Deposits caused by May-Grünwald stain or neutral water can be seen with the naked eye in the liquid on the slide. Drain off the stain. Rinse the slide twice in methanol. Dry and re-stain using fresh or filtered May-Grünwald stain.

Deposits of Giemsa stain

These deposits are seen with the naked eye or under the microscope. Rinse with methanol, but wash off immediately with neutral water. Dry the slide and repeat the staining procedure from the beginning.

Too much blue in the film (basophilic staining)

Prepare a solution of 1% boric acid in 95% ethanol. Rinse the slide twice in this preparation. Wash at once in neutral water. Dry and examine under the microscope without further treatment. Basophilic staining can usually be prevented by using buffered water at a more acid pH and, if necessary, altering the differentiation time.

Poor staining may also be caused by impurities in the dyes — the use of the standardized stain is recommended.

#### 9.10.4 Microscopic examination

Using the  $\times 40$  objective, examine the slides. The cells should appear as described in Table 9.10.

#### **Erythrocytes**

In certain diseases, especially anaemia, the erythrocytes may have an abnormal shape, size or colour. To check for abnormal erythrocytes, look at the cells just before the thin end of the film; this is where they are spread out, just touching one another, but not overlapping (Fig. 9.74). Do not look at either the thick end, where the cells are too closely packed (Fig. 9.75), or the thin end, where there are not enough cells (Fig. 9.76).

The various types of abnormal erythrocytes are described below.

**Table 9.10 Appearance of blood cells in thin films stained with Leishman stain**

Cell type	Appearance
Neutrophils	Cytoplasm stains faint pink and contains small mauve granules
Eosinophils	Cytoplasm stains faint pink and contains large red granules
Basophils	Cytoplasm contains numerous dark mauve-blue granules
Monocytes	Cytoplasm stains grey-blue
Lymphocytes	
large	Cytoplasm stains clear blue
small	Cytoplasm stains dark blue
Erythrocytes	Stain pink-red
Thrombocytes	Stain mauve-pink

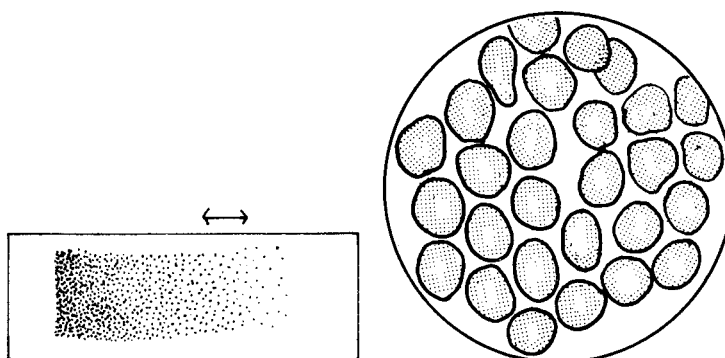

Fig. 9.74 Examining blood films for abnormal erythrocytes: where to look

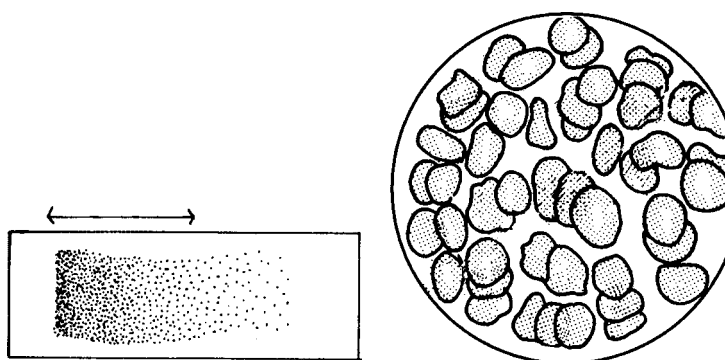

Fig. 9.75 Examining blood films for abnormal erythrocytes: cells too closely packed

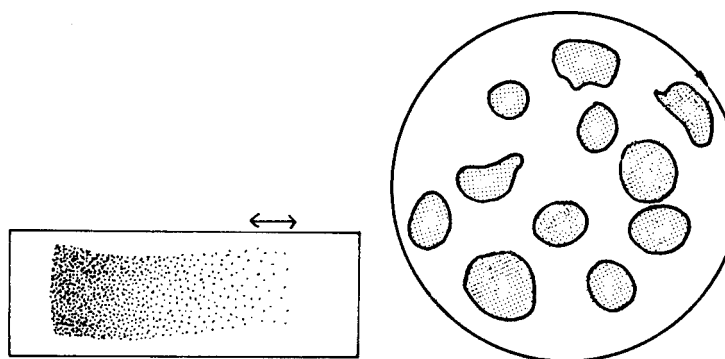

Fig. 9.76 Examining blood films for abnormal erythrocytes: not enough cells

**Normal erythrocytes** (Fig. 9.77)

*Size:* 6–8  $\mu\text{m}$ .

*Shape:* round, discoid, occasionally slightly irregular.

*Cytoplasm:* periphery deep pink, centre pale pink or colourless.

**Target cells** (Fig. 9.78)

*Size:* 6–8  $\mu\text{m}$ .

*Shape:* round or slightly irregular.

*Cytoplasm:* centre and periphery stain well, but between them there is a colourless ring.

Seen in thalassaemias, vitamin B<sub>6</sub> deficiency, haemoglobinopathy, liver diseases, sickle-cell anaemia and iron-deficiency anaemia.

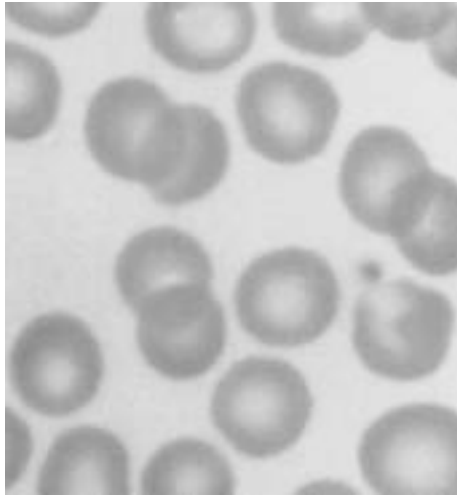

Fig. 9.77 Normal erythrocytes

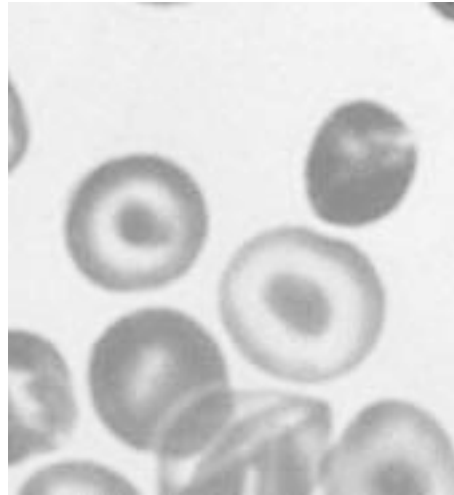

Fig. 9.78 Target cells

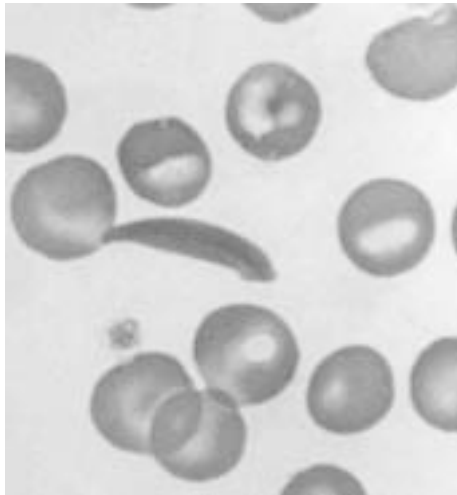

Fig. 9.79 Sickle cells

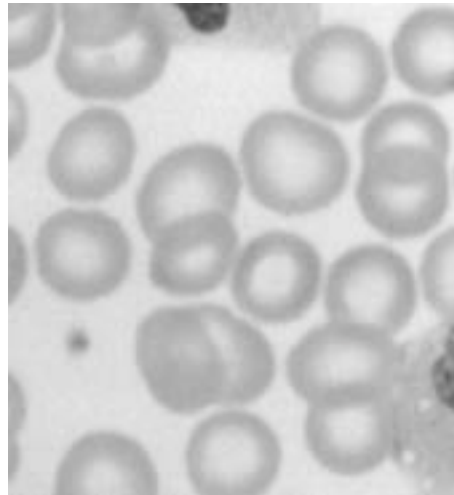

Fig. 9.80 Microcytes

**Sickle cells** (Fig. 9.79)

*Shape:* elongated and narrow, often with one or both ends curved and pointed.

Seen in sickle-cell anaemia and sickle-cell thalassaemia, along with nucleated erythrocytes, target cells and often macrocytes.

Microscopic examination of sickle cells in wet preparations is described in section 9.11.4.

**Microcytes** (Fig. 9.80)

*Size:* small (about 5  $\mu\text{m}$ ).

Seen often in iron-deficiency anaemia, sideroblastic anaemia and thalassaemias. Must be distinguished from spherocytes (see below).

**Macrocytes** (Fig. 9.81)

*Size:* large (9–10  $\mu\text{m}$ ).

Seen in macrocytic anaemias caused by folic acid deficiency, vitamin B<sub>12</sub> deficiency and iron-deficiency anaemia, and in certain liver diseases. Must be distinguished from reticulocytes (see below).

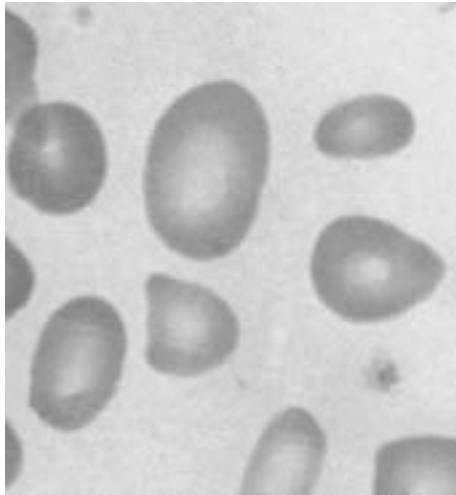

Fig. 9.81 Macrocytes

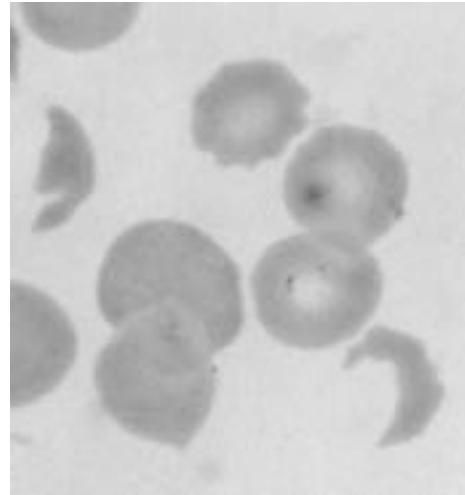

Fig. 9.82 Schistocytes

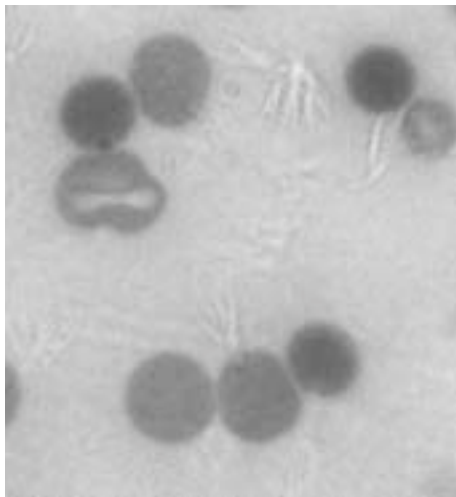

Fig. 9.83 Spherocytes

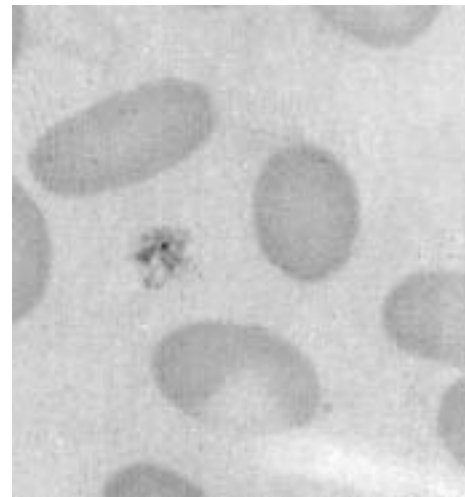

Fig. 9.84 Elliptocytes

**Schistocytes** (Fig. 9.82)

*Size:* normal or slightly smaller than normal erythrocytes.

Fragmented cells.

Seen in haemolytic anaemias, sickle-cell disease and thalassaemias.

**Spherocytes** (Fig. 9.83)

*Size:* small (6  $\mu\text{m}$ ).

*Shape:* perfectly round.

*Cytoplasm:* more darkly stained than normal erythrocytes.

Seen in haemolytic anaemias and hereditary spherocytosis.

**Elliptocytes** (Fig. 9.84)

*Size:* normal (8  $\mu\text{m}$ ).

*Shape:* oval.

*Cytoplasm:* stained darker at the periphery (especially at the poles).



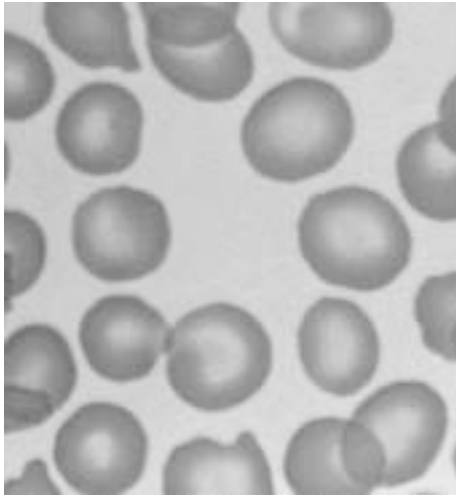

Fig. 9.85 Anisocytosis

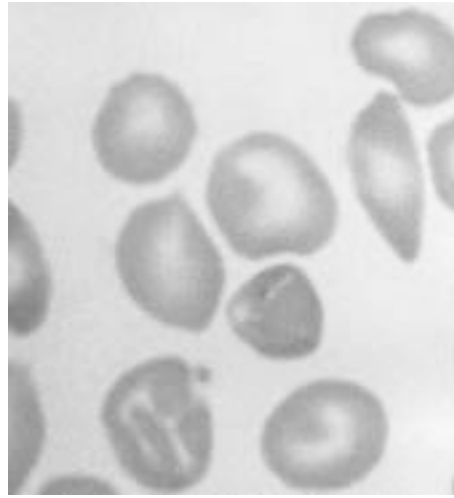

Fig. 9.86 Poikilocytes

Seen very occasionally. Found in hereditary elliptocytosis, iron-deficiency anaemia, pernicious anaemia, sickle-cell disease, thalassaemias and myelofibrosis.

**Anisocytosis** (Fig. 9.85)

A condition in which erythrocytes of *different sizes* are present in the blood, e.g. erythrocytes measuring 9  $\mu\text{m}$  are mixed with erythrocytes measuring 6  $\mu\text{m}$ .

Seen in many types of anaemia.

**Poikilocytes** (Fig. 9.86)

Erythrocytes of *different shapes* in the blood, e.g. a mixture of round, oval, triangular, pear-shaped and indented cells.

Seen in many types of severe anaemia and myelofibrosis.

**Erythrocytes containing Howell–Jolly bodies** (Fig. 9.87)

Erythrocytes containing one or more large purple granules (nuclear remnants).

Do not confuse with thrombocytes lying on the cells.

Seen in haemolytic anaemias and megaloblastic anaemia, and following splenectomy.

**Erythrocytes containing Cabot ring bodies** (Fig. 9.88)

Erythrocytes containing thin ring-shaped or figure-of-eight structures that stain red with Wright stain.

Seen in severe anaemias.

Do not confuse with malaria parasites.

**Erythrocytes containing basophilic stippling** (Fig. 9.89)

Erythrocytes containing multiple blue–black dots in the cytoplasm.

Do not confuse with stain deposits.

Seen in vitamin deficiency, thalassaemias and lead poisoning.

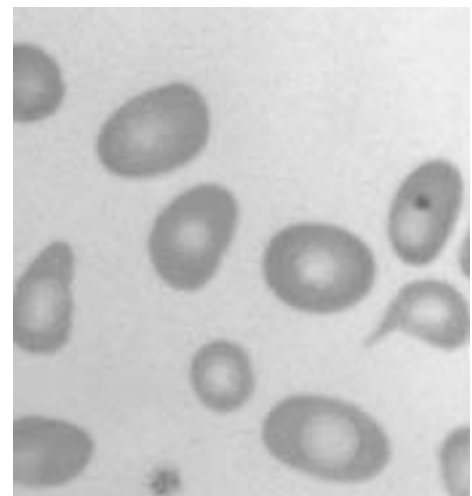

Fig. 9.87 Erythrocytes containing Howell–Jolly bodies

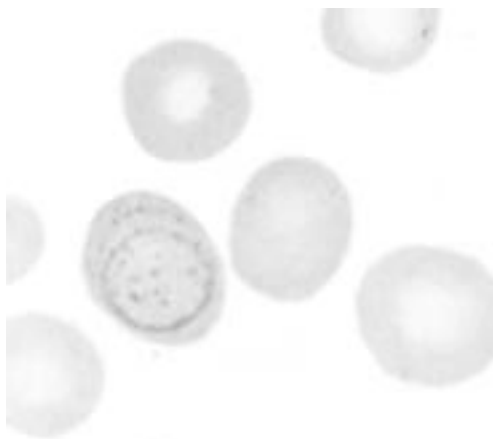

Fig. 9.88 Erythrocytes containing Cabot ring bodies

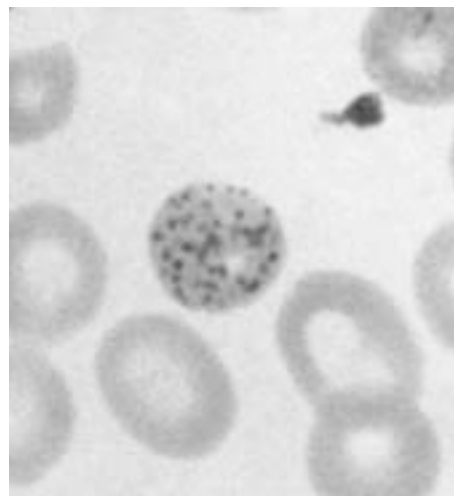

Fig. 9.89 Erythrocytes containing basophilic stippling

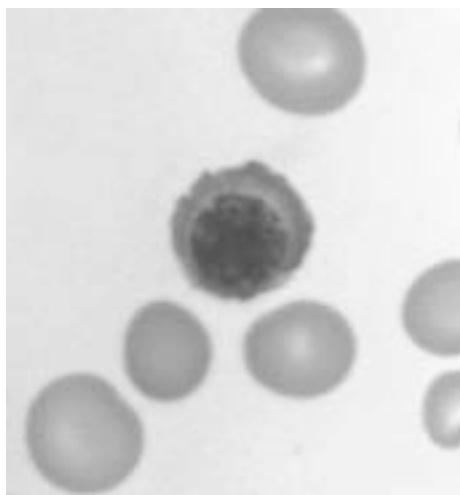

Fig. 9.90 Normoblasts

**Nucleated erythrocytes (normoblasts)** (Fig. 9.90)

*Size:* 8–10  $\mu\text{m}$ .

*Shape:* round or irregular.

*Nucleus:* round, often eccentric, with deep purple, dense chromatin.

*Cytoplasm:* pink or greyish-blue.

Seen in accelerated erythropoiesis in severe anaemias, for example sickle-cell anaemia, in severe bacterial infections, and in leukaemias and cancers.

**Reticulocytes** (Fig. 9.91)

Erythrocytes containing granules (nuclear remnants) that stain dark blue with vital stains such as brilliant cresyl blue and Evan's blue. Reticulocytes usually disappear within 4 hours after the release of the erythrocytes into the blood.

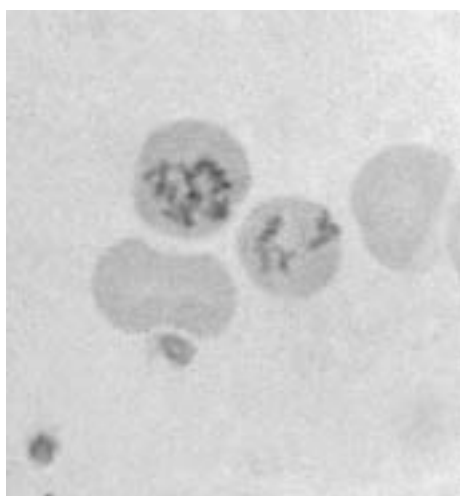

Fig. 9.91 Reticulocytes

**Leukocytes**

In contrast to erythrocytes, leukocytes contain a nucleus that may vary in size and shape. As already mentioned, there are five main types of leukocyte — neutrophils, eosinophils, basophils, lymphocytes and monocytes.

The proportion of each type of leukocyte, known as the leukocyte type number fraction, is of diagnostic importance.

**Polymorphonuclear cells (neutrophils, eosinophils and basophils)**

Polymorphonuclear cells have:

- a nucleus with several lobes;
- granules in the cytoplasm (hence their usual name, granulocytes).

**Polymorphonuclear neutrophils** (Fig. 9.92)

*Size:* 12–15  $\mu\text{m}$ .

*Shape:* rounded, well defined.

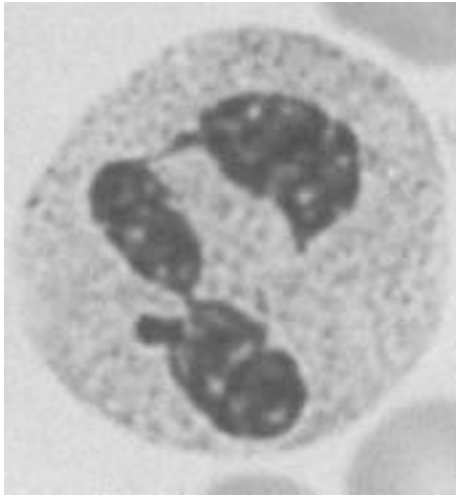

Fig. 9.92 Polymorphonuclear neutrophils

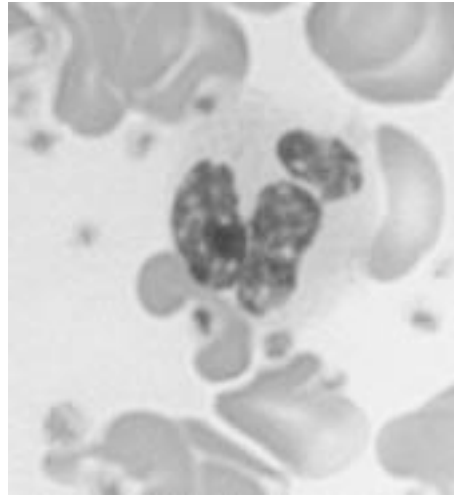

Fig. 9.93 Polymorphonuclear eosinophils

*Nucleus:* several (2–5) lobes, linked by strands of chromatin. The chromatin appears as a uniform deep purple mass.

*Cytoplasm:* abundant, pinkish, containing numerous very small, mauve granules. The granules appear brown-violet after staining.

Polymorphonuclear eosinophils (Fig. 9.93)

*Size:* 12–15  $\mu\text{m}$ .

*Nucleus:* usually two lobes.

*Cytoplasm:* very little visible, containing numerous large, round, densely packed, orange-red granules.

Sometimes the cell appears damaged, with scattered granules.

Polymorphonuclear basophils (Fig. 9.94)

These are the rarest type of granulocyte.

*Size:* 11–13  $\mu\text{m}$ .

*Shape:* round.

*Nucleus:* difficult to see because it is covered by the granules.

*Cytoplasm:* very little visible, containing numerous very large, round, deep purple granules, less densely packed than those of the eosinophils. Small colourless vacuoles are sometimes present.

### ***Lymphocytes and monocytes***

Lymphocytes and monocytes have a compact nucleus and may or may not have granules in the cytoplasm.

Small lymphocytes (Fig. 9.95)

*Size:* 7–10  $\mu\text{m}$ .

*Shape:* round.

*Nucleus:* large (occupying most of the cell), with densely packed dark purple chromatin.

*Cytoplasm:* very little visible, blue with no granules.

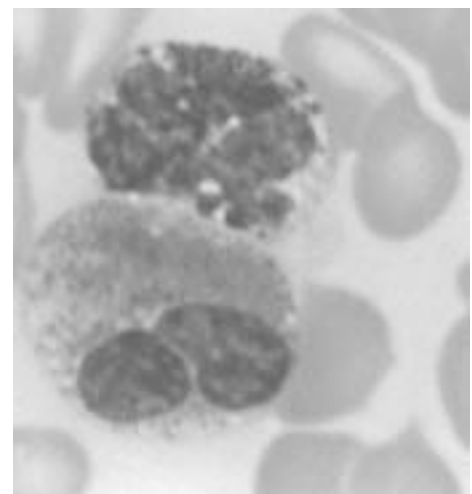

Fig. 9.94 Polymorphonuclear basophils

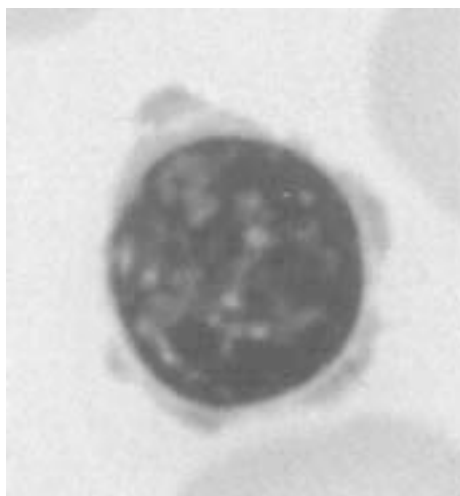

Fig. 9.95 Small lymphocytes

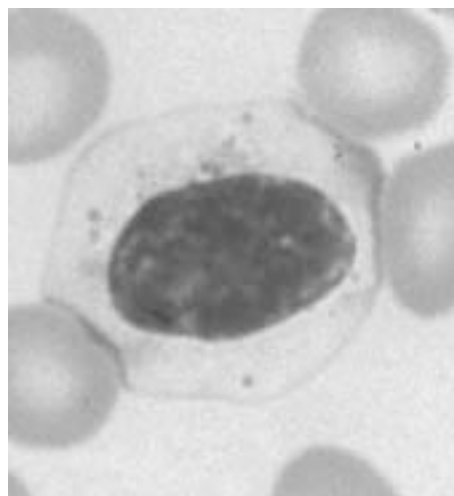

Fig. 9.96 Large lymphocytes

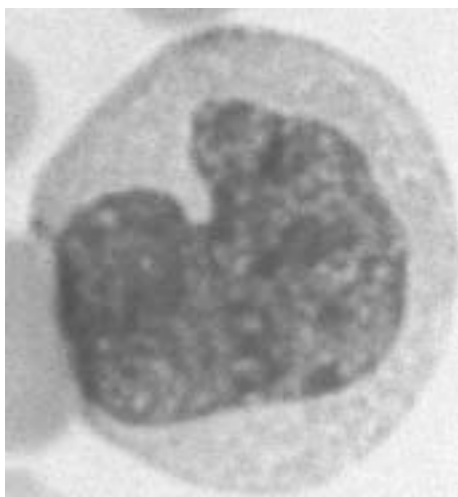

Fig. 9.97 Monocytes

Large lymphocytes (Fig. 9.96)

*Size:* 10–15  $\mu\text{m}$ .

*Shape:* round or irregular.

*Nucleus:* oval or round, may lie to one side of the cell.

*Cytoplasm:* abundant, pale blue, containing several large, dark red granules.

Monocytes (Fig. 9.97)

*Size:* 15–25  $\mu\text{m}$  (largest of the leukocytes).

*Shape:* irregular.

*Nucleus:* variable, often kidney-shaped with pale mauve chromatin arranged in strands.

*Cytoplasm:* pale blue, containing fine, dust-like, usually reddish granules. Vacuoles are usually present.

In patients suffering from malaria the cytoplasm often contains brownish-black masses. These masses are malaria pigment.

#### *Rare or abnormal cells*

Plasma cells (Fig. 9.98)

Plasma cells produce antibodies. They may be seen in blood films prepared from patients with measles, tuberculosis, other viral or bacterial infections or multiple myeloma.

*Size:* 12–15  $\mu\text{m}$ .

*Shape:* round or oval.

*Nucleus:* round, eccentric, with densely packed chromatin, often in a wheel-like arrangement.

*Cytoplasm:* dark blue with a pale-staining area round the nucleus. Numerous very small vacuoles are present, which are not easily seen.

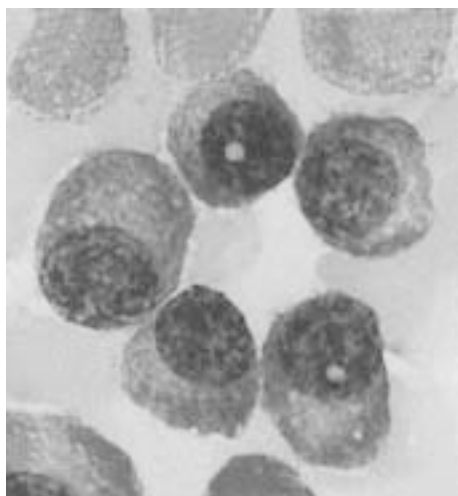

Fig. 9.98 Plasma cells

### Immature granulocytes

Immature polymorphonuclear granulocytes of the bone marrow pass into the bloodstream in severe bacterial infections. They can be distinguished by the following features:

*Size:* 12–18  $\mu\text{m}$ .

*Nucleus:* without lobes, with chromatin varying in colour from dark red to purple.

*Cytoplasm:* pale blue or pink with many large mauve or dark red granules. Toxic granulation may be seen, in which the granules are very large and darkly stained.

If immature polymorphonuclear neutrophils (“band form” or “stab cells”) (Fig. 9.99) are seen, report their number fraction as for other types of leukocyte.

There are also immature cells without granules and with nucleoli (lymphoblasts) (see Fig. 9.102).

### Hypersegmented polymorphonuclear neutrophils (Fig. 9.100)

Hypersegmented polymorphonuclear neutrophils look like normal neutrophils, except that their nuclei have 5–10 lobes and are often larger in size.

Such neutrophils can be seen in patients with macrocytic anaemia, caused by folic acid or vitamin B<sub>12</sub> deficiency.

### Atypical lymphocytes (Fig. 9.101)

Atypical lymphocytes can be seen in viral infections, especially infectious mononucleosis (glandular fever), whooping cough and measles. They are also found in tuberculosis, severe malaria and the acquired immunodeficiency syndrome (AIDS).

*Size:* very variable, 12–18  $\mu\text{m}$ .

*Shape:* usually irregular.

*Nucleus:* round or irregular, often lying to one side of the cell; nucleoli may be seen.

*Cytoplasm:* usually darker blue than that of large lymphocytes; forms a dark edge to the cell. Does not contain granules.

### Lymphoblasts (Fig. 9.102)

The earliest (most immature) of all the types of leukocyte. Lymphoblasts can be seen in the blood films of patients with leukaemia.

*Size:* large, 15–25  $\mu\text{m}$ .

*Nucleus:* large, round, pale mauve, containing 1–5 nucleoli.

*Cytoplasm:* dark blue, with a clear unstained area round the nucleus. Does not contain granules.

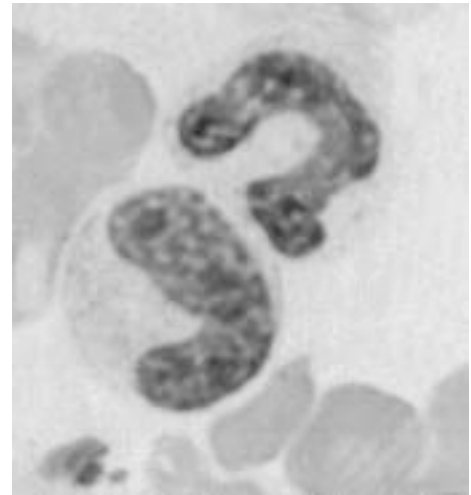

Fig. 9.99 Immature polymorphonuclear neutrophils

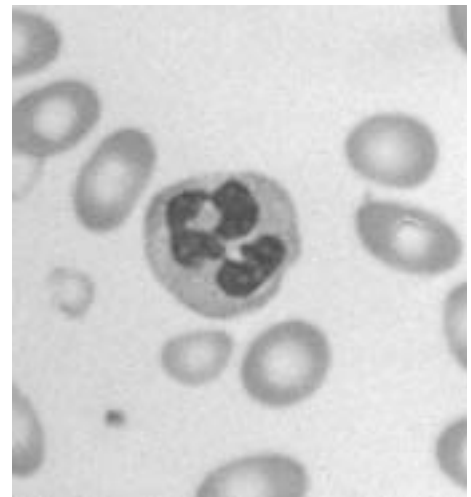

Fig. 9.100 Hypersegmented polymorphonuclear neutrophils

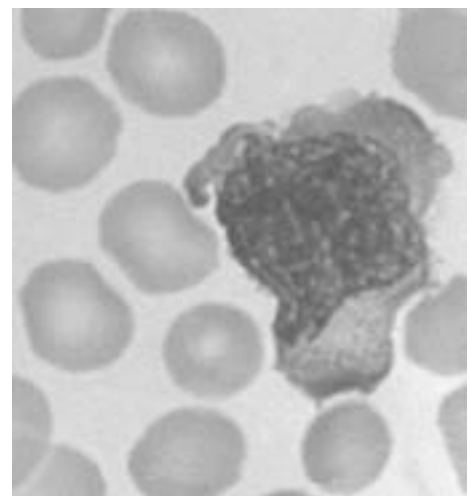

Fig. 9.101 Atypical lymphocyte

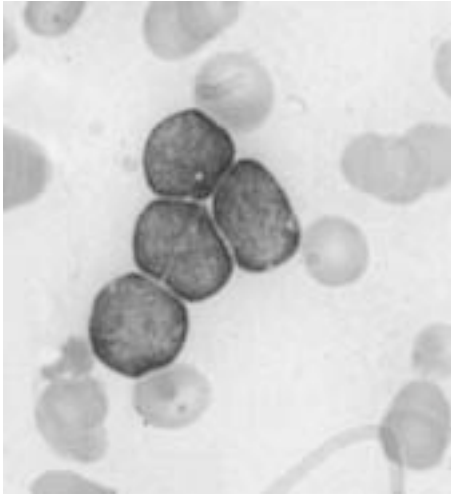

Fig. 9.102 Lymphoblast

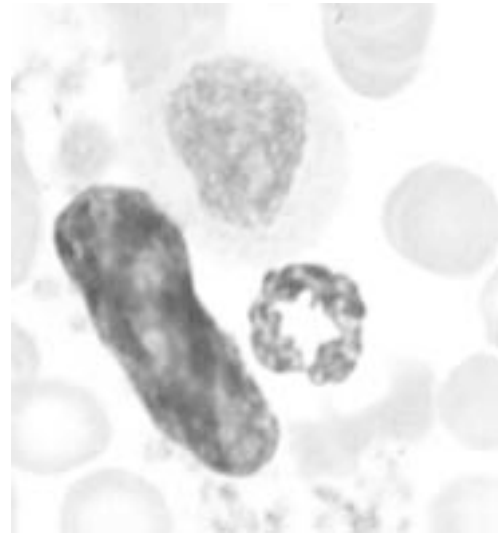

Fig. 9.103 Megakaryocyte

Megakaryocytes (Fig. 9.103)

The parent cells of thrombocytes (see section 9.1.3) found in the bone marrow.

*Size:* very large, 60–100  $\mu\text{m}$ .

*Nucleus:* very irregular, greatly lobulated but dense.

*Cytoplasm:* contains numerous fine granules, mostly dark red, and thrombocytes.

The cell wall is not clearly defined.

(Very rarely found in the blood.)

## 9.11 Test for sickle-cell anaemia

Haemoglobin S is an inherited abnormal haemoglobin. If inherited from both parents it causes sickle-cell anaemia, a serious disease. If inherited from only one parent it causes sickle-cell trait, which does not usually cause disease. Haemoglobin S occurs mainly in tropical Africa but also in the Eastern Mediterranean region and among Americans of African origin. The sickle-cell slide test does not distinguish between sickle-cell anaemia and sickle-cell trait.

### 9.11.1 Principle

One drop of blood is mixed with one drop of sodium metabisulfite reagent on a slide. If the erythrocytes contain haemoglobin S, they will become sickle-shaped or half-moon-shaped (see Fig. 9.79).

The reagent removes oxygen from the cells, allowing sickling to take place.

### 9.11.2 Materials and reagents

- Microscope
- Microscope slides
- Coverslips
- Filter-paper
- Pasteur pipette (or dropping pipette)
- Two small wooden sticks
- Containers to prevent drying of the preparation, such as Petri dishes
- Fresh sodium metabisulfite, 2% solution (reagent no. 55).



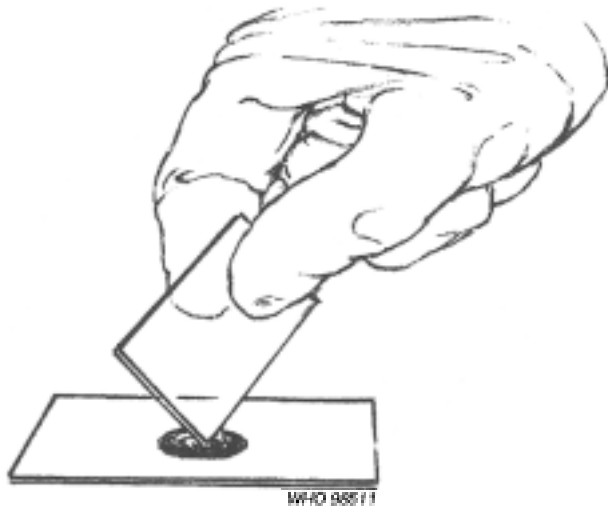

Fig. 9.104 Mixing the blood and sodium metabisulfite solution

### 9.11.3 Method

1. Place a small drop of capillary blood (about 4 mm diameter) in the centre of a slide (see Fig. 9.65).
2. Add an equal-sized drop of sodium metabisulfite solution.
3. Mix carefully with the corner of a slide (Fig. 9.104). Cover with a coverslip, making sure that no air bubbles form.
4. Place the slide in a Petri dish that has wet filter-paper in the bottom. Support the slide on two sticks (Fig. 9.105). Wait 30 minutes before examining the slide.

*Note:* When using a reducing reagent such as sodium metabisulfite it is not necessary to seal the preparation.

### 9.11.4 Microscopic examination

Examine the slide under the microscope using the  $\times 40$  objective.

#### Negative result

The erythrocytes remain round (Fig. 9.106).

If the test is negative, re-examine the slide after a further 30 minutes, then after 2 hours and after 24 hours.

#### Positive result

The erythrocytes become sickle-shaped or banana-shaped (Fig. 9.107 (a)), often with spikes (Fig. 9.107 (b)).

It is important to examine several parts of the preparation, as sickling can occur more quickly in one part than in another.

Do not mistake normal erythrocytes lying on their side or crenated cells for sickle cells.

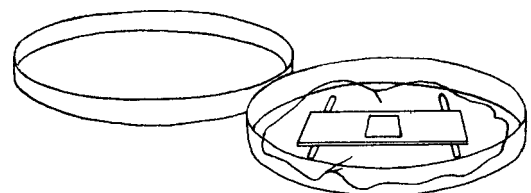

Fig. 9.105 Incubating the slide in a Petri dish

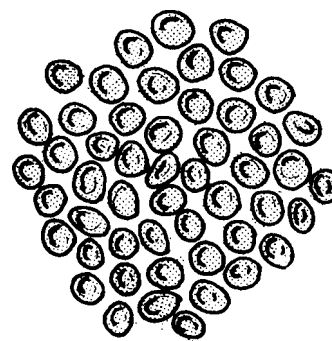

Fig. 9.106 Test for sickle-cell anaemia: negative result

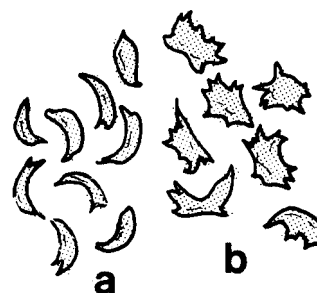

Fig. 9.107 Test for sickle-cell anaemia: positive result  
a: Sickle-shaped erythrocytes; b: sickle-shaped erythrocytes with spikes.

*Note:*

False-negative results may occur if:

- outdated reagents are used;
- concentrations of haemoglobin S are low;
- patients have moderate or severe anaemia.

If the test is positive a thin blood film should be examined. Patients with sickle-cell anaemia have sickle cells, nucleated erythrocytes, target cells, marked poikilocytosis and often macrocytosis. Patients with sickle-cell trait are not usually anaemic and have a normal erythrocyte morphology. Whenever possible, electrophoresis of the haemoglobin should be carried out to confirm a diagnosis of sickle-cell disease. This can be done in a reference laboratory.

**Other methods**

- The test can be carried out on venous blood provided it is freshly collected (within 1–2 hours of the test) or collected into an anticoagulant (EDTA dipotassium salt, 10% solution (reagent no. 22)).
- The test can also be carried out using a test-tube rather than a Petri dish. Commercial reagents are available for this method.

**9.12 Determination of the reticulocyte number concentration/fraction**

Reticulocytes are immature erythrocytes that pass into the bloodstream from the bone marrow. The number of reticulocytes in the blood indicates the degree of activity of the bone marrow in the production of erythrocytes, and when the marrow is very active (as in anaemia) their number increases. Reticulocytes contain fine, deep-violet granules arranged in a network (reticulum). They do not contain a nucleus.

**9.12.1 Principle**

The fine granules in reticulocytes can be stained with brilliant cresyl blue. A blood film is stained with this dye and a certain number of erythrocytes observed under the microscope. From this observation, either:

- the number of reticulocytes per litre of blood, or
- the proportion of erythrocytes that are reticulocytes is calculated.

**9.12.2 Materials and reagents**

- Microscope
- Microscope slides (grease-free)
- Glass spreader
- Test-tubes
- Test-tube rack
- Funnel
- Filter-paper
- Two Pasteur pipettes with teats
- Hand tally counter, if available
- Saturated solution of brilliant cresyl blue (reagent no. 13).





Fig. 9.108 Preparing the cresyl blue solution

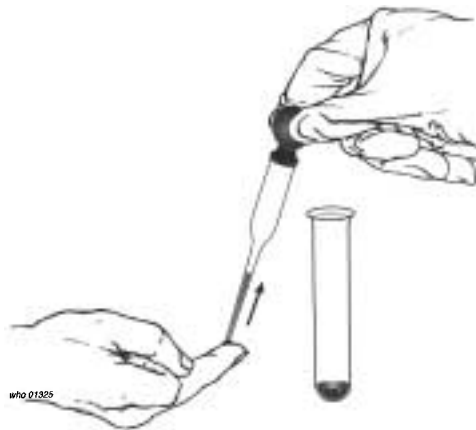

Fig. 9.109 Collecting a capillary blood sample

### 9.12.3 Method

1. Filter a little of the cresyl blue solution into a test-tube. In the bottom of another tube place two drops of filtered cresyl blue solution (Fig. 9.108).
2. Collect a few drops of blood from the patient's finger with a Pasteur pipette (Fig. 9.109), or use venous blood collected in EDTA dipotassium salt solution and mix well.
3. Add two drops of blood to the tube containing cresyl blue solution.
4. Mix by gently shaking the tube. Plug the tube with non-absorbent cotton wool. Leave for 15 minutes.
5. Take the tube and shake it gently. Remove one drop of the mixture. Place it on a slide ready for spreading.
6. Make a thin smear of the mixture with the spreader (see section 9.10.3). Leave the smear to air-dry.

### 9.12.4 Microscopic examination

Examine the smear using the  $\times 100$  oil-immersion objective (Fig. 9.110). Look at the end of the smear, where the erythrocytes should be well separated from each other. Erythrocytes stain pale blue.

Examine at least 100 erythrocytes. Keep a careful count of the total number of erythrocytes examined and the number of these that are reticulocytes. (Counting is easier if the size of the microscope field is reduced. This can be done by placing in the eyepiece a small circular piece of stiff black paper in which a hole of about 5 mm in diameter has been punched.)

Some haematologists prefer reticulocytes to be reported in terms of the number concentration (number of reticulocytes per litre of blood), while others prefer them to be reported in terms of the number fraction (the proportion of erythrocytes that are reticulocytes). Depending on the practice in your laboratory or the specification of the requesting physician, make the appropriate calculation.<sup>1</sup>

<sup>1</sup> Traditionally, reticulocytes have been reported in the form of percentages (i.e. the proportion, expressed as a percentage, of the erythrocytes that are reticulocytes). If 500 erythrocytes are observed on the blood film and  $n$  of them are reticulocytes, the percentage of erythrocytes is calculated by multiplying  $n$  by 0.2.

*Example:*

Of 500 erythrocytes examined, 25 are reticulocytes. The percentage of reticulocytes is then  $25 \times 0.2 = 5\%$ . The normal range for newborn infants is 2.0–6.0%, and that for adults and children is 0.2–2.0%.

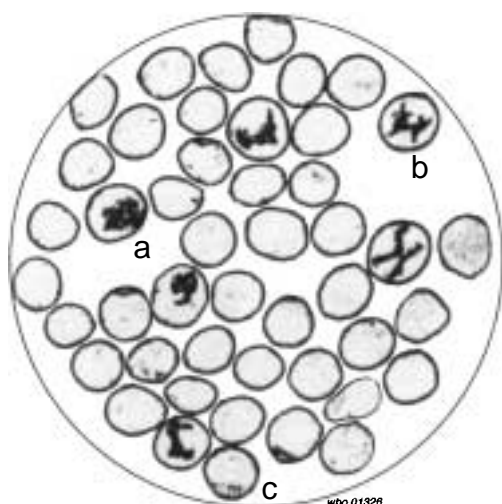

Fig. 9.110 Examining the smear under the microscope  
 a: Typical reticulocytes, containing fine, deep violet granules;  
 b: reticulocytes containing filaments;  
 c: mature reticulocytes (containing only a few granules).

### Calculation

To calculate the reticulocyte number concentration, you must know the total erythrocyte number concentration. If  $C$  is the total erythrocyte number concentration (omitting the " $\times 10^{12}/l$ ") and  $n$  is the number of reticulocytes seen on observing 500 erythrocytes, the reticulocyte number concentration is  $C \times 2n \times 10^9/l$ .

*Example:*

$$\begin{aligned} \text{total erythrocyte number concentration} &= 4.5 \times 10^{12}/l \\ \text{number of reticulocytes seen in counting 500 erythrocytes} &= 6 \\ \text{reticulocyte number concentration} &= 4.5 \times (2 \times 6) \times 10^9/l \\ &= 4.5 \times 12 \times 10^9/l \\ &= 54 \times 10^9/l \\ &\text{(report this result).} \end{aligned}$$

To calculate the reticulocyte number fraction you do not need to know the erythrocyte number concentration. If  $n$  is the number of reticulocytes seen in examining 500 erythrocytes, the reticulocyte number fraction is  $2n \times 10^{-3}$ .

*Example:*

$$\begin{aligned} \text{number of reticulocytes seen in counting 500 erythrocytes} &= 6 \\ \text{reticulocyte number fraction} &= (2 \times 6) \times 10^{-3} = 12 \times 10^{-3} \end{aligned}$$

*Note:* If more than 500 erythrocytes are examined on the blood film, the calculation will have to be adjusted accordingly.

### Reference range

Table 9.11 shows the reference ranges for different age groups.

### Other structures that can be seen in blood films stained with brilliant cresyl blue

The blood film stained with brilliant cresyl blue that is used for determining the reticulocyte number concentration and reticulocyte number fraction may also show the following structures.

#### *Haemoglobin H bodies*

Haemoglobin H bodies appear as pale blue dots, variable in size. Unlike the reticulum of the reticulocytes, they occur in most of the erythrocytes. They are found in  $\alpha$ -thalassaemia or haemoglobin H disease.

**Table 9.11 Reticulocyte number concentrations and reticulocyte number fractions, by age group**

Age group	Reticulocyte number concentration <sup>a</sup>	Reticulocyte number fraction
Infants (newborn)	100–300 $\times 10^9/l$	20–60 $\times 10^{-3}$
Children	8–110 $\times 10^9/l$	2–20 $\times 10^{-3}$
Adults	8–110 $\times 10^9/l$	2–20 $\times 10^{-3}$

<sup>a</sup> Approximate values. The concentration depends on the erythrocyte number concentration (see Table 9.7).

### *Heinz bodies*

Heinz bodies appear as blue granules, variable in size, lying to one side of the erythrocyte near the cell membrane. They occur in glucose-6-phosphatase dehydrogenase deficiency following treatment with certain drugs.

## 9.13 Determination of the leukocyte type number fraction

### 9.13.1 Principle

A total of 100 leukocytes are counted and the number of each type seen is recorded. The proportion of each type of leukocyte is reported as a decimal fraction.<sup>1</sup>

*Example:* neutrophils 0.56, lymphocytes 0.25, eosinophils 0.12, monocytes 0.06 and basophils 0.01.

The total of all the fractions should be 1. If the total leukocyte count is known, express the result in terms of the number concentration (i.e. number of cells per litre) rather than as a decimal fraction.

### 9.13.2 Materials

- Microscope
- Immersion oil
- Well-spread thin blood films stained with a Romanowsky stain (see section 9.10.3)
- Paper
- Pencil.

### 9.13.3 Microscopic examination

Using the  $\times 100$  oil-immersion objective, check that the leukocytes are evenly distributed.

In a badly spread film, the neutrophils may have collected at the end of the film.

To record the different types of leukocytes as they are counted, proceed as follows:

Draw up a table with:

- five vertical columns (N, E, B, L and M), and
- 10 horizontal lines (see Fig. 9.111).

When 10 strokes have been made in the first line, go on to the next. Thus, when the 10th line has been completed, you know that you have counted 100 leukocytes. Then add up the total for each vertical column.

These totals give the percentage of each type of leukocyte. The totals are turned into decimal fractions by placing a decimal point two digits to the left (in some cases this may necessitate the insertion of a zero). Thus 59 becomes 0.59, 8 becomes 0.08, 1 becomes 0.01, 28 becomes 0.28, etc., as in the last line of the illustration. These decimals are the number fractions of each type of leukocyte and are the results that are reported when SI units are used.

### Reference range

Table 9.12 shows the reference ranges for different age groups.

<sup>1</sup> In the traditional system, the leukocyte type number fractions are called the “differential leukocyte (or white cell) count”, and the proportion of each type is reported as a percentage (e.g. neutrophils 56%, lymphocytes 25%, eosinophils 12%, monocytes 6% and basophils 1% in the example given above).

	N	E	B	L	M
1					
2					
3					
4					
5					
6					
7					
8					
9					
10					
Total	59	8	1	28	4
Fraction	0.59	0.08	0.01	0.28	0.04

Fig. 9.111 Table for recording the different types of leukocytes  
N: neutrophils; E: eosinophils; B: basophils; L: lymphocytes; M: monocytes.

There are two main patterns of distribution of different types of leukocyte:

- One pattern shows a majority of *lymphocytes* (this type is seen in infants and children under 10 years).
- The other pattern shows a majority of *neutrophils* (seen in newborn infants, children over 10 years and adults).

Each type of leukocyte may be reported in terms of its number concentration (i.e. number of cells per litre) instead of as a number fraction. The number concentration is calculated by multiplying the number fraction of a particular type of leukocyte by the total leukocyte number concentration.

*Example:*

$$\text{leukocyte number concentration} = 5 \times 10^9/\text{l}$$

$$\text{neutrophil number fraction} = 0.42$$

$$\text{neutrophil number concentration} = 0.42 \times 5 \times 10^9 = 2.1 \times 10^9/\text{l}$$

#### Abnormal findings

- Neutrophilia is an increased proportion of neutrophils (above 0.65). It is particularly common in infections.
- Eosinophilia is an increased proportion of eosinophils (above 0.05). It almost always suggests a parasitic infection localized in the tissues (e.g. schistosomiasis, filariasis, hookworm, ascariasis). It can also be caused by allergies.

**Table 9.12 Normal leukocyte type number fractions, by age group**

Age group	Cell type <sup>a</sup>				
	Neutrophils	Eosinophils	Basophils	Lymphocytes	Monocytes
Newborn infants	0.55–0.65	0.02–0.04	0.00–0.01	0.30–0.35	0.03–0.06
Infants (up to 1 year, excluding newborns)	0.40–0.48	0.02–0.05	0.00–0.01	0.40–0.48	0.05–0.10
Infants (1–4 years)	0.36–0.48	0.02–0.05	0.00–0.01	0.44–0.54	0.03–0.06
Children (10 years)	0.45–0.55	0.02–0.05	0.00–0.01	0.38–0.45	0.03–0.06
Adults	0.55–0.65	0.02–0.04	0.00–0.01	0.25–0.35	0.03–0.06

<sup>a</sup>To obtain values in traditional units (i.e. as percentages), multiply each value by 100. The differential leukocyte count is calculated by multiplying the percentage of a particular type of leukocyte (e.g. neutrophils) by the total leukocyte count and dividing by 100.

*Example:*

$$\text{total leukocyte count} = 5000/\text{mm}^3$$

$$\text{percentage of neutrophils} = 42\%$$

$$\text{"absolute" neutrophil count} = (42 \times 5000)/100 = 2100/\text{mm}^3$$

- Lymphocytosis is an increased proportion of lymphocytes (above 0.35 in adults and above 0.45 in children). It is found in certain virus infections (e.g. measles), certain chronic infections (e.g. malaria, tuberculosis) and some toxic conditions.
- Monocytosis is an increased proportion of monocytes (above 0.06). It occurs in certain bacterial infections (e.g. typhoid fever, infectious mononucleosis) and certain parasitic infections (e.g. malaria, kala-azar (visceral leishmaniasis)).
- Neutropenia is a decreased number of neutrophils. It may occur in certain infections (e.g. sepsis) and some other diseases.
- Lymphopenia is a decreased number of lymphocytes and may occur in AIDS.

## 9.14 Determination of the thrombocyte number concentration

### 9.14.1 Materials

- Microscope
- Immersion oil
- Well-spread blood film stained with a Romanowsky stain (see section 9.10.3).

### 9.14.2 Microscopic examination

Using the  $\times 100$  oil-immersion objective, count the number of thrombocytes in 20 fields and make a rough estimate of the number of erythrocytes per field.

Calculate the ratio of thrombocytes to erythrocytes. If the erythrocyte number concentration (see section 9.5) is known, the thrombocyte count can be estimated. If not, a rough estimate of the thrombocyte count, either “normal”, “high” or “low”, can be based on a ratio of approximately one thrombocyte per 500–1000 erythrocytes being normal.

### Reference range

Table 9.13 shows the reference ranges for different age groups.

**Table 9.13 Normal thrombocyte counts, by age group**

Age group	Thrombocyte count (per $\text{mm}^3$ )
Infants (< 1 year)	$3.5\text{--}6.6 \times 10^5$
Children (1–15 years)	$2.5\text{--}5.1 \times 10^5$
Adults	$1.7\text{--}4.0 \times 10^5$

---

# 10. Blood chemistry



## 10.1 Estimation of glucose concentration in blood: *o*-toluidine method<sup>1</sup>

Estimates of the glucose (sugar) concentration in blood are required to help in the diagnosis of diabetes mellitus or any other condition in which there is abnormal carbohydrate metabolism in the body. In patients with diabetes glucose is usually found in the urine (see section 7.2.4).

### 10.1.1 Principle

The proteins are first precipitated by trichloroacetic acid. The glucose in the filtrate reacts with the *o*-toluidine reagent to give a green colour, which is measured using a photoelectric colorimeter.

### 10.1.2 Materials and reagents

- Colorimeter
- Conical centrifuge tubes and large test-tubes (to hold 20 ml)
- Test-tube racks
- Blood (Sahli) pipettes, 0.2 ml
- Pipettes, 0.5 ml, 5.0 ml
- Water-bath at 100 °C
- Glucose reagents (reagent no. 30)
  - trichloroacetic acid, 3% solution
  - *o*-toluidine reagent
  - benzoic acid, 0.1% solution
  - glucose stock reference solution (100 mmol/l)
  - glucose working reference solutions (2.5, 5.0, 10, 20 and 25 mmol/l)
- Whole blood (capillary or venous), plasma or serum, taken from a fasting patient<sup>2</sup>
- Control serum.

A control serum should be used with each batch of tests. If the result of the test with the control serum is correct, it can be assumed that the patient's results will also be correct.

### 10.1.3 Method

1. Pipette 1.8 ml of trichloroacetic acid solution into each of three centrifuge tubes.

*Note:* Trichloroacetic acid is corrosive. Use it with care.

---

<sup>1</sup> This method is also used for estimating the glucose concentration in CSF (see section 8.3.4).

<sup>2</sup> If venous blood is used, it is advisable to use fluoride oxalate (reagent no. 26) as the anticoagulant. This will prevent the glucose from being destroyed in the blood.

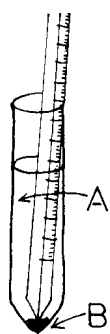

Fig. 10.1 Delivering blood under trichloroacetic acid solution using a blood pipette  
A: trichloroacetic acid solution; B: blood.

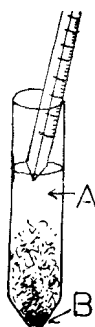

Fig. 10.2 Rinsing the blood pipette with trichloroacetic acid solution

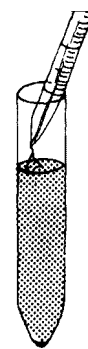

Fig. 10.3 Expelling trichloroacetic acid solution into a centrifuge tube

2. With a 0.2-ml blood pipette, deliver 0.2 ml of the blood<sup>1</sup> specimen to the *bottom* of the first centrifuge tube (B in Fig. 10.1) — i.e. *under* the trichloroacetic acid solution (A in Fig. 10.1). The trichloroacetic acid solution will become cloudy where it makes contact with the blood specimen.
3. Raise the pipette and draw clear trichloroacetic acid solution into it in order to wash out all traces of the blood specimen (Fig. 10.2).
4. Expel the trichloroacetic acid solution from the pipette into the centrifuge tube (Fig. 10.3).
5. Mix well (the entire solution will become cloudy) and allow to stand for 5 minutes.
6. Using a clean 0.2 ml blood pipette, deliver 0.2 ml of distilled water and 0.2 ml of glucose working reference solution to the second and third centrifuge tubes, respectively, as described in step 2. These tubes will be used to prepare the reagent blank and the glucose working reference standard, respectively.
7. Centrifuge the three tubes at 3000*g* for 5 minutes. The precipitated proteins in the tube containing the blood specimen will sediment and a clear supernatant fluid will be obtained.
8. Take three (or more if needed) large test-tubes and label as shown in Fig. 10.4:
  - blank tube (B)
  - reference tube (R)
  - patient tube (P).

*Note:* If more than one estimation is being carried out, label each of the P tubes with the name or number of the patient.

9. Pipette into each tube as follows:

- Blank:
  - 0.5 ml of fluid from the second centrifuge tube
  - 3.5 ml of *o*-toluidine reagent.
- Reference:
  - 0.5 ml of from the third centrifuge tube
  - 3.5 ml of *o*-toluidine reagent.
- Patient:
  - 0.5 ml of supernatant fluid from the first centrifuge tube
  - 3.5 ml of *o*-toluidine reagent.

*Note:* The *o*-toluidine reagent is corrosive.

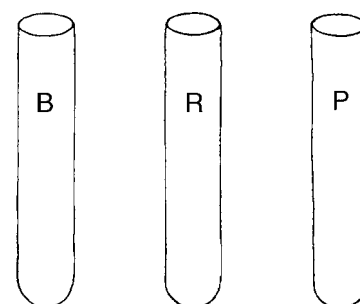

Fig. 10.4 Labelling test-tubes for the test  
B: blank tube;  
R: reference tube;  
P: patient tube.

<sup>1</sup> When this test is performed using CSF, the volume required in this step is greater (0.8 ml).

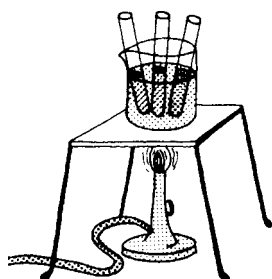

Fig. 10.5 Heating the test-tubes in a water-bath

10. Mix the contents of each tube. Place all the tubes in the water-bath at 100°C for exactly 12 minutes (Fig. 10.5).
11. Remove the tubes and allow them to cool in a beaker of cold water for 5 minutes.
12. Measure the colour produced in a colorimeter at a wavelength of 630 nm.
  - (a) Place the orange-red filter in the colorimeter.
  - (b) Fill the colorimeter tube or cuvette with the solution contained in the tube marked B (blank) and place in the colorimeter.
  - (c) Adjust the reading of the colorimeter to zero with the cuvette containing solution B in place.
  - (d) Pour solution B out of the cuvette, rinse the cuvette with a small amount of solution R (reference), pour this out, and fill the cuvette with solution R; place the cuvette in the colorimeter and read the absorbance,  $A_R$ .
  - (e) Pour solution R out of the cuvette, rinse the cuvette with a small amount of solution P (patient), pour this out, and fill the cuvette with solution P; place the cuvette in the colorimeter and read the absorbance,  $A_P$ .

### Calibration of the colorimeter

Before taking measurements, prepare a calibration graph using the different concentrations of the glucose working reference solution treated as described in steps 6–9. The graph should be linear up to the highest concentration and should pass through the origin. Prepare a new graph whenever the *o*-toluidine reagent is renewed, to confirm the linearity.

### 10.1.4 Results

#### Calculation

Calculate the concentration of glucose in the blood specimen using the following formula:<sup>1</sup>

$$\text{concentration of glucose in blood (mmol/l)} = (A_P / A_R) \times C$$

where:

$A_P$  = absorbance reading of the patient's specimen

$A_R$  = absorbance reading of the glucose working reference solution

$C$  = concentration of the glucose working reference solution.

*Note:* If a control serum has been included, make the calculation for that serum in exactly the same way, substituting  $A_c$  (absorbance of the control solution) for  $A_P$  in the formula.

#### Reference range

The reference ranges of glucose concentrations in the blood of fasting patients are shown in Table 10.1.

#### High and low values

If unusually high or low values are observed, the test should be repeated in order to confirm the results, as described below.

<sup>1</sup> The calculation given is for SI units. The formula for calculating blood glucose concentrations in traditional units is as follows:

$$\text{concentration of glucose (mg/100ml)} = \text{concentration of glucose (mmol/l)} \times 1/0.0555$$



**Table 10.1 Blood glucose concentrations in fasting patients**

Fluid	Glucose concentration	
	SI units (mmol/l)	Traditional units (mg/100ml)
Venous blood	3.3–5.5	60–100
Capillary blood	3.9–5.5	70–100
Serum	3.9–6.4	70–115
Plasma	3.9–6.4	70–115

***Glucose concentrations higher than 16.5 mmol/l***

Dilute solutions B (blank) and P (patient) with an equal volume of glacial acetic acid. Using diluted solution B in the cuvette, set the colorimeter reading to zero. Then read the absorbance  $A_p$  with diluted solution P in the cuvette. Recalculate the glucose concentration, using the new value of  $A_p$  and the value of  $A_R$  that was obtained previously. Multiply the result by two (because solution P has been diluted 1 in 2) to obtain the true glucose concentration.

***Glucose concentrations lower than 2.3 mmol/l***

Repeat the entire test. In step 1, use 1.6 ml of trichloroacetic acid solution (instead of 1.8 ml), and in step 2 use 0.4 ml of blood, serum or plasma (instead of 0.1 ml). Perform the test and calculate the result exactly as before. Divide the result by four to obtain the true glucose concentration.

**10.2 Estimation of urea concentration in blood: diacetyl monoxime/thiosemicarbazide method**

Urea is a waste product formed in the liver following the breakdown of protein. It passes into the blood, is filtered out by the kidneys and excreted in the urine.

If the kidneys do not remove urea, the concentration in the blood is increased. This can happen if the kidney tubules become damaged or if the volume of blood flowing through the kidneys is reduced.

**10.2.1 Principle**

The proteins are first precipitated by trichloroacetic acid. The urea in the filtrate reacts with diacetyl monoxime in the presence of acid, oxidizing reagent and thiosemicarbazide to give a red solution. The colour is measured using a photoelectric colorimeter.

**10.2.2 Materials and reagents**

- Colorimeter
- Conical tubes and test-tubes (to hold 20 ml)
- Pipettes, 50  $\mu$ l, 0.1 ml, 0.5 ml, 5 ml
- Measuring cylinder, 50 ml
- Water-bath at 100 °C
- Urea reagents (reagent no. 62):
  - trichloroacetic acid, 5% solution
  - diacetyl monoxime stock solution
  - colour reagent
  - urea stock reference solution (125 mmol/l)
  - urea working reference solution (10 mmol/l)
- Acid reagent (reagent no. 6)

- Blank reagent (reagent no. 11)
- Patient's blood (treated with EDTA dipotassium salt, 10% solution (reagent no. 22)), serum or plasma
- Control serum.

A control serum (of known concentration) should be used with each batch of tests. If the result of the test with the control serum is correct, it can be assumed that the patient's results will also be correct.

### 10.2.3 Method

1. Prepare the colour reagent immediately before use, using a 1:1 mixture of the diacetyl monoxime stock solution and acid reagent. Prepare at least 15 ml of colour reagent for each test.

Mix the colour reagent in a large test-tube or small flask.

2. Pipette into a conical centrifuge tube 50  $\mu$ l of whole blood (treated with EDTA dipotassium salt solution), serum or plasma.
3. Add 1 ml of trichloroacetic acid solution and mix.

Centrifuge at high speed (3000g) for 5 minutes to sediment the precipitated proteins and obtain a clear supernatant fluid.

4. Take three (or more if needed) large test-tubes and label as shown in Fig. 10.4:
  - blank tube (B)
  - reference tube (R)
  - patient tube (P).

*Note:* If more than one estimation is being carried out, label each of the P tubes with the name or number of the patient.

5. Pipette into each tube as follows:

- Blank:
  - 0.1 ml of blank reagent
  - 3.0 ml of freshly prepared colour reagent.
- Reference:
  - 0.1 ml of working reference solution
  - 3.0 ml of freshly prepared colour reagent.
- Patient:
  - 0.1 ml of supernatant fluid
  - 3.0 ml of freshly prepared colour reagent.

6. Mix the contents of each tube. Place all the tubes in the water-bath at 100°C for 15 minutes (see Fig. 10.5) to allow the red colour to develop.
7. Remove the tubes and place them in a beaker of cold water until they have cooled to room temperature.
8. Measure the colour produced in a colorimeter at a wavelength of 520 nm.
  - (a) Place the green filter in the colorimeter.
  - (b) Fill the colorimeter test-tube or cuvette with the solution contained in the tube marked B (blank) and place in the colorimeter.
  - (c) Adjust the reading of the colorimeter to zero with the cuvette containing solution B in place.
  - (d) Pour solution B out of the cuvette, rinse the cuvette with a small amount of working reference solution R (reference), pour this out, and fill the cuvette with solution R; place the cuvette in the colorimeter and read the absorbance,  $A_R$ .
  - (e) Pour solution R out of the cuvette, rinse the cuvette with a small amount of solution P (patient), pour this out, and fill the cuvette with solution P; place the cuvette in the colorimeter and read the absorbance,  $A_P$ .

### 10.2.4 Results

#### Calculation

Calculate the concentration of urea in the blood as follows:<sup>1</sup>

$$\text{urea concentration (mmol/l)} = \left( A_p / A_r \right) \times C$$

where:

$A_p$  = absorbance reading of patient's specimen

$A_r$  = absorbance reading of urea working reference standard

$C$  = concentration of working reference standard (10 mmol/l).

#### Reference range

The reference range of urea concentrations in blood is approximately 3–7 mmol/l (18–42 mg/100 ml).

#### High values

If a value greater than 25 mmol/l (150 mg/100 ml) is obtained, repeat the entire test, using 0.1 ml of whole blood (treated with EDTA dipotassium salt solution), serum or plasma in step 2. Perform the test and calculate the results exactly as before, but divide the result by two to obtain the true urea concentration.

---

<sup>1</sup> The calculation given is for SI units. The formula for calculating blood urea concentrations in traditional units is as follows:

$$\text{urea concentration (mg/100ml)} = \text{urea concentration (mmol/l)} \times 1/0.167$$

---

# 11. Immunological and serological techniques



Many of the diagnostic techniques applied in immunology are based on the fact that antigens and antibodies interact. Most infectious diseases are diagnosed by isolating and identifying the infectious microorganism in a specimen from the patient. In some cases microorganisms are difficult to culture and isolate or may require special and often expensive techniques that are not available for routine diagnosis. In other immunological disorders there is no microorganism per se to identify or isolate. There are also some “naturally” occurring immune diseases, often classified as autoimmune diseases, which are not caused by a microorganism but can be detected by some of the diagnostic techniques applied in immunology. Several of these techniques detect specific metabolic products or specific antibodies and antigens. In those disease states where a microorganism is involved, these immunology tests do not detect the microorganism directly, but provide evidence of its presence.

A number of diagnostic techniques based on biological reactions using antigen-antibody interactions are described. It is beyond the scope of this manual to go into detail about the immune system. The aim here is to introduce some terminology and general concepts of the immune system, which will help in understanding some of the immunological techniques described. Note that various approaches are available for different diagnostic purposes; the choice should be based upon the question asked and the availability of facilities. The diagnostic techniques described here are those most frequently used as an aid in the diagnosis of certain diseases that cause an immunological reaction.

## 11.1 Introduction to immunology

The role of the immune system is defence. The immune system has both non-specific and specific mechanisms to recognize and respond accordingly to foreign and potentially pathogenic microorganisms. The non-specific defences are physical or mechanical barriers, for example, the skin and mucous membranes. These barriers are there to prevent entry of pathogens into the body. These barriers usually work very well, but some pathogens do manage to enter the body where they are immediately destroyed by phagocytic cells such as macrophages.

When pathogenic microorganisms enter the body the specific defence mechanisms are activated. The specific mechanisms are divided into the humoral (antibody-mediated) and the cell-mediated systems. The humoral system is associated with cells known as B-lymphocytes, which are the precursors of plasma cells. Plasma cells produce and secrete protein substances known as antibodies or immunoglobulins. The cell-mediated system is associated with T-lymphocytes which can process and destroy foreign bodies.

### 11.1.1 Antibodies

Antibodies are found in serum, milk, saliva, tears, urine and other body fluids. In neonates, antibody production is virtually absent and protection is provided by maternal antibodies mainly through breast milk and those that cross the placenta. A growing infant is constantly exposed to various environmental antigens which

promote production of antibodies. In humans there are five major classes of antibodies or immunoglobulins: IgG, IgM, IgA, IgE and IgD.

These proteins differ in their electrophoretic mobility, relative molecular mass, antigenic structure, sedimentation coefficient, shape and other properties. All the immunoglobulins have a structure composed of four polypeptide chains with two long or heavy (H) chains and two short or light (L) chains (Fig. 11.1).

Within these H and L chains there are regions known as constant regions, where amino acid sequences are very similar, and variable regions (usually at the ends of the chains), where amino acid sequences are highly variable. The variable regions give the different antibodies their specificity.

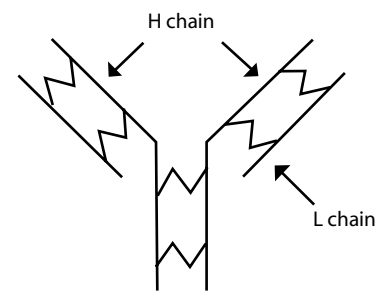

Fig. 11.1 Structure of immunoglobulins

### 11.1.2 Antigens

Antigens are molecules (usually proteins) that can elicit an immune response. Antigens have sites on them known as antigenic determinants which can be recognized by antibodies. Antigens may have several determinants of different configuration or several of the same configuration such that antibodies of the same kind or of several different kinds can bind to these sites.

Several properties can influence the immunogenicity of an antigen; these are briefly discussed below.

#### Recognition of the antigen as a foreign substance

The most important property of an antigen is that which allows the body to recognize the substance as foreign. An individual's immune system is normally capable of distinguishing substances belonging to the body from those that do not (self from non-self). Certain conditions incapacitate the self-tolerance mechanism and the system starts to react against itself.

#### Relative molecular mass

The relative molecular mass or size of an antigen also affects its immunogenicity. As a general rule, large molecules make good antigens (i.e. they are effective in generating an immune response), provided they are foreign to the body. Small molecules are usually poor antigens.

#### Complexity

The more complex the molecule, the better the immune response to the antigen. Complex proteins make "better" antigens than repeating polymers of lipids, carbohydrates and nucleic acids.

#### Stability

It is essential for the antigen to be stable for it to be recognized by the immune system.

#### Degradability

The substance must be degradable. In order to initiate an immune response the immune system must be able to process the substance.

#### Route of antigen administration and dosage

Antigens must be administered correctly. Some substances elicit an immune response if administered subcutaneously, but not if administered intravenously. The

right dose is also important since too much or too little antigen may not elicit the desired immune response.

### 11.1.3 Antigen–antibody interactions

The binding between an antigen and an antibody can be compared with the exclusive fit that exists between a lock and its key. The antigen determinant (the “lock”) has a predetermined conformation and only a specific antibody (the “key”) with the appropriate variable regions (grooves and contours) will give a perfect fit. However, the situation is not always so clear-cut. Sometimes an antigen will combine (poorly) with an antibody that was produced against a different antigen, causing cross-reactivity. To avoid these unwanted interactions, it is important to know and define the analytical sensitivity and specificity of immunological tests based on antibody–antigen reactions.

The analytical sensitivity of an immunological test refers to its ability to detect small quantities of antigen or antibody. It is used as a synonym for the limit of detection. The analytical specificity of an immunological test is its ability to measure only the substance it purports to measure.<sup>1</sup> These are important considerations, especially when choosing a new test. Others include: applicability in a given laboratory environment, cost, availability, level of expertise required, speed and simplicity.

## 11.2 Principle of immunochemical techniques

Antigen–antibody reactions can be classified into three groups: primary, secondary and tertiary binding reactions. Only primary and secondary binding reactions are described here. Tertiary reactions follow secondary reactions and usually occur *in vivo*.

### 11.2.1 Primary binding tests

This group of tests provides a direct measure of the initial binding reaction between an antigen and an antibody. This is a very sensitive approach for which a label is needed to detect the binding reaction. Such tests include radioimmunoassays, enzyme immunoassays and immunofluorescence assays.

#### Radioimmunoassay

In a radioimmunoassay, either an antigen or an antibody is conjugated with a radioactive tracer substance and the radioactivity is measured with a scintillation counter (Fig. 11.2). This type of assay is becoming less common, partly because of the need for radioactive substances and also because the measuring equipment required is difficult to use.

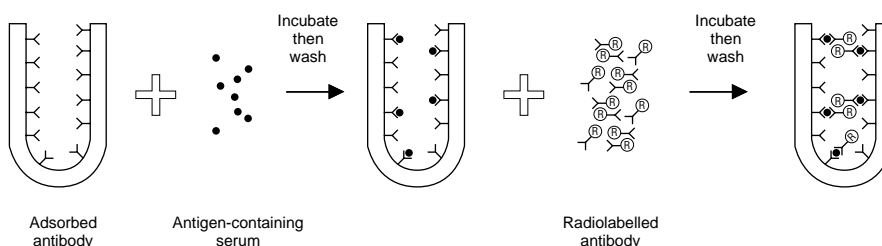

Fig. 11.2 Principle of radioimmunoassays

<sup>1</sup> The analytical sensitivity and specificity of an immunological test must not be confused with the diagnostic sensitivity and specificity as defined to discriminate between diseased and non-diseased populations.

### Enzyme immunoassay

In an enzyme immunoassay, an antigen or antibody is conjugated with a labelled enzyme and a colour change is produced by the enzyme reacting with its substrate. This change can be detected visually or with a spectrophotometer. The binding event can be either competitive or non-competitive. Competitive binding depends on competition between a labelled (known amount) and an unlabelled (unknown amount) antigen for the same antibody (when measuring antigen) or between a labelled (known amount) and an unlabelled (unknown amount) antibody for the same antigen (when measuring antibody) (Fig. 11.3). The amount of binding of the labelled antigen (or antibody) is related to the amount of unlabelled antigen (or antibody) present.

In non-competitive binding (sandwich technique), the antigen or antibody is adsorbed (or immobilized) to a solid phase, which may be an insoluble particle (bead) or the sides of a test-tube or the bottom of a microtitre plate. The test sample containing the corresponding antibody or antigen is then added. A labelled antibody or antigen (conjugate) is added last to form the top layer of the sandwich (Fig. 11.4). When testing for an antibody, the conjugate would contain anti-immunoglobulin and when testing for an antigen, the conjugate would contain an antibody specific for that antigen. The amount of binding of the conjugate is directly related to the amount of antigen or antibody in the test sample and only the bound portion is measured in this assay.

An example of this technique is the enzyme-linked immunosorbent assay (ELISA). The enzymes used in ELISAs include horseradish peroxidase, alkaline phosphatase, lysozyme and  $\beta$ -galactosidase.

The enzyme immunoassays are replacing many radioimmunoassays because of their advantages over the latter, which include longer reagent shelf-life, cheaper and simpler equipment, no restrictive regulations for reagent disposal, and safer reagents.

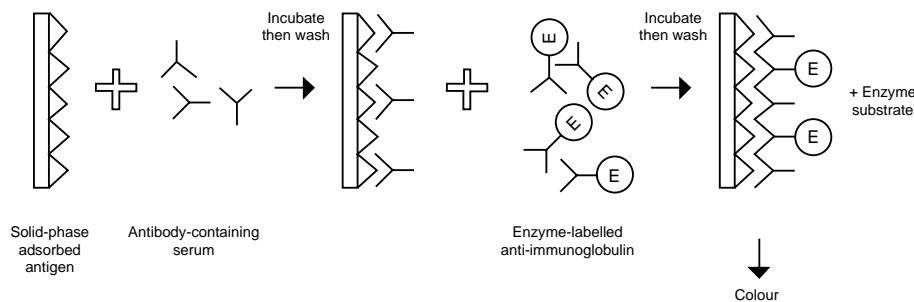

Fig. 11.3 Principle of competitive enzyme immunoassays

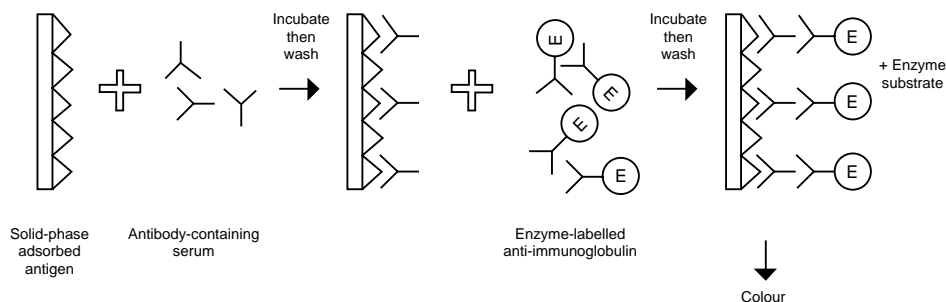

Fig. 11.4 Principle of non-competitive enzyme immunoassays

## Immunofluorescence

Fluorescent dyes such as fluorescein isothiocyanate and tetra-methylrhodamine isothiocyanate can be coupled to antibodies without destroying their specificity. Fluorescence occurs when molecules that have been excited to a higher energy state return to their normal energy state. The excess energy is released in the form of light. A fluorescent microscope, which is a modified light microscope, is used to visualize the light emitted.

Two types of immunofluorescence technique can be used.

### *Direct immunofluorescence*

Direct immunofluorescence is used when testing for an antigen. In this technique a fluorescent dye is linked to the isolated portion of an antiserum containing antibodies directed against a specific component of cells or tissue. The antiserum is applied directly to the tissue specimen. The antigen and antibody react, then the tissue specimen is washed.

The tissue specimen is examined under the microscope and fluorescence is seen where the antibody is attached to the antigen (Fig. 11.5).

### *Indirect immunofluorescence*

Indirect immunofluorescence is used to determine whether antibodies are present in a patient's serum. The serum is applied directly to an appropriate tissue specimen containing an antigen directed against the specific antibody under investigation. The antigen and antibody react, then the tissue specimen is washed. An anti-immunoglobulin with a fluorescent label is added and the tissue specimen is then incubated before being washed again.

The labelled anti-immunoglobulin will attach to any antibody already bound to the antigen in the tissue specimen and shows up under the microscope as areas of fluorescence (Fig. 11.6). The indirect method is more sensitive than the direct method because it is amplified in the sense that each unlabelled antibody can be bound by two labelled antibodies.

## 11.2.2 Secondary binding tests

The secondary binding tests enable visible manifestations following the primary reaction to be observed. In these tests one can actually see the effects of the binding event without the aid of an additional label. These tests include agglutination, precipitation, complement-dependent reactions and neutralization methods. The agglutination and precipitation methods are routinely employed for diagnostic purposes. These methods are briefly described below.

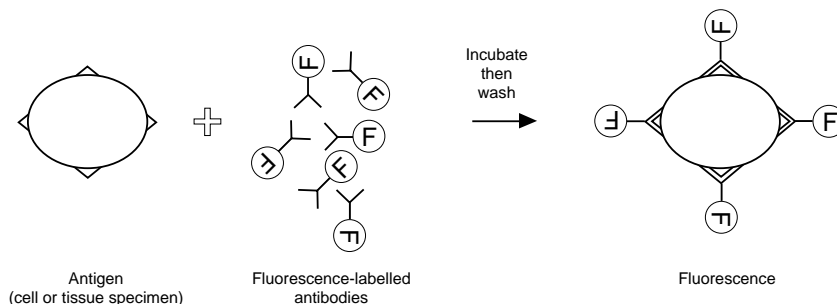

Fig. 11.5 Principle of direct immunofluorescence



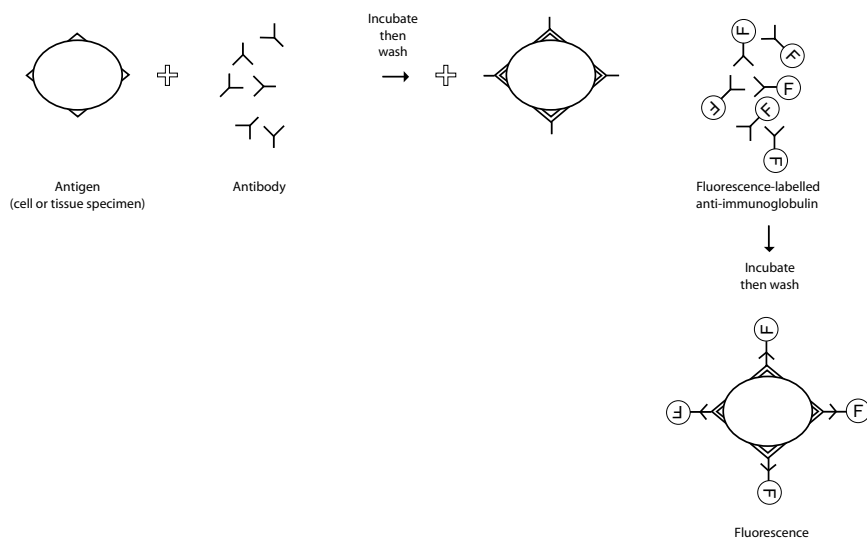

Fig. 11.6 Principle of indirect immunofluorescence

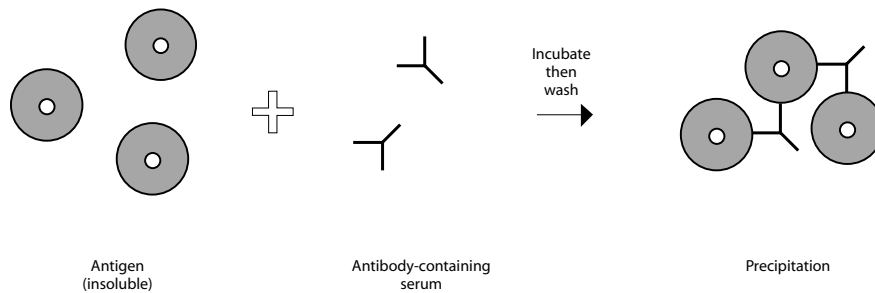

Fig. 11.7 Principle of agglutination

### Agglutination

Agglutination involves the reaction of an antibody with a particulate (insoluble) antigen leading to visible clumping of these particles (Fig. 11.7). The interaction of surface antigens and antibodies directed against them leads to cross-linking of adjacent particles, e.g. bacteria, to form a lattice of agglutinated cells.

#### *Active agglutination (direct)*

Active agglutination involves antigenic determinants that are an intrinsic constituent of the particle, e.g. haemagglutination reactions used for blood grouping.

#### *Passive agglutination (indirect)*

Passive agglutination involves antigenic determinants that are not an intrinsic constituent of the particle. A soluble antigen is combined with insoluble particles such as erythrocytes. The erythrocytes are usually treated with tannic acid, which alters their surface properties so that the antigen can bind firmly. Other insoluble particles include bacteria, charcoal, bentonite (clay) and polyvinyl latex where the antigen is simply adsorbed.

Semi-quantitative titrations can be carried out to determine the amount of antibody present in a sample. A constant volume of suspended particles (antigen) is added to a constant volume of serially diluted antiserum. The presence of antibody in the serum causes agglutination of the particles (Fig. 11.8) and the reaction is usually scored on a scale of 0 to 4+. The antibody content is expressed as a titre —

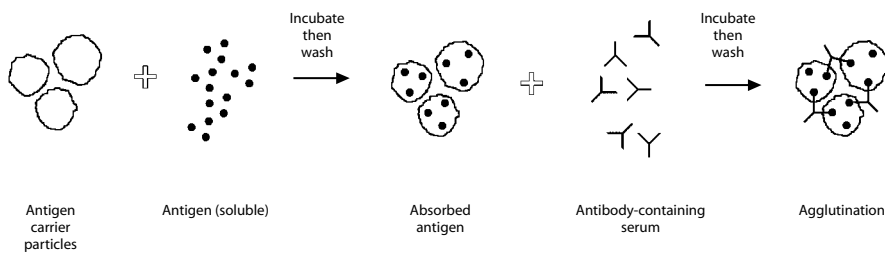

Fig. 11.8 Principle of passive agglutination

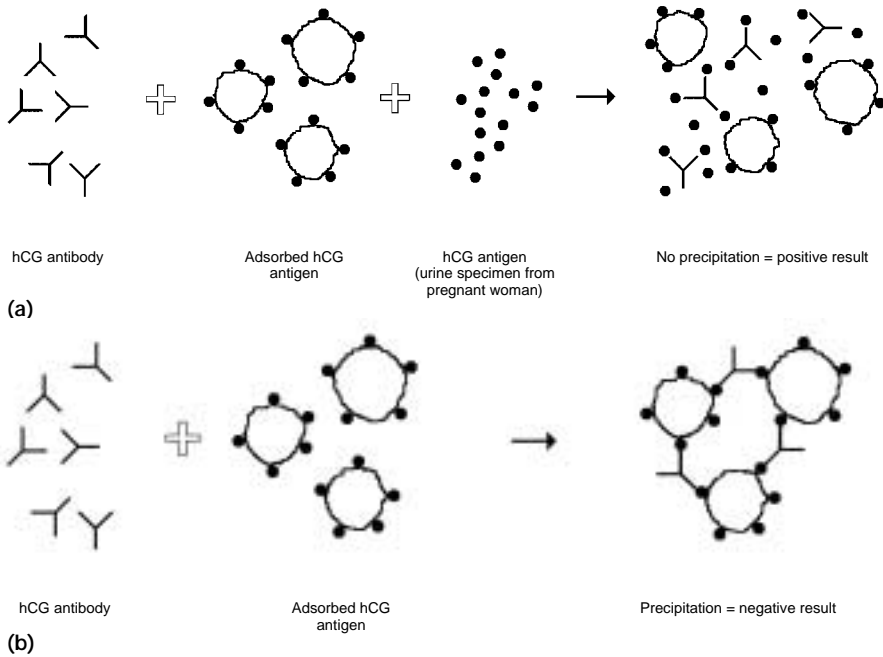

Fig. 11.9 Principle of the agglutination inhibition test for hCG

the reciprocal of the final dilution of antiserum capable of producing visible agglutination.

### Agglutination inhibition

Agglutination inhibition is used for determining the presence of antigen. This assay is based on competition between particulate and soluble antigen for antibody-binding sites. The antibody and the test sample are allowed to react together. If soluble antigen is present in the sample, the antibody reacts with it and is not free to react further after the subsequent addition of indicator particles or cells. Thus, the absence of agglutination with a specimen under investigation indicates a positive test result. An example of this kind of assay is the detection of human chorionic gonadotropin (hCG) used in the test for confirmation of pregnancy and also in other pathological conditions where hCG levels are important (Fig. 11.9).

### Precipitation

Unlike agglutination reactions in which the antigen is particulate (insoluble), in precipitation reactions the interaction is between a soluble antibody and a soluble antigen. If a soluble antibody is incubated with a soluble antigen, antibody and antigen complexes cross-link and form a precipitate. Precipitation methods can be quantitative or qualitative and the interactions are dependent on ionic strength, pH and concentration.

A quantitative precipitin curve can be drawn in which the proportion of antigen and antibody determines the extent of cross-linking and precipitation. The curve shows the following features (Fig. 11.10):

- The equivalence zone in which the proportions of antigen and antibody are equivalent.
- The excess antibody zone in which all available antigenic determinants are bound by individual antibody molecules, leaving some antibody molecules unbound.
- The excess antigen zone in which all the antigen binding sites of an antibody are bound by individual antigen molecules, leaving some molecules of antigen unbound.

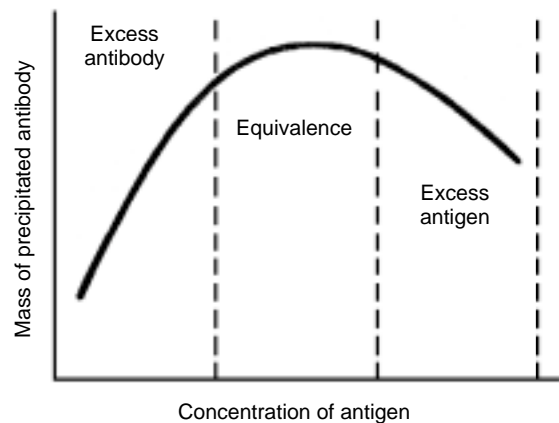

Fig. 11.10 A quantitative precipitin curve

Several other immunological techniques employ the precipitation reaction in one form or another. These include nephelometry, turbidimetry, radial immunodiffusion (Mancini technique), double diffusion (Ouchterlony) and some immunoelectrophoresis techniques.

### Nephelometry and turbidimetry

Nephelometry and turbidimetry involve the measurement of the light scattering and light absorption properties, respectively, of antigen–antibody complexes. These techniques are used to measure concentrations of proteins and drugs in serum or CSF. The assays are rapid and sensitive. A constant, excessive amount of antibody is incubated with an antigen in a cuvette.

In nephelometry light is passed through the cuvette and the scatter produced by the antigen–antibody complexes that have been formed is measured.

The antigen concentration is determined from a standard curve made by measuring the light scatter produced by a series of antigen solutions of known concentrations. In some assays, polymers are added to accelerate the formation of antigen–antibody complexes.

In turbidimetry light is passed through the cuvette and the absorption produced by the antigen–antibody complexes that have been formed is measured. A conventional photometer can be used for this purpose.

### Radial immunodiffusion (Mancini technique)

Radial immunodiffusion is based on the principle that a quantitative relationship exists between the amount of antigen placed in a well cut in an agarose gel containing antibody and the diameter of the resulting ring of precipitate. The antigen concentration is proportional to the square of the diameter of the ring of precipitate. The concentration of unknown samples is calculated with the aid of a standard curve which is prepared by plotting the diameter<sup>2</sup> of the resulting ring of precipitate produced by a series of antigen solutions of known concentration (Fig. 11.11). This technique can be used for the quantitative measurement of complement factors and immunoglobulins.

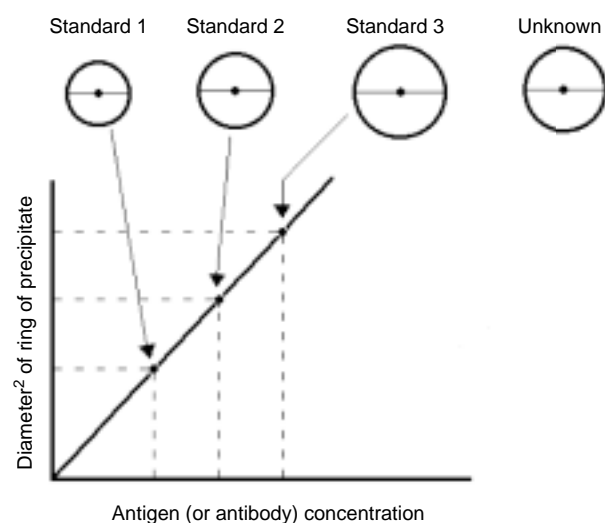

Fig. 11.11 Principle of radial immunodiffusion

### 11.3 Determination of rheumatoid factors by the latex-agglutination technique

#### 11.3.1 Materials and reagents

- Test plates (preferably with a dark background)
- Stirring rods, wooden orange sticks or rotator
- Test-tubes, 5 ml
- Test-tube rack
- Micropipettes
- Latex rheumatoid factor (RF) reagent (aqueous suspension of latex particles coated with human IgG)
- Negative and positive control sera
- Sodium chloride, 0.85% solution (reagent no. 53).

The above-mentioned materials and reagents are usually supplied as part of a commercial test kit.

#### 11.3.2 Method

1. Bring the test and control sera and latex RF reagent to room temperature.
  2. Dilute the test and control sera 1 : 5 with sodium chloride solution.
  3. Apply one drop of each dilution to the test plates.
  4. Shake the vial of latex RF reagent and add one drop to each of the samples on the test plates.
  5. Mix well with stirring rods or orange sticks (one for each sample) and rotate the plates gently (about 10 times), or place on a rotator.
  6. After 2 minutes, examine the plates and compare the reactions of the test sera with those of the control sera (Fig. 11.12).
  7. If any sera are positive, repeat steps 3–6, using a twofold dilution.
- The highest dilution of serum that causes agglutination is the titre.

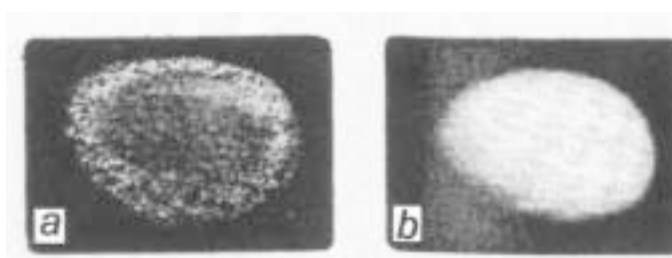

Fig. 11.12 Latex agglutination test  
a: Positive result; b: negative result.

### 11.4 Tests for the determination of anti-streptolysin O antibodies

#### 11.4.1 Anti-streptolysin O test (ASOT)

Streptolysin O is a toxin produced by haemolytic streptococci. The anti-streptolysin O test (ASOT) is the most commonly used laboratory test for following a streptococcal infection and its sequelae (rheumatic fever and acute post-streptococcal glomerulonephritis). Other approaches are now available, but the “standard” ASOT is based on the fact that streptolysin O will lyse human or sheep erythrocytes unless neutralized by anti-streptolysin O antibodies present in the patient’s serum.

One streptolysin O unit is the minimum amount of streptolysin O that will lyse 0.5 ml of a freshly prepared 5% suspension of sheep erythrocytes when incubated for 1 hour at 37°C. One Todd unit is defined as the amount of anti-streptolysin O antibody that will neutralize 0.5 streptolysin O units.

### Principle

The test is performed by incubating a constant amount of standardized streptolysin O with serial dilutions of heat-inactivated patient's serum (containing anti-streptolysin O antibodies) at 37°C for 15 minutes. A freshly prepared suspension of 5% sheep erythrocytes is then added to all the tubes and incubation is continued for a further 45 minutes. After centrifugation at 500g, the highest dilution of patient's serum that still has a clear supernatant (no haemolysis) is the end-point and its Todd unit value (reciprocal of the dilution) is reported. This technique is rather time-consuming and simpler and more rapid methods using latex agglutination are now available (see section 11.4.2).

### Materials and reagents

- Volumetric flask, 1000 ml
- Test-tubes, 75 mm × 12 mm
- Test-tube racks
- Serological pipettes
- Water-bath
- Centrifuge
- Phosphate-buffered water, pH 6.8 (reagent no. 43)
- Sodium chloride, 0.85% solution (reagent no. 53)
- 5% Suspension of washed sheep erythrocytes in sodium chloride, 0.85% solution (reagent no. 53)
- Reduced streptolysin O (instructions for the preparation of reduced streptolysin O from the unreduced form are usually provided by the manufacturer).

### Method

1. Make three dilutions of the patient's serum (inactivated by heating at 56°C for 30 minutes) as follows:

0.5 ml of serum + 4.5 ml of phosphate buffer = 1 : 10

0.5 ml of 1 : 10 serum + 4.5 ml of phosphate buffer = 1 : 100

1 ml of 1 : 100 serum + 4 ml of phosphate buffer = 1 : 500

2. From these master dilutions, make an extended series of dilutions as shown in Table 11.1. For screening purposes, use only the first seven tubes and the control tubes (13 and 14).
3. Add 0.5 ml (equivalent to 1 International Unit (IU)) of reduced streptolysin O to all the tubes except tube 13. Mix and incubate in a water-bath at 37°C for 15 minutes.
4. Add 0.5 ml of the 5% suspension of sheep erythrocytes to each tube. Mix and incubate in a water-bath at 37°C for 45 minutes, mixing again after the first 15 minutes of incubation.
5. Centrifuge the tubes gently at 500g for 3 minutes and observe for haemolysis.

The end-point is the last tube (i.e. the highest dilution) showing no haemolysis. Control tube 13 should show no haemolysis. If there is haemolysis in this tube the test should be repeated. Control tube 14 should show complete haemolysis.

**Table 11.1 Preparation of dilution series for the anti-streptolysin O test**

Tube number	Volume of patient's serum (inactivated) (ml), diluted:			Volume of streptolysin O buffer (ml)	Resulting serum dilution	Volume of reduced streptolysin O buffer (ml)	Volume of 5% suspension of sheep erythrocytes
	1:10	1:100	1:500				
1	0.8	—	—	0.2	1:12.5	0.5	0.5
2	0.2	—	—	0.8	1:50	0.5	0.5
3	—	1.0	—	0.0	1:100	0.5	0.5
4	—	0.8	—	0.2	1:125	0.5	0.5
5	—	0.6	—	0.4	1:167	0.5	0.5
6	—	0.4	—	0.6	1:250	0.5	0.5
7	—	0.3	—	0.7	1:333	0.5	0.5
8	—	—	1.0	0.0	1:500	0.5	0.5
9	—	—	0.8	0.2	1:625	0.5	0.5
10	—	—	0.6	0.4	1:833	0.5	0.5
11	—	—	0.4	0.6	1:1250	0.5	0.5
12	—	—	0.2	0.8	1:2500	0.5	0.5
13	—	—	—	1.5	control	0.0	0.5
14	—	—	—	1.0	control	0.5	0.5

### 11.4.2 Latex agglutination

#### Materials and reagents

- Test plates
- Stirring rods, wooden sticks or rotator
- Test-tubes, 5 ml
- Test-tube rack
- Micropipettes, 50 µl
- Anti-streptolysin O latex reagent: suspension of latex particles coated with streptolysin O
- Negative control serum
- Positive control sera (strongly and weakly positive)
- Sodium chloride, 0.85% solution (reagent no. 53).

#### Method

1. Bring the reagents and test and control sera to room temperature.
2. Apply one drop of each of the test and control sera to the test plates.
3. Shake the anti-streptolysin O latex reagent to mix; add one drop to each of the test and control sera.
4. Mix well with stirring rods or wooden sticks (one per sample) and rotate the plates gently about 10 times, or place on a rotator.
5. After 2 minutes, examine the plates and compare the reactions of the test sera with those of the controls. A positive reaction is indicated by the presence of agglutination. A negative reaction is indicated by the absence of agglutination.
6. If any sera are positive, repeat steps 2–5, using a twofold dilution.

The highest dilution that causes agglutination is the titre. Most anti-streptolysin O reagents have a detection limit (e.g. 200 IU/ml) that is usually multiplied by the dilution factor to give the serum concentration of anti-streptolysin O in IU/ml.

## 11.5 Determination of $\beta$ -human chorionic gonadotropin ( $\beta$ -hCG) in urine by the agglutination inhibition technique

### 11.5.1 Materials and reagents

- Test plates
- Stirring rods, wooden sticks or rotator
- Test-tubes, 75 mm  $\times$  12 mm
- Test-tube rack
- Anti- $\beta$ -human chorionic gonadotropin (anti- $\beta$ -hCG) antibody
- Latex hCG reagent (suspension of latex particles coated with hCG)
- Negative control
- Positive controls (strongly and weakly positive).

The above-mentioned reagents are usually supplied as part of a commercial test kit.

### 11.5.2 Method

1. Bring the urine samples and reagents to room temperature.
2. Add one drop of each of the urine samples and each of the controls to the test plates.
3. Add one drop of anti- $\beta$ -hCG antibody to each of the samples and each of the controls. Mix carefully.
4. Mix the latex hCG reagent suspension well; apply one drop to the test samples and rotate the plates or mix with stirring rods or wooden sticks (one per sample).
5. After 3 minutes examine the plates and compare the reactions of the test samples with those of the controls.

A positive reaction (pregnant or  $\beta$ -hCG present) is indicated by the absence of agglutination. A negative reaction (non-pregnant or  $\beta$ -hCG absent) is indicated by the presence of agglutination.

### Semi-quantitative analysis

Semi-quantitative analysis may be desirable in some cases where the production of  $\beta$ -hCG may have a pathological cause. This may occur in both pregnant and non-pregnant patients.

Make a twofold dilution of the positive urine samples and examine as described in steps 2–5 above. The highest dilution that does not cause agglutination is the titre.

The results for this semi-quantitative analysis are reported in IU/ml which can be obtained by multiplying the dilution factor of the highest dilution that does not cause agglutination by the sensitivity or limit of detection of the method, as stated by the manufacturer.

## 11.6 Quantitative determination of IgA, IgG and IgM by radial immunodiffusion

### 11.6.1 Materials and reagents

- Siliconized glass plates 8 cm  $\times$  12 cm, or Petri dishes (glass or plastic)
- Boxes with tightly fitting lids
- Hole-punch with inner diameter of 2 mm

- Pipettes, 5 µl
- Water-bath
- Thermometer
- Test-tubes
- Test-tube racks
- Agar, 3% solution in distilled water
- Sodium chloride, 0.15 mol/l with 0.1% sodium azide
- Agarose or agar
- Anti-human IgA antiserum
- Anti-human IgG antiserum
- Anti-human IgM antiserum
- Human standard serum containing:
  - IgA 2.0 mg/ml (123 IU/ml)
  - IgG 9.5 mg/ml (110 IU/ml)
  - IgM 0.96 mg/ml (111 IU/ml).

The above-mentioned reagents are usually supplied as part of a commercial test kit.

### 11.6.2 Method

1. Coat as many glass plates (or Petri dishes) as necessary (allowing one per patient) with agar, 3% solution.
2. Calculate the exact volume of 1% agarose gel that needs to be prepared to cover all the plates with gel to a thickness of 1.5 mm. The formula for calculating this is as follows:

$$\frac{\pi d^2}{4} \times 0.15$$

where  $d$  is the diameter of the plate (in cm).

3. Prepare 40 ml of 1% agarose in 0.15 mol/l sodium chloride with 0.1% sodium azide. Dissolve the agarose by placing it in the water-bath at 100 °C. When the suspension is clear, allow it to cool to 56 °C.
4. Warm the antisera to 56 °C in the water-bath.
5. Add 0.1 ml of anti-human IgA antiserum to each 10 ml of the agarose solution. Mix thoroughly.
6. Pour on to each glass plate (or Petri dish) the exact volume of the agarose-antiserum mixture needed to make a gel with a thickness of 1.5 mm and allow it to solidify at room temperature.
7. Prepare two more agarose gels in the same way: the first with 0.2 ml of anti-human IgG antiserum per 10 ml of agarose solution and the second with 0.13 ml of anti-human IgM antiserum per 10 ml of agarose solution.
8. Punch holes of 2-mm diameter in the gels.
9. Prepare twofold dilutions of the standard serum in 0.15 mol/l sodium chloride, as follows, for the determination of:
  - IgA: 1:8, 1:16, 1:32, 1:64 and 1:128.
  - IgG: 1:20, 1:40, 1:80, 1:160 and 1:320.
  - IgM: undiluted, 1:2, 1:4, 1:8 and 1:16.
10. Prepare 1:2, 1:16 and 1:40 dilutions of the patients' sera in 0.15 mol/l sodium chloride for the determination of IgM, IgA and IgG, respectively.



11. Pipette 5  $\mu$ l of each of the dilutions of the standard serum and the patients' sera into different holes of the appropriate agarose gels (see steps 6 and 7).
12. Place the plates in tightly closed boxes in a humid atmosphere and incubate them for 3 days at room temperature.
13. Measure the diameter of the rings of precipitate (in millimetres) using a ruler.
14. Make plots of the titrations of the standard serum. On the *x*-axis plot the square of diameter of the rings of precipitate, and on the *y*-axis plot the concentrations of the standard serum (see Fig. 11.11).
15. Use these curves to read the concentration of IgA, IgG and IgM in the patients' sera.

## 11.7 Tests for the determination of HIV antibodies

### 11.7.1 ELISA

#### Materials and reagents

- Micropipettes
- Incubator or water-bath at 37°C
- Washer or vacuum pump
- Spectrophotometer (reader)
- Distilled or deionized water
- ELISA test kit (commercially available)
- Solid-phase support system, reagents and controls.

#### Method

Each kit comes with its own instructions which should be followed carefully. However, the general steps are as outlined below.

1. Add the test (serum) sample and controls to the antigen-precoated solid-phase support system and incubate at the specified temperature for the appropriate time.
2. Carefully aspirate the sample from the solid-phase system and wash to remove excess sample and other proteins. The washing should not remove the HIV antibodies that have attached to the solid phase during incubation.
3. Add the indicated amount of conjugate (enzyme-linked anti-human (usually goat) IgG) and incubate according to the manufacturer's instructions.
4. Carefully aspirate the liquid again to remove any unbound conjugate and wash the solid-phase system.
5. Add the appropriate quantity of substrate and incubate according to the manufacturer's instructions. This is the colour development stage and should be protected from light.
6. At the end of the incubation period, add the stopping solution. The stopping solution inhibits any further reaction between the enzyme and the substrate.
7. Read the results in a spectrophotometer at the recommended wavelength.
8. Calculate the cut-off values for each test run according to the manufacturer's instructions.
9. If borderline results are obtained, repeat the test in case there have been technical errors. If borderline results are still obtained, examine the sample using a western blot. Alternatively, repeat the test using a different ELISA and/or a rapid test system (see section 11.7.2).

A test run is invalid if the positive control values are less than the calculated cut-off values. In such cases, the test run must be repeated.

*Note:* Criteria for testing samples using a western blot vary from laboratory to laboratory. Some laboratories test all samples that give a positive reaction in the ELISA. In some cases a specific request may be made for a western blot even if the ELISA was non-reactive.

### 11.7.2 Dipstick test

#### Principle

Dipstick tests were developed for the rapid detection of antigens and antibodies in human serum. These tests are generally employed in situations where quick decisions may need to be taken and often require no equipment other than that provided in the kits.

In the dipstick test for HIV antibody, which is commercially available, a polystyrene strip is coated with HIV antigen and allowed to react with serum. Any HIV antibody present will then bind to the HIV antigen. After subsequent incubation with a substrate solution, a coloured spot that indicates the presence of HIV antibody will develop (Fig. 11.13).

#### Materials and reagents

- Timer
- Absorbent towels or filter-paper
- Commercially available test kit containing dipsticks, reagents and positive and negative controls
- Weak-positive in-house control serum.

#### Method

Follow the instructions provided in the kit.

A positive result is indicated by any colour development on the antibody-coated spot. A spot should be visible on the positive control and no colour should be seen on the negative control. Weak-positive in-house controls should be included to help in reading results. The test run is invalid if the results obtained using the controls are not as described above.

### 11.8 Tests for hepatitis virus infection

Routine tests for hepatitis include the use of markers for hepatitis A, B and C viruses. Hepatitis A is most common in children, especially in nurseries; however, it is not routinely tested for, except in cases of epidemics.

Hepatitis B and C viruses are transmitted through blood products, body fluids, contaminated needles and other contaminated materials.

Hepatitis B virus has several markers which include:

- surface antigen (HBsAg)
- antibody to surface antigen (anti-HBs)
- envelope antigen (HBeAg)
- antibody to envelope antigen (anti-HBe)
- antibody to core antigen (anti-HBc).

The concentrations of these markers vary during the course of an infection. The antigen markers appear first or earlier on after exposure to the virus.

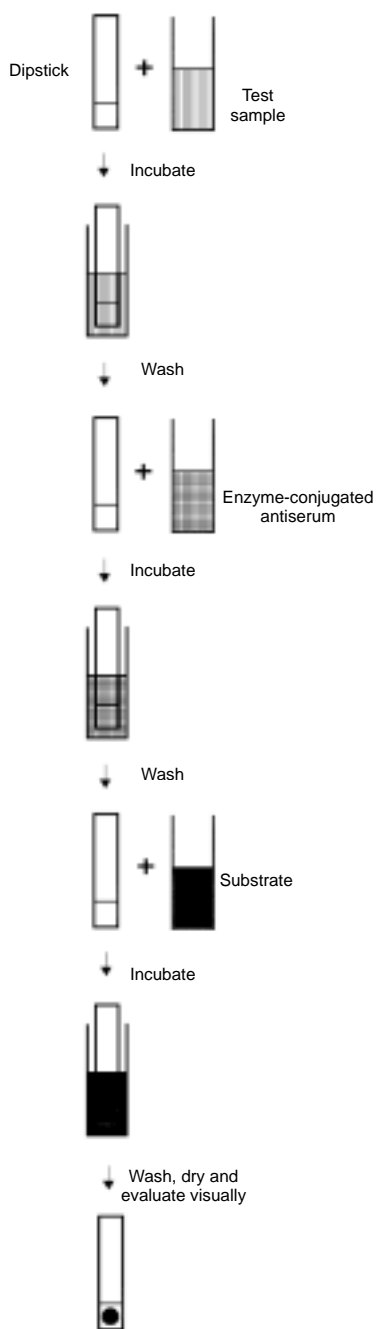

Spot = positive reaction  
No spot = negative reaction

Fig. 11.13 Dipstick assay for HIV antibody

Seroconversion (antibody production) often occurs several weeks or months after exposure.

Hepatitis testing is routinely done by solid-phase ELISA and radioimmunoassay methods. Commercial kits for detection of hepatitis markers are available and specific criteria and instructions are provided with each kit. The general principles of the ELISA technique for one of the markers for hepatitis B virus are outlined below.

### 11.8.1 ELISA for hepatitis B surface antigen

#### Materials and reagents

- Micropipettes
- Incubator or water-bath
- Washer or vacuum pump
- Spectrophotometer (reader)
- Commercially available test kit containing solid-phase support system, reagents and controls
- Distilled or deionized water.

#### Method

1. Add the test (serum) samples and controls to the anti-HBs precoated solid-phase support system and incubate according to the manufacturer's instructions.
2. Using a vacuum pump or automated washer, carefully aspirate the liquid from the solid phase and wash the system.
3. Add the specified amount of conjugate (enzyme-linked anti-HBs) and incubate according to the manufacturer's instructions.
4. Aspirate the liquid and wash to remove any unbound conjugate.
5. Add the specified amount of substrate (usually *o*-phenylenediamine) and incubate in the dark. (This is the colour development stage and should be protected from light.)
6. Add the stopping solution as specified. The stopping solution (usually an acid) inhibits any further reaction between the enzyme and the substrate.
7. Read the results in a spectrophotometer at the specified wavelength.
8. Calculate the cut-off value for the test run as instructed by the manufacturer.

The test run is invalid if the positive control values are less than the cut-off value. In such cases the assay must be repeated.

#### Precautions

The ELISA method is fairly easy to perform, but pay attention to the following:

- Make sure that the reagents and samples are brought to room temperature.
- Make appropriate dilutions of reagents or specimens if required.
- Make sure that the pre-coated antigen or antibody (solid phase) is not disturbed during the addition of the sample or of beads.
- Prepare only enough chromogen solution for a single test run. Store the solution in a closed container, in the dark. If colour develops prior to application, a new solution should be prepared.
- Avoid cross-contamination of samples.
- Adhere strictly to the incubation times, temperatures and other conditions specified in the manufacturer's instructions.

- In addition to the controls in the kit, it is generally recommended to include an in-house control of known optical density for quality control purposes.

### 11.8.2 Dipstick test for hepatitis B surface antigen

#### Principle

The dipstick test for the detection of hepatitis B surface antigen (HBsAg) takes advantage of the formation of a visible spot by precipitating immunocomplexes.

Conjugates of monoclonal antibodies against HBsAg coupled to colloidal gold particles are adsorbed to one area of a nitrocellulose strip (zone A in Fig. 11.14).

Polyclonal antibodies against HBsAg are chemically fixed to another area of the strip (zone B in Fig. 11.14). A drop of human serum is applied to zone A (Fig. 11.15). The HBsAg antigen in the serum binds to the antibody conjugate and the gold-HBsAg immunocomplex migrates along the strip until it reaches the fixed polyclonal antibodies in zone B. The polyclonal antibodies precipitate the gold-HBsAg immunocomplex, and form a visible red band in zone B (Fig. 11.16). No red band is formed if the serum does not contain HBsAg.

#### Materials and reagents

- Commercially available test kit containing dipsticks, reagents and controls.

#### Method

1. Label the test strip with the patient's name and/or number.
2. Add a drop of serum to zone A as recommended by the manufacturer.
3. Allow the serum fluid to migrate to zone B on the test strip.
4. Inspect zone B after 10–20 minutes for the appearance of a spot indicating a positive reaction.

### 11.9 Dipstick test for falciparum malaria

Dipstick tests are also available for the detection of the malarial parasite *Plasmodium falciparum*. The test described here is based on the detection by monoclonal antibodies of the species-specific histidine-rich protein II (HRP-II) which is expressed by the asexual blood stages and possibly early gametocyte stages of the parasite.

#### 11.9.1 Materials and reagents

- Capillary tubes and rubber bulbs
- Test-tubes
- Test-tube rack
- Reaction stand
- Commercially available test kit containing dipsticks, test cards, reagents and controls.

The dipstick is pretreated with a mouse monoclonal antibody against HRP-II which is applied in a line across the stick about 1 cm from its base. A second dotted line of HRP-II antigen is incorporated into the dipstick about 2–3 mm above the line of monoclonal antibody as a positive reagent control.

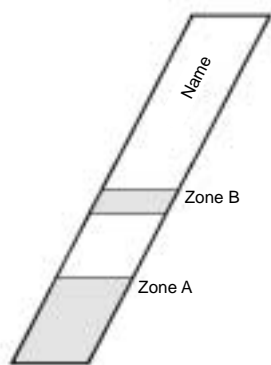

Fig. 11.14 Dipstick for the detection of HBsAg

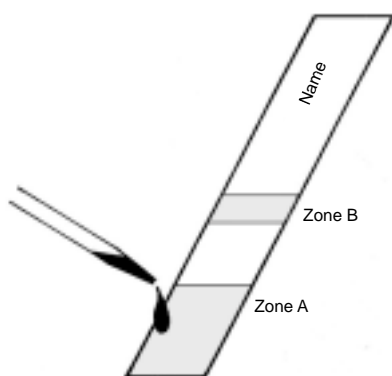

Fig. 11.15 Applying a test sample to the dipstick

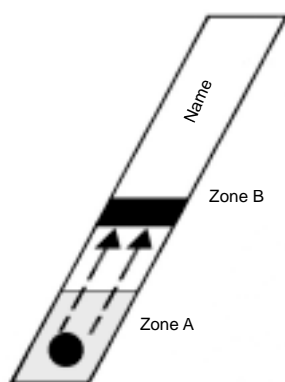

Fig. 11.16 Dipstick test for HBsAg: positive reaction

### 11.9.2 Method

1. Collect a finger-prick sample of blood from the patient.
2. Place one drop of blood into a test-tube containing three drops of lysing reagent (Fig. 11.17).
3. Place one drop of the lysed blood sample into one of the wells of the test card in the reaction stand (Fig. 11.18).
4. Place the dipstick in the lysed blood until all the blood has been absorbed (Fig. 11.19).
5. Apply one drop of detection reagent to the base of the dipstick (Fig. 11.20). This reagent consists of a suspension of micelles (phospholipid vesicles) containing sulfo-rhodamine B as a marker coupled to rabbit antibody raised against HRP-II.
6. When the reagent has been absorbed, apply two drops of washing reagent to clear the lysed blood (Fig. 11.21).

If the result is positive a thin red line will be left across the dipstick with a broken line (the reagent control) above it.



Fig. 11.17 Adding a blood sample to lysing reagent

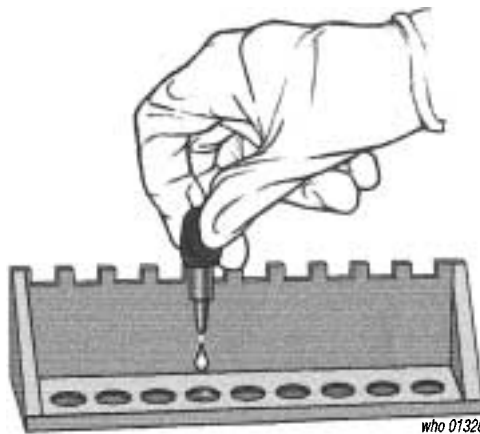

Fig. 11.18 Applying the blood sample to the test card

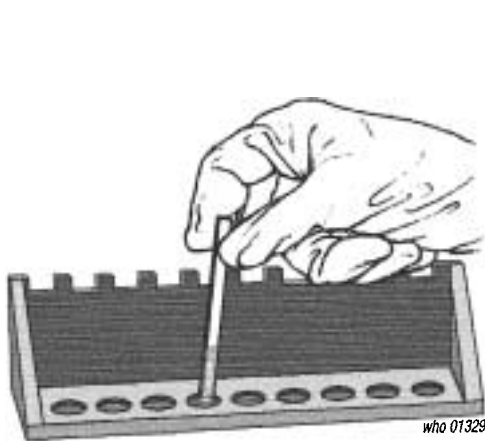

Fig. 11.19 Placing the dipstick in the lysed blood

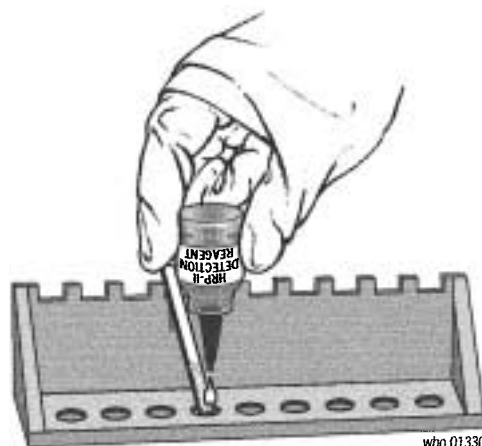

Fig. 11.20 Applying detection reagent to the dipstick

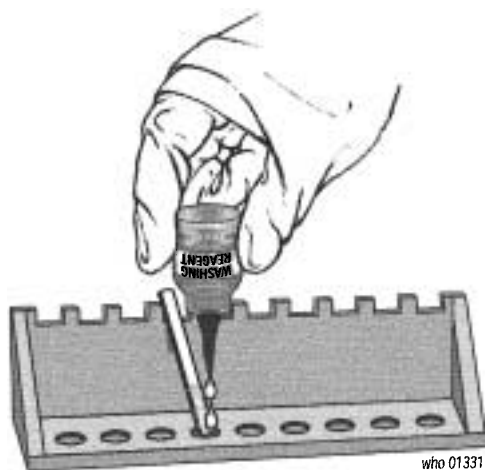

Fig. 11.21 Clearing the lysed blood with washing reagent

If the result is negative only the broken line is seen.

The whole test takes less than 10 minutes.

Current studies indicate that the test has a sensitivity and a specificity of 86–95% when compared with standard light microscopy carried out by experienced technicians. A similar test for *P. vivax* is under development.

### 11.10 Tests for syphilis infection

Syphilis is caused by *Treponema pallidum*. There are four stages of syphilis infection: primary, secondary, latent and tertiary, and a special condition of maternal–fetal transmission termed congenital syphilis. Immune responses to syphilis can be grouped into two categories: non-specific (or reaginic) and specific.

The non-specific reagin is of the IgM class and reacts with an alcoholic extract of beef heart known as cardiolipin (a phospholipid).

Since the reaginic antibody lacks specificity, it shows up in many other conditions and disease states unrelated to treponemal infection. In these cases false-positive reactions can occur. Specific antibodies to treponemes (both to *T. pallidum* and to nonpathogenic treponemes) of the normal bacterial flora of the oral or genital tract can also develop. These antibodies are of the IgG class and remain detectable throughout the life of the patient despite treatment. Routine tests for syphilis include the rapid plasma reagin (RPR) test, the fluorescent treponemal antibody-absorbed (FTA-Abs) test and the *T. pallidum* haemagglutination (TPHA) test.

#### Principle

##### RPR test

The RPR test has replaced the Venereal Disease Research Laboratory (VDRL) test, as a rapid screening test for the following reasons:

- There is no need for daily preparation of reagents.
- No microscope is required.
- Heat inactivation of serum is not required.

The RPR test uses the VDRL antigen modified with choline chloride to inactivate complement, and charcoal particles to allow the results of the reaction to be read without a microscope. The RPR test can also be applied as a semi-quantitative test.

##### FTA-Abs test

The FTA-Abs test is used in the confirmation of syphilis. In the first step of the test, serum is diluted in a concentrated culture filtrate of Reiter treponemes to absorb any antibodies to nonpathogenic treponemes. The serum is then layered over a glass slide on which killed *T. pallidum* organisms (Nichols strain) have been affixed. The slide is incubated, washed and overlaid with a fluorescent-labelled anti-human immunoglobulin antibody. If the test result is positive the treponemes will fluoresce.

This indirect immunofluorescence technique is highly sensitive in all stages of syphilis, especially in the very early and very late stages. Once positive this test remains positive for the life of the patient. It is not used as a screening test for syphilis because it does not detect reinfection and it is time-consuming and costly (a fluorescence microscope with a dark-field condenser is required).

The results of a test for syphilis must be interpreted according to the type(s) of test employed and the stage of the disease the patient has reached. Remember that a

positive result from a screening test for syphilis may be due to other heterophile antibodies, faulty technique or to the presence of other treponemal antibodies. A negative result may mean one of the following:

- The infection is too recent to have produced detectable levels of antibodies.
- The test is temporarily non-reactive because of treatment the patient is receiving.
- The test has been rendered temporarily non-reactive because the patient has consumed alcohol prior to testing.
- The disease is latent or inactive.
- The patient has not produced protective antibodies because of immunological tolerance.
- The technique is faulty.

Weakly positive results may be due to:

- very early infection;
- lessening of the activity of the disease after treatment;
- nonspecific immunological reactions;
- incorrect technique.

The greatest value of the non-treponemal tests is in screening following therapy and in the detection of reinfection.

### **TPHA test**

The TPHA test is also used in the confirmation of syphilis. In the first step of the test, diluted serum is mixed with absorbing diluent containing non-pathogenic Reiter treponemes. The serum is then transferred to a microtitre plate and erythrocytes sensitized with killed *T. pallidum* organisms (Nichols strain) are added. If the test result is positive the erythrocytes will form a smooth mat of agglutinated cells.

#### **11.10.1 RPR test**

##### **Materials and reagents<sup>1</sup>**

- Test plates
- Disposable Pasteur pipettes
- Serological pipette
- Test-tubes, 75 mm × 12 mm
- Test-tube rack
- Rotator
- RPR antigen
- Negative, weak-positive and strongly positive controls
- Sodium chloride, 0.85% solution (reagent no. 53).

The above reagents are usually supplied as part of a test kit.

##### **Method**

1. Bring the test and control sera and RPR antigen to room temperature.
2. Dispense one drop of each of the test and control sera on to the test plates and spread carefully in the individual wells.

<sup>1</sup> Note: The reagents for the RPR test should be stored at 2–6 °C in the refrigerator.

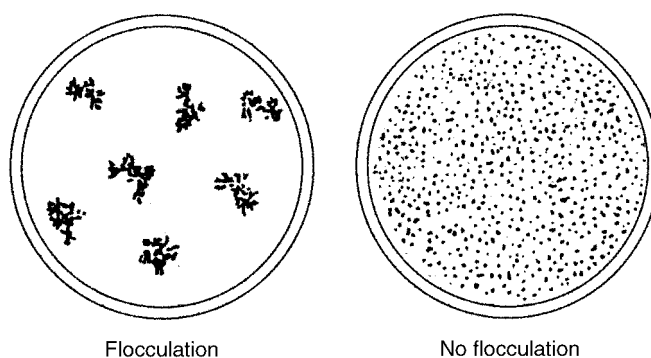

Fig. 11.22 RPR test

3. Add one drop of RPR antigen to each well of the test plates.
4. Place the test plates on the rotator and rotate for 8 minutes at 100rpm. (The recommended speed is between 95 and 105 rpm and this should be checked daily as part of quality control.)  
If a mechanical rotator is not available, tilt the plates back and forth and rotate the plates carefully for 8 minutes at 80–85 rpm.
5. Examine the test plates for flocculation (Fig. 11.22) and compare the reactions of the test sera with those of the controls.
6. Prepare a twofold dilution of any positive sera and examine the dilutions as described in steps 2–5. The highest dilution of serum to give flocculation is the titre.

### 11.10.2 TPHA test

#### Materials and reagents

- Test-tubes
- Test-tube rack
- Commercially available TPHA test kit containing microtitre plates, micropipettes (with disposable tips), absorbing diluent, erythrocytes sensitized with *T. pallidum*, unsensitized erythrocytes, positive and negative control sera
- Distilled water.

The reagents and controls should be reconstituted before use according to the manufacturer's instructions.

#### Method

1. Dilute the test and control sera 1:20 with absorbing diluent.
2. Using a micropipette, dispense 25 µl of the negative control serum into wells 1 and 2 of the first horizontal row of the microtitre plate (A in Fig. 11.23).
3. Dispense 25 µl of the positive control serum into wells 1 and 2 of the second horizontal row of the microtitre plate (B in Fig. 11.23).
4. Dispense 25 µl of the first test serum into wells 1 and 2 of the third horizontal row of the microtitre plate (C in Fig. 11.23). Repeat the procedure with the remaining test sera. If necessary, use the adjacent wells (e.g. 3 and 4 in Fig. 11.23).
5. Add 75 µl of the control erythrocytes to the wells in the first vertical row (1) and every other row (3, 5, 7, 9 and 11), as appropriate.



	1	2	3	4	5	6	7	8	9	10	11	12
A	N	N	S7	S7								
B	P	P	S8	S8								
C	S1	S1	S9	S9								
D	S2	S2	S10	S10								
E	S3	S3	S11	S11								
F	S4	S4	S12	S12								
G	S5	S5	S13	S13								
H	S6	S6	S14	S14								
	CE	AE	CE	AE								

Fig. 11.23 Test plate for the TPHA test

6. Add 75  $\mu$ l of the sensitized erythrocytes to the wells in the second vertical row (2) and every other row (4, 6, 8, 10 and 12), as appropriate.
7. Rotate the plates carefully, cover and leave to stand at room temperature for the time recommended by the manufacturer. The plates should be protected from vibration, radiant heat and direct sunlight.
8. Place the plates carefully on a white background or a sintered glass plate illuminated from below or a viewing device that allows the sedimentation pattern to be seen from below through a mirror.

If the result is positive a smooth mat of agglutinated cells will be seen. The cells may be surrounded by a red circle, or may even cover the entire base of the well. If the result is negative a compact red button of non-agglutinated cells will be seen, with or without a very small hole in its centre.

If the result is doubtful (borderline) a button of non-agglutinated cells with a small hole in its centre will be seen.

*Note:* The results should be interpreted according to the criteria provided by the manufacturer.



**Acetic acid, 500g/l (50%) solution (No. 3)**

Glacial acetic acid ( $\text{CH}_3\text{COOH}$ )	100 ml
Distilled water	q.s. 200 ml

Label the bottle "ACETIC ACID 50% SOLUTION" and write the date.

*Warning:* Glacial acetic acid is highly corrosive.

**Acetone-ethanol decolorizer for Gram stain (No. 4)**

Acetone	200 ml
Absolute ethanol	475 ml
Distilled water	25 ml

Mix the acetone, ethanol and distilled water and transfer to a clean glass-stoppered bottle. Label the bottle "ACETONE-ETHANOL DECOLORIZER" and write the date.

**Acid-ethanol for Ziehl-Neelsen stain (No. 5)**

Hydrochloric acid (HCl), concentrated	3 ml
Ethanol ( $\text{CH}_3\text{CH}_2\text{OH}$ ), 95%	97 ml

Label the bottle "ACID-ETHANOL FOR ZIEHL-NEELEN STAIN" and write the date.

*Warning:* Hydrochloric acid is highly corrosive.

**Acid reagent (No. 6)**

Concentrated sulfuric acid ( $\text{H}_2\text{SO}_4$ )	44 ml
Orthophosphoric acid ( $\text{H}_3\text{PO}_4$ ), 85%	66 ml
Cadmium sulfate	1.6 g
Thiosemicarbazide	50 mg
Distilled water	q.s. 500 ml

Half fill a 500-ml flask with distilled water, add the sulfuric acid very slowly, stirring constantly, and follow with the orthophosphoric acid. Continue mixing the solution and add the thiosemicarbazide and then the cadmium sulfate. Make up the volume to 500ml with distilled water. Transfer the reagent to a brown bottle. Label the bottle "ACID REAGENT" and write the date. Store at 2–8°C.

The reagent will keep for at least 6 months at 2–8 °C.

*Warning:* Sulfuric acid is highly corrosive.

**Albert stain (No. 7)**

Toluidine blue	0.15 g
Malachite green	0.20 g
Glacial acetic acid ( $\text{CH}_3\text{COOH}$ )	1 ml
Ethanol ( $\text{CH}_3\text{CH}_2\text{OH}$ ), 96%	2 ml
Distilled water	q.s. 100 ml

Dissolve the glacial acetic acid in 30 ml of distilled water in a clean 100-ml bottle. Add the toluidine blue and malachite green and mix well. Add the ethanol and make up the volume to 100ml with distilled water. Mix well. Label the bottle "ALBERT STAIN" and write the date. Store at room temperature.

*Warning:* Glacial acetic acid is highly corrosive.

### Alkaline haematin D reagent (No. 8)

Sodium hydroxide (NaOH)	4 g
Triton X-100 (or equivalent)	25 g
Distilled water	1000 ml

Dissolve the sodium hydroxide in the distilled water in a clean conical flask. Stir using a glass rod until the crystals have completely dissolved. Add the Triton X-100 (or equivalent) and mix well. Filter the solution into a clean glass-stoppered reagent bottle, using Whatman No. 1 (or equivalent) filter-paper. Label the bottle "ALKALINE HAEMATIN D REAGENT" and write the date. Store at room temperature (20–25°C).

Check the quality of the solution (see below).

Alkaline haematin D (AHD) reagent will keep for several months at 20–25°C. If a precipitate forms during storage, the reagent should be filtered before use.

*Note:* Use filtered rainwater if distilled water is not available.

### Quality control of alkaline haematin D reagent

An alkaline haematin D standard solution (AHD standard) supplied by the central laboratory is used to test the quality of new batches of AHD reagent in peripheral-level laboratories.

1. Fill a clean cuvette with distilled water. Place the cuvette in the cuvette chamber and adjust the haemoglobinometer or colorimeter to read zero at 540 nm wavelength.
2. Replace the distilled water with AHD reagent. The haemoglobinometer or colorimeter should read zero.
3. Pipette 20 µl of AHD standard into a test-tube containing 3 ml of the freshly prepared AHD reagent (1:150 dilution).
4. Measure the haemoglobin concentration of the AHD standard (see section 9.3.2).
5. Repeat the procedure using the previous batch of AHD reagent. Compare the results.
6. If the haemoglobin values differ by more than 5 g/l, discard the freshly prepared AHD reagent and prepare a new batch, paying attention to accurate measurement of the constituents and the cleanliness of the glassware.

The AHD standard stock solution will keep for 8 months at 4–8°C.

### Amies transport medium (No. 9)

Charcoal, pharmaceutical grade	10.0 g
Sodium chloride (NaCl)	3.0 g
Disodium hydrogen phosphate ( $\text{Na}_2\text{HPO}_4 \cdot 2\text{H}_2\text{O}$ )	1.15 g
Potassium dihydrogen phosphate ( $\text{KH}_2\text{PO}_4$ )	0.20 g
Sodium thioglycollate	0.10 g
Calcium chloride ( $\text{CaCl}_2$ ), anhydrous	0.10 g
Magnesium chloride ( $\text{MgCl}_2$ )	0.10 g
Agar	4.00 g
Distilled water	1000 ml

Suspend the mixture of salts in the distilled water. Add the agar and heat until the agar has completely dissolved. Add the charcoal. Dispense into small tubes or bottles while stirring to keep the charcoal evenly suspended.

Sterilize by autoclaving at 120°C for 15 min. Cool immediately in cold water to keep the charcoal evenly suspended. Label the tubes or bottles “AMIESTRANS-PORT MEDIUM” and write the date.

Amies transport medium is also available commercially.

### Benedict solution (No. 10)

Copper sulfate ( $\text{CuSO}_4 \cdot 5\text{H}_2\text{O}$ )	17.3 g
Trisodium citrate ( $\text{Na}_3\text{C}_6\text{H}_5\text{O}_7 \cdot 2\text{H}_2\text{O}$ )	173 g
Sodium carbonate ( $\text{Na}_2\text{CO}_3$ ), anhydrous	100 g
Distilled water	q.s. 1000 ml

Dissolve the copper sulfate crystals by heating in 100 ml of distilled water.

Dissolve the trisodium citrate and the sodium carbonate in about 800 ml of distilled water. Add the copper sulfate solution slowly to the sodium carbonate/trisodium citrate solution, stirring constantly. Make up the volume to 1000 ml with distilled water. Transfer the solution to a glass-stoppered bottle. Label the bottle “BENEDICT SOLUTION” and write the date.

### Blank reagent (No. 11)

Trichloroacetic acid ( $\text{CCl}_3\text{COOH}$ ), 50 g/l (5%) solution (5 g in 100 ml of distilled water; see No. 62)	50 ml
Distilled water	q.s. 100 ml

Mix. Transfer the solution to a glass-stoppered bottle. Label the bottle “BLANK REAGENT” and write the date. Store at room temperature (20–25°C).

The reagent will keep for several months at 20–25°C.

*Warning:* Trichloroacetic acid is highly corrosive.

### Boric acid, saturated solution (No. 12)

Boric acid	4.8 g
Distilled water	q.s. 1000 ml

Store in a glass-stoppered bottle. Label the bottle “BORIC ACID SATURATED SOLUTION” and write the date.

### Brilliant cresyl blue (No. 13)

Brilliant cresyl blue	1.0 g
Trisodium citrate ( $\text{Na}_3\text{C}_6\text{H}_5\text{O}_7 \cdot 2\text{H}_2\text{O}$ )	0.4 g
Sodium chloride ( $\text{NaCl}$ ), 8.5 g/l (0.85%) solution (No. 53)	100 ml

Dissolve the dye and the trisodium citrate together in the sodium chloride solution. Filter the solution obtained into a staining bottle. Label the bottle “BRILLIANT CRESYL BLUE” and write the date.

### Buffered glycerol saline (No. 14)

Sodium chloride ( $\text{NaCl}$ )	4.2 g
Dipotassium hydrogen phosphate ( $\text{K}_2\text{HPO}_4$ ), anhydrous	3.1 g
Potassium dihydrogen phosphate ( $\text{KH}_2\text{PO}_4$ ), anhydrous	1.0 g
Phenol red	0.003 g

Distilled water	700 ml
Glycerol (C <sub>3</sub> H <sub>8</sub> O <sub>3</sub> )	300 ml

Final pH = 7.2

Dispense the solution into bijou bottles so that there is only a 2-cm gap between the top of the medium and the top of the bottles. Label the bottles "BUFFERED GLYCEROL SALINE" and write the date.

### Buffered water, pH 7.2 (No. 15)

Buffer solution for May-Grünwald, Giemsa and Leishman stains.

Disodium hydrogen phosphate (Na <sub>2</sub> HPO <sub>4</sub> ·2H <sub>2</sub> O)	3.8 g
Potassium dihydrogen phosphate (KH <sub>2</sub> PO <sub>4</sub> ), anhydrous	2.1 g
Distilled water	q.s. 1000 ml

Dissolve the salts in the distilled water, stirring well. Check the pH using narrow-range pH papers; it should be 7.0–7.2.

Transfer the solution to a glass-stoppered bottle. Label the bottle "BUFFERED WATER" and write the date.

### Carbol fuchsin solution for Ziehl-Neelsen stain (No. 16)

**Solution A (saturated solution of basic fuchsin):**

Basic fuchsin	3 g
Ethanol (CH <sub>3</sub> CH <sub>2</sub> OH), 95%	100 ml

**Solution B (phenol aqueous solution, 50 g/l (5%)):**

Phenol (C <sub>6</sub> H <sub>5</sub> OH)	10 g
Distilled water	q.s. 200 ml

Mix 10 ml of solution A with 90 ml of solution B. Transfer the resulting mixture to a glass-stoppered bottle. Label the bottle "CARBOL FUCHSIN SOLUTION" and write the date.

*Warning:* Phenol is highly corrosive and poisonous.

### Cary-Blair transport medium (No. 17)

Sodium thioglycolate	1.5 g
Disodium hydrogen phosphate (Na <sub>2</sub> HPO <sub>4</sub> ), anhydrous	1.1 g
Sodium chloride (NaCl)	5.0 g
Agar	5.0 g
Distilled water	991.0 ml

Add the salts, agar and distilled water to a clean 1000-ml beaker and mix. Heat while mixing until the solution becomes clear. Cool to 50 °C, add 9 ml of freshly prepared aqueous calcium chloride (CaCl<sub>2</sub>), 10 g/l (1%) solution, and adjust the pH to about 8.4.

Dispense the solution in 7-ml volumes into previously rinsed and sterilized 9-ml screw-capped vials. Autoclave the vials containing the media for 15 minutes, cool, and tighten the caps.

Label the vials "CARY-BLAIR TRANSPORT MEDIUM" and write the date.

**Crystal violet, modified Hucker (No. 18)****Solution A**

Crystal violet	2.0 g
Ethanol (CH <sub>3</sub> CH <sub>2</sub> OH), 95%	20 ml

**Solution B**

Ammonium oxylate ((NH <sub>4</sub> ) <sub>2</sub> CO <sub>4</sub> ·H <sub>2</sub> O)	0.8 g
Distilled water	80 ml

Mix solutions A and B. Store for 24 hours before use. Filter into a staining bottle. Filter the stain solution into a staining bottle. Label the bottle "CRYSTAL VIOLET, MODIFIED HUCKER" and write the date.

**Delafield's haematoxylin stain (No. 19)**

Haematoxylin	4.0 g
Ammonium alum	8.0 g
Potassium permanganate	0.2 g
Absolute ethanol	125 ml
Distilled water	410 ml

Warm the ethanol by placing the beaker in a bowl of hot water. Add the haematoxylin and stir until it has dissolved. Allow the solution to cool, then filter.

Add the ammonium alum to 400 ml of distilled water (warmed to 40°C) and stir until it has dissolved. Add the solution to the filtered haematoxylin solution and mix well.

Dissolve the potassium permanganate in 10 ml of distilled water and add this solution to the stain solution. Mix well. Transfer the stain solution to a staining bottle. Label the bottle "DELAFIELD'S HAEMATOXYLIN STAIN" and write the date. Store at room temperature (20–25°C).

The stain will keep for several months at 20–25°C.

**Dichromate cleaning solution (No. 20)**

For cleaning glassware.

Potassium dichromate (K <sub>2</sub> Cr <sub>2</sub> O <sub>7</sub> )	100 g
Concentrated sulfuric acid (H <sub>2</sub> SO <sub>4</sub> )	100 ml
Distilled water	1000 ml

Dissolve the dichromate in the distilled water. Add the acid gradually, stirring constantly. The acid must always be added to the water, *not* the water to the acid. Transfer the solution to a glass-stoppered bottle. Label the bottle "DICHROMATE CLEANING SOLUTION" and write the date.

*Warning:* Since potassium dichromate and sulfuric acid are both corrosive and the mixture even more so, use the solution as seldom as possible.

**Drabkin diluting fluid (No. 21)**

Drabkin diluting fluid can be prepared from commercially available reagent tablets. The instructions for its preparation are supplied by the manufacturer.

For laboratories equipped with an accurate balance, Drabkin diluting fluid can be prepared as follows:

Potassium ferricyanide (K <sub>3</sub> Fe(CN) <sub>6</sub> )	0.40 g
Potassium cyanide (KCN)	0.10 g
Potassium dihydrogen phosphate (KH <sub>2</sub> PO <sub>4</sub> )	0.28 g
Sterox SE (or equivalent)	1 ml
Distilled water	q.s. 2000 ml

Dissolve the first three chemicals in the distilled water and mix. Add the detergent and mix gently. The reagent should be clear and pale yellow in colour. When measured against water as blank in a spectrophotometer at a wavelength of 540 nm, the absorbance should be zero. Transfer the diluting fluid to a brown bottle. Label the bottle "DRABKIN DILUTING FLUID" and write the date. If the reagent appears cloudy, discard.

*Warning:* Potassium cyanide is a highly poisonous chemical and should be used only by experienced chemists. When not in use it should be kept in a locked cupboard. After using the chemical, wash your hands thoroughly.

### EDTA dipotassium salt, 100g/l (10%) solution (No. 22)

Dipotassium ethylenediaminetetraacetate (potassium edetate)	20 g
Distilled water	q.s. 200 ml

For use, pipette 0.04 ml of this solution into small containers marked to hold 2.5 ml of blood. Allow the anticoagulant to dry by leaving the containers overnight on a warm bench or in an incubator at 37°C.

### Eosin, 10g/l (1%) solution (No. 23)

Eosin	1 g
Distilled water	q.s. 100 ml

Label the bottle "EOSIN 1% SOLUTION" and write the date.

### Eosin, 20g/l (2%) solution in saline (No. 24)

Eosin	2 g
Sodium chloride (NaCl), 8.5 g/l (0.85%) solution (No. 53)	q.s. 100 ml

Label the bottle "EOSIN 2% SOLUTION IN SALINE" and write the date.

### Field stain (No. 25)

#### Field stain A

#### Preparation from prepared powders

Field stain A powder	5 g
Distilled water, heated to 80°C	q.s. 600 ml

Mix until dissolved. Filter when cool into a 1000-ml bottle. Label the bottle "FIELD STAIN A" and write the date.

#### Preparation from original stains and chemicals

Methylene blue (medicinal)	1.6 g
Azur 1	1.0 g
Disodium hydrogen phosphate ( $\text{Na}_2\text{HPO}_4$ ), anhydrous	10.0 g
Potassium dihydrogen phosphate ( $\text{KH}_2\text{PO}_4$ ), anhydrous	12.5 g
Distilled water	q.s. 1000 ml

Dissolve the two salts in the distilled water. Pour about half of the solution into a 1000-ml bottle containing a few glass beads. Add the stain powders and mix well. Add the remainder of the solution. Mix well and filter into a clean 1000-ml bottle. Label the bottle "FIELD STAIN A" and write the date.



**Field stain B****Preparation from prepared powders**

Field stain B powder	4.8 g
Distilled water, heated to 80°C	q.s. 600 ml

Mix until dissolved. Filter when cool into a 1000-ml bottle. Label the bottle "FIELD STAIN B" and write the date.

**Preparation from original stain and chemicals**

Eosin (yellow water-soluble)	2.0 g
Disodium hydrogen phosphate ( $\text{Na}_2\text{HPO}_4$ ), anhydrous	10.0 g
Potassium dihydrogen phosphate ( $\text{KH}_2\text{PO}_4$ ), anhydrous	12.5 g
Distilled water	q.s. 1000 ml

Dissolve the two salts in the distilled water. Pour into a 1000-ml bottle. Add the eosin. Mix until dissolved. Filter into a clean 1000-ml bottle. Label the bottle "FIELD STAIN B" and write the date.

Undiluted, Field stains can be used for as long as they give good results. After dilution, they should be filtered every 2–3 days.

**Fluoride oxalate anticoagulant (No. 26)**

Sodium fluoride (NaF)	1.2 g
Potassium oxalate (KCOOH)	6.0 g
Distilled water	q.s. 100 ml

For use, pipette 0.1 ml of the anticoagulant into small containers, marked to hold 2 ml of blood (or CSF).

*Warning:* Both sodium fluoride and potassium oxalate are poisonous.

**Formaldehyde saline (No. 27)**

Neutral commercial formaldehyde ( $\text{CH}_2\text{O}$ ) solution, at least 37% (formalin)	10 ml
Sodium chloride (NaCl), 8.5 g/l (0.85%) solution (No. 53)	90 ml

Commercial formaldehyde solution is neutralized by adding a few drops of sodium carbonate, 50 g/l (5%) solution (No. 52). Test with pH indicator paper.

Label the bottle "FORMALDEHYDE SALINE" and write the date.

*Warning:* Formaldehyde is corrosive and poisonous.

**Formaldehyde, 10% solution (No. 28)**

Commercial formaldehyde ( $\text{CH}_2\text{O}$ ) solution, at least 37% (formalin)	100 ml
Distilled water	300 ml

Transfer the solution to a glass-stoppered bottle. Label the bottle "FORMALDEHYDE 10% SOLUTION" and write the date.

*Warning:* Formaldehyde is corrosive and poisonous.

**Giemsa stain (No. 29)**

Powdered Giemsa stain	0.75 g
Methanol ( $\text{CH}_3\text{OH}$ )	65 ml
Glycerol ( $\text{C}_3\text{H}_8\text{O}_3$ )	35 ml

Put the ingredients in a bottle containing glass beads and shake. Shake the bottle three times a day for 4 consecutive days. Filter into a staining bottle. Label the bottle "GIEMSA STAIN" and write the date.

### Glucose reagents (No. 30)

#### Trichloroacetic acid, 30g/l (3%) solution

Trichloroacetic acid (CCl <sub>3</sub> COOH)	15 g
Distilled water	q.s. 500 ml

Weigh the acid out quickly, since it is highly deliquescent. Transfer to a beaker. Add distilled water to dissolve the chemical. Transfer to a 500-ml flask and make up the volume to 500 ml with distilled water. Label the flask "TRICHLOROACETIC ACID 3% SOLUTION" and write the date. Keep in the refrigerator.

*Warning:* Trichloroacetic acid is highly corrosive.

#### *o*-Toluidine reagent

Thiourea	0.75 g
Glacial acetic acid (CH <sub>3</sub> COOH)	470 ml
<i>o</i> -Toluidine	30 ml

Dissolve the thiourea in the glacial acetic acid. (If it is difficult to dissolve, stand the flask in a bowl of hot water.) Add the *o*-toluidine and mix well. Transfer the reagent to a brown bottle. Label the bottle "*O*-TOLUIDINE REAGENT" and write the date. Keep at room temperature. Allow to stand for at least 24 hours before use.

*Warning:* Glacial acetic acid is highly corrosive.

#### Benzoic acid, 1 g/l (0.1%) solution

Benzoic acid	1 g
Distilled water	q.s. 1000 ml

Measure 1000 ml of distilled water and heat to just below boiling. Add the benzoic acid and mix well until it is dissolved. Allow to cool. Transfer the solution to a 1000-ml glass-stoppered bottle. Label the bottle "BENZOIC ACID 0.1% SOLUTION" and write the date.

#### Glucose stock reference solution (100 mmol/l)

Glucose, pure, anhydrous	9 g
Benzoic acid, 1 g/l (0.1%) solution	q.s. 500 ml

Label the flask "GLUCOSE STOCK REFERENCE SOLUTION 100 MMOL/L" and write the date.

Freeze in quantities of about 100 ml. Use a new bottle of frozen stock reference solution each time the working reference is prepared.

#### Glucose working reference solutions (2.5, 5, 10, 20 and 25 mmol/l)

Allow the glucose stock reference solution to reach room temperature. Carefully pipette 2.5, 5, 10, 20 and 25 ml of the stock reference solution into each of five 100-ml volumetric flasks. Make up to the mark with the benzoic acid solution and mix well. Label the flasks as above and write the date. Store in a refrigerator. Renew monthly.

**Glycerol–malachite green solution (No. 31)**

1. Prepare a stock solution of malachite green, 1% solution:

Malachite green	1 g
Distilled water	100 ml

Using a pestle and mortar, grind the malachite green crystals to a powder. Dissolve 1 g of the freshly prepared powder in 100 ml of distilled water and pour the solution into a dark bottle. Label the bottle “MALACHITE GREEN 1% SOLUTION” and write the date. Close the bottle tightly and keep it in the dark.

2. Prepare a working solution of glycerol–malachite green:

Glycerol	100 ml
Malachite green, 1% stock solution	1 ml
Distilled water	100 ml

Add the glycerol, malachite green stock solution and distilled water to a 250-ml glass-stoppered bottle. Label the bottle “GLYCEROL–MALACHITE GREEN SOLUTION” and write the date. Mix gently before use.

**Hydrochloric acid, 0.01 mol/l solution (No. 32)**

Hydrochloric acid (HCl), concentrated	8.6 ml
Distilled water	q.s. 1000 ml

Measure out 500 ml of distilled water into a 1000-ml glass-stoppered bottle. Add the acid, drop by drop. Make up to 1000 ml with the rest of the distilled water. Label the bottle “HYDROCHLORIC ACID 0.01 MOL/L SOLUTION” and write the date. Renew monthly.

*Warning:* Hydrochloric acid is highly corrosive.

**Isotonic saline**

See Sodium chloride.

**Lactophenol cotton blue mounting solution (No. 33)**

Cotton blue (aniline blue)	50 mg
Phenol (C <sub>6</sub> H <sub>5</sub> OH) crystals	20 mg
Lactic acid (CH <sub>3</sub> CH(OH)COOH)	20 ml
Glycerol (C <sub>3</sub> H <sub>8</sub> O <sub>3</sub> )	40 ml
Distilled water	20 ml

Add the phenol, lactic acid and glycerol to the distilled water, mix and dissolve by heating gently. Add the cotton blue and mix. Transfer the solution to a glass-stoppered bottle. Label the bottle “LACTOPHENOL COTTON BLUE MOUNTING SOLUTION” and write the date.

*Warning:* Phenol is highly corrosive and poisonous.

**Leishman stain (No. 34)**

Leishman powder	1.5 g
Methanol (CH <sub>3</sub> OH)	q.s. 1000 ml

Rinse out a clean staining bottle with methanol. Add a few clean dry glass beads. Add the staining powder and methanol and mix well. Label the bottle “LEISHMAN STAIN” and write the date.

The stain is ready for use the following day. It is important to prevent moisture from entering the stain during its preparation and storage.

**Loeffler methylene blue (No. 35)**

Methylene blue	0.5 g
Absolute ethanol (CH <sub>3</sub> CH <sub>2</sub> OH)	30 ml
Potassium hydroxide (KOH), 200 g/l (20%) solution (No. 45)	0.1 ml
Distilled water	q.s. 100 ml

Dissolve the methylene blue in 30 ml of distilled water and transfer the solution to a clean brown bottle. Add the potassium hydroxide, ethanol and the remainder of the distilled water and mix well. Label the bottle "LOEFFLER METHYLENE BLUE" and write the date. Store in a dark place at room temperatures (20–25°C).

**Lugol iodine, 1 g/l (0.1%) solution (No. 36)**

Iodine	1 g
Potassium iodide (KI)	2 g
Distilled water	300 ml

Grind the dry iodine and potassium iodide in a mortar. Add distilled water, a few millilitres at a time, and grind thoroughly after each addition until the iodine and iodide dissolve. Rinse the solution into an amber glass bottle with the remainder of the distilled water.

Alternatively, measure 300 ml of distilled water in a cylinder. First dissolve the potassium iodide in about 30 ml of the distilled water. Add the iodine and mix until dissolved. Add the remainder of the distilled water and mix well. Store in a brown bottle.

Label the bottle "LUGOL IODINE 0.1% SOLUTION" and write the date.

**Lugol iodine, 5 g/l (0.5%) solution (No. 37)**

Iodine	5 g
Potassium iodide (KI)	10 g
Distilled water	q.s. 300 ml

Grind the dry iodine and potassium iodide in a mortar. Add distilled water, a few millilitres at a time, and grind thoroughly after each addition until the iodine and iodide dissolve. Rinse the solution into an amber glass bottle with the remainder of the distilled water.

Alternatively, measure 300 ml of distilled water in a cylinder. First dissolve the potassium iodide in about 30 ml of the distilled water. Add the iodine and mix until dissolved. Add the remainder of the distilled water and mix well. Store in a brown bottle.

Label the bottle "LUGOL IODINE 0.5% SOLUTION" and write the date.

**May-Grünwald stain (No. 38)**

May-Grünwald powder	5 g
Methanol	q.s. 1000 ml

Rinse out a clean 1000-ml bottle with methanol. Add a few clean dry glass beads. Add the staining powder and methanol. Mix well to dissolve the stain. Label the bottle "MAY-GRÜN WALD STAIN" and write the date.

The stain is improved by keeping for 1–2 weeks, mixing at intervals. It is important to prevent moisture from entering the stain during its preparation and storage.

**Methylene blue solution (No. 39)**

Methylene blue	0.3 g
Distilled water	100 ml

Dissolve the methylene blue in the distilled water. Filter the solution into a clean brown bottle. Label the bottle "METHYLENE BLUE SOLUTION" and write the date.

**Neutral red, 1 g/l (0.1%) solution (No. 40)**

Neutral red	1 g
Distilled water	q.s. 1000 ml

Dissolve the neutral red in about 300 ml of distilled water in a clean 1000-ml bottle. Make up the volume to 1000 ml with distilled water and mix well. Label the bottle "NEUTRAL RED 0.1% SOLUTION" and write the date. Store at room temperature.

**Pandy reagent (No. 41)**

Phenol (C <sub>6</sub> H <sub>5</sub> OH)	30 g
Distilled water	500 ml

Put the phenol in a 1000-ml bottle. Add the distilled water and shake vigorously. Label the bottle "PANDY REAGENT" and write the date. Leave to stand for 1 day. Check whether any phenol remains undissolved. If so, filter. (If all the phenol has dissolved, add a further 10 g and wait another day before filtering.) (Pandy reagent is a saturated solution of phenol.)

*Warning:* Phenol is highly corrosive and poisonous.

**Phenol red, 10 g/l (1%) solution (No. 42)**

Phenol red crystals	0.1 g
Distilled water	10 ml

Weigh out the phenol red crystals in a 20-ml beaker. Add the distilled water and stir until the crystals have dissolved. Transfer the solution to a plastic dropper bottle. Label the bottle "PHENOL RED 1% SOLUTION" and write the date. Store at room temperature (20–25°C).

**Phosphate-buffered water, 0.01 mol/l, pH 6.8 (No. 43)**

1. Prepare a stock solution of anhydrous sodium dihydrogen phosphate in a 1000-ml volumetric flask:

Sodium dihydrogen phosphate, anhydrous (NaH <sub>2</sub> PO <sub>4</sub> )	13.6 g
Distilled water	q.s. 1000 ml

Sterilize the stock solution by filtering it through a 0.2- $\mu$ m pore size filter. If anhydrous sodium dihydrogen phosphate is not available, the solution can be prepared by dissolving 17.2 g of sodium dihydrogen phosphate dihydrate (NaH<sub>2</sub>PO<sub>4</sub>·2H<sub>2</sub>O) in 1000 ml of distilled water. Label the volumetric flask "ANHYDROUS SODIUM DIHYDROGEN PHOSPHATE" and write the date. Keep the stock solution in a refrigerator.

2. Prepare a stock solution of disodium hydrogen phosphate in a 1000-ml volumetric flask:

Disodium hydrogen phosphate, dihydrate (Na <sub>2</sub> HPO <sub>4</sub> ·2H <sub>2</sub> O)	17.8 g
Distilled water	q.s. 1000 ml

Sterilize the stock solution by filtering it through a 0.2- $\mu\text{m}$  pore size filter. If disodium hydrogen phosphate dihydrate is not available, the solution can be prepared by dissolving 26.8 g of disodium hydrogen phosphate, heptahydrate ( $\text{Na}_2\text{HPO}_4 \cdot 7\text{H}_2\text{O}$ ) or 35.8 g of disodium hydrogen phosphate, dodecahydrate ( $\text{Na}_2\text{HPO}_4 \cdot 12\text{H}_2\text{O}$ ). Label the volumetric flask "DISODIUM HYDROGEN PHOSPHATE STOCK SOLUTION" and write the date. Keep the stock solution in a refrigerator.

- Mix the two stock solutions in the amounts shown in the table below to obtain 100 ml of buffered water. The pH should be as indicated in the table. If the pH is too low, adjust it with sodium hydroxide (NaOH), 0.01 mol/l solution (No. 54); if it is too high, adjust it with hydrochloric acid (HCl), 0.01 mol/l solution (No. 32).

pH of working solution	Volume of stock solution (ml)	
	$\text{NaH}_2\text{PO}_4$	$\text{Na}_2\text{HPO}_4 \cdot 2\text{H}_2\text{O}$
6.4	83.2	16.8
6.5	75.0	25.0
6.8	50.8	49.2
6.9	43.9	56.1
7.0	39.0	61.0
7.2	28.0	72.0
7.4	19.9	81.0
7.6	13.0	87.0
7.8	8.5	91.5
8.0	5.3	94.7

### Polyvinyl alcohol (PVA) fixative (No. 44)

*Note:* This should be prepared at an intermediate level laboratory, because of the dangerous reagents involved.

#### Modified Schaudinn fixative

Mercuric chloride crystals ( $\text{HgCl}_2$ )	1.5 g
Ethanol, 95%	31.0 ml
Glacial acetic acid	5.0 ml

Dissolve the mercuric chloride in the ethanol in a stoppered flask (50 or 125 ml) by swirling at intervals. Add the acetic acid, stopper, and mix by swirling. Label the flask "MODIFIED SCHAUDINN FIXATIVE" and write the date.

*Warning:* Mercuric acid is highly poisonous. Glacial acetic acid is highly corrosive.

#### PVA mixture

Glycerol	1.5 ml
PVA powder (low viscosity)	5.0 g
Distilled water	52.5 ml

In a small beaker, add the glycerol to the PVA powder and mix thoroughly with a glass rod until all particles appear coated with the glycerol. Scrape the mixture into a 125-ml flask. Add the distilled water, stopper, and leave at room temperature (20–25°C) for 3 hours or overnight. Label the flask "PVA MIXTURE" and write the date. Swirl the mixture occasionally to mix.

PVA powder and PVA fixative solutions are available from several commercial sources. There are many grades of PVA powder on the market, but the grades with high hydrolysis and low or medium viscosity are most satisfactory for preparing PVA fixative.

### PVA fixative working solution

1. Heat a water-bath (or large beaker of water) to 70–75°C. Adjust the heat to maintain this temperature range.
2. Place the loosely stoppered flask containing the PVA mixture in the water-bath for about 10 minutes, swirling frequently.
3. When the PVA powder appears to be mostly dissolved, pour in the modified Schaudinn fixative solution, restopper and swirl to mix.
4. Continue to swirl the mixture in the water-bath for 2–3 minutes to dissolve the remainder of the PVA, to allow bubbles to escape, and to clear the solution.
5. Remove the flask from the water-bath and allow it to cool. Store the PVA fixative in a screw-cap or glass-stoppered bottle. Label the bottle “PVA FIXATIVE” and write the date. The fixative will keep for 6–12 months.

### Potassium hydroxide, 200 g/l (20%) solution (No. 45)

Potassium hydroxide (KOH) pellets	20 g
Distilled water	q.s. 100 ml

Label the volumetric flask “POTASSIUM HYDROXIDE 20% SOLUTION” and write the date.

*Warning:* Potassium hydroxide is corrosive.

### Potassium permanganate, 40g/l (4%) solution (No. 46)

Potassium permanganate (KMnO <sub>4</sub> )	40 g
Distilled water	q.s. 1000 ml

Dissolve the potassium permanganate in 300 ml of distilled water in a 1000-ml volumetric flask. Make up the volume to 1000 ml with distilled water. Label the volumetric flask “POTASSIUM PERMANGANATE 4% SOLUTION” and write the date.

### Safranin solution (No. 47)

1. Prepare a stock solution:

Safranin O	2.5 g
Ethanol (CH <sub>3</sub> CH <sub>2</sub> OH), 95%	q.s. 100 ml

Mix until all the safranin has dissolved. Transfer the solution to a glass-stoppered bottle. Label the bottle “SAFRANINE STOCK SOLUTION” and write the date.

2. Prepare a working solution in a glass-stoppered bottle:

Stock solution	10 ml
Distilled water	90 ml

Label the bottle “SAFRANINE WORKING SOLUTION” and write the date. Store in the dark.

### Saponin, 10g/l (1%) solution (No. 48)

Saponin	1 g
Sodium chloride (NaCl), 8.5 g/l (8.5%) solution (No. 53)	100 ml

Add the sodium chloride solution to a glass bottle. Add the saponin, mix, and heat until it has completely dissolved.

Label the bottle "1% SAPONIN IN SALINE" and write the date.

### Silver nitrate, 17 g/l (1.7%) solution (No. 49)

Silver nitrate ( $\text{AgNO}_3$ )	5.1 g
Distilled water	q.s. 300 ml

Mix until all the silver nitrate has dissolved. Label the bottle "SILVER NITRATE 1.7% SOLUTION" and write the date.

*Warning:* Silver nitrate is caustic.

### Sodium bicarbonate, 20 g/l (2%) solution (No. 50)

Sodium bicarbonate ( $\text{NaHCO}_3$ )	2 g
Distilled water	q.s. 100 ml

Label the volumetric flask "SODIUM BICARBONATE 2% SOLUTION" and write the date.

### Sodium carbonate, 2 g/l (0.2%) solution (No. 51)

Sodium carbonate ( $\text{Na}_2\text{CO}_3$ ), anhydrous (or an equivalent quantity of one of the hydrates)	2 g
Distilled water	q.s. 100 ml

Label the volumetric flask "SODIUM CARBONATE 0.2% SOLUTION" and write the date.

### Sodium carbonate, 50 g/l (5%) solution (No. 52)

Sodium carbonate ( $\text{Na}_2\text{CO}_3$ ), anhydrous (or an equivalent quantity of one of the hydrates)	5 g
Distilled water	q.s. 100 ml

Label the volumetric flask "SODIUM CARBONATE 5% SOLUTION" and write the date.

### Sodium chloride, 8.5 g/l (0.85%) solution (isotonic saline) (No. 53)

Sodium chloride ( $\text{NaCl}$ )	8.5 g
Distilled water	q.s. 1000 ml

Label the volumetric flask "SODIUM CHLORIDE 0.85% SOLUTION" and write the date.

### Sodium citrate

See Trisodium citrate.

### Sodium hydrogen carbonate

See Sodium bicarbonate.

### Sodium hydroxide, 0.01 mol/l solution (No. 54)

Sodium hydroxide ( $\text{NaOH}$ ) pellets	3 g
Distilled water	q.s. 100 ml



Label the volumetric flask "SODIUM HYDROXIDE 0.01 MOL/L SOLUTION" and write the date.

*Warning:* Sodium hydroxide is corrosive.

### Sodium metabisulfite, 20 g/l (2%) solution (No. 55)

Sodium metabisulfite ( $\text{Na}_2\text{S}_2\text{O}_5$ )	0.5 g
Distilled water	q.s. 25 ml

Make up freshly for use.

Label the volumetric flask "SODIUM METABISULFITE 2% SOLUTION" and write the date.

### Stuart transport medium, modified (No. 56)

Agar	4.00 g
Distilled water	1000 ml

Heat until dissolved and add while hot:

Sodium chloride (NaCl)	3.00 g
Potassium chloride (KCl)	0.20 g
Disodium hydrogen phosphate ( $\text{Na}_2\text{HPO}_4$ ), anhydrous	1.15 g
Sodium dihydrogen phosphate ( $\text{NaH}_2\text{PO}_4$ ), anhydrous	0.20 g
Sodium thioglycolate	1.00 g
Calcium chloride ( $\text{CaCl}_2$ ), 10 g/l (1%) aqueous solution (freshly prepared)	10 ml
Magnesium chloride ( $\text{MgCl}_2$ ), 10 g/l (1%) aqueous solution	10 ml

Final pH: 7.3

1. Stir until dissolved and add 10 g of neutral charcoal powder.
2. Dispense 5–6 ml of medium per 13 mm × 10 mm screw-capped tube (avoid crushing).
3. Autoclave at 121 °C for 20 minutes. Invert the tubes before the medium solidifies in order to distribute the charcoal uniformly. Label the tubes "STUART TRANSPORT MEDIUM, MODIFIED" and write the date. Store in the refrigerator.

### Sulfosalicylic acid, 30 g/l (3%) solution (No. 57)

Sulfosalicylic acid	3 g
Distilled water	q.s. 100 ml

Label the volumetric flask "SULFOSALICYLIC ACID 3% SOLUTION" and write the date.

### TIF (thiomersal–iodine–formaldehyde) fixative (No. 58)

1. Prepare a stock solution:

Tincture of thiomersal, 1 : 1000	200 ml
Formaldehyde, 10% solution (No. 28)	25 ml
Glycerol	5 ml
Distilled water	q.s. 250 ml

Transfer the stock solution to a brown bottle. Label the bottle "THIOMERSAL-FORMALDEHYDE STOCK SOLUTION" and write the date. The stock solution will keep for up to 3 months.

*Warning:* Formaldehyde is corrosive and poisonous.

2. On the day of use, mix:

Stock thiomersal solution	9.4 ml
Lugol iodine, 50 g/l (5%) solution (No. 37)	0.6 ml

### Trisodium citrate, 20g/l (2%) solution in saline (No. 59)

Trisodium citrate, dihydrate ( $\text{Na}_3\text{C}_6\text{H}_5\text{O}_7 \cdot 2\text{H}_2\text{O}$ )	2 g
Sodium chloride, 8.5 g/l (0.85%) solution (No. 53)	q.s. 100 ml

Keep in the refrigerator.

Label the volumetric flask "TRISODIUM CITRATE 2% SOLUTION IN SALINE" and write the date.

### Trisodium citrate, 32g/l (3.2%) solution (No. 60)

This is used as an anticoagulant.

Trisodium citrate, anhydrous ( $\text{Na}_3\text{C}_6\text{H}_5\text{O}_7$ ) (or an equivalent quantity of either the dihydrate or the pentahydrate)	3.2 g
Distilled water	q.s. 100 ml

Keep in the refrigerator. Use 1 ml of the solution per 4 ml of blood.

Label the volumetric flask "TRISODIUM CITRATE 3.2% SOLUTION" and write the date.

### Türk solution (No. 61)

Glacial acetic acid ( $\text{CH}_3\text{COOH}$ )	4 ml
Methylene blue solution (No. 39)	10 drops
Distilled water	q.s. 200 ml

Dissolve the glacial acetic acid in 100 ml of the distilled water. Add the methylene blue solution and mix. Transfer the mixture to a 200-ml volumetric flask and make up the volume to 200 ml with distilled water. Label the volumetric flask "TURK SOLUTION" and write the date.

*Warning:* Glacial acetic acid is highly corrosive.

### Urea reagents (No. 62)

#### Trichloroacetic acid, 50g/l (5%) solution

Trichloroacetic acid ( $\text{CCl}_3\text{COOH}$ )	10 g
Distilled water	q.s. 200 ml

Weigh the acid out quickly; it is highly deliquescent. Transfer to a beaker. Add 100 ml of distilled water and mix to dissolve the chemical. Transfer the solution to a 200-ml volumetric flask and make up the volume to 200 ml with distilled water. Label the volumetric flask "TRICHLOROACETIC ACID 5% SOLUTION" and write the date.

*Warning:* Trichloroacetic acid is highly corrosive.

**Diacetyl monoxime stock solution**

Diacetyl monoxime (also called 2,3-butanedione monoxime)	2 g
Distilled water	q.s. 500 ml

Label the volumetric flask "DIACETYL MONOXIME STOCK SOLUTION" and write the date. The solution will keep for at least 6 months at 2–8 °C.

**Colour reagent**

Acid reagent (No. 6)	50 ml
Diacetyl monoxime reagent	50 ml

Mix the acid reagent and stock solution in a 100-ml stoppered flask. Label the flask "COLOUR REAGENT". The quantities shown above are sufficient for 33 measurements. The reagent must be prepared daily.

**Urea stock reference solution, 125 mmol/l**

Urea	750 mg
Benzoic acid, 1 g/l (0.1%) solution (see No. 30)	q.s. 100 ml

Dissolve the urea in about 20 ml of the benzoic acid solution in a 100-ml volumetric flask. Make up the volume to 100 ml with benzoic acid solution. Label the flask "UREA STOCK REFERENCE SOLUTION 125 MMOL/L" and write the date. Store in a refrigerator. The solution will keep for several months at 2–8 °C.

**Urea working reference solution, 10 mmol/l**

Urea stock reference solution	8 ml
Benzoic acid (C <sub>7</sub> H <sub>6</sub> O <sub>2</sub> ), 1 g/l (0.1%) solution (see No. 30)	q.s. 100 ml

Mix the solutions well in a 100-ml volumetric flask. Label the volumetric flask "UREA WORKING REFERENCE SOLUTION 10 MMOL/L" and write the date.

**Wayson stain (No. 63)****Solution A<sub>1</sub>:**

Basic fuchsin	2 g
Absolute methanol (CH <sub>3</sub> OH)	100 ml

**Solution A<sub>2</sub>:**

Methylene blue	7 g
Absolute methanol (CH <sub>3</sub> OH)	100 ml

Combine the two solutions to give solution A.

**Solution B** (phenol, 50 g/l (5%) solution):

Phenol (C <sub>6</sub> H <sub>5</sub> OH)	100 g
Distilled water	2000 ml

Add solution A to solution B. The staining properties of Wayson stain improve with age. Make the stain in large quantities and dispense it in small amounts in to dark bottles for future use. Label the bottles "WAYSON STAIN" and write the date.

*Warning:* Phenol is corrosive.

**Willis solution (No. 64)**

This is a saturated solution of sodium chloride.

Sodium chloride (NaCl)	125 g
Distilled water	500 ml

Dissolve the sodium chloride by heating the mixture to boiling point. Leave to cool and stand. Check that some of the salt remains undissolved. If it has all dissolved add a further 50 g. Filter into a corked bottle. Label the bottle "WILLIS SOLUTION" and write the date.

**Wintrobe solution (No. 65)**

Ammonium oxalate ( $(\text{NH}_4)_2\text{C}_2\text{O}_4 \cdot \text{H}_2\text{O}$ )	1.2 g
Potassium oxalate ( $\text{K}_2\text{C}_2\text{O}_4 \cdot \text{H}_2\text{O}$ )	0.8 g
Distilled water	q.s. 100 ml

Dissolve the two salts in 50 ml of distilled water in a 100-ml volumetric flask. Make up the volume to 100 ml with distilled water. Label the volumetric flask "WINTROBE SOLUTION" and write the date.

Put 0.5 ml of this mixture in each 5-ml bottle used for the collection of blood. Leave the open bottles to dry at room temperature or, preferably, place them in an incubator at 37°C.

**Zenker fixative (No. 66)**

Potassium dichromate ( $\text{K}_2\text{Cr}_2\text{O}_7$ )	2.5 g
Mercuric chloride ( $\text{HgCl}_2$ )	5.0 g
Sodium sulfate ( $\text{Na}_2\text{SO}_4$ )	1.0 g
Distilled water	q.s. 100 ml

Just before use, add 5 ml of glacial acetic acid to the solution.

Dissolve the three salts in 50 ml of distilled water in a 100-ml volumetric flask. Make up the volume to 100 ml with distilled water. Label the volumetric flask "ZENKER FIXATIVE" and write the date.

*Warning:* Glacial acetic acid is highly corrosive and mercuric chloride is highly poisonous. This fixative should be made up by fully qualified and experienced technicians only.

# Index



Note: Page numbers in bold refer to main entries; italicized page numbers refer to illustrations.

- Acids  
corrosive injuries from **98–99**  
handling precautions **97**
- Acquired immunodeficiency syndrome (AIDS) (*see also* Human immunodeficiency virus) 313, 320
- “Actinomycetes”, identification **200**, 201, 204
- African trypanosomiasis **182–192**, 184–187, 259–260, 260, 263
- Agglutination techniques 333–334, **333–334**, 336, **336**, **339**  
CATT **188–192**, 189–192
- AHD, *see* Alkaline haematin D
- AIDS, *see* Acquired immunodeficiency syndrome
- Albert stain 201, **201–202**, **351**
- Albumin, urine 237
- Alcohols, disinfection **85**
- Alembics, distilled water 25, 25
- Alkaline haematin D (AHD) **276–279**, **352**
- Alkalis  
corrosive injuries from **99–100**  
handling precautions **97**
- Allen & Ridley sedimentation technique **153–154**, 154
- Amies transport medium **352–353**
- Amoebae 105  
cysts **118–120**, 119–121, **123**  
motile forms 111–114, **113–115**  
pathogenicity 111
- Anaemias 284, **287–288**, 292, 293, 313  
abnormal erythrocytes **305–310**, 306–310  
sickle-cell 306, 307, **307**, 308–310, **314–316**, 315
- Analytical balances 32, **68–69**, 69
- Ancylostoma duodenale* (hookworm) 106  
adults **148**, 150  
eggs 126, **127**, 128, 133, 152  
larvae **157**, 158
- Anisocytosis 309, **309**
- Anthrax (*Bacillus anthracis*) 204, **204**, **219**
- Antibodies **328–329**, 329  
antigen interactions **330**  
immunochemical techniques **330–335**  
tests 331–336, **336–349**, 344–346, 348–349
- Anticoagulants **42–43**, 266, **357**
- Antigens **329–330**  
antibody interactions **330**  
immunochemical techniques **330–335**  
tests 331–336, **336–349**, 344–346, 348–349
- Anti-streptolysin O test (ASOT) **336–338**
- Applicators, wooden 36
- Ascaris lumbricoides* (roundworm) 106  
adults **146**, 147  
eggs 126, **127–128**, 133, **133**, 152
- ASOT, *see* Anti-streptolysin O test
- Aspiration  
body cavity fluids **218–220**  
buboes 218, **219**  
lymph nodes **183–185**, 184–185
- Assays, immunology 330–331, **330–331**, **343–344**
- Autoclaves 33, 86–87, **86–88**
- Bacillus anthracis* 204, **204**, **219**
- Bacteria **197–224**  
anthrax **220**  
body cavity fluids **218–220**  
diarrhoeal diseases 105  
leprosy **220–224**, 221–223  
smears **199–201**  
sputum/throat specimens **204–207**, 205–207  
staining techniques 199–201, **199–204**, 204  
stool specimens **216–218**, 217  
urine specimens 240, **249–254**, 250–253  
urogenital specimens **209–211**, 210–211, **215–216**
- Bacteriological index (BI) **223–224**
- Bacteriological tests (*see also* Bacteria)  
equipment **37–38**  
laboratory registers 47, **50**
- Balances, laboratory 32, **66–69**, 67–69
- Balantidium coli* 105, **116**, 117, 121, **121**
- Base units, SI **3**
- Basophilic staining **305**
- Basophilic stippling, erythrocytes **309**, 310
- Basophils, polymorphonuclear 310, 311, **311**
- Batteries, electrical supply **14–15**
- Battery-operated centrifuges 71
- Benedict solution 236, **236–237**, **353**
- Benzoic acid **358**

- BI, *see* Bacteriological index
- Bilirubin crystals, urine 248, 248
- Binding tests, immunology 330–335, 330–335
- Biopsy specimens 93, 95–96, 160–163, 161–163
- Blank reagent 353
- Blastocystis hominis* (yeast) 124–125, 127
- Bleaches, household 84–85
- Bleeding time, measurement 295–296, 295–296
- Blood
- cells 265–266, 265–266
  - clotting 266, 266, 297–298, 297–298
  - CSF specimens 256–259, 256–259
  - disinfection 84–85
  - stool specimens 157–159, 158
  - urine specimens 234, 241–242, 241–243, 244
- Blood flukes (*Schistosoma* spp.) 106, 150–151, 151
- Blood specimens
- chemistry registers 47, 49
  - collection 102, 267–270, 267–270, 280–282, 281, 286
  - dispatch 92
  - equipment 42–43, 43
  - glucose concentrations 322–325, 323–324
  - parasites 159–160, 166–196
    - microfilariae 159, 163–172, 166, 167, 169, 171, 173
    - Plasmodium* spp. 172–182, 178
    - protozoa 172–194, 178, 185, 187, 193–194
    - Trypanosoma* spp. 159, 182–194, 185–187
  - test-tube cleaning 82
  - thick blood films 173–182, 175, 187, 187, 193–194, 193–194
  - thin blood films 175, 299–314, 300–304, 306–314
  - urea concentrations 7, 325–327
- Boric acid 353
- Bottles 36–37
- Brilliant cresyl blue 316–317, 318–319, 353
- Broken glass injuries 101
- Brugia* spp. 159–160, 165, 166, 171, 173
- Bubonic plague (*Yersinia pestis*) 203–204, 218, 219
- Buffered glycerol saline 217–218, 353–354
- Buffered water 29–31, 31, 354, 361–362
- Bunsen burners 35
- Burettes 77, 77
- Burns, laboratory accidents 100–101
- Butane gas burners 97
- Cables, electrical 19
- Cabot ring bodies 309, 310
- Calcium crystals, urine 245, 245, 246, 246, 247
- Calcium hydroxide 85
- Calcium hypochlorite 84–85
- Calculations (*see also* Measurement)
- blood glucose concentration 7, 324–325
  - blood urea concentration 327
  - erythrocyte number concentration 6, 287–288
  - erythrocyte sedimentation rate 292–295, 293–294
  - erythrocyte volume fraction 6, 279–287, 280–283, 286–287
  - haemoglobin concentration 7, 271–279, 272–273
  - leukocyte number concentration 6, 258–259, 258–259, 288–290, 288–292
  - leukocyte type number fraction 6, 319–321, 320
  - malaria parasites 180–182
  - reticulocyte number concentration/fraction 6, 317–318
  - thrombocyte number concentration 7, 321
  - urine protein 238–239
- Calibrated dropping pipettes 75, 75
- Calibration
- colorimeters 277, 278, 279, 324
  - spectrophotometers 272–274, 272–273, 276, 279
- Campylobacter* spp. 216
- Candida albicans*
- CSF 257, 261, 261
  - identification 200, 200
  - vaginal discharge 215
- Capillary blood
- bleeding time 295–296, 295–296
  - collection 164, 164, 166, 280–281, 281
  - glucose concentration 325
- Carbol fuchsin solution 354
- Card agglutination trypanosomiasis test (CATT) 188–192, 189–192
- Cary-Blair transport medium 216–217, 354
- Casts, urine 240, 243–244, 243–244
- Catheters 233
- CATT, *see* Card agglutination trypanosomiasis test
- Cavity body fluids, specimens 218–219
- Cellophane faecal thick smear technique 141–143, 142–143
- Cells
- blood 125, 125, 265–266, 265–266
  - plasma 312, 312
  - polymorphonuclear 310–311, 311, 313, 313
  - target 306, 307
  - urine specimens 241–243, 241–243
- Centrifugation 69, 166–168

- Centrifuges 32, 69–72, **69–73**  
balancing 72, **72**  
cleaning and maintenance **83**  
tubes 34, 37
- Cerebrospinal fluid (CSF) 255–264, **255–264**  
blood in 256–259, **256–259**  
glucose concentration 7, **261–262**  
laboratory registers 47, **50**  
leukocyte number concentration/  
fraction 6, **258–259**  
meningitis 260–261, **260–261**  
protein concentration 262, **262**  
specimen containers 44, **82**  
specimen dispatch **92**  
trypanosomes **259–260**, 260
- Chagas disease **192–194**, 193–194
- Chancre, syphilitic 210, **210**
- Chemical formulae, reagents **350**
- Chemicals, storage **45**
- Children (*see also* Infants; Neonates)  
Chagas disease **192–194**, 193–194  
erythrocyte number concentration **287**  
erythrocyte volume fraction **284**  
*Haemophilus influenzae* 261, **261**  
leukocyte number concentration **291**  
leukocyte type number fraction **320**  
normal haemoglobin **275**  
normal thrombocytes **321**  
reticulocyte number concentration **318**  
venous blood collection 267
- Chilomastix mesnili* **115–116**, 117, 121, **121**
- Chinese liver fluke (*Clonorchis sinensis*) 106, 130, 134, **134**
- Chloramine **85**
- Cholesterol crystals, urine **247**, 248
- Chromatoid bodies **122**
- Ciliates  
cysts 121, **121**  
motile forms 111, **116**, 117  
pathogenicity 111
- Cleaning **77–85**, 78–82  
centrifuges **83**  
glassware **77–81**, 78–81  
incubators **83**  
laboratory balances 66–67  
microscopes 65, **64–65**  
reusable syringes/needles **81**  
specimen containers **81–82**, 82
- Clonorchis sinensis* (Chinese liver fluke) 106, 130, 134, **134**
- Clotting  
blood 266, **266**, 297–298, **297–298**  
CSF **257**
- Coccidia 122, **122**, 124
- Colorimeters 32, 271–274  
AHD method 276–277  
calibration **277–278**, 278, 279, 324
- Colour reagent **367**
- Communicable diseases, reporting 52
- Concentration techniques,  
parasites 152–156, **152–157**
- Concentrations  
blood glucose **322–325**, 323–324  
blood urea **325–327**  
CSF glucose 261–262  
erythrocyte number 6, 263, 284, **287–288**  
haemoglobin 7, **271–279**, 284–285  
leukocyte number 6, 265, 288–290, **288–292**  
measurement **4–6**  
reticulocyte number 6, **316–319**  
thrombocyte number 7, 266, **321**
- Condensers, microscopes 56, 56, 58, 60–61, **60**
- Confidentiality **2**
- Containers  
cleaning **81–82**, 82  
“sharps” 96  
specimens 42–44, **42–44**
- Corrosive injuries, acids/alkalis **98–100**
- Corynebacterium diphtheriae* (*see also* Diphtheria)  
specimen dispatch 207, **207**  
staining techniques 201, **201–202**
- Counters, differential 32
- Counting chambers 37  
Fuchs–Rosenthal **258–259**, 258–259  
Neubauer **259**, 288, **288–291**, 290
- Counts (*see also* Number concentrations; Number fractions)  
parasite eggs 251  
sperm **214–215**
- Coverslips, slides 80, 80, **81**
- Cresols 83
- Cresyl blue, *see* Brilliant cresyl blue
- Cryptococcus neoformans*, CSF 257, 261, **261**
- Cryptosporidium* spp. **123–124**, 124, **202–203**
- Crystals, urine **236**, 240, 245–248, **245–248**
- Crystal violet, modified Hucker **355**
- CSF, *see* Cerebrospinal fluid
- Cultures  
dispatch **206–207**, 207, **263–264**, 264  
*Mycobacterium leprae* **223**  
urine **254**  
watery stools 216
- Cutaneous leishmaniasis **195–196**
- Cuts, laboratory accidents **101**
- Cystine crystals, urine 247, **247**
- Cysts  
hyatid 151, **151**  
protozoa **118–125**, 119–122, 124–125  
stool examination 108, 109  
yeast **124–125**, 125

- Dark-field microscopy **64**, 211, 211, 216
- Decontamination  
blood spills 84  
laboratory accidents 101  
microscopes **65**
- Definitions  
mass 3  
mole 3  
quantity 2  
weight 3
- Deionizers 33
- Delafield's haematoxylin stain **355**
- Demineralized water **27–29**, 28–29, 33
- Derived units, SI **3–5**
- Dessicators 34, 37
- Diabetes 236, 239, 322
- Diacetyl monoxime  
blood urea concentration **325–327**  
stock solution **367**
- Diaphragms, microscopes 56, 57, 58, 61, **61**
- Diarrhoeal diseases (*see also* Intestinal parasites)  
common causes **105–106**  
dysentery amoebae 113, **113–114**
- Dichromate cleaning solution **355**
- Dicrocoelium* spp. (lancet fluke) 106, 131, 134, **134**
- Dientamoeba fragilis* 114, **114–115**, 120
- Differential counters 32
- Differential diagnoses  
*Entamoeba histolytica/Escherichia coli* **114**  
larvae 157, 158  
parasites and other matter 144–146, **144–146**  
tapeworms 148, 149
- Differential leukocyte counts, *see* Leukocyte type number fraction
- Digested meat fibres, identification 145, **145**
- Dilutions  
AHD reference solution **277**  
Drabkin fluid 271–275, **355–356**  
haemiglobincyanide reference solution 272–273, **272–275**
- Diphtheria (*see also Corynebacterium diphtheriae*) 201, **201–202**, 252, 253
- Diphyllobothrium latum* (fish tapeworm) 106, **152**  
adults **152**  
eggs 130, 136, **136**
- Dipstick tests  
falciparum malaria **344–346**, 345–346  
hepatitis B 344, **344**  
HIV 342, **342**  
urine **234**, **253–254**
- Dipylidium caninum* (tapeworm) 106  
adults 148, 149  
eggs 130, 135, **135**
- Direct examination  
CSF 256–257, **256–257**  
semen **212**  
stools 107, **107**  
urine **234**
- Dirofilaria* spp. 159
- Disinfectants (*see also* Cleaning; Sterilization) **85–90**
- Disodium hydrogen phosphate **361–362**
- Dispatch  
specimens **91–96**, 93–94  
CSF **263–264**, 264  
sputum **205**, **206**  
stool **109–110**, **216–218**  
throat 207, **207**  
urogenital 209, **209**
- Dispensary balances 69, **69**
- Dispensing, liquids 73–77, **73–77**
- Disposable materials 90–91, **90–91**
- Disposal  
laboratory waste **90–91**  
specimens 97
- Distilled water **24–27**, 25–26
- Distributors, water 24, **24**
- Drabkin diluting fluid 271–275, **355–356**
- Drainage, plumbing 22–23, **22–23**
- Drinking-water, disinfection **84**
- Drop bottles 35, 37
- Dropping pipettes, calibrated 75, 75
- Dry heat, sterilization 90, **89–90**
- Dual-voltage electrical equipment 16, **16**
- Duke method, bleeding time 295–296, **295–296**
- Dysentery amoebae (*Entamoeba histolytica*) 113, **113–114**
- Ear lesions, leprosy 221, **221–223**
- Echinococcus granulosus* (hydatid cyst) 151, **151**
- Ectothrix 226, 226
- EDTA dipotassium salt **356**
- Effusions, examination **218–219**
- Eggs  
helminths **126–144**, 129–144, **152–153**  
sputum/throat specimens 206–207  
urine specimens 248, **249–251**
- Electric centrifuges 70–72, **70–72**
- Electricity **12–20**  
equipment **15–17**  
equipment failure **17–20**  
meters 16  
shocks from **101**  
supply sources **12–15**
- Electronic charge regulators **14**
- ELISA, *see* Enzyme-linked immunosorbent assay
- Elliptocytes 308, **308–309**



- Endolimax nanus* 114, **114**, 120, **120**  
Endothrix 226, 226  
*Entamoeba*  
  *coli* 113, **113–114**, 118, 120  
  *hartmanni* 114, **114**, 120, **120**  
  *histolytica* 106, 113, **113–114**, **118**,  
  120  
*Enterobius vermicularis* (pinworm) 106  
  adults **146**, 147  
  eggs 126, 128, 135–137, **135–137**  
Enzyme immunoassay 331, **331**  
Enzyme-linked immunosorbent assay  
  (ELISA) 331, **341–342**, **343–344**  
Eosinophils, polymorphonuclear 310,  
  311, **311**  
Eosin solution **117–118**, **356**  
Epithelial casts, urine 243, 244  
Equipment **1–2**  
  centrifuges 70–73, **70–73**  
  cleaning **77–90**, 78–82  
  electrical **15–20**, 16–19  
  first-aid **98**  
  laboratory **32–46**, 34–35, 39–44  
  water demineralizers **27–29**, 28–29  
Erlenmeyer flasks 34, 36–37, 45  
Erythrocytes 265, **265**, **306**, 307  
  abnormal 306–310, **306–310**  
  Cabot ring bodies **309**, 310  
  CSF 257–258  
  haemoglobin relationship **284–285**  
  immature (reticulocytes) **316–319**,  
  318  
  malaria infected **179**  
  measurement **6–7**  
  nucleated **292**, 310, **310**  
  number concentration **6**, 265, 284,  
  **287–288**  
  sedimentation rate (ESR) **292–295**,  
  293–294  
  sickle-cell anaemia **314–316**, 315  
  thin blood films **305–310**, 306–310  
  urine 240, 241, **241–242**  
  volume fraction **6**, **279–287**, 280–283,  
  286–287  
ESR, *see* Erythrocytes, sedimentation  
  rate  
Estimation, *see* Calculation  
Evaporating dishes 34, 37  
Expiry dates, reagents 46  
Extension leads, electrical 19, **19**  
Exudates, examination **218–220**  
Eyepieces, microscopes **56**, **61**, 61  
Eyes  
  acid/alkali splashes in 99, **99**, **100**  
  filarial infection 160  
Facial lesions, leprosy **221–223**, 222  
Faeces, *see* Stools  
Failure, electrical equipment **17–20**  
False casts, urine 244, 244  
False positives/negatives, smear  
  staining **201**  
*Fasciola* spp. 106, 128, 138, **138**  
*Fasciolopsis buski* 106, 128, 138, **138**  
Fatty casts, urine 243, 244  
Female patients, urogenital  
  specimens 208, 209, **215**  
Fibrinogen, deficiency 298  
Field stains **356–357**  
  faecal trophozoites **117**  
  malaria parasites **177–178**  
  thin blood films 299, 304, **304–305**  
Filariae **159–172**, 162–163  
  blood infection **163–172**, 166–167,  
  171–172  
  geographical distribution **160**, **165**,  
  172  
  skin infection **160–163**, 161–163  
Filariasis, *see* Filariae  
Films (*see also* Slide preparation)  
  thick blood **173–182**, 175, 187, **187**,  
  193–194, **193–194**  
  thin blood **173–179**, 175–176,  
  178–181, **299–314**, 300–304,  
  306–314  
Filter funnels 34  
Filters  
  microscopes 57  
  water 24, **24**  
Filtration, parasite detection **168–170**,  
  169, 250–251, **250–251**  
Fire risk, electricity 17  
First aid **98–101**, 99  
Fish tapeworm (*Diphyllobothrium*  
  *latum*) 106, **152**  
  eggs 128, 134, **134**  
Fixation  
  biopsy specimens **95–96**  
  smears **197**, 199, **199**  
Fixatives 95, **362–363**, **368**  
Flagellates  
  cysts 121, **121**, **123**  
  motile forms 111, 115–116, **115–116**  
  pathogenicity 111  
Flaming, sterilization 90, **90**  
Flammable liquids, precautions 97  
Flasks 34, 36–37  
Flatworms, *see* Flukes  
Flotation techniques, parasite  
  detection 152–153, **152–153**  
Flukes (*see also* *Schistosoma* spp.)  
  liver, transmission routes **106**  
  stools 150–151, **150–151**  
Fluorescent treponemal antibody-  
  absorbed (FTA-Abs) test,  
  syphilis **346–347**  
Fluoride oxalate anticoagulant **357**  
Forceps 35, 36, 38  
Foreign substances, urine  
  specimens **244–245**, 245  
Formaldehyde **357**  
  stool preservation 109, 110, **110**  
Formaldehyde–detergent sedimentation  
  technique **154–156**, 155–156

- Formaldehyde–ether sedimentation technique **153–154**, 154
- Formol gel test, leishmaniasis **196**
- Formulae, reagents **350**
- FTA-Abs, *see* Fluorescent treponemal antibody-absorbed test
- Fuchs–Rosenthal counting chamber 258, **258–259**
- Fungi 204, **224–228**, 226, 228–229  
CSF 257, 261, **261**  
identification **124–125**, 125, 146, 146  
urine 240, 248, **248**, 252, 253
- Fuses, electrical 18, **18**
- Gas burners, precautions **97**
- Generators, electrical supply **13**
- Genital specimens, *see* Urogenital specimens
- Geographical distribution  
filarial parasites **160**, **165**, 172  
malaria parasites **173**
- Giardia intestinalis* 115, **115**, 121, **121**
- Giemsa stain 175–177, 299–300, **304**, 305, **357–358**
- Glassware 34–35, **36–37**  
autoclaving 87, 87  
cleaning **77–81**, 78–81  
disinfection **84**  
heating precautions **97**  
injuries from **101**  
making in the laboratory **33**, 39–42, **39–42**  
still 25, 26  
storage **45**  
tubing 37, 39–42, 39–42
- Globulins, CSF (Pandy test) **262–263**, 263
- Glucose  
blood concentrations **322–325**, 323–324  
CSF specimens **261–262**  
substance concentration **7**  
urine specimens 236, **236**
- Glucose reagents **358**
- Glycerol–malachite green solution **359**
- Gonococcal infection 197, 215  
urogenital specimens **207–208**, 208, 253
- Gonorrhoea, *see* Gonococcal infection
- Graduated conical glasses 77
- Graduated pipettes 73, **73**
- Gram staining 199–201, **199–201**  
acetone–ethanol decolorizer **351**  
CSF specimens 260–261, **260–261**  
urine specimens **252–253**, 253
- Granular casts, urine 243, 243–244
- Granulocytes, immature 313, **313**
- Habitat, common filarial parasites **165**
- Haematology (*see also*  
Haemoglobin) **265–321**  
blood cell types 265–266, **265–266**
- Haematology (*continued*)  
blood clotting 297–298, **297–298**  
erythrocytes **279–288**, 280–283, 286–287  
ESR **292–295**, 293–294  
leukocytes **319–321**, 320  
microscopes 32  
registers 47, **49**  
reticulocytes **316–318**, 317  
specimen collection 267–270, **267–270**  
test equipment **37**, **42–43**  
thin blood films **299–314**, 300–304, 306–314  
thrombocytes **321**
- Haemoglobin  
erythrocyte relationship **284–285**  
estimation **7**, **271–279**, 272–273, 275, 278, 284–285  
H bodies 319
- Haemoglobinometers, *see* Spectrophotometers
- Haemophilia 298, **298**
- Haemophilus influenzae* 257, 259, 261, **261**
- Hair  
fungal infections **225–226**, 227  
specimen dispatch **93**
- Hand-operated centrifuges 70, **70**
- Hansen disease, *see* Leprosy
- Harada–Mori sedimentation technique **156–157**
- $\beta$ -hCG, *see*  $\beta$ -Human chorionic gonadotropin
- Heads, centrifuge 70, 71
- Heinz bodies 319
- Helminths  
intestinal 105, **125–152**, 129–151, **156–159**  
adults **146–152**, 147–151  
eggs 125, **126–144**, 129–144  
larvae **156–159**, 158  
transmission routes **106**
- Heparinized tubes 42
- Hepatitis, tests **342–344**, 344
- Heterophyes heterophyes* 106, 128, **138–139**, 139
- HIV, *see* Human immunodeficiency virus
- Hookworm (*Ancylostoma duodenale*/*Necator americanus*) 106  
adults **148**, 150  
eggs 126, **127**, 128, 133, 152, 152  
larvae **157**, 158
- Hot-air ovens 33, **89–90**
- Household bleaches **84–85**
- Howell–Jolly bodies, erythrocytes 309, **309**
- $\beta$ -Human chorionic gonadotropin ( $\beta$ -hCG) **339**
- Human immunodeficiency virus (HIV) **341–342**, 342

- Hyaline casts, urine 243, 243
- Hydatid cysts (*Echinococcus granulosus*) 151, 151
- Hydrochloric acid 359
- Hygiene, intestinal parasites 106
- Hymenolepis* spp. (tapeworm)  
adults 148, 149  
eggs 128, 139, 139, 152
- Hypersegmented polymorphonuclear neutrophils 313, 313
- Hypochlorite solutions 84–85
- Identification
- Bacillus anthracis* 204, 204
  - Balantidium coli* 116, 117, 121, 121
  - Blastocystis hominis* (yeast) 124–125, 125
  - blood parasites
    - microfilariae 163–172, 166, 167, 169, 171–172
    - Plasmodium* spp. 173–182, 174–176, 179–181
    - Trypanosoma* spp. 187, 185–194, 193–194
  - Corynebacterium diphtheriae* 201, 202
  - filariae 159–172, 162–163, 166–167, 171–172
  - fungi 124–125, 125, 146
  - helminths
    - adults 146–152, 147–151
    - eggs 126–144, 129–144
    - larvae 156–158, 158
    - tapeworms 149
  - intestinal protozoa 111–117, 111–125, 119–122, 124
    - amoebae 113–114, 113–115, 118, 120, 120
    - ciliates 116, 121, 121
    - coccidia 122, 122
    - flagellates 115–116, 115–116, 121, 121
  - Leishmania* spp. 195–196, 196
  - leukocytes 125, 125
  - pollen grains 146, 146
  - pus 125, 125
  - starch granules 144, 144–145
  - Yersinia pestis* 204
- Immunofluorescence 332–333, 332
- Immunoglobulins, *see* Antibodies
- Immunology 328–349, 329–336
  - antibodies 328–329, 329
  - antigens 329–330
  - immune system 328, 329
  - immunochemical techniques 330–335
  - tests 336–349
- Incineration, laboratory waste 90, 90–91
- Incubators, cleaning and maintenance 83
- Infants (*see also* Children; Neonates)
  - capillary blood collection 280
  - erythrocyte number concentration 287
- Infants (*continued*)
  - erythrocyte volume fraction 284
  - leukocyte number concentration 291
  - leukocyte type number fraction 320
  - normal haemoglobin 275
  - normal thrombocyte counts 321
  - pinworm egg collection 135–137, 135–137
  - reticulocyte number concentration 318
  - stool specimens 217
  - urine collection 234
- Infection sources
  - African trypanosomiasis 183
  - blood/skin parasites 160
  - Chagas disease 193
  - intestinal parasites 106
  - leishmaniasis 194
- Infectious mononucleosis 313
- Injuries, laboratory accidents 98–101, 99
- Inoculating loops 197–198, 198
- Instruments 32
  - disinfection 84
  - storage 45
- Intestinal parasites 105–159
  - concentration techniques 152–156, 152–157
  - helminths 125–152, 129–151
    - adults 146–152, 147–151
    - eggs 125, 126–144, 129–144
    - larvae 156–158, 158
  - protozoa 111–117, 111–124, 119–122, 124–125
    - amoebae 113–114, 113–115, 118–120, 120
    - ciliates 116, 121, 121
    - coccidia 122, 122
    - cysts 118–124, 119–122, 124–125
    - flagellates 115–116, 115–116, 121, 121
  - sedimentation techniques 153–157, 154–156
  - stool specimens 107–110, 107–111, 159–161
  - transmission routes 106
- Inventories, supplies 46
- Iodamoeba butschlii* 114, 114, 120, 121
- Iodine 85, 123
- Iron deficiency 288
- Isospora belli* 124
- Isotonic saline, *see* Sodium chloride
- Kahn tubes 34
- Kato–Katz technique, *Schistosoma mansoni* infection 141–143, 142–143
- Ketone bodies, urine specimens 239–240, 239–240
- Labelling
  - biopsy specimens 96

- Labelling (*continued*)  
   specific reagents **350–368**  
   specimens for transport 94  
 Laboratory workers, responsibilities 2  
 Lactophenol cotton blue mounting  
   solution **359**  
 Lamps, microscopes **58–60, 59**  
 Lancet flukes (*Dicrocoelium* spp.) 106,  
   128, 134, **134**  
 Lancets 36  
 Larvae (*see also* Microfilariae) **156–157,**  
   158  
   stool specimens 109  
   urine specimens 248  
 Latex agglutination techniques 336,  
   **336, 338**  
 Lead batteries **14–15**  
 Lead poisoning 255, **309**  
 Leishman stain 299, **303, 305, 354, 359**  
 Leishmaniasis (*Leishmania* spp.)  
   **194–196, 196**  
 Lenses, microscopes 53–54, 54  
 Leprosy (*Mycobacterium leprae*)  
   **220–224, 221–223**  
 Leukaemia 285, 291, 313  
 Leukocytes 125, **125, 265, 265, 310–314,**  
   311–314  
   CSF specimens **255–257, 255–257**  
   malaria **180–182**  
   number concentration **6, 265, 288–**  
   290, **288–292**  
   type number fraction **6, 259, 319–320,**  
   320  
   urine specimens 240, 242, **242–243**  
 Leukocytosis 291  
 Leukopenia 291  
 Liquids  
   heating precautions **97**  
   measurement/dispensing 73–77,  
   **73–77**  
 Litre, measurement **4–5**  
 Liver diseases 306, 307  
 Liver flukes, *see* Flukes  
*Loa* spp. **159–160, 163, 165, 172**  
 Loeffler methylene blue **204, 360**  
 Lugol iodine **360**  
*Lutzomyia longipalpis* 194  
 Lymphatic system, filarial worms 159  
 Lymph nodes, aspiration **183–185,**  
   184–185  
 Lymphoblasts **313, 314**  
 Lymphocytes 311–313, **311–313**  
 Lymphocytosis 320  
 Lymphopenia 320  
 Lysis time, blood specimens 297–298,  
   **297–298**  
 Lysol 84–85  
  
 Macrocytes **307, 308**  
 Macroscopic examination, *see* Direct  
   examination  
 Madura foot, *see* Mycetoma  
  
 Magnification, microscopes **53–56,**  
   54–56  
 Maintenance (*see also* Repairs)  
   batteries **15**  
   burettes **77**  
   centrifuges **83**  
   incubators **83**  
   lead batteries **15**  
   microscopes **64–66, 65**  
   water-baths **83**  
 Malaria (*see also* *Plasmodium* spp.) 159,  
   **172–182, 178, 291, 309**  
   blood cells 312, 313, 320  
   dipstick test **344–346, 345–346**  
 Male patients, urogenital  
   specimens 197, **207–208,**  
   **209–210**  
*Mammomonogamus laryngeus* 205  
 Mancini technique, *see* Radial  
   immunodiffusion  
*Mansonella* spp. **159–160, 163, 163, 165,**  
   172  
 Markers, hepatitis B virus **342–343**  
 Mass, definition 3, 5  
 May–Grünwald stain 299, **304, 305,**  
   354, **360**  
 Mean erythrocyte haemoglobin  
   concentration **285–286**  
 Measles 312, 313, 320  
 Measurement (*see also* Calculations;  
   Number concentrations; Number  
   fractions) **2–7**  
   balances 32, **66–69, 67–69**  
   bleeding time 295–296, **295–296**  
   blood clotting 297–298, **297–298**  
   ESR **292–295, 293–294**  
   helminth eggs **126–127**  
   liquids **73–77, 73–77**  
   lysis time 297–298, **297–298**  
   metric system **2–7**  
   ocular micrometers 63, **63–64**  
   pH, urine 235, **235–236**  
   protozoa cysts 123  
   quantities **2–3**  
   traditional system **5–7**  
 Megakaryocytes 266, 314, **314**  
 Meker burners 35  
 Meningitis 255, 259  
   common causes **256**  
   CSF examination 197, 260–261,  
   **260–261, 263**  
   tuberculous 257, 259, 261, 263  
*Meningonema* spp. 159  
 Mercurothiolate, *see* Thiomersal  
*Metagonimus yokogawai* 106, 128, 139,  
   **139**  
 Meters, electricity 16, 16  
 Methylene blue solution **361**  
 Metric system **2–7**  
 Microcytes 307, **307**  
 Microfilariae **159–172, 163, 166,**  
   171–172, 249

- Microhaematocrit equipment **37**
- Micrometers, ocular *63*, **63–64**
- Micropipettes *38–39*, *74*, **74–75**
- Microscopes **32**, *38*, *53–57*, **53–66**,  
*59–63*, *65*  
adjustment system *57*, **57–58**  
cleaning **64–65**, *65*  
focusing *61*, **62–63**  
illumination system *56–57*, **56–57**, *59*,  
**59**  
maintenance **64–66**, *65*  
mirrors *56*, **56**, *60*, **60**  
precautions **65–66**  
setting up **58–61**, *59–61*  
slides *37*, **79–80**, *80*
- Microscopic examination  
acid-fast bacilli **203**  
*Bacillus anthracis* *204*, **204**, **220**  
body cavity fluid **219–220**  
*Corynebacterium diphtheriae* **202**  
CSF **257–261**, *258–261*  
fungi *226*, **226**, **227**, *229*, **229**  
gonorrhoea *208*, **209–210**  
Gram-stained organisms *200–201*,  
**200–201**, *253*  
*Leishmania* spp. **195–196**, *196*  
leukocyte type number fraction  
**319–320**  
malaria parasites *178*, **178–182**  
microfilariae in blood **164**, *166–167*,  
**166–172**, *169*, *171–172*  
microfilariae, *Onchocerca volvulus*  
*162–163*, **162–163**  
mycetoma pus specimens **227**  
*Mycobacterium leprae* *223*, **223–224**  
pityriasis versicolor *229*, **229**  
protozoa cysts *124*, **124–125**  
reticulocyte numbers *317*, **317–318**  
semen specimens *212–214*, **212–215**  
sickle-cell anaemia *315*, **315–316**  
sputum/throat specimens **206**  
stool specimens **107–109**, *108–109*  
syphilis treponemes *211*, **211**  
thin blood films **305–314**, *306–314*  
thrombocyte number concentration  
**321**  
*Trypanosoma* spp. *185–187*, **185–188**  
urine *241–248*, **241–248**, *250–253*,  
**251–254**  
vaginal discharge specimens **215**  
watery stools **216**, *217*  
*Yersinia pestis* **204**
- Mole  
definition **3**  
substance concentration **5**
- Molecular weight **3**
- Monocytes **311–312**, *312*
- Morphological index, *Mycobacterium leprae* **224**
- Mortars/pestles *35*
- Motile forms (*see also* Trophozoites)  
protozoa *111–117*, **111–118**
- Motility, spermatozoa **214**
- Mott cells *259*, *260*
- Mycetoma, pus examination **226–227**
- Mycobacterium*  
*leprae* *202*, **220–224**, *221–223*  
*tuberculosis* *197*, *206*
- Mycology (*see also* Fungi) **225–229**, *226*,  
*228–229*
- Myelofibrosis *309*
- Myeloma *237*, *312*
- Nail specimens, dispatch **93**
- Nasal specimens, leprosy *220*, *222*,  
**223–224**, *223*
- Necator americanus* (hookworm)  
adults **148**, *150*  
eggs *126*, *128*, *140*, **140**, *152*  
larvae **157**, *158*
- Needles  
disposable **36**  
reusable *81*, **81**, *87*, **87**
- Neisseria meningitidis* *260*, **260**, *264*
- Neonates (*see also* Children; Infants)  
erythrocyte number concentration  
**287**  
erythrocyte volume fraction **284**  
immune system **328**  
leukocyte number concentration **291**  
leukocyte type number fraction **320**  
normal haemoglobin **275**
- Nephelometry, immunology **335**
- Nephrotic syndrome *247*
- Neubauer counting chambers **259**, *288*,  
**288–291**, *290*
- Neutral red **361**
- Neutropenia **320**
- Neutrophilia **320**
- Neutrophils, polymorphonuclear  
**310–311**, *311*, *313*, **313**
- New glassware, cleaning **77**
- Nickel-cadmium (Ni-Cd) batteries  
**15**
- Normoblasts, *see* Nucleated erythrocytes
- Nucleated erythrocytes **292**, *310*, **310**
- Number concentrations **5–7**  
erythrocytes *265*, **284**, **287–288**  
leukocytes *265*, *285*, *288–290*,  
**288–292**  
leukocytes in CSF *258–259*, **258–259**  
reticulocytes **316–319**  
thrombocytes *266*, **321**
- Number fractions **5–6**  
leukocyte type **6**, **259**, *319*, **319–321**  
reticulocyte **6**, **316–319**, *317*
- Occult blood, stools **157–159**, *159*
- Ocular micrometers *63*, **63–64**
- Oil droplets, identification *145*, **145**
- Onchocerca volvulus* **160–163**, *161–163*,  
**165**, *249*
- Oocysts, *Cryptosporidium* spp. **123–124**,  
*124*

- Open two-pan balances 67–68, **67–68**  
*Opisthorchis felineus*, eggs 128, 140, **140**  
 Ordering, supplies **46**  
 Orthostatic proteinuria 237  
 Ovens, hot-air 33, **89–90**
- Packed cell volume, *see* Erythrocyte volume fraction  
 Packing, specimens for dispatch **91–94**, 93–94  
 Pandy reagent **361**  
 Pandy test, CSF globulin **262–263**, 263  
 Panels, solar **13–14**  
*Paragonimus westermani* 106, 128, 140, **140**  
 Parasites (*see also* Intestinal parasites) **105–196**, 320  
   blood 159–160, 163–194, 178, 186–187, 189–194, 196  
   malaria **172–182**, 178  
   microfilariae **159–172**, 163, 166, 171–172  
   protozoa **172–196**, 178, 185, 187, 193–194  
   trypanosomiasis **182–194**, 184–187, 189–192  
   concentration techniques 152–156, **152–156**  
   laboratory registers 47, **49–51**  
   leishmaniasis **194–196**  
   skin **159–163**, 161–163, **195–196**, 196  
   sputum/throat 205  
   transmission routes **106**  
   urine 240, 248, **248–251**, 251  
 Pasteur pipettes  
   how to make **33**, 39–40, **39–40**  
   sterilization 87, 87  
   urogenital specimens 209, **209**  
 Pathogenicity, intestinal protozoa **111**  
 Pelvic cells, urine 242, **242**  
 Pestles/mortars 35  
 Petri dishes 34, 37  
 Phenol red **361**  
 pH measurement, urine 235, **235–236**  
 Phosphate-buffered water **361–362**  
 Photometers 32  
 Photometric methods, haemoglobin estimation **271–279**, 272–273  
 Pinworm (*Enterobius vermicularis*)  
   adults **146**, 147  
   eggs 126, 128, 135–138, **135–137**  
 Pipettes 37–39, 73–75, **73–75**  
   cleaning **78–79**, 79  
   Pasteur **33**, 39–40, **39–40**  
   precautions 97  
 Pityriasis versicolor (*Pityrosporum furfur*) **227–229**, 228–229  
 Plans, laboratories 11–12, **11–12**  
 Plant parts, identification **145–146**, 146  
 Plasma  
   abnormal proteins 298  
   Plasma (*continued*)  
     cells 312, **312**, 328  
     erythrocyte volume fraction 279–280  
     glucose concentration **325**  
     serum comparison 266  
   *Plasmodium* spp. (*see also* Malaria) 124, 159, **173–182**, 175–176, 178  
     dipstick test **344–346**, 345–346  
 Platelets, *see* Thrombocytes  
 Plugs, electrical 18–19, **18–19**  
 Plumbing 20–23, **20–23**  
 Poikilocytes 309, **309**  
 Poisoning  
   laboratory accidents **100**  
   lead 255, 309  
 Pollen grains, identification 146, 146  
 Polycythaemia 287  
 Polymorphonuclear cells **310–311**, 311, 313, **313**  
 Polyvinyl alcohol (PVA) 110, **362–363**  
 Potassium cyanide 274  
 Potassium hydroxide **363**  
 Potassium permanganate **363**  
 Power, electrical 17  
 Precautions (*see also* Safety)  
   accident prevention **97**  
   anthrax specimens 204, 220  
   anticoagulants 43  
   autoclaving **88**  
   centrifuges **72**  
   CSF specimens **255–256**  
   electricity **19–20**  
   ELISA for hepatitis B **343–344**  
   hypochlorite solutions 85  
   microscope care **65–66**  
   pipette use 75  
   potassium cyanide 274, 356  
   potassium hydroxide 225  
   stool specimens **107**, 116  
   thin blood films **303**  
 Precipitation, immunology **334–335**, 335  
 Precipitin tubes 34  
 Prefixes, SI **4**  
 Preparation (*see also* Slide preparation)  
   reagents **350–368**  
   smears **197–199**, 198–199  
   thin blood films **299–314**, 300–304, 306–314  
 Preservation  
   stool specimens 109–110, 110  
   urine specimens **234**  
 Pressure cookers, equipment  
   sterilization **88–89**, 89  
 Prevention  
   accidents **97**  
   laboratory infections 96–97  
 Propane gas burners 97  
 Protein  
   CSF specimens 262–263, **262–263**  
   urine specimens **236–239**

- Protozoa  
  blood **173–194**, 178, 185, 187, 193–194  
  intestinal 105–106, 111–117, **111–124**, 119–122, 124  
  transmission routes **106**
- Public health, laboratory reports **47–48**, **52**
- Pus casts, urine 243, 244
- Pus specimens  
  *Bacillus anthracis* **219–220**  
  containers **83**  
  CSF 256, 256  
  dispatch **92**  
  gonorrhoea 210, 210  
  identification 125, **125**  
  mycetoma **227–228**
- PVA, *see* Polyvinyl alcohol
- Pyelonephritis 237
- Quality assurance **101–102**
- Quality control  
  AHD reagent **352**  
  demineralized water **28–29**  
  distilled water **27**
- Quantities, measurement **2–7**
- Quaternary ammonium compounds (QUATS) **85**
- QUATS, *see* Quaternary ammonium compounds
- Radial immunodiffusion 335, **335**, **339–341**
- Radioimmunoassay 330, **330**
- Rapid Field stain, trophozoites **117**
- Rapid plasma reagin (RPR) test, syphilis **346**, **347–348**, 348
- Reagents **1**, **350–368**  
  acetic acid **350–351**  
  acetone–ethanol decolorizer **351**  
  acid–ethanol for Ziehl–Neelsen stain **351**  
  acid reagent **351**  
  Albert stain 201, **351**  
  alkaline haematin D reagent 276, **352**  
  Amies transport medium **352–353**  
  Benedict solution **353**  
  benzoic acid **358**  
  blank reagent **353**  
  boric acid **353**  
  brilliant cresyl blue **353**  
  buffered glycerol saline **353–354**  
  buffered water, pH 7.2 29–31, **354**  
  Carbol fuchsin solution **354**  
  Cary–Blair transport medium **354**  
  chemical formulae **350**  
  colour reagent **367**  
  crystal violet, modified Hucker **355**  
  Delafield's haematoxylin stain **355**  
  diacetyl monoxime stock solution **367**  
  dichromate cleaning solution **355**
- Reagents (*continued*)  
  disodium hydrogen phosphate stock solution **361–362**  
  Drabkin diluting fluid **355–356**  
  EDTA dipotassium salt **356**  
  eosin **356**  
  expiry dates 46  
  Field stains 117, **356–357**  
  fixatives 95, **362–363**, **365–366**, **368**  
  fluoride oxalate anticoagulant **357**  
  formaldehyde **357**  
  Giemsa stain **357–358**  
  glucose reagents **358**  
  glycerol–malachite green solution **359**  
  hydrochloric acid **359**  
  lactophenol cotton blue mounting solution **359**  
  Leishman stain **359**  
  Loeffler methylene blue 204, **360**  
  Lugol iodine **360**  
  May–Grünwald stain **360**  
  methylene blue solution **361**  
  modified Schaudinn fixative **362**  
  neutral red **361**  
  Pandy reagent **361**  
  phenol red **361**  
  phosphate-buffered water **361–362**  
  polyvinyl alcohol (PVA) fixative **362–363**  
  potassium hydroxide **363**  
  potassium permanganate **363**  
  safranin solution **363**  
  saponin **363–364**  
  silver nitrate **364**  
  sodium bicarbonate **364**  
  sodium carbonate **364**  
  sodium chloride **364**  
  sodium hydroxide **364–365**  
  sodium metabisulfite **365**  
  streptolysin O **336–338**  
  Stuart transport medium, modified **365**  
  sulfosalicylic acid **365**  
  thiomersal–iodine–formaldehyde (TIF) **365–366**  
  *o*-toluidine **322–325**, 323–324, **358**  
  trisodium citrate **366**  
  Türk solution **366**  
  urea reagents 325, **366–367**  
  Wayson stain 203, **367**  
  Willis solution 152, **368**  
  Wintrobe solution **368**  
  Zenker fixative **368**  
  Ziehl–Neelsen stain **202–203**, 219, 221, 351, 354
- Records, laboratory 38, **47–52**, **223–224**
- Red blood cells, *see* Erythrocytes
- Reference laboratories, specimen dispatch **91–96**, 93–94
- Reference ranges  
  blood glucose concentrations **324–325**

- Reference ranges (*continued*)  
 blood urea concentrations **327**  
 erythrocytes **284, 287**  
 ESR **293–294**  
 leukocytes **291, 320**  
 normal haemoglobin **275**  
 reticulocytes **318**  
 thrombocytes **321**
- Reference solutions, haemoglobin  
 272–273, **272–273**
- Refrigerators 32
- Registers (*see also* Records)  
 specimens **47–51**
- Renal cells, urine 242–243, **242–243**
- Renal disease 236
- Repairs (*see also* Maintenance)  
 electrical equipment 17–19, **17–20**  
 microscopes 65  
 plumbing 20–23, **20–23**
- Reports, laboratory 38, **47–48, 52, 251, 253**
- Resolving power, microscopes 55
- Responsibilities, laboratory workers 2
- Results, reporting **47–48, 52, 251, 253**
- Reticulocytes **6, 310, 310, 316–319, 317**
- Reusable needles 81, **87, 87**
- Reusable syringes 81, **81, 87, 87**
- Rheumatoid factors, determination 336, **336**
- Ringworm **225–226, 226**
- Romanowsky stains 265, 299
- Roundworm (*Ascaris lumbricoides*) 106  
 adults **146, 147**  
 eggs 126, **127–128, 133, 133, 152**
- RPR, *see* Rapid plasma reagin
- Safety (*see also* Precautions)  
 electricity **19–20**  
 in the laboratory **97**  
 pressure cookers 89
- Safety bulbs, rubber 35
- Safranin solution **363**
- Sand filters 24, 24
- Sanitation, plumbing 20–23, **20–23**
- Saponin **363–364**
- Scale readers, erythrocyte volume  
 fraction **280–281**
- Scalpels 36
- Schaudinn fixative, modified **362**
- Schistocytes 308, **308**
- Schistosoma*  
 eggs 128, 140–141, **140–143**  
*haematobium* 248, 248, **249–251, 250–251**  
*mansoni* **141–143, 142–143**  
 spp. (blood flukes) 108, **150–151, 151**
- Schistosomiasis (*see also* *Schistosoma*) 320  
 urine detection 234, 240, 248, 248, **249–251, 250–251**
- Sedimentation rate, erythrocytes  
 (ESR) **292–295, 293–294**
- Sedimentation techniques **153–157, 154–156, 250**
- Semen specimens **211–215, 212–214**
- Serological tests  
 African trypanosomiasis **188–192, 189–192**  
 registers 47, **51**
- Serum  
 glucose concentration **325**  
 plasma comparison 266
- Sharps containers 96
- Shocks, electric **101**
- SI units (International System of Units) 2–7, 271
- Sickle-cell anaemia 292, 307, 307–308, 310  
 test **314–316, 315**
- Silver nitrate **364**
- Sink traps, plumbing 22–23, **22–23**
- Sizes, helminth eggs **132**
- Skin  
 acid/alkali splashes on **98, 100**  
 disinfection **84**
- Skin specimens (*see also* Slit skin specimens)  
 dispatch **93**  
 fungal infections **225–229, 226, 228–229**  
*Mycobacterium leprae* **220–224, 221–223**  
 parasites **159–163, 161–163, 195–196, 196**
- Sleeping sickness, *see* African trypanosomiasis
- Slide preparation (*see also* Thick blood films; Thin blood films) 198–201, **198–204, 204**  
 anthrax diagnosis **220**  
 body cavity fluids **218–219**  
 erythrocytes **305–310, 306–310**  
 fungal infections **225–226, 226, 228–229, 229**  
 gonorrhoea diagnosis 208  
 leprosy diagnosis **222–224, 223**  
 malaria diagnosis **173–179, 175–176**  
 semen specimens **212**  
 sputum/throat specimens 206  
 syphilis diagnosis **210**  
 urine specimens 252, **252**  
 vaginal discharge specimens **215**
- Slides  
 cleaning **79–80, 80**  
 supplies 37
- Slit skin specimens  
 cutaneous leishmaniasis **195–196, 196**  
 leprosy **221–222, 222**  
*Onchocerca* 161–162, **161–162**
- Smears  
 CSF 259, 260–261, **260–261**  
 faecal **141–143, 142–143**  
*Mycobacterium leprae* **220–225, 223**



- Smears (*continued*)  
preparation/fixation **197–199**,  
198–199  
staining techniques 199–201,  
**199–204**, 204
- Soaps, identification 145, **145**
- Sodium bicarbonate **364**
- Sodium carbonate **364**
- Sodium chloride **364**  
flotation technique 152–153, **152–153**
- Sodium citrate, *see* Trisodium citrate
- Sodium dihydrogen phosphate,  
anhydrous **361–362**
- Sodium hydrogen carbonate, *see* Sodium  
bicarbonate
- Sodium hydroxide **364–365**
- Sodium hypochlorite **84–85**
- Sodium metabisulfite **365**
- Solar energy, electrical supply **13–15**
- Solar stills 26, **26–27**
- Specimen collection  
appropriate **102**  
blood 267–270, **267–270**, **280–282**,  
281, **286**  
malaria parasites 174–175, **174**  
microfilariae 164, **164**, **166**  
thin blood films **300**, 301  
trypanosomes 186, **186**, 189, **189**  
body cavity fluids **218**  
CSF 255, **255**  
fungal infection **225**, **227–228**, 228  
leprosy 221–222, **221–223**  
lymph node aspirates  
184–185, **184–185**  
pinworm eggs 135–137, **135–137**  
pus **220**, **227**  
semen **212**  
skin 161–163, **161–163**, **195**, 196  
sputum 205, **205–206**  
stools **107**, **216–217**, 217  
syphilis chancre 210, **210**  
throat swabs 206, **206**  
urine **231–232**, **238**, **241**, **249**, 252  
urogenital samples **207–208**, 215
- Specimen containers **34**, 42–44, **42–44**  
cleaning **81–82**, 82
- Specimens  
dispatch **91–96**, 93–94  
disposal 97  
registration **46–51**
- Spectrophotometers (*see also*  
Colorimeters) **271–279**  
calibration **272–274**, 273, **276–277**
- Sperm counts (*see also* Semen  
specimens) **214–215**
- Spherocytes 308, **308**
- Spherocytosis, hereditary 308
- Spinal compression 257, 262, 263
- Spirit lamps 35
- Sputum, disinfection **84**
- Sputum specimens **204–206**, 205  
containers 44, 44, 82, **82**
- Sputum specimens (*continued*)  
*Corynebacterium diphtheriae* 201,  
**201–202**  
dispatch **92**
- Staining techniques 109  
blood films 175–176, **175–178**,  
**303–305**, 304  
faecal cysts **123–124**, 124  
faecal trophozoites **117–118**  
*Leishmania* spp. **195**  
microfilariae **170–171**, 171–172  
*Onchocerca volvulus* 163, **163**  
*Plasmodium* spp. 175, **177**  
smears 199–201, **199–204**, 204
- Staining troughs 34
- Stains (*see also* Staining techniques;  
Ziehl–Neelsen stain)  
Albert 201, **201–202**, **351**  
brilliant cresyl blue 316–317, 317,  
**318–319**, **353**  
Delafield's haematoxylin **355**  
eosin **117–118**, **356**  
Field **117**, **356–357**  
Giemsa 299–300, **304**, 305, **357–358**  
Gram **199–201**  
Leishman **359**  
May–Grünwald 299, **304**, 305, 354,  
**360**  
Romanowsky 265, 299  
Wayson **367**
- Standard curve, haemoglobin  
concentration **273**
- Starch granules, identification 144,  
**144–145**
- Sterilization (*see also* Cleaning;  
Disinfection) **85–90**, 86–87,  
89–90  
autoclaving 86–87, **86–88**  
boiling **89**  
dry heat **89–90**, 91  
using a pressure cooker **89–90**, 90
- Stills  
demineralized water 33  
distilled water **24–27**, 25–26
- Stirring rods, how to make 40–41, **40**
- Stocktaking, supplies **45–46**
- Stools, disinfection **85**
- Stool specimens  
containers 42, **42**, **82**  
dispatch **92**  
occult blood **157–159**, 159  
parasitology 107–110, **107–110**  
watery **216–218**, 217
- Stoppers, volumetric flasks 76
- Storage  
supplies **45**  
water 24  
*Streptococcus pneumoniae* 257, 260,  
**260–261**
- Streptolysin O **336–338**
- Strongyloides stercoralis*  
eggs 109, 128, 143, **143**

- Strongyloides stercoralis* (continued)  
larvae **156–157**, 158
- Stuart transport medium 207, **209**, 264, **264**, **365**
- Subarachnoid haemorrhage 256–257, 257, 262, 263
- Sulfosalicylic acid **365**
- Sulfuric acid, handling 97
- Supplies  
electricity **12–20**  
laboratory 33, 34–35, **36–39**  
ordering procedures **46**  
stocktaking **45–46**
- Supplies (continued)  
storage **45**  
water **24–31**
- Switches, electrical 19, **19**
- Symptoms  
African trypanosomiasis **183**  
Chagas disease **192–193**  
leishmaniasis **194**  
malaria **172**
- Syphilis (*Treponema pallidum*) 197, **209–211**, 211  
tests **346–349**, 348–349
- Syringes 36, 81, **81**, 87, **87**
- Système internationale, see Units, SI
- Taenia* spp. (tapeworm) 106  
adults **146–148**, 147–149  
eggs 128, **143–144**, 144, 152  
identification 149
- Tally counters 37
- Tapeworm, fish (*Diphyllobothrium latum*) 106, 128, 134, **134**, **152**
- Tapeworm (*Taenia* spp.)  
adults **146–148**, 147, 149  
eggs 128, **143–144**, 144, 152  
identification **149**
- Taps, water supply 20–22, **20–22**
- Target cells, erythrocytes **306**, 307
- Techniques (see also Tests)  
agglutination **188–192**, 189–192, 333–334, **333–336**, 336, **338–339**  
anthrax detection 204, **204**, **219–220**  
biopsy fixation **95–96**  
blood sample staining 175–176, **175–177**  
cellophane faecal thick smear **141–143**, 142–143  
CSF examinations 256–264, **256–264**  
fungi detection **225–229**, 226, 228–229, 261, **261**  
gonorrhoea diagnosis **207–209**, 208  
leishmaniasis diagnosis 196, **195–196**  
leprosy diagnosis 221–223, **221–224**  
microfilariae detection 164, **164–172**, 166–167, 169, 171–172  
oocyst detection **123–124**, 124  
parasite concentration 152–156, **152–157**
- Techniques (continued)  
pinworm eggs examination 135–138, **135–137**  
*Plasmodium* spp. detection **173–182**, 178  
*Schistosoma mansoni* detection **141–143**, 142–143  
sedimentation **153–157**, 154–156  
semen examination 212, **212–214**  
smear staining 199–201, **199–204**, 204  
sputum/throat swab examination 205–206, **205–206**  
stools examination **107–109**, 108–109  
syphilis diagnosis **210–211**, 211, **346–349**  
tapeworm detection 147–149, **147–148**  
thin blood films 300–304, **300–314**, 306–314  
trophozoites staining **117–118**  
*Trypanosoma* spp. detection **183–194**, 184–187, 189–194  
urine protein estimation **238–239**  
Willis solution flotation 152–153, **153–154**
- Tests (see also Techniques)  
African trypanosomiasis **188–192**, 189–192  
anthrax 204, **204**, **220**  
antibody determination **339–341**  
ASOT **336–338**  
Chagas disease 193–194, **193–194**  
ELISA **341–342**, **343–344**  
falciparum malaria **344–346**, 345–346  
hepatitis **342–344**, 344  
HIV **341–342**, 342  
immunology 330–335, **330–335**  
latex agglutination 336, **336**, **338**  
leishmaniasis formol gel **196**  
*Onchocerca volvulus* **160–163**, 161–163  
rheumatoid factors determination 336, **336**  
sickle-cell anaemia **314–316**, 315  
stools occult blood **157–159**, 158  
syphilis infection **346–349**, 348–349
- Test-tubes 34, 37  
cleaning **82**  
heating precautions 97  
holders 35
- Thalassaemias 306–309
- Thermometers 35
- Thick blood films  
Chagas disease 193–194, **193–194**  
*Plasmodium* spp. **173–182**, 175  
*Trypanosoma* spp. 187, **187**
- Thiomersal, see Thiomersal
- Thin blood films **299–314**, 300–304, 306–314  
*Plasmodium* spp. **173–182**, 175  
preparation 300–303, **300–303**  
staining **303–305**, 304

- Thiomersal-iodine-formaldehyde (TIF) 109, **110**, **365-366**
- Thiosemicarbazide, blood urea concentrations **325-327**
- Threadworm, *see* Pinworm
- Throat specimens **92**, **206-209**, *208-209*
- Thrombocytes *266*, **266**  
deficiency 298  
number concentration **7**, **321**
- TIF, *see* Thiomersal-iodine-formaldehyde
- Timers 35
- Tinea infection **225-226**, *226*
- o*-Toluidine reagent **322-325**, *323-324*, **358**
- Tongue depressors 36
- Tools  
electrical repairs *17*, **17**  
laboratory 38  
plumbing *20*, **20**
- Tourniquets, blood collection *268*, **268**
- Toxoplasma gondii* 124
- Traditional system, measurement **5-7**
- Transformers, electrical 17
- Transmission  
African trypanosomiasis 183  
blood/skin parasites 160  
Chagas disease **193**  
intestinal parasites **106**  
leishmaniasis **194**
- Transport  
biological specimens **91-96**, *93-94*  
lead batteries 14  
specimens, *see* Dispatch
- Transport media 263-264  
Amies **352-353**  
buffered glycerol saline **218**  
Cary-Blair **216-217**, **354**  
Stuart *207*, **209**, *264*, **264**, **365**
- Treponema*  
*pallidum* 209-210, **346-349**  
*pertenue* 210-211
- Trichloroacetic acid 322-323, 353, **358**, **366**
- Trichomonas*  
*hominis* **115**, *116*  
*vaginalis* 215, 249
- Trichostrongylus* spp. 106, 128, *144*, **144**
- Trichuris trichiura* (whipworm) 106  
adults *150*, **150**  
eggs 126, 128, *144*, **144**, 152
- Triple phosphate crystals, urine **245**, *246*
- Trisodium citrate **366**
- Trophozoites *111-117*, **111-118**  
amoebae *113-114*, **113-115**  
ciliates **116**, *117*  
flagellates *115-116*, **115-116**  
staining methods **117-118**  
urine specimens 240, 249
- Trypanosoma* spp. 159, **182-194**, *185*, *187*, *193*  
CSF **259-260**, *260*
- Trypanosomiasis (*see also* *Trypanosoma* spp.) 161, 295  
African **183-192**, *184-187*  
Chagas disease **192-194**, *193*
- Tubercle bacilli 253, *253*
- Tuberculosis 197, 295
- Tuberculous meningitis 257, 259  
CSF examination **263**  
Ziehl-Neelsen staining **261**
- Tubes (*see also* Test-tubes)  
centrifuge *72*, **72**  
glass 33, *34*, 37, *39-40*, **39-42**  
Westergren 37
- Turbidimetry, immunology **335**
- Türk solution **366**
- Type number fraction, leukocyte **6**, 259, *319*, **319-320**
- Typhoid fever 291, 320
- Units, SI **2-7**
- Urates, urine *246*, **246**, *247*, **247**
- Urea **7**, **325-327**
- Urea reagents **325**, **366-367**
- Uric acid crystals, urine *245*, **245**
- Urine  
disinfection **84**  
neutral 245-246, 248
- Urine specimens **231-254**, *235-236*, *239-248*, *250-253*  
abnormalities detection *241-248*, **241-248**  
analysis register 47, **49**  
bacteriological examination **251-254**, *252-253*  
blood **234**, *241-242*, **241-242**  
casts *243-244*, **243-244**  
cells *241-243*, **241-243**  
containers 44, **82**  
crystals **236**, *245-248*, **245-248**  
dispatch **93**  
foreign substances **244-245**, *245*  
glucose detection *236*, **236**  
 $\beta$ -hCG determination **339**  
ketone bodies *239-240*, **239-240**  
pH measurement *235*, **235-236**  
preservation **234**  
protein detection **236-239**  
*Schistosoma haematobium* *248*, *248*, **249-251**, *250-251*
- Urogenital specimens  
gonorrhoea **207-208**, *208*  
syphilis **209-210**, *210*  
vaginal discharge **215-216**
- Vacuum pumps 79, *79*
- Vaginal discharge specimens **215-216**
- Vectors (*see also* Transmission)  
common filarial parasites **165**

- Venous blood  
collection 267–270, **267–270**, 281, 286  
examination **166–170**  
glucose concentration 325  
*Vibrio cholerae* 216, 217  
Vincent's bacilli 199, 201, **201**  
Virus infections 312, 313, 321  
diarrhoeal disease 105  
hepatitis **342–344**, 344  
Visceral leishmaniasis **196**  
Voltage, electrical supply **16**  
Volume fraction, erythrocyte **6**, **279–287**, 280–283, 286  
Volume, SI derived units of **4–5**  
Volumetric flasks 34, **75–76**, 76  
Volumetric pipettes **73–74**, 74
- Wall sockets, electrical 19  
Wash bottles 35, 37, 42, **41–42**  
Waste disposal 90–91, **90–91**  
Watch glasses 34, 37  
Water  
laboratory supplies **23–31**, **354**, 361–362  
plumbing **20–23**  
waste **22–23**  
Water-baths 32, **83**  
Watery stool specimens **216–218**, 217  
Wayson stain **203–204**, **367**
- Weighing, laboratory balances **66–69**, 67–69  
Weight, definition 3  
Westergren tubes 37, **83**  
Whipworm (*Trichuris trichiura*) 106  
adults 150, **150**  
eggs 126, 128, 144, **144**, 152  
White blood cells, *see* Leukocytes  
Willis solution 152–153, **152–153**, **368**  
Wintrobe solution **368**  
Work benches, disinfection **85**  
Worms, *see* Filariae, Helminths  
*Wuchereria*  
*bancrofti* 248, 249  
spp. **159–160**, 163, **165**, 172
- Xanthochromia, CSF 257, **257**
- Yaws (*Treponema pertenu*) **210–211**, 211  
Yeasts **124–125**, 125, 204  
*Yersinia pestis* (bubonic plague) 218  
staining techniques **203–204**, 218, 219
- Zenker fixative **368**  
Ziehl–Neelsen stain 123–124, 202–203  
acid-ethanol **351**  
carbol fuchsin solution 354  
smears 221, 222–223  
tuberculous meningitis 261

---

## Selected WHO publications of related interest

---

**Basic laboratory methods in medical parasitology.**

1991 (122 pages)

**Basic laboratory methods in clinical bacteriology.**

1991 (128 pages)

**Laboratory diagnosis of sexually transmitted diseases.**

Van Dyck E, Meheus AZ, Piot P.

1999 (146 pages)

**Maintenance and repair of laboratory,  
diagnostic imaging, and hospital equipment.**

1994 (164 pages)

**Safe management of wastes from health-care activities.**

Prüss A, Giroult E, Rushbrook P, eds.

1999 (244 pages)

**Safety in health-care laboratories.**

(document WHO/LAB/97.1)

1997 (157 pages)

**Laboratory biosafety manual, 2nd ed.**

1993 (133 pages)

**Basics of quality assurance for intermediate  
and peripheral laboratories, 2nd ed.**

El-Nageh MM et al.

WHO Regional Publications, Eastern Mediterranean Series, No. 2

2002 (256 pages)

---

Further information on these and other WHO publications can be obtained from  
Marketing and Dissemination, World Health Organization,  
1211 Geneva 27, Switzerland.

This manual provides a practical guide to the safe and accurate performance of basic laboratory techniques. Intended for use by laboratory technicians working in peripheral-level laboratories in developing countries, the book emphasizes simple, economical procedures that can yield accurate results where resources, including equipment, are scarce and the climate is hot and humid.

The book is divided into three parts. The first describes the setting-up of a peripheral health laboratory and general laboratory procedures, including use of a microscope and laboratory balances, centrifugation, measurement and dispensing of liquids, and cleaning, disinfection and sterilization of laboratory equipment. Methods of disposal of laboratory waste, dispatch of specimens to reference laboratories and laboratory safety are also discussed. The second part describes techniques for the examination of different specimens for helminths, protozoa, bacteria and fungi. Techniques for the preparation, fixation and staining of smears are also discussed. The third and final part describes the examination of urine, cerebrospinal fluid and blood, including techniques based on immunological and serological principles. For each technique, a list of materials and reagents is given, followed by a detailed description of the method and the results of microscopic examination.

Numerous illustrations are used throughout the book to clarify the different steps involved. A summary of the reagents required for the various techniques and their preparation is provided in the annex.

