

# Amino Acids in Animal Nutrition

Second Edition



EDITED BY  
J. RR D'NELLO



CABI Publishing

# **Amino Acids in Animal Nutrition**

**Second Edition**

---



# **Amino Acids in Animal Nutrition**

**Second Edition**

---

*Edited by*

**J.P.F. D'Mello**

*Formerly of the Scottish Agricultural College  
Edinburgh, UK*

*CABI Publishing*

**CABI Publishing is a division of CAB International**

CABI Publishing  
CAB International  
Wallingford  
Oxon OX10 8DE  
UK

CABI Publishing  
44 Brattle Street  
4th Floor  
Cambridge, MA 02138  
USA

Tel: +44 (0) 1491 832111  
Fax: +44 (0) 1491 833508  
E-mail: [cabi@cabi.org](mailto:cabi@cabi.org)  
Web site: [www.cabi-publishing.org](http://www.cabi-publishing.org)

Tel: +1 617 395 4056  
Fax: +1 617 354 6875  
E-mail: [cabi-nao@cabi.org](mailto:cabi-nao@cabi.org)

© CAB *International* 2003. All rights reserved. No part of this publication may be reproduced in any form or by any means, electronically, mechanically, by photocopying, recording or otherwise, without the prior permission of the copyright owners.

A catalogue record for this book is available from the British Library, London, UK.

**Library of Congress Cataloging-in-Publication Data**

Amino acids in animal nutrition / edited by J.P.F. D'Mello.-- 2nd ed.

p. cm.

Includes bibliographical references and index.

ISBN 0-85199-654-X (alk. paper)

1. Amino acids in animal nutrition. I. D'Mello, J.P. Felix.

SF98.A4 A44 2003

636.08'52--dc21

2002011559

ISBN 0 85199 654 X

# Contents

---

<b>Contributors</b>	vii
<b>Preface</b>	ix
<b>Abbreviations</b>	xi
<b>PART I: GENERAL ASPECTS</b>	
<b>1 Amino Acids as Multifunctional Molecules</b> <i>J.P.F. D'Mello</i>	1
<b>2 Amino Acid Analysis of Feeds</b> <i>J. Fontaine</i>	15
<b>3 Absorption of Amino Acids and Peptides</b> <i>C.R. Krehbiel and J.C. Matthews</i>	41
<b>4 An Outline of Pathways in Amino Acid Metabolism</b> <i>J.P.F. D'Mello</i>	71
<b>5 Amino Acid Metabolism in Animals: an Overview</b> <i>B.J. Bequette</i>	87
<b>6 Essential to Non-essential Amino Acid Ratios</b> <i>J. Heger</i>	103
<b>7 Adverse Effects of Amino Acids</b> <i>J.P.F. D'Mello</i>	125
<b>PART II: PIGS</b>	
<b>8 Methionine–Cystine Relationships in Pig Nutrition</b> <i>A.J. Lewis</i>	143
<b>9 Ideal Dietary Amino Acid Profiles for Pigs</b> <i>S. Boisen</i>	157
<b>10 Digestible Amino Acids in Diet Formulation for Pigs</b> <i>R. Mosenthin and M. Rademacher</i>	169
<b>11 Modelling Amino Acid Metabolism and the Estimation of Amino Acid Requirements</b> <i>P.J. Moughan and M.F. Fuller</i>	187
<b>12 Amino Acid Utilization for Reproduction in Sows</b> <i>S.W. Kim and R.A. Easter</i>	203

---

<b>PART III: POULTRY</b>	
<b>13</b>	<b>Ideal Amino Acid Patterns for Broiler Chicks</b> 223 <i>D.H. Baker</i>
<b>14</b>	<b>Responses of Growing Poultry to Amino Acids</b> 237 <i>J.P.F. D'Mello</i>
<b>PART IV: RUMINANTS</b>	
<b>15</b>	<b>Metabolism and <i>De Novo</i> Synthesis of Amino Acids by Rumen Microbes</b> 265 <i>C. Atasoglu and R.J. Wallace</i>
<b>16</b>	<b>Modelling Amino Acid Metabolism in Ruminants</b> 291 <i>R.L. Baldwin, C.C. Calvert, P.H. Robinson and H.A. Johnson</i>
<b>17</b>	<b>Amino Acid Utilization for Wool Production</b> 309 <i>S.M. Liu and D.G. Masters</i>
<b>18</b>	<b>Amino Acid Utilization by Growing and Finishing Ruminants</b> 329 <i>E.C. Titgemeyer</i>
<b>19</b>	<b>Mammary Uptake and Metabolism of Amino Acids by Lactating Ruminants</b> 347 <i>B.J. Bequette, M.D. Hanigan and H. Lapierre</i>
<b>20</b>	<b>Effects of Amino Acids on Milk Production</b> 367 <i>D.G. Chamberlain and J.-M. Yeo</i>
<b>21</b>	<b>Predicting Dietary Amino Acid Adequacy for Ruminants</b> 389 <i>D.G. Fox and L.O. Tedeschi</i>
<b>PART V: OTHER ANIMALS</b>	
<b>22</b>	<b>Canine and Feline Amino Acid Requirements for Different Physiological Functions</b> 411 <i>W.H. Hendriks</i>
<b>23</b>	<b>Amino Acid Requirements of Finfish and Crustaceans</b> 427 <i>R.P. Wilson</i>
<b>PART VI: APPLICATIONS AND PERSPECTIVES</b>	
<b>24</b>	<b>Crystalline Amino Acids and Nitrogen Emission</b> 449 <i>M.W.A. Verstegen and A.W. Jongbloed</i>
<b>25</b>	<b>Economic Assessment of Amino Acid Responses in Growing Poultry</b> 459 <i>M. Pack, D. Hoehler and A. Lemme</i>
<b>26</b>	<b>Conclusions</b> 485 <i>J.P.F. D'Mello</i>
<b>Index</b>	503

# Contributors

---

**Atasoglu, C.** Rowett Research Institute, Greenburn Road, Bucksburn, Aberdeen AB21 9SB, UK. Present address: Department of Animal Science, Faculty of Agriculture, Canakkale Onsekiz Mart University, 17100 Canakkale, Turkey

**Baker, D.H.** Department of Animal Sciences, University of Illinois, 132 Animal Sciences Laboratory, 1207 West Gregory Drive, Urbana, IL 61801, USA

**Baldwin, R.L.** Department of Animal Science, University of California, Davis, CA 95616-8521, USA

**Bequette, B.J.** Department of Animal and Avian Sciences, University of Maryland, College Park, MD 20742, USA

**Boisen, S.** Department of Animal Nutrition and Physiology, Research Centre Foulum, PO Box 50, DK-8830, Tjele, Denmark

**Calvert, C.C.** Department of Animal Science, University of California, Davis, CA 95616-8521, USA

**Chamberlain, D.G.** Hannah Research Institute, Hannah Research Park, Ayr KA6 5HL, UK

**D'Mello, J.P.F.** Formerly of The Scottish Agricultural College, West Mains Road, Edinburgh, EH9 3JG, UK

**Easter, R.A.** College of Agricultural, Consumer and Environmental Sciences, University of Illinois, 122 Mumford Hall, 1301 West Gregory Drive, Urbana, IL 61801, USA

**Fontaine, J.** Feed Additives Division, Degussa AG, Applied Technology 913-205, PO Box 1345, D-63403 Hanau, Germany

**Fox, D.G.** Department of Animal Science, Cornell University, Ithaca, NY 14853, USA

**Fuller, M.F.** Institute of Food, Nutrition and Human Health, Massey University, Palmerston North, New Zealand

**Hanigan, M.D.** Dairy Research Group, Purina Mills Inc., St Louis, MO 63144, USA

**Heger, J.** Biofaktory Praha s.r.o., Generala Píky 3, 613 00 Brno, Czech Republic

**Johnson, H.A.** Department of Animal Science, University of California, Davis, CA 95616-8521, USA

**Hendriks, W.H.** Institute of Food, Nutrition and Human Health, Massey University, Palmerston North, New Zealand

**Hoehler, D.** Degussa AG, Applied Technology Feed Additives, PO Box 1345, D-63457 Hanau, Germany



- 
- Jongbloed, A.W.** *ID-TNO Animal Nutrition, Lelystad, The Netherlands*
- Kim, S.W.** *Department of Animal and Food Sciences, Texas Tech University, Box 2141, 123 Animal Science Building, Lubbock, TX 79209, USA*
- Krehbiel, C.R.** *Department of Animal Science, Oklahoma State University, Stillwater, OK 74078, USA*
- Lapierre, H.** *Dairy and Swine R & D Research Centre, Lennoxville, Quebec, Canada J1M 1Z3*
- Lemme, A.** *Degussa AG, Applied Technology Feed Additives, PO Box 1345, D-63457 Hanau, Germany*
- Lewis, A.J.** *Department of Animal Science, University of Nebraska, Lincoln, NE 68583, USA*
- Liu, S.M.** *CSIRO Livestock Industries, Private Bag 5, PO Wembley, WA 6913, Australia*
- Masters, D.G.** *CSIRO Livestock Industries, Private Bag 5, PO Wembley, WA 6913, Australia*
- Matthews, J.C.** *Department of Animal Sciences, University of Kentucky, Lexington, KY 40546, USA*
- Mosenthin, R.** *Institute of Animal Nutrition, Hohenheim University, D-70593 Stuttgart, Germany*
- Moughan, P.J.** *Institute of Food, Nutrition and Human Health, Massey University, Palmerston North, New Zealand*
- Pack, M.** *Degussa AG, Applied Technology Feed Additives, PO Box 1345, D-63457 Hanau, Germany*
- Rademacher, M.** *Feed Additives Division, Degussa AG, Applied Technology, Rodenbacher Chaussee 4, PO Box 1345, D-63457 Hanau, Germany*
- Robinson, P.H.** *Department of Animal Science, University of California, Davis, CA 95616-8521, USA*
- Tedeschi, L.O.** *Department of Animal Science, Cornell University, Ithaca, NY 14853, USA*
- Titgemeyer, E.C.** *Department of Animal Sciences and Industry, 132 Call Hall, Kansas State University, Manhattan, KS 66506, USA*
- Verstegen, M.W.A.** *Department of Animal Sciences, Animal Nutrition Group, Wageningen University and Research Centre, PO Box 338, 6700 AA Wageningen, The Netherlands*
- Wallace, R.J.** *Rowett Research Institute, Greenburn Road, Bucksburn, Aberdeen AB21 9SB, UK*
- Wilson, R.P.** *Department of Biochemistry and Molecular Biology, Mississippi State University, Box 9650, Mississippi State, MS 39762, USA*
- Yeo, J.-M.** *Hannah Research Institute, Hannah Research Park, Ayr KA6 5HL, UK*

# Preface

---

The previous edition of this book (published in 1994 with the title *Amino Acids in Farm Animal Nutrition*) was well received by academic and commercial users and by critics undertaking reviews on behalf of international journals. Citation of individual chapters in various research publications has also been a source of considerable satisfaction.

Amino acid metabolism and nutrition of farm animals continues to be an active area of research, with new data now widely published in proceedings of international conferences and in journals. A new edition would, therefore, be justified for this reason alone. However, in addition, there is a need to take into account advances in the amino acid nutrition of a wider range of animals, including companion animals. There is also a need to address changes in focus and to recognize the efforts of new scientists in the field and the role of our commercial colleagues. I am now able to offer an enlarged version with the not too dissimilar title of *Amino Acids in Animal Nutrition*.

In this new edition of *Amino Acids in Animal Nutrition*, I have attempted to retain chapters imparting strength to the first version, while introducing authors with new ideas and vision. I have also addressed comments I received from external reviewers, chiefly to do with overlap. The book is thematically structured. Part I includes chapters of an introductory and general nature with applications to a wide range of animal species. The next four parts are species-related sections, including pigs (Part II), poultry (Part III), ruminants (Part IV) and other animals (Part V). The chapters in the final section (Part VI) cover applications and perspectives. A unifying theme emerging from these sections is the improved outlook for pure amino acids, against a backdrop of restrictions in the use of protein feeds from animal sources. Another noticeable feature of recent work is a significant shift from empirical supplementation studies to fundamentals such as signalling and molecular aspects. As ever, methodological innovations are the key to improved understanding of the amino acid nutrition of animals; examples of recent advances will be found throughout all sections of this book. Comparative issues are given greater prominence in the new edition compared to the earlier version. The aim continues to be to improve exchange and integration of information across the species barrier. Many excellent reviews on different aspects of protein and amino acid nutrition have appeared since the publication of the first edition. For example, two reviews on the measurement and significance of protein turnover and inter-organ amino acid flux recently appeared in the book entitled *Farm Animal Metabolism and Nutrition* published in 2000 by CABI Publishing.

It is hoped that *Amino Acids in Animal Nutrition* will appeal to final year undergraduates and students on Masters courses as a coherent synthesis of existing literature. Authors were once again asked to provide comprehensive reviews with a critical appraisal of current information and concepts and suggestions for further research. Since virtually all my authors are actively publishing refereed papers in their respective fields of research, readers can look forward to chapters with up-to-date information and thought-provoking ideas.

I am indebted to my team of authors who have made production of this book possible, despite their busy schedules. It is clear to me that they have invested considerable time in gathering and integrating data into lucid and comprehensive reviews. Their help with proof-reading and preparation of the index is also much appreciated.

The information set out within the individual chapters of *Amino Acids in Animal Nutrition* is presented in good faith. Although every effort has been made to verify the facts and figures, neither the editor nor CABI Publishing can assume responsibility for data presented in individual chapters or for any consequences of their use. This book necessarily contains references to commercial products. No endorsement of these products is implied or should be attributed to the editor or to CABI Publishing.

J.P.F. D'Mello  
Editor

# Abbreviations

---

AA(s)	amino acid(s)	DCAM	decarboxylated 5-adenosyl-methionine
ADG	average daily gain	DE	digestible energy
AFRC	Agricultural and Food Research Council	DM	dry matter
AID	apparent ileal digestibility	DMI	dry matter intake
AOAC	Association of Official Analytical Chemists	DNA	deoxyribonucleic acid
ASCT	alanine, serine, cysteine (and other neutral $\alpha$ -amino acids) transport	Dopa	3,4-dihydroxyphenylalanine
Asn	asparagine	EAA	essential amino acids
Asp	aspartate	EAAT	excitatory amino acid transport
ATP	adenosine 5'-triphosphate	ECP	endogenous crude protein
BBMV	brush border membrane vesicles	EU	European Union
BBSRC	Biotechnology and Biological Sciences Research Council	EUN	endogenous urinary nitrogen
BCAA	branched-chain amino acids	EUUN	endogenous urinary urea nitrogen
BCKA	branched-chain keto acids	FRS	fractional synthetic rate
BLMV	basolateral membrane vesicles	GABA	$\gamma$ -aminobutyrate
BV	biological value	GDH	glutamate dehydrogenase
CAT	cationic amino acid transport	GH	growth hormone
Cit	citrulline	GIT	gastrointestinal tract
CNCPS	Cornell Net Carbohydrate and Protein System	Gln	glutamine
cNOS	constitutive nitric oxide synthase	Glu	glutamate
CCK	cholecystokinin	Gly	glycine
cDNA	complementary DNA	Gly-Sar	glycylsarcosine
CoA	coenzyme A	GS-GOGAT	glutamine synthetase-glutamate synthase
CP	crude protein	h	hour
Cys	cysteine	HCl	hydrochloric acid
d	day(s)	HI	heat increment
DC	digestibility coefficient	His	histidine
		HMB	2-hydroxy-4-(methylthiol)butyric acid
		HPLC	high performance liquid chromatography

---

IAAP	ideal amino acid pattern	NRC	National Research Council
IEC	ion-exchange chromatography	NSC	non-structural carbohydrates
IGF-1	insulin-like growth factor-1	ODC	ornithine decarboxylase
Ile	isoleucine	PDV	portal-drained viscera
IMP	inosine monophosphate (inosinate)	PepT1	peptide transporter 1
iNOS	inducible nitric oxide synthase	Phe	phenylalanine
Leu	leucine	Pro	proline
Lys	lysine	PRPP	5-phosphoribosyl-1-pyrophosphate
MCP	microbial crude protein	RDP	rumen degraded protein
MDV	mesenteric-drained viscera	RNA	ribonucleic acid
ME	metabolizable energy	RPAA	ruminally protected amino acids
Met	methionine	RUP	rumen undegraded protein
min	minutes	SAA	sulphur amino acids
MP	metabolizable protein	SD	standard deviation
N	nitrogen	Ser	serine
NAD <sup>+</sup>	nicotinamide adenine dinucleotide (oxidized)	SMCO	S-methylcysteine sulphoxide
NADP <sup>+</sup>	nicotinamide adenine dinucleotide phosphate (oxidized)	SPI	soy protein isolate
NADPH	nicotinamide adenine dinucleotide phosphate (reduced)	TDN	total digestible nutrients
NDF	neutral detergent fibre	tRNA	transfer RNA
NE	net energy	Thr	threonine
NEAA	non-essential amino acids	TID	true ileal digestibility
NIRS	near-infrared spectroscopy	Trp	tryptophan
NO	nitric oxide	Tyr	tyrosine
NOS	nitric oxide synthase	UDP	undegraded dietary protein
NP	net protein	UMP	uridine monophosphate (uridylate)
NPN	non-protein nitrogen	Val	valine
		VFA	volatile fatty acids

# 1 Amino Acids as Multifunctional Molecules

**J.P.F. D'Mello\***

*Formerly of The Scottish Agricultural College,  
Edinburgh, UK*

---

## **Introduction**

Reviews in animal nutrition conventionally and necessarily focus on the involvement of amino acids in protein synthesis and their impact on the production of meat, milk, wool and eggs. The nutritional classification is another traditional feature due to dietary requirements for specific amino acids. However, the unique physiological and biochemical functions of particular amino acids are equally critical. In this chapter, emphasis is placed on amino acids as multifunctional bioactive molecules. Their involvement in the processes of protein synthesis has been reviewed repeatedly elsewhere and will not be considered here.

## **Classification**

Amino acids may be grouped according to their transport affinities or essential role in animal nutrition or on the basis of catabolic fate of the carbon skeleton. Additional subsets are also recognized, based on common structural features. Thus, leucine, isoleucine and valine are referred to as the branched-chain amino acids (BCAA), whereas phenylalanine and tyrosine are categorized as the aromatic amino acids. Assessments of requirements for

sulphur amino acids (SAA) are invariably based on a summation of methionine and cyst(e)ine needs, but it will be recalled that homocysteine is another member of this group. Another subset, the excitatory amino acids, includes glutamate and aspartate.

## **Transport groups**

In the context of transport systems, three main groups of amino acids may be recognized: anionic, cationic and neutral. Cellular protein synthesis and other metabolic processes demand uninterrupted delivery of all amino acids at appropriate sites. The study of amino acid transport and associated systems is thus of critical importance, for example, to those interested in the processes of intestinal absorption and brain function. Animals have a wide array of cells and this diversity is matched by a complex system of transporters of amino acids which operates on the basis of substrate specificity and ion requirements (Matthews, 2000). Thus, glutamate movement in the central nervous system is mediated via distinct Na-dependent proteins of the excitatory amino acid transport (EAAT) class. Five such transporters (EAAT1–5) have been cloned from mammalian tissue and their modulation by other proteins is the subject of

\*E-mail address: f.dmello@ed.sac.ac.uk

continuing studies (Jackson *et al.*, 2001). It is important to recognize, however, that amino acids in different classes may share the same transport system. Thus, three transport systems recognize both lysine and leucine. Details of the biochemical and molecular characterization of the various transport systems for the major classes of amino acids are presented in Chapter 3.

### Essential amino acids

Higher animals require a core of nine amino acids for maintenance and productive purposes (Table 1.1). The need for these amino acids arises from the inability of all animals to synthesize the corresponding carbon skeleton or keto acid. These amino acids are classified as 'indispensable' or 'essential' and provision of these nutrients is mandatory. Non-ruminants will receive the essential amino acids via the diet, but ruminants may also acquire substantial amounts of these amino acids through the digestion of microbial protein synthesized in the rumen. Those amino acids which animals are able to synthesize are termed 'dispensable' or 'non-essential'.

All mammals require the core of nine essential amino acids, but may also respond to dietary arginine and possibly proline as well, during the early phases of rapid growth. Endogenous synthesis of arginine from glutamate/glutamine and proline plays an important role in the provision of arginine in the pig

during the neonatal and immediate post-weaning phases (Wu *et al.*, 1997). However, it has been estimated that 40% of the arginine requirements of the rapidly growing pig must be supplied by the diet. This need arises partly because the vast majority of arginine synthesized in the urea cycle is catabolized in the liver by an active arginase within this pathway. Consequently, insufficient arginine is exported for the rapid growth of extra-hepatic tissues. It is relevant to recall in this context that sow colostrum and milk are markedly deficient in arginine (Wu and Knabe, 1994).

The cat is unique among mammals in its requirement for arginine as an essential component of the diet. Indeed, Morris and Rogers (1978) observed that one meal without arginine was sufficient to precipitate mortality in cats. Other effects included emesis, tetanic spasms and hyperammonaemia. It was concluded that the inability of the cat to synthesize ornithine is the basis of the dietary need for arginine. The cat also has a specific requirement for taurine which is directly related to its role in the prevention of retinal degeneration.

Poultry have an absolute requirement for arginine arising from a non-functional urea cycle. This dependence translates into acute sensitivity to natural structural analogues of arginine (Chapter 14).

Of the two aromatic amino acids required for protein synthesis and other functions, only phenylalanine is considered to be essential. Tyrosine is regarded as dispensable as it is readily synthesized from phenylalanine. Although

**Table 1.1.** Nutritional classification of amino acids.

Essential			
Common core	Additional species-related requirements	Conditionally non-essential	Non-essential
Lysine	Arginine (cats, poultry, fish)	Cyst(e)ine	Glutamate
Histidine	Taurine (cats)	Tyrosine	Glutamine
Leucine		Arginine	Glycine
Isoleucine		Proline	Serine
Valine			Alanine
Methionine			Aspartate
Threonine			Asparagine
Tryptophan			
Phenylalanine			

this conversion is irreversible, the presence of tyrosine in the diet may reduce the requirement for phenylalanine. However, this sparing effect of tyrosine is limited and, consequently, a minimum quantity of dietary phenylalanine should always be ensured. With regard to growing poultry, for example, at least 58% of the total aromatic amino acid requirement should be supplied in the form of phenylalanine. An analogous situation exists between methionine and cyst(e)ine (see Chapter 8). The unique relationship between tryptophan and the B-complex vitamin, nicotinamide, represents another facet of the multifunctional roles of amino acids.

It is now widely acknowledged that high-yielding animals will not achieve their genetically determined potential if the dietary N is supplied exclusively in the form of the essential amino acids. Additional N is required and highly effective sources of this non-specific N include glutamate, alanine and diammonium citrate. However, the most effective source is a mixture of the non-essential amino acids. Consequently, although animals have specific dietary requirements for the essential amino acids, some combination of the dispensable amino acids should also be provided in order to maximize performance. The issue of essential to non-essential amino acid ratios is reviewed in Chapter 6.

### Glucogenic and ketogenic amino acids

In the degradation of amino acids, the carbon skeletons follow distinct pathways (see Chapter 4). Those amino acids that are broken down to pyruvate or key intermediates of the tricarboxylic acid cycle have the potential

to yield glucose via phosphoenolpyruvate. These amino acids are referred to as glucogenic. Those amino acids that yield acetyl CoA or acetoacetyl CoA are classified as ketogenic since the latter two compounds are the precursors of ketone bodies. Some amino acids are both ketogenic and glucogenic (Table 1.2). Only leucine and lysine are exclusively ketogenic. In dogs, hepatic gluconeogenesis may be reduced by administration of amino acids with glucose prior to and during exercise (Hamada *et al.*, 1998, 1999).

### Structural analogues

A wide range of non-protein amino acids occur naturally in plants, particularly in the seeds and foliage of leguminous species.

**Table 1.2.** Glucogenic and ketogenic amino acids.

Glucogenic	Ketogenic	Glucogenic and ketogenic
Threonine	Leucine	Isoleucine
Arginine	Lysine	Phenylalanine
Methionine		Tyrosine
Valine		Tryptophan
Histidine		
Cysteine		
Glutamate		
Glutamine		
Aspartate		
Asparagine		
Glycine		
Serine		
Proline		
Alanine		

**Table 1.3.** Plant non-protein amino acids<sup>a</sup> with the potential to cause adverse effects in animals.

Arginine analogues	Aromatic amino acid analogues	Sulphur amino acid analogues	Neurotoxicogens
Canavanine	Mimosine	Selenomethionine	$\beta$ -( <i>N</i> -oxalylamino)alanine
Indospicine	3,4-Dihydroxyphenylalanine	Selenocyst(e)ine	$\beta$ -Cyanoalanine
Homoarginine		S-Methylcysteine sulphoxide (SMCO)	$\alpha,\gamma$ -Diaminobutyric acid
		Djenkolic acid	

<sup>a</sup>See Chapter 4 and D'Mello (1991) for structures and intermediary metabolism.



The non-protein group (Table 1.3) includes several structural analogues of the essential amino acids. The aromatic amino acid, mimosine, occurs in the tropical legume, *Leucaena leucocephala*, a ubiquitous species yielding palatable forage for ruminants. A structural analogue of arginine, canavanine, is widely distributed in various tropical legumes including *Canavalia ensiformis*, *Gliricidia sepium* and *Indigofera spicata*. In temperate regions, the factor causing haemolytic anaemia in cattle and sheep consuming forage brassicas has been identified as a ruminal derivative of S-methylcysteine sulphoxide, an analogue of methionine, distributed throughout the plant. It has been conventional to consider selenocysteine as a member of the non-protein group; however, selenocysteine is now recognized to be the 21st amino acid that may be incorporated into specific proteins (Atkins and Gesteland, 2000). A subset of the non-protein group contains the lathrogenic amino acids which are accorded with profound neurotoxic properties. Although these neurotoxic lathrogens have not been associated structurally with the essential or non-essential amino acids, at least two lathrogenic amino acids exert marked effects on the brain metabolism of glutamine. Consequently, some biochemical association with the amino acid neurotransmitter system embracing glutamate and  $\gamma$ -aminobutyrate (GABA) cannot be excluded.

Whereas some non-protein amino acids are profoundly neurotoxic, others exert their effects by reducing utilization of specific essential amino acids. Details of the adverse effects and underlying mechanisms will be found in Chapter 7.

### Isomers

All amino acids used in protein synthesis must be in the L-configuration. Nevertheless, animals are capable of utilizing some D enantiomorphs. Indeed the widespread commercial supplementation of diets with methionine has been accomplished with the racemic mixture. Two steps are essential in the utilization of D-amino acids: firstly, the

D-isomer must undergo oxidative deamination to the corresponding  $\alpha$ -keto acid analogue; secondly, this analogue must then undergo L-specific reamination by means of an appropriate aminotransferase reaction. There are no aminotransferases for lysine and threonine in animal tissues, hence the D-isomers of these amino acids are not nutritionally active (Table 1.4). Of all the D-amino acids that are convertible by animals, D-methionine is the most effective in replacing its L isomer. However, marginally better efficacy may still be observed with L-methionine in comparison with D-methionine or DL-methionine when levels below the requirement are employed (see D'Mello and Lewis, 1978). In addition, when racemic mixtures of other amino acids are used, D-methionine becomes less effective than the L-isomer. Species differences in D-amino acid utilization should be recognized. The mouse utilizes D- and DL-methionine less effectively than other animals, whereas both the rat and the pig use D-tryptophan more efficiently than the chick. It is apparent that the mouse is an unsuitable model for validating the efficacy of D-amino acids for other species of animals (Table 1.4).

### Deficiency

The unique sequence of amino acids in proteins demands that all amino acids, whether essential or non-essential, be present at the sites of protein synthesis. In the event of any deficit, the utilization of the remaining amino acids will be prejudiced and protein synthesis and other physiological processes will be impaired. Thus, it might be assumed that dietary deficiencies of individual essential amino acids would lack distinctive features. However, the published evidence indicates unique effects of particular amino acids. This evidence has been derived primarily from studies in which the amino acid in question has been omitted altogether. In addition, recent investigations on determination of maintenance requirements have yielded valuable data on the effects of graduated degrees of deficiency of particular essential amino acids.

**Table 1.4.** Efficacy of isomers and analogues of amino acids. Values represent growth efficacy as a percentage of that of the L-isomer. (Adapted from Baker, 1994.)

Amino acid	Chick	Rat	Mouse	Dog	Pig
D-lysine	0	0	0	–	–
D-threonine	0	0	0	–	–
D-tryptophan	20	100	30	35	80
D-methionine	90	90	75	100	100
DL-methionine	95	95	88	100	100
DL-OH-methionine	80	–	70	–	100
Keto-methionine	90	–	–	–	–
N-acetyl-L-methionine	100	100	90	100	–
D-arginine	0	0	–	–	–
D-histidine	10	0	10	–	–
D-leucine	100	50	15	–	–
D-valine	70	15	5	–	–
D-isoleucine	0	–	–	–	–
D-phenylalanine	75	70	–	–	–
L-OH-phenylalanine	70	50	–	–	–
Keto-phenylalanine	85	65	–	–	–
D-tyrosine	100	100	–	–	–

### Deletion studies

It is logical to expect that dietary deletion of one particular essential amino acid should impair growth to the same extent as the omission of another essential amino acid. However, the results of many studies show distinct differences between individual amino acids. Thus, lysine deprivation in fish, chickens and rats (see D'Mello and Lewis, 1978) is accompanied by relatively modest weight losses, whereas isoleucine or threonine deficiencies inhibit growth more severely. Median survival times for chicks fed diets devoid of lysine or histidine were 53 and 60 days. Isoleucine or valine deprivation reduced median survival times to 18 and 19 days respectively (Ousterhout, 1960). Chicks fed diets lacking in lysine or histidine were also stronger and more active than those deprived of isoleucine or valine. It has been postulated that certain peptides such as carnosine and proteins such as haemoglobin may serve as sources of histidine and lysine in times of restricted supply. Appreciable reserves of carnosine occur in muscle (Maynard *et al.*, 2001). Nevertheless, mortality will occur if animals are deprived of histidine or lysine for prolonged periods of time. Dietary omission

of a single essential amino acid might be expected to induce effects similar to deprivation of all amino acids. The experimental evidence indicates that, for example, chicks deprived of lysine survived for longer and lost less weight than those fed a protein-free diet. Similarly in rats fed a diet devoid of lysine, body water losses were less than in those fed a protein-free diet. However, rats fed diets devoid of threonine, isoleucine or methionine plus cystine lost body water to the same extent as those in the protein-free group (see D'Mello and Lewis, 1978).

Extensive morphological changes have been recorded following the imposition of severe amino acid deficiencies. It has been consistently recorded that during acute amino acid deprivation or deficiency in *ad libitum*-fed animals, there is a severe inhibition of food intake. Diet selection may also be altered under certain conditions (Hrupka *et al.*, 1997, 1999). The resulting morphological responses (Table 1.5) have been attributed to the combined effects of amino acid deficiency and energy restriction. Attempts have, therefore, been directed at overcoming the marked differences in food intake between deficient and control groups by pair-feeding or by force-feeding. However, D'Mello and

**Table 1.5.** Morphological effects of amino acid deficiencies<sup>a</sup>. (Adapted from D'Mello and Lewis, 1978.)

Organ affected	<i>Ad libitum</i> feeding conditions (long-term studies <sup>b</sup> )	Force-feeding conditions (short-term studies <sup>c</sup> )
Liver	Enhanced glycogen levels; hepatocytes in periportal region distended by lipid droplets	Excess glycogen levels; lipid accumulation in hepatic cells in periportal areas; nucleolar enlargement
Pancreas	Reduced zymogen granules; lipid droplets in acinar cells; mitochondria swollen and deformed	Decreased cytoplasm and zymogen granules in acinar cells; nucleolar enlargement; oedema
Thymus	Thymic involution; formation of giant cells; loss of normal architecture; depletion of thymocytes	Decrease of lymphocytes in cortex; loss of distinction between cortex and medulla
Muscle	Degenerative changes; lack of cross-striations in fibres; damaged fibres swollen, hyalinized and fragmented	No changes
Testes	Atrophy of seminiferous tubules and testicular interstitial cells; inhibition of spermatogenesis	No data

<sup>a</sup>As observed in rats deprived of isoleucine, threonine, lysine or histidine.

<sup>b</sup>Duration: 30 days or more.

<sup>c</sup>Feeding period: 3–8 days.

Lewis (1978) concluded that feeding method was less important than duration of exposure to the deficient diet. Thus, similar morphological effects were observed in long-term deprivation of an amino acid under *ad libitum* conditions as in short-term force-feeding conditions (Table 1.5). Exposure time appears to be a significant factor in the induction of morphological changes during amino acid deprivation. Although *ad libitum* feeding over a period of about 8 days of a diet devoid of an essential amino acid elicits no adverse histological changes in animals (D'Mello and Lewis, 1978), extensive aberrations do emerge in long-term investigations lasting 30 days or more. In many instances, these abnormalities reflect those observed in animals force-fed incomplete amino acid diets over a shorter duration (typically 3–8 days). It was noted that morphological abnormalities occur even in animals deprived of lysine or histidine (Table 1.5).

Predictably, extensive biochemical changes also occur during acute amino acid deficiency, irrespective of feeding method (Table 1.6). Under these conditions, muscle protein synthesis is rapidly reduced (Tesseraud

*et al.*, 1996), and amino acids including the one missing from the diet are released into the systemic circulation. These amino acids, together with those derived from intestinal absorption, cause an increase in hepatic protein synthesis. The partition of amino acids, however, depends on the dietary level and intake of carbohydrate. Low carbohydrate intake diminishes or eliminates the changes in hepatic protein synthesis. Thus, the biochemical effects of acute amino acid deficiencies represent the consequence of a complex nutritional imbalance rather than that of a simple deficiency (D'Mello and Lewis, 1978).

Insulin-like growth factor-1 (IGF-1) exerts an important effect on whole-body protein synthesis. This factor is complexed with up to six specific binding proteins, which are believed to modulate the biological activity of IGF-1. The results of Takenaka *et al.* (2000) indicate that a single essential amino acid deficiency may reduce IGF-1 production in rats without affecting plasma IGF-1 binding protein-1. The molecular action of specific amino acids is likely to be an important area for further research.

**Table 1.6.** Effects of acute amino acid deficiency on protein metabolism. (Adapted from D'Mello and Lewis, 1978.)

Aspect of protein metabolism	Force-feeding studies	<i>Ad libitum</i> -feeding studies
Protein content of:		
Liver	No change	Decrease
Muscle	Decrease	Decrease
Pancreas	Decrease	Decrease
Free amino acid levels in:		
Liver	Decrease	–
Muscle	Increase	–
Blood plasma	Increase	Increase
Protein synthesis in:		
Liver	Increase	Increase
Heart	Increase	–
Blood	Increase	Increase
Muscle	Decrease	Decrease
Kidney	No change	Marginal decrease

### Maintenance studies

Induction of deficiency states is an integral component of the process to determine maintenance requirements of individual amino acids (Table 1.7). The approach involves the formulation of diets with varying degrees of deficiency. For example in their studies on threonine requirements for maintenance in the chick, Edwards *et al.* (1997) used diets varying in threonine concentrations from 5 to 95% of assumed requirements for maximal growth. Chicks fed diets containing threonine at 5, 10 and 15% of

ideal requirements lost weight commensurate with the degree of deficiency. Threonine retention was also negative for these groups, in proportion to the extent of threonine deficiency. Over the entire range tested, whole-body accretion of threonine occurred with an efficiency of 82%, considerably higher than that reported for pigs (60%; Adeola, 1995). Chicks fed lysine-deficient diets retained lysine in carcass with an efficiency of 79% (Edwards *et al.*, 1999). In contrast, chicks fed graded levels of total SAA (methionine + cysteine) from 5 to 95% of ideal requirements gained weight, and retained SAA in carcass

**Table 1.7.** Whole-body accretion of amino acids in chicks.

Dietary amino acid level (% of ideal) <sup>a</sup>	Whole-body accretion (mg day <sup>-1</sup> )			
	Thr	Val	Lys	SAA <sup>b</sup>
5	-11.9	-8.7	-20.9	2.8
10	-6.4	-2.4	–	6.3
15	-2.3	–	–	–
40	40.0	53.1	15.1	50.4
55	83.2	100.0	50.5	67.9
70	116.9	139.6	100.9	93.4
95	158.4	190.1	167.2	109.8
Reference	Edwards <i>et al.</i> (1997)	Baker <i>et al.</i> (1996)	Edwards <i>et al.</i> (1999)	Edwards and Baker (1999)

<sup>a</sup>Diets deficient in the single amino acids indicated in the next four columns.

<sup>b</sup>SAA, sulphur amino acids.

in a positive and dose-related manner over the entire range of dietary concentrations (Edwards and Baker, 1999). Furthermore, efficiency of whole-body SAA accretion was only 52%, presumably reflecting the diverse functions of methionine in addition to its role as a component of tissue proteins. Although chicks fed the lysine-deficient diet maintained a stable body-weight (Edwards *et al.*, 1999) those fed the valine-deficient diet lost weight (Baker *et al.*, 1996) when each amino acid was set at 5% of ideal. However, carcass retention of lysine was  $-20.9 \text{ mg day}^{-1}$  and of valine was  $-8.7 \text{ mg day}^{-1}$  (Table 1.7). Thus equivalent degrees of deficiency induced different responses, with lysine again emerging as an amino acid with unique effects (Velu *et al.*, 1972).

## Molecular Action

The biochemical and molecular actions of amino acids are areas of increasing research interest. It is obvious that dietary amino acids will stimulate muscle protein synthesis in the postabsorptive period. This anabolic effect is partly due to increased substrate supply at the sites of protein synthesis. However, it has been proposed that individual amino acids may act as signalling molecules that serve to regulate mRNA translation. The binding of initiator methionyl-tRNA to the 40S ribosomal subunit is an important step subject to regulation *in vivo* (Table 1.8). However, Anthony *et al.* (2000a) suggest that leucine may also act in a signalling role in the stimulation of

**Table 1.8.** Diverse functions of amino acids.

Amino acids	Products	Significance/functions
21 amino acids <sup>a</sup>	Polypeptides and proteins	Hormones, enzymes and other bioactive proteins
Methionine	Formylmethionine (fMet) S-Adenosylmethionine Homocysteine	Initiator of protein synthesis Donor of methyl groups Donor of S; indicator of vitamin B <sub>12</sub> status
Tryptophan	Serotonin (5-hydroxytryptamine) Nicotinamide	Neurotransmitter B-complex vitamin
Tyrosine	Dopamine Noradrenaline Adrenaline Thyroxine	Neurotransmitter Neurotransmitter Hormone Hormone
Arginine	Nitric oxide  Polyamines	Involved in vasorelaxation; neurotransmission; male reproductive performance; gut motility Regulation of RNA synthesis; maintenance of membrane stability
Histidine	Histamine	Potent vasodilator
Glutamate	Glutamine  Glutathione  $\gamma$ -Aminobutyrate (GABA)	Purine and pyrimidine synthesis; excretion of N in avian species Reduced form involved in maintenance of cysteine residues of blood proteins in a reduced state Neurotransmitter
Glycine	Energy Porphyrins Purines	Energy source in some tissues (mucosa) Part of haemoglobin structure Components of nucleic acids
Serine	Sphingosine Cysteine	Membrane structure Important for activity of proteins
Aspartate	Urea, purines and pyrimidines	Donor of N
3-Methylhistidine	Component of actin and myosin	Index of muscle protein breakdown

<sup>a</sup>Includes selenocysteine.

muscle protein synthesis by enhancing availability of specific eukaryotic initiation factors. Further studies demonstrated that leucine is unique among the BCAA in its ability to stimulate muscle protein synthesis (Anthony *et al.*, 2000b). It is thought that these effects are independent of the action of insulin. Clearly, additional work is required to elucidate the role of leucine and other amino acids as signalling molecules.

### Amino Acids as Precursors of Bioactive Molecules

Irrespective of their position in the biochemical and nutritional classification, amino acids are involved in diverse pathways leading to the synthesis of important bioactive molecules (Table 1.8). Indeed, glutamate has been referred to as an amino acid of 'particular distinction' (Young and Ajami, 2000) and selenocysteine is now recognized as the 21st amino acid that may be incorporated into proteins (Atkins and Gesteland, 2000). Some amino acids are important precursors of neurotransmitters and certain hormones, while others are involved in N transport and in the maintenance of integrity of cell membranes.

#### Neurotransmitters

Key neurotransmitters synthesized from amino acids include GABA, serotonin, dopamine, noradrenaline and nitric oxide (Table 1.8). The pathways for the production and metabolic disposition of the three biogenic amines are now well established (Bradford, 1986); the synthesis of NO is discussed below. It is logical to expect that brain concentrations of neurotransmitters may be subject to dietary control of the amino acid precursors. One form of dietary manipulation involves the imposition of an amino acid imbalance (Harrison and D'Mello, 1986, 1987). However, results from various sources are inconclusive and may have been confounded by methodological differences among individual studies (Chapter 7).

#### Arginine

As indicated above, the primary direction of arginine metabolism in mammals occurs via the urea cycle, enabling the disposal of excess N from amino acids. However, the peripheral metabolism of arginine is also of considerable biochemical and physiological significance. Thus, the action of arginine decarboxylase permits many organisms to synthesize putrescine and other polyamines. In animals, putrescine is produced solely by the action of ornithine decarboxylase (ODC). Although the specific functions of polyamines await elucidation, recent studies suggest that these compounds are essential for normal growth and development in all living organisms, and may regulate RNA synthesis and stabilize membrane structures. Polyamine production appears to be an indispensable feature of all tissues actively engaged in protein synthesis. Arginine uptake by the mammary gland from the blood supply substantially exceeds the quantities of this amino acid secreted in milk. This is generally attributed to the need to synthesize non-essential amino acids, particularly proline, within the gland itself. However, the excess uptake of arginine may also reflect the need for polyamine synthesis by tissues actively synthesizing proteins in the mammary gland. Polyamine synthesis is an important focal point for the action of antinutritional factors. Thus in lectin-induced hyperplastic growth of the small intestine, levels of putrescine, spermidine, spermine and cadaverine are markedly enhanced (Pusztai *et al.*, 1993). On the other hand, the growth-retarding effect in chicks fed *C. ensiformis* has been attributed to inhibition of polyamine synthesis (Chapter 7). The non-protein amino acid, canavanine, present in this legume is metabolized to canaline, a potent inhibitor of ODC (D'Mello, 1993).

A striking feature of arginine relates to the synthesis of NO. The biosynthesis of NO involves the oxidation of arginine by NADPH and O<sub>2</sub> via the action of NO-synthases. It is now established that NO plays a key role in vasorelaxation, neurotransmission, immunocompetence, male reproductive performance

and gut motility (Moncada *et al.*, 1991). It is suggested in Chapter 7 that dietary canavanine may inhibit NO synthesis through its structural antagonism with arginine. Enneking *et al.* (1993) arrived at a similar conclusion from their studies on canavanine-induced feed intake inhibition in pigs.

### Homocysteine

Homocysteine is a key intermediate in SAA metabolism, positioned at the juncture between remethylation to methionine and transsulphuration to cystathionine, yielding cysteine and taurine. The importance of homocysteine in human health was highlighted at the first conference on this amino acid (Rosenberg, 1996). It is now well recognized that plasma homocysteine levels are higher than normal in patients with coronary, cerebrovascular or peripheral arterial occlusive disease (Malinow, 1996). Other investigators suggested a link between homocysteine and neural tube defects (Mills *et al.*, 1996; Rosenquist and Finnell, 2001). Furthermore, circulating concentrations of this amino acid may be of diagnostic value in assessing vitamin B<sub>12</sub> status in humans (Stabler *et al.*, 1996; Cikot *et al.*, 2001). In pigs, prolonged vitamin B<sub>12</sub> deficiency is associated with hyperhomocysteinaemia (Stangl *et al.*, 2000a) whereas in cattle a similar effect has been reported in long-term moderate deficiency of Co (Stangl *et al.*, 2000b). Co is required for ruminal synthesis of vitamin B<sub>12</sub>. It is clear that much more effort is required to elucidate the role of homocysteine in farm animals, particularly pregnant ruminants and sows.

### Immune modulators

A number of essential amino acids have been implicated in immune function. Cysteine may function as an immunoregulatory signal between macrophages and lymphocytes. It has been proposed that release of this amino acid by macrophages enhances intracellular concentrations of the cysteine-containing tripeptide, glutathione (GSH) in lymphocytes. The latter is important for T-cell activity. Miller *et al.* (2000)

observed that cysteine infusion into the abomasum of sheep appeared to influence certain facets of immune response, including antibody responses to non-parasitic antigens. However, the exact role of cysteine in ovine immune function remains elusive. Swain and Johri (2000) indicated that the methionine requirement for optimum antibody production in broiler chickens was greater than that for optimum growth. Other reports suggest that dietary cysteine and the BCAA in particular may exert specific effects in the modulation of immune responses in broiler chickens (Takahashi *et al.*, 1997; Konashi *et al.*, 2000). Clearly, there is a need to undertake further studies to elucidate the exact role of SAA and BCAA as regulators of the immune system.

### 3-Methylhistidine

This unique amino acid occurs in the muscle proteins actin and myosin, deriving its methyl group in a post-translational event (Rathmacher, 2000). It is used as an index of muscle protein breakdown since it does not charge tRNA and is thus not re-utilized in protein synthesis. It is excreted quantitatively in the urine of certain animals and the major source is skeletal muscle. Thus changes in 3-methylhistidine disposition is predominantly a reflection of muscle protein metabolism. However, species differences are apparent. Cattle, for example, quantitatively excrete 3-methylhistidine in urine, whereas in sheep and pigs excretion is not quantitative. Rathmacher (2000) presented three-compartment models of 3-methylhistidine kinetics (Fig. 1.1), based on the knowledge that there are pools of this amino acid in plasma, in other extracellular fluids, within muscle and in other tissues. In sheep and pigs there is a balenine pool in muscle. Balenine is a dipeptide composed of  $\beta$ -alanine and 3-methylhistidine in equimolar quantities.

### Conclusions

In this chapter an attempt has been made to set the scene in terms of identifying and defining basic principles such as classification of amino acids, unique effects of deficiency

**Fig. 1.1.** Three-compartment models for 3-methylhistidine (3-MH) kinetics in selected animal species (Rathmacher, 2000). Tracer doses of labelled 3-methylhistidine are used in investigations with these models.

and utilization of isomers and precursors of neurotransmitters. Since the previous edition (D'Mello, 1994), significant advances have been made in our understanding of the multifunctional roles of amino acids. These have

been highlighted in this chapter and pursued in greater depth in other parts of this book. Emerging issues include the role of specific amino acids, such as leucine, in molecular signalling and cysteine in modulation of



immune function. In addition, a number of issues have reached a stage enabling a more mature assessment of their metabolic or nutritional significance. The use of 3-methyl-histidine is a case in point, whereas the role of homocysteine emerges as an issue worthy of future research, particularly with respect to breeding animals.

## References

- Adeola, O. (1995) Dietary lysine and threonine utilization by young pigs: efficiency for carcass growth. *Canadian Journal of Animal Science* 75, 445–452.
- Anthony, J.C., Anthony, T.G., Kimball, S.R., Vary, T.C. and Jefferson, L.S. (2000a) Orally administered leucine stimulates protein synthesis in skeletal muscle of postabsorptive rats in association with increased eIF4F formation. *Journal of Nutrition* 130, 139–145.
- Anthony, J.C., Yoshizawa, F., Anthony, T.G., Vary, T.C., Jefferson, L.S. and Kimball, S.R. (2000b) Leucine stimulates translation initiation in skeletal muscle of postabsorptive rats via a rapamycin-sensitive pathway. *Journal of Nutrition* 130, 2413–2419.
- Atkins, J.F. and Gesteland, R.F. (2000) The twenty-first amino acid. *Nature* 407, 463–465.
- Baker, D.H. (1994) Utilization of precursors for L-amino acids. In: D'Mello, J.P.F. (ed.) *Amino Acids in Farm Animal Nutrition*. CAB International, Wallingford, UK, pp. 37–61.
- Baker, D.H., Fernandez, S.R., Parsons, C.M., Edwards III, H.M., Emmert, J.L. and Webel, D.M. (1996) Maintenance requirement for valine and efficiency of its use above maintenance for accretion of whole body valine and protein in young chicks. *Journal of Nutrition* 126, 1844–1851.
- Bradford, H.F. (1986) *Chemical Neurobiology*. W.H. Freeman and Company, New York.
- Cikot, R.J.L.M., Steegers-Theunissen, R.P.M., Thomas, C.M.G., de Boo, T.M., Merkus, H.M.W. and Steegers, E.A.P. (2001) Longitudinal vitamin and homocysteine levels in normal pregnancy. *British Journal of Nutrition* 85, 49–58.
- D'Mello, J.P.F. (1991) Toxic amino acids. In: D'Mello, J.P.F., Duffus, C.M. and Duffus, J.H. (eds) *Toxic Substances in Crop Plants*. The Royal Society of Chemistry, Cambridge, pp. 21–48.
- D'Mello, J.P.F. (1993) Non-protein amino acids in *Canavalia ensiformis* and hepatic ornithine decarboxylase. *Amino Acids* 5, 212–213.
- D'Mello, J.P.F. (1994) *Amino Acids in Farm Animal Nutrition*. CAB International, Wallingford, UK.
- D'Mello, J.P.F. and Lewis, D. (1978) Effect of nutrient deficiencies in animals: amino acids. In: Rechcigl, M. (ed.) *Handbook Series in Nutrition and Food*. CRC Press, West Palm Beach, Florida, pp. 441–490.
- Edwards, H.M. III and Baker, D.H. (1999) Maintenance sulphur amino acid requirements of young chicks and efficiency of their use for accretion of whole-body sulfur amino acids and protein. *Poultry Science* 78, 1418–1423.
- Edwards, H.M. III, Baker, D.H., Fernandez, S.R. and Parsons, C.M. (1997) Maintenance threonine requirement and efficiency of its use for accretion of whole-body threonine and protein in young chicks. *British Journal of Nutrition* 78, 111–119.
- Edwards, H.M. III, Fernandez, S.R. and Baker, D.H. (1999) Maintenance lysine requirement and efficiency of using lysine for accretion of whole-body lysine and protein in young chicks. *Poultry Science* 78, 1412–1417.
- Enneking, D., Giles, L.C., Tate, M.E. and Davies, R.L. (1993) Canavanine: a natural feed-intake inhibitor for pigs. *Journal of the Science of Food and Agriculture* 61, 315–325.
- Hamada, K., Matsumoto, K., Minehira, K., Doi, T., Okamura, K. and Shimizu, S. (1998) Effect of glucose on ureagenesis during exercise in amino acid-infused dogs. *Metabolism, -Clinical-and-Experimental* 47, 1303–1307.
- Hamada, K., Matsumoto, K., Okamura, K., Doi, T., Minehira, K. and Shimizu, S. (1999) Effect of amino acids and glucose on exercise-induced gut and skeletal muscle proteolysis in dogs. *Metabolism, -Clinical-and-Experimental* 48, 161–166.
- Harrison, L.M. and D'Mello, J.P.F. (1986) Large neutral amino acids in the diet and neurotransmitter concentrations in the chick brain. *Proceedings of the Nutrition Society* 45, 72A.
- Harrison, L.M. and D'Mello, J.P.F. (1987) Zinc deficiency, amino acid imbalance and brain catecholamine concentrations in the chick. *Proceedings of the Nutrition Society* 46, 58A.

- Hrupka, B., Lin, Y., Gietzen, D.W. and Rogers, Q.R. (1997) Small changes in essential amino acid concentrations alter diet selection in amino acid-deficient rats. *Journal of Nutrition* 127, 777–789.
- Hrupka, B., Lin, Y., Gietzen, D.W. and Rogers, Q.R. (1999) Lysine deficiency alters diet selection without depressing food intake in rats. *Journal of Nutrition* 129, 424–430.
- Jackson, M., Song, W., Liu, M.Y., Jin, L., Dykes-Hoberg, M., Lin, C.G., Bowers, W.J., Federoff, J., Sternweis, P.C. and Rothstein, J.D. (2001) Modulation of the neuronal glutamate transporter EAAT4 by two interacting proteins. *Nature* 410, 89–93.
- Konashi, S., Takahashi, K. and Akiba, Y. (2000) Effects of dietary essential amino acid deficiencies on immunological variables in broiler chickens. *British Journal of Nutrition* 83, 449–456.
- Malinow, M.R. (1996) Plasma homocyst(e)ine: a risk factor for arterial occlusive diseases. *Journal of Nutrition* 126, 1238S–1243S.
- Mathews, J.C. (2000) Amino acid and peptide transport systems. In: D’Mello, J.P.F. (ed.) *Farm Animal Metabolism and Nutrition*. CAB International, Wallingford, UK, pp. 3–23.
- Maynard, L.M., Boissonneault, G.A., Chow, C.K. and Bruckner, G.G. (2001) High levels of dietary carnosine are associated with increased concentrations of carnosine and histidine in rat soleus muscle. *Journal of Nutrition* 131, 287–290.
- Miller, F.M., Blair, H.T., Birtles, M.J., Reynolds, G.W., Gill, H.S. and Revell, D.K. (2000) Cysteine may play a role in the immune response to internal parasites in sheep. *Australian Journal of Agricultural Research* 51, 793–799.
- Mills, J.L., Scott, J.M., Kirke, P.N., McPartlin, J.M., Conley, M.R., Weir, D.G., Molloy, A.M. and Lee, Y.J. (1996) Homocysteine and neural tube defects. *Journal of Nutrition* 126, 756S–760S.
- Moncada, S., Palmer, R.M.J. and Higgs, E.A. (1991) Nitric oxide: physiology, pathophysiology and pharmacology. *Pharmacological Reviews* 43, 109–142.
- Morris, J.G. and Rogers, Q.R. (1978) Arginine: an essential amino acid for the cat. *Journal of Nutrition* 108, 1944–1953.
- Ousterhout, L.E. (1960) Survival time and biochemical changes in chicks fed diets lacking different essential amino acids. *Journal of Nutrition* 70, 226–234.
- Pusztai, A., Grant, G., Spencer, R.J., Duguid, T.J., Brown, D.S., Ewen, S.W.B., Peumans, W.J., Van Damme, E.J.M. and Bardocz, S. (1993) Kidney bean lectin-induced *Escherichia coli* overgrowth in the small intestine is blocked by GNA, a mannose-specific lectin. *Journal of Applied Bacteriology* 75, 360–368.
- Rathmacher, J.A. (2000) Measurement and significance of protein turnover. In: D’Mello, J.P.F. (ed.) *Farm Animal Metabolism and Nutrition*. CAB International, Wallingford, UK, pp. 25–47.
- Rosenberg, I.H. (1996) Homocysteine, vitamins and arterial occlusive disease: an overview. *Journal of Nutrition* 126, 1235S–1237S.
- Rosenquist, T.H. and Finnell, R.H. (2001) Genes, folate and homocysteine in embryonic development. *Proceedings of the Nutrition Society* 60, 53–61.
- Stabler, S.P., Lindenbaum, J. and Allen, R.H. (1996) The use of homocysteine and other metabolites in the specific diagnosis of vitamin B-12 deficiency. *Journal of Nutrition* 126, 1260S–1272S.
- Stangl, G.I., Roth-Maier, D.A. and Kirchgessner, M. (2000a) Vitamin B-12 deficiency and hyperhomocysteinemia are partly ameliorated by cobalt and nickel supplementation in pigs. *Journal of Nutrition* 130, 3038–3044.
- Stangl, G.I., Schwarz, F.J., Jahn, B. and Kirchgessner, M. (2000b) Cobalt-deficiency-induced hyperhomocysteinemia and oxidative status of cattle. *British Journal of Nutrition* 83, 3–6.
- Swain, B.K. and Johri, T.S. (2000) Effect of supplemental methionine, choline and their combination on the performance and immune response of broilers. *British Poultry Science* 41, 83–88.
- Takahashi, K., Ohta, N. and Akiba, Y. (1997) Influence of dietary methionine and cysteine on metabolic responses to immunological stress by *Escherichia coli* lipopolysaccharide injection, and mitogenic response in broiler chickens. *British Journal of Nutrition* 78, 815–821.
- Takenaka, A., Oki, N., Takahashi, S.I. and Noguchi, T. (2000) Dietary restriction of single amino acids reduces plasma insulin-like growth factor-I (IGF-I) but does not affect plasma IGF-binding protein-1 in rats. *Journal of Nutrition* 130, 2910–2914.
- Tesseraud, S., Peresson, R., Lopes, J. and Chagneau, A.M. (1996) Dietary lysine greatly affects muscle and liver protein turnover in growing chickens. *British Journal of Nutrition* 75, 853–865.
- Velu, J.G., Scott, H.M. and Baker, D.H. (1972) Body composition and nutrient utilization of chicks fed amino acid diets containing graded amounts of either isoleucine or lysine. *Journal of Nutrition* 102, 741–748.

- Wu, G. and Knabe, D.A. (1994) Free and protein-bound amino acids in sow's colostrum and milk. *Journal of Nutrition* 124, 415–424.
- Wu, G., Davis, P.K., Flynn, N.E., Knabe, D.A. and Davidson, J.T. (1997) Endogenous synthesis of arginine plays an important role in maintaining arginine homeostasis in postweaning growing pigs. *Journal of Nutrition* 127, 2342–2349.
- Young, V.R. and Ajami, A.M. (2000) Glutamate: an amino acid of particular distinction. *Journal of Nutrition* 130, 892S–900S.

# 2 Amino Acid Analysis of Feeds

**Johannes Fontaine\***

*Feed Additives Division, Degussa AG, Applied Technology, Hanau, Germany*

---

## Introduction

Never before has the economic success of feed manufacturers been so heavily dependent on optimal and accurate amino acid composition as today. The effects on growth and feed conversion of animals are so impressive that the annual amount of synthetic methionine and lysine supplemented in feeds worldwide now exceeds 400,000 tonnes each. This generates growing demand for amino acid analysis of feed raw materials to improve the amino acid matrix for linear feed programming, but also as a quality assurance tool for compound feeds and pre-mixtures.

In the first edition of this book A.P. Williams reported on the state of amino acid analysis by reviewing the literature up to 1992. In this second edition the focus shall be mainly on the developments of the last 10 years. There are numerous publications on amino acid analysis, but only a small proportion are concerned with test matrices that are relevant to animal nutrition, such as feedingstuffs, food products, plants, silages, by-products of plant and animal origin, animal blood plasma, intestinal and ruminal contents; these are the topics which will be discussed here.

One of the most important developments of recent years was undoubtedly the long overdue international standardization of amino acid analysis in feedingstuffs. Analytical scientists at national European supervisory authorities, who in the 1980s had adopted different methods of analysis for the determination of total amino acids as standards in their respective countries, eventually joined forces in an international collaborative effort to establish a common EU methodology. Recently, after extensive groundwork, official EU methods for the determination of total and free amino acids in animal feedingstuffs and corresponding methods for tryptophan were passed (Commission Directives 98/64/EC and 2000/45/EC). International collaboration was also the basis for the analytical method adopted by AOAC International for the determination of total amino acids with the exception of tryptophan (AOAC, 1994). The official methods of analysis of the AOAC enjoy worldwide recognition as an authoritative collection of analytical methods far beyond the NAFTA region. The reference method adopted for feed analysis was the chromatographic separation of amino acids with a cation exchanger resin followed by ninhydrin derivatization. Sample preparation is virtually identical for the various methods. The

\*E-mail address: johannes.fontaine@degussa.com

EU standard procedure for the determination of tryptophan in feedingstuffs utilizes alkaline hydrolysis with barium hydroxide and HPLC analysis with specific fluorescence detection.

A second important innovation was the development of robust, internationally usable near-infrared spectroscopy (NIRS) calibrations for amino acids for the major feed raw materials, based on reliable wet chemical reference analysis. These allow the rapid, simple analysis of the amino acid composition of raw materials today and up-to-date feed optimization. This development will also be described in detail.

A review article by Kivi (2000) which focuses on chromatographic and detection methods deserves special mention because it is an excellent addition to this review.

## Wet Chemical Analysis

### Sample preparation

#### *Acid hydrolysis and oxidation*

The determination of amino acids requires the hydrolytic splitting of protein into its individual building blocks, which behave very differently during hydrolysis due to the functionality of the R side group. Asparagine and glutamine lose the amide residue in the side group and form aspartate and glutamate, respectively. The resulting ammonia can be determined chromatographically, but amino acid analysis always determines the sum Asx or Glx of these amino acid pairs. Tryptophan is largely destroyed by acid hydrolysis whereas methionine, and especially cystine, are converted by partial oxidation into several derivatives. Standard hydrolysis conditions in the EU and USA are 24 h with 6 M hydrochloric acid at 110°C, the boiling point of this acid. This can be done either under reflux or in a closed vessel in a thermostated oven. These conditions are a compromise for optimal recovery of all amino acids. Serine and threonine, which carry one hydroxyl group, are slowly degraded with increasing length of hydrolysis or increasing acid strength by the splitting off of water and the branched-chain amino acids isoleucine, leucine and valine, especially if

they are adjacent in the protein, are more slowly released by steric hindrance of the hydrolysis. Albin *et al.* (2000a,b) recently studied this topic and the effect of the acid concentration for soybean products, Rowan *et al.* (1992) tested the effect of the hydrolysis time (8–72 h) for diets, ileal digesta and faeces samples. The optimal recovery relative to the standard conditions is frequently 5–10%, in some cases 20% or even higher. The authors recommend the use of correction factors.

Hydrolysis in a microwave oven at about 150°C can reduce the time needed for splitting the protein to a few minutes (Carisano, 1992; Joergensen and Thestrup, 1995; Marconi *et al.*, 1996; Shang and Wang, 1997; Kroll *et al.*, 1998). If only minute amounts of protein are available hydrolysis with gaseous hydrochloric acid (Schrijver *et al.*, 1991; Molnar-Perl and Khalifa, 1994) is of benefit. Fountoulakis and Lahm (1998) produced a survey of protein hydrolysis techniques, which also includes alternative acids such as methan- or *p*-toluene-sulphonic acid or the use of enzymes (Hauck, 1990; Chen *et al.*, 1996). Weiss *et al.* (1998) compared different hydrolysis techniques by means of chromatographically purified proteins. In the method of standardization of the EU (Commission Directive 98/64/EC) the use of correction factors for the hydrolysis, as previously practised in the Netherlands, was deliberately ruled out, however. The side reactions of hydrolysis are matrix-dependent and can be considerable, especially in microwave hydrolysis. Correction factors would therefore have to be defined individually for all feed raw materials, which would pose problems, especially in the case of compound feeds. Moreover, differences in the use of correction factors would probably increase the analytical error when compiling tables of raw material composition. The uniform application of standard hydrolysis conditions worldwide on the other hand produces highly consistent amino acid analyses.

The sulphur-containing amino acids are oxidized prior to hydrolysis in the protein with performic acid to methionine sulphone and cysteic acid, which survive acid hydrolysis without losses. In the official methods of the EU and the AOAC this is done by leaving a

sample corresponding to 10 mg nitrogen to react overnight with 5 ml performic acid (16 h) at 0°C. The latter was previously generated *in situ* at room temperature from 4.5 ml of 88% formic acid and 0.5 ml of 30% hydrogen peroxide with the addition of a little phenol and cannot be concentrated or stored. These reaction conditions have been standardized for decades and are based on the work of Schram *et al.* (1954). Excess performic acid can later be destroyed by the addition of hydrogen bromide or hydrogen chloride, forming bromine or chlorine, which have to be drawn off with a rotary evaporator. Spindler *et al.* (1984), Elkin and Griffith (1985) and Gehrke *et al.* (1987) studied the recovery of all amino acids under these conditions and showed that all acid-stable amino acids, with the exception of phenylalanine, histidine and tyrosine, are completely recovered from the hydrolysate after previous oxidation. Mason *et al.* (1980a,b) and Bech-Andersen *et al.* (1990) tried to streamline this procedure and introduced the addition of sodium metabisulphite salt to destroy performic acid. The advantage is that it eliminates the need for rotary removal of the halogen prior to hydrolysis and that phenylalanine and histidine can also be determined from the oxidized hydrolysate. This method is capable of determining all amino acids except tryptophan and tyrosine. However, it is important to remember that these hydrolysates now contain sulphuric acid or hydrogen sulphate formed from sulphite which, when concentrated for the complete removal of the hydrochloric acid, can form sulphate esters with serine and threonine which interfere with cysteine acid in the amino acid analyser. The EU method based on this variant therefore suggests neutralization of the hydrolysates, which can be readily automated, or the partial removal of the hydrochloric acid by distillation. Llames and Fontaine (1994) compared both variants of oxidation and acid hydrolysis in a worldwide collaborative trial, with 28 participants, using broiler starter and finisher feed, maize, fish-meal and poultry meal, and obtained equivalent results (Table 2.1). Toran *et al.* (1996) also suggest oxidation for the determination of cystine and methionine in infant formulas.

Slump and Bos (1985) describe an interference of the oxidation of methionine, if chloride levels from salts far in excess of 1% occur in for example supplementary feeds or concentrates. This causes the performic acid to be partially degraded, while forming chlorine, so that only cysteine acid but not methionine sulphone is formed completely. If this happens the authors suggest oxidation with diluted performic acid for methionine determination, which is not suitable for cystine. The German VDLUFA (1997) has nominated this procedure as the official method of analysis for methionine determination in chloride-rich diets. We should also mention the work of Tuan and Phillips (1997) who studied cystine recovery in diets based on casein and sorghum and in digesta samples as mixed disulphide with the addition of 3,3'-dithiodipropionic acid during hydrolysis with hydrochloric acid in evacuated ampoules at 145°C and different times. At a 100-fold molar excess of the reagent they recovered pure cystine at the rate of 99%. Very inconsistent results were however obtained in feed and digesta, which makes a final assessment of the method impossible.

#### *Tryptophan analysis*

The analysis of tryptophan, an essential amino acid which can become limiting, especially in swine diets, has been extensively studied. The focus in recent years has been on alkaline hydrolysis in the total absence of oxygen. Simat and Steinhart (1998) recently published detailed studies on the oxidation of free and protein-bound tryptophan and described follow-up products. Nielsen and Hurrell (1984), having conducted comparative tests, suggested hydrolysis with sodium hydroxide in an evacuated vessel (110°C, 20 h) with the addition of 5-methyltryptophan as internal standard and hydrolysed starch. Werner (1986) and Rogers and Pesti (1990) on the other hand preferred to work with lithium hydroxide after flushing with nitrogen, without using an internal standard, because sodium hydroxide readily attacks glass, and they reported a 97–99% tryptophan recovery. Slump *et al.* (1991) compared lithium hydroxide and barium hydroxide for hydrolysis in a

**Table 2.1.** Comparison of three oxidation and hydrolysis procedures in an international collaborative study with 28 participating labs and five samples in blind duplicates. The mean amino acid contents obtained were equivalent, if the respective method is applicable.

	Mean contents(g kg <sup>-1</sup> )														
	Broiler finisher			Broiler starter			Maize			Fishmeal			Poultry meal		
	Ox <sup>a</sup> (SO <sub>2</sub> )	Ox (HBr)	Hyd	Ox (SO <sub>2</sub> )	Ox (HBr)	Hyd	Ox (SO <sub>2</sub> )	Ox (HBr)	Hyd	Ox (SO <sub>2</sub> )	Ox (HBr)	Hyd	Ox (SO <sub>2</sub> )	Ox (HBr)	Hyd
Alanine	11.7	12.0	11.8	12.8	13.1	12.9	6.1	6.1	6.2	35.0	35.6	34.9	42.6	42.8	42.6
Arginine	12.8	12.2	12.5	15.7	15.1	15.7	4.0	3.9	3.7	34.0	32.4	33.6	43.5	42.4	44.0
Aspartate	16.8	17.5	16.7	22.9	23.6	23.0	5.4	5.6	5.4	52.2	52.6	53.1	49.2	50.4	51.3
Cystine	3.2	3.5	–	3.5	3.6	–	1.8	1.9	–	4.8	4.9	–	8.1	8.2	–
Glutamate	32.5	32.3	32.4	40.4	40.4	40.4	15.1	14.9	15.4	73.7	74.9	74.5	79.7	80.5	81.8
Glycine	12.7	13.0	13.0	12.7	12.9	12.9	3.3	3.3	3.3	38.4	39.1	38.8	69.0	68.6	69.8
Histidine	5.0	–	5.0	6.5	–	6.1	2.7	–	2.4	13.7	–	13.9	13.1	–	13.8
Isoleucine	7.6	7.6	7.4	9.5	9.8	9.6	2.8	2.9	2.8	23.2	24.0	23.5	22.4	23.1	23.0
Leucine	16.6	16.9	16.6	19.7	20.3	19.8	9.9	10.0	9.9	40.7	41.5	40.7	40.9	41.8	41.0
Lysine	10.7	11.0	10.6	13.5	13.9	13.5	2.6	2.6	2.5	42.2	44.6	42.5	36.3	37.2	36.7
Methionine	5.3	5.4	–	6.2	6.3	–	1.8	1.9	–	16.1	16.3	–	11.7	12.0	–
Phenylalanine	8.7	–	8.7	11.2	–	11.1	3.8	–	4.0	22.9	–	22.4	23.3	–	23.3
Proline	13.9	14.1	14.2	14.7	14.3	15.0	7.3	7.1	7.6	26.2	25.4	26.5	45.3	44.9	47.8
Serine	9.4	9.4	9.7	11.2	11.4	11.7	3.9	3.9	4.1	22.1	22.3	22.5	27.6	27.1	28.6
Threonine	7.3	7.4	7.4	11.2	9.1	9.0	2.9	3.0	3.0	22.8	23.8	23.7	23.2	23.8	23.8
Tyrosine	–	–	6.3	–	–	8.4	–	–	3.0	–	–	18.5	–	–	17.8
Valine	9.2	9.3	9.3	11.1	11.2	11.1	3.8	3.9	3.9	27.8	28.9	28.2	28.2	28.5	29.0

<sup>a</sup>Ox (SO<sub>2</sub>), oxidation, where performic acid is destroyed by addition of sodium metabisulphite and followed by standard hydrolysis (6 mol l<sup>-1</sup> HCl, 110°C, 24 h); Ox (HBr), oxidation, where performic acid is destroyed by addition of hydrogen bromide and followed by standard hydrolysis; Hyd, only standard hydrolysis.

sterilizing autoclave (130°C, 8 h), added the internal standard only after the hydrolysis and obtained the same recovery each time, which they estimated at about 92% for defined proteins and pure tryptophan. Bech-Andersen (1991) suggested hydrolysis in an autoclave with sodium hydroxide solution, adding lactose to enhance recovery and  $\alpha$ -methyltryptophan as internal standard. Ranfft and Faure (1993), who conducted an intercomparison with compound feed and four raw materials using different in-house methods of 14 European laboratories, found coefficients of variation ranging from 4 (soy) to 10% (maize) and observed no significant differences in relation to the hydroxide used, temperature, time or the hydrolysis technique. Landry and Delhaye (1992a,b, 1994a) and Delhaye and Landry (1992, 1993) conducted intensive studies on tryptophan determination. Three hydroxides, different times and temperatures for hydrolysis and several assay procedures were varied and compared. They favoured as a result the hydrolysis with barium hydroxide in an autoclave with added 5-methyltryptophan as internal standard to compensate for losses. They also suggested HPLC conditions on reversed phase (RP)-silica gel with a separating time of only 10 min and fluorescence detection. Landry and Delhaye (1994b) evaluated the results of two collaborative studies by normalizing the tryptophan values of all other participants relative to their own assays. They were convinced that the above conditions bring 15–20% higher tryptophan recovery. Most other authors also suggested HPLC with UV or fluorescence detection, the latter being preferred because of its specificity for tryptophan.

Landry and Delhaye (1992a) also compared separation by gel filtration on Sephadex, analysis of the hydrolysates with a cation exchanger or colorimetric analysis after staining with *p*-dimethylamino-cinnamaldehyde. Other authors also determined tryptophan colorimetrically by the acid ninhydrin method (Pintér-Szakács and Molnar-Perl, 1990), after conversion with *p*-dimethylamino-benzaldehyde (Lee *et al.*, 1996) or nitrous acid (Shah *et al.*, 1996). However, on comparing this procedure with HPLC analysis, the simple operation and greater precision

of the HPLC method is emphasized. The general acceptance of HPLC has therefore led to the virtual disappearance of the previously widespread spectrophotometric tryptophan methods. Molnár-Perl (1997) has compiled a review of methods of tryptophan analysis in peptides and proteins, including descriptions of techniques not normally used in feedingstuffs, such as acid or enzymatic hydrolysis, measurement by gas chromatography or derivative spectroscopy without chemical derivatization. Carisano (1993), who employed microwave hydrolysis with lithium hydroxide under temperature control, was able to hydrolyse meat and fish completely in less than 60 min, obtaining results similar to those with barium hydroxide (110°C, 12 h). He derivatized tryptophan with *o*-phthalaldehyde (OPA) prior to HPLC, whereas Algeria *et al.* (1996) converted with phenylisothiocyanate (PITC).

An expert group of the EU Commission, DG XII, has been working for 4 years on comparative studies with a view to establishing a harmonized system of feedstuff analysis in the EU. Fontaine *et al.* (1998) reported that three collaborative trials with 12–16 participants tested lithium hydroxide versus sodium hydroxide and barium hydroxide, the use of an internal standard during or after hydrolysis, the suitability of 5-methyl- or  $\alpha$ -methyltryptophan as internal standard and the use of evacuated or nitrogen-purged hydrolysis vessels versus autoclaving. Landry and Delhaye (1994b), who also participated, presented the view, as mentioned above, that 5-methyltryptophan must be present during hydrolysis with barium hydroxide and that by using their special autoclaving conditions about 15% higher tryptophan concentrations are obtained than with other techniques. The second collaborative trial showed, however, that irrespective of the hydrolysis technique the use of this internal standard generated analytical values in all laboratories that were a significant 13–20% higher than with  $\alpha$ -methyltryptophan. A comparison of the hydrolytic stability of the two internal standards revealed that the 5-methyl derivative is less stable than tryptophan, whereas  $\alpha$ -methyltryptophan is considerably more stable. This leads to a marked overcorrection of the



small hydrolysis losses in the case of protein-bound tryptophan, so that the addition of an internal standard during hydrolysis was rejected. The best results were obtained with 4 M barium hydroxide (110°C, 20 h) in an autoclave. Moreover, the addition of the stable  $\alpha$ -methyltryptophan after hydrolysis greatly improved the comparability of the results between laboratories. The determination of supplemented tryptophan was also optimized, the best technique being extraction with 0.1 M hydrochloric acid with an internal standard. Publication of the Commission Directive (2000) made the adopted method compulsory across the EU. The accuracy achieved was excellent, with a reproducibility  $CV_R$  of between 2.2 and 6.3%, and 1.5–4.7% in a second test.

### Supplemented or free amino acids and taurine

Virtually all compound feeds are now supplemented with amino acids and determination of this additive is an important quality assurance tool in the feed industry. Fahrenstich and Tanner (1973) developed a method for extracting free amino acids from a few grams of finely ground feed using diluted cold 0.1 M hydrochloric acid. Mason *et al.* (1980a) described similar extraction conditions but with the addition of thiodiglycol as stabilizer for methionine and protein precipitation in the extract prior to chromatography. Virtually identical extraction conditions were incorporated in the official EU method for the determination of supplemented amino acids as a result of the Commission Directive (1998). In the EU collaborative trial, where this extraction method was tested on a premix, excellent repeatability within laboratory  $CV_r$  and reproducibility between laboratories  $CV_R$  are achieved (Table 2.2). Protein hydrolysis does not occur with diluted hydrochloric acid. It is not possible, however, to distinguish supplemented from natural, non-protein-bound amino acids out of the feed raw materials. All that needs to be done prior to performing cation exchange chromatography is to adjust the pH to 2.20 and no special cleaning of the extracts is necessary according to our experi-

ence. Extractions of various compound feeds with the addition of norleucine as internal standard gave a very good intralaboratory repeatability  $CV_r$  of 1–1.5% in our laboratory (Fontaine, 2002). Foulon *et al.* (1990), who compared extraction of methionine and lysine with water, 85% ethanol and buffer solution with the acid extraction described above, achieved the highest recovery with 0.1 M hydrochloric acid. Saurina and Hernandez-Cassou (1993) described a flow-injection spectrophotometric determination specialized for supplemented lysine in commercial feeds. Bech-Andersen (1997) developed special alkaline/acid extraction conditions for mineral premixes with high contents of heavy metals in order to obtain extracts without heavy metal ions as the latter cause considerable interference in the cation exchanger. Fontaine and Eudaimon (2000) gave a detailed description of an acid extraction method with subsequent determination in an amino acid analyser, specially designed for assays of commercial amino acid products and concentrated premixes, which they tested in an international collaborative trial with 17 laboratories. They achieved a between-laboratory reproducibility  $CV_R$  of only 1.5–2.6% and a recovery of the amino acids in the accurately produced premixes of 97.5–102.8%. This method has been adopted as the Official First Action by AOAC International.

The effect of amino acids in the diet on free amino acid concentrations in blood plasma, muscles or liver, etc., has also been the subject of many animal experiments. These matrices require deproteinization by precipitation (addition of acids or solvents) or by means of physical techniques (ultrafiltration etc.). Walker and Mills (1995) wrote in a review article that in human clinical diagnostic work precipitation is performed predominantly with 4–5% final concentration of 5-sulphosalicylic acid, as also described by De Jonge and Breuer (1994) for porcine plasma and Hagen *et al.* (1993) for bovine plasma. Sedgwick *et al.* (1991) compared protein precipitation by means of acetone or acetonitrile with that performed using perchloric acid or trichloroacetic acid in ovine plasma and bovine serum albumin solutions. Acid precipitation achieved good amino acid recoveries

**Table 2.2.** Precision of amino acid analysis. Published results of collaborative trials on the analysis of total amino acid contents in mixed feed and ingredients and of supplemented amino acids in premixes and pure amino acid trade products.

	Llames and Fontaine (1994)						Commission Directive (1998)				Bütikofer <i>et al.</i> (1992)			
	Broiler finisher		Poultry meal		Fish meal		Mixed pig feed		Broiler compound		Whey protein concentrate		Feed	
	CV <sub>r</sub>	CV <sub>R</sub>	CV <sub>r</sub>	CV <sub>R</sub>	CV <sub>r</sub>	CV <sub>R</sub>	CV <sub>r</sub>	CV <sub>R</sub>	CV <sub>r</sub>	CV <sub>R</sub>	CV <sub>r</sub>	CV <sub>R</sub>	CV <sub>r</sub>	CV <sub>R</sub>
Methionine (total)	1.1	7.6	2.1	12.0	1.9	9.7	3.4	7.0	3.1	10.9	3.1	13.4	5.9	16.0
Cystine (total)	3.1	11.3	4.6	17.7	4.0	19.0	3.3	9.9	2.8	8.8	5.5	44.8	13.1	77.2
Lysine (total)	3.5	9.0	3.1	9.9	2.8	7.9	2.8	3.2	2.1	5.4	2.3	5.5	5.3	13.2
Threonine (total)	2.7	8.2	3.2	9.1	3.6	10.7	1.9	4.1	2.1	5.3	1.5	5.2	3.1	8.4
Arginine (total)	2.3	8.6	3.3	9.7	2.3	7.2					3.0	8.8	4.2	7.8
Isoleucine (total)	3.2	6.8	2.7	11.7	2.1	10.3					4.2	9.4	3.1	18.7
Leucine (total)	2.7	6.3	2.5	7.6	1.9	6.8					2.5	6.4	2.3	7.8
Valine (total)	3.8	12.7	3.2	12.8	2.3	11.2					2.9	10.2	6.1	16.4
Phenylalanine (total)	4.4	14.6	3.5	9.2	1.6	7.7					4.2	11.5	4.7	12.3
	Commission Directive (2000)				Commission Dir. (1998)		Fontaine and Eudaimon (2000)							
	Feed concentrate for pigs		Soybean meal		Premixture		No. 3 Premix		No. 5 Premix		Biolys™		DL-Methionine	
	CV <sub>r</sub>	CV <sub>R</sub>	CV <sub>r</sub>	CV <sub>R</sub>	CV <sub>r</sub>	CV <sub>R</sub>	CV <sub>r</sub>	CV <sub>R</sub>	CV <sub>r</sub>	CV <sub>R</sub>	CV <sub>r</sub>	CV <sub>R</sub>	CV <sub>r</sub>	CV <sub>R</sub>
Tryptophan (total)	1.9	2.2	1.3	4.1										
Methionine (suppl.)					2.4	6.9	1.2	1.8	0.5	2.6			0.9	1.5
Lysine (suppl.)					2.1	6.7	1.3	2.5	0.7	1.9	0.8	2.3		
Threonine (suppl.)					2.2	4.3	0.7	1.9	0.8	1.9				

CV<sub>r</sub>, coefficient of variation (%) for within laboratory standard deviation S<sub>r</sub>, repeatability CV<sub>r</sub>; CV<sub>R</sub>, coefficient of variation (%) for between laboratory standard deviation S<sub>R</sub>, reproducibility CV<sub>R</sub>.

over a wide concentration range of the dissolved protein (4–16%). The solvents, however, included free amino acids in the precipitate so that the recovery fell to only 50% with increasing protein content. Aristoy and Toldra (1991) on the other hand obtained equally satisfactory results in the determination of free amino acids in fresh pork muscle and dry-cured ham either by protein precipitation with perchloric acid, trichloroacetic acid, picric acid and acetonitrile or by ultrafiltration with a 10 kDa exclusion limit, whereas sulphosalicylic acid or ultrafiltration with 1 kDa gave a poorer recovery. Peter *et al.* (1999) also used trichloroacetic acid for protein precipitation in cell extracts of algae and Bugueno *et al.* (1999) used acetonitrile for deproteinization of raw salmon muscle. Antoine *et al.* (1999) used 75% methanol in the analysis of free amino acids in fish samples. Urine sample preparation on the other hand was done by Hara *et al.* (1999) with 30% sulphosalicylic acid. Van de Merbel *et al.* (1995) described online amino acid monitoring in fermentation processes employing ultrafiltration for protein separation and ion exchange chromatography. There are thus many suitable variants for the removal of unwanted protein and the recovery of supplemented amino acids should always be tested in preliminary experiments.

Taurine, a metabolic derivative of cysteine, is essential for cats but it also plays a role in infant nutrition. It occurs in the non-protein-bound form and can, in principle, be analysed in the same way as free amino acids. Balschukat and Kunesch (1989) described its determination in fish meal, pet food and animal raw materials following extraction with 0.1 M hydrochloric acid in an amino acid analyser. Nicolas *et al.* (1990) measured taurine concentrations in infant formulas and human milk following ultrafiltration also by ion-exchange chromatography. McCarthy *et al.* (2001) tested a taurine assay in pet food after acid hydrolysis (6 M HCl, 110°C, 16 h) and precolumn derivatization with dansyl chloride in a collaborative trial. In six samples of wet and dry cat and dog food interlaboratory reproducibility  $CV_{R,S}$  of 6.1–13.3% were achieved, and the procedure was adopted as the official method by AOAC International.

Porter *et al.* (1988), Amiss *et al.* (1990), Sakai and Nagasawa (1992) and Messing and Sturmman (1993) described the determination of taurine in feline and other blood and plasma by HPLC separation following precolumn derivatization with different reagents.

### Chromatographic separation and detection

Several recent review articles on amino acid analysis should first be mentioned here. Morr and Ha (1995) reported in general terms on analysis of protein and amino acids in food products, whereas Rutherford and Moughan (2000) focused on analysis of animal feeds. Molnar-Perl (2000) described chromatographic techniques for the determination of sugar, carboxylic acids and amino acids in foodstuffs and included references to techniques such as gas chromatography and capillary electrophoresis. Fekkes (1996) and Walker and Mills (1995) reported on advances in amino acid determination in physiological samples or biological fluids, respectively. Detailed descriptions of different chromatographic techniques were given, with examples of the degree of separation obtained.

#### *Ion-exchange chromatography (IEC)*

The chromatographic separation of all amino acids by means of a cation exchange column (polystyrene sulphonic acid as  $Na^+$  or  $Li^+$  salt) eluted with three to five citrate or sometimes acetate buffers of different ionic strength, pH and with different modifiers, was developed way back in 1948 and automated by Spackman *et al.* as an amino acid analyser in 1958. More than 50 years later this method had become the standard in amino acid analysis owing to the outstanding and stable separation, which allows the analysis of more than 45 amino acids in blood plasma (lithium buffer), the high reproducibility of retention time and peak area and the extended stability of the calibration. The resin is highly resistant to matrix effects, which is of major importance given the complex composition of compound feeds. Any increase in pressure due

to soiling or a reduction in the separation performance can in many cases be corrected by simply reversing the flow direction; in the author's laboratory ion exchange columns are often operated continuously for more than a year; they are then cleaned, the resin regenerated and the columns repacked. The running costs of an amino acid analyser are therefore far lower than using RP-HPLC columns, which do not allow regeneration and are susceptible to attack by fats and non-polar components in feedingstuffs and therefore need to be changed frequently. Postcolumn derivatization is carried out either with ninhydrin in a heated coil or with OPA, the latter reagent being about 20 times more sensitive. The key advantage of postcolumn derivatization is that each amino acid, be it from sample or standard, is always derivatized under identical conditions in the respective elution buffer, which explains the high reproducibility. Moreover, amino acids in the underivatized state are chromatographically more strongly differentiated than the derivatives of conventional HPLC precolumn derivatizations, where a very large non-polar molecule is bound to the amino group. Also, this reaction inevitably takes place in the respective matrix, which can influence the reaction yield and stability of the derivative. Bütikofer *et al.* (1992) conducted a collaborative trial comparing HPLC analysis after precolumn derivatization with a mixture of OPA and 9-fluorenylmethyl chloroformate (FMOC) as an alternative to the classic ion exchanger in dairy products and feedingstuffs; although the means obtained with both methods were similar, IEC delivered greater reproducibility and precision and was recommended for cases requiring high precision. As IEC equipment technology is mature few articles with details have been published. Grunau and Swiader (1992) and Moeller (1993) used IEC columns in HPLC machines with two- or three-buffer gradient elution; Le Boucher *et al.* (1997) subjected the Hitachi L-8500A, a new amino acid analyser, to intensive tests with biological fluids for performance in peak reproducibility, retention time stability and linear concentration, with good results.

#### *Other separation and detection techniques of underivatized amino acids*

The separation of amino acids by means of anion exchange chromatography was also tested, often combined with pulsed amperometric detection (PAD). This separation principle is interesting because the elution sequence is reversed compared with the cation exchanger, i.e. arginine and lysine elute after a short time. PAD with a gold electrode covers oxidizable organic groups, e.g. compounds containing hydroxyl, amino and sulphide groups, but not inorganic salts or carbonic acids. Martens and Frankenberger (1992) successfully applied this new method to different proteins and wheat varieties, with adequate separation and reproducibility, although the detection sensitivities for arginine (high) and glutamic acid differed by a factor of 30 and the baseline of the chromatogram is very unstable. Simonson and Pietrzyk (1993) systematically tested the effect of the anion in the separation buffer used for separating efficiency and sensitivity in the alternative indirect photometric detection (IPD) method. Jensen and Hofler (1999) of the equipment manufacturer Dionex successfully employed anion exchange chromatography in a recently developed device with PAD for analysing meat products, fermentation solutions and fruit juices. Casella *et al.* (2000) tested cheese samples and found detection limits of 5–30 pmol absolute and sufficient linearity of detection. Jandik *et al.* (2000) managed to improve the resin-related short retention time of arginine and tested soy hydrolysates, and De Bruijn and Bout (2000) tested sugar beet, but had to remove a large proportion of the sugar as it interfered with the detection. Jandik *et al.* (2001) used a cation exchange column in hydrogen form for this purpose, which retains amino acids while allowing sugars to pass. After a development time of over 8 years, anion exchange chromatography has still not gained widespread acceptance in feed analysis.

Few authors achieved the separation of underivatized amino acids by means of RP-HPLC. Saurina and Hernandez-Cassou (1994) described in great detail an eluent system by ion pair chromatography and detected

amino acids at 309 nm after postcolumn reaction with 1,2-naphthochinone-4-sulphonate at 65°C. This method was employed for animal feed and powdered milks. Arlorio *et al.* (1998) also used ion pair chromatography to analyse aromatic amino acids and the associated biogenic amines in food products and sometimes found high concentrations in cheese. UV detection is sufficiently sensitive for these amino acids. The recently developed chemiluminescent nitrogen detector allows the specific and sensitive measurement of amino acids without derivatization (Fujinari *et al.*, 1993; Bizanek *et al.*, 1996; Petritis *et al.*, 2001). Pei and Li (2000) even described an amperometric sensor specifically for amino acids, which employs immobilized amino acid oxidase and was used for HPLC.

The recently developed method of capillary electrophoresis (CE) in different separating media (CE, capillary zone electrophoresis (CZE), micellar electrokinetic capillary chromatography (MECC)) for the determination of amino acids has also been extensively studied. Here the amino acid ions or derivatives migrate in the electric field through a separating capillary, for which a wide range of techniques have been described. Of these, only the review article by Smith (1997) on this separation technique will be mentioned and some recent papers which apply CE to the analysis of the amino acid composition of feedstuffs and skin (Michaelsen *et al.*, 1994), or soy protein (Oguri *et al.*, 1997), free amino acids in beer (Klampfl *et al.*, 1998), or soy sauce and beverages (Soga and Ross, 1999), and of methionine and homocysteine in human plasma (Vecchione *et al.*, 1999).

#### *HPLC after precolumn derivatization*

After precolumn derivatization with non-polar, UV-vis- or fluorescence-active reagents on the amino group, all amino acids can be separated by RP-HPLC. This is of benefit especially in laboratories where amino acids are tested only occasionally as the HPLC equipment, unlike the amino acid analyser, is very versatile. New derivatization reagents are being developed all the time and can be protected by patents, which is a major advantage for HPLC manufacturers. The techniques dif-

fer mainly with regard to derivatization conditions (temperature, time, separation of the reagent), stability of the derivatives and detection methodology (cf. Table 2.3). The ideal reagent has not yet been identified and recent developments have so far not superseded established older methods.

The long-established, slightly cumbersome (long reaction time, distillation for removal of excess reagent in a vacuum) derivatization with PITC was made commercially accessible by Waters as the Pico-Tag method using a dedicated apparatus. The PITC amino acids being formed, which are fairly stable in an acid environment, can cyclize to phenylthiohydantoin (PTH) amino acids in an alkaline environment (secondary reaction). The first-named derivatives are usually chromatographed and detected under UV light. The follow-up products of cysteic acid and methionine sulphone can also be separated chromatographically after oxidation of the sample with performic acid.

Cohen and Strydom (1988) and Molnar-Perl (1994) have written reviews on this subject, Khalifa and Molnar-Perl (1996) studied the effect of salt from the neutralization of the hydrolysates on the derivatization and observed no interference, so that the widely practised removal of the hydrochloric acid by distillation would be superfluous. Vasantis and Molnar-Perl (1999) systematically studied and optimized the separation conditions for 27 amino acids. Elkin and Wasynczuk (1987) successfully applied the technique to feed raw materials and compound feeds and compared it with IEC. The extensively described PITC methodology was considered equivalent to IEC. Zhao *et al.* (1992) also tested animal feed and cereal and reported interference with derivatization in materials with a high starch content. Suzuki and Early (1993), Shang and Wang (1996) and Gonzalez-Castro *et al.* (1997) reported on PITC amino acid analysis in plant products. Toran *et al.* (1996) studied infant formulas and chromatographically optimized the determination of sulphur-containing amino acids, whereas Alonso *et al.* (1994) analysed the free amino acids in these products, which they were able to quantify in just 20 min with an intralaboratory  $CV_r$  of less than 10%. Other authors used this technique

**Table 2.3.** Comparison of chromatographic methods of amino acid analysis.

Method <sup>a</sup>	IEC		HPLC after precolumn derivatization			
	Ninhydrin or OPA post column	PITC	OPA	FMOC	AQC	DABS-Cl
Derivatization reagent <sup>b</sup>	Ninhydrin or OPA post column	PITC	OPA	FMOC	AQC	DABS-Cl
Derivatization time (min)	2 (online reactor)	20	1	2	1	10 min / 70°C
Removal of reagent	No	Evaporation	No	Extraction	No	Yes
Stable derivatives	Color is formed	(Yes)	No	Yes	Yes	Yes
Detects imino acids	Yes	Yes	No	Yes	Yes	Yes
Matrix sensitivity	No	Yes	Yes	Yes	Low	High
Detector	Visible	UV	Fluorescence	Fluorescence	Fluorescence	Visible
Sensitivity (pmol)	50	50	1–5	< 1	1–5	50
Advantages	Long column life, stable and excellent separation and calibration, no matrix sensitivity	HPLC can be used for other determinations, high sensitivity allows analysis of very small sample size, shorter separation times				
Disadvantages	Expensive instrumentation and columns, complex buffer and column temperature programme	Some multiple or unstable derivates, complex purification and extraction, interference from salts and lipids, short column life, poor resolution for some amino acids				
Applications	Standard procedure for feed, digesta and blood	Individual amino acids; peptide research, hydrolysates, physiological fluids				

<sup>a</sup>IEC, ion exchange chromatography; HPLC, high performance liquid chromatography with reversed phase columns.

<sup>b</sup>PITC, phenylisothiocyanate; OPA, orthophthaldialdehyde; FMOC, 9-fluorenylmethylchloroformate; AQC, 6-aminoquinolyl-*N*-hydroxysuccinimidylcarbamate; DABS-Cl, dabsylchloride.

for the analysis of free amino acids in plasma and other biological samples (Hagen *et al.*, 1993; Hariharan *et al.*, 1993; Bugueno *et al.*, 1999; Campanella *et al.*, 1999).

Precolumn derivatization with OPA in combination with a thiol compound combines the advantage of a very rapid reaction time (1 minute at room temperature) with the specificity and sensitivity of fluorescence detection. Although secondary amino acids do not react, this can be avoided by the subsequent addition of FMOC after a complete reaction with OPA with the formation of FMOC-proline for example. The stability of the OPA derivatives is very limited, which is particularly relevant for the important amino acid lysine. This is why OPA derivatization should preferably be fully automated in the autosampler. May and Brown (1989), Molnar-Perl and Bozor (1998), Molnar-Perl and Vasantis (1999) and Molnar-Perl (2001) systematically tested different thiols, reagent mixtures and derivatization conditions for yield and stability of the amino acid derivatives. In a collaborative trial, Bütikofer *et al.* (1991, 1992) compared the accuracy and reproducibility of OPA/FMOC precolumn derivatization in feedstuffs, milk/cereal mixtures and cheese with that of classic ion-exchange chromatography. According to their studies, the within-laboratory repeatability is comparable for hydrolysate analyses, but the sensitivity of fluorescence detection is 5–20 times greater depending on the amino acid, except for lysine. Although the mean concentrations found in the ring test were approximately equal, the reproducibility was distinctly poorer for almost all amino acids, especially the limiting methionine, lysine and threonine, and across all samples. The feedstuff sample fared worst, which the authors attributed to matrix interference during the derivatization. Puchala *et al.* (1994) tested methionine sulphoxide and other amino acids in the rumen of cattle, Li *et al.* (1998) used the method for feed samples, Heems *et al.* (1998) for soybean cattle cake and beverages, Zunin and Evangelisti (1999) for infant formulas, Baek *et al.* (1999) for amino acids and biogenic amines in soy sauces and Herbert *et al.* (2000), and Pripis-Nicolau *et al.* (2001) for analysis of free amino acids in musts and

wines. Other authors tested seafood for free amino acid concentrations (Vazquez-Ortiz *et al.*, 1995; Antoine *et al.*, 1999, 2001). The method was also used for the analysis of free amino acids in blood plasma and urine (Van Eijk *et al.*, 1993; Begley *et al.*, 1994; Fekkes *et al.*, 1995, 2000; Czauderna and Kowalczyk, 1998; Tcherkas *et al.*, 2001).

Another fluorescence-active reagent for precolumn derivatization is FMOC. It reacts quickly with all amino acids at room temperature, but more slowly than OPA. The derivatives are stable and analytical solutions can be stored for several days in a refrigerator. In the presence of water 9-fluorenylmethanol develops from the reagent, which is highly fluorescence-active and elutes in the centre of the amino acid chromatogram. For this reason an extraction step with non-polar solvents is required, a disadvantage if this cannot be done automatically in a special autosampler. Cottingham and Smallidge (1988) have used this technique with good results for the determination of total lysine in complete feeds and supplemented lysine in premixes. Fernandez-Trapiella (1990) tested methionine, cystine and lysine following oxidation with performic acid in soybean meal, meat meal, fishmeal and other feedstuffs and obtained equivalent results when compared with conventional IEC. Yet no further papers on feed analysis with FMOC have been published. Kirschbaum *et al.* (1994a,b,c) determined amino acids and biogenic amines using this methodology, Arnold *et al.* (1994) analysed green coffee beans and Or-Rashid *et al.* (2000) and Sultana *et al.* (2001) tested free amino acids in rumen fluid. Assays in biological samples were also described (Ndibualonji *et al.*, 1992; Ou *et al.*, 1996; Or-Rashid *et al.*, 1999).

In 1993 the company Millipore introduced a new derivatization reagent, 6-aminoquinolyl-*N*-hydroxysuccinimidyl carbamate (AQC), which they tested against IEC for analysis of feed samples (Cohen and Michaud, 1993; Cohen and De Antonis, 1994). According to these studies, the highly fluorescence-active reagent reacts quickly with amino acids, derivatization is very simple to perform and the derivatives formed are stable for several weeks at room temperature. The authors

described HPLC conditions which also separate cysteic acid and methionine sulphone from oxidized hydrolysates, and the reagent peak causes no interference. Liu (1994) tested the recovery of 14 amino acid standards added to a feed hydrolysate and found between 92 and 112% with a mean recovery of 98%, compared with IEC the recovery was 93–110%, except for threonine (85%) and arginine (117%). Indeed, he and some other authors heated the derivatization mixtures for 10 min at 50–55°C in sealed autosampler vials in a reaction block in order to finish the derivatization procedure. Liu *et al.* (1995) tested the methodology thoroughly in food and feed samples, ruling out interference from salt in neutralized hydrolysates. The depicted chromatograms of broiler feed and maize show good separation of all amino acids in the oxidized hydrolysate. Good agreement with IEC is achieved in several samples, including for arginine and threonine. Van Wendelen and Cohen (1997) studied the separation conditions in collagen hydrolysates and cell culture media samples and designed an optimal quaternary eluent system. Reverter *et al.* (1997) used this technique to analyse blood plasma of swine, but were unable to achieve complete separation of all plasma amino acids with the dual gradient system employed. Miao *et al.* (2000) reported on analyses of various foodstuffs with 88–110% recovery of all amino acids.

Another derivatization reagent, which has been around for some time, is dabsyl chloride, which is typically kept for 12 min at 70°C for conversion with amino acids and yields stable, coloured derivatives which can be detected with a photometer at 436 nm. Schneider (1989) of the company Beckman gave an overview of separating conditions and reproducibility of the technique, Drnevich and Vary (1993) used it to analyse blood plasma samples, Ikeda *et al.* (1993) employed this reagent for the determination of hydroxyproline and proline in collagen and Krause *et al.* (1995) tested amino acids and biogenic amines in biological samples and food.

Also worth mentioning is the fluorescence-active, long-established reagent dansyl chloride which was used by Sanz *et al.* (1996) for the analysis of milk and egg protein, and

two projects concerned with the analysis of amino acids in feed or plant raw materials after derivatization to volatile compounds by means of gas chromatography (GC-MS) (Oh *et al.*, 1995; Muranszky, 1996).

### Specific detection of single amino acids

If the intention is to determine the concentration of a single amino acid in the hydrolysate or in its free form in fermentation solutions, juices or extracts, chromatographic separation can be omitted altogether if a reagent or enzymatic reaction is used that is specific for this particular amino acid. Marko-Varga *et al.* (1993) reported on enzymatic detection systems specific for amino acids. Pohlmann *et al.* (1990) have developed an enzymatic flow-injection method which is specific for lysine and allows up to 30 assays per hour. Using a similar flow-injection analysis, Lavagnini *et al.* (1993) determined lysine concentrations in feed hydrolysates and Chen *et al.* (1996) analysed supplemented lysine in fish food. Vrbova *et al.* (1992) described an enzyme electrode specific for L-lysine which enabled its determination in wheat extracts. A fluorimetric assay of lysine in feed hydrolysate following reaction with L-lysine oxidase was described by Hikuma *et al.* (1991) which showed a high degree of concordance with IEC for compound feeds, fish meal and soy. Ninhydrin-ferric reagent was used by Hsieh *et al.* (1995) for the determination of lysine in culture broth. Colorimetric assays of tryptophan have been mentioned above.

### Available/reactive lysine

Lysine in protein is highly susceptible to damage through heat treatment as it possesses a reactive  $\epsilon$ -amino group, especially if reducing sugars are present. The follow-up products of lysine created during Maillard reactions for example (Eichner *et al.*, 1994) are no longer available for animal or human protein synthesis. In 1960 Carpenter introduced an *in vitro* test for available, better reactive lysine, in which the protein was reacted with fluoro-2,4-dinitrobenzene (FDNB) and the resulting



coloured dinitrophenyl (DNP)-lysine was determined photometrically following hydrolysis. Only converted lysine that was still reactive at the  $\epsilon$ -amino group is in theory available for the protein metabolism of animals. Other reagents and test conditions such as conversion with OPA or guanidination to homoarginine have also been described (see below). But such tests are beset by numerous problems, from the chemical accessibility of the  $\epsilon$ -amino group for derivatization in the sample protein suspended in the solution to interferences and secondary reactions caused by the matrix. A more sophisticated FDNB method was therefore often used, where the total lysine from the underivatized sample and unconverted lysine were determined chromatographically after reaction with FDNB and hydrolysis, the difference being the available lysine. Carpenter *et al.* (1989) compared these and two further *in vitro* tests on lysine availability in fish, meat and plant-derived food products with the *in vivo* rat growth assay; all *in vitro* tests, except those in the pure protein samples casein and soy protein, failed. Faldet *et al.* (1991, 1992) applied the aforementioned differential method and the rat growth assay to soybeans subjected to heat treatment under different conditions in order to optimize protein utilization by ruminants and obtained a reasonable match for lysine utilization. More recent research went further in determining DNP-lysine by HPLC in cereal-based baby food, infant formulas and other food, but without drawing comparisons with biological tests (Castillo *et al.*, 1997; Albala-Hurtado *et al.*, 1997; Fernandez-Artigas *et al.*, 1999; Hernandez *et al.*, 2001).

Mauron and Bujard (1964) developed an assay of available lysine which is based on the guanidination of the  $\epsilon$ -amino group with *o*-methyl-isourea in an alkaline environment to homoarginine, which can then be chromatographically determined by IEC following hydrolysis. Although this derivatization in protein is only possible at room temperature and requires a reaction time of several days, it is still in common use today. Mao *et al.* (1993) employed the method for the determination of available lysine in soy proteins treated with glucose or alkali and compared it with the total lysine assay. They showed that whereas total lysine

declined by 17–40% after the treatments by reacting with glucose, available lysine fell by as much as 78–85%. Damage caused by heat treatment with alkali was also identified far more efficiently with guanidination, which was explained by a re-cleaving of some of the damaged lysine (e.g. fructose-lysine of the initial Maillard reaction) in acid hydrolysis. Imbeah *et al.* (1996) optimized the reaction conditions of guanidination in casein and soybean meal. They achieved 100% lysine conversion for the soluble milk protein and just under 80% for soy. These authors, like Ravindran *et al.* (1996), were interested in the preparative guanidination of feedstuff to determine endogenous amino acid secretions in digestibility trials. The latter studies focused mainly on optimal conversion in cottonseed protein, where up to 64% of the lysine was converted into homoarginine, and conversion rates of other feed raw materials are also given. Moughan and Rutherford (1996) also devised optimal derivatization conditions and compared the reactive lysine of guanidination with that determined in the FDNB test for heat-treated casein/lactose mixtures, with a good degree of concordance. This and subsequent studies (Rutherford and Moughan, 1997; Rutherford *et al.*, 1997) focused primarily on the development of a new bioassay 'digestible reactive lysine', which would allow a more accurate determination of lysine digestibility in digestibility trials because the re-cleaving of previously damaged lysine which can occur during protein hydrolysis in lysine assays of raw material and digesta is eliminated. Research concerned with the determination of the available lysine content in proteins, dairy products or milk by reaction with OPA should also be mentioned (Vigo *et al.*, 1992; Medina-Hernandez and Alvarez-Coque, 1992; Morales *et al.*, 1996). A great advantage of this method is the rapidity and simplicity of fluorescence measurement as no prior protein hydrolysis is necessary.

*In vitro* methods are appropriate and helpful for comparing different treatments of a feed raw material or foodstuff. Relative effects are meaningful in such tests, but absolute results concerning lysine availability are heavily influenced by matrix effects on the test system and often diverge considerably from animal experiments.

### Data on precision and accuracy

Regular collaborative trials on amino acid analysis have been conducted for many years by different organizations, and quality assurance of this kind is indeed obligatory today if a laboratory wishes to become accredited, however these results are not published. Organizations that are accessible to all laboratories are AAFCO (USA) with monthly ring tests, Bipea (France) and KDLL (Netherlands) with four to eight samples per year. The results of these and other organizations, which are unfortunately not accessible, provide a more accurate indication of the state of the art in amino acid analysis than published collaborative trials, which are mostly concerned with method design and standardization. Table 2.2 gives an overview of some published results from literature sources described above, mostly relating to the adoption of official methods by AOAC International or the EU Commission. One of the reasons for the somewhat lower precision of the assay of total concentrations of sulphur-containing amino acids is the prior oxidation in the protein, which introduces additional variation in sample preparation; another reason is due to their almost universally low concentrations of only 0.6–3% in the protein, causing small peaks and greater peak integration errors. Moreover, in IEC cysteic acid elutes almost in the dead volume of the column, confining matrix interferences to this area. Due to the simplicity of the extraction, analysis of supplemented amino acids gives lower CV than determination of total concentrations. Within-laboratory repeatability  $CV_r$  are always better by a factor of about 2–5 than the reproducibility  $CV_R$  between laboratories because the random error is inevitably greater in the latter due to different equipment, handling and calibration. The accuracy and precision of standard methods of amino acid analysis are adequate for the requirements of the feed industry provided that the laboratories are continuously monitored by ring tests and comparisons.

### NIRS Amino Acid Estimation in Feedstuffs

Near-infrared spectroscopy (NIRS) in reflectance technique is an easy to do analyti-

cal method which only requires grinding of the samples and scanning of the feedstuff in an NIRS apparatus. The measurement, which is non-destructive, requires no chemicals and results are ready within a few minutes. Since the early 1970s sample spectra of feed raw materials or compound feeds have been correlated with the respective concentrations of crude ingredients, analysed by wet chemistry, and multivariate calibrations were established from a sample set with chemometric correlations (Kramer, 1998 and monographs cited there). At that time only universities and research institutes had mainframe computers powerful enough to do this work. This kind of calibration, which should contain at least 50 or so samples to cover most of the variation of the sample type, can then be used for estimating the calibrated parameters in new samples. Rubenthaler and Bruinsma (1978) and Gill *et al.* (1979) were the first to develop calibrations of amino acid contents in wheat and barley, followed a few years later by the published papers on calibrations in cereal and peas (Williams *et al.*, 1984, 1985). But it was not until the 1990s before this attractive estimation technique found more widespread acceptance, including use in feed mills, with the advent of low-cost, powerful personal computers and the development of software allowing the transfer of calibrations to other, adapted NIR-spectrometers. Workman (1991), Michalski and Mroczyk (1992), Shenk (1994), Dyer and Feng (1996, 1997) and Pazdernik *et al.* (1997) also developed sufficiently accurate amino acid calibrations for soybean meal and seed, grains and rapeseed, generally with the intention of replacing expensive wet chemical amino acid analysis in their extensive raw material studies partially by NIRS estimations. In all of these cases the use of these amino acid calibrations was limited both geographically and seasonally. The amino acid manufacturer Rhône-Poulenc, now Aventis, was the first company to use existing raw material samples from digestibility studies to design calibrations for estimation of poultry digestible and total amino acid concentrations as a service to customers worldwide. Papers by Van Kempen and Jackson (1996), Van Kempen and Simmins (1997), Van Kempen and Bodin (1998) and Bodin *et*

*al.* (1999) describe the results obtained for essential amino acids in all major feed raw materials. The objective of the work was to promote the use of digestible amino acid contents in ration formulation, which allows quality fluctuations of the raw material to be estimated by NIRS without having to rely solely on tabular digestibility data. Because of the very high costs of digestibility trials, researchers were forced by a lack of enough characterized raw material batches to establish a combined animal meal calibration from a total of 66 samples of fishmeal, poultry meal, and meat and bone meal and calibrations for soy meal, wheat and maize based on only 20–30 samples per raw material. The resulting insufficient coverage of the raw material variation together with unknown analytical errors, never quantified in collaborative trials, of the digestibility coefficients determined in animal experiments, cast some doubt on the reliability of the predictions. The service laboratory of Degussa, which specializes in amino acid analysis, concentrated on the development of calibrations of total amino acid contents in individual raw materials. Fontaine *et al.* (2001, 2002) describe the development of 14 raw material calibrations, most containing 100–330 samples, which are regularly updated. In most cases fractions of explained variance for cross validation  $r^2$  far in excess of 0.8 were achieved for the correlation between NIRS and wet chemical data and the standard errors of cross validation (SECV) are typically only 2–5% relative to the mean of essential amino acid contents for protein-rich feedstuffs calibrations. Additionally validations with about 100 independent samples for each of the soy, meat and bone meal and wheat calibrations corroborate the accuracy of NIRS amino acid estimations. The calibrations can be transferred to equipment in feed mills and are used in Degussa laboratories to analyse more than 5000 raw material samples per year. The central development of NIRS calibrations by experienced specialists is an efficient way of encouraging the widespread use of NIRS in feed analysis by enabling for the first time the time-critical quality estimation of each individual raw material batch.

## Applications of Amino Acid Analysis in Feed

### Optimization of feed formulation

All diets for poultry and swine are today formulated to match the amino acid requirement of the species to achieve optimal growth and feed conversion. To do this the nutritionist needs reliable data on the amino acid composition of his feed raw materials. If NIR amino acid calibrations are available any quality fluctuations can be corrected by supplementation of amino acids. Due to the complexity and high cost of the technique, chromatographic amino acid analysis is usually not available to the feed manufacturer, but he will seek to improve his matrix data in the medium term by having his own raw materials analysed in an external laboratory. Up-to-date tabular data by national organizations (CVB, 2001; NRC, 1998, 2001) summarizing the amino acid concentrations of raw materials across many samples are also helpful. Fickler *et al.* (2001) have compiled more than 15,000 amino acid profiles of 120 raw materials which provide information on variations in the concentrations, together with breakdowns by country of origin. The authors have even established linear regression equations for most raw materials, allowing an estimation of the amino acid content of a sample from the analysed crude protein.

### Determination of digestible amino acids

Experts have for many years recommended compound feed formulation on the basis of digestible amino acids in raw materials, especially in the case of protein-rich raw materials that have been subjected to thermal treatment such as soy and rapeseed meals, meat and bone meal, poultry by-product meal and feather meal. The assay has to be performed separately for each species in complex animal experiments, often requiring removal of digesta from the gut. Because the calculation of the digestibility coefficients of the tested raw material batch correlates dietary amino acid concentrations with unabsorbed amino acids in the digesta or faeces, extremely high demands are placed on accuracy

and precision of the analysis. As the work is done in different matrices, analysis by IEC and postcolumn ninhydrin derivatization is preferable to HPLC after precolumn derivatization.

### Check for compound feed quality

Declarations of amino acid concentrations in commercial animal feedingstuffs are compulsory in many countries and are monitored by means of official amino acid analysis. But regular analyses of the amino acid composition of compound feeds and premixes are also necessary as a quality assurance tool, i.e. to check ration formulation and production. Of particular concern is the accurate and homogeneous incorporation of the supplemented amino acids as they account for a considerable proportion of the total content and have therefore a major impact on animal performance. The given good repeatability of extraction and analysis of these supplemented amino acids has led to the elaboration of a mixer test which determines concentrations and variation (CV) in typically ten samples from a mixer batch (Poole, 1991; Fontaine, 2002). A summary evaluation over several years revealed that in about one-fifth of feeds with an analysed CV of more than 10% the distribution of the amino acids in the feed is not sufficiently homogeneous.

### Conclusions

- 1.** Amino acid analysis of feedingstuffs is more important than ever today as virtually all compound feeds are formulated with supplemental amino acids and a sound knowledge of amino acid content in current raw materials delivers considerable cost savings.
- 2.** Because of its high precision and resistance to matrix effects, amino acid analysis by IEC and postcolumn ninhydrin derivatization has become the official standard in recent years. Hydrolysis conditions have also been standardized. None of the various methods of HPLC analysis after precolumn derivatization have prevailed over this classic technique.
- 3.** Tryptophan in feed is determined underivatized after alkaline hydrolysis, separated by HPLC on RP-silica gel and measured specifically by fluorescence detection. Hydrolysis with barium hydroxide in an autoclave gives optimal recovery.
- 4.** The development of robust NIRS calibrations for amino acid analysis in feed raw materials from global origin by service laboratories of amino acid manufacturers and their transfer to spectrometers in feed mills for the first time allows a continuous adaptation of diet formulation to current raw material batches.

### References

- Albala-Hurtado, S., Bover-Cid, S., Izquierdo-Pulido, M., Veciana-Nogues, M.T. and Vidal-Carou, M.C. (1997) Determination of available lysine in infant milk formulae by high-performance liquid chromatography. *Journal of Chromatography A* 778, 235–241.
- Albin, D.M., Wubben, J.E. and Gabert, V.M. (2000a) Effect of hydrolysis time on the determination of amino acids in samples of soybean products with ion-exchange chromatography or precolumn derivatization with phenylisothiocyanate. *Journal of Agricultural and Food Chemistry* 48, 1684–1691.
- Albin, D.M., Wubben, J.E. and Gabert, V.M. (2000b) The influence of hydrochloric acid concentration and measurement method on the determination of amino acid levels in soya bean products. *Animal Feed Science and Technology* 87, 173–186.
- Alegria, A., Barbera, R., Farre, R., Ferreres, M., Lagarda, M.J. and Lopez, J.C. (1996) Isocratic high performance liquid chromatographic determination of tryptophan in infant formulas, *Journal of Chromatography A* 721, 83–88.
- Alonso, M.L., Alvarez, A.I. and Zapico, J. (1994) Rapid analysis of free amino acids in infant foods. *Journal of Liquid Chromatography* 17, 4019–4030.
- Amiss, T.J., Tyczkowska, K.L. and Aucoin, P. (1990) Analysis of taurine in feline plasma and whole blood by liquid chromatography with fluorometric detection and confirmation by thermospray mass spectrometry. *Journal of Chromatography* 526, 375–382.

- Antoine, F.R., Wei, C.I., Littell, R.C. and Marshall, M.R. (1999) HPLC method for analysis of free amino acids in fish using *o*-phthalaldehyde precolumn derivatization. *Journal of Agricultural and Food Chemistry* 47, 5100–5107.
- Antoine, F.R., Wei, C.I., Littell, R.C., Quinn, B.P., Hogle, A.D. and Marshall, M.R. (2001) Free amino acids in dark- and white-muscle fish as determined by *o*-phthalaldehyde precolumn derivatization. *Journal of Food Science* 66, 72–77.
- AOAC (1994) Method 994.12 Amino Acids in Feeds. In: *Official Methods of Analysis*, 16th edn. AOAC International, Arlington, Virginia, chapter 4, 4–4H.
- Aristoy, M.-C. and Toldra, F. (1991) Deproteinization for HPLC amino acid analysis in fresh pork muscle and dry-cured ham. *Journal of Agricultural and Food Chemistry* 39, 1792–1795.
- Arlorio, M., Coisson, J.D. and Martelli, A. (1998) Ion-pair HPLC determination of biogenic amines and precursor amino acids. Application of a method based on simultaneous use of heptanesulfonate and octylamine to some foods. *Chromatographia* 48, 763–769.
- Arnold, U., Ludwig, E., Kuehn, R. and Moenschwitzer, U. (1994) Analysis of free amino-acids in green coffee beans. I. Determination of amino-acids after precolumn derivatization using 9-fluorenylmethylchloroformate. *Zeitschrift für Lebensmitteluntersuchung und Forschung A* 199, 22–25.
- Baek, I.-G., Spengler, U. and Bruckner, H. (1999) Determination of amino acids and biogenic amines in oriental fermented foods. *Lebensmittelchemie* 53, 117.
- Balschukat, D. and Kunesch, H. (1988) Determination of taurine: influence of the coil temperature on the taurine peak purity. *Journal of Chromatography* 462, 105–113.
- Bech-Andersen, S. (1991) Determination of tryptophan with HPLC after alkaline hydrolysis in autoclave using  $\alpha$ -methyl-tryptophan as internal standard. *Acta Agriculturae Scandinavica* 41, 305–309.
- Bech-Andersen, S. (1997) Determination of lysine, methionine and threonine in premixes with high contents of metal salts. *Agribiological Research* 50, 123–127.
- Bech-Andersen, S., Mason, V.C. and Dhanoa, M.S. (1990) Hydrolysate preparation for amino acid determinations in feed constituents: 9. Modifications of oxidation and hydrolysis conditions for streamlined procedures. *Zeitschrift für Tierphysiologie, Tierernährung und Futtermittelkunde* 63, 188–197.
- Begley, D.J., Reichel, A. and Ermisch, A. (1994) Simple high-performance liquid-chromatographic analysis of free primary amino-acid concentrations in rat plasma and cisternal cerebrospinal fluid. *Journal of Chromatography B* 657, 185–191.
- Bizanek, R., Manes, J.D. and Fujinari, E.M. (1996) Chemiluminescent nitrogen detection as a new technique for purity assessment of synthetic peptides separated by reversed-phase HPLC. *Peptide Research* 9, 40–44.
- Bodin, J.-C., Maillard, R., Venuat, M. and Jackson, D. (1999) La Technique NIRS: Un outil pour la prediction des Acides Amines totaux et digestibles. 3. *Journées de la Recherche Avicole*. St Malo, France, 189–191.
- Bugueno, G., Escriche, I., Serra, J.A., Munoz, O. and Rastrepo J. (1999) Determination of free amino acids in raw muscle of salmon (*Salmo salar*) by HPLC. Precolumn derivatization with phenylisothiocyanate. *Alimentaria* 299, 77–80.
- Bütikofer, U., Fuchs, D. and Bosset, J.O. (1992) Quantitative determination of amino acids from hydrolysates: evaluation of an interlaboratory test with classical ion exchange amino acid analyzers and HPLC-systems with OPA/FMOC-precolum derivatization. *Mitteilungen aus dem Gebiete der Lebensmitteluntersuchung und Hygiene* 83, 457–466.
- Bütikofer, U., Fuchs, D., Bosset, J.O. and Gmür, W. (1991) Automated HPLC-amino acid determination of protein hydrolysates by precolum derivatization with OPA and FMOC and comparison with classical ion exchange chromatography. *Chromatographia* 31, 441–447.
- Campanella, L., Crescentini, G. and Avino, P. (1999) Simultaneous determination of cysteine, cystine and 18 other amino acids in various matrices by high-performance liquid chromatography. *Journal of Chromatography A* 833, 137–145.
- Carisano, A. (1992) Rapid digestion of proteins in food by using a microwave oven. 1. Determination of amino acids (excluding tryptophan, cysteine, and methionine). *Industria Alimentara* 31, 891–895.
- Carisano, A. (1993) Digestion of proteins in food by using a microwave oven. II. Determination of tryptophan. *Industria Alimentara* 32, 346–348.
- Carpenter, K.J. (1960) The estimation of available lysine in animal protein foods. *Biochemical Journal* 77, 604–610.
- Carpenter, K.J., Steinke, F.H., Catignani, G.L., Swaisgood, H.E., Allred, M.C., MacDonald, J.L. and Schelstraete, M. (1989) The estimation of 'available lysine' in human foods by three chemical procedures. *Plant Foods for Human Nutrition* 39, 12–135.

- Casella, I.G., Gatta, M. and Cataldi, T.R.I. (2000) Amperometric determination of underivatized amino acids at a nickel-modified gold electrode by anion-exchange chromatography. *Journal of Chromatography A* 878, 57–67.
- Castillo, G., Sanz, M.A., Serrano, M.A., Hernandez, T. and Hernandez, A. (1997) An isocratic high-performance liquid chromatographic method for determining the available lysine in foods. *Journal of Chromatographic Science* 35, 423–429.
- Chen, R.L.C., Lee, M.-H. and Masumoto, K. (1996) Selective biosensing of L-lysine by a low-temperature flow-injection technique using an immobilized lysine oxidase reactor. *Analytical Sciences* 12, 87–90.
- Cohen, S.A. and De Antonis, K.M. (1994) Applications of amino acid derivatization with 6-aminoquinolyl-N-hydroxysuccinimidyl carbamate. Analysis of feed grains, intravenous solutions and glycoproteins. *Journal of Chromatography A* 661, 25–34.
- Cohen, S.A. and Michaud, D.P. (1993) Synthesis of a fluorescent derivatizing reagent, 6-aminoquinolyl-N-hydroxysuccinimidyl carbamate, and its application for the analysis of hydrolysate amino-acids via high-performance liquid chromatography. *Analytical Biochemistry* 211, 279–287.
- Cohen, S.A. and Strydom, D.J. (1988) Amino acid analysis utilizing phenylisothiocyanate derivatives. *Analytical Biochemistry* 174, 1–6.
- Commission Directive 2000/45/EC of 6 July 2000, establishing Community methods for the determination of vitamin A, vitamin E and tryptophan, annex part C, Determination of tryptophan. *Official Journal of the European Communities* L174, 45–50.
- Commission Directive 98/64/EC of 3 September 1998, establishing Community methods for the determination of amino-acids, crude oils and fats, and olanquinox in feedingstuff and amending Directive 71/393/EEC, annex part A, Determination of amino acids. *Official Journal of the European Communities* L257, 14–23.
- Cottingham, L. and Smallidge R. (1988) Reverse-phase liquid chromatographic determination of lysine in complete feeds and premixes, using manual precolumn derivatization. *Journal of the Association of Official Analytical Chemists* 71, 1012–1016.
- CVB (2001) *Veevoedertabel 2001*. Central Veevoederbureau, Postbus 2176, 8203 AD Lelystad, The Netherlands.
- Czuderna, M. and Kowalczyk, J. (1998) Determination of free amino acids in blood plasma by high-performance liquid chromatography with fluorescence detection. *Journal Animal Feed Sciences* 7, 453–463.
- De Bruijn, J.M. and Bout, M. (2000) HPAEC analysis of amino acids in sugar beet samples: method development and application. *Zuckerindustrie* 125, 604–609.
- De Jonge, L. and Breuer, M. (1994) Modification of the analysis of amino-acids in pig plasma. *Journal of Chromatography B* 652, 90–96.
- Delhaye, S. and Landry, J. (1992) Determination of tryptophan in pure proteins and plant material by three methods. *Analyst* 117, 1875–1877.
- Delhaye, S. and Landry, J. (1993) Quantitative determination of tryptophan in food and feedstuffs: practical considerations on autoclaving samples for hydrolysis. *Journal of Agricultural and Food Chemistry* 41, 1633–1634.
- Drnevich, D. and Vary, T.C. (1993) Analysis of physiological amino acids using dabsyl derivatization and reversed-phase liquid chromatography. *Journal of Chromatography* 613, 137–144.
- Dyer, D.J. and Feng, P. (1996) NIR applications in the development of genetically altered grains. *Near Infrared Spectroscopy: Procedures of 7th International Conference*, pp.490–493.
- Dyer, D.J. and Feng, P. (1997) NIR destined to be major analytical influence. *Feedstuffs* 10 Nov., 16–19, 24–25.
- Eichner, K., Reutter, M. and Wittmann, R. (1994) Detection of Amadori compounds in heated foods. *ACS Symposium Series* 543, 42–54.
- Elkin, E.G. and Griffith, J.E. (1985) Hydrolysate preparation for analysis of amino acids in sorghum grains: effect of oxidative pretreatment. *Journal of the Association of Official Analytical Chemists* 68, 1117–1121.
- Elkin, E.G. and Wasynczuk, A.M. (1987) Amino acid of feedstuff hydrolysates by precolumn derivatization with phenylisothiocyanate and reversed-phase high-performance liquid chromatography. *Cereal Chemistry* 64, 226–229.
- Fahrenstich, R. and Tanner, H. (1973) Bestimmung von supplementierten Aminosäuren in Futtermitteln und Mischfuttern. *Landwirtschaftliche Forschung* 27.
- Faldet, M.A., Voss, V.L., Broderick, G.A. and Satter, L.D. (1991) Chemical, *in vitro*, and *in situ* evaluation of heat-treated soybean proteins. *Journal of Dairy Science* 74, 2548–2554.

- Faldet, M.A., Satter, L.D. and Broderick, G.A. (1992) Determining optimal heat treatment of soybeans by measuring available lysine chemically and biologically with rats to maximize protein utilization by ruminants. *Journal of Nutrition* 122, 151–160.
- Fekkes, D. (1996) State-of-the-art of high-performance liquid chromatographic analysis of amino acids in physiological samples. *Journal of Chromatography B* 682, 3–22.
- Fekkes, D., van Dalen, A., Edelman, M. and Voskuilen, A. (1995) Validation of the determination of amino-acids in plasma by high performance liquid chromatography using automated precolumn derivatization with o-phthalaldehyde. *Journal of Chromatography B* 669, 177–186.
- Fekkes, D., Voskuilen-Kooyman, A., Jankie, R. and Huijmans, J. (2000) Precise analysis of primary amino-acids in urine by an automated high-performance liquid chromatography method: comparison with ion-exchange chromatography. *Journal of Chromatography B* 744, 183–188.
- Fernandez-Artigas, P., Garcia-Villanova, B. and Guerra-Hernandez, E. (1999) Blockage of available lysine at different stages of infant cereal production. *Journal of the Science of Food and Agriculture* 79, 851–854.
- Fernandez-Trapiella, A.C. (1990) Quantitative analysis of methionine, cysteine, and lysine in feeds by reversed-phase liquid chromatography using precolumn derivatization with 9-fluorenylmethyl chloroformate: preliminary study. *Journal of the Association of Official Analytical Chemists* 73, 935–939.
- Fickler J., Fontaine J. and Heimbeck, W. (2001) *The Amino Acid Composition of Feedstuffs (AminoDat™)*, 5th completely revised edition. Degussa AG, Feed Additives Division, Hanau, Germany.
- Fontaine, J. (2002) AminoBatch™ – How is your mixer performing? *AminoNews™*, Degussa's Information for the Feed Industry 3 (1), Degussa AG, Hanau, Germany, pp.13–16.
- Fontaine, J. and Eudaimon, M. (2000) Liquid chromatographic determination of lysine, methionine, and threonine in pure amino acids (feed grade) and premixes: collaborative study. *Journal of AOAC International* 83, 771–783.
- Fontaine, J., Bech-Andersen, S., Bütikofer, U. and de Froidmont-Görtz, I. (1998) Determination of tryptophan in feed by HPLC – development of an optimal hydrolysis and extraction procedure by the EU Commission DG XII in three international collaborative studies. *Agribiological Research* 51, 97–108.
- Fontaine, J., Hörr, J. and Schirmer, B. (2001) Near infrared reflectance spectroscopy enables the fast and accurate prediction of the essential amino acid contents in soy, rapeseed meal, sunflower meal, peas, fishmeal, meat meal products and poultry meal. *Journal of Agricultural and Food Chemistry* 49, 57–66.
- Fontaine, J., Schirmer, B. and Hörr, J. (2002) Near infrared reflectance spectroscopy (NIRS) enables the fast and accurate prediction of the essential amino acid contents. 2. Results for wheat, barley, corn, triticale, wheatbran/middlings, rice bran and sorghum. *Journal of Agricultural and Food Chemistry* 50, 3902–3911.
- Foulon, M., Vanbelle, M., Bruyer, D. and Teller, E. (1990) Détermination de la lysine et de la méthionine. *Revue de l'Alimentation Animale* 440, 40–41
- Fountoulakis M. and Lahm, H.-W. (1998) Hydrolysis and amino acid composition of proteins. *Journal of Chromatography A* 826, 109–134.
- Fujinari, E.M., Ribble, E. and Piserchio, M.V. (1993) Nitrogen-specific liquid chromatography detection of amino acids, peptides, and proteins by HPLC-CLND. *Developments in Food Science* 32, 75–89.
- Gehrke, C.W., Rexroad, P.R., Schisla, R.M., Absheer, J.S. and Zumwalt, R.W. (1987) Quantitative analysis of cystine, methionine, lysine, and nine other amino acids by a single oxidation-4 hour hydrolysis method. *Journal of the Association of Official Analytical Chemists* 70, 171–174.
- Gill, A.A., Starr, C. and Smith, D.B. (1979) Lysine and nitrogen measurement by NIR-analysis as an aid to barley breeding. *Journal of Agricultural Science* 93, 727–733.
- Gonzalez-Castro, M.J., Lopez-Hernandez, J., Simal-Lozano, J. and Oruna-Concha, M.J. (1997) Determination of amino acids in green beans by derivatization with phenylisothiocyanate and high-performance liquid chromatography with ultraviolet detection. *Journal of Chromatographic Science* 35, 181–185.
- Grunau, J.A. and Swiader, J.M. (1992) Chromatography of 99 amino acids and other ninhydrinreactive compounds in the Pickering lithium gradient system. *Journal of Chromatography* 594, 165–171.
- Hagen, S.R., Augustin, J., Grings, E. and Tassinari, P. (1993) Precolumn phenylisothiocyanate derivatization and liquid chromatography of free amino acids in biological samples. *Food Chemistry* 46, 319–323.

- Hara, K., Hijikata, Y., Hiraoka, E., Ogawa, N. and Takahashi, H. (1999) Measurement of urinary amino acid using high-performance liquid chromatography equipped with a strong cation exchange resin precolumn. *Annals of Clinical Biochemistry* 36, 202–206.
- Hariharan, M., Naga, S. and Van Noord, T. (1993) Systematic approach to the development of plasma amino-acid analysis by high-performance liquid chromatography with ultraviolet detection with precolumn derivatization using phenylisothiocyanate. *Journal of Chromatography B* 132, 15–22.
- Hauck, M. (1990) Enzymatische Hydrolyse von Proteinen zur Aminosäurenbestimmung und Probenvorbereitung. *Deutsche Lebensmittel-Rundschau* 86, 12–15.
- Heems, D., Luck, G., Fraudeau, C. and Verette, E. (1998) Fully automated precolumn derivatization, on-line dialysis and high-performance liquid chromatographic analysis of amino acids in food, beverages and feedstuff. *Journal of Chromatography A* 798, 9–17.
- Herbert, P., Barros, P., Ratola, N. and Alves, A. (2000) HPLC determination of amino-acids in musts and port wine using OPA-FMOC derivatives. *Journal of Food Science* 65, 1130–1133.
- Hernandez, A., Serran, M.A., Munoz, M.M. and Castillo, G. (2001) Liquid chromatographic determination of the total available free and intrachain lysine in various foods. *Journal of Chromatographic Science* 39, 39–43.
- Hikuma, M., Kawarai, M., Tonooka, Y. and Hashimoto, K. (1991) Determination of L-lysine in feeds by fluorometric method based on L-lysine oxidase. *Analytical Letters* 24, 2225–2236.
- Hsieh, C.-L., Hsiung, K.-P. and Su, J.-C. (1995) Determination of lysine with ninhydrin-ferric reagent. *Analytical Biochemistry* 224, 187–189.
- Ikeda, M., Sorimachi, K., Akimoto, K. and Yasumura, Y. (1993) Reversed-phase high-performance liquid-chromatographic analysis of hydroxyproline from collagen by derivatization with dabsyl chloride. *Journal of Chromatography B* 132, 133–138.
- Imbeah, M., Angkanaporn, K., Ravindran, V. and Bryden, W.L. (1996) Investigations of the guanidination of lysine in proteins. *Journal of the Science of Food and Agriculture* 72, 213–218.
- Jandik, P., Cheng, J., Jensen, D., Manz, S. and Avdalovic, N. (2000) New technique for increasing retention of arginine on an anion-exchange column. *Analytical Biochemistry* 287, 38–44.
- Jandik, P., Cheng, J., Jensen, D., Manz, S. and Avdalovic, N. (2001) Simplified in-line sample preparation for amino acid analysis in carbohydrate containing samples. *Journal of Chromatography B* 758, 189–196.
- Jensen, D. and Hofler, F. (1999) Chromatographic analysis of amino acids with IPAD detection. *Oesterreichische Chemie Zeitung* 100, 136–139.
- Joergensen, L. and Thestrup, H.N. (1995) Determination of amino acids in biomass and protein samples by microwave hydrolysis and ion-exchange chromatography. *Journal of Chromatography A* 706, 421–428.
- Klampfl, C.W., Buchberger, W., Turner, M. and Fritz, J.S. (1998) Determination of underivatized amino acids in beverage samples by capillary electrophoresis. *Journal of Chromatography A* 804, 349–355.
- Khalifa, M. and Molnar-Perl, I. (1996) The analysis of phenylthiocarbonyl amino acids in the presence of sodium chloride. *LC GC International* 9, 143–147.
- Kirschbaum, J., Luckas, B. and Beinert, W.-D. (1994a) Application of automatic precolumn derivatization with 9-fluorenylmethyl chloroformate (FMOC-Cl) for the determination of biogenic amines and amino acids in food by HPLC. *Deutsche Lebensmittel-Rundschau* 90, 224–228.
- Kirschbaum, J., Luckas, B. and Beinert, W.-D. (1994b) HPLC analysis of biogenic amines and amino acids in food after automatic pre-column derivatization with 9-fluorenylmethyl chloroformate. *American Laboratory* 26, 280–288.
- Kirschbaum, J., Luckas, B. and Beinert, W.-D. (1994c) Pre-column derivatization of biogenic amines and amino acids with 9-fluorenylmethyl chloroformate and heptylamine. *Journal of Chromatography A* 661, 193–199.
- Kivi, J.T. (2000) Amino acids. In: Nolle, L.M.L. (ed.) *Food Analysis by HPLC*. Marcel Dekker, New York, pp. 55–97.
- Kramer, R. (1998) *Chemometric Techniques for Quantitative Analysis*. Marcel Dekker, New York, 203 pp.
- Krause, I., Bockhardt, A., Neckermann, H., Henle, T. and Klostermeyer, H. (1995) Simultaneous determination of amino acids and biogenic amines by reversed-phase high-performance liquid chromatography of the dabsyl derivatives. *Journal of Chromatography A* 715, 67–79.
- Kroll, J., Rawel, H. and Kroeck, R. (1998) Microwave digestion of proteins. *Zeitschrift für Lebensmitteluntersuchung und Forschung A* 207, 202–206.



- Landry, J. and Delhaye, S. (1992a) Determination of tryptophan in feedstuffs: comparison of two methods of hydrolysis prior to HPLC analysis. *Journal of the Science of Food and Agriculture* 58, 439–441.
- Landry, J. and Delhaye, S. (1992b) Simplified procedure for the determination of tryptophan of foods and feedstuffs from barytic hydrolysis. *Journal of Agricultural and Food Chemistry* 40, 776–779.
- Landry, J. and Delhaye, S. (1994a) Determination of tryptophan in feedstuffs: comparison of sodium hydroxide and barium hydroxide as hydrolysis agents. *Food Chemistry* 49, 95–97.
- Landry, J. and Delhaye, S. (1994b) Tryptophan determination in feedstuffs: a critical examination of data from two collaborative studies through the evaluation of tryptophan recovery, *Journal of Agricultural and Food Chemistry* 42, 1717–1721.
- Lavagnini, M.G., Moscone, D., Palleschi, G., Compagnone, D. and Cremisini, C. (1993) Amperometric lysine bioprobes analysis in feeds. *Talanta* 40, 1301–1306.
- Le Boucher, J., Charret, C., Coudrax-Lucas, C., Giboudeau, J. and Cynober, L. (1997) Amino acid determination in biological fluids by automated ion-exchange chromatography: performance of Hitachi L-8500A. *Clinical Chemistry* 43, 1421–1428.
- Lee, M.L., Chi H.J. and Hsu, A. (1996) Determination of tryptophan in feed ingredients by colorimetric method and by high performance liquid chromatography. *Journal of Taiwan Livestock Research* 29, 257–262.
- Li, W., Xu, Z. and Sun, J. (1998) Determination of contents of amino acids in feeds by precolumn derivatization with *o*-phthalaldehyde. *Zhejiang Nongye Daxue Xuebao* 24, 163–166.
- Liu, H.J. (1994) Determination of amino acids by precolumn derivatization with 6-aminoquinolyl-*N*-hydroxysuccinimidyl carbamate and high-performance liquid chromatography with ultraviolet detection. *Journal of Chromatography A* 670, 59–66.
- Liu, H.J., Chang, B.Y., Yan, H.W., Yu, F.H. and Liu, X.X. (1995) Determination of amino acids in food and feed by derivatization with 6-aminoquinolyl-*N*-hydroxysuccinimidyl carbamate and reversed-phase liquid chromatographic separation. *Journal of AOAC International* 78, 736–744.
- Llames, C.R. and Fontaine, J. (1994) Determination of amino acids in feeds: collaborative study. *Journal of AOAC International* 77, 1362–1402.
- Mao, L.-C., Lee, K.-H. and Erbersdobler, H.F. (1993) Effects of heat treatment of lysine in soya protein. *Journal of Agricultural and Food Chemistry* 62, 307–309.
- Marconi, E., Panfilì, G., Messia, M.C., Cubadda, R., Compagnone, D. and Palleschi, G. (1996) Fast analysis of lysine in food using protein microwave hydrolysis and electrochemical biosensor. *Analytical Letters* 29, 1125–1137.
- Marko-Varga, G., Gorton, L., Dominguez, E. and Barcelo, D. (1993) Enzyme based detection systems in column liquid chromatography – extension of selectivity and sensitivity. *Chromatographia* 36, 381–398.
- Martens, D.A. and Frankenberger, W.T. (1992) Pulsed amperometric detection of amino acids separated by anion exchange chromatography. *Journal of Liquid Chromatography* 15, 423–439.
- Mason, V.C., Rudemo, M. and Bech-Andersen, S. (1980a) Hydrolysate preparation for amino acid determinations in feed constituents: 6. The influence of phenol and formic acid on the recovery of amino acids from oxidized feed proteins. *Zeitschrift für Tierphysiologie, Tierernährung und Futtermittelkunde* 43, 35–48.
- Mason, V.C., Rudemo, M. and Bech-Andersen, S. (1980b) Hydrolysate preparation for amino acid determinations in feed constituents: 8. Studies of oxidation conditions for streamlined procedures. *Zeitschrift für Tierphysiologie, Tierernährung und Futtermittelkunde* 43, 146–164.
- Mauron, J. and Bujard, E. (1964) Guanidination, an alternative approach to the determination of available lysine in foods. In: Fassmore M.E. (ed.) *Proceedings of the 6th International Nutrition Congress*. Churchill Livingstone, Edinburgh, pp. 489–490.
- May, M. and Brown, L. (1989) Instability of orthophthalaldehyde reagent for amino acid analysis. *Analytical Biochemistry* 181, 135–139.
- McCarthy, K., Hischenhuber, C. and Joyce, N. (2001) Determination of total taurine in pet foods by liquid chromatography of the dansyl derivative, collaborative study. *Journal of AOAC International* 83, 784–788.
- Medina-Hernandez, M.J. and Alvarez-Coque, G. (1992) Available lysine in protein, assay using *o*-phthalaldehyde/*N*-acetyl-L-cysteine spectrometric method. *Journal of Food Science* 52, 503–505.
- Messing, J. and Sturman, J. (1993) Evaluation of taurine status in cats consuming diets containing different amounts of taurine by determination of plasma and whole blood taurine concentrations. *Journal of Nutritional Biochemistry* 4, 168–171.
- Miao, H., Yang, T., Huo, J., Liu, Q. and Lu, C. (2000) Determination of amino acids in food samples by

- high performance liquid chromatography with precolumn derivatization. *Fenxi Huaxue* 28, 1091–1095.
- Michaelsen, S., Møller, P. and Sørensen, H. (1994) Analysis of dansyl amino acids in feedstuffs and skin by micellar electrokinetic capillary chromatography. *Journal of Chromatography A* 680, 299–310.
- Michalski, C.M. and Mroczek, W.B. (1992) Protein, NDF, ADF, lysine and sulphur amino acids determination on rapeseed – NIR and NIT comparison. In: Hildrum, K.I. (ed.) *Near Infra-Red Spectroscopy*. Horwood, Chichester, UK, pp. 259–262.
- Moeller, S.E. (1993) Quantification of physiological amino-acids by gradient ion-exchange high-performance liquid chromatography. *Journal of Chromatography B* 124, 223–230.
- Molnar-Perl, I. (1994) Advances in the high-performance liquid-chromatographic determination of phenylthiocarbamoyl-amino-acids. *Journal of Chromatography A* 66, 43–50.
- Molnar-Perl, I. (1997) Tryptophan analysis in peptides and proteins, mainly by liquid chromatography. *Journal of Chromatography A* 763, 1–10.
- Molnar-Perl, I. (2000) Role of chromatography in the analysis of sugars, carboxylic acids and amino acids in food. *Journal of Chromatography A* 891, 1–32.
- Molnar-Perl, I. (2001) Derivatization and chromatographic behaviour of the *o*-phthaldialdehyde amino-acid derivatives obtained with various SH-group-containing additives. *Journal of Chromatography A* 913, 283–302.
- Molnar-Perl, I. and Bozor, I. (1998) Comparison of the stability and UV and fluorescence characteristics of the *o*-phthaldialdehyde / 3-mercaptopropionic acid and *o*-phthaldialdehyde / *N*-acetyl-L-cysteine reagents and those of their amino acid derivatives. *Journal of Chromatography A* 798, 37–46.
- Molnar-Perl, I. and Khalifa, M. (1994) Analysis of foodstuff amino-acids using vapour-phase hydrolysis. *LC-GC International* 7, 395–398.
- Molnar-Perl, I. and Vasantis, A. (1999) Stability and characteristics of the *o*-phthaldialdehyde / 3-mercaptopropionic and *o*-phthaldialdehyde / *N*-acetyl-L-cysteine reagents and their amino acid derivatives measured by high-performance liquid chromatography. *Journal of Chromatography A* 835, 73–91.
- Morales, F.-J., Romero, C. and Jimenez-Perez, S. (1996) Evaluation of heat-induced changes in Spanish commercial milk: hydroxymethylfurfural and available lysine content. *International Journal of Food Science and Technology* 31, 411–418.
- Morr, C.V. and Ha, E.Y.W. (1995) Protein and nonprotein nitrogen components of foods. In: Jeon, I.J. and Ikins, W.G. (eds) *Analyzing Food for Nutrition Labeling and Hazardous Contaminants*. Marcel Dekker, New York, pp.137–167.
- Moughan, P.J. and Rutherford, S.M. (1996) A new method for determining digestible reactive lysine in foods. *Journal of Agricultural and Food Chemistry* 44, 2002–2209.
- Muranszky, G. (1996) Determination of the amino acid composition of feeds by gas chromatography-mass spectrometry (GS-MS). *Élelmiszervizsgálati közlemények* 42, 120–126.
- Ndibualonji, B.B., Dehareng, D., Debue, P. and Godeau, J. (1992) Determination of free amino acids in plasma by HPLC and study of the effects of food deprivation on free amino acid values in blood of a dry Friesian cow. *Annales de Médecine Veterinaire* 136, 413–422.
- Nicolas, E.C., Pfender, K.A., Aoun, M.A. and Hemmer, J.E. (1990) Determination of taurin in infant formulas using ultrafiltration and cation-exchange chromatography. *Journal of the Association of Official Analytical Chemists* 73, 627–631.
- Nielsen, H.K. and Hurrell, R.F. (1985) Tryptophan determination of food proteins by h.p.l.c. after alkaline hydrolysis. *Journal of the Science of Food and Agriculture* 36, 893–907.
- NRC (1998) Composition of feed ingredients. In: *Nutrient Requirements of Swine*, 10th edn. National Research Council, National Academic Press, Washington, DC, pp. 132–139.
- NRC (2001) Nutrient composition of feeds. In: *Nutrient Requirements of Dairy Cattle*, 7th edn. National Research Council, National Academic Press, Washington, DC, pp. 290–303.
- Oguri, S., Yokoi, K. and Motohase, Y. (1997) Determination of amino acids by high-performance capillary electrophoresis with on-line mode in-capillary derivatization. *Journal of Chromatography A* 787, 253–260.
- Oh, C.-H., Kim, J.-H., Kim, K.-R. and Mabry, T.J. (1995) Rapid gas chromatographic screening of edible seeds, nuts and beans for non-protein and protein amino acids. *Journal of Chromatography A* 708, 131–141.
- Or-Rashid, M.M., Onodera, R., Wadud, S., Nasser, M.-E.A. and Amin, M.R. (1999) Rapid determination of lysine in biological samples by isocratic liquid chromatography. *Journal of AOAC International* 82, 809–814.

- Or-Rashid, M.M., Onodera, R., Wadud, S. and Mohammed, N. (2000) Convenient method of threonine, methionine and their related amino compounds by high-performance liquid chromatography and its application to rumen fluid. *Journal of Chromatography B* 741, 279–287.
- Ou, K., Wilkins, M.R., Yan, J.X., Gooley, A.A., Fung, Y., Sheumack, D. and Williams, K.L. (1996) Improved high-performance liquid chromatography of amino-acids derivatized with 9-fluorenylmethyl chloroformate. *Journal of Chromatography A* 723, 219–225.
- Pazdernik, D.L., Killam, A.S. and Orf, J.H. (1997) Analysis of amino and fatty acid composition in soybean seed, using NIR-spectroscopy. *Agronomy Journal* 89, 679–685.
- Pei, J.H. and Li, X.Y. (2000) Determination of underivatized amino-acids by high-performance liquid chromatography and electrochemical detection at an amino acid oxidase immobilized copper (II) hexachloroplatinate (IV) (CuPtC16)-modified electrode. *Fresenius Journal of Analytical Chemistry* 367, 707–713.
- Peter, A., Tourwe, D., Baumann, M.E.M., Elskens, M. and Goeyens, L. (1999) High-performance liquid-chromatography determination of free amino-acids in algae. *Journal of Liquid Chromatography and Related Technologies* 22, 1077–1093.
- Petritis, K., Elfakir, C. and Dreux, M. (2001) HPLC-CLND for the analysis of underivatized amino-acids. *LC-GC Europe* 14, 389–395.
- Pinter-Szakacs, M. and Molnar-Perl, I. (1990) Determination of tryptophan in unhydrolyzed food and feed-stuffs by the acid ninhydrin method. *Journal of Agricultural and Food Chemistry* 38, 720–726.
- Pohlmann, A., Stamm, W.W., Kusakabe, H. and Kula, M.-R. (1990) Enzymatic determination of L-lysine by flow-injection techniques. *Analytica Chimica Acta* 235, 329–335.
- Poole, D. (1991) Feed mixing problems and their effect on feed performance. In: *Degussa Technical Symposium, Indianapolis*. Degussa Corporation, Atlanta, Georgia.
- Porter, D.W., Banks, M.A., Castranova, V. and Martin, W.G. (1988) Reversed-phase high-performance liquid chromatography technique for taurine quantitation. *Journal of Chromatography* 454, 311–316.
- Pripis-Nicolau, L., de Revel, G., Marchand, S., Belouqui, A. and Bertrand, A. (2001) Automated HPLC method for the measurement of free amino-acids including cysteine in musts and wines; first applications. *Journal of the Science of Food and Agriculture* 81, 731–738.
- Puchala, R., Pior, H., von Keyeserlingk, M., Shelford, J.A. and Barej, W. (1994) Determination of methionine sulfoxide in biological materials using HPLC and its degradability in the rumen of cattle. *Animal Feed Science and Technology* 48, 121–130.
- Ranfft, K. and Faure, U. (1993) An intercomparison of methods for the determination of tryptophan in Feedstuffs. *Agribiological Research* 46, 65–72.
- Ravindran, V., Imbeah, M., Angkanaporn, K. and Bryden, W.L. (1996) Guanidination of lysine in cottonseed protein. *Journal of Agricultural and Food Chemistry* 44, 1812–1815.
- Reverter, M., Lundh, T. and Lindberg, J.E. (1997) Determination of free amino acids in pig plasma by pre-column derivatization with 6-N-aminoquinolyl-N-hydroxysuccinimidyl carbamate and high-performance liquid chromatography. *Journal of Chromatography A* 696, 1–8.
- Rogers S.R. and Pesti G.M. (1990) Determination of tryptophan from feedstuffs using reverse phase high-performance liquid chromatography. *Journal of Micronutrient Analysis* 7, 27–35.
- Rowan, A.M., Moughan, P.J. and Wilson, M.N. (1992) Effect of hydrolysis time on the determination of the amino acid composition of diet, ileal digesta, and feces samples and on the determination of dietary amino acid digestibility coefficients. *Journal of Agricultural and Food Chemistry* 40, 981–985.
- Rubenthaler, G.L. and Bruinsma, B.L. (1978) Lysine estimation in cereals by NIR. *Crop Science* 18, 1039–1042.
- Rutherford, S.M. and Moughan, P.J. (1997) Application of a new method for determining digestible reactive lysine to variably heated protein sources. *Journal of Agricultural and Food Chemistry* 45, 1582–1586.
- Rutherford, S.M. and Moughan, P.J. (2000) Development in the determination of protein and amino acids. In: Moughan, P.J., Verstegen, M.W.A. and Visser-Reyneveld, M.I. (eds) *Feed Evaluation*. Wageningen Peus, Wageningen, The Netherlands, pp. 45–56.
- Rutherford, S.M., Moughan, P.J. and Van Osch, L. (1997) Digestible reactive lysine in processed feedstuffs: application of a new bioassay. *Journal of Agricultural and Food Chemistry* 45, 1189–1194.
- Sakai, T. and Nagasawa, T. (1992) Simple, rapid and sensitive determination of plasma taurine by high performance liquid chromatography using pre-column derivative formation with fluorescamine. *Journal of Chromatography* 567, 155–157.
- Sanz, M.A., Castillo, G. and Hernandez, A. (1996) Isocratic high-performance liquid-chromatographic method for quantitative determination of lysine, histidine and tyrosine in foods. *Journal of Chromatography A* 719, 195–201.

- Saurina, J. and Hernandez-Cassou, S. (1993) Flow-injection spectrophotometric determination of lysine in feed samples. *Analytica Chimica Acta* 281, 593–600.
- Saurina, J. and Hernandez-Cassou, S. (1994) Determination of amino acids by ion-pair liquid chromatography with post-column derivatization, using 1,2-naphthoquinone-4-sulfonate. *Journal of Chromatography A* 676, 311–319.
- Schneider, H.-J. (1989) Amino acid analysis using DABS-CL. *Chromatographia* 28, 45–48.
- Schram, E., Moore, S. and Bigwood, E.J. (1954) Chromatographic determination of cystine as cysteic acid. *Biochemistry* 57, 33–37.
- Schrijver, R. de, Eenaeme, C. van, Fremaut, D., Vermeulen, D., Jacobs, K., Baldwin, P. and Bienfait, J.M. (1991) Hydrolysate preparation and comparative amino-acid determination by cation-exchange and gas-liquid chromatography in diet ingredients. *Cerevisia and Biotechnologie* 16, 26–37.
- Sedgwick, G.W., Fenton, T.W. and Thompson, J.R. (1991) Effect of protein precipitating agents of the recovery of plasma free amino acids. *Canadian Journal of Animal Science* 71, 953–957.
- Shah, S.W., Memon, A.A., Arain, M.A. and Bhangar, M.I. (1996) Spectrophotometric and liquid chromatographic determination of tryptophan in wheat and rice cultivars. *ACGC Chemical Research Communications* 5, 17–23.
- Shang, S.F. and Wang, H. (1996) Sensitive determination of amino acids in kelp by reversed phase high performance liquid chromatography with precolumn derivatization using phenylisothiocyanate. *Chromatographia* 43, 309–312.
- Shang, S.F. and Wang, H. (1997) Study on microwave hydrolysis for the analysis of amino acids in eggs by high performance liquid chromatography. *Sepu* 15, 138–140.
- Shen, J.S. (1994) Can NIRS measure amino acids in feed ingredients? *Feed Management* 45, 1.
- Simat, T.J. and Steinhart, H. (1998) Oxidation of free tryptophan and tryptophan residues in peptides and proteins. *Journal of Agricultural and Food Chemistry* 46, 490–498.
- Simonson, P.G. and Pietrzyk, D.J. (1993) Separation and detection of underivatized amino acids. *Journal of Liquid Chromatography* 16, 597–618.
- Slump, P. and Bos, K.D. (1985) Determination of methionine in feed concentrates. *Poultry Science* 64, 705–707.
- Slump, P., Flissebaalje, T.D. and Haaksman, I.K. (1991) Tryptophan in food proteins: a comparison of two hydrolytic procedures. *Journal of the Science of Food and Agriculture* 55, 493–496.
- Smith, J.T. (1997) Developments in amino acid analysis using capillary electrophoresis. *Electrophoresis* 18, 2377–2392.
- Soga, T. and Ross, G.A. (1999) Simultaneous determination of inorganic anions, organic acids, amino acids and carbohydrates by capillary electrophoresis. *Journal of Chromatography A* 837, 231–239.
- Spackman, D., Stein, W. and Moore, S. (1958) Automatic recording apparatus for use in the chromatography of amino acids. *Analytical Chemistry* 30, 1190–1206.
- Spindler, M., Sandler, R. and Tanner, H. (1984) Amino acid analysis of feedstuffs: determination of methionine and cystine after oxidation with performic acid and hydrolysis. *Journal of Agricultural and Food Chemistry* 32, 1366–1371.
- Sultana, H., Onodera, R., Or-Rashid, M.M. and Wadud, S. (2001) Convenient method for the determination of arginine and its related compounds in rumen fluid by reversed-phase high-performance liquid chromatography. *Journal of Chromatography B* 755, 321–329.
- Suzuki, E.Y. and Early, R.J. (1993) High-performance liquid chromatographic separation of phenylthiocarbonyl derivatives of amino-acids from protein hydrolysates using a Partisphere C18 column. *Journal of Chromatography A* 657, 204–207.
- Tcherkas, Y.V., Kartsova, L.A. and Krasnova, I.N. (2001) Analysis of amino-acids in human serum by isocratic reversed-phase high-performance liquid chromatography with electrochemical detection. *Journal of Chromatography A* 913, 303–308.
- Toran, A.A., Barbera, R., Farre, R., Lagarde, M.J. and Lopez, J.C. (1996) HPLC method for cyst(e)ine and methionine in infant formulas. *Journal of Food Science* 61, 1132–1135.
- Tuan, Y.-H. and Dixcon Phillips, R. (1997) Optimized determination of cystine/cysteine and acid-stable amino acids from a single hydrolysate of casein- and sorghum-based diet and digesta samples. *Journal of Agricultural and Food Chemistry* 45, 3535–3540.
- Van de Merbel, N.C., Zuur, P., Frijlink, M., Holthuis, J.J.M., Lingeman H. and Brinkman, U.A.T. (1995) Automated monitoring of amino acids during fermentation processes using on-line ultrafiltration and column liquid chromatography: application to fermentation medium improvement – amino acid analysis

- applied to a recombinant *Escherichia coli* growing on a culture medium with a complex N-source. *Analytica Chimica Acta* 303, 175–185.
- Van Eijk, H.M.H., Rooyackers, D.R. and Deutz, N.E.P. (1993) Rapid routine determination of amino-acids in plasma by high-performance liquid chromatography with a 2–3  $\mu\text{m}$  Spherisorb ODS II column. *Journal of Chromatography* 131, 143–148.
- Van Kempen, T. and Jackson, D. (1996) NIRS may provide rapid evaluation of amino acids. *Feedstuffs*, 2 Dec. pp.12–15.
- Van Kempen, T. and Simmins, P.H. (1997) NIRS in precision feed formulation. *Journal of Applied Poultry Research* 6, 471–477.
- Van Kempen, T. and Bodin, J.-C. (1998) NIRS appears to be superior to nitrogen-based regression as a rapid tool in predicting the poultry digestible amino acid content of commonly used feedstuffs. *Animal Feed Science and Technology* 76, 139–147.
- Van Wendelen, C. and Cohen, S.A. (1997) Using quaternary high-performance liquid chromatography eluent systems for separating 6-aminoquinolyl-N-hydroxysuccinimidyl carbamate-derivatized amino acid mixtures. *Journal of Chromatography A* 763, 11–22.
- Vasantis, A. and Molnar-Perl, I. (1999) Temperature, eluent flow-rate and column effects on the retention and quantitation properties of phenylthiocarbamyl derivatives of amino acids in reversed-phase high-performance liquid chromatography. *Journal of Chromatography A* 832, 109–122.
- Vazquez-Ortiz, F.A., Caire, G., Higuera-Ciajara, I. and Hernandez, G. (1995) High performance liquid-chromatographic determination of free amino-acids in shrimp. *Journal of Liquid Chromatography* 18, 2059–2068.
- VDLUFA (1997) Bestimmung von Methionin in Futtermitteln mit hohem Chloridgehalt. Methode 4.11.5 In: *Methodenbuch Band III. Die chemische Untersuchung von Futtermitteln*, 4. Ergänzung. VDLUFA-Verlag, Darmstadt, Germany.
- Vecchione, G., Margaglione, M., Grandone, E., Colaizzo, D., Cappucci, G., Fermo, I., D'Angelo, A. and Di Minno, G. (1999) Determining sulphur-containing amino-acids by capillary electrophoresis: a fast novel method for total homocyst(e)ine in human plasma. *Electrophoresis* 20, 569–574.
- Vigo, M.S., Malec, L.S., Gomez, R.G. and Llosa, R.A. (1992) Spectrophotometric assay using *o*-phthalaldehyde for determination of reactive lysine in dairy products. *Food Chemistry* 44, 363–365.
- Vrbova, E., Marek, M. and Ralys, E. (1992) Biosensor for the determination of L-lysine. *Analytica Chimica Acta* 270, 131–136.
- Walker, V. and Mills, G.A. (1995) Quantitative methods for amino acid analysis in biological fluids. *Annals of Clinical Biochemistry* 32, 28–57.
- Weiss, M., Manneberg, M., Juranville, J.-F., Lahm, H.-W. and Fountoulakis, M. (1998) Effect of the hydrolysis method on the determination of the amino acid composition of proteins. *Journal of Chromatography A* 795, 263–275.
- Werner, G. (1986) Eine HPLC-Methode zur Bestimmung von Tryptophan in Futtermitteln und Getreide. *Landwirtschaftliche Forschung* 39, 109–117.
- Williams, P.C., Preston, K.R., Norris, K.H. and Starkey, P.M. (1984) Determination of amino acids in wheat and barley by NIRS. *Journal of Food Science* 49, 17–20.
- Williams, P.C., Mackenzie, S.L. and Starkey, P.M. (1985) Determination of methionine in peas by NIRS. *Journal of Agricultural and Food Chemistry* 33, 811–815.
- Workman, J. (1991) NIRS measurement of amino acids in feed ingredients. In: *Procedures of the Georgia Nutrition Conference for the Feed Industry*. University of Georgia, Atlanta, pp. 37–47.
- Zhao, Y., Cu, X. and Guo, H. (1992) Determination of amino acids in grains and feeds by PICO-TAG method. *Huaxue Tongbao* 4, 39–41.
- Zunin, P. and Evangelisti, F. (1999) Determination of free amino acids in infant formulas. *International Dairy Journal* 9, 653–656.

# 3 Absorption of Amino Acids and Peptides

C.R. Krehbiel<sup>1\*</sup> and J.C. Matthews<sup>2</sup>

<sup>1</sup>Department of Animal Science, Oklahoma State University, Stillwater, Oklahoma, USA; <sup>2</sup>Department of Animal Sciences, University of Kentucky, Lexington, Kentucky, USA

---

## Introduction

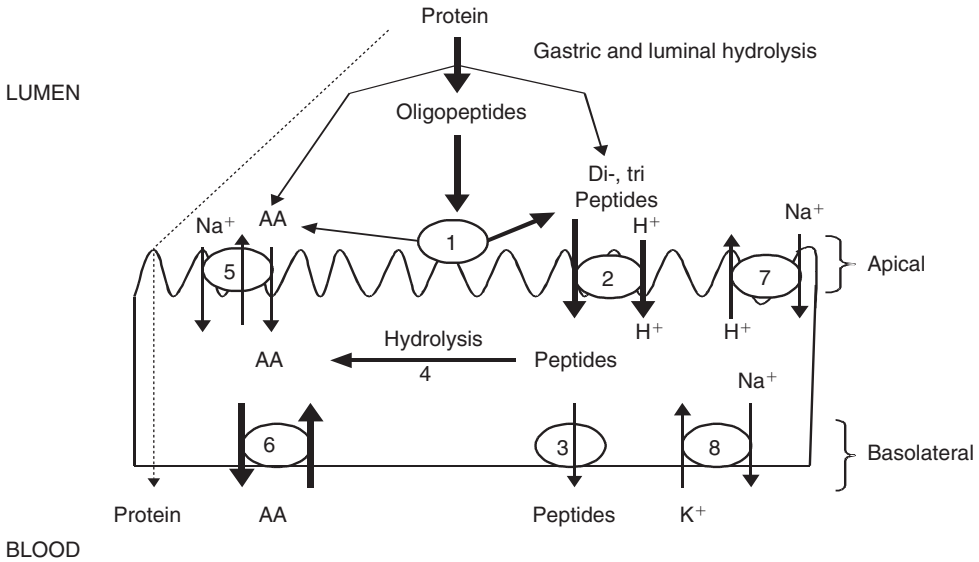
Assimilation of dietary or microbial (ruminants) protein involves the interaction of a series of steps beginning in the stomach (non-ruminants), abomasum (ruminants), or proventriculus (poultry) and ending with the transport of amino acids and peptides from the basolateral membrane of the small intestine. In the glandular stomach, hydrochloric acid (HCl) denatures dietary protein and promotes proteolysis protein to large polypeptides via the action of pepsin. On entering the small intestine, pancreatic proteases principally hydrolyse large polypeptides and proteins into oligopeptides of six or less amino acid residues as well as free amino acids. Degradation of dietary protein continues by hydrolytic enzymes of the small intestine epithelia that are present in the luminal surface (apical membrane or brush border) of absorptive epithelial cells (enterocytes). Brush border peptidases split oligopeptides of six or less amino acids in length. Many of the resulting di- and tripeptides are transported into the enterocyte intact by a single H<sup>+</sup>-coupled transporter and then hydrolysed to free amino acids by cytosolic peptidases (primary) or transported across the basolateral membrane. In contrast, free amino acids are absorbed by a

variety of iron-dependent and -independent transporters. The fate of absorbed peptides is principally further hydrolysis to free amino acids by a variety of cytosolic peptidases, whether absorbed as free or peptide-bound amino acids, cytosolic amino acids are available as energy substrates, incorporation into constitutive protein, or transport across the basolateral membrane into blood. Ultimately, digested protein enters the hepatic portal circulation in the form of free amino acid and peptides.

The working hypothesis for assimilation of luminal proteins by enterocytes is illustrated in Fig. 3.1. The model identifies gastric, luminal, glycocalyx/apical membrane, and intracellular hydrolytic digestion events, in addition to apical and basolateral membrane-mediated absorption events of peptide-bound and free amino acids by specific transport proteins. Each component of the model is discussed in this chapter. Although poorly understood, and in contrast to the specificity of digestion and transport events, it is also important to note that the potential contribution to the absorption of amino acids by relatively non-specific transmembrane simple diffusion and paracellular flow events may be of nutritional significance.

Despite anatomical differences in the digestive tracts among farm animal species,

\*E-mail address: kclinto@okstate.edu



**Fig. 3.1.** The current model for the role of peptide uptake in protein assimilation, as adapted from Ganapathy *et al.* (1994). The relative contribution of peptide (di-, tri-) versus free amino acid (AA) to total protein assimilation through hydrolytic and transport events is indicated by the relative thickness of the lines. After hydrolysis by gastric proteases and luminal peptidases, oligopeptides are hydrolysed to small peptides and free amino acids by apical membrane-bound (1) peptidases. Peptides are absorbed across brush border membrane by PepT1 (2). Whereas a small proportion of absorbed peptides are then absorbed intact across the basolateral membrane by a H<sup>+</sup>-independent transport activity (3), the majority are hydrolysed by intracellular peptidases (4). The resulting free AA, plus those absorbed across the apical membrane by a complement of Na<sup>+</sup>-dependent and -independent amino acid transporters (5) are then transported across the basolateral membrane by a complement of Na<sup>+</sup>-independent and amino acid exchanger transport proteins (6). The extracellular-intracellular H<sup>+</sup> gradient that drives PepT1 activity (2) is re-established by the combined function of the apical Na<sup>+</sup>/H<sup>+</sup> exchanger (7) and the basolateral Na<sup>+</sup>/K<sup>+</sup> ATPase (8), which re-establishes the extracellular-intracellular Na<sup>+</sup> gradients diminished by both Na<sup>+</sup>/H<sup>+</sup> exchanger and Na<sup>+</sup>-coupled free amino acid transport. The contribution to total protein assimilation by free AA uptake from the lumen is represented by a composite transporter model (7), representing AA transport by Na<sup>+</sup>-coupled, AA counterexchange, and/or facilitated transport proteins. The transepithelial passage of intact proteins is also indicated (dashed line). The mechanisms responsible for this relatively minor, but immunologically important process, have been reviewed by Gardner (1994).

enzyme and transporter expression and activity of the associated tissues is fundamentally similar. Although differences do exist, enzymes and transport proteins responsible for digestion and absorption have probably adapted to the nature of the food more than the type of animal (Lassiter and Edwards, 1982). Therefore, processes involved in mammalian protein digestion and peptide and amino acid absorption are generally common to all species. We will attempt to point out differences where known. Our goal in this chapter is to review some of the more recent findings regarding

peptide and amino acid net flux and transport processes. We begin with a brief review of processes involved in protein digestion in the glandular stomach. Pregastric digestion processes of ruminants and birds are topics of the other reviews.

## Digestive Processes

### Gastric digestion

Mammalian and avian protein digestion is initiated in the stomach (non-ruminants), abo-

masum (ruminants) or proventriculus (poultry) in the presence of HCl and pepsin. As discussed by Atasoglu and Wallace in Chapter 15, ruminant animals derive their amino acid supply from a mixture of feed protein that escapes ruminal degradation and microbial protein that is formed as a result of microbial fermentation in the reticulorumen. Microbial protein is readily digested by the host animal and constitutes a well-balanced array of essential amino acids for ruminants in many production systems. Gastric digestion involves the secretion of HCl by gastric parietal cells. Hydrochloric acid is required to initiate the conversion of pepsinogens into pepsins, and also to maintain pepsin activity. Pepsins are secreted as inactive precursors (i.e. pepsinogens) by chief cells in the stomach. In chickens, both gastric acid and pepsinogen are secreted by oxynticopeptic cells of the proventriculus (true stomach). Although HCl production is relatively high, little digestion occurs in the proventriculus as there is little storage capacity, and digesta transit rate is rapid. The synthesis and secretion of inactive precursors, known as zymogens or proenzymes, allow vertebrates to digest exogenous protein without destroying constituent protein in the stomach and pancreas. Once secreted and activated ( $\text{pH} < 5.0$ ), pepsin increases the susceptibility of native proteins to attack by pancreatic proteases by opening the tertiary and quaternary structure of the protein and exposing amino acid residues to the pancreatic endopeptidases (Guan and Green, 1996). For some dietary proteins, gastric predigestion is also important for stimulation of pancreatic exocrine secretion and cholecystokinin (CCK) release in the intestinal phase of digestion in the rat (Guan and Green, 1996) and dog (Meyer and Kelly, 1976). As mentioned, there are a number of pepsinogens secreted and these are converted into the analogous pepsins when the pH is less than 5.0. Once pepsin is present in the lumen of the stomach, the reaction becomes autocatalytic, which involves the splitting off of a peptide chain and peptide fragments. The pepsins are most active at pH less than 4.0 and become inactive at pH greater than 6.0, although the optimum pH for pepsin activity varies from

species to species (Creveieu-Gabriel *et al.*, 1999).

Pepsins are most active at peptide bonds that include phenylalanine, tyrosine, leucine, valine and glutamic acid (Ulshen, 1987). Its most pronounced effect is between leucine and valine, tyrosine and leucine, or between the aromatic amino acids such as phenylalanine-phenylalanine or phenylalanine-tyrosine. The principal function of digestion in the stomach is the transformation of protein into large polypeptides, although peptic digestion in acid pH can produce free or peptide-bound amino acids. As suggested above, both amino acids and peptides are good stimuli for release of hormones that stimulate pancreatic enzyme secretion, e.g. CCK. Ultimately, the object of stomach proteolysis is to make peptide molecules available that are susceptible to further hydrolysis by proteolytic enzymes in the small intestine.

### Digestion in the small intestinal lumen

The products of HCl and pepsin digestion enter the duodenum of the small intestine through the pyloric sphincter. In the duodenum, proteins and polypeptides serve as substrate for enzymes secreted from the pancreas and small intestine. Initially, protein and polypeptides entering the duodenum are broken down further in the intestine by pancreatic exopeptidases trypsin, chymotrypsin, elastase, and pancreatic endopeptidases carboxypeptidase A and B. The pancreas secretes proenzymes into the duodenum, which when activated hydrolyse peptide bonds. The conversion of inactive trypsinogen into active trypsin requires removal of an N-terminal peptide and is catalysed by the brush border enzyme enteropeptidase (formerly known as enterokinase). Enteropeptidase selectively cleaves a hexapeptide ( $\text{H}_2\text{N-Val-Asp-Asp-Asp-Lys}$ ) from the amino terminus of trypsinogen resulting in trypsin (Kitamoto *et al.*, 1994). Enteropeptidase activity may be regulated by pancreatic secretion (Kwong *et al.*, 1978) and thus possibly by dietary protein content. Following its conversion from trypsinogen, trypsin activates the



other zymogens and to a lesser degree trypsinogen.

Trypsin, chymotrypsin, and elastase catalyse the breakdown of proteins, polypeptides, and peptides into smaller peptides and amino acids in the duodenum. Each pancreatic protease has a unique and complementary action. Trypsin catalyses the breakdown of bonds that involve lysine and/or arginine, whereas linkages involving aromatic amino acid residues are susceptible to chymotrypsin catalysis (Alpers, 1994). Elastases are less specific with regard to the type of peptide bonds, but in general catalyse the breakdown of peptide bonds containing aliphatic residues. The action of trypsin, chymotrypsin, and elastase releases numerous terminal peptide bonds, which in turn are further digested by aminopeptidases, carboxypeptidases, and other specific peptidases present in the lumen or mucosa of the small intestine. Pancreatic carboxypeptidase A and B are exopeptidases that catalyse the hydrolysis of the carboxy-terminal bonds in polypeptide chains, removing the amino acids in sequence. Proteolysis of an approximately 100-residue segment from the amino-terminal region results in the activation of procarboxypeptidases (Aviles *et al.*, 1985). Carboxy-terminal aromatic or non-polar amino acids exposed by the action of chymotrypsin and elastase are available to be cleaved by carboxypeptidase A, while carboxy-terminal basic amino acids exposed by trypsin can be cleaved by carboxypeptidase B. Both carboxypeptidase A and B are inhibited by proline. The products of pancreatic digestion are oligopeptides of up to six amino acid residues (approximately 60%) as well as free amino acids (approximately 40%; Alpers, 1994).

### Mucosal phase of digestion

The final stages of non-fermentative protein digestion are carried out by a wide array of brush border and cytosolic peptidases. A review of the brush border and cytosolic peptidases of the small intestine has been conducted by Alpers (1994). The small intestinal peptidases are capable of splitting products of pancreatic digestion (i.e. oligopeptides of six

or less amino acids). These enzymes are present in the enterocyte in two groups that are associated with different cell fractions, the apical membrane and the cytosol (Kim *et al.*, 1972, 1974). The apical-membrane enzymes are attached to the outer surface of the microvillus and extend out from the luminal surface of the enterocyte. In contrast, the cytosolic enzymes are found within the cell and do not make direct contact with the luminal contents. As such, these two groups of enzymes are distinct from one another, differing in location and physicochemical and immunochemical properties (Kim *et al.*, 1972; Nören *et al.*, 1977; Tobey *et al.*, 1985). In addition, the apical enzymes seem to be unique to the small intestine, whereas similar cytosolic peptidases have been found in a number of tissues.

Many di- and tripeptides are absorbed intact and cleaved within the enterocyte by cytosolic peptidases. In mammals, as much as 90% of the total mucosal peptidase activity for dipeptides, 40% of activity for tripeptides, and 10% of the tetrapeptidase activity is associated with the cytosolic fraction (Sterchi and Woodley, 1980); therefore, the capability of cytosolic enzymes to hydrolyse oligopeptides with more than three amino acids appears to be limited. It should be noted, however, that the distribution of peptidase activity between the apical membrane and cytoplasm varies considerably with species and has been dependent on substrates used for the assay (Sterchi and Woodley, 1980). Oligopeptides of four to six amino acids in length are split to shorter peptides and free amino acids by apical microvillus membrane peptidases, whereas many di- and tripeptides are potential substrates for either apical membrane or cytosolic peptidases (Alpers, 1986). Therefore, membrane hydrolysis of peptides with subsequent absorption of amino acids, and transport of peptides followed by intracellular hydrolysis can occur. However, little is known about the importance of control of apical and cytosolic enzyme activity in relation to amino acid and peptide transport, or if location of specific peptidases along the longitudinal axis of the small intestine corresponds to specific amino acid and peptide transport proteins (Ugolev *et al.*, 1990).

## Absorption of End Products of Protein Digestion

Theories about protein digestion and absorption, have evolved in the last 50 years. Initially it was thought that the vast majority of luminal proteins were completely hydrolysed to free amino acids before absorption from digesta (Cohnheim, 1901; Van Slyke and Meyer, 1912; Wiggans and Johnston, 1959). However, this classic hypothesis was challenged by an early report that at least dogs were capable of absorbing appreciable amounts of glycylglycine across the intestinal wall (Newey and Smyth, 1959), and subsequent reports that measured higher rates of absorption for amino acids when presented in the form of peptides than as free amino acids (Adibi and Morse, 1971; Matthews, 1983). From these and other studies (Matthews, 1991), it was understood that the absorption of protein in the form of small peptides was of tremendous nutritional importance. More specifically, most nutritional physiologists now accept the concept that about 70–85% of all luminal amino acids are absorbed from the digesta into enterocytes in the form of small peptides from the digesta, with the balance being absorbed as unbound (free) amino acids. After absorption into enterocytes, however, it is thought that about 85% of all absorbed amino acids appear in hepatic portal blood as free amino acids, as a result of intracellular hydrolysis (Matthews, 1991; Ganapathy *et al.*, 1994).

## Net Portal-drained Visceral Flux of Peptides

Measurements of peptide and amino acid (and other nutrients) absorption and metabolism by tissues of the portal-drained viscera (PDV; gastrointestinal tract, pancreas, spleen and omental fat) can be obtained using chronic indwelling catheters in animals which allows for simultaneous sampling of arterial and venous blood draining the PDV, or sections of the PDV, and measuring blood flow through the same tissues (Reynolds, 2001). Net rates of peptide or amino acid release or removal by the PDV (or tissue of

interest) can then be calculated as blood flow multiplied by venous–arterial concentration difference (Huntington *et al.*, 1989). Net portal appearance of peptide-bound or free amino acids is defined as the total amount of amino acids reaching portal blood minus the daily amounts entering the PDV via arterial blood. Peptides and amino acids liberated at the apical membrane or in the cytoplasm can be incorporated into proteins in the enterocyte, metabolized within the epithelium of the small intestine, or transported across the basolateral membrane, ultimately reaching the hepatic portal circulation. In addition, peptides and amino acids are mixed in the lumen and/or enterocyte with amino acids and peptides of endogenous origin during the digestion and absorption process. For these reasons the amino acids present in the hepatic portal vein do not completely reflect the amino acid pattern of the diet (Reynolds, 2001).

As discussed, it is now accepted that peptide absorption is an important physiological process in farm and other animals, and constitutes the primary source of absorbed amino acids. Peptide absorption across the PDV of ruminants has been reported by several researchers (McCormick and Webb, 1982; Seal and Parker, 1991; Koeln *et al.*, 1993; Han *et al.*, 2001), and has been shown to account for 63–92% of total amino acid flux by sheep and cattle. With net flux procedures, the origin of the peptides cannot be determined, but may be from absorption from the lumen, synthesis by tissues of the PDV, breakdown of endogenous protein by intracellular peptidases, or a combination of factors. At any rate, net flux of free amino acids appears to be low compared with peptide-bound amino acids in ruminants (Koeln *et al.*, 1993; Webb *et al.*, 1993; Han *et al.*, 2001). Based on evidence that chemical deproteinization overestimates the peptide amino acid concentration in plasma (Bernard and Rémond, 1996; Backwell *et al.*, 1997), it has been suggested that the high flux of peptides might be due to the procedure of sample deproteinization (Neutze *et al.*, 1996; Backwell *et al.*, 1997). Methods for measuring peptides have generally relied on the difference method, where amino acid analysis of deproteinized

samples before and after acid hydrolysis has occurred, with the difference being attributed to peptides. A modification of this procedure has included gel filtration after acid deproteinization of samples to ensure removal of residual protein before acid hydrolysis (Seal and Parker, 1996; Backwell *et al.*, 1997). However, Seal and Parker (1996) reported that, even after the treatment with both chemical deproteinization and physical filtration, peptide-bound amino acid flux still accounted for 63% of the net PDV appearance of total amino acids. The large appearance (438 g day<sup>-1</sup>) of peptide-bound and free amino acids when calves were deprived of feed for 72 h (Koeln *et al.*, 1993) suggests that a large portion of small peptides might be the degradation products resulting from tissue protein in the gastrointestinal tract (GIT), spleen, pancreas or a combination of these organs, but also supports an increase in PepT1 mRNA and protein expression observed during dietary deprivation in rats (Thamotharan *et al.*, 1999a).

Interestingly, work of Webb *et al.* (1993) indicated that 86–90% of peptide-bound amino acids in the PDV of sheep and calves comes from the stomach tissues (rumen, reticulum, omasum, cranial abomasum, spleen and pancreas). Similar data from Seal and Parker (1996) suggested that 40% of portal peptide-bound amino acids were from the mesenteric-drained viscera (MDV; small intestine, caecum, colon, mesenteric fat and pancreas) suggesting that the remaining 60% were from the stomach tissues. Therefore, tissues of the stomach appear to account for the majority of peptide-bound amino acid release. Similarly, Han *et al.* (2001) found in yaks that 78% of the absorbed peptide-bound amino acids were from the stomach, whereas net flux of peptide-bound amino acids across the MDV accounted for 22% of the total peptide amino acids. In ruminants, the ability of the forestomach to absorb small peptides has been demonstrated *in vitro* (Matthews and Webb, 1995) and *in vivo* (Bernard and Rémond, 1999; see below). The lower absorption (10–40%) of peptide amino acids across tissues of the MDV supports the apparent high intracellular peptide hydrolysis observed in the cytoplasm of the small intes-

nal enterocyte (Matthews, 1991; Ganapathy *et al.*, 1994).

Han *et al.* (2001) found that the dominant amino acids appearing in the hepatic portal vein in the form of peptide were glutamate, aspartate, leucine, glycine, lysine, proline and serine. These peptide-bound amino acids accounted for 60% of the total peptide-bound amino acids appearing in hepatic portal blood. Han (1998) found similar results in Holstein steers and growing yaks, and similar results have been reported in calves (McCormick and Webb, 1982; Koeln *et al.*, 1993). Wallace *et al.* (1993) reported degradation-resistant peptides in rumen fluid of sheep 6 h after feeding. Interestingly, these peptides contained a significant proportion of aspartate, glycine and proline. In addition, several studies (Gardner and Wood, 1989; Daniel *et al.*, 1992; Pan *et al.*, 1996) have suggested that hydrophobic peptides and peptides resistant to mucosal hydrolysis are absorbed faster than hydrophilic and hydrolysis-susceptible peptides. As suggested by Han *et al.* (2001), resistance to mucosal hydrolysis might explain the larger fluxes of some peptide-bound amino acids. Also, the higher net absorption of glutamate, leucine, lysine, and serine in the form of peptides may imply that these amino acids exist more often in the form of peptides that are relatively hydrophobic and resistant to hydrolysis either by microbial peptidases in the rumen, or by apical-membrane and/or cytosolic peptidases of enterocytes.

### Net Portal-drained Visceral Flux of Amino Acids

Early research in dogs (Elwyn *et al.*, 1968) showed an increase in free amino acids appearing in hepatic portal blood during protein digestion following a meal. During the absorptive period, amino acids appearing in portal blood were similar in composition to those ingested with the meal, except that glutamic and aspartic acids, which were removed by the PDV, and lysine and histidine appeared in greater amounts. Interestingly, net portal absorption of total amino acids was greater than the amount ingested, sug-

gesting complete hydrolysis of protein in the gut, and/or a contribution of amino acids from endogenous protein. In contrast, early comparisons of net PDV release of amino acids with amounts disappearing from the small intestine of ruminants showed that the amount of amino acids disappearing across the small intestine was 1.5–2 times greater than the amount appearing in hepatic portal plasma (Tagari and Bergman, 1978). These authors suggested that the gastrointestinal tract tissues selectively and preferentially used essential amino acids during absorption resulting in an imbalance in the profile of essential amino acids delivered to the liver.

More recent attempts in both sheep (MacRae *et al.*, 1997b) and cattle (Berthiaume *et al.*, 2001) have measured net flux of amino acids from the small intestine by placing a catheter at a point where the venous drainage from the small intestine first enters the mesenteric arcade, prior to the junction with the ileocaecal vein (Seal and Reynolds, 1993; MacRae *et al.*, 1997b). This approach has allowed researchers to measure net flux of amino acids across the small intestine, either from duodenum to ileum or from proximal jejunum to ileum (MacRae *et al.*, 1997b). Interestingly, in both sheep (MacRae *et al.*, 1997b) and cattle (Berthiaume *et al.*, 2001), net flux of essential amino acids across the PDV, when compared with the rates of disappearance of essential amino acids from the small intestine, confirmed the apparent loss of essential amino acids between the lumen of the small intestine and the hepatic portal vein. However, mean MDV net flux of essential amino acids averaged 106 and 103% of the small intestinal disappearance of essential amino acids in sheep and cattle, respectively. Berthiaume *et al.* (2001) reported that recovery of essential amino acids across the MDV of cattle was 102.8, 126.7, 102.2, 92.1, 76.5, 101.1, 100.0, 114.7 and 110.9% of intestinal disappearance for arginine, histidine, isoleucine, leucine, lysine, methionine, phenylalanine, threonine and valine, respectively. This indicates that across the MDV, a net balance of essential amino acids occurs such that inputs of essential amino acids for protein synthesis from both luminal and arterial sources are equivalent to outputs in mesen-

teric venous drainage from luminal amino acid transport and/or endogenous protein degradation (Reynolds, 2001). Interestingly, the ratio of PDV:MDV averaged 61% (range = 55–69%) in sheep and 62% (range = 38–76%) in cattle, indicating a substantial use of arterial amino acids by the stomach (reticulorumen, omasum, abomasum) and other tissues of the PDV (see Bequette, Chapter 5). MacRae *et al.* (1997b) hypothesized that low recovery of essential amino acids in PDV compared with MDV suggests that other tissues of the GIT not drained by the MDV (i.e. stomach and hindgut) do not exhibit a net balance between arterial sequestration and venous drainage from transport and/or protein turnover. In a study with the same sheep (MacRae *et al.*, 1997a), sequestration of arterial essential amino acids across the entire PDV accounted for 35–50% of the whole-body flux of essential amino acids. Therefore, the authors suggested the stomach and hindgut might sequester essential amino acids for tissue proteins from arterial sources at a greater rate than their degradation products are released into venous drainage as free amino acids. Alternatively, a greater portion of the products of stomach and hindgut protein degradation could be released as peptides as previously discussed.

The stomach (reticulorumen, omasum, abomasum) of the ruminant has the ability to absorb free amino acids. Calculations from Webb *et al.* (1993) indicated that 22 and 11% of total free amino acids appearing in portal blood of calves and sheep, respectively, were from stomach viscera. The potential for amino acid absorption across epithelial tissues of rumen and omasum have also been shown *in vitro* with radiolabelled and non-radiolabelled methionine (Matthews and Webb, 1995). Similarly, Rémond *et al.* (2000) demonstrated that free amino acids (glycine, serine, valine, methionine and lysine) can be absorbed across ruminal epithelium. However, the authors noted that absorption was low considering the small changes in net flux across the rumen wall relative to the large increases in ruminal concentrations.

In non-ruminants, experiments using radioisotopes have shown that digestion of most proteins in the small intestine is virtually

100% complete (Gaudichon *et al.*, 1996; Lien *et al.*, 1997). However, other studies suggest that less than 100% of ingested amino acids appear in hepatic portal blood following a meal (Rerat *et al.*, 1992; Stoll *et al.*, 1998; Wu, 1998; van Goudoever *et al.*, 2000). Results of portal recovery of essential amino acids ingested are similar to ruminants (56%); as a percentage of amino acid intake, 38, 57, 54, 60, 61, 48 and 69% of threonine, leucine, lysine, phenylalanine, valine, methionine and isoleucine were recovered in portal blood of young pigs (Stoll *et al.*, 1998). Similar results were reported by Rerat *et al.* (1992). Therefore, similar to the ruminant, there appears to be substantial utilization of dietary amino acids by tissues of the PDV during the absorptive process in the non-ruminant (Stoll *et al.*, 1998; Wu, 1998; van Goudoever *et al.*, 2000; and Bequette, Chapter 5). To our knowledge, rates of absorption across the MDV (i.e. small intestine) compared with the PDV have not been measured in pigs.

In dairy cattle (Berthiaume *et al.*, 2001), disappearance of total amino acids in the small intestine was 65.2%, which is in close agreement with values (57–76%) summarized by Reynolds *et al.* (1994) for ruminants in general. Essential amino acids disappearing in the small intestine were numerically higher than for non-essential amino acids (66.5 vs. 63.9%). Mesenteric-drained visceral flux accounted for 131% of intestinal disappearance of non-essential amino acids, and PDV flux represented 50% of MDV flux. In the case of non-essential amino acids, mean disappearance in the small intestine of aspartic acid, glutamic acid, cystine, proline and glycine was considerably higher than their respective MDV fluxes, while 116% of Ala and 123% of Ser that disappeared from the small intestine was recovered in the MDV. With the exception of serine, similar results were reported in piglets as a percentage of amino acid ingested (Stoll *et al.*, 1998). Reynolds (2001) suggested that the net loss of glutamate–glutamine and aspartate–asparagine pairs and other non-essential amino acids provide nitrogen for the synthesis of alanine using pyruvate arising from glycolysis (in part). In ruminants (Reynolds *et al.*, 1994; Reynolds, 2001) and non-ruminants

(Rerat *et al.*, 1992; Prior and Gross, 1995), alanine is typically the amino acid released across the PDV in the largest amount of a net basis, transferring nitrogen and carbon to the liver for urea and glucose synthesis (Jungas *et al.*, 1992). The large release of alanine into the portal vein also reflects glutamate transamination and glutamine catabolism by the PDV, providing energy for gastrointestinal metabolism (Britton and Krehbiel, 1993; Reynolds *et al.*, 1994).

### Peptide-bound and Free Amino Acid Transport Activities and Proteins

Paralleling tissue flux studies, which have described the relative flux and absorption potential of peptides and amino acids, has been research conducted to characterize specific biochemical activities (ion coupling, relative substrate affinities) and the molecular identity of specific gene products (proteins) capable of absorbing peptide-bound and free amino acids (transporters). The biochemical characterization of mammalian peptide-bound (peptide) or free (amino acid) amino acid transport systems has revealed the presence of at least two H<sup>+</sup>-dependent and one H<sup>+</sup>-independent peptide transport activities, one H<sup>+</sup>-dependent amino acid transporter, and at least eight free amino acid systems in intestinal tissue (Fig. 3.2). The recent cloning and biochemical characterization of the cloned proteins responsible for these specific activities has revealed that, typically, several different proteins are capable of a biochemical 'system' activity, and that several Na<sup>+</sup>-independent activities result from the function of two separate proteins. Although the data are limited compared with that for humans and laboratory animals, the intestinal epithelia of pigs, cattle and sheep appear to express a similar complement of transport activities and specific transport proteins as observed for other species. For all species, however, relatively little is known regarding how expression and function of individual transporters are coordinated with that of other transporters to account for the quantity and relative ratio of amino acids that are absorbed across the intestinal epithelium. Ultimately, to design

truly 'efficient' diets to support a desired level of animal production, knowledge regarding the intestinal luminal amino acid load must be matched with digestive and absorptive capacities for peptide-bound and free amino acids. The goal of this section is to identify and/or describe current information about peptide-bound and free amino acid transport.

## Transport of Peptide-bound Amino Acids

### Biochemical characterization of H<sup>+</sup>-coupled peptide transport by enterocytes

As identified above, more moles of amino acids are absorbed as small di- and tripeptides (peptides) than as free amino acids. The importance of this process, along with the subsequent understanding that most  $\beta$ -lactam antibiotics appeared to compete for absorption with peptides, generated a tremendous amount of interest in identifying the process by which peptides were absorbed. Research using either hydrolysis-resistant peptides or poorly metabolized  $\beta$ -lactam antibiotics in whole-tissue, cell line and membrane vesicle experimental models demonstrated that many species are capable of mediated absorption of intact di- or tripeptides. An important understanding from early studies was that peptide transport activity is unique from free amino acid transport. Additionally,

the transport of dipeptides is dependent on an extracellular–intracellular H<sup>+</sup> gradient and not a Na<sup>+</sup> gradient (Ganapathy *et al.*, 1984). Subsequent research showed that the pH dependence was specifically a H<sup>+</sup>/peptide cotransport process (Daniel *et al.*, 1991, 1992). After coabsorption of the H<sup>+</sup> and peptide, the pH gradient is re-established by the Na<sup>+</sup>/H<sup>+</sup> exchanger, which also resides in the brush border membrane. This counter transport is dependent on an extracellular–intracellular Na<sup>+</sup> gradient. The increased Na<sup>+</sup> concentration of the cell is re-established by the function of the basolateral membrane bound Na<sup>+</sup>/K<sup>+</sup> ATPase. Because ATP is expended for two processes after absorption of the peptide, H<sup>+</sup>/peptide-coupled transport is considered to be a 'tertiary' transport process. Research establishing the existence of an H<sup>+</sup> gradient across the 'microenvironment' (pH 5.5–6.3) of the apical membrane, and that H<sup>+</sup>-coupled peptide transport is concentrative, has been well reviewed (Ganapathy *et al.*, 1994; Webb and Matthews, 1994). How these ion transporters function to support H<sup>+</sup>-coupled peptide transport is illustrated in Fig. 3.1. The known biochemical parameters of endogenously and exogenously expressed PepT1 activities of farm animal species are summarized in Table 3.1. When compared to the functional activities of humans and laboratory animals (Table 3.2), it is clear that PepT1-like activity is well conserved among animals.

**Table 3.1.** Michaelis–Menten constants for low-affinity, H<sup>+</sup>-dependent peptide transport activity of farm animal species.

Animal	Source tissue	Experimental model	Substrate	$K_m$ (mM)	Source
Chicken	Intestine	PepT1 cDNA <sup>a</sup> expressed in oocytes	Gly-Sar <sup>b</sup>	0.47	Pan <i>et al.</i> (2001a)
Pig	Jejunum	Ussing-chamber	Gly-Gln	9.23 ± 0.14	Winckler <i>et al.</i> (1999)
Sheep	Omasum	Poly(A)+ mRNA expressed in oocytes	Gly-Sar	11.62 ± 3.32	
		PepT1 cDNA expressed in oocytes	Gly-Sar	0.4	Matthews <i>et al.</i> (1996)
		PepT1 cDNA expressed in oocytes	Gly-Sar	1.0 ± 0.01	Chen <i>et al.</i> (2002)
Cattle	Jejunum	BBMV <sup>c</sup>	Gly-Sar	1.28	Wolffram <i>et al.</i> (1998)
	Ileum	BBMV	Gly-Sar	0.93	

<sup>a</sup>Complementary DNA.

<sup>b</sup>Glycylsarcosine.

<sup>c</sup>BBMV, brush border membrane vesicles.

**Table 3.2.** Michaelis–Menten constants for low-affinity, H<sup>+</sup>-dependent peptide transport activity of gastrointestinal tissues and cell lines.

Animal	Source tissue	Experimental model	Substrate	$K_m$ (mM) $K_i$ (mM) <sup>a</sup>	Source
Rat	Small intestine	BBMV <sup>b</sup>	Gly-Sar	2.2 ± 0.2	Tanaka <i>et al.</i> (1998)
Mouse	Intestine	Everted sleeves	Carnosine	12.6 ± 1.6	Ferraris <i>et al.</i> (1988)
Human	Small intestine	BBMV	Penicillin-G	13.9	Poschet <i>et al.</i> (1999)
		BBMV	Gly-Pro	4.1	Adibi (1997a)
	Jejunum Colon: Caco-2 cells	BBMV	Gly-Gly-Pro	3.42	
		BBMV	Gly-Gln	0.64	
		Apical membrane	Bestatin	0.34	Saito and Inui (1993)
		Basolateral membrane	Bestatin	0.71	
		Apical membrane	Gly-Sar	1.1 ± 0.1	Brandsch <i>et al.</i> (1994)
		Apical membrane	Gly-Sar	3.9 ± 0.2	Walker <i>et al.</i> (1998)
		Apical membrane	Cefadroxil	0.98	Terada <i>et al.</i> (1999)
		Basolateral membrane	Cefadroxil	3.29	
Apical membrane	Gly-Sar	0.65			
Rabbit	Jejunum	Basolateral membrane	Gly-Sar	2.1	
		Villus tip cells	Cephadrine	3.6	Tomita <i>et al.</i> (1995)
	Small intestine	BLMV <sup>c</sup>	Gly-Pro	2 ± 0.2	Dyer <i>et al.</i> (1990)
		BBMV	Gly-Sar	17.3 ± 1.4	Ganapathy <i>et al.</i> (1984)
		BBMV	Gly-Sar	19.5 ± 2	
Hamster	Jejunum	BBMV	Penicillin-G	21.7	Poschet <i>et al.</i> (1996)
		Everted rings	Val-Val	9.6	Matthews (1983)
		Gly-Sar	6.1		
		Leu-Leu	5.6		
		Gly-Gly	5.2		
Tilapia (fish)	Intestine	BBMV	Ala-Ala	3.2	
Eel	Intestine	BBMV	Gly-Phe	9.8 ± 3.5	Reshkin and Ahearn (1991)
		BBMV	Gly-Gly	1.81 ± 0.49	Verri <i>et al.</i> (2000)
			Gly-Sar	1.75 ± 0.47	

<sup>a</sup> $K_i$  for cefadroxil inhibition of Gly-Sar transport.

<sup>b</sup>BBMV, brush border membrane vesicles.

<sup>c</sup>BLMV, basolateral membrane vesicles.

In contrast to apical transport of peptides, convincing biochemical evidence for the mediated transfer of intact peptides across the basolateral membrane of these epithelia was not provided until recently. The transport of Gly-Pro across jejunal basolateral membranes isolated from rabbits was reported to be saturable, stimulated by an H<sup>+</sup> gradient, and competitively inhibited by other glycyl-containing peptides (Dyer *et al.*, 1996). These results led researchers to believe that the peptide transport systems expressed in the brush border membrane and in the basolateral membrane are very similar or identical. However, subsequent research using polarized Caco-2

cells and peptide and  $\beta$ -lactam antibiotic substrates (Table 3.2), demonstrated that the affinities of apical and basolateral membrane-localized peptide transport activities differ (Saito and Inui, 1993). Most recently, transport of Gly-Sar across the basolateral membrane of Caco-2 cells was shown to be less sensitive to changes in external pH, as compared to the apically located system (Terada *et al.*, 1999). In addition, the relative ability of cefadroxil to competitively inhibit Gly-Sar uptake was less for basolateral than apical transport, and basolateral transport was unable to concentrate intracellular Gly-Sar, in contrast to the apical transport. Therefore, it

is likely that basolateral peptide transport is mediated by a single low-affinity, H<sup>+</sup>-independent, facilitated transport system. That peptide transport systems possess functional differences, depending on which membrane they are localized in (apical vs. basolateral) is analogous to differences in the location and function of many mammalian amino acid transport systems (Kilberg and Haussinger, 1992; see below). How the differential membrane localization of these transporters contributes to peptide-bound (and free) amino acid absorption across enterocytes is illustrated in Fig. 3.1.

In terms of the energetic cost associated with H<sup>+</sup>-coupled peptide uptake, data from initial biochemical studies were mixed, indicating that either 1 or 2 H<sup>+</sup> were co-transported per peptide molecule (Ganapathy and Leibach, 1985; Hoshi, 1985). Initial studies that characterized the biochemical activity of a protein capable of H<sup>+</sup>-coupled peptide uptake (PepT1; see below) after overexpression by *Xenopus laevis* oocytes (Fei *et al.*, 1994) determined that the H<sup>+</sup>:peptide ratio for the neutral peptide Gly-Sar is 1:1. More extensive research with additional PepT1 substrates, however, has revealed that the number of H<sup>+</sup> required for peptide transport across the apical membrane of enterocytes depends on the charge of the peptide. For example, rabbit PepT1 displays H<sup>+</sup>:peptide ratios of 1:1, 2:1 and 1:1 for neutral, acidic and basic dipeptides, respectively (Steel *et al.*, 1997). Whether acidic peptides are relatively less well recognized in the presence of a lower pH than are neutral or basic dipeptides, has not been definitively established, as evidenced by the contradictory data from whole tissue (Lister *et al.*, 1997) versus *in vitro* (Brandsch *et al.*, 1997) studies.

#### Molecular characteristics and tissue distribution of PepT1

As shown in Tables 3.1 and 3.2, expression of H<sup>+</sup>/peptide co-transport activity by the gastrointestinal epithelia of a variety of animal species has been demonstrated, including that by the chicken, pig, sheep and cow. In addition, there is strong evidence that forestom-

ach epithelia of ruminants are also capable of H<sup>+</sup>-mediated peptide absorption (Matthews, 2000a). With the seminal cloning of PepT1 protein (Fei *et al.*, 1994), the mechanism responsible for H<sup>+</sup>-coupled absorption of intact small peptides (predominantly di- and tripeptides) from the digesta of the intestinal lumen by enterocytes was identified. In mammals, PepT1 mRNA encodes an integral membrane protein that is predicted to possess 12 membrane-spanning domains, with a relatively large extracellular loop between transmembrane domains 9 and 10 (Leibach and Ganapathy, 1996). Chicken PepT1 mRNA, however, is significantly smaller than the mammalian PepT1 mRNA (1.9 kb versus about 3 kb; Chen *et al.*, 1999) and is predicted to encode a protein that lacks the large extracellular loop present in mammalian PepT1 (Pan *et al.*, 2001a).

The distribution of PepT1 mRNA along the small intestine also differs among species. The expression of PepT1 for a rabbit is most abundant in the duodenum and jejunum, lower in ileum, and very low in the colon (Freeman *et al.*, 1995). In contrast, PepT1 expression in rats is most abundant in the ileum as compared to the duodenum and jejunum (Miyamoto *et al.*, 1996). In ruminants, PepT1 is expressed by small intestinal epithelia, and by omasal and ruminal epithelium (Chen *et al.*, 1999; Pan *et al.*, 2001b). These differences in expression of PepT1 reflect the site of protein digestion and the availability of substrates for a given species and confirm previously identified biochemical activities. The molecular characteristics of known farm animal PepT1 mRNA orthologues, and their tissue-specific expression, are summarized in Table 3.3.

#### Regulation of PepT1 expression and activity

How PepT1 activity is regulated is of immense interest to nutritionists and pharmacologists, as this single protein activity accounts for much of total amino acid and  $\beta$ -lactam antibiotic absorption. Consequently, a variety of experimental regimens have been used to investigate how the expression of



**Table 3.3.** Molecular characteristics and tissue distribution of PepT1 mRNA expressed by farm animal species<sup>a</sup>.

Animal	Genbank accession no.	Tissues screened <sup>a</sup>	Transcript size (kb)	Source
Chicken	AY029615	+ du – cr, pr, gi, ce, li, sm	1.9	Chen <i>et al.</i> (1999)
Pig		+ je	2.9	Winckler <i>et al.</i> (1999)
Sheep	AY027496	+ om, ru, du, je, il – li, ki, stm, lm, ce, co	2.8	Pan <i>et al.</i> (2001b)
Cattle		+ om, ru, du, je, il – ab, ce, co, li, sm, lm	2.8	Chen <i>et al.</i> (1999)

<sup>a</sup>ab, abomasum; br, brain; ce, caecum; co, colon; cr, crop; du, duodenum; gi, gizzard; il, ileum; je, jejunum; li, liver; lm, longissimus muscle; om, omasum; pr, proventriculus; ru, rumen; sm, skeletal muscle; stm, semitendinous muscle.

various species orthologues of PepT1 is regulated. As selectively collated in Table 3.4, the sensitivity of PepT1 mRNA and protein expression and/or functional activity to nutritional, ontogenic, disease and various metabolic effectors has been evaluated. In terms of dietary regulation of PepT1, increasing protein and casein content of the diet stimulates PepT1 expression and/or activity (Ferraris *et al.*, 1988; Erickson *et al.* 1995; Shiraga *et al.*, 1999). In terms of specific substrate regulation, either specific or mixtures of peptides appear capable of stimulating PepT1 activity (Ferraris *et al.*, 1988; Brandsch *et al.*, 1995; Adibi, 1997b) and expression (Shiraga *et al.*, 1999; Ogihara *et al.*, 1999), but not, generally, amino acids.

In an apparent paradox, dietary deprivation also stimulates PepT1 expression and activity. Specifically, the effect of a one day fast on the uptake of Gly-Gln by rat jejunal brush border membrane vesicles was to double H<sup>+</sup>-dependent Gly-Gln uptake (Thamotharan *et al.*, 1999a). Concomitant with this increased activity was a threefold increase in the amount of PepT1 mRNA and protein content of the cells. The finding that starvation appears to stimulate was supported by the observation that starvation of rats for 4 days also results in increased levels of PepT1 mRNA by intestinal epithelia (Ogihara *et al.*, 1999; Ihara *et al.*, 2000). Consistent with the robust stimulation of PepT1 activity by nutritional surfeit or deficit, 5-fluorouracil-induced (a chemotherapeutic agent) injury to the intestinal epithe-

lium of rats results in the preservation and production of PepT1 mRNA, relative to depressed mRNA levels observed for sugar (SGLT1) and amino acid (NBAT) transporters (Tanaka *et al.*, 1998). In keeping, PepT1 protein levels were unaffected, whereas sucrase and Na<sup>+</sup>-dependent glucose SGLT1 activities were decreased. Collectively, the nutritional and disease status data suggest that the collective effect of nutritional challenge is to increase PepT1 uptake capacity.

With regard to identifying specific mechanism(s) responsible for PepT1 regulation, the culture of Caco-2 cells in the presence of pentazocine (a selective  $\sigma_1$  receptor ligand) resulted in an increase in PepT1 mRNA and maximum velocity of Gly-Sar transport (Fujita *et al.*, 1999). In contrast, insulin seems to stimulate PepT1 activity in an acute, post-translational manner (Thamotharan *et al.*, 1999b). Specifically, culture of Caco-2 cells in physiological levels of insulin (5 nM) for more than 1 h apparently results from the insertion of pre-existing PepT1 from a cytoplasmic pool, and not from *de novo* synthesis. In keeping with these reports, PepT1 uptake capacity may be regulated by protein kinase C, as the blocking of calmodulin-regulated enzyme cascade depresses endogenously expressed canine (Brandsch *et al.*, 1995) and exogenously expressed ovine (Chen *et al.*, 2002) PepT1 activity. Whether this regulation occurs from a direct phosphorylation-dependent activation of PepT1, or through stimulation of trafficking pathways of cytoplasmic pools of PepT1 remains to be determined.

**Table 3.4.** Regulation of peptide transport activity in animal tissues and cell lines.

Animal	Tissue source	Model <sup>a</sup>	Experimental treatment	Activity			mRNA	Protein	Source
				Substrate	K <sub>i</sub> (mM)	V <sub>max</sub>			
Rat	Jejunum	NS	Control				100 ± 29 <sup>b</sup>		Ihara <i>et al.</i> (2000)
			Starved (4 days)				161 ± 32		
			Semistarved (10 days)				164 ± 32		
			Parenteral nutrition (10 days)				179 ± 35		
	Small Intestine	NS	Low protein (7 days)				1		Erickson <i>et al.</i> (1995)
			High protein (14 days)				1.5–2× ↑ <sup>c</sup>		
	Jejunum, BBMV	NS	Control	Gly-Gln	19.9 ± 1.6		1	1	Thamotharan <i>et al.</i> (1999a)
			Fasting (1 day)	Gly-Gln	41.4 ± 2.7		3× ↑ <sup>d</sup>	3× ↑ <sup>e</sup>	
	Small Intestine	NS	Fasting (4 days)					2× ↑	Ogihara <i>et al.</i> (1999)
			Oral AA mixture (4 days)					1.6× ↓	
	Jejunum	ON	4 days old				1		Miyamoto <i>et al.</i> (1996)
			28 days old				3.6× ↑		
	Ileum, BBMV	SR	Fasting (4 days)	Gly-Sar	2.1 ± 0.4	2.8 ± 0.3			Shiraga <i>et al.</i> (1999)
			Protein free (4 days)				1	1	
			5% casein (4 days)	Gly-Sa	2.0 ± 0.2	2.7 ± 0.2	0.9 ± 0.1	1.2 ± 0.3	
			20% casein (4 days)	Gly-Sar	3.6 ± 0.3*	2.7 ± 0.2	1.8 ± 0.3*	2.0 ± 0.3*	
			50% casein (4 days)	Gly-Sar	4.6 ± 0.2*	2.5 ± 0.2	2.0 ± 0.3*	2.2 ± 0.4*	
			10% Gly (4 days)	Gly-Sar	2.2 ± 0.3	2.6 ± 0.3	0.9 ± 0.1	0.9 ± 0.1	
			10% Phe (4 days)	Gly-Sar	4.7 ± 0.3*	2.6 ± 0.2	2.3 ± 0.2*	2.4 ± 0.5*	
			20% Gly-Phe (4 days)	Gly-Sar	5.5 ± 0.4*	2.4 ± 0.5	2.4 ± 0.3*	2.6 ± 0.3*	
Control			Gly-Sar	3.6 ± 0.2	2.2 ± 0.2	2.3× ↑			
5-Fluorouracil <sup>f</sup> (3 days)			Gly-Sar	3.2 ± 0.2	3.4 ± 0.3				
Jejunum, BBMV	DS	Control	Gly-Sar	10.3 ± 0.7	0.51 ± 0.1			Tanaka <i>et al.</i> (1998)	
		5-Fluorouracil <sup>f</sup> (3 days)	Gly-Sar	3.2 ± 0.2	3.4 ± 0.3				
Colon: Caco-2	SR	Control	Cefadroxil	0.19				Adibi <i>et al.</i> (1997b)	
		GlySar 10 mM (1 day)	Cefadroxil	0.35					
Colon: Caco-2	HS	Control	Gly-Sar	10.3 ± 0.7	0.51 ± 0.1			Fujita <i>et al.</i> (1999)	
		(+) Pentazocine <sup>g</sup> 1 μM (1 day)	Gly-Sar	20.9 ± 1.1	0.69 ± 0.1				
Colon: Caco-2	HS	Control	Gly-Gln	3.53 ± 0.61				Thamotharan <i>et al.</i> (1999b)	
		Insulin 5 nM (1 h)	Gly-Gln	6.31 ± 0.5					
Colon: Caco-2	PM	Control	Gly-Sar	13.8 ± 0.6	0.83 ± 0.1			Brandsch <i>et al.</i> (1997)	
		DEP 0.4 mM (10 min)	Gly-Sar	6.4 ± 0.3	0.76 ± 0.1				

Continued

Table 3.4. *Continued.*

Animal	Tissue source	Model <sup>a</sup>	Experimental treatment	Activity			mRNA	Protein	Source
				Substrate	K <sub>t</sub> (mM)	V <sub>max</sub>			
Canine	Kidney: MDCK	SM	Control	Gly-Sar	132.9 ± 17.5				Brandsch <i>et al.</i> (1995)
			W-7 <sup>i</sup> 50 μM (16 h)	Gly-Sar	67.6 ± 4.2				
			CGS-9343B <sup>j</sup> 30 μM (16 h)	Gly-Sar	79.8 ± 8				
			Calmidazolium <sup>k</sup> 10 μM (16 h)	Gly-Sar	88.5 ± 8				
			DMEM <sup>l</sup> (4 days)	Gly-Sar	29.5 ± 2.98				
Mouse	Small Intestine	SR	LHM <sup>m</sup> (4 days)	Gly-Sar	114.5 ± 8.37			Ferraris <i>et al.</i> (1988)	
			Low protein (18% casein)	Carnosine	5.5 ± 0.5				
			High protein (72% casein)	Carnosine	7.9 ± 0.6				
			54% casein	Carnosine	5.0 ± 0.6				
			54% casein hydrolysate <sup>h</sup>	Carnosine	6.6 ± 0.9				
Swine	Kidney: LLC-PK <sub>1</sub>	SM	Control	D-Phe-L-Ala	92.8 ± 8.1			Wenzel <i>et al.</i> (1999)	
			EGTA-AM <sup>o</sup> /Straurospine (3 h)	D-Phe-L-Ala	157.7 ± 6.3				
			Control	D-Phe-L-Ala	90.3 ± 1.4				

↑, ↓ denotes increase or decrease, respectively; × denotes multiples (or 'times'); \*Differs ( $P < 0.05$ ) from protein-free treatment.

<sup>a</sup>DS, disease status; HS, hormonal status; NS, nutritional status; ON, ontogenic effect; PM, protein modification; SM, second messenger effect; SR, substrate regulation.

<sup>b</sup>Percentages relative to control value.

<sup>c</sup>Middle and distal intestine.

<sup>d</sup>Intestinal mucosa.

<sup>e</sup>Brush border membrane.

<sup>f</sup>Diethylpyrocarbonate which modifies histidyl residues and blocks function (Brandsch *et al.*, 1997).

<sup>g</sup>Anticancer drug that is toxic to cell growth.

<sup>h</sup>A selective  $\sigma_1$  receptor ligand (Fujita *et al.*, 1999).

<sup>i</sup>W-7, *N*-(6-aminohexyl)-5-chloro-1-naphthalenesulphonamide; a calmodulin inhibitor.

<sup>j</sup>CGS-9343B, zaldaride maleate; a calmodulin inhibitor with no effect on protein kinase C.

<sup>k</sup>Inhibitor of calmodulin-regulated enzymes.

<sup>l</sup>DMEM, Dulbecco's modified Eagle's medium.

<sup>m</sup>LHM, lactalbumin hydrolysate medium.

<sup>n</sup>Casein hydrolysate, consists of 50% free amino acids and 50% peptides.

<sup>o</sup>EGTA-AM, ethylene-glycol-bis-( $\beta$ -aminoethyl)-*N*, *N*, *N'*, *N'*-tetraacetoxymethyl ester.

<sup>p</sup>dbcAMP, dibutyryl cyclic AMP.

Overall, despite the above-described understandings, it is still not known whether PepT1 expression is regulated by specific nutrient-gene interactions, intracellular signalling in response to cellular metabolic status, mechanical functioning of the transporter, and/or by hormones. What is clear, however, is that the need to maintain PepT1 functional capacity must be strong and of especial importance to absorptive epithelial function given that most metabolic challenges result in an increase in PepT1 activity. This conclusion is consistent with the understanding that the predominant form of intestinal protein assimilation is that of absorption as small peptides.

### Mediated Absorption of Free Amino Acids

#### Molecular and functional properties of proteins capable of biochemically defined free amino acid transport 'system' activities

As indicated in Fig. 3.1, the mediated absorption of free amino acids across both apical and basolateral membranes is critical to the assimilation of luminal proteins. Remarkably, within the last 12 years, cDNA have been generated that encode proteins for six anionic, four cationic, 11 neutral, and five neutral and cationic free amino acid transporters. Except for exclusive proline and hydroxyproline transport by the IMINO system, at least one of these 26 proteins account for each of the major amino acid transport activities expressed by non-embryonic tissues, which have been biochemically defined over the previous 35 years. To facilitate a working knowledge base for understanding which proteins perform which transport activities, the biochemical and molecular properties of free amino acid transport systems and proteins have been collated in Table 3.5. An important understanding from this research is that the activities of seven biochemically defined transport systems are actually performed by more than one amino acid transporter. In addition, a subset of transporters actually function as heterodimer units, in conjunction with one of two glyco-

proteins (4F2hc, rBAT). These glycoprotein-associated amino acid transporter family members (Verrey *et al.*, 2000) account for all known Na<sup>+</sup>-independent exchange transport activities, and system y<sup>+</sup>L, which functions dually as a Na<sup>+</sup>-independent exchanger of cationic amino acids and Na<sup>+</sup>-dependent exchanger of neutral amino acids. A third concept is that about half of the cloned free amino acid transporters are not capable of net molar flux of amino acids across membranes. Instead, these 'exchangers' selectively import certain amino acids in exchange for export of selected other amino acids.

#### Free amino acid transporters expressed by intestinal epithelia

To facilitate an abbreviated discussion of which and how these transporters function to support absorption of amino acids across the gastrointestinal epithelium, the site of expression for the functional activities, mRNA, and protein (when reported) of free amino acid transporters expressed by gastrointestinal epithelia are collated in Table 3.6. Although few of the transporter proteins have actually been detected in apical or basolateral membranes, the matching of membrane-defined transport activity with detection of mRNA expression (Table 3.5) suggests that at least one molecularly defined transporter has been identified for all biochemically defined transport activities reported for apical and basolateral membranes. In terms of comparing specific substrates with the reported function of cloned transporters (Table 3.5) specific transporters are identified for apical membrane absorption of anionic L-glutamate, L-aspartate, D-aspartate by EAAT2 and/or EAAT3; cationic L-lysine, L-arginine, L-histidine and L-ornithine by CAT1 and L-arginine, L-lysine and L-histidine by b<sup>0,+</sup>AT; and neutral amino acids by ASCT2 and b<sup>0,+</sup>AT. Interestingly, 4F2-1c6 also encodes a protein capable of b<sup>0,+</sup> activity, but which associates with 4F2-hc, not RBAT. As with b<sup>0,+</sup>AT, however, 4F2-1c6 transports cystine and neutral and cationic amino acids in a Na<sup>+</sup>-independent manner. In terms of both cationic and neutral amino acid transport, system B<sup>0,+</sup> activity has long been identified with the apical membrane of intestinal epithelia. However, the

**Table 3.5.** Molecular and biochemical properties of free  $\alpha$ -amino acid transport proteins<sup>a</sup>.

CLONE	Alternate names	Genbank Acc. no.	Length	Transport system	Substrate specificity <sup>bc</sup>	Substrate affinity <sup>d</sup>	Co-substrate coupling	Source
Anionic								
EAAT1	GluT, GLAST	X63744	543	X <sub>AG</sub> <sup>-</sup>	D-,L-Asp, L-Glu	$\mu$ M	Na <sup>+</sup> <sub>in</sub> , K <sup>+</sup> <sub>out</sub> , OH <sup>-</sup> /HCO <sub>3</sub> <sup>-</sup> <sub>out</sub>	Storck <i>et al.</i> (1992)
EAAT2	GLT, GLAST2, GLTR	X67857	573	X <sub>AG</sub> <sup>-</sup>	D-,L-Asp, L-Glu	$\mu$ M	Na <sup>+</sup> <sub>in</sub> , K <sup>+</sup> <sub>out</sub> , OH <sup>-</sup> /HCO <sub>3</sub> <sup>-</sup> <sub>out</sub>	Pines <i>et al.</i> (1992)
EAAT3	EAAC1	L12411	523–525	X <sub>AG</sub> <sup>-</sup>	D-,L-Asp, L-Glu	$\mu$ M	Na <sup>+</sup> <sub>in</sub> , K <sup>+</sup> <sub>out</sub> , OH <sup>-</sup> /HCO <sub>3</sub> <sup>-</sup> <sub>out</sub>	Kanai and Hediger (1992)
EAAT4	—	U18244	564	X <sub>AG</sub> <sup>-</sup>	D-,L-Asp, L-Glu	$\mu$ M	Na <sup>+</sup> <sub>in</sub> , K <sup>+</sup> <sub>out</sub> , OH <sup>-</sup> /HCO <sub>3</sub> <sup>-</sup> <sub>out</sub>	Fairman <i>et al.</i> (1995)
EAAT5	—	U76362	561	X <sub>AG</sub> <sup>-</sup>	D-,L-Asp, L-Glu	$\mu$ M	Na <sup>+</sup> <sub>in</sub> , K <sup>+</sup> <sub>out</sub> , OH <sup>-</sup> /HCO <sub>3</sub> <sup>-</sup> <sub>out</sub>	Arriza <i>et al.</i> (1997)
xCT <sup>ef</sup>	4F2-Ic4	AB022345 AB026891 AF252872	502 501	X <sub>c</sub> <sup>-</sup>	CssC, L-Glu; L-Asp	$\mu$ M	AA1 <sub>CssC</sub> ; AA2 <sub>Glu</sub>	Sato <i>et al.</i> (1999) Bridges <i>et al.</i> (2001)
Cationic								
CAT1	ecoR	M26687	622–629	y <sup>+</sup>	Lys, Arg; Orn, His (when charged)	$\mu$ M	none	Kim <i>et al.</i> (1991) Wang <i>et al.</i> (1991)
CAT2	CAT2 $\beta$	NM003046	657–658	y <sup>+</sup>	Lys, Arg;	$\mu$ M	none	Closs <i>et al.</i> (1993a)
CAT2a	CAT2 $\alpha$	L03290	657–659	y <sup>+</sup>	Lys, Arg; Orn	mM	none	Closs <i>et al.</i> (1993b)
CAT3	—	U70859	619	y <sup>+</sup>	Arg	$\mu$ M	none	Hosokawa <i>et al.</i> (1997)
Neutral								
GlnT (neuronal A)	ATA1	AF075704	485	A	Gln, Asn, His, Ala, Met, Ser, Gly; MeAIB, Pro	$\mu$ M	Na <sup>+</sup> <sub>in</sub>	Varoqui <i>et al.</i> (2000)
ATA2 (classic A)	SA1 SAT2	AF249673 AF273024 AF173682	504	A	MeAIB, Ala, Gly, Ser, Pro, Met, His, Asn, Gln	$\mu$ M	Na <sup>+</sup> <sub>in</sub>	Sugawara <i>et al.</i> (2000a) Reimer <i>et al.</i> (2000) Yao <i>et al.</i> (2000)
ATA3 (hepatic A)		AF295535	547	A	Ala, Gly, Ser, Cys, Asn, Thr; Pro, Met, Gln, His; MeAIB, Lys	mM	Na <sup>+</sup> <sub>in</sub>	Hatanaka <i>et al.</i> (2000)
					Lys, Arg	$\mu$ M	none	Sugawara <i>et al.</i> (2000b)

ASCT1	SATT	L14595	532	ASC	neutral, except for Gln at pH 7.5; plus anionic at pH 5.5	$\mu\text{M}$	$\text{Na}^+_{\text{in}}\text{AA}_{\text{in}}, \text{Na}^+_{\text{in}}\text{AA}_{\text{out}}$	Arriza <i>et al.</i> (1993) Zerangue and Kavanaugh (1996)
ASCT2	ATB°	D-85044 U53347	553	B°	L-AA: Ala, Gln, Ser, Cys, Thr, Trp, Gln, Asn, Leu; Met, Val, Ile, Phe; Trp, Gly D-AA: Ser, Thr, Cys	$\mu\text{M}$	$\text{Na}^+_{\text{in}}$	Utsunomiya-Tate <i>et al.</i> (1996) Kekuda <i>et al.</i> (1996)
Asc-1 <sup>ef</sup>		AB026688	530	asc	L-AA: Ala, Gly, Ser, Thr, Cys; Val, Met, Ile, Leu, His D-AA: Ala, Ser, $\beta$ -Ala, AIB, Ala-methyl; Cys, Asn, Leu, Ile, Val, His; Gln, Met, Phe	$\mu\text{M}$	$\text{AA1}_{\text{in}}; \text{AA2}_{\text{out}}$	Fukasawa <i>et al.</i> (2000)
LAT1 <sup>ef</sup>	4F2-1c1	AB015432 AF104032	512 507	L	L-AA: Leu, Ile, Phe, Met, Tyr His, Trp; Val D-AA: Leu, Phe, Met; Ile	low $\mu\text{M}$	$\text{AA1}_{\text{in}}; \text{AA2}_{\text{out}}$	Kanai <i>et al.</i> (1998) Prasad <i>et al.</i> (1999)
LAT2 <sup>ef</sup>	4F2-1c5	AF171668	531	L	Phe; Leu; Ala; Gln, His	$\mu\text{M}$	$\text{AA1}_{\text{in}}; \text{AA2}_{\text{out}}$	Rossier <i>et al.</i> (1999)
		AF171669	535		Thr, Phe, Trp; Ser, Gln, Leu, Ala, Cys, BCH	$\mu\text{M}$		Rajan <i>et al.</i> (2000)
SN1	NAT	NM006841 AF159856 AF244548	504 505 504	N	Gln, His Gln, His; Ala Gln, His; Asn, Ala	mM mM mM	$\text{Na}^+_{\text{in}}\text{AA}_{\text{out}}^+$ , $2\text{Na}^+_{\text{in}}\text{AA}_{\text{out}}^{2+}$ , $\text{Li}^+$ or $\text{Na}^+_{\text{in}}$	Chaudhry <i>et al.</i> (1999) Gu <i>et al.</i> (2000) Fei <i>et al.</i> (2000)
SN2		AF276870	472	N	His; Asn, Ser, Gln; Ala, Gly	mM	$\text{Li}^+$ or $\text{Na}^+_{\text{in}}, \text{H}^+_{\text{out}}$	Nakanishi <i>et al.</i> (2001)

Continued

Table 3.5. *Continued.*

CLONE	Alternate names	Genbank Acc. no.	Length	Transport system	Substrate specificity <sup>bc</sup>	Substrate affinity <sup>d</sup>	Co-substrate coupling	Source
TAT1		AB047324	514	T	L-AA: Tyr, Trp, Phe, L-Dopa, 3-O-methyl-Dopa D-AA: Trp, Phe	mM	none	Kim <i>et al.</i> (2001)
Neutral and cationic ATB <sup>0+</sup>		AF151978	642	B <sup>0+</sup>	Ile, Leu, Trp, Met, Val, Ser; His, Tyr, Ala, Lys, Arg, Cys, Gly; Asn, Thr, Gln; Pro	NR	2Na <sup>+</sup> <sub>in</sub> , 2Cl <sup>-</sup> <sub>in</sub>	Sloan and Mager (1999)
y <sup>+</sup> LAT1 <sup>ef</sup>	AmAT-L-1c 4F2-1c2	AF092032 AJ130718 R82979	511	y <sup>+</sup> L	Leu; Arg, Lys, Gln, His  Lys, Arg, Orn; Met, Leu, His	μM	AA1 <sub>in</sub> ; AA2 <sub>out</sub> Na <sup>+</sup> <sub>in</sub> or H <sup>+</sup> (for neutral)	Torrents <i>et al.</i> (1998) Pfeiffer <i>et al.</i> (1999a) Kanai <i>et al.</i> (2000)
y <sup>+</sup> LAT2 <sup>ef</sup>	4F2-1c3	D87432	515	y <sup>+</sup> L	Arg, Leu Arg, Lys, Gln, His, Met;	μM	AA1 <sub>in</sub> ; Arg <sub>out</sub> Na <sup>+</sup> <sub>in</sub> (for neutral)	Torrents <i>et al.</i> (1998) Broer <i>et al.</i> (2000)
BAT1 <sup>eg</sup>	b <sup>0+</sup> AT	AB029559 AJ249198 Aj249199	487	b <sup>0+</sup>	Arg, Leu, Lys, Phe, Tyr; CysC, Ile, Val, Trp, His, Ala; Met, Gln, Asn, Thr, Cys, Ser	μM	neutral AA, dibasic AA exchange	Chairoungdua <i>et al.</i> (1999)  Pfeiffer <i>et al.</i> (1999b)
4F2-1c6 <sup>ef</sup>		AF155119	487	b <sup>0+</sup>	Leu, Trp, Phe, Met, Ala, Ser, Cys, Thr, Gln, Asn; Gly, CysC, BCH	μM	neutral AA, dibasic AA exchange	Rajan <i>et al.</i> (1999)

<sup>a</sup>Does not include members of the BGT, GAT, GLYT, TAUT or PRO neurotransmitter transporter families.

<sup>b</sup>;<sup>c</sup> denotes physiologically significant differences in degree of substrate affinity.

<sup>c</sup>CysC, L-cystine; Orn, ornithine; MeAIB, 2-methylaminoisobutyrate; AIB, α-aminoisobutyric acid; BCH, 2-aminobicyclo(2,2,1)heptane-2-carboxylic acid; Dopa, L-dihydroxyphenylalanine.

<sup>d</sup>When possible, values are data from overexpression of cDNA by mammalian cells, rather than by *Xenopus* oocytes.

<sup>e</sup>Member of the glycoprotein-associated amino acid transporter family.

<sup>f</sup>Associates with 4F2hc glycoprotein.

<sup>g</sup>Associates with rBAT glycoprotein.

**Table 3.6.** Expression of free  $\alpha$ -amino acid transporter activities, mRNA and/or protein by mammalian gastrointestinal epithelia.

Transport system	Location of activity <sup>a</sup>	Specific transporter	Epithelia <sup>bc</sup> evaluated	mRNA	Protein <sup>d</sup>	Source
<b>Anionic</b>						
X <sub>AG</sub> <sup>-</sup>	Ap	EAAT2	R, O, D, J, I, Ce, Co	X	CMV	Howell <i>et al.</i> (2001)
		EAAT3	R, O, D, J, I, Ce, Co	X	CMV	Howell <i>et al.</i> (2001)
x <sub>c</sub> <sup>-</sup>	NR	xCT	intestine	X		Bassi <i>et al.</i> (2001)
<b>Cationic</b>						
y <sup>+</sup>	Ap, BI	CAT1	Small intestine	X		Kim <i>et al.</i> (1991); Wang <i>et al.</i> (1991)
<b>Neutral</b>						
A	BI	ATA2	Small intestine	X		Sugawara <i>et al.</i> (2000a)
B <sup>o</sup>	Ap	ASCT2	Intestine	X		Kekuda <i>et al.</i> (1996, 1997)
asc	BI	Asc-1	Small intestine	X		Fukasawa <i>et al.</i> (2000)
L	BI	LAT2	Small intestine	X	BI	Rossier <i>et al.</i> (1999)
N	Ap or BI	SN2	Small intestine	X		Nakanishi <i>et al.</i> (2001)
T	BI	TAT1	J, I, Co	X	BI	Kim <i>et al.</i> (2001)
IMINO	Ap	Unknown				
<b>Neutral and cationic</b>						
B <sup>o,+</sup>	Ap	ATB <sup>o,+</sup>	Distal I, Ce, Co	X		Hatanaka <i>et al.</i> (2001)
y <sup>+</sup> L	BI	y <sup>+</sup> LAT1	Small intestine	X		Torrents <i>et al.</i> (1998); Pfeiffer <i>et al.</i> (1999a)
	BI	y <sup>+</sup> LAT2	Small intestine	X		Broer <i>et al.</i> (2000)
b <sup>o,+</sup>	Ap	BAT1	J, I	X		Chairoungdua <i>et al.</i> (1999)
	Ap	b <sup>o,+</sup> AT	Intestine	X		Pfeiffer <i>et al.</i> (1999b)
	Ap	4F2-1c6	Small intestine	X		Rajan <i>et al.</i> (1999)

<sup>a</sup>As reviewed by Ganapathy *et al.* (1994), Mailliar *et al.* (1995), Palacin *et al.* (1998), Wagner *et al.* (2001), Bode (2001) and/or Matthews and Anderson (2002). Ap, apical; BI, basolateral membrane; NR, not reported.

<sup>b</sup>R, rumen; O, omasum; D, duodenum; J, jejunum; I, ileum; Co, colon; Ce, caecum.

<sup>c</sup>When known, expression is reported for farm animal species.

<sup>d</sup>CMV, crude membrane vesicles isolated from homogenates of scraped epithelial tissues.



limited mRNA tissue distribution profiles for  $\text{ATB}^{0,+}$ , which encodes a protein capable of  $\text{B}^{0,+}$  activity, shows no expression by the duodenum or jejunum and only weak expression by the distal ileum. In contrast, caecal and colonic expression is high. Therefore, it remains to be determined whether  $\text{ATB}^{0,+}$  function contributes significantly to small intestinal absorption of amino acids, or whether another, as yet unidentified,  $\text{ATB}^{0,+}$  isoform is responsible for system  $\text{B}^{0,+}$  activity.

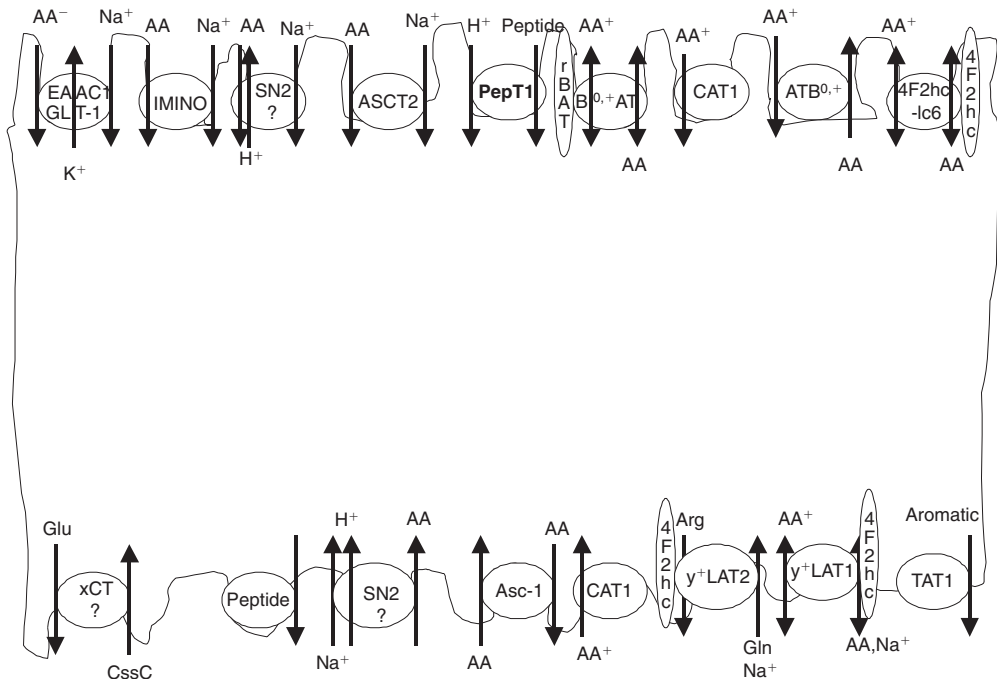
In terms of basolateral transport capacity, cationic amino acids are unilaterally transported by CAT1 uniport in counterexchange for neutral amino acids by  $\text{y}^+\text{LAT1}$ . In addition, given its intracellular binding preference for L-arginine and the high blood concentrations of L-glutamine, the predominant function of  $\text{y}^+\text{LAT2}$  is to absorb L-glutamine into enterocytes in exchange for L-arginine. Accordingly, the function of  $\text{y}^+\text{LAT2}$  may well be the mechanical coupling of the high intestinal L-glutamine uptake from, and L-arginine export into, splanchnic blood (Wu, 1998). In contrast, the presence of a basolateral anionic amino acid transporter has yet to be described (although xCT mRNA has been detected by RT-PCR, Bassi *et al.*, 2001), and may help explain the low arterial uptake of L-glutamate and L-aspartate by small intestinal epithelia. Neutral amino acid transport across the basolateral membrane of enterocytes appears to be achieved by a combination of activities by  $\text{Na}^+$ -dependent (ATA2) and  $\text{Na}^+$ -independent (TAT1) uniporters and ion-independent amino acid exchangers (Asc-1, LAT2,  $\text{y}^+\text{LAT1}$ ,  $\text{y}^+\text{LAT2}$ ). In addition, SN2 may contribute significantly to L-histidine, L-serine, L-asparagine and L-glutamine absorption by coupled  $\text{Na}^+/\text{H}^+$  counter-exchange (Bode, 2001).

**Asymmetrical expression, yet coordinated function, of amino acid transporters by polarized intestinal epithelia**

In terms of how amino acid flux is mediated across enterocytes, all of the apical transporters are ion-dependent and capable of concentrative transport, except for the two system  $\text{b}^{0,+}$  transporters. Consequently, the molar ratio of

cationic and neutral amino acids initially absorbed from the lumen by concentrative transporters can be modulated by  $\text{ATB}^{0,+}$  activity. Of the basolateral transporters, only ATA2 and TAT1 are uniporters. ATA2 (system A activity) activity is  $\text{Na}^+$ -dependent, capable of concentrative transport, and functions to transport amino acids into the cell, not into the blood. Conversely, TAT1 is a  $\text{Na}^+$ -independent system that selectively transports aromatic amino acids, down their concentration gradients. In contrast the other basolateral transporters are all exchangers. As a consequence of this differential expression of apical and basolateral transporters, it is likely that the bulk of amino acids that enter the blood through enterocytes is dependent on the concentration of amino acids in the cytosol of enterocytes.

A pertinent question that arises from the combined understandings gained from localization and functional studies with intestinal amino acid transporters is the degree to which the functions of apical (including PepT1) and basolateral amino acid transporters functions are coordinated. A working model that reflects current understanding of differential localization and identity of specific transporters responsible for mediated flux of amino acids across apical and basolateral membranes of enterocytes is presented in Fig. 3.2. How differential localization of transporters results in ion-dependent and substrate exchange-dependent vectorial transport of amino acids through enterocytes likely is similar to that proposed for renal epithelia presented by Palacin *et al.* (1998) and Verrey *et al.* (2000). As discussed above, it is generally accepted that the majority of amino acids are absorbed as small peptides, by PepT1 activity. After absorption, the peptide-bound amino acids are readily hydrolysed to free amino acids by intracellular peptidases (Fig. 3.1). As a consequence of these PepT1-dependent activities, and the activity of the  $\text{Na}^+$ -dependent  $\text{X}^-_{\text{AG}}$  and  $\text{B}^0$  (and, perhaps, SN2 and  $\text{B}^{0,+}$ ), an elevated supply of free amino acids exists to drive counterexchange across the apical membrane by BAT1 (and 4F2-1c6) and the counterexchange transport by basolateral transporters (Asc-1, LAT2) into the blood. Whereas the putative coordinated function of these differentially expressed transporters on transepithelial amino acid flux



**Fig. 3.2.** Working model for the membrane-specific expression of peptide and free amino acid transporters by intestinal epithelial cells. The locations and predominant direction of substrate flow is derived from functional properties listed in Tables 3.4 and 3.5, and/or described in the text.

has not been evaluated, the influence of apically expressed PepT1 function on apical neutral and cationic amino acid uptake capacity by polarized Caco-2 cells has been (Wenzel *et al.*, 2001). PepT1 uptake of several neutral amino acid-containing dipeptides resulted in a 2.5- to 3.5-fold increased uptake of L-arginine by apical b<sup>0,+</sup>AT activity. As this stimulation was dependent on intracellular hydrolysis of transported amino acids, it appears that PepT1 activity stimulated L-arginine by supplying requisite amino acids to drive b<sup>0,+</sup>AT antiport uptake of arginine.

### Emerging Concepts for the Role of Amino Acid Transporters

#### Potential for absorption of D-amino acids by intestinal epithelia

Given the fundamental differences in the amount of D-amino acids likely to be seen by

animals that have a large pregastric fermentation capacity, and hence, a relatively greater production of bacterially derived D-amino acids, it is reasonable to suggest that the intestinal epithelia of ruminants may possess a larger capacity to absorb D-amino acids than postgastric fermenters. In this regard, several amino acid transport systems and proteins capable of D-amino acid absorption have been identified. Of particular importance is those systems capable of absorbing D-amino acids which are especially abundant in bacterial cell walls (D-glutamate, D-alanine and D-serine). Biochemically characterized system x<sub>c</sub><sup>-</sup> activity has been defined as the Na<sup>+</sup>-independent obligate exchange of L-glutamate and L-cysteine, which may be inhibited by D-glutamate (Dantzig *et al.*, 1978). Recently a cRNA has been generated (xCT) that apparently encodes for system x<sub>c</sub><sup>-</sup>-like activity, when co-expressed with 4F2hc (Sato *et al.*, 1999). However, expression of x<sub>c</sub><sup>-</sup> activity by enterocytes is unknown to these authors and investigation of

the ability of xCT to recognize and transport D-glutamate was not reported.

Although asc-like activity has been reported in the basolateral membranes of enterocytes (Mailliard *et al.*, 1995), the localization of Asc-1 has not been confirmed. In contrast, ASCT2 is localized to the apical membrane of intestinal epithelia. With regard to aromatic D-amino acids, both LAT1 and TAT1 are localized to the basolateral membrane and transport D-phenylalanine. In addition, the absorption of at least D-phenylalanine-containing peptides by PepT1 has been documented (Meredith and Boyd, 2000). The differential expression of ASCT2 and Asc-1 activity on both membranes of enterocytes indicates the capacity to absorb significant amounts of bacterial-derived D-amino acids from the intestinal lumen into the blood. These understandings, and that the flux of specific amino acids into the blood depends on their ability to compete for transport, suggest that the indiscriminant use of D-, L-isomer combinations as a supplemental source for one L-amino acid may perturb the flux of others into blood.

Other emerging concepts not explicitly covered in this review regarding the physiological consequences of transporter expression and function, include the potential pathological consequences that system  $y^+$  (CAT1; Kim *et al.*, 1991; Wang *et al.*, 1991), ASC (ASCT1; Marin *et al.*, 2000), and B<sup>0</sup> (ASCT2; Rasko *et al.*, 1999; Taylor *et al.*, 2001) transporters serve as recognition molecules for various retroviruses and, in terms of ion fluxes, that system X<sub>AG</sub><sup>-</sup> (EAAT5; Fairman

*et al.*, 1995) and N (SN1, Chaudhry *et al.*, 1999) 'amino acid' transporters may be more accurately considered to function as amino acid-gated ion channels. Respectively, these understandings suggest that the ability to transport amino acids is associated with a health 'risk/cost' and indicate that amino acids can serve as 'signalling' molecules.

## Conclusions

As reviewed previously in detail (Matthews, 2000a,b), and augmented with the current discussion, the evidence is strong that the gastrointestinal epithelia of pigs, chickens, sheep and cattle possess a large capacity to digest proteins and absorb their constituent amino acids by the same mechanisms as other animals, albeit with some important distinctions. Unanswered questions regarding the application of flux and transport data to the design of all animal diets include the following:

1. What is the capacity for peptide-bound versus free amino acid uptake by the gastrointestinal epithelia?
2. Can this capacity be regulated *in vivo* by diet and/or feeding regimens?
3. Will increasing the amount of peptide-bound amino acids achieve greater amino acid absorption efficiencies?
4. Is the development and use of model substrates and/or protein hydrolysates to potentiate peptide absorption capacity economically feasible?

## References

- Adibi, S.A. (1997a) Renal assimilation of oligopeptides: physiological mechanisms and metabolic importance. *American Journal of Physiology* 272, E723-E736.
- Adibi, S.A. (1997b) The oligopeptide transporter (PepT-1) in human intestine: biology and function. *Gastroenterology* 113, 332-340.
- Adibi, S.A. and Morse, E.L. (1971) Intestinal transport of dipeptides in man: relative importance of hydrolysis and intact absorption. *Journal of Clinical Investigation* 50, 2266-2275.
- Alpers, D.H. (1986) Uptake and fate of absorbed amino acids and peptides in the mammalian intestine. *Federation Proceedings* 45, 2261-2267.
- Alpers, D.H. (1994) Digestion and absorption of carbohydrates and proteins. In: Johnson, L.R. (ed.) *Physiology of the Gastrointestinal Tract*, 3rd edn. Raven Press, New York, pp. 1723-1749.
- Arriza J.L., Eliasof, S., Kavanaugh, M.P., Fairman, W.A., Wu, Y.N., Murdoch, G.H., North, R.A. and Amara, S.C. (1993) Cloning and expression of a human neutral amino acid transporter with structural

- similarity to the glutamate transporter gene family. *Journal of Biological Chemistry* 268, 15329–15332.
- Arriza, J.L., Eliasof, S., Kavanaugh, M.P. and Amara, S.G. (1997) Excitatory amino acid transporter 5, a retinal glutamate transporter coupled to a chloride conductance. *Proceedings of the National Academy of Sciences USA* 94, 4155–4160.
- Aviles, F.X., Vendrell, J., Burgos, F.J., Soriano, F. and Mendez, E. (1985) Sequential homologies between procarboxypeptidases A and B from porcine pancreas. *Biochemical and Biophysical Research Communications* 130, 97–103.
- Backwell, F.R.C., Hipiolito-Reis, M., Wilson, D., Bruce, L.A., Buchan, V. and Macrae, J.C. (1997) Quantification of circulating peptides and assessment of peptide uptake across the gastrointestinal tract of sheep. *Journal of Animal Science* 75, 3315–3322.
- Bassi, M.T., Gasol, E., Manzoni, M., Pineda, M., Riboni, M., Martin, R., Zorzano, A., Borsani, G. and Palacin, M. (2001) Identification and characterization of human xCT that co-expresses, with 4F2 heavy chain, the amino acid transport activity system x<sub>c</sub><sup>-</sup>. *Pflugers Archiv* 442, 286–296.
- Bernard, L. and Rémond, D. (1996) Effect of two methods of deproteinization on the estimation of peptide bound amino acids in whole blood and plasma. In: *Protein Metabolism and Nutrition. Proceedings of the 7th International Symposium*. EAAP Publication no. 81, pp. 413–414.
- Bernard, L. and Rémond, D. (1999) Carnosine absorption across the ruminant stomach wall. *South African Journal of Animal Science* 29, 233–234.
- Berthiaume, R., Dubreuil, P., Stevenson, M., McBride, B.W. and Lapierre, H. (2001) Intestinal disappearance and mesenteric portal appearance of amino acids in dairy cows fed ruminally protected methionine. *Journal of Dairy Science* 84, 194–203.
- Bode, B. (2001) Recent molecular advances in mammalian glutamine transport. *Journal of Nutrition* 131, 2475S–2485S.
- Brandsch, M., Miyamoto, Y., Ganapathy, V. and Leibach, F.H. (1994) Expression and protein kinase c-dependent regulation of peptide/H<sup>+</sup> co-transport system in the Caco-2 human colon carcinoma cell line. *Journal of Biochemistry* 299, 253–260.
- Brandsch, M., Ganapathy, V. and Leibach, F.H. (1995) H(+)-peptide cotransport in Madin-Darby canine kidney cells: expression and calmodulin-dependent regulation. *American Journal of Physiology* 268, F391–F397.
- Brandsch, M., Brandsch, C. Ganapathy, M.E., Chew, C.S., Ganapathy, V. and Leibach, F.H. (1997) Influence of proton and essential histidyl residues on the transport kinetics of the H<sup>+</sup>/peptide cotransport systems in intestine (PEPT1) and kidney (PEPT2). *Biochimica et Biophysica Acta* 1324, 251–262.
- Bridges, C.C., Kekuda, R., Wang, H., Prasad, P.D., Mehta, P., Huang, W., Smith, S.B. and Ganapathy, V. (2001) Structure, function, and regulation of human cystine/glutamate transporter in retinal pigment epithelial cells. *Investigative Ophthalmology and Visual Science* 42, 47–54.
- Britton, R., and Krehbiel, C. (1993) Nutrient metabolism by gut tissues. *Journal of Dairy Science* 76, 2125–2131.
- Broer, A., Wagner, C.A., Lang, F. and Broer, S. (2000) The heterodimeric amino acid transporter 4F2hc/y<sup>+</sup>LAT2 mediates arginine efflux in exchange with glutamine. *Journal of Biochemistry* 349, 787–795.
- Chairoungdua, A., Segawa, H., Kim, J.Y., Miyamoto, K., Haga, H., Fukui, Y., Mizoguchi, K., Ito, H., Takedo, E., Endou, H. and Kanai, Y. (1999) Identification of an amino acid transporter associated with the cystinuria-related type II membrane glycoprotein. *Journal of Biological Chemistry* 274, 28845–28848.
- Chaudhry, F.A., Reimer, R.J., Krizaj, D., Barber, D., Storm-Mathisen, J., Copenhagen, D.R. and Edwards, R.H. (1999) Molecular analysis of system N suggests novel physiological roles in nitrogen metabolism and synaptic transmission. *Cell* 99, 769–780.
- Chen, H., Wong, E.A. and Webb, K.E. Jr. (1999) Tissue distribution of a peptide transporter mRNA in sheep, dairy cows, pigs, and chickens. *Journal of Animal Science* 77, 1277–1283.
- Chen, H., Pan, Y.X., Wong, E.A. and Webb, K.E. Jr. (2002) Characterization and regulation of a cloned ovine gastrointestinal peptide transporter (oPepT1) expressed in a mammalian cell line. *Journal of Nutrition* 132, 38–42.
- Closs, E.I., Lyons, C.R., Kelly, C. and Cunningham, J.M. (1993a) Characterization of a third member of the MCAT family of cationic amino acid transporters. *Journal of Biological Chemistry* 268, 20796–20800.
- Closs, E.I., Albritton, L.M., Kim, J.W. and Cunningham, J.M. (1993b) Identification of a low affinity, high

- capacity transporter of cationic amino acids in mouse liver. *Journal of Biological Chemistry* 268, 7538–7544.
- Cohnheim, O. (1901) Transformation of protein by intestine wound. *Journal of Physiological Chemistry* 33, 451–465.
- Creveieu-Gabriel, I., Gomez, J., Caffin, J.P. and Carre, B. (1999) Comparison of pig and chicken pepsins for protein hydrolysis. *Reproduction, Nutrition, Development* 39, 443–454.
- Daniel, H., Morse, E.L. and Adibi, S.A. (1991) The high and low affinity transport systems for dipeptides in kidney brush border membrane respond differently to alterations in pH gradient and membrane potential. *Journal of Biological Chemistry* 266, 19917–19924.
- Daniel, H., Morse, E.L. and Adibi, S.A. (1992) Determinants of substrate affinity for the oligopeptide/H<sup>+</sup> symporter in the renal brush border membrane. *Journal of Biological Chemistry* 267, 9565–9573.
- Dantzig, A.H., Finkelstein, M.C., Adelberg, E.A. and Slayman, C.W. (1978) The uptake of L-glutamic acid in a normal mouse lymphocyte line and in a transport mutant. *Journal of Biological Chemistry* 253, 5813–5819.
- Dyer, J., Beechey, R.B., Gorvel, J.P., Smith, R.T., Wootton, R. and Shirazi-Beechey S.P. (1990) Glycyl-L-proline transport in rabbit enterocyte basolateral-membrane vesicles. *Biochemical Journal* 269, 565–571.
- Dyer, J., Allison, G., Scollan, N.D. and Shirazi-Beechey, S.P. (1996) Mechanism of peptide transport in ruminant intestinal brush-border membrane. *Biochemical Society Transactions* 24, 274S.
- Elwyn, D.H., Hamendra, C.P. and Shoemaker, W.C. (1968) Amino acid movements between gut, liver, and periphery in unanesthetized dogs. *American Journal of Physiology* 215, 1260–1275.
- Erickson, R.H., Gum, J.R., Jr, Lindstrom, M.M., McKean, D. and Kim, Y.S. (1995) Regional expression and dietary regulation of rat small intestinal peptide and amino acid transporter mRNA. *Biochemical and Biophysical Research Communications* 216, 249–257.
- Fairman, W.A., Vandenberg, R.J., Arriza, J.L., Kavanaugh, M.P. and Amara, S.G. (1995) An excitatory amino acid transporter with properties of a ligand-gated chloride channel. *Nature* 375, 599–603.
- Fei, Y.J., Kanai, Y., Nussberger, S., Ganapathy, V., Leibach, F.H., Romero, M.F., Singh, S.K. Boron, W.F. and Hediger, M.A. (1994) Expression cloning of a mammalian proton-coupled oligopeptide transporter. *Nature* 368, 563–566.
- Fei, Y.J., Sugawara, M., Nakanishi, T., Huang, W., Wang, H., Prasad, P.D., Leibach, F.H. and Ganapathy, V. (2000) Primary structure, genomic organization, and functional and electrogenic characteristics of human system N1, a Na<sup>+</sup>- and H<sup>+</sup>-coupled glutamine transporter. *Journal of Biological Chemistry* 275, 23707–23717.
- Ferraris, R.P., Diamond, J. and Kwan, W.W. (1988) Dietary regulation of intestinal transport of the dipeptide carnosine. *American Journal of Physiology* 255, G143–G150.
- Freeman, T.C., Bentsen, B.S., Thwaites, D.T. and Simmons, N.L. (1995) H<sup>+</sup>/di-tripeptide transporter (PepT1) expression in the rabbit intestine. *Pflugers Archiv* 430, 390–400.
- Fujita, T., Majikawa, Y., Umehisa, S., Okada, N., Yamamoto, A., Ganapathy, V. and Leibach, F.H. (1999) Sigma receptor ligand-induced up-regulation of the H<sup>(+)</sup>/peptide transporter PEPT1 in the human intestinal cell line Caco-2. *Biochemical and Biophysical Research Communications* 261, 242–246.
- Fukasawa, Y., Segawa, H., Kim, J.Y., Chairoungdua, A., Kim, D.K., Matsuo, H., Cha, S.H., Endou, H. and Kanai, Y. (2000) Identification and characterization of a Na<sup>+</sup>-independent neutral amino acid transporter that associates with the 4F2 heavy chain and exhibits substrate selectivity for small neutral D- and L-amino acids. *Journal of Biological Chemistry* 275, 9690–9698.
- Ganapathy, V. and Leibach, F.H. (1985) Is intestinal transport energized by a proton gradient? *American Journal of Physiology* 249, G153–G160.
- Ganapathy, V., Brandsch, M. and Leibach, F.H. (1994) Intestinal transport of amino acids and peptides. In: Johnson, L.R. (ed.) *Physiology of the Gastrointestinal Tract*, 3rd edn. Raven Press, New York, pp.1773–1794.
- Ganapathy, V., Burckhardt, G. and Leibach, F.H. (1984) Characteristics of glysylsarcosine transport in rabbit intestinal brush-border membrane vesicles. *Journal of Biological Chemistry* 259, 8954–8959.
- Gardner, M.L.G. (1994) Absorption of intact proteins and peptides. In: Johnson, L.R. (ed.) *Physiology of the Gastrointestinal Tract*, 3rd edn. Raven Press, New York, pp. 1795–1820.
- Gardner, M.L.G. and Wood, D. (1989) Transport of peptides across the gastrointestinal tract. *Biochemical Society Transactions* 17, 934–937.
- Gaudichon, C., Mahe, S., Luengo, C., Laurent, C., Meaugeais, P., Krempf, M. and Tome, D. (1996) A

- <sup>15</sup>N-leucine-dilution method to measure endogenous contribution to luminal nitrogen in the human upper jejunum. *European Journal of Clinical Nutrition* 50, 261–268.
- Gu, S., Roderick, H.L., Camacho, P. and Jiang, J.X. (2000) Identification and characterization of an amino acid transporter expressed differentially in liver. *Proceedings of the National Academy of Sciences USA* 97, 3230–3235.
- Guan, D. and Green, G.M. (1996) Significance of peptic digestion in rat pancreatic secretory response to dietary protein. *American Journal of Physiology* 271, G42–G47.
- Han, X.T. (1998) Net absorption of ammonia, urea, glucose free and peptide amino acids in portal-drained yak and Holstein steers fed diets containing different level of ruminal protein degradability. PhD thesis, Northwest Institute of Plateau Biology, the Chinese Academy of Sciences, Xining, China.
- Han, X.T., Xue, B., Du, J.Z. and Hu, L.H. (2001) Net fluxes of peptide and amino acid across mesenteric-drained and portal-drained viscera of yak cows fed a straw-concentrate diet at maintenance level. *Journal of Agricultural Science* 136, 119–127.
- Hatanaka T., Huang, W., Wang, H., Sugawara, M., Prasad, P.D., Leibach, F.H. and Ganapathy, V. (2000) Primary structure, functional characteristics and tissue expression pattern of human ATA2, a subtype of amino acid transport system A. *Biochimica et Biophysica Acta* 1467, 1–6.
- Hatanaka, T., Nakanishi, T., Huang, W., Leibach, F.H., Prasad, P.D., Ganapathy, V. and Ganapathy, M.E. (2001) Na<sup>+</sup> and Cl<sup>-</sup> coupled active transport of nitric oxide synthase inhibitors via amino acid transport system B(0,+). *Journal of Clinical Investigation* 107, 1035–1043.
- Hoshi, T. (1985) Proton-coupled transport of organic solutes in animal membranes and its relation to Na<sup>+</sup> transport. *Japanese Journal of Physiology* 35, 179–191.
- Hosokawa, H., Sawamura, T., Kobayashi, S., Ninomiya, H., Miwa, S. and Masaki, T. (1997) Cloning and characterization of a brain-specific cationic amino acid transporter. *Journal of Biological Chemistry* 272, 8717–8722.
- Howell, J.A., Matthews, A.D., Swanson, K.C., Harmon, D.L. and Matthews, J.C. (2001) Molecular identification of high-affinity glutamate transporters in sheep and cattle forestomach, intestine, liver, kidney, and pancreas. *Journal of Animal Science* 79, 1329–1336.
- Huntington, G.B., Reynolds, C.K. and Stroud, B. (1989) Techniques for measuring blood flow in the splanchnic tissues of cattle. *Journal of Dairy Science* 72, 1583–1595.
- Ihara, T., Tsujikawa, T., Fujiyama, Y. and Bamba, T. (2000) Regulation of PepT1 peptide transporter expression in the rat small intestine under malnourished conditions. *Digestion* 61, 59–67.
- Jungas, R.L., Halperin, M.L. and Brosnan, J.T. (1992) Quantitative analysis of amino acid oxidation and related gluconeogenesis in humans. *Physiological Reviews* 72, 419–448.
- Kanai, Y. and Hediger, M.A. (1992) Primary structure and functional characterization of a high-affinity glutamate transporter. *Nature* 360, 467–471.
- Kanai, Y., Segawa, H., Miyamoto, K., Uchino, H., Takeda, E. and Endou, H. (1998) Expression and cloning of a transporter for large neutral amino acids activated by the heavy chain of 4F2 antigen (SD98). *Journal of Biological Chemistry* 273, 23629–23632.
- Kanai, Y., Fukasawa, Y., Cha, S.H., Segawa, H., Chairoungdua, A., Kim, D.K., Matsuo, H., Kim, J.Y., Miyamoto, K., Takeda, E. and Endou, H. (2000) Transport properties of a system y<sup>+</sup>L neutral and basic amino acid transporter. Insights into the mechanisms of substrate recognition. *Journal of Biological Chemistry* 275, 20787–20793.
- Kekuda, R., Prasad, P.D., Fei, Y.-J., Torres-Zamorano, V., Sinha, S., Yang-Feng, T.L., Leibach, F.H. and Ganapathy, V. (1996) Cloning of the sodium-dependent, broad-scope, neutral amino acid transporter B<sup>0</sup> from a human placental choriocarcinoma cell line. *Journal of Biological Chemistry* 271, 18675–18661.
- Kekuda, R., Torres-Zamorano, V., Fei, Y.-J., Prasad, P.D., Li, H.W., Mader, D., Leibach, F.H. and Ganapathy, V. (1997) Molecular and functional characterization of intestinal Na<sup>+</sup>-dependent neutral amino acid transporter B<sup>0</sup>. *American Journal of Physiology* 272 (Gastrointestinal Liver Physiology 35), G1463–G1472.
- Kilburg, M.S. and Haussinger, D. (1992) *Mammalian Amino Acid Transport: Mechanisms and Control*. Plenum Press, New York.
- Kim, D.K., Kanai, Y., Chairoungdua, A., Maysuo, H., Cha, S.H. and Endou, H. (2001) Expression cloning of a Na<sup>+</sup>-independent aromatic amino acid transporter with structural similarity to H<sup>+</sup>/monocarboxylate transporters. *Journal of Biological Chemistry* 276, 17221–17228.
- Kim, J.W., Closs, E.I., Albritton, L. and Cunningham, J.M. (1991) Transport of cationic amino acids by the mouse ecotropic retrovirus receptor. *Nature* 352, 725–728.

- Kim, Y.S., Birthwhistle, W. and Kim, Y.W. (1972) Peptide hydrolases in the brush border and soluble fractions of small intestinal mucosa of rat and man. *Journal of Clinical Investigation* 51, 1419–1430.
- Kim, Y.S., Kim, Y.W., and Slesinger, M.H. (1974) Studies on the properties of peptide hydrolases in the brush border and soluble fractions of small intestinal mucosa of rat and man. *Biochimica et Biophysica Acta* 370, 283–296.
- Kitamoto, Y., Yuan, X., Wu, Q., McCourt, D.W., and Sadler, J.E. (1994) Enterokinase, the initiator of intestinal digestion, a mosaic protease composed of a distinctive assortment of domains. *Proceedings of the National Academy of Sciences USA* 91, 7588–7592.
- Koeln, L.L., Schlagheck, T.G. and Webb, K.E. Jr. (1993) Amino acid flux across the gastrointestinal tract and liver of calves. *Journal of Dairy Science* 76, 2275–2285.
- Kwong, W.K., Seetharam, L. and Aplers, D.H. (1978) Effect of exocrine pancreatic insufficiency on small intestine in the mouse. *Gastroenterology* 74, 1277–1282.
- Lassiter, J.W. and Edwards, H.M. (1982) Comparative digestion and absorption: general concepts. In: *Animal Nutrition*. Reston Publishing Co., Reston, Virginia, pp.13–23.
- Leibach, F.H. and Ganapathy, V. (1996) Peptide transporters in the intestine and the kidney. *Annual Review of Nutrition* 16, 99–119.
- Lien, K.A., Sauer, W.C., Mosinthin, R., Souffrant, W.B. and Dugan, M.E. (1997) Evaluation of the <sup>15</sup>N-isotope dilution technique for determining the recovery of endogenous protein in ileal digesta of pigs: effect of dilution in the precursor pool for endogenous nitrogen secretion. *Journal of Animal Science* 75, 148–158.
- Lister, N., Bailey, P.D., Collier, I.D., Boyd, C.A.R. and Bronk, J.R. (1997) The influence of luminal pH on transport of neutral and charged dipeptides by rat small intestine, *in vitro*. *Biochimica et Biophysica Acta* 1324, 245–250.
- MacRae, J.C., Bruce, L.A., Brown, D.S. and Calder, A.G. (1997a) Amino acid use by the gastrointestinal tract of sheep given Lucerne forage. *American Journal of Physiology*. 273, G1200–G1207.
- MacRae, J.C., Bruce, L.A., Brown, D.S., Farningham, D.A.H. and Franklin, M. (1997b) Absorption of amino acids from the intestine and their net flux across the mesenteric- and portal-drained viscera of lambs. *Journal of Animal Science* 75, 3307–3314.
- Mailliard, M.E., Stevens, B.R. and Mann, G.E. (1995) Amino acid transport by small intestinal, hepatic, and pancreatic epithelia. *Gastroenterology* 108, 888–910.
- Marin, M., Tailor, C.S., Nouri, A. and Kabat, D. (2000) Sodium-dependent neutral amino acid transporter 1 is an auxiliary receptor for baboon endogenous retrovirus. *Journal of Virology* 74, 8085–8093.
- Matthews, D.M. (1983) Intestinal absorption of peptides. *Biochemical Society Transactions* 11, 808–810.
- Matthews, D.M. (1991) *Protein Absorption: Development and Present State of the Subject*. Wiley-Liss, New York.
- Matthews, J.C. (2000a) Amino acid and peptide transport systems. In: D'Mello, J.P.F. (ed.) *Farm Animal Metabolism and Nutrition*. CAB International, Wallingford, UK, pp. 3–23.
- Matthews, J.C. (2000b) Peptide absorption: where peptides fit in protein nutrition and metabolism. In: Lyons, T.P. and Jaques, K.A. (eds) *Biotechnology in the Feed Industry. Proceedings of Alltech's Sixteenth Annual Symposium*. Nottingham University Press, Nottingham pp. 357–368.
- Matthews, J.C. and Anderson, K.J. (2002) Recent advances in amino acid transporters and excitatory amino acid receptors. *Current Opinions in Clinical Nutrition and Metabolic Care* 1, 77–89.
- Matthews, J.C. and Webb, K.E. Jr. (1995) Absorption of L-carnosine, L-methionine, and L-methionylglycine by isolated sheep ruminal and omasal epithelial tissue. *Journal of Animal Science* 73, 3463–3475.
- Matthews, J.C., Wong, E.A., Bender, P.K., Bloomquist, J.R. and Webb, K.E. Jr. (1996) Demonstration and characterization of dipeptide transport system activity in sheep omasal epithelium by expression of mRNA in *Xenopus laevis* oocytes. *Journal of Animal Science* 74, 1720–1727.
- McCormick, M.E. and Webb, K.E. Jr. (1982) Plasma free, erythrocyte free and plasma peptide amino acid exchange of calves in steady state and fasting metabolism. *Journal of Nutrition* 112, 276–282.
- Meredith, D. and Boyd, C.A. (2000) Structure and function of eukaryotic peptide transporters. *Cellular and Molecular Life Sciences* 57, 754–778.
- Meyer, J.H. and Kelly, G.A. (1976) Canine pancreatic responses to intestinally perfused proteins and protein digests. *American Journal of Physiology* 231, 682–691.
- Miyamoto, K., Shiraga, T., Morita, K., Yamamoto, H., Haga, H., Taketani, Y., Tamai, I., Sai, Y., Tsuji, A. and Takeda, E. (1996) Sequence, tissue distribution and developmental changes in rat intestinal oligopeptide transporter. *Biochimica et Biophysica Acta* 1305, 34–38.
- Nakanishi, T., Sugawara, M., Huang, W., Martindale, R.G., Leibach, F.H., Ganapathy, M.E., Prasad, P.D. and Ganapathy, V. (2001) Structure, function, and tissue expression pattern of human SN2, a subtype

- of the amino acid transport system N. *Biochemical and Biophysical Research Communications* 281, 1343–1348.
- Neutze, S.A., Gooden, J.M. and Oddy, V.H. (1996) Uptake of labeled phenylalanine into different blood fractions in the portal vein and cranial mesenteric vein of lambs. *Journal of Agricultural Science* 126, 511–518.
- Newey, H. and Smyth, D.H. (1959) The intestinal absorption of some dipeptides. *Journal of Physiology* 145, 48–56.
- Nóren, O., Dabelsteen, E., Sjöstrom, H. and Josefsson, L. (1977) Histological localization of two dipeptidases in the pig small intestine and liver using immunofluorescence. *Gastroenterology* 72, 87–92.
- Ogihara, H., Suzuki, T., Nagamachi, Y., Inui, K. and Takata, K. (1999) Peptide transporter in the rat small intestine: ultrastructural localization and the effect of starvation and administration of amino acids. *Histochemical Journal* 31, 169–174.
- Palacin, M., Estevez, R., Bertran, J. and Zorzano, A. (1998) Molecular biology of mammalian plasma membrane amino acid transporters. *Physiological Reviews* 78, 969–1054.
- Pan, Y., Bender, P.K., Akers, R.M., and Webb, K.E. Jr. (1996) Methionine-containing peptides can be used as methionine sources for protein accretion in cultural C2C12 and MAC-T cells. *Journal of Nutrition* 126, 232–241.
- Pan, Y., Chen, L., Wong, E.A., Bloomquist, J.R. and Webb, K.E. Jr. (2001a) Functional expression of a cloned chicken intestinal peptide transporter (cPepT1) in *Xenopus* oocytes. *FASEB Journal* 15, A962.
- Pan, Y., Wong, E.A., Bloomquist, J.R. and Webb, K.E. Jr. (2001b) Expression of a cloned ovine gastrointestinal peptide transporter (oPepT1) in *Xenopus* oocytes induces uptake of oligopeptides *in vitro*. *Journal of Nutrition* 131, 1264–1270.
- Pfeiffer, R., Löffing, J., Rossier, G., Spindler, B., Meier, C., Kuhn, L.C. and Verrey, F. (1999a) Amino acid transport of y<sup>+</sup>L-type by heterodimers of 4F2hc/CD98 and members of the glycoprotein-associated amino acid transporter family. *EMBO Journal* 18, 49–57.
- Pfeiffer, R., Löffing, J., Rossier, G., Bauch, C., Meier, C., Eggermann, T., Löffing-Cueni, D., Kuhn, L.C. and Verrey, F. (1999b) Luminal heterodimeric amino acid transporter defective in cystinuria. *Molecular Biology of the Cell* 10, 4135–4147.
- Pines, G., Danbolt, N.C., Borjas, M., Zhang, Y., Bendahan, A., Eide, L., Kopsell, H., Storm-Mathisen, J., Seeberg, E. and Kanner, B.I. (1992) Cloning and expression of a rat brain L-glutamate transporter. *Nature* 360, 464–467.
- Poschet, J.F., Hammond, S.M. and Fairclough, P.D. (1996) Characterisation of penicillin-G uptake in rabbit small-intestinal brush-border membrane vesicles. *Biochimica et Biophysica Acta* 1278, 233–240.
- Poschet, J.F., Hammond, S.M. and Fairclough, P.D. (1999) Characterisation of penicillin G uptake in human small intestinal brush border membrane vesicles. *Gut* 44, 620–624.
- Prasad, P.D., Wang, H.P., Huang, W., Kekdua, R., Rajan, D.P., Leibach, F.H. and Ganapathy, V. (1999) Human LAT1, a subunit of system L amino acid transporter: molecular cloning and transport function. *Biochemical and Biophysical Research Communications* 255, 283–288.
- Prior, R.L. and Gross, K.L. (1995) Dietary arginine deficiency and gut ammonium infusion alter flux of urea cycle intermediates across the portal-drained viscera of pigs. *Journal of Nutrition* 125, 251–263.
- Rajan, D.P., Kekdua, R., Huang, W., Wang, H.P., Devoe, L.D., Leibach, F.H., Prasad, P.D. and Ganapathy, V. (1999) Cloning and expression of a b<sup>0,+</sup>-like amino acid transporter functioning as a heterodimer with 4F2hc instead of rBAT – a new candidate gene for cystinuria. *Journal of Biological Chemistry* 274, 29005–29010.
- Rajan, D.P., Kekdua, R., Huang, W., Wang, H.P., Devoe, L.D., Leibach, F.H., Prasad, P.D. and Ganapathy, V. (2000) Cloning and functional characterization of a Na<sup>+</sup>-independent, broad-specific neutral amino acid transporter from mammalian intestine. *Biochimica et Biophysica Acta* 1463, 6–14.
- Rasko, J.E., Battini, J.L., Gottschalk, R.J., Mazo, I. and Miller, A.D. (1999) The RD114/simian type D retrovirus receptor is a neutral amino acid transporter. *Proceedings of the National Academy of Sciences USA* 96, 2129–2134.
- Rémond, D., Bernard, L. and Poncet, C. (2000) Amino acid flux in ruminal and gastric veins of sheep: effects of ruminal and omasal injections of free amino acids and carnosine. *Journal of Animal Science* 78, 158–166.
- Reimer, R.J., Chaudhry, F.A., Gray, A.T. and Edwards, R.H. (2000) Amino acid transport A resembles system N in sequence but differs in mechanism. *Proceedings of the National Academy of Science USA* 97, 7715–7720.
- Rerat, A., Simoes Nunes, C., Mendy, F., Vaissade, P. and Vaugelade, P. (1992) Splanchnic fluxes of amino



- acids after duodenal infusion of carbohydrate solutions containing free amino acids of oligopeptides in the nonanaesthetized pig. *British Journal of Nutrition* 68, 111–138.
- Reshkin, S.J. and Ahearn, G.A. (1991) Intestinal glycyl-L-phenylalanine and L-phenylalanine transport in a euryhaline teleost. *American Journal of Physiology* 260, R563–R569.
- Reynolds, C.K. (2001) Economics of visceral energy metabolism in ruminants – Toll keeping or internal revenue service? Proceedings of the American Society of Animal Science Available at: <http://www.asas.org/jas/symposia/proceedings/filename>. Accessed 25 Feb. 2002.
- Reynolds, C.K., Harmon, D.L. and Cecava, M.J. (1994) Absorption and delivery of nutrients for milk protein synthesis by portal-drained viscera. *Journal of Dairy Science* 77, 2787–2808.
- Rossier, G., Meier, C., Bauch, C., Summa, V., Sordat, B., Verrey, F. and Kuhn, L.C. (1999) LAT2, a new basolateral 4F2hc/CD98-associated amino acid transporter of kidney and intestine. *Journal of Biological Chemistry* 274, 34948–34954.
- Saito, H. and Inui, K. (1993) Dipeptide transporters in apical and basolateral membranes of the human intestinal cell line Caco-2. *American Journal of Physiology* 265, G289–G294.
- Sato, H., Tamba, M., Ishii, T. and Bannai, S. (1999) Cloning and expression of a plasma membrane cystine/glutamate exchange transporter composed of two distinct proteins. *Journal of Biological Chemistry* 276, 11455–11458.
- Seal, C.J. and Parker, D.S. (1991) Isolation and characterization of circulating low molecular weight peptides in steer, sheep and rat portal and peripheral blood. *Comparative Biochemistry and Physiology. B. Comparative Biochemistry* 99, 679–685.
- Seal, C.J. and Parker, D.S. (1996) Effect of intraruminal propionic acid infusion on metabolism of mesenteric- and portal-drained viscera in growing steers fed a forage diet: II. Ammonia, urea, amino acids, and peptides. *Journal of Animal Science* 74, 245–256.
- Seal, C.J. and Reynolds, C.K. (1993) Nutritional implications of gastrointestinal and liver metabolism in ruminants. *Nutrition Research Reviews* 6, 185–208.
- Shiraga, T., Miyamoto, K., Tanaka, H., Yamamoto, H., Taketani, Y., Morita, K., Tamai, I., Tsuji, A. and Takeda, E. (1999) Cellular and molecular mechanisms of dietary regulation on rat intestinal H<sup>+</sup>/Peptide transporter PepT1. *Gastroenterology* 116, 354–362.
- Sloan, J.L. and Mager, S. (1999) Cloning and functional expression of a human Na<sup>+</sup> and Cl<sup>-</sup> dependent neutral and cationic amino acid transporter B<sup>0,+</sup>. *Journal of Biological Chemistry* 274, 23740–23745.
- Steel, A., Nussberger, S., Romero, M.F., Boron, W.F., Boyd, C.A. and Hediger, M.A. (1997) Stoichiometry and pH dependence of the rabbit proton-dependent oligopeptide transporter PepT1. *Journal of Physiology* 498 (Pt 3), 563–569.
- Sterchi, E.E. and Woodley, J.F. (1980) Peptide hydrolases of the human small intestinal mucosa: Distribution of activities between brush border membranes and cytosol. *Clinica Chimica Acta* 102, 49–56.
- Stoll, B., Henry, J., Reeds, P.J., Hung, Y., Jahoor, F. and Burrin, D.G. (1998) Catabolism dominates the first-pass intestinal metabolism of dietary essential amino acids in milk protein-fed piglets. *Journal of Nutrition* 128, 606–614.
- Storck, T., Schulte, S., Hofmann, K. and Stoffel, W. (1992) Structure, expression, and functional analysis of a Na<sup>+</sup>-dependent glutamate/aspartate transporter from rat brain. *Proceedings of the National Academy of Sciences USA* 89, 10955–10959.
- Sugawara, M., Nakanishi, T., Fei, Y.J., Huang, W., Ganapathy, M.E., Leibach, F.H. and Ganapathy, V. (2000a) Cloning of an amino acid transporter with functional characteristics and tissue expression pattern identical to that of system A. *Journal of Biological Chemistry* 275, 16473–16477.
- Sugawara, M., Nakanishi, T., Fei, Y.J., Martindale, R.G., Ganapathy, M.E., Leibach, F.H. and Ganapathy, V. (2000b) Structure and function of ATA3, a new subtype of amino acid transport system A, primarily expressed in the liver and skeletal muscle. *Biochimica et Biophysica Acta* 1509, 7–13.
- Tagari, H. and Bergman, E.N. (1978) Intestinal disappearance and portal blood appearance of amino acids in sheep. *Journal of Nutrition* 108, 790–803.
- Taylor, C.S., Marin, M., Nouri, A., Kavanaugh, M.P. and Kabat, D. (2001) Truncated forms of the dual function human ASCT2 neutral amino acid transporter/retroviral receptor are translationally initiated at multiple alternative CUG and GUG codons. *Journal of Biological Chemistry* 276, 27221–27230.
- Tanaka, H., Miyamoto, K.I., Morita, K., Haga, H., Segawa, H., Shiraga, T., Fujioka, A., Kouda, T., Taketani, Y., Hisano, S., Fukui, Y., Kitagawa, K. and Takeda, E. (1998) Regulation of the PepT1 pep-

- tide transporter in the rat small intestine in response to 5-fluorouracil-induced injury. *Gastroenterology* 114, 714–723.
- Terada, T., Sawada, K., Saito, H., Hashimoto, Y. and Inui, K. (1999) Functional characteristics of basolateral peptide transporter in the human intestinal cell line Caco-2. *American Journal of Physiology* 276, G1435–G1441.
- Thamotharan, M., Bawani, S.Z., Zhou, X. and Adibi, S.A. (1999a) Functional and molecular expression of intestinal oligopeptide transporter (Pept-1) after a brief fast. *Metabolism* 48, 681–684.
- Thamotharan, M., Bawani, S.Z., Zhou, X. and Adibi, S.A. (1999b) Hormonal regulation of oligopeptide transporter Pept-1 in a human intestinal cell line. *American Journal of Physiology* 276, C821–C826.
- Tobey, N., Yeh, R., Huang, T.I., Heizer, W. and Hoffner, C. (1985) Human intestinal brush border peptidases. *Gastroenterology* 88, 913–926.
- Tomita, Y., Takano, M., Yasuhara, M., Hori, R. and Inui, K. (1995) Transport of oral cephalosporins by the H<sup>+</sup>/dipeptide cotransporter and distribution of the transport activity in isolated rabbit intestinal epithelial cells. *Journal of Pharmacology and Experimental Therapeutics* 272, 63–69.
- Torrents, D., Estevez, R., Pineda, M., Fernandez, E., Lloberas, J., Shi, Y.-B., Zorzano, A. and Palacin, M. (1998) Identification and characterization of a membrane protein (y<sup>+</sup>L amino acid transporter-1) that associates with 4F2hc to encode the amino acid transporter activity y<sup>+</sup>L. *Journal of Biological Chemistry* 273, 32437–32445.
- Ugokv, A.M., Timofeeva, N.M., Roshchina, G.M., Smirnova, L.F., Gruzdkov, A.A. and Gusev, S.A. (1990) Localization of peptide hydrolysis in the enterocyte and the transport mechanisms of apical membrane. *Comparative Biochemistry and Physiology* 95A, 501–509.
- Ulshen, M.H. (1987) Physiology of protein and amino acid absorption. In: Grand, R.J., Sutphen, J.L. and Dietz, W.H. (eds) *Pediatric Nutrition: Theory and Practice*. Butterworths, Boston, Massachusetts, pp. 139–152.
- Utsunomiya-Tate, N., Endou, H. and Kanai, Y. (1996) Cloning and functional characterization of a System ASC-like Na<sup>+</sup>-dependent neutral amino acid transporter. *Journal of Biological Chemistry* 271, 14883–14890.
- van Goudoever, J.B., Stoll, B., Henry, J.F., Burrin, D.G. and Reeds, P.J. (2000) Adaptive regulation of intestinal lysine metabolism. *Proceedings of the National Academy of Sciences USA* 97, 11620–11625.
- Van Slyke, D. and Meyer, G.M. (1912) The amino acid nitrogen of the blood. *Journal of Biological Chemistry* 12, 399–410.
- Varoqui, H., Zhu, H., Yao, D., Ming, H. and Erickson, J.D. (2000) Cloning and functional identification of a neuronal glutamine transporter. *Journal of Biological Chemistry* 275, 4049–4054.
- Verrey, F., Meier, C., Rossier, G. and Kuhn, L.C. (2000) Glycoprotein-associated amino acid exchanges: broadening the range of transport specificity. *European Journal of Physiology* 440, 503–512.
- Verri, T., Maffia, M., Danieli, A., Herget, M., Wenzel, U., Daniel, H. and Storelli, C. (2000) Characterisation of the H(+)/peptide cotransporter of eel intestinal brush-border membranes. *Journal of Experimental Biology* 203, Pt 19, 2991–3001.
- Wagner, C.A., Lang, F. and Boer, S. (2001) Function and structure of heterodimeric amino acid transporters. *American Journal of Physiology* 281, 1077–C1093.
- Wallace, R.J., Newbold, C.J., Watt, N.D., Buchan, J. and Brown, D.S. (1993) Amino acid composition of degradation-resistant peptides in extracellular rumen fluid of sheep. *Journal of Agricultural Science* 120, 129–133.
- Walker, D., Thwaites, D.T., Simmons, N.L., Gilbert, H.J. and Hirst, B.H. (1998) Substrate upregulation of the human small intestinal peptide transporter, hPepT1. *Journal of Physiology* 507, 697–706.
- Wang, H., Kavanaugh, M.P., North, R.A. and Kabat, D. (1991) Cell-surface receptor for ecotropic murine retroviruses is a basic amino-acid transporter. *Nature* 352, 729–731.
- Webb, K.E., Jr and Matthews, J.C. (1994) Absorption of amino acids and peptides. In: Asplund, J.M. (ed.) *Principles of Protein Nutrition of Ruminants*. CRC Press, Boca Raton, Florida, pp. 127–146.
- Webb, K.E., Jr, Dirienzo, D.V. and Matthews, J.C. (1993) Recent developments in gastrointestinal absorption and tissue utilization of peptides: a review. *Journal of Dairy Science* 76, 351–361.
- Wenzel, U., Diehl, D., Herget, M., Kuntz, S. and Daniel, H. (1999) Regulation of the high-affinity H<sup>+</sup>/peptide cotransporter in renal LLC- PK1 cells. *Journal of Cellular Physiology* 178, 341–348.
- Wenzel, U., Meissner, B., Doring, F. and Daniel, H. (2001) PepT1-mediated uptake of dipeptides enhances the intestinal absorption of amino acids via transport system b<sup>0,+</sup>. *Journal of Cellular Physiology* 186, 251–259.

- Wiggans, D.S. and Johnston, J.M. (1959) The absorption of peptides. *Biochimica et Biophysica Acta* 32, 69–73.
- Winckler, C., Breves, G., Boll, M. and Daniel, H. (1999) Characteristics of dipeptide transport in pig jejunum *in vitro*. *Journal of Comparative Physiology B* 169, 495–500.
- Wolffram, S., Grenacher, B. and Scharrer, E. (1998) H(+)-coupled uphill transport of the dipeptide glycylsarcosine by bovine intestinal brush-border membrane vesicles. *Journal of Dairy Science* 81, 2595–2603.
- Wu, G. (1998) Intestinal mucosal amino acid catabolism. *Journal of Nutrition* 128, 1249–1252.
- Yao, D., Mackenzie, B., Ming, H., Varoqui, H., Zhu, H., Hediger, M.A. and Erickson, J.D. (2000) A novel system A isoform mediating Na<sup>+</sup>/neutral amino acid transport. *Journal of Biological Chemistry* 275, 2790–2797.
- Zerangue, N. and Kavanaugh, M.P. (1996) ASCT-1 is a neutral amino acid exchanger with chloride channel activity. *Journal of Biological Chemistry* 271, 27991–27994.

# 4 An Outline of Pathways in Amino Acid Metabolism

**J.P.F. D'Mello\***

*Formerly of Biotechnology Department, The Scottish Agricultural College,  
Edinburgh, UK*

---

## Introduction

Since the first edition of this book, considerable advances have been made in elucidating the processes involved in the metabolism of amino acids in animals. These developments as reviewed in several chapters in the present updated edition, rely on some basic appreciation of intermediary metabolism of important amino acids. To avoid unnecessary repetition, outline pathways are collated in this chapter, commencing with key reactions and following up with more advanced features of metabolism of particular relevance to chapters in this edition.

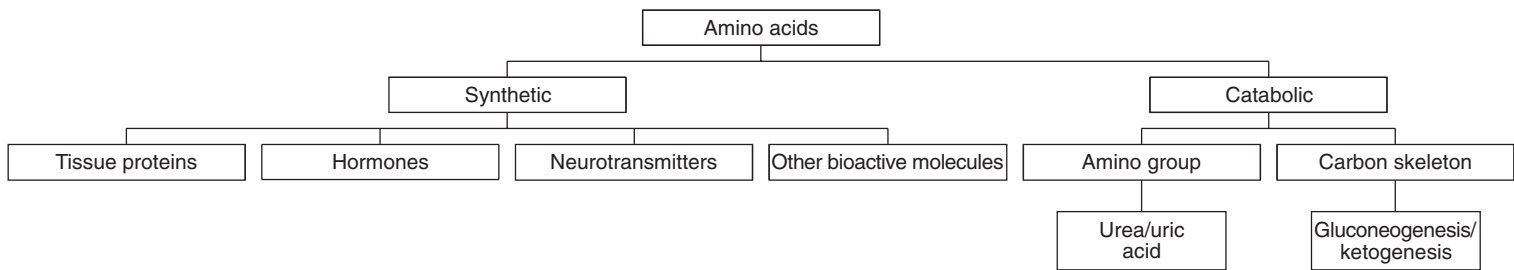
Inter-organ flux of amino acids is important in determining the profile that reaches the ultimate sites of utilization (Seal and Parker, 2000). Amino acids cannot be stored as free molecules and must follow anabolic routes to peptides, proteins, hormones and other bioactive molecules (Fig. 4.1) or catabolic pathways to ammonia (fish), urea (mammals) or uric acid (birds and reptiles). The terms 'ammoniotelic', 'ureotelic' and 'uricotelic' are used to indicate the forms of N excretion in the respective groups of animals. Despite the disparate end products of amino acid catabolism in these animals, the basic features outlined in the next section

apply in common to all species covered in this book. Furthermore, rumen microbes display these key reactions as well as the innate capacity to synthesize all of the essential amino acids (Chapter 15).

## Key Reactions

All animals have the capacity to use or salvage metabolic ammonia in key assimilation reactions involving glutamate dehydrogenase and glutamine synthase. In mammals, assimilation of ammonia also occurs via the action of carbamoyl phosphate synthetase, enabling delivery of carbamoyl phosphate to the urea cycle. The amino group formed by the action of glutamate dehydrogenase may then be transferred to  $\alpha$ -keto acids to form a number of important amino acids. This synthesis is catalysed by the aminotransferases or transaminases. Amino acids may also undergo reactions brought about by oxidases and decarboxylases with significant physiological and nutritional consequences. The major sites of amino acid metabolism are gut, muscle, liver, and brain. A summary of some important enzymes involved in amino acid metabolism is presented in Table 4.1.

\*E-mail address: f.dmello@ed.sac.ac.uk



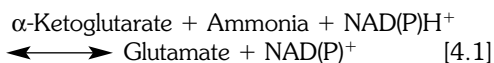
**Fig. 4.1.** Overview of pathways in amino acid metabolism in animals.

**Table 4.1.** Some key enzymes in amino acid metabolism of animals.

Class	Enzymes	
	Specific examples	Function
Transferases	Aspartate aminotransferase	Synthesis/breakdown of aspartate
Dehydrogenases	Glutamate dehydrogenase	Synthesis/breakdown of glutamate
Oxidases	D-amino acid oxidases	Conversion of certain D-amino acids to the L-form when linked to an appropriate aminotransferase
Hydroxylases	Tyrosine hydroxylase	Formation of Dopa from tyrosine
Decarboxylases	Ornithine decarboxylase	Initiation of polyamine synthesis
	Orotidylate decarboxylase	Pyrimidine biosynthesis
	Aromatic decarboxylase	Decarboxylation of Dopa
	5-Hydroxytryptophan decarboxylase	Synthesis of 5-hydroxytryptamine
Urea cycle enzymes	Ornithine transcarbamoylase	Synthesis of citrulline
	Argininosuccinate synthetase	Synthesis of argininosuccinate
	Argininosuccinase	Breakdown of argininosuccinate to arginine and fumarate
	Arginase	Breakdown of arginine to urea and ornithine
Uric acid enzymes	Glutamine phosphoribosyl pyrophosphate amidotransferase	Incorporation of glutamine in synthesis of purine ring
	Phosphoribosyl glycinamide synthetase	Incorporation of glycine in purine synthesis
	Xanthine oxidase	Synthesis of uric acid
	Nitric oxide synthases (NOS)	cNOS and iNOS

### Glutamate dehydrogenase

Glutamate dehydrogenase is a key enzyme in amino acid metabolism due to its involvement in both the synthesis of glutamate and its breakdown by the reversible reaction shown below:

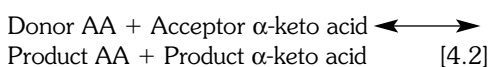


When linked with aminotransferase reactions, the above pathway enables the synthesis of the non-essential amino acids and the degradation of all amino acids. The breakdown of glutamate by this reaction represents an oxidative deamination requiring either  $\text{NAD}^+$  or  $\text{NADP}^+$ .

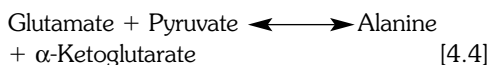
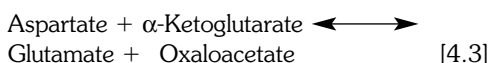
### Aminotransferases (transaminases)

Aminotransferases or transaminases catalyse the transfer of an amino group from one amino acid (AA) to a keto acid to form another amino acid. These enzymes require

pyridoxal phosphate as cofactor to maximize activity. In general terms the aminotransferase reaction may be represented by:

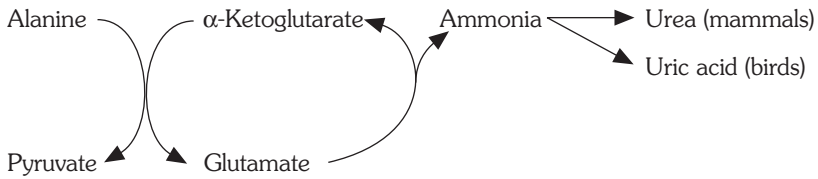


Two specific examples are shown below:



In theory all aminotransferase reactions should be reversible and this certainly is the case in microbial metabolism, for example in the rumen. However, within animal tissues only a limited number of  $\alpha$ -keto acids are readily transaminated to their respective amino acids (Table 4.2).

Using alanine and pyruvate, the two key reactions shown above (Reactions [4.1] and [4.2]) may be rearranged into the following sequence:



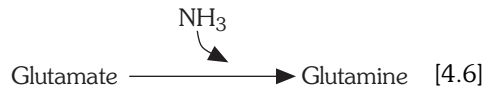
**Table 4.2.**  $\alpha$ -Keto acids readily transaminated in animal tissues.

$\alpha$ -Keto acid	Amino acid
$\alpha$ -Ketoglutarate	Glutamate
Oxaloacetate	Aspartate
Pyruvate	Alanine
$\alpha$ -Ketoisocaproate	Leucine
$\alpha$ -Keto- $\beta$ -methylvalerate	Isoleucine
$\alpha$ -Ketoisovalerate	Valine
Phenylpyruvate	Phenylalanine

The initial step in the degradation of most amino acids involves a transamination reaction which when coupled with the action of glutamate dehydrogenase results in the production of ammonia. The liver is the primary site for coupled reactions of this type, enabling degradation of all amino acids. The ammonia may be re-utilized or, because of its toxicity, converted into urea or uric acid in the liver prior to excretion via the kidneys. Skeletal muscle, however, is the major site for the transamination of the three branched-chain amino acids (BCAA), leucine, isoleucine and valine (Harper *et al.*, 1984). BCAA transaminase accepts all three amino acids as substrates, yielding the respective branched-chain keto acids (BCKA). These keto acids are then transported to the liver for further metabolism. The amino groups of BCAA are eventually used in the synthesis of glutamine which essentially acts as a carrier of ammonia. Species differences have been noted with respect to the initial and ultimate fate of leucine (Seal and Parker, 2000). In non-ruminants, skeletal muscle oxidizes the bulk of leucine derived from muscle protein degradation and the corresponding  $\alpha$ -keto acid is re-aminated in the liver. In contrast, in the fasted ruminant, leucine produced from muscle turnover is used in protein synthesis in the liver and gut.

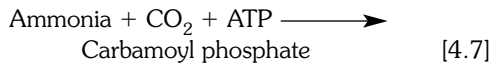
### Glutamine synthase

The assimilation of ammonia may occur by a second pathway catalysed by glutamine synthase as follows:



### Carbamoyl phosphate synthetase

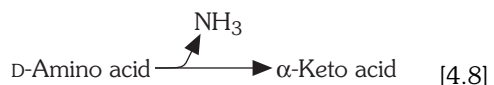
A third mechanism for the assimilation of ammonia involves carbamoyl phosphate synthetase:



Carbamoyl phosphate then enters the urea cycle by combining with ornithine, thus enabling the excretion of waste N in mammals. The enzyme, however, is absent in uricotelic animals which consequently lack a functional urea cycle.

### Oxidases

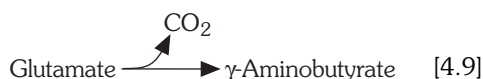
In animals only amino acids of the L-configuration are encoded for incorporation into tissue proteins. However, D-isomers of certain amino acids may be utilized by animals, following conversion of these isomers to the corresponding L-forms. The enzymes catalysing such reactions are termed D-amino acid oxidases requiring FAD as cofactor. The reaction is shown below:



The  $\alpha$ -keto acid then undergoes reaction with an L-specific transaminase to yield the appropriate L-amino acid. This coupled set of reactions enables animals to use D-methionine with up to 90% efficacy (Baker, 1994).

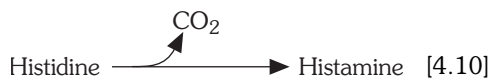
### Decarboxylases

The conversion of glutamate into  $\gamma$ -aminobutyrate (GABA) typifies the physiologically important decarboxylation reactions that lead to the formation of bioactive molecules such as neurotransmitters. The reaction below is catalysed by glutamate decarboxylase, a pyridoxal phosphate-dependent enzyme:



GABA acts as an inhibitory neurotransmitter in the central nervous system of higher animals. The inactivation of GABA is brought about by the action of GABA-glutamate transaminase resulting in the formation of succinate semialdehyde which is then oxidized to succinate by a specific dehydrogenase (Bradford, 1986).

The synthesis of histamine is also brought about by a decarboxylase. Specifically, histidine decarboxylase catalyses the reaction shown below to yield histamine:



Release of histamine by mast cells is a biochemical manifestation associated with allergic enteropathy and other gut disorders (Piva *et al.*, 2002).

Another key decarboxylase initiates the synthesis of polyamines, molecules that are essential in the regulation of cell growth and differentiation. The enzyme concerned is ornithine decarboxylase (ODC).

### Phenylalanine hydroxylase

Hydroxylases play a key role in animal metabolism and no account of amino acid

pathways would be complete without reference to phenylalanine hydroxylase, which catalyses the formation of tyrosine from phenylalanine. Animals can thus synthesize tyrosine for important reactions as long as sufficient quantities of phenylalanine are present in the diet. Tyrosine is a component of proteins, and provides the aromatic ring for the synthesis of thyroxine, adrenaline (epinephrine) and noradrenaline (norepinephrine).

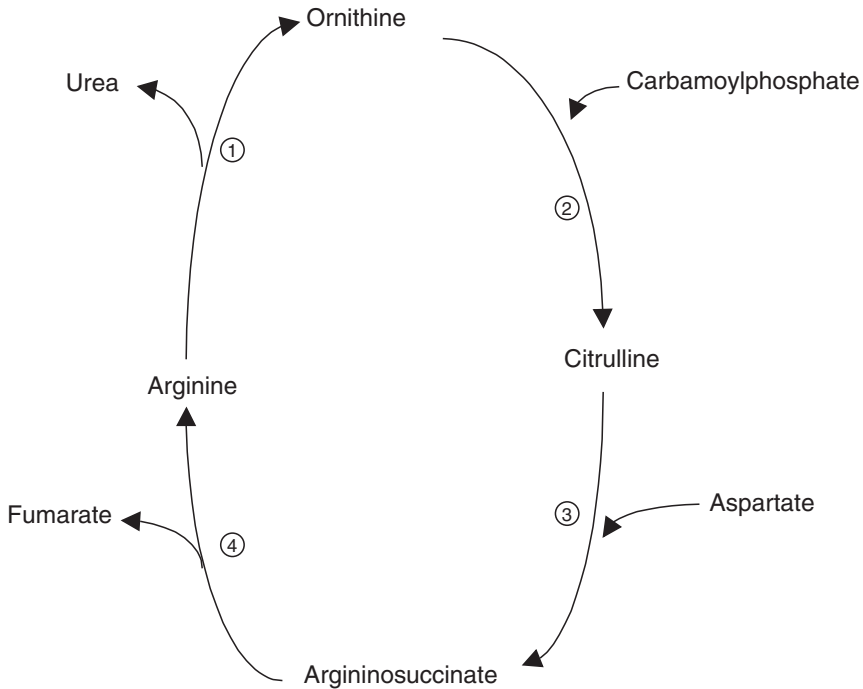
### Arginine Metabolism

Arginine has only comparatively recently emerged as an intriguing amino acid in animal metabolism. Following the establishment of its pivotal role in the urea cycle in the 1930s, arginine remained in the background for many decades. It was not until the 1990s that important developments were made with respect to its function as a precursor of polyamines and nitric oxide (NO). Many authors have yet to record these developments in their biochemistry textbooks.

### Urea cycle

In the urea cycle (Fig. 4.2), the metabolism of arginine, ornithine, citrulline and argininosuccinate is linked in a pathway that enables mammals to dispose of excess N from amino acids that cannot be used for anabolic purposes. The liver is the primary site for this activity. Waste N enters the urea cycle as carbamoyl phosphate, synthesized from ammonia,  $\text{CO}_2$  and ATP as indicated in Reaction [4.7]. However, waste N also enters the cycle directly, via aspartic acid. Long after the elucidation of the urea cycle, it emerged that arginase exists in two forms depending on localization within cells. Arginase I is a cytosolic enzyme whereas arginase II occurs in the mitochondria. Many extrahepatic tissues contain both forms of arginase, including the mammary gland (O'Quinn *et al.*, 2002). The absence of other enzymes of the urea cycle in the mammary gland is consistent with





**Fig. 4.2.** The urea cycle. Key to enzymes: 1, arginase; 2, ornithine transcarbamoylase; 3, argininosuccinate synthetase; 4, argininosuccinase.

the concept that a pivotal role for arginine is the generation of proline (Basch *et al.*, 1997), polyamines (Wu *et al.*, 1998) and NO (Lacasse *et al.*, 1996) for optimal lactational performance. Remnants of the urea cycle may also be found in birds and reptiles, despite their reliance on uric acid as the major route of disposal of waste N. Thus arginase is found in the liver and kidney of birds, with higher activity in the latter organ. Avian kidney arginase is sensitive to dietary arginine status and antagonisms caused by lysine and certain other analogues (Chapter 7).

The reaction is catalysed by various isoforms of NO synthase localized in specific compartments (Onoda and Inano, 1998). Thus, inducible (iNOS) and constitutive (cNOS) forms have been identified in the cytosol of porcine mammary gland (O'Quinn *et al.*, 2002). The cNOS isoforms are always present and generate intermittent low levels of NO. On the other hand, iNOS is activated by cytokines and endotoxins, and following induction, produces large and sustained quantities of NO. Barouch *et al.* (2002) referred to spatial confinement of neuronal and endothelial isoforms allowing NO signals to exert independent and even opposite effects on organ function.

### Nitric oxide

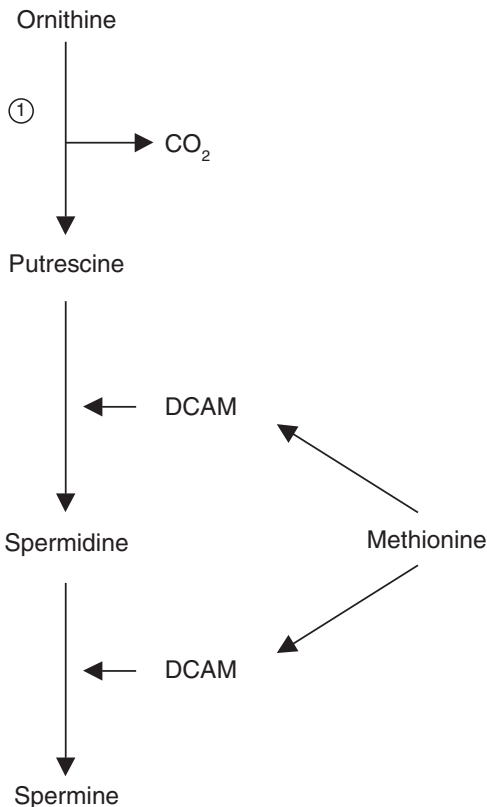
The synthesis of nitric oxide (NO) from arginine is depicted as follows:



### Polyamines

Reference has already been made to ODC, a key enzyme in polyamine synthesis. ODC acts on ornithine to yield the initial product,

putrescine. Inputs from methionine then allow for the synthesis of spermidine and spermine (Fig. 4.3). Polyamine production appears to be an essential adjunct in all tissues that are actively synthesizing proteins. For example, polyamines act as mediators in the histological development of enterocytes (Piva *et al.*, 2002). Polyamine synthesis is also an important focal point for the action of certain antinutritional factors in legume seeds. In addition, the involvement of methionine in polyamine synthesis imposes competing metabolic demands, particularly when the tissue supply of cysteine is critical.



**Fig. 4.3.** Action of ornithine decarboxylase in the initiation of polyamine synthesis. Key: 1, ornithine decarboxylase; DCAM, decarboxylated 5-adenosylmethionine.

## Analogues

A number of amino acid analogues occur naturally in plants used as sources of animal feed. These are structural analogues of certain nutritionally important amino acids. Canavanine contributes significantly to the toxicity of the seeds of the tropical legume, *Canavalia ensiformis* (jack bean). Poultry are particularly sensitive to the effects of canavanine since it is a structural analogue of arginine, an essential amino acid for avian species (see Table 1.1). In mammals, canavanine may be processed via a pathway that is analogous to the urea cycle (Fig. 4.4).

The aromatic amino acid, mimosine, is an important toxic component of the tropical forage legume, *Leucaena leucocephala*. Although mimosine may be regarded as an analogue of tyrosine, the adverse effects appear not to be mediated via any antagonism between the two amino acids. The pathways of mimosine metabolism have been extensively studied in the ruminant (Fig. 4.5) due to the widespread use of *Leucaena* as fodder.

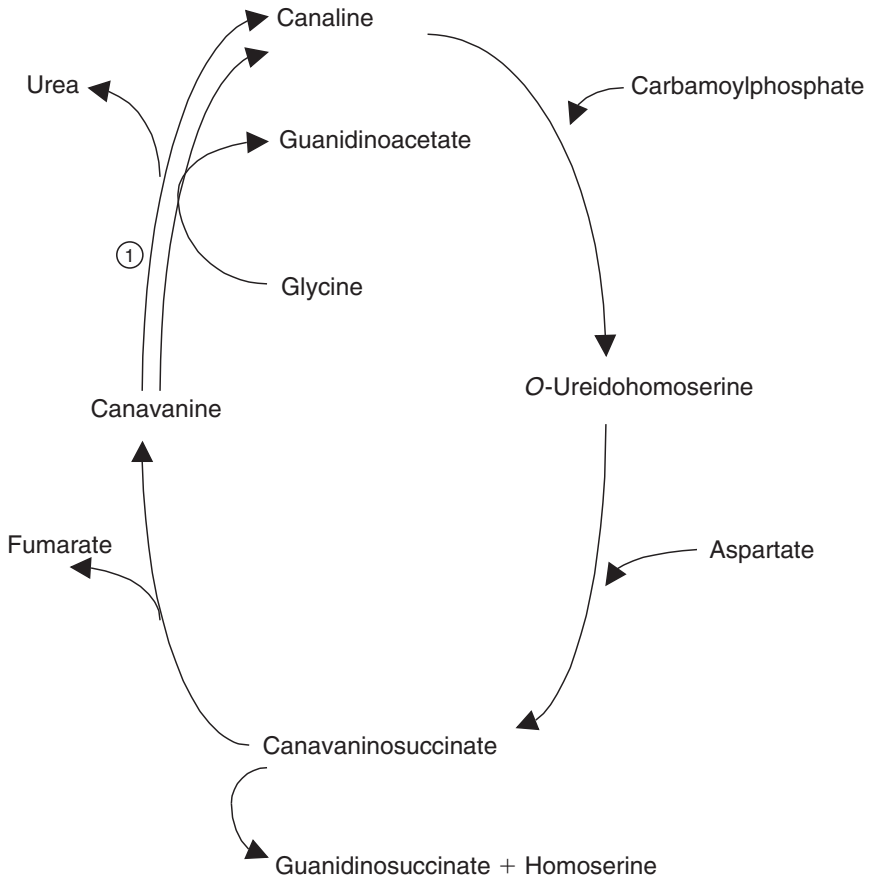
The toxic effects of a number of amino acid analogues including canavanine and mimosine are considered in detail in Chapter 7.

## Uric Acid Pathway

The uric acid pathway is a major route for the disposal of waste N in avian species. In these animals, the purine biosynthetic pathway has been adapted for the purpose of N excretion in the form of uric acid (Fig. 4.6). The committed reaction in the synthesis of uric acid is the production of 5-phosphoribosylamine from glutamine and 5-phosphoribosyl-1-pyrophosphate. Glycine, another mole of glutamine, and aspartate act as further sources of N in the sequence shown in Fig. 4.6.

## Pyrimidines

The synthesis of pyrimidines also involves glutamine and aspartate (Fig. 4.7). However, in contrast to the synthesis of purines, the



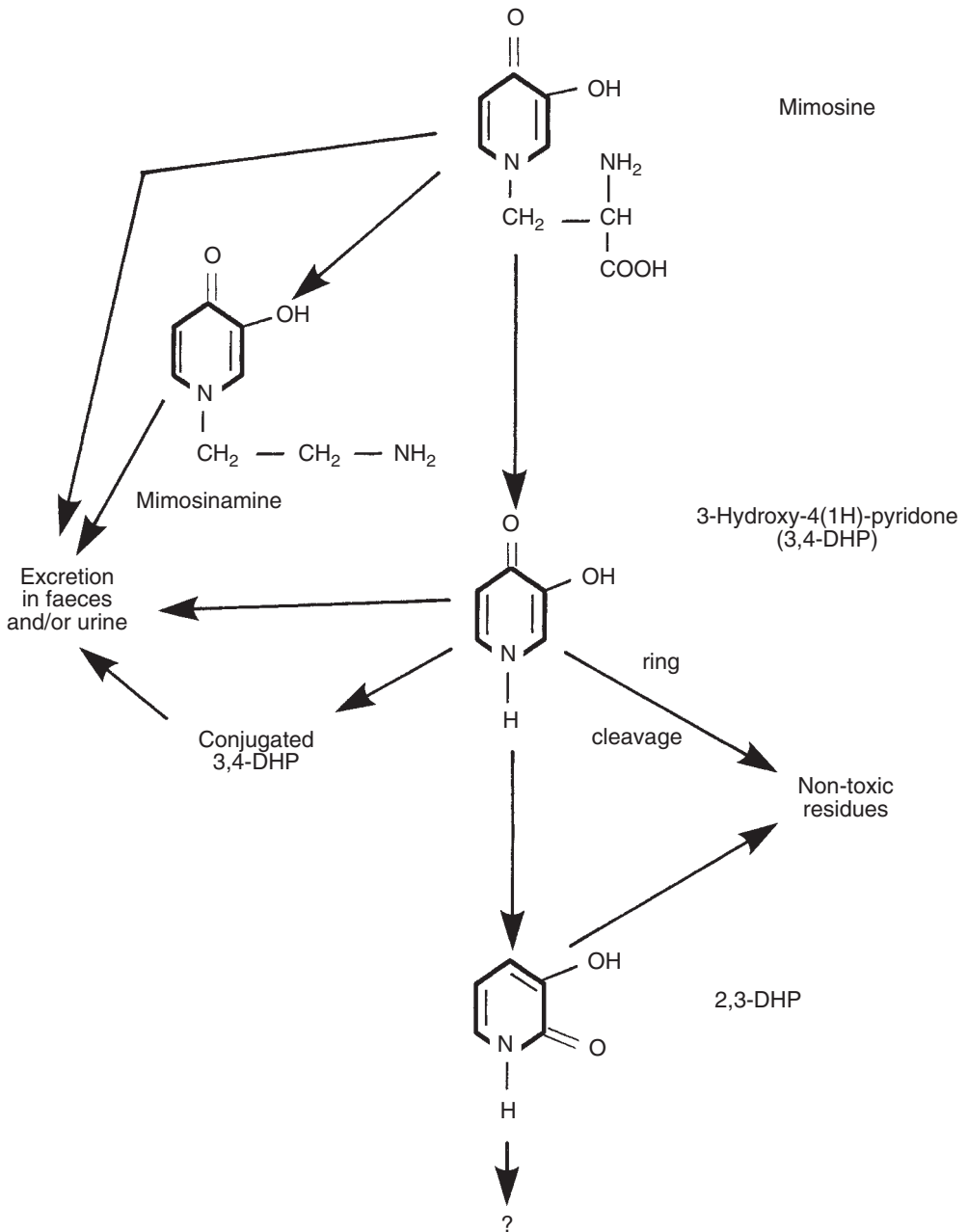
**Fig. 4.4.** Mammalian metabolism of canavanine. Enzymes: analogous to those involved in the urea cycle; thus 1, arginase. (Adapted from D'Mello, 1991.)

pyrimidine ring is assembled first and subsequently linked to ribose phosphate. It will be noted that pyrimidine synthesis begins with the production of carbamoyl phosphate. The enzyme, carbamoyl phosphate synthetase is distinct from that involved in the formation of urea, thus enabling all species, including uricotelic animals to generate the pyrimidines necessary for nucleotide production. The committed reaction in the pyrimidine pathway is formation of *N*-carbamoylaspartate.

### Sulphur Amino Acids

The sulphur amino acids of particular relevance here are methionine and cysteine. In

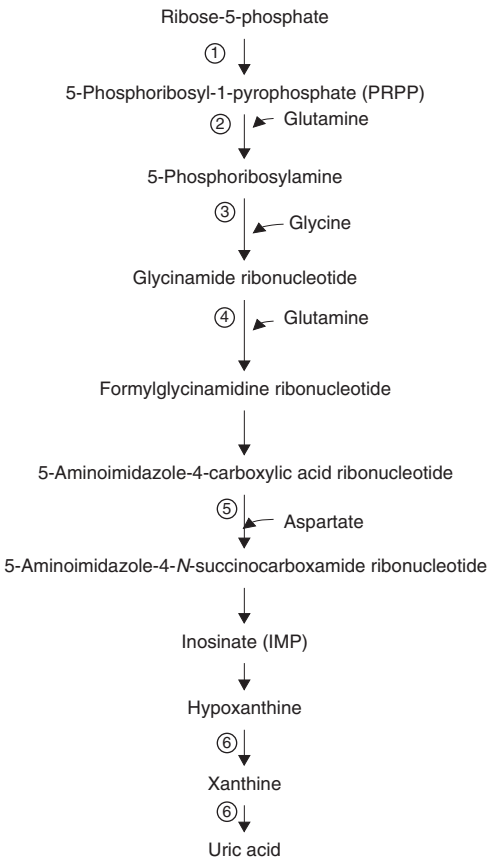
proteins, 2 mol of cysteine may undergo oxidation to form a disulphide bridge, yielding another sulphur amino acid, cystine. Methionine plays a key role in metabolism as a donor of active methyl groups. It does so after conversion into *S*-adenosylmethionine. Following release of the active methyl group, *S*-adenosylhomocysteine is formed which may then undergo hydrolysis to produce homocysteine. The importance of homocysteine in human health has recently been recognized following demonstrations of elevated plasma levels of the amino acid in patients with coronary, cerebrovascular and peripheral arterial occlusive disease. In addition, the role of homocysteine in embryonic development may have implications in animal



**Fig. 4.5.** Mimosine metabolism in the ruminant (D'Mello, 1991).

reproduction. The 'homocysteine as a teratogen' hypothesis has been tested partly by employing a chicken embryo model (Rosenquist and Finnell, 2001).

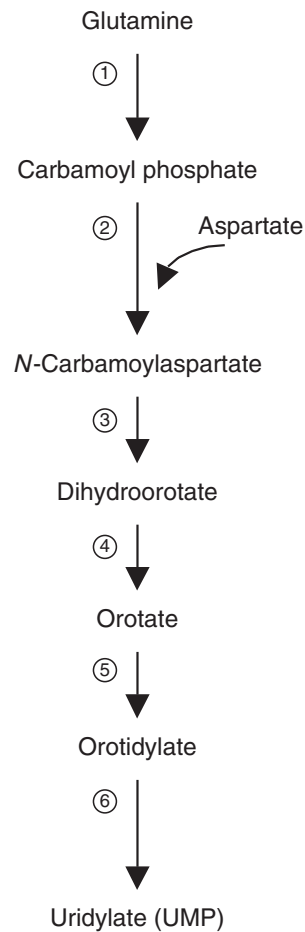
The biosynthesis of cysteine from methionine relies on the initial formation of homocysteine which then donates its sulphur atom to serine to yield cystathionine.



**Fig. 4.6.** Uric acid synthesis (an abbreviated pathway to show key reactions involving inputs of amino acid N). Enzymes: 1, ribose 5-phosphate pyrophosphokinase; 2, glutamine phosphoribosyl pyrophosphate amidotransferase; 3, phosphoribosyl glycinamide synthetase; 4, amido-ligase; 5, specific synthetase; 6, xanthine oxidase.

Following deamination and molecular cleavage, cysteine and  $\alpha$ -ketobutyrate are produced. This pathway underpins an important nutritional relationship and is depicted in Chapter 8. The competing metabolic demands for methionine are considered in some depth in Chapter 17.

Particular note should be made of the roles of the B-complex vitamins that service methionine and homocysteine metabolism. Thus, methionine synthesis from homocysteine requires the tissue presence of FAD, tetrahydrofolate and cobalamin, whereas the synthesis of cystathionine from homocysteine



**Fig. 4.7.** Biosynthesis of pyrimidines. Enzymes: 1, carbamoyl phosphate synthetase; 2, aspartate transcarbamoylase; 3, dihydroorotase; 4, dihydroorotate dehydrogenase; 5, orotate phosphoribosyltransferase; 6, orotidylate decarboxylase.

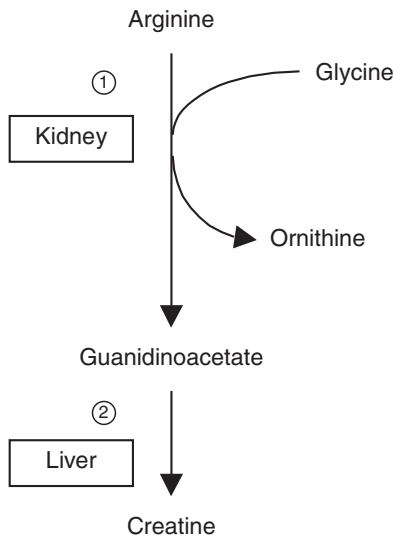
requires pyridoxal phosphate as cofactor (Stabler *et al.*, 1996).

### Non-essential Amino Acids

Examination of Reactions [4.1], [4.5], [4.6] and [4.9] shows the pivotal role of glutamate in animal metabolism and function, enabling the synthesis and breakdown of amino acids and the production of GABA. However, it is important to recognize that

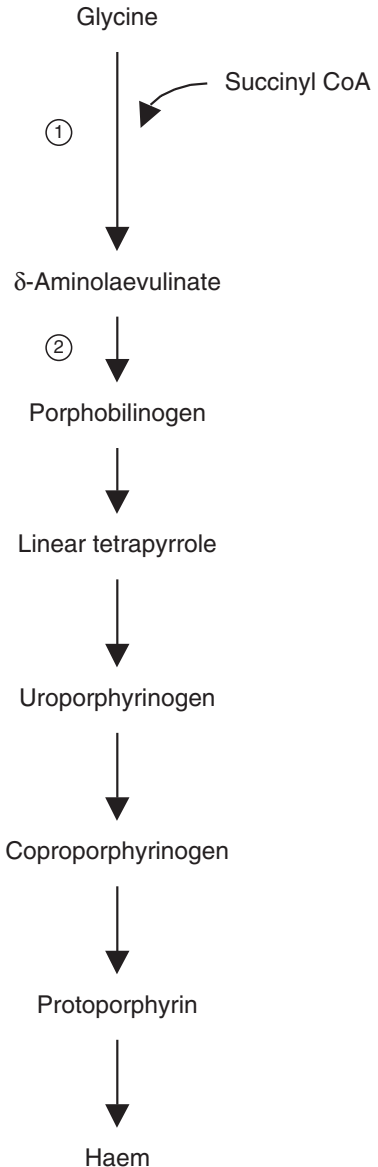
glutamate itself is part of the amino acid neurotransmitter system (Bradford, 1986). The critical roles of this non-essential amino acid should, therefore, not be underestimated. Indeed, it has been suggested that several of the non-essential amino acids may become conditionally essential because endogenous synthesis cannot satisfy immediate requirements under certain conditions. Thus, stress caused by disorders of pregnancy and lactation and microbial pathogens may induce the need for these amino acids. In this respect, the case for glutamine is particularly convincing. It serves as a precursor of purines (Fig. 4.6), pyrimidines (Fig. 4.7) and amino sugars. It is also the preferred fuel for the cellular metabolism of intestinal mucosa and an obligate nutrient for the immune system (Nieto *et al.*, 2002). Other functions include involvement in the maintenance of acid–base balance, prevention of peripheral hyperammonaemia and regulation of cellular macronutrient metabolism.

Glycine is another amino acid associated with multifunctional roles, being involved in the synthesis of purines (Fig. 4.6), creatine (Fig. 4.8) and haem (Fig. 4.9).



**Fig. 4.8.** Biosynthesis of creatine from arginine and glycine. Enzymes: 1, transamidinase; 2, guanidinoacetate methyltransferase.

Creatine supplements may exert beneficial effects on pork quality (James *et al.*, 2002). Together with aspartate, glycine is a component of the amino acidergic system of neurotransmitters.



**Fig. 4.9.** Biosynthesis of haem from glycine. Enzymes: 1,  $\delta$ -aminolaevulinate synthetase; 2,  $\delta$ -aminolaevulinate dehydrase.

The critical functions displayed by the non-essential amino acids means that they must be synthesized from essential amino acids and/or derived from dietary sources. Optimum ratios of the essential to non-essential amino acids exist for particular functions and species of animals (Chapter 6).

### Neurotransmitters

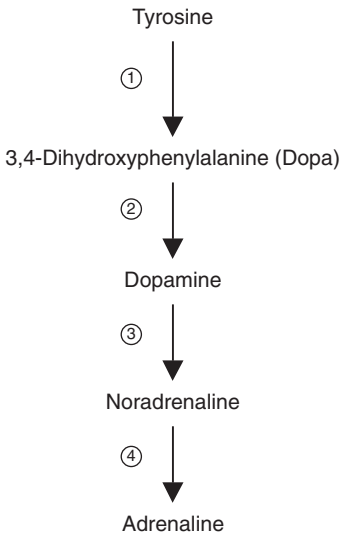
A wide range of amino acids and their derivatives act as neurotransmitters (Table 4.3).

Amino acids directly involved in this function are classified within the amino acidergic system, whereas those derived from the aromatic amino acids and tryptophan are categorized within the monoaminergic system (Bradford, 1986).

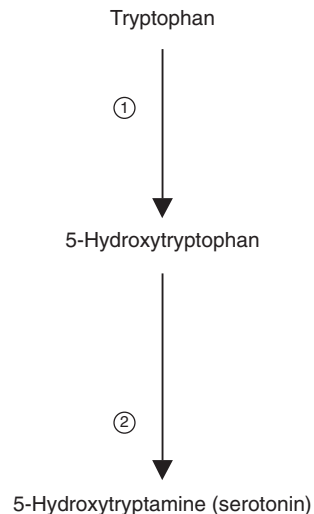
The synthesis of GABA from glutamate has already been shown [Reaction 4.9]. The formation of dopamine and noradrenaline from tyrosine and of serotonin from tryptophan respectively are depicted in Figs 4.10 and 4.11.

**Table 4.3.** Amino acids and their derivatives as neurotransmitters: definitive and proposed compounds.

Group/precursor	Specific compound	Action
Amino acids	$\gamma$ -Aminobutyrate (GABA)	Inhibitory
	Glutamate	Excitatory
	Aspartate	Excitatory
	Glycine	Inhibitory
	Histamine	Classical neurotransmitter; immunomodulator
Arginine Biogenic amines	Taurine	Modulator of neuronal activity
	Nitric oxide (NO)	Multifunctional
	Dopamine	Excitatory and inhibitory
	Noradrenaline	Excitatory and inhibitory
	Serotonin (5-hydroxytryptamine)	Vasoconstrictor and stimulator of smooth muscle contraction



**Fig. 4.10.** Synthesis of noradrenaline and adrenaline from tyrosine. Enzymes: 1, tyrosine hydroxylase; 2, aromatic decarboxylase; 3, dopamine- $\beta$ -hydroxylase; 4, transmethylease.

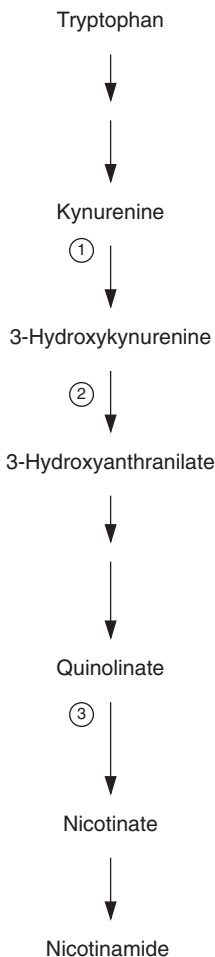


**Fig. 4.11.** Synthesis of 5-hydroxytryptamine from tryptophan. Enzymes: 1, tryptophan 5-monoxygenase; 2, 5-hydroxytryptophan decarboxylase.

## Other Bioactive Molecules

In addition to being a source of serotonin, tryptophan uniquely serves as a precursor of a B-complex vitamin, nicotinamide or niacin (Fig. 4.12). However, the relatively low efficiency of this pathway means that for all practical purposes an exogenous supply of the vitamin is necessary to satisfy metabolic demands.

The hormone thyroxine is synthesized from tyrosine. It is, effectively, a dimer composed of two iodinated residues of tyrosine. Adrenaline is formed by methylation of noradrenaline (Fig. 4.10) by a reaction that is dependent on the participation of *S*-adenosylmethionine.



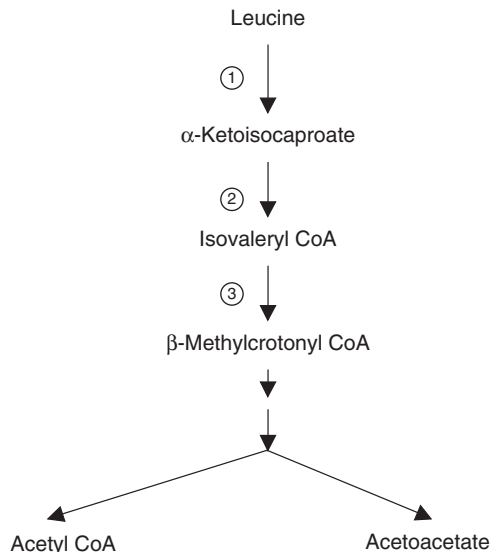
**Fig 4.12.** Biosynthesis of nicotinamide from tryptophan. Enzymes: 1, kynurenine 3-oxygenase; 2, kynureninase; 3, quinolinolate transphosphoribosylase.

## Path of Carbon in Amino Acid Catabolism

In the catabolism of amino acids, the carbon skeletons follow pathways leading to the formation of glucose and/or ketones. Amino acids may be glucogenic, ketogenic or both (Chapter 1). The process of ketogenesis from leucine is shown in Fig. 4.13. It will be noted that leucine is exclusively ketogenic. Lysine is also ketogenic (Fig. 4.14); however, it should be noted that lysine itself does not participate in transamination. On the other hand, two separate transamination reactions are involved in the catabolism of cysteine leading to the glucogenic precursor, pyruvate (Fig. 4.15). The pathways of gluconeogenesis and ketogenesis from amino acids have been elucidated and are presented in Fig. 4.16. The key intermediate in the synthesis of glucose is phosphoenolpyruvate.

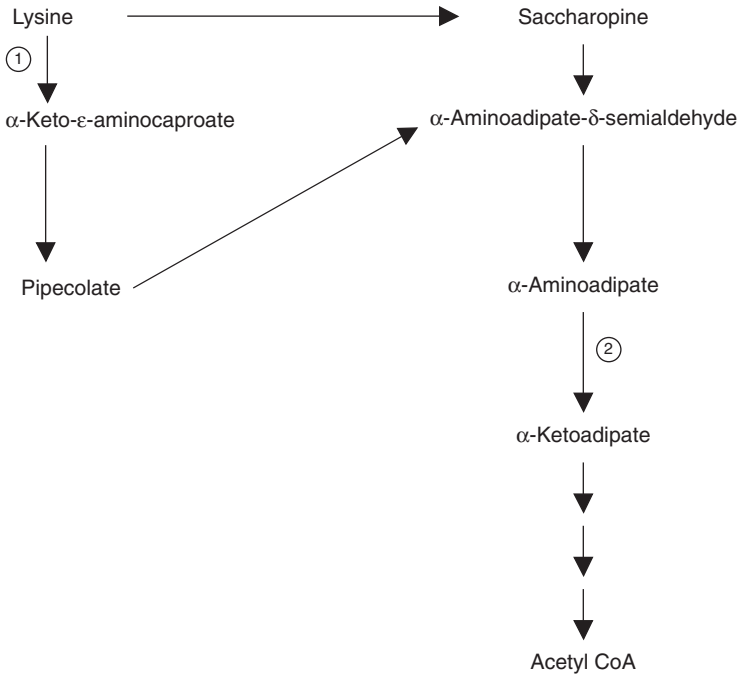
## Summary

The pathways described in this chapter highlight the roles of several amino acids in animal metabolism. Arginine is a key

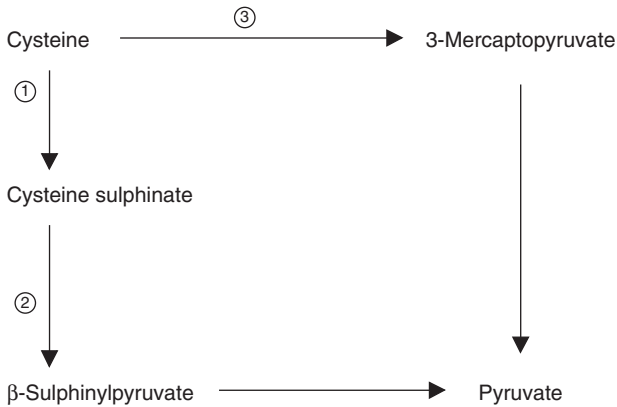


**Fig. 4.13.** Degradation of leucine. Enzymes: 1, branched-chain aminotransferase; 2, decarboxylase; 3, dehydrogenase.





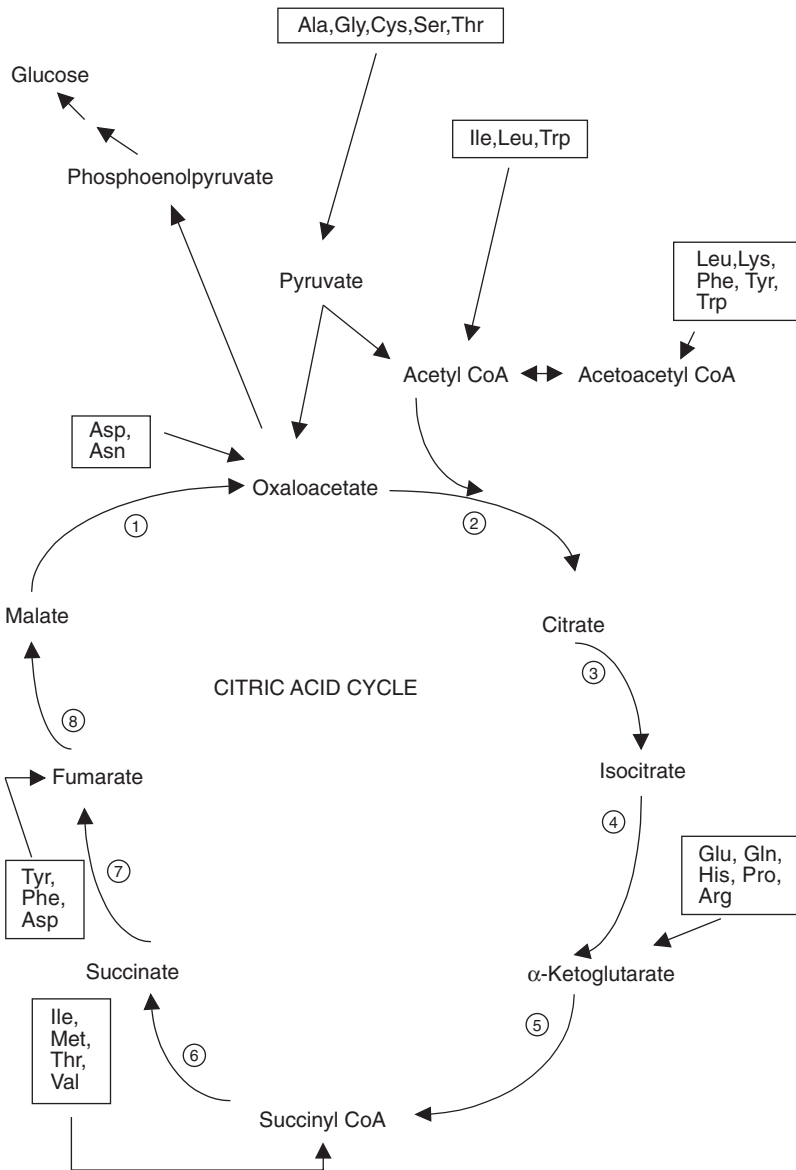
**Fig. 4.14.** Degradation of lysine. Enzymes: 1, L-amino acid oxidase; 2, specific aminotransferase.



**Fig. 4.15.** Catabolism of cysteine. Enzymes: 1, cysteine dioxygenase; 2, transaminase; 3, transaminase.

intermediate in the urea cycle, enabling mammals to dispose of waste nitrogen. However, interest in arginine has recently been revived following demonstration of its involvement in the production of polyamines and nitric oxide. Together with glycine, arginine also contributes to the formation of creatine. In poultry, waste nitrogen is disposed

of as uric acid, a purine synthesized from glycine, glutamine and aspartate. The latter two amino acids are involved again in the biosynthesis of the pyrimidine ring, whereas glycine is the starting molecule in the production of haem. In addition, both glycine and aspartate act as inhibitory neurotransmitters. Tyrosine and tryptophan are precursors in



**Fig. 4.16.** Gluconeogenesis and ketogenesis from amino acids. Asn, asparagine; Asp, aspartate; Cys, cysteine; Gln, glutamine; Glu, glutamate; Gly, glycine; His, histidine; Ile, isoleucine; Leu, leucine; Lys, lysine; Met, methionine; Phe, phenylalanine; Pro, proline; Ser, serine; Thr, threonine; Trp, tryptophan; Tyr, tyrosine; Val, valine. Enzymes: 1, malate dehydrogenase; 2, citrate synthase; 3, aconitase; 4, isocitrate dehydrogenase; 5,  $\alpha$ -ketoglutarate dehydrogenase complex; 6, succinyl CoA synthetase; 7, succinate dehydrogenase; 8, fumarase.

the production of neuroactive biogenic amines. Tryptophan is also a source of the B-complex vitamin, nicotinamide. Finally, the involvement of methionine in polyamine syn-

thesis and in the activated methyl cycle imposes competing metabolic demands, particularly when the tissue supply of cysteine is critical.

---

## References

- Baker, D. (1994) Utilization of precursors for L-amino acids. In: D'Mello, J.P.F. (ed.) *Amino Acids in Farm Animal Nutrition*. CAB International, Wallingford, UK, pp. 37–61.
- Barouch, L.A., Harrison, R.W., Skaf, M.W., Rosas, G.O., Cappola, T.P., Kobeissi, Z.A., Hobai, I.F., Lemmon, C.A., Burnett, A.L., O'Rourke, B., Rodriguez, E.R., Huang, P.L., Lima, J.A.C., Berkowitz, D.E. and Hare, J.M. (2002) Nitric oxide regulates the heart by spatial confinement of nitric oxide synthase isoforms. *Nature* 416, 337–340.
- Basch, J.J., Wickham, E.D. and Farrell, H.M. (1997) Arginase in lactating bovine mammary glands; implications in proline synthesis. *Journal of Dairy Science* 80, 3241–3248.
- Bradford, H.F. (1986) *Chemical Neurobiology*. W.H. Freeman, New York, 507 pp.
- D'Mello, J.P.F. (1991) Toxic amino acids. In: D'Mello, J.P.F., Duffus, C.M. and Duffus, J.H. (eds) *Toxic Substances in Crop Plants*. The Royal Society of Chemistry, Cambridge, pp. 21–48.
- Harper, A.E., Miller, R.H. and Block, K.P. (1984) Branched-chain amino acid metabolism. *Annual Review of Nutrition* 4, 409–454.
- James, B.W., Goodband, R.D., Unruh, J.A., Tokach, M.D., Nelssen, J.L., Dritz, S.S., O'Quinn, P.R. and Andrews, B.S. (2002) Effect of creatine monohydrate on finishing pig growth performance, carcass characteristics and meat quality. *Animal Feed Science and Technology* 96, 135–145.
- Lacasse, P.V.C., Farr, S.R., Davis, S.R. and Prosser, C.G. (1996) Local secretion of nitric oxide and the control of mammary blood flow. *Journal of Dairy Science* 79, 1369–1374.
- Nieto, R., Obitsu, T., Fernandez-Quintela, A., Bremner, D., Milne, E., Calder, A.G. and Lobley, G.E. (2002) Glutamine metabolism in ovine splanchnic tissues: effects of infusion of ammonium bicarbonate or amino acids into the abomasum. *British Journal of Nutrition* 87, 357–366.
- Onoda, M. and Inano, H. (1998) Localization of nitric oxide synthase and nitric oxide production in the rat mammary gland. *Journal of Histochemistry and Cytochemistry* 46, 1269–1278.
- O'Quinn, P.R., Knabe, D.A. and Wu, G. (2002) Arginine catabolism in lactating porcine mammary tissue. *Journal of Animal Science* 80, 467–474.
- Piva, A., Prandini, A., Fiorentini, L., Morlacchin, M., Galvano, F. and Luchansky, J.B. (2002) Tributyrin and lactitol synergistically enhanced the trophic status of the intestinal mucosa and reduced histamine levels in the gut of nursery pigs. *Journal of Animal Science* 80, 670–680.
- Rosenquist, T.H. and Finnell, R.H. (2001) Genes, folate and homocysteine in embryonic development. *Proceedings of the Nutrition Society* 60, 53–61.
- Seal C.J. and Parker D.S. (2000) Inter-organ amino acid flux. In: D'Mello, J.P.F. (ed.) *Farm Animal Metabolism and Nutrition*. CAB International, Wallingford, UK, pp. 49–63.
- Stabler, S.P., Lindenbaum, J. and Allen, R.H. (1996) The use of homocysteine and other metabolites in the specific diagnosis of vitamin B-12 deficiency. *Journal of Nutrition* 126, 1266S–1272S.
- Wu, G., Pond, W.G., Flynn, S.P., Ott, T.L. and Bazer, F.W. (1998) Maternal dietary protein deficiency decreases nitric oxide synthase and ornithine decarboxylase activities in placenta and endometrium of pigs during early gestation. *Journal of Nutrition* 128, 2395–2402.

# 5 Amino Acid Metabolism in Animals: an Overview

**B.J. Bequette\***

*Department of Animal and Avian Sciences, University of Maryland, College Park,  
Maryland, USA*

---

## Introduction

It is well recognized by nutritionists that the quantity and quality (amino acid profile) of dietary proteins are important for optimum productivity and health of animals. The roots of protein–amino acid metabolism and nutrition can be traced back nearly 250 years ago to the work of several groundbreaking researchers. In the mid-1700s, von Haller recognized the essentiality of a substance in the diet for the renewal of blood and tissues. Many years later the true essentiality of this nitrogenous substance was confirmed by Magendie (1816) in feeding trials in dogs. Subsequently, upon the suggestion of Berzelius, the substance was officially introduced as ‘proteine’ by Mulder (1838). Nearly a century later, Mendel and Osborne (1914–1916), noting that vegetable proteins differed significantly from animal proteins in amino acid composition, questioned whether plant proteins were nutritionally inferior. Using some of the first-ever purified diets, they demonstrated the importance of amino acid composition as a determinant of protein quality, and examples of three types of amino acids: one that could not be synthesized and is needed almost entirely for growth (lysine), one needed for maintenance and for growth (tryptophan), and one that could be synthesized

and is not limiting (glycine). Since that time, similar experimental approaches have been used to establish amino acid essentiality, and non-essentiality, most notably those of W.C. Rose and colleagues beginning in 1930.

The work of Rudolph Schoenheimer and colleagues (1939–1942) provided another major paradigm shift in the history of protein nutrition. Earlier, Folin (1903) had argued that nitrogen metabolism could be distinctly divided into endogenous (tissue) and exogenous (dietary) phases and that exchange between diet and tissues only occurred to replace damaged tissue. Employing the stable isotope ( $^{15}\text{N}$ ,  $^2\text{H}$ ) labelled compounds that his colleague Harold Urey had recently isolated, Schoenheimer and colleagues demonstrated that not only were body proteins dynamic (continually synthesized and degraded), but also that the rates of turnover and partition of amino acid nitrogen varied between tissues and organs. Schoenheimer’s dynamic concept had dispelled Folin’s views, and today we can see extensions of Schoenheimer’s concept in many aspects of metabolism, including the genome. Their studies also demonstrated the extensive exchange of nitrogen between amino acids (transamination), in particular those occurring in the liver, confirming the central location of the hepatic ornithine–urea cycle (Fig. 4.2), discovered earlier by Krebs and Henseleit in 1932.

\*E-mail address: bbequett@wam.umd.edu

These landmark studies clearly demonstrated that protein and amino acid requirements are a function of the metabolic demand of the animal's tissues and the processes within the tissues. Moreover, they showed how these processes contribute to how efficiently (or inefficiently) the diet can be used to satisfy the metabolic demand. Current nutrient requirement schemes reflect this concept. For example, amino acid requirements are subdivided into net requirements for maintenance services, which are the first priority, and for growth, lactation and reproduction. In growing animals, the nutrient requirement schemes reflect the fact that the main role of amino acids, in particular the classical essentials, is as precursors for synthesis of proteins. Thus, a major component of the dietary requirement for amino acids is largely determined by the composition of the proteins accreted (e.g. muscle, fetal tissues) or secreted (caseins). In recent years, we have also come to realize the significance of amino acids, not only in terms of their nutritional availability for growth, but also their metabolic and functional roles in growth, protein and energy deposition, and in health maintenance functions.

This chapter will not attempt to present a comprehensive review of amino acid and protein metabolism in animals as this would require a book itself. However, there are basic pathways of amino acid metabolism common to all species (see Chapter 4), either because of their phylogeneticity or because of the similar types of foods they consume, which provide a common link to amino acid nutrition. From this basis it is possible to explain the subtle differences that often become amplified in terms of nutritional requirements of animals throughout their life cycles. In an attempt to bring the reader up to date with some of the more recent and interesting research findings, it is necessary to start with first principles in the nutritional classification of amino acids. What follows is a discussion of amino acids in terms of comparative requirements of animals, synthesis and catabolism, roles in intermediary nitrogen and energy metabolism, roles in health and disease, regulators of protein metabolism, and protein effi-

ciency and environmental pollution. Lastly, in view of the current situation, I will offer perspectives on the challenges ahead and the lead role that amino acid nutrition and metabolism will be expected to take in this, the postgenomic era.

### **Biosynthesis of Amino Acids and Nutritional Classifications**

The title of this book now reflects the fact that, in addition to traditional farm animal species, additional chapters have been included to address the amino acid nutrition of cats and fishes. In light of this, it is necessary to revisit the classification of amino acids in the context of the physiological state of each species in question, the productive and health management goals and how this influences our nutritional decisions (see Chapter 1). There are 20 amino acids commonly found in animal proteins, and all of these are incorporated into proteins as the L-isomer. As nutritionists, we use the terms essential and indispensable, and non-essential and dispensable, interchangeably. An important qualifier here is that these categories were initially established for growth, indeed rapid growth. For growing mammals, birds and fishes, the essential amino acids 'required' in the diet will be dominated by the composition of the proteins accreted (e.g. skeletal proteins in growing animals and fishes) or secreted (e.g. milk proteins in lactating animals, eggs in birds). The original definition by W.C. Rose and colleagues (Borman *et al.*, 1946) had this in mind when they defined an essential amino acid as, 'One which cannot be synthesized by the animal organism out of materials ordinarily available to the cells at a speed commensurate with the demands for normal growth'. Table 1.1 shows the nutritional classifications of the 20 amino acids commonly found in animal tissue proteins plus non-protein amino acids that fall into conditional classifications.

Nutritional essentiality has sometimes been misinterpreted to mean that the animal is incapable of synthesizing it. In order to clarify, it must be pointed out that in monogastric species the context of nutritional essentiality relates directly to the diet

whereas in ruminants essentiality relates to the supply of amino acid leaving the rumen, which is composed mostly of microbial proteins with variable contributions from undigested feed proteins. In the core essential group, the branched-chain amino acids, methionine and phenylalanine can be synthesized by animals from their corresponding keto-acids. However, the keto-acids can only be derived *de novo* from the original parent amino acid via transamination (see Chapter 4), and so there is no new or net synthesis, unless the corresponding keto-acid is provided in the diet. Racemic mixtures of D- and L-isomers of amino acids can provide a cheap source of supplemental amino acid to balance diets because the keto-acid that is produced following D-oxidase degradation has no racemic centre and so it can be reaminated to yield the L-isomer. Similarly, keto-acids can be supplemented in the diet to yield the corresponding L-isomer. The effectiveness of these supplementation strategies probably depends on the relative rates and affinities of the aminotransaminases and competing oxidative pathways. The same holds true for the original L-isomer. In light of this potential competition, it has been suggested that if the balance could be tilted in favour of transamination (i.e. reamination of the keto-acid), amino acids (their keto-acids) could be 'protected' from irrevocable catabolism (Lobley *et al.*, 2001). The main source of amino donors would be from glutamate or glutamine, both of which are found in millimolar concentrations within tissues. Transamination occurs with most amino acids except for lysine (Fig. 4.14) and threonine, whereas histidine transamination occurs to a limited extent.

Methionine can also be synthesized via remethylation of homocysteine but this also does not represent new synthesis since homocysteine itself originates from methionine. The methionine analogue 4-thiomethyl-2-hydroxybutanoic acid has been used effectively in pigs, poultry, and dairy cows. The advantage here is that the analogue is not toxic, as is methionine, and it readily diffuses across and into tissues. In sheep (Wester *et al.*, 2000), the analogue is converted into methionine via transamination, with the greatest contribu-

tions to tissue methionine occurring in the kidneys (22%) where there is abundant transaminase activity, followed by liver (14%) and the gastrointestinal tract (5–12%). The mammary gland is also a site of conversion with 20% of milk protein methionine derived from the analogue (Lobley and Lapierre, 2001). The ability of specific tissues to convert the analogue into methionine will depend on the relative activities of the transaminases and dehydrogenases (oxidation) within the tissues and, presumably, the adequacy of amino donors.

A recent finding that may influence requirements is that threonine and lysine, and to a lesser degree other amino acids, can be synthesized by microbes in the lumen of the small intestines and large bowel. On a gross basis this contribution may account for 1–20% of maintenance intake needs (Torrallardona *et al.*, 1996). At intakes well above maintenance, as in growing animals, this contribution is probably <5%. The intestinal microbial synthesis of amino acids is influenced by diet composition where the availability of precursors (ammonia, urea, amino acids, non-starch carbohydrates) in the small intestines determines the extent of microbial growth.

Rose (Borman *et al.*, 1946) defined non-essential amino acids as those that can be synthesized by the animal from materials normally available, and at a rate commensurate with normal growth. Reeds (2000) points out that, from a metabolic standpoint, the only truly non-essential amino acids are glutamate and serine. These can be synthesized from non-amino nitrogen (ammonium ions) and appropriate carbon skeletons derived from intermediates of glycolysis (3-phosphoglycerate) and the tricarboxylic acid cycle ( $\alpha$ -ketoglutarate). This should not be taken to infer that glutamate is not required in the diet. Indeed, diets devoid of glutamate have been shown to depress growth (Rose *et al.*, 1948), suggesting that under growing conditions the material normally available or its rate of synthesis may be limiting. All other non-essentials derive their amino group or carbon skeleton from other amino acids. In this connection, glutamate and serine play a central role because they are the primary precursors for non-essential amino acid synthesis.

## Comparative Amino Acid Requirements

In general, the animal nutritionist's goal is to maximize productivity in growing, lactating and egg-laying animals. In consequence, predictions of essential amino acid requirements are dominated by the composition of the proteins accreted or secreted. There is a remarkable consistency across species in the amino acid composition of mixed body proteins from fetal, growing and mature animals, suggesting that the minimal qualitative requirement for essential amino acids for growth will be similar. There are a few exceptions, however. In fish, the composition of tissues is also relatively constant across fish species, with the exceptions that lysine and arginine contents are higher in transgenic carp (Fu *et al.*, 2000), which may suggest that the requirements for these are higher. In sheep, as expected, wool is higher in the sulphur amino acids than average tissue proteins, but lower in lysine and histidine, supporting recommendations that the sulphur amino acid requirement for wool-producing sheep is higher (Chapter 17). Egg proteins appear to be similar in composition to body tissues except for lower levels of lysine in eggs. There appears to be a consistent composition of mature milk across several species (human, sows, horses, cows, goats) despite the fact that the whey and casein contents vary across species (Davis *et al.*, 1994). Compared to tissue, the composition of cow and sow milk protein is adequate in most amino acids to support growth of the suckling young, except that arginine and cysteine are lower in milk. In suckling pigs and preruminant calves, arginine supplementation has sometimes improved growth rate (Leibholz, 1982; Fligger *et al.*, 1997). Reduced feed intake during the early weaning period may exacerbate these deficiencies leading to bacterial translocation, gut atrophy, mucosal shedding and weight loss. Supplemental glutamate and glutamate plus arginine appear to reverse these affects by enhancing total gut weight and preventing villus atrophy (Ewtushik *et al.*, 2000). Glutathione plays an important role in maintaining the defence mechanisms of the gut

mucosa against peroxidative damage. Because glutamate, glycine and cysteine for glutathione synthesis are derived mainly from the gut lumen (Reeds *et al.*, 1997), glutathione synthesis may be penalized at the time of weaning when food intake is less than optimal.

There are metabolic differences between species that necessitate higher requirements for certain amino acids to support maximal growth, thus their designation as conditionally essential. One species difference relates to the expression of enzymes of the ornithine-urea cycle. This cycle serves to dispose of excess ammonia, and it also plays a critical role in the synthesis of the glutamate family of amino acids (proline, arginine, citrulline, ornithine), in particular arginine, which can be degraded to form urea and ornithine. The high activity of arginase in the liver of rapidly growing animals coupled with the low rate of intestinal arginine synthesis, limits arginine for protein synthesis (Wu *et al.*, 1997). Arginine is required in cat diets because they lack the enzymes to synthesize arginine and ornithine, plus they have a limited ability to convert glutamate into ornithine (Chapter 22). In the absence of these precursors, cats become comatose due to the build up of toxic ammonia. Symptoms can be reversed by supplementing the diet with arginine or its precursor ornithine. Chickens also need dietary arginine because they do not have a functional urea cycle and the situation is amplified because of the high content of arginine in feathers. Fish require higher amounts of arginine in the diet, not because they do not have a urea cycle, but because the main route of elimination of excess nitrogen is via ammoniogenesis (transdeamination and deamination routes). As a result, transfer of nitrogen into the ornithine cycle is low with limited synthesis of arginine. In marine cartilaginous fish, the arginine requirement is higher and this probably reflects the need to synthesize urea to help maintain buoyancy when salinity is low (Withers, 1998).

Another example of species-related requirements is taurine and phenylalanine/tyrosine in cats. Due to a limited ability to convert cysteine into taurine and the limited conservation of taurine via conjugation with cholic acid, young cats require dietary taurine

to prevent retinal degeneration (Chapter 22). Cats also require higher dietary levels of phenylalanine/tyrosine for melanin synthesis; otherwise, hair coat colour turns from black to reddish brown. Other species can convert phenylalanine into tyrosine via phenylalanine hydroxylase, but this has not proven to be a limitation. Wool growth in sheep is limited by the supply of cysteine. Although there is synthesis of cysteine locally within the wool follicle or skin via methionine transulphuration with serine, the supply of methionine from rumen microbial proteins is generally limited. Moreover, the transulphuration pathway in the skin may have to compete with polyamine synthesis and transmethylation reactions for methionine (Chapter 17).

### **Intermediary Metabolism of Amino Acids: Links to Energy Metabolism**

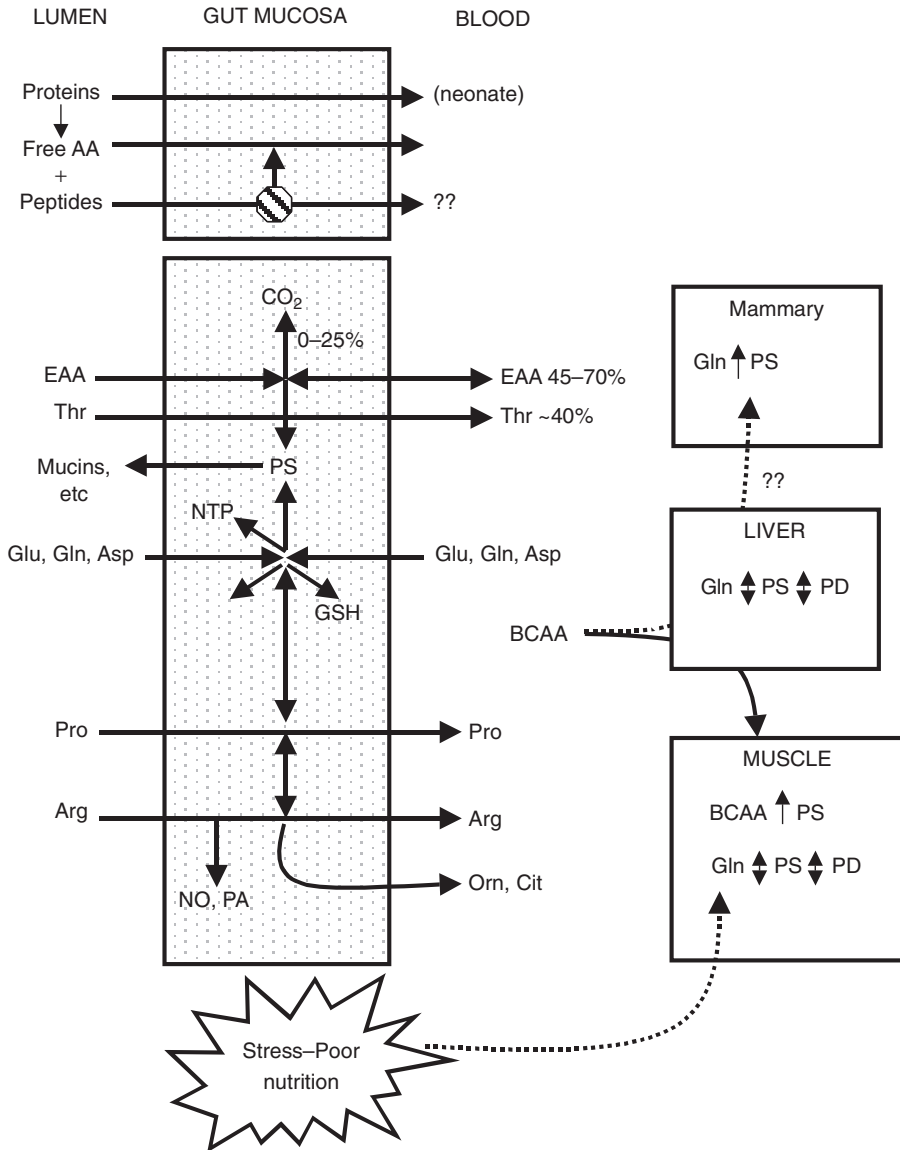
Enzymes for the catabolism and synthesis of amino acids are present in every tissue, but their levels of expression and activities vary in some species to suit the metabolic needs or functions of the tissue. Catabolism involves deamination/deamidation reactions with the resulting carbon skeleton reaminated to form non-essential amino acids or the carbon skeleton can be channelled into the tricarboxylic acid cycle where it is either oxidized, channelled towards gluconeogenesis via pyruvate carboxylase, or from pyruvate converted into acetate for fatty acid synthesis (see Chapter 4). The excess nitrogen (amino groups) is ultimately transaminated to form alanine, aspartate, glutamine or glutamate for entry into the ornithine cycle for urea or arginine synthesis. Metabolism in ruminants is orchestrated to conserve glucose, and so it is no surprise that amino acid carbon contributes 12–35% to gluconeogenesis (see Anison and Bryden, 1999). In early lactation when glucose demands for lactose synthesis are high, and where glucose-precursor (propionate) supply is low, the channelling of amino acid carbon towards gluconeogenesis is probably vital. Fish species are unique in this respect because their diets are generally high in protein and fatty acids, but low in carbohydrates, particularly in carnivorous fish. Fish have adapted to

use amino acids as the main substrates for gluconeogenesis and as the main oxidative fuel, especially in migratory fish, which may go for long periods without eating. Apart from dietary glucose and its immediate precursors (e.g. propionate in ruminants), all new glucose carbon derives from amino acid.

The intestines and the liver are the major sites of amino acid catabolic and synthesis (Fig. 5.1, see Wu, 1998). In all species examined to date, almost 100% of dietary glutamate, glutamine and aspartate are removed by the gastrointestinal tract (GIT) during absorptive metabolism, and further quantities are recycled from the blood supply to the GIT. Surprisingly, glucose contributes only 35% to oxidative metabolism of the GIT, with most of the remainder derived from amino acids (Reeds *et al.*, 1998). In consequence, glutamate, glutamine and alanine must be synthesized almost entirely by the animal to support protein synthesis and other metabolic functions (e.g. synthesis of purines, pyrimidines and glutathione). The fluxes of alanine, glutamine and glutamate are considerable. To support these fluxes, plus other metabolic functions, requires equivalent synthesis of glutamate, which consumes 4 mol of ATP per mole of glutamate. Reeds *et al.* (1998) estimated that synthesis of glutamate could account for 10% of maintenance energy expenditures.

Most often, dietary shortfalls in proline, arginine, glutamine and alanine can be made up through intestinal synthesis. High arginase activity in the liver plus the lack of a full complement of enzymes in the liver and kidney to synthesize citrulline (from glutamine, glutamate and proline) means that the intestine is the major site of net arginine and citrulline synthesis. Wu *et al.* (1997) estimated in post-weaning pigs that 50% of the arginine requirement for protein deposition must derive from intestinal synthesis. Sucking pigs have a limited ability to synthesize arginine from glutamate and proline, however, and on this basis arginine may become limiting. The gastrointestinal tract of the ruminant, in particular the rumen tissues, is also capable of synthesizing arginine. However, very little arginine synthesized in the gut reaches the peripheral tissues due to the high activity of





**Fig. 5.1.** A general schematic of amino acid metabolism by the gastrointestinal tract and regulation of peripheral tissue metabolism. Abbreviations: AA, amino acid; Arg, arginine; Asp, aspartate; BCAA, branched-chain amino acids; Cit, citrulline; EAA, essential AA; Gln, glutamine; Glu, glutamate; GSH, glutathione; NO, nitric oxide; NTP, nucleotides; Orn, ornithine; PA, polyamines; PD, protein degradation; Pro, proline; PS, protein synthesis; Thr, threonine; ??, mechanism not directly proven.

arginase in the hepatic urea cycle. The mammary gland is a site of extensive amino acid catabolism and biosynthesis (Bequette *et al.*, 1998). Arginine is extracted by the mammary gland in two- to threefold greater quantities than are required for milk protein synthesis.

Net contributions of arginine to nitric oxide and polyamine synthesis are negligible in most tissues, but no doubt important in the regulation of vasodilatation and for cell differentiation and proliferation. Arginase activity is abundant in the mammary gland, and so most

of the extra arginine is probably degraded to ornithine and, via ornithine aminotransferase, converted into proline or glutamate. Proline and glutamate uptake by the mammary gland is always less than required for milk protein synthesis and so the conversion of arginine into proline and glutamate would appear to provide a mechanism to supply these.

Nutritionally significant quantities of essential amino acids are removed by the gastrointestinal tract during absorptive metabolism. In pigs, the net appearance of essential amino acid in the portal vein (i.e. the main blood supply to the liver) represents only 40–80% of dietary supply (Stoll *et al.*, 1998). In ruminants, net appearance in the portal vein represents 55–77% of that disappearing from the small intestines (MacRae *et al.*, 1997). Threonine removal by the intestines is the highest, and it is likely that most of the threonine removed is directed at mucin synthesis since oxidation of threonine by the pig gut appears to be negligible (Burrin *et al.*, 2001). Lysine, leucine, and phenylalanine are oxidized to some extent by the pig gut (Stoll *et al.*, 1999), which appears to be in contrast with observations in sheep where only leucine is oxidized to a significant extent (Yu *et al.*, 2000; Lobley, 2001, personal communication). Studies in pigs indicate that oxidation of essential amino acids occurs only from the luminal side of the intestines, representing 2–5% of that available for absorption (van Goudoever *et al.*, 2000). Although 2–5% may seem insignificant, gut oxidation represents one-third of whole body oxidation, and thus gut metabolism has a major influence on whole body amino acid requirements (Burrin *et al.*, 2001). Endogenous secretions and abraded mucosal cells also account for a significant proportion of essential amino acid losses by the gut. Recent advances in stable isotope labelling techniques have allowed estimation of endogenous losses in pigs, sheep and cattle. Based on tracer estimates, there is a close relationship between endogenous losses and dry matter intake with losses in pigs and sheep very similar when adjusted for intake differences (25–39 g protein kg<sup>-1</sup> intake). Dietary factors, intestinal microbes and parasites will have a major impact on gastrointestinal metabolism, and, therefore, the nutritional requirement for amino acids.

## Amino Acids in Health and Disease States

For many years, feed antibiotics and anthelmintics have been used extensively to improve animal health and productivity. Recent links between antibiotic resistance in farm animals and in humans, and the gradual development of anthelmintic resistance, have pressured the agricultural industry to find alternative ways of achieving high levels of production and safe products from healthy animals. Nutritional supplements, so-called nutraceuticals, are being considered as a means to bolster the immune system, prevent muscle and lactational losses, and improve gastrointestinal defence mechanisms against invasive bacteria.

Glutamine, glutamate, arginine, threonine, and cysteine are involved in many maintenance functions; in particular, those of the immune surveillance system and in gut mucosal repair processes. The intestines represent the first barrier to food-borne antigens and bacteria. The high rate of protein turnover in the gut ensures that damaged tissues are rapidly shed. Large quantities of glutathione are synthesized by the gut for protection against oxidative damage (Jahoor *et al.*, 1995) and copious amounts of mucin are secreted to create a barrier to bacterial translocation. Mucosal cells and intraepithelial lymphocytes have an obligate requirement for glutamine as an energy source, and for the synthesis of other non-essential amino acids and nucleotide bases. The nutritional supply of glutamine may become limited at weaning or during intestinal stress due to the rapid turnover and replacement of mucosal cells. In weanling pigs, glutamine supplementation reduces jejunal villus atrophy and improves weight gain (Wu *et al.*, 1996), presumably by 'feeding' the gut and eliminating the need to breakdown muscle to supply the extra glutamine. In calves exposed to the K99+ virus, glutamine administration has proved an effective therapy (Brooks *et al.*, 1997). Equally, however, there have been null effects of glutamine supplementation in similar pig disease models and in sheep exposed to intestinal parasites. The effectiveness of glutamine may depend on whether the digestive insult challenges the immune system

Mucins act as a barrier to infection and antigen materials presented to the gut. In fish, mucins are secreted by the skin for external protection. Mucins are rich in threonine, proline, serine and cysteine. Mucins are relatively resistant to digestion and so endogenous losses of these amino acids can be high. Dietary derived tannins, lectins, bacteria, and indigestible fibres and intestinal diseases (intestinal parasitism, diarrhoea, scours, dysentery) induce gut atrophy and increase mucin secretion. In preruminant calves fed increasing levels of protein, intestinal mucin secretion is also increased proportionately (Montagne *et al.*, 2000).

### Amino Acids as Metabolic Regulators

Millward and Rivers (1988) proposed the 'anabolic drive' theory to account for the transient effect of protein intake on protein anabolism. They suggested that it would be an advantage to consume indispensable amino acids in excess of requirements to match identifiable needs. An overwhelming amount of research in the last 10 years appears to support that view. Exciting evidence has emerged demonstrating that amino acids are potent signals that either directly or indirectly regulate protein metabolism (Jefferson and Kimball, 2001). Amino acids therefore serve primary roles as precursors for protein synthesis, and they modulate the protein synthetic machinery within target cells. Further, amino acids are secretagogues of anabolic hormones and they also sensitize target tissues to hormonal actions.

Following consumption of a meal, amino acid availability and adequacy is detected at the cellular level where changes in expression of key genes involved in the initiation and elongation of polypeptide chains are regulated by a series of phosphorylation events to promote protein synthesis (Kimball *et al.*, 2000). This 'nutrient sensing' mechanism involves specific amino acids. The branched-chain amino acids alone are capable of increasing net anabolism (net protein gain) in muscle, adipose tissue and in the liver, with leucine being the most potent (Garlick and Grant, 1988; Patti *et al.*, 1998; Jefferson and

Kimball, 2001). The branched-chain amino acids sensitize tissues to the presence of insulin and insulin-like growth factor-1 (IGF-1). The role of the branched-chain amino acids as signals of nutritional adequacy or availability appears to be uniquely suited to these amino acids because in most animals species, except for fish, branched chain removal by the liver is low (Fig. 5.1). Catabolism of the branched chains occurs in two steps (Fig. 4.13). Removal of the amino group via branched chain aminotransferase occurs mainly in the muscle whereas irreversible oxidation of the keto-acid via branched chain keto-acid dehydrogenase occurs mainly in the liver. The supply of branched-chain amino acids to peripheral tissues, therefore, largely reflects that of the diet and provides the signal to peripheral tissues that additional nutrients are available for protein synthesis.

Non-essential amino acids also act as regulators of protein metabolism. Alanine, glycine, aspartate and glutamate, and glutamine, all of which are transported by Na<sup>+</sup>-dependent transporters, regulate cell swelling. This mechanism has been associated with regulation of protein, carbohydrate and fat metabolism (Haussinger *et al.*, 1994). Glutamine is the most potent, and increased influx of this amino acid into the cell causes the cell to swell, stimulating protein synthesis via similar mechanisms as the branched-chain amino acids (Fig. 5.1). By contrast, during cell shrinkage, as occurs when intracellular levels of the amino acid become depleted (e.g. immune challenge), protein degradation is enhanced. Increased cell swelling also leads to an increase in amino acid oxidation and hepatic ureagenesis. Positive correlations between protein synthesis and amino acid catabolism have been established at the whole animal level (Benevenga *et al.*, 1993). Taken together, there appears to be an obligatory loss of amino acids associated with protein anabolism. This does not always appear to be the case, however, because in pigs administered growth hormone (GH), there is an inverse relationship between muscle protein synthesis and lysine oxidation (Gahl *et al.*, 1998). This issue will need to be resolved since it has important implications for current attempts to balance the amino acid supply

from diets to attain optimal rates of protein gain and improved nitrogen efficiency.

Several amino acids are capable of stimulating hormone synthesis and secretion (Kuhara *et al.*, 1991). In general, leucine and arginine are the most potent stimulators of insulin (anabolic) secretion whereas alanine, glycine and serine are the most effective stimulators of both glucagon (catabolic) and insulin. Aspartate and arginine are most effective in stimulating GH secretion. In pigs, tryptophan stimulates insulin secretion and protein synthesis in the liver, muscle and skin (Ponter *et al.*, 1994). The stimulation of IGF-1 secretion by GH is dependent on level of protein intake. Specific amino acids appear to be important in the GH-IGF-1 axis, with single deletions of arginine, proline, threonine, tryptophan and valine each blocking GH stimulated IGF-1 mRNA expression (Brameld *et al.*, 1999). The GH-IGF-1 axis is re-established, however, at low physiological concentrations of valine or lysine, suggesting that under normal growing conditions, where intake is near maximal, the GH-IGF-1 axis is probably not limited by amino acid availability. At maintenance, low intakes and diseased states, however, these signals may become very important.

During gestation there is a window of time when the embryo and fetus are susceptible to maternal protein intake. Low protein intake by rat dams during the pre-implantation period reprogrammes the physiology and metabolism of the fetus resulting in reduced postnatal growth rate, compromised immune function and the development of impaired glucose tolerance and insulin resistance in later life (Metges, 2001). Dietary lysine sufficiency during gestation-lactation of first-litter sows affects maternal weight loss, sow lactation and piglet growth, and interestingly, the added lysine results in an additional (10.7 vs. 9.6) piglet born alive in the subsequent mating (Tritton *et al.*, 1996). By contrast, in adolescent pregnant sheep, where the drive towards maternal tissue growth is still considerable, higher intakes favour partition of nutrients towards maternal tissues, rather than towards the fetal-placental compartment (Wallace, 2000). In adult ewes, maternal protein restriction of 30% compromises the fetal-placental

compartment, resulting in low birth weight lambs that grow poorly. Piglets born to sows fed a protein-restricted diet are 10% smaller, have a reduced muscle mass and plasma levels of IGF-1 are 30% lower (Schoknecht *et al.*, 1997), suggesting that maternal protein restriction reprogrammes IGF-1 activity. Remarkably, these pigs eventually recover the lost growth after weaning, but this may come too late since the most challenging periods in normal production units are the suckling and weaning phases. Reduced placental-fetal transport and metabolism of glucose, threonine, glycine, and methionine/cysteine appear to be hallmark metabolic features of gestational protein restriction.

### Improving Protein Efficiency

Reducing the contamination of soils, water and air caused by excessive build-up of animal wastes is now the priority of many nutritionists, land managers and lawmakers! A recent evaluation of dairy farms in the eastern US states indicated that dairy farmers over feed protein by 7%, resulting in a 16% increase in urinary N excretion (Jonker *et al.*, 2002). The transfer of current nutritional information from research scientist to nutritionist to farmer may be the problem, but more than likely it results from farmers including a 'safety margin' to ensure that higher producers in the herd are not underfed protein. The goal is to determine the level of protein required to achieve optimal production, yet also improve protein efficiency. Feeding lower protein diets supplemented with limiting amino acids has been successful in the pig and poultry (mostly lysine and methionine) industry where growth rate can be maintained with 15–20% less protein and a 30–40% reduction in nitrogen excretion (Pieterse *et al.*, 2000). In ruminants, this is also possible but a major roadblock in ruminant nutrition is in the prediction of limiting amino acids. The success of whole-animal feeding models, especially for ruminants, will require model development based on knowledge of the pattern of amino acid delivered to and metabolized by tissues and organs.

The need to reduce animal wastes in the environment continues to stimulate interest in defining the ideal pattern and quantity of amino acids required to optimize animal productivity at all stages of the life cycle. The gross efficiency for converting dietary protein into protein gain, milk secretion and egg production is less than optimal and varies among animal species. Beef cattle are the lowest at 8%, followed by pigs (19%), dairy cows (21%), laying hens (24%), growing birds (31%) and fishes (up to 40%) (CAST, 1999). The low value for ruminants reflects the significant (25–40%) losses of dietary N as ammonia. Based on comparisons of the disappearance of amino acids from the small intestines with their accretion in carcass, the estimates are much higher; for pigs, 60–85% (Batterham *et al.*, 1990) and for ruminants 50–59% (MacRae *et al.*, 1993).

A significant source of 'inefficiency' is the apparent obligatory loss associated with high rates of tissue turnover. Protein turnover is particularly high in the visceral tissues (20–100%/day), and even in muscle where turnover is 40-fold lower (fractionally 1–4%/day), only 32–46% of the protein synthesized in young (suckling) animals is retained. In older animals, this value drops to 24%. Protein efficiency declines with maturity, mainly as a result of reductions in protein translational efficiency (Davis *et al.*, 2000) and in the sensitivity of target tissues to hormone and amino acid signals (O'Connor *et al.*, 2000). At intakes above maintenance, protein synthesis and degradation are both stimulated by energy intake. However, the response in protein degradation is 24%–33% less than for protein synthesis, and so net anabolism results. The energetic cost of protein turnover is high, requiring 4.5–7 mol of ATP per mole of peptide bond formed and 1–2 mol of ATP per mole of peptide bond breakage. In addition, although most tissues recycle 80% of the amino acid derived from protein breakdown, the remainder appears to be oxidized. Strategies that target protein degradation would appear to be more beneficial in terms of improving overall energy and protein efficiency.

Achieving optimal rates of protein deposition or secretion is a trade-off with lower partial efficiencies of utilization as dietary protein

intake increases. In part, the diminishing returns on protein gain may reflect the point of energy limitation (use of amino acid carbon as energy) and/or the limits to genetic potential. Most research has focused on providing the ideal balance of amino acid, which may become more important at higher levels of production. The 'ideal protein' concept now used in formulating pig and poultry diets is based on balancing dietary essential amino acids to meet requirements for maintenance and growth. The requirement for dispensable amino acids, which make up over half of the N in proteins, is now being considered. Earlier, the vital roles of some of the non-essential amino acid were emphasized, and indeed it has been demonstrated that at maintenance the requirement is dominated by non-essential amino acids (Fuller *et al.*, 1989). The requirement for non-essentials could be met by supplying extra essential amino acids, but this would be wasteful and most studies indicate that essentials (e.g. arginine, lysine, methionine/cysteine) are poor precursors for the non-essentials. Chapter 6 discusses the implications of balancing the essential to non-essential ratio in pig diets when the goal is to achieve maximum rates of nitrogen retention versus maximum nitrogen efficiency.

Imbalances or excesses of dietary amino acids are often inevitable when protein sources are expensive or limited in availability (see Chapter 7). Most imbalances are manifested at the level of transport through competitive mechanisms. An example is the inhibitory effect of arginine on lysine transport and utilization. Imbalances or excesses of branched-chain amino acids affects the transport of their cohorts (Langer and Fuller, 2000). In addition, an excess of one branched-chain amino acid stimulates oxidation of the others because the branched-chain keto-acid dehydrogenase has a high affinity for all of them. Methionine is also recognized by the branched-chain dehydrogenase. Under methionine-limiting conditions, however, excesses of the branched-chain amino acids reduce methionine oxidation due to competitive inhibition of the branched-chain keto-acids with the methionine keto-acid. The net effect is an improvement in nitrogen retention (Langer and Fuller, 2000; Langer *et al.*,

2000). Similarly, addition of glutamate to a threonine-limiting diet improves pig growth rate (Le Floch *et al.*, 1994), but here the effect appears to be at the level of the intestines where threonine catabolism is spared (Le Floch *et al.*, 1999).

### Future Considerations

As we enter into the postgenomic era, nutrition and metabolism will play increasingly important roles. Genomics may tell us the potential for productivity but it does not tell us about the capacity. Genes make proteins and proteins function in metabolic pathways but it is the nutrients that regulate the network of signalling pathways that regulate the genes and so on and so forth. Identifying the function of the targeted genes, therefore, requires an understanding of the metabolism and roles that nutrients play, in our case amino acids.

Traditional selection practices have focused on identifying genetic lines capable of rapid growth, and wool and milk production, and although feed conversion efficiency has improved only marginally, the tools of biotechnology should allow us to identify and manipulate those genes linked to efficiency. Transgenic technologies have already led to the development of transgenic mice overexpressing myostatin. These mice have 22–44% larger carcasses and lower epididymal fat (Yang *et al.*, 2001). Although attempts to overexpress the GH gene in pigs have been limited, there has been success in fish where dramatic (tenfold) improvements in growth rate have been reported for salmon containing the piscine GH gene constructs (Dunham and Devlin, 1999).

The next major advances in nutrition will rely on the functional characteristics of such genes and a better understanding of the underlying cellular and molecular mechanisms involved once their expression has been enhanced or downregulated. The interactions of nutrition with regulation of the target genes controlling growth, development, health and other agronomic attributes will probably prove to be more important than the effect of nutrition on product composition. As nutritionists, we will need to begin to ask important ques-

tions. We already know of the importance of amino acid balance in optimizing productivity, but given the recent discoveries of the regulatory role of amino acids in the control of protein metabolism, health and in fetal programming, we may need to redefine that balance. Will the amino acid requirements for transgenic animals be different? Early indications are that animals selected for rapid growth and muscle gain are more susceptible to disease and are less capable of mounting an immune response. Will transgenic animals require greater quantities of glutamine, glutamate, cysteine, arginine and threonine in their diets to preserve growth performance by 'feeding' the immune system? Which amino acids and other nutrients are the ones important in facilitating the expression of regulatory genes in early fetal and postnatal life that entrain the changes in growth pattern, egg and milk production and health in later life?

Recent findings in human nutrition of the benefits of supplementing specific amino acids has stimulated interest and research to test whether these lead to production or health advantages in farm animals. Responses to some of these supplements have been inconsistent and not always are the desired responses observed. Examples were given above of glutamine and arginine supplementation in young rapidly growing animals, especially during the weaning period. The inconsistency of the responses to glutamine, for example, is evidence that our understanding of amino acid metabolism and its links to physiology is still limited. Caution will need to be exercised and further evaluations conducted before these 'theories' become nutritional practice. Studies on intermediary amino acid metabolism and physiology of farm animals at the tissue and whole animal levels will need to be funded and conducted to evaluate the production situations where the additives do and do not work. The powerful modulatory effect of amino acids on the proteins involved in regulation of mRNA translation has opened up a new and exciting area of protein nutrition. This area is still in its infancy, and it is still not known which amino acids regulate the pathways that effect global protein synthesis and which ones target the translation of mRNAs for synthesis of specific

proteins. Further, the amino acid sensing mechanism remains poorly defined.

Improvements in diet digestibility and nutritional adequacy have greatly contributed to improvements in farm animal productivity. Transgenic plants are already available with modified seed or leaf proteins that contain amino acid compositions that better match the animal's requirements. Most of the major plant sources (soybeans, grain legumes, barley, maize) are deficient in methionine, cysteine, and lysine, and this has been the target of most of the gene targeting research. Genes encoding sunflower seed albumin (rich in cysteine/methionine) have been transferred to clover but technical constraints have resulted in low expression in the leafy material (Khan

*et al.*, 1996). Better success has been achieved by altering protein gene expression of seeds by overexpression, transfection or transformation of existing or foreign genes (Mandal and Mandal, 2000) or by anti-sense approaches to downregulate expression of lower quality proteins (Kohnomurase *et al.*, 1995). Feeding transgenic lupin seeds containing sunflower albumin (1.3- to 2.3-fold higher methionine and cysteine) increases wool growth and efficiency (8%) and live weight gain (7%) of sheep (White *et al.*, 2001). Realization of the power of transgenic plant and animal technologies is just on the horizon, and this will raise further questions to fuel research on the role and suitability of amino acid nutrition of animals.

## References

- Annisson, E.F. and Bryden, W.L. (1999) Perspectives on ruminant nutrition and metabolism. *Nutrition Research Reviews* 12, 147–177.
- Batterham, E.S., Anderson, L.M., Baignent, D.R. and White, E. (1990) Utilisation of ileal digestible amino acid by growing pigs: effect of dietary lysine concentration on efficiency of lysine retention. *British Journal of Nutrition* 64, 81–94.
- Benevenga, N.J., Gahl, M.J. and Blemings, K.P. (1993) Role of protein synthesis in amino acid catabolism. *Journal of Nutrition* 123, 332–336.
- Bequette, B.J., Backwell, F.R.C. and Crompton, L.A. (1998) Current concepts of amino acid and protein metabolism in the mammary gland of the lactating ruminant. *Journal of Dairy Science* 81, 2540–2559.
- Borman, A., Wood, T.R., Black, H.C., Anderson, E.G., Oesterling, M.J., Womack, M. and Rose, W.C. (1946) The role of arginine in growth with some observations on the effects of argininic acid. *Journal of Biological Chemistry* 166, 585–594.
- Brameld, J.M., Gilmour, R.S. and Buttery, P.J. (1999) Glucose and amino acids interact with hormones to control expression of insulin-like growth factor-I and growth hormone receptor mRNA in cultured pig hepatocytes. *Journal of Nutrition* 129, 1298–1306.
- Brooks, H.W., White, D.G. and Wagstaff, A.J. (1997) Evaluation of a glutamine-containing oral rehydration solution for the treatment of calf diarrhea using an *Escherichia coli* model. *British Veterinary Journal* 153, 163–170.
- Burrin, D.G., Stoll, B., Van Goudoever, J.B. and Reeds, P.J. (2001) Nutrient requirements for intestinal metabolism and growth in the neonatal pig. In: Lindberg, J.E. and Ogle, B. (eds) *Digestive Physiology of Pigs*. CAB International, Wallingford, UK, pp. 75–88.
- CAST (1999) *Animal Agriculture and Global Food Supply*. Council for Agricultural Science and Technology. Task Force Report no. 135.
- Davis, T.A., Nguyen, H.V., Garcia-Bravo, R., Fiorotto, M.L., Jackson, E.M. and Reeds, P.J. (1994) Amino acid composition of the milk of some mammalian species changes with stage of lactation. *British Journal of Nutrition* 72, 845–853.
- Davis, T.A., Nguyen, H.V., Suryawan, A., Bush, J.A., Jefferson, L.S. and Kimball, S.R. (2000) Developmental changes in the feeding-induced stimulation of translation initiation in muscle of neonatal pigs. *American Journal of Physiology* 279, E1226–E1234.
- Dunham, R.A. and Devlin, R.H. (1999) Comparison of traditional breeding and transgenesis in farmed fish with implications for growth enhancement and fitness. In: Murray, J.D., Anderson, G.B., Oberbauer, A.M. and McGloughlin, M.M. (eds) *Transgenic Animals in Agriculture*. CAB International, Wallingford, UK, pp. 209–229.

- Ewtushik, A.L., Bertolo, R.F.P. and Ball, R.O. (2000) Intestinal development of early-weaned piglets receiving diets supplemented with selected amino acids or polyamines. *Canadian Journal of Animal Science* 80, 653–662.
- Fligger, J.M., Gibson, C.A., Sordillo, L.M. and Baumrucker, C.R. (1997) Arginine supplementation increases weight gain, depresses antibody production, and alters circulating leukocyte profiles in pre-ruminant calves without affecting plasma growth hormone concentrations. *Journal of Animal Science* 75, 3019–3025.
- Fu, C.H., Cui, Y.B., Hung, S.S.O. and Zhu, Z.Y. (2000) Whole-body amino acid pattern of F-4 human growth hormone gene-transgenic red common carp (*Cyprinus carpio*) fed diets with different protein levels. *Aquaculture* 189, 287–292.
- Fuller, M.F., McWilliam, R., Wang, T.C. and Giles, L.R. (1989) The optimum dietary amino acid pattern for growing pigs. 2. Requirements for maintenance and for tissue protein accretion. *British Journal of Nutrition* 62, 255–267.
- Gahl, M.J., Benevenga, N.L. and Crenshaw, T.D. (1998) Rates of lysine catabolism are inversely related to rates of protein synthesis when measured concurrently in adult female rats induced to grow at different rates. *Journal of Nutrition* 128, 1503–1511.
- Garlick, P.J. and Grant, I. (1988) Amino acid infusion increases the sensitivity of muscle protein synthesis *in vivo* to insulin. *Biochemical Journal* 254, 579–584.
- Haussinger, D., Lang, F. and Gerok, W. (1994) Regulation of cell function by the cellular hydration state. *American Journal of Physiology* 276, E343–E355.
- Jahoor, F., Wykes, L.J., Reeds, P.J., Henry, J.F., del Rosario, M.P. and Frazier, M.E. (1995) Protein-deficient pigs cannot maintain reduced glutathione homeostasis when subjected to the stress of inflammation. *Journal of Nutrition* 125, 1462–1472.
- Jefferson, L.S. and Kimball, S.R. (2001) Amino acid regulation of gene expression. *Journal of Nutrition* 131, 2460S–2466S.
- Jonker, J.S., Kohn, R.A. and High, J. (2002) Dairy herd management practices that impact nitrogen utilization efficiency. *Journal of Dairy Science* 85, 1218–1226.
- Khan, M.R.I., Ceriotti, A., Tabe, L., Aryan, A., McNabb, W., Moore, A., Craig, S., Spencer, D. and Higgins, T.J.V. (1996) Accumulation of a sulphur-rich seed albumin from sunflower in the leaves of transgenic subterranean clover (*Trifolium subterraneum* L). *Transgenic Research* 5, 179–185.
- Kimball, S.R., Jefferson, L.S., Nguyen, H.V., Suryawan, A., Bush, J.A. and Davis, T.A. (2000) Feeding stimulates protein synthesis in muscle and liver of neonatal pigs through an mTOR-dependent process. *American Journal of Physiology* 279, E1080–E1087.
- Kohnomurase, J., Murase, M., Ichikawa, H. and Imamura, J. (1995) Improvement in the quality of seed storage protein by transformation of brassica-napus with an antisense gene for cruciferin. *Theoretical and Applied Genetics* 91, 627–631.
- Kuhara, T., Ikeda, S., Ohneda, A. and Sasaki, Y. (1991) Effects of intravenous infusion of 17 amino acids on the secretion of GH, glucagons, and insulin in sheep. *American Journal of Physiology* 260, E21–E26.
- Langer, S. and Fuller, M.F. (2000) Interactions among the branched-chain amino acids and their effects on methionine utilization in growing pigs: effects on nitrogen retention and amino acid utilization. *British Journal of Nutrition* 83, 43–48.
- Langer, S., Scislowski, P.W.D., Brown, D.S., Dewey, P. and Fuller, M.F. (2000) Interactions among the branched-chain amino acids and their effects on methionine utilization in growing pigs: effects on plasma amino- and keto-acid concentrations and branched-chain keto-acid dehydrogenase activity. *British Journal of Nutrition* 83, 49–58.
- Le Floch, N., Seve, B. and Henry, Y. (1994) The addition of glutamic-acid or protein to a threonine-deficient diet differentially affects growth-performance and threonine dehydrogenase-activity in fattening pigs. *Journal of Nutrition* 124, 1987–1995.
- Le Floch, N., Meziere, N. and Seve, B. (1999). Threonine transfer across the splanchnic area of pigs. In: Lobley, G.E., White, A. and MacRae, J.C. (eds) *Eighth International Symposium on Protein Metabolism and Nutrition*, Wageningen Pers, Aberdeen, UK, p. 43.
- Leibholz, J. (1982) Arginine requirements of pigs between 7 and 28 days of age. *Australian Journal of Agricultural Research* 33, 165–170.
- Lobley, G.E. and Lapiere, H. (2001) HMB metabolism in ruminants. *Proceedings of the 16th Annual Southwest Nutrition and Management Conference*. Arizona, USA, pp. 15–23.
- Lobley, G.E., Hoskin, S.O. and McNeil, C.J. (2001) Glutamine in animal science and production. *Journal of Nutrition* 131, 2525S–2531S.



- MacRae, J.C., Walker, A., Brown, D. and Lobley, G.E. (1993) Accretion of total protein and individual amino-acids by organs and tissues of growing lambs and the ability of nitrogen-balance techniques to quantitate protein retention. *Animal Production* 57, 237–245.
- MacRae, J.C., Bruce, L.A., Brown, D.S., Farningham, D.A.H. and Franklin, M. (1997) Absorption of amino acids from the intestine and their net flux across the mesenteric- and portal-drained viscera of lambs. *Journal of Animal Science* 75, 3307–3314.
- Mandal, S. and Mandal R.K. (2000) Seed storage proteins and approaches for improvement of their nutritional quality by genetic engineering. *Current Science (India)* 79, 576–589.
- Metges, C.C. (2001) Does dietary protein in early life affect the development of adiposity in mammals? *Journal of Nutrition* 131, 2062–2066.
- Millward, D.J. and Rivers, J.P.W. (1988) The nutritional role of indispensable amino acids and the metabolic basis for their requirements. *European Journal of Clinical Nutrition* 42, 367–393.
- Montagne, L., Toullec, R. and Lalles, J.P. (2000) Calf intestinal mucin: isolation, partial characterisation, and measurement in ileal digesta with an enzyme-linked immunosorbent assay. *Journal of Dairy Science* 83, 507–517.
- O'Connor, P.M.J., Nguyen, H.V., Fiorotto, M.L., Reeds, P.J., Burrin, D.G., Beckett, P.R. and Davis, T.A. (2000) Stimulation of protein synthesis by amino acids and insulin varies with muscle fibre type and age. *Pediatric Research* 47, 1730 (Suppl. S).
- Patti, M.E., Brambilla, E., Luzi, L., Landaker, E.J. and Kahn, C.R. (1998) Bidirectional modulation of insulin action by amino acids. *Journal of Clinical Investigations* 101, 1519–1529.
- Pieterse, E., Siebrits, F.K., Gloy, E.L. and Mphuloane, A.K. (2000) The effect of protein inclusion level in diets formulated to contain an ideal amino acid composition for growing pigs. *South African Journal of Animal Science* 30, 57–61.
- Ponter, A.A., Cortamira, N.O., Seve, B., Salter, D.N. and Morgan, L.M. (1994) The effects of energy source and tryptophan on the rate of protein synthesis and on hormones of the entero-insular axis in the piglet. *British Journal of Nutrition* 71, 661–674.
- Reeds, P.J. (2000) Dispensable and indispensable amino acids for humans. *Journal of Nutrition* 130, 1835S–1840S.
- Reeds, P.J., Burrin, D.G., Stoll, B., Jahoor, F., Wykes, L., Henry, J. and Frazer, M.E. (1997) Enteral glutamate is the preferential source for mucosal glutathione synthesis in fed piglets. *American Journal of Physiology* 36, E408–E415.
- Reeds, P.J., Burrin, D.G., Davis, T.A. and Stoll, B. (1998) Amino acid metabolism and the energetics of growth. *Archives of Animal Nutrition* 51, 187–197.
- Rose, W.C., Oesterling, M.J. and Womack, M. (1948) Comparative growth on diets containing ten and nineteen amino acids, with further observations upon the role of glutamic and aspartic acids. *Journal of Biological Chemistry* 176, 753–762.
- Schoknecht, P.A., Ebner, S., Skottner, A., Burrin, D.G., Davis, T.A., Ellis, K. and Pond, W.G. (1997) Exogenous insulin-like growth factor-I increases weight gain in intrauterine growth-retarded neonatal pigs. *Pediatric Research* 42, 201–207.
- Stoll, B., Henry, J., Reeds, P.J., Yu, H., Jahoor, F. and Burrin, D.G. (1998) Catabolism dominates the first-pass intestinal metabolism of dietary essential amino acids in milk protein-fed piglets. *Journal of Nutrition* 128, 606–614.
- Stoll, B., Burrin, D.G., Henry, J., Yu, H., Jahoor, F. and Reeds, P.J. (1999) Substrate oxidation by the portal drained viscera of fed piglets. *American Journal of Physiology* 277, E168–E175.
- Torrallardona, D., Harris, C.I., Coates, M.E. and Fuller, M.F. (1996) Microbial amino acid synthesis and utilization in rats: incorporation of  $^{15}\text{N}$  from  $^{15}\text{NH}_4\text{Cl}$  into lysine in the tissues of germ-free and conventional rats. *British Journal of Nutrition* 76, 689–700.
- Tritton, S.M., King, R.H., Campbell, R.G., Edwards, A.C. and Hughes, P.E. (1996) The effects of dietary protein and energy levels of diets offered during lactation on the lactational and subsequent reproductive performance of first-litter sows. *Animal Science* 62, 573–579.
- van Goudoever, J.B., Stoll, B., Henry, J.F., Burrin, D.G. and Reeds, P.J. (2000) Adaptive regulation of intestinal lysine metabolism. *Proceedings of the National Academy of Sciences USA* 97, 11620–11625.
- Wallace, J.M. (2000) Nutrient partitioning during pregnancy: adverse gestational outcome in overnourished adolescent dams. *Proceedings of the Nutrition Society* 59, 107–117.
- Wester, T.J., Vasquez-Anon, M., Parker, D.S., Dibner, J.J., Calder, A.G. and Lobley, G.E. (2000) Synthesis of methionine (met) from 2-hydroxy-4-methylthio butanoic acid (HMB) in growing lambs. *Journal of Animal Science* 78 (Suppl. 1), 269.

- 
- White, C.L., Tabe, L.M., Dove, H., Hamblin, J., Young, P., Phillips, N., Taylor, R., Gulati, S., Ashes, J. and Higgins, T.J.V. (2001) Increased efficiency of wool growth and live weight gain in Merino sheep fed transgenic lupin seed containing sunflower albumin. *Journal of the Science of Food and Agriculture* 81, 147–154.
- Withers, P.C. (1998) Urea: diverse functions of a 'waste' product. *Clinical and Experimental Pharmacology and Physiology* 25, 722–727.
- Wu, G. (1998) Intestinal amino acid catabolism. *Journal of Nutrition* 128, 1249–1252.
- Wu, G., Meier, S.A. and Knabe, D.A. (1996) Dietary glutamine supplementation prevents jejunal atrophy in weaned pigs. *Journal of Nutrition* 126, 2578–2584.
- Wu, G., Davis, P.K., Flynn, N.E., Knabe, D.A. and Davidson, J.T. (1997) Endogenous synthesis of arginine plays an important role in maintaining arginine homeostasis in postweaning growing pigs. *Journal of Nutrition* 127, 2342–2349.
- Yang, J.Z., Ratovitski, T., Brady, J.P., Solomon, M.B., Wells, K.D. and Wall, R.J. (2001) Expression of myostatin pro domain results in muscular transgenic mice. *Molecular Reproduction and Development* 60, 351–361.
- Yu, F., Bruce, L.A., Calder, A.G., Milne, E., Coop, R.L., Jackson, F., Horgan, G.W. and MacRae, J.C. (2000) Subclinical infection with the nematode *Trichostrongylus colubriformis* increases gastrointestinal tract leucine metabolism and reduces availability of leucine for other tissues. *Journal of Animal Science* 78, 380–390.



# 6 Essential to Non-essential Amino Acid Ratios

Jaroslav Heger\*

*Biofaktory Praha s.r.o., Czech Republic*

---

## Introduction

The ideal protein concept is generally accepted as an efficient tool for estimating amino acid requirements. Although the importance of a proper balance of essential amino acids for maximum growth and protein utilization is widely recognized, less attention has been paid to the role of non-essential amino acids even though they supply more than half the total nitrogen ingested. The optimum proportion of non-essential nitrogen of the ideal protein is defined rather vaguely. Thus Stranks *et al.* (1988) defined the ideal protein as that having a 'correct balance between the essential and non-essential amino acids'. Similarly, Batterham (1994) stated that the essential and non-essential amino acids should be included in the ideal protein 'in a correct ratio'. Cole and Van Lunen (1994) suggested that, to provide the ideal protein, it would be necessary to supply an optimally balanced mixture of essential amino acids 'with sufficient nitrogen for the synthesis of non-essential amino acids'. These statements, however, are not very helpful when considering the optimal distribution of total dietary N between both amino acid classes in quantitative terms. Defining the optimum essential to non-essential amino acid ratio could thus be useful as part of the ideal protein concept

provided reliable estimates of the optimum for various physiological functions are available and factors affecting the optimum are taken into account.

The ideal protein balance providing essential amino acids at levels corresponding to the requirement together with sufficient amounts of non-essential amino acids represents a theoretical minimum requirement for a given type and level of performance. Minimization of surplus amino acids in the diet is one of the ways of reducing, by nutritional means, excessive nitrogen excretion, which is becoming a serious problem in countries with intensive livestock production. Concerns for environmental protection stimulate the search for nutritional strategies aimed at increasing dietary N utilization as a prerequisite for reducing environmental nitrogen pollution. Availability of industrially produced feed-grade amino acids greatly assists this approach. Supplementation of practical diets with essential amino acids to optimize amino acid balance allows a decrease in dietary crude protein level and gives an increase in its utilization. At the same time, metabolic load resulting from the degradation of surplus amino acids is reduced and energy expenditure for the elimination of surplus nitrogen is decreased. It is expected that efforts to reduce the crude protein content of practical diets will

\*E-mail address: biohp@traveller.cz

continue and that non-essential N may become a limiting factor in such diets. Thus defining the optimum proportion of non-essential N in low-protein, amino acid-supplemented diets will be important for attaining maximum performance and overall efficiency of protein utilization.

The aim of this chapter is to provide a quantitative overview of the relationships between essential and non-essential amino acids in the diet with respect to their effect on animal performance. The biochemical basis of the response to changes in essential to non-essential amino acid ratio will also be examined.

### **Difficulties in Defining Essential to Non-essential Amino Acid Ratio**

Most of the disparity between published estimates of the optimum essential to non-essential amino acid ratios is attributable to the different ways of expressing the relations between the two amino acid groups, different classifications of amino acids with regard to their essentiality, and different methodological approaches. These issues are briefly discussed below.

#### **Expressing the relations between essential and non-essential amino acids**

There are various ways of expressing the relationships between dietary essential and non-essential amino acids. Essential amino acids have been related to total amino acids (Ikemoto *et al.*, 1989), non-essential amino acids (Mitchel *et al.*, 1968; Wang and Fuller, 1989; Markert *et al.*, 1993), total nitrogen (Young and Zamora, 1968) or total protein (Dove *et al.*, 1977a; Bedford and Summers, 1985). However, the validity of expressing the amino acid content on a weight basis is questionable. Non-essential amino acids differ considerably in their N concentrations which range from 108 g kg<sup>-1</sup> in glutamate to 245 g kg<sup>-1</sup> in asparagine. Variation in the contents of individual non-essential amino acids in both practical and experimental diets, can result in their sum expressed on weight basis changing even though the total concentration of non-essential N remains the same (Boisen, 1997).

Since the main function of non-essential amino acids is to provide non-specific nitrogen, the proportions of amino acid groups should be expressed on a nitrogen basis, either as essential to non-essential N ratio (Young and Zamora, 1968; Lenis *et al.*, 1999) or essential to total N ratio (Taylor *et al.*, 1996; Heger *et al.*, 1998). The latter value appears to be more acceptable as the ratio of essential to non-essential N equals infinity at zero concentration of non-essential amino acids.

When crystalline amino acids are a main or sole source of dietary nitrogen, both of the above ways of N expression are essentially equivalent since the content of non-amino acid N is low or close to zero; the essential to total N ratio can be easily converted into essential to non-essential N ratio and vice versa. Crude protein of natural feedstuffs, however, contains a considerable amount of non-amino acid nitrogen such as nucleic acids and their derivatives, amino sugars, nitrates and nitrites, creatine, porphyrins, etc., only part of which may be used for the synthesis of non-essential amino acids (ARC, 1981; AFRC, 1987). Hence the essential to total N ratio may differ depending upon the type of diet. To avoid uncertainties associated with the utilization of sources of non-specific nitrogen other than amino acids, it seems reasonable to take into account amino acid nitrogen only. Therefore, the ratio between the amino acid groups is defined in this chapter as the ratio of essential amino acid N to total amino acid N (E:T). Wherever possible, the literature data expressed in another way have been recalculated.

#### **Classification of amino acids**

Another factor that may influence the E:T value is the classification of amino acids (Table 1.1). Difficulties arise particularly with semi-essential amino acids that have been classified alternatively as essential or non-essential by different authors. In rats, Stucki and Harper (1962) classified arginine as essential but cystine and tyrosine as non-essential amino acids. On the other hand, Ikemoto *et al.* (1989) considered cystine and tyrosine to be essential,

with arginine and histidine grouped among the non-essential amino acids. Other authors who studied the optimum E:T ratio in rats classified arginine, cystine and tyrosine as essential amino acids (Adkins *et al.*, 1967; Heger *et al.* 1987). Similarly in pigs, arginine was considered essential in some studies (Heger *et al.*, 1998; Lenis *et al.*, 1999), yet other authors classified arginine as non-essential (Markert *et al.*, 1993; Gotterbarm *et al.*, 1998). In studies with poultry, glycine was included into the essential group by Stucki and Harper (1961) whereas Deschepper and de Groote (1995) and Alleman *et al.* (2000) classified this amino acid as non-essential. In their studies on the optimum E:T ratio in turkeys, Bedford and Summers (1988) included glycine into both essential and non-essential groups. Proline was considered essential for chicks in experiments by Sugahara and Ariyoshi (1968).

It is evident that any change in amino acid classification brings about a change in N content of both amino acid groups and, consequently, a change in E:T ratio. Arginine, due to its high N concentration, exerts the most significant effect. Thus Roth *et al.* (1994b) who classified arginine as non-essential estimated the optimum E:T ratio for growing pigs to be 0.45. However, when the data by Roth *et al.* (1994b) were recalculated with arginine as essential, the optimum E:T ratio increased to 0.59. It is also evident that any estimates of optimum E:T ratio are only justified when the essential amino acid pattern is ideal relative to the requirement. Any departure from the ideal pattern results in the partial degradation of essential amino acids, with the released nitrogen being used for the synthesis of non-essential amino acids or excreted. It follows that the essential amino acids present in excess relative to the requirement should be regarded as sources of non-essential N (Moran *et al.*, 1967; Bedford and Summers, 1986). This is illustrated by the results of Ikemoto *et al.* (1989) who estimated the optimum essential to total amino acid ratio in rats fed on amino acid diets simulating egg protein or wheat gluten. Although the optimum ratio for well-balanced egg protein was found to be 0.4, the optimum value for wheat gluten was 0.9 indicating that, because

of the severe deficiency of lysine, a great part of essential amino acids in wheat gluten was degraded and used for the synthesis of non-essential amino acids.

In order to be able to compare E:T ratios reported in the literature as well as those found in rats, pigs and poultry, the same method of amino acid classification was used in this chapter for all species, being slightly different from that presented in Table 1.1. Arginine, cystine and tyrosine were classified as essential whereas proline and taurine were considered non-essential. If the proportions of sulphur or aromatic amino acids were higher than those in the ideal protein, the excessive parts of cystine or tyrosine were taken as sources of non-essential N. In those cases where the amino acid classification was based on a different principle and data on amino acid composition of diets were available, E:T ratios were recalculated by the above method.

## Methodology

There are two main approaches to estimating optimum E:T ratio: measuring the response to alterations in essential and non-essential N at constant concentration of total dietary N or studying the effects of altering the E:T ratio at constant concentration of essential N by altering the concentration of total N. Both methods have their limitations. In isonitrogenous diets, a low E:T ratio is inevitably associated with a low response due to the deficiency of essential amino acids, the degree of which being dependent on the level of total nitrogen selected. At low E:T ratios, a sufficient intake of essential N relative to the requirement can be attained only with high-protein diets. Total dietary N may thus considerably affect both the shape of the response curve and its maximum (or the breakpoint in a rectilinear model) and consequently the estimated optimum. It is evident that at higher concentrations of total dietary N the requirement for essential N will be met at lower E:T values and therefore lower estimates of the optimum can be expected than for diets with low concentrations of total N. On the other hand, the use of isonitrogenous diets allows the response to E:T ratios to be studied within the whole

range from 0 to 1, and if the study is carried out at several levels of total dietary N, it provides a more comprehensive view than one based on a constant level of essential N.

Estimating the optimum E:T value at a constant level of essential N seems to be more suitable for practical applications. This approach gives an assessment of the minimum amounts of total dietary N, at a given level of essential amino acids, needed for various types of response such as growth rate, protein deposition, amino acid utilization, nitrogen excretion, etc. When essential amino acids are maintained constant at levels near the optimum requirement, it is difficult to achieve low E:T ratios since the total dietary N content increases exponentially as the E:T value decreases; however, this disadvantage is not of much importance from a practical point of view. It is worth mentioning that, in spite of its merit, the method based on constant concentration of essential N has been used in only a few experiments (Dove *et al.*, 1977b; Roth *et al.*, 1994b, 1999; Heger *et al.*, 1998), and the majority of reported optimum E:T ratios have been estimated using isonitrogenous diets.

As with any empirical method of determining the dose-response relationship, several criteria must be fulfilled to obtain a reliable estimate of the optimum value. Firstly, a wide range of E:T values must be selected and a sufficient number of treatments must be used to fit a suitable function to experimental data. This precondition is particularly important when fitting polynomial models to data giving a flat response curve, as is usually the case when studying the response to changing E:T ratios. As shown by Morris (1989), the most often used quadratic curve is sensitive to the range of input values and tends to estimate the maximum (or minimum) in the middle of the interval tested. When the range of the independent variable is small or incorrectly chosen, the estimated optimum can be biased with a significant error. Secondly, the response to E:T ratio must not be influenced by any other dietary or environmental factor. This precondition poses a problem when using diets with a low E:T ratio and a high total N content where a part of energy is required for deamination and elimination of

the surplus protein, thereby decreasing the amount of metabolizable energy which may thus become a limiting factor. Thirdly, in balance experiments with constant levels of essential nitrogen in which the total N concentration varies within a wide range, the adaptation period must be long enough to allow for the short-time changes in N deposition in internal organs resulting from adaptive responses to the changes in non-essential amino acid intake.

### Optimum E:T Ratio for Growth and Protein Deposition

Soon after experiments with purified diets had been started in the early 1940s, it became apparent that use of essential amino acids as a sole source of dietary N did not promote normal growth of rats (Kinsey and Grant, 1944) or chicks (Hegsted, 1944; Luckey *et al.*, 1947) and that, to attain maximum growth rate, it was necessary to supplement the mixture of essential amino acids with one or several non-essential amino acids or another source of non-specific nitrogen (Rose *et al.*, 1948; Frost and Sandy, 1951; Rechcigl *et al.*, 1957; Greenstein *et al.*, 1957; Klain *et al.*, 1959). Favourable effects of the inclusion of non-essential amino acid supplements were observed even in diets containing an excess of essential amino acids sufficient for the synthesis of non-essential amino acids (Adkins *et al.*, 1966). This observation led to the proposal that the rate of synthesis of one or more non-essential amino acids is not sufficient to support maximum growth rate (Adkins *et al.*, 1966). In the following years the importance of a correct balance between the essential and non-essential amino acids was established in other species such as pigs (Mitchell *et al.*, 1968), turkeys (Bedford and Summers, 1988), preruminating lambs (Dove *et al.*, 1977a,b), kittens (Anderson *et al.*, 1980), fish (Mambrini and Kaushik, 1994; Schuhmacher *et al.*, 1995) and humans (Kies and Linkswiler, 1965; Daniel *et al.*, 1970).

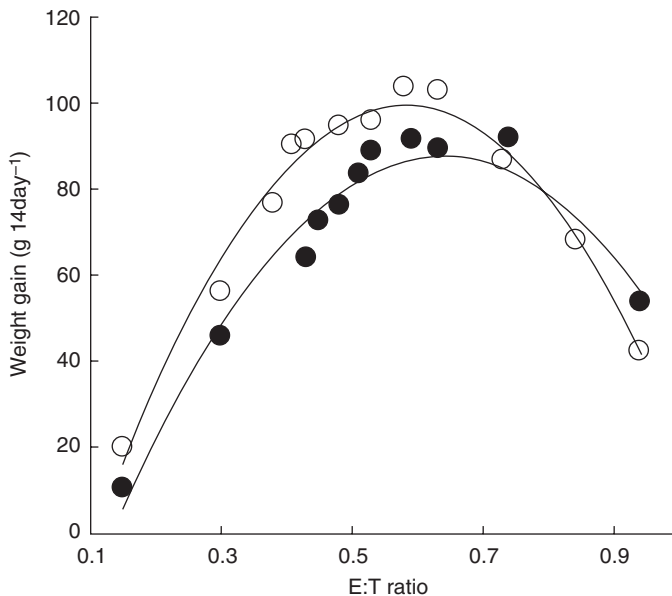
Stucki and Harper (1961, 1962) were among the first researchers to make quantitative estimates of the optimum E:T ratio within a broad range of the ratios and at several levels

of dietary N. In their experiments with weanling rats (Stucki and Harper, 1962), they used purified diets containing 75–150 g CP kg<sup>-1</sup> in which the E:T ratios ranged from 0.33 to 1.0. Lower performance was observed in diets with extreme E:T ratios whereas E:T values ranging from 0.53 to 0.81 had no significant effect on growth rate, feed conversion or protein efficiency ratio. A marked decrease in growth rate and protein utilization was found in the diet with the highest N concentration containing only essential amino acids (E:T = 1.0); this might be attributable to an adverse effect of the excess of one or more essential amino acids. In contrast, the negative effect of low E:T ratios on growth rate was more pronounced in diets with the lower total N concentration, suggesting a lack of essential amino acids.

A further extensive series of experiments on growing rats was carried out by Young and Zamora (1968) who evaluated the effect of 12 essential to non-essential amino acid ratios on weight gain and protein efficiency ratio at two dietary crude protein levels. Their findings support those of Stucki and Harper (1962)

indicating that both too low and too high E:T ratios are inhibitory to growth regardless of nitrogen intake and that the dietary crude protein level affects both the shape of the response curve and the optimum E:T ratio (Fig. 6.1). The adverse effects of high E:T ratios were exaggerated by high dietary crude protein level whereas the lowest weight gains at low E:T ratios were associated with low crude protein (CP) level. The optimum E:T ratio decreased as the CP level of the diet increased. At 139 g CP kg<sup>-1</sup>, maximum growth was attained with E:T ratio of 0.61 whereas the E:T value required for maximum growth rate at 181 g CP kg<sup>-1</sup> was 0.58. In another experiment with growing rats, the optimum E:T ratio required for maximum N retention at dietary CP concentration of 100 g kg<sup>-1</sup> was estimated to be 0.68 (Heger *et al.*, 1987).

There is relatively little information available on optimum E:T ratios in pigs and poultry estimated within a sufficiently broad range of values. Mitchell *et al.* (1968) studied the effect of adding four levels of glutamate to a semipurified diet with a constant concentration



**Fig. 6.1.** Relationship between E:T ratio and weight gains of rats fed on diets containing 22.3 (●) or 29 (○) g N kg<sup>-1</sup>. (From Young and Zamora, 1968. Reproduced with permission of the American Society for Nutritional Sciences.)

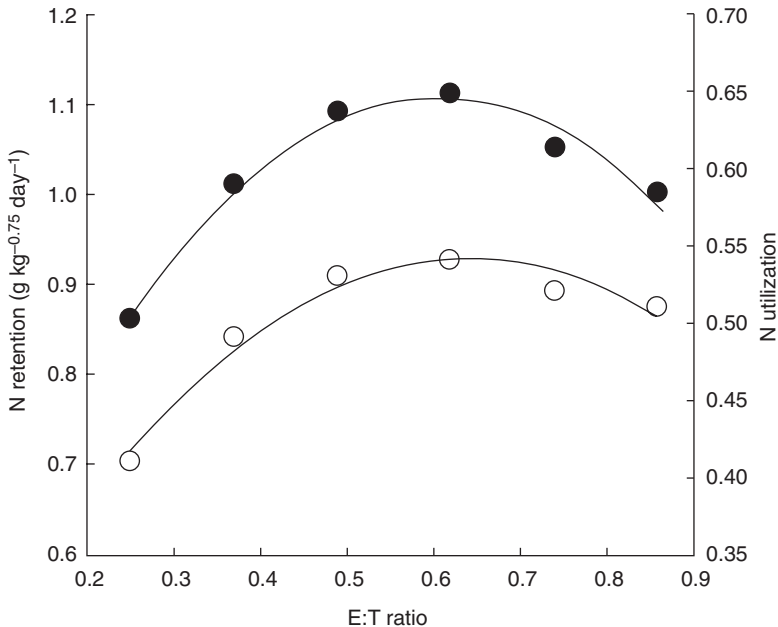


of essential amino acids on N retention in 10-kg piglets. They found that the young pigs utilized dietary N most efficiently when the E:T ratio was 0.40. In their experiment, however, only three animals per treatment were used. Wang and Fuller (1989) estimated the optimum E:T ratio in growing pigs fed isonitrogenous diets at four E:T values ranging from 0.34 to 0.58, using a rectilinear model to fit the data. Based on their results it can be concluded that the minimum E:T ratio required for maximum protein deposition is approximately 0.46. Lenis *et al.* (1999) measured N retention in pigs at three E:T ratios within three dietary N concentrations and concluded that, to attain maximum N retention and N utilization, the E:T ratio should be about 0.5. In their experiments, optimum E:T ratio tended to decrease with increasing dietary N concentration.

A more detailed study with pigs comprising six E:T ratios ranging from 0.25 to 0.86 was conducted by Heger *et al.* (1998). At a constant concentration of total dietary N

( $24.5 \text{ g kg}^{-1}$ ), the response of N retention to varying E:T ratios was curvilinear with a maximum corresponding to an E:T value of 0.61. A similar relationship was found for N utilization (Fig. 6.2). In the region around the optimum, however, the dose-response curves were flat and within the E:T range of 0.49–0.74 no significant difference between treatments was found. There are other experiments with pigs in which the optimum E:T ratio required for maximum N retention was estimated to be near 0.6 (Roth *et al.*, 1993; 1994b; Gotterbarm *et al.*, 1998).

Estimates of optimum E:T ratios for poultry were comparable to those found in rats and pigs. Stucki and Harper (1961) studied the effect of altering the E:T ratio on growth of chicks fed on purified diets containing  $153\text{--}302 \text{ g CP kg}^{-1}$ . They concluded that the growth rate was maximized when the E:T ratio was about 0.66. Dietary CP level had no significant effect on the response measured. However, the results of this experiment were confounded by using racemic forms of some

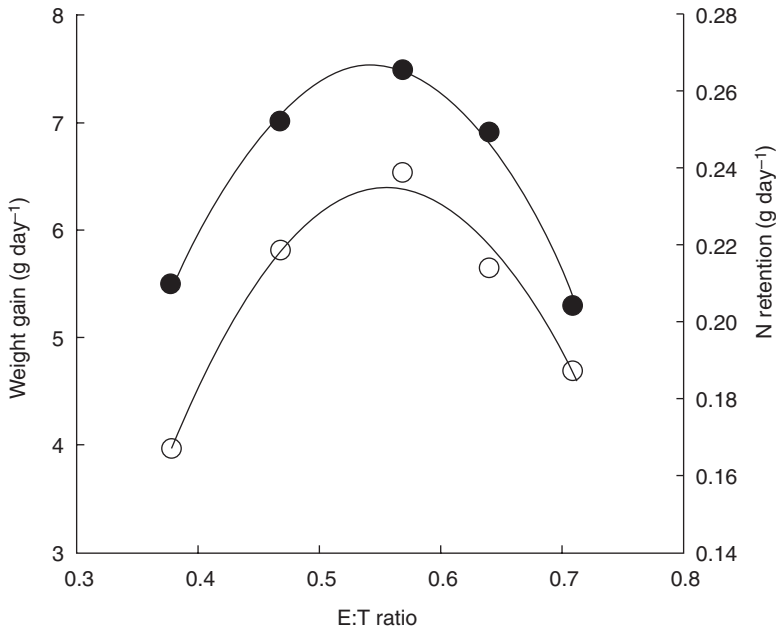


**Fig. 6.2.** Relationship between E:T ratio and N retention (●) or N utilization (○) in growing pigs at constant concentration of total dietary N. (From Heger *et al.*, 1998. Reproduced with permission of The Nutrition Society.)

essential and non-essential amino acids, D-isomers of essential amino acids being considered fully available for the chick. Later, Sugahara and Ariyoshi (1968) reassessed the results of Stucki and Harper (1961) taking into account the nutritional value of D-amino acids and concluded that the optimum E:T ratio was 0.57. In their own experiments, Sugahara and Ariyoshi (1968) studied growth rate, N retention and the concentration of amino acids in serum of chicks fed on isonitrogenous purified diets with E:T ratios ranging from 0.38 to 0.71. Weight gain and N retention responses to changing E:T values were similar (Fig. 6.3) and both reached their maximum at an E:T ratio of 0.56. The concentration of free amino acids in serum was considerably influenced by the diet composition. The sum of non-essential amino acids gradually decreased with the increasing E:T ratio, and the ratio of essential to non-essential amino acids broadly reflected their concentrations in the diet. At the highest E:T values, however, there was a decrease of the serum essential amino acid level, which indi-

cated that a proportion of the essential amino acids was converted into non-essential amino acids under these conditions. In turkeys, Bedford and Summers (1988) observed maximum growth rate and carcass protein deposition at an E:T ratio of about 0.6. Part of the glycine, however, was included into the essential amino acid group in this study.

A number of other experiments with poultry have been carried out to study the effect of adding non-essential amino acids to low-protein diets. Unlike rats and pigs, birds responded to a higher non-essential N supply (mostly as glutamate and/or glycine) by decreased feed intake and a moderate reduction in growth rate. Feed conversion, however, was improved and was comparable to that of a positive control (Parr and Summers, 1991; Han *et al.*, 1992; Huyghebaert and Pack, 1996; Aletor *et al.*, 2000). In most experiments, the addition of glutamate or a mixture of non-essential amino acids to low-protein diets decreased body fat content (Fancher and Jensen, 1989; Han *et al.*, 1992; Kerr and Kidd, 1999). However, no



**Fig. 6.3.** Relationship between E:T ratio and weight gains (●) or N retention (○) in chicks. (Plotted from data by Sugahara and Ariyoshi, 1968.)

such effect was observed in the study by Aletor *et al.* (2000). It seems that the response of chicks to the supplements of non-essential amino acids may depend on genotype (Leclercq *et al.*, 1994; Alleman *et al.*, 2000) or diet composition (Deschepper and de Groote, 1995).

Several conclusions can be drawn from studies aimed at estimating optimum E:T ratios in rats, pigs and poultry.

- Optimum E:T ratios for growth or protein deposition estimated at a constant level of total dietary N and using the same amino acid classification do not differ substantially between species, the mean value being 0.55–0.6.
- Optimum E:T ratio depends on dietary N concentration, being lower at higher dietary N and *vice versa*.
- There is a substantial range near the optimum within which the response to varying E:T ratio does not change appreciably.
- Both too low and too high E:T ratios have an adverse effect on performance.

Although the poor growth or N retention at low E:T ratios is clearly due to the deficiency of essential amino acids, the effect of high E:T ratios is not fully understood. It has been suggested that the synthesis of one or more amino acids commonly classified as non-essential might not be sufficient to maintain maximum growth rate (Adkins *et al.*, 1966), thus causing a reduction in protein deposition. However, there is no direct

experimental evidence supporting this premise. Another possibility is that the efficiency of conversion of some essential amino acids into non-essential amino acids is low, and limits the amount of non-essential N available at a given concentration of total dietary N. Even though there is compelling evidence that all essential amino acids can be converted into non-essential amino acids (Aqvist, 1951), experiments evaluating the process from the quantitative point of view suggest that the conversion efficiency of some essential amino acids is lower than that of non-essential amino acids. Comparing the efficacy of various sources of non-essential N in chicks using the slope-ratio assay, Allen and Baker (1974) found that arginine and lysine were poorly converted into non-essential N and none of the essential amino acids tested was as efficient as glutamate as a source of non-specific N (Table 6.1). Heger (1990) studied the effects of excessive amounts of essential amino acids on N retention and the biological value of protein in rats. The basal diet containing essential amino acids in proportions corresponding to an ideal protein pattern and supplemented with a small amount of non-essential N (E:T ratio 0.96) was inferior to a diet with E:T ratio of 0.65. However, when the levels of arginine, lysine or sulphur amino acids were reduced while maintaining total N concentration constant by supplements of a non-essential amino acid mixture, there was a significant increase in N retention and biological

**Table 6.1.** Utilization of various amino acids as sources of non-specific nitrogen for growing chicks relative to L-glutamate. (From Allen and Baker, 1974. Reproduced with permission of the Poultry Science Association.)

Amino acid	Gain per g N consumed (g) <sup>a</sup>	Ratio
L-Glutamate	38.16	1.00
L-Proline	37.69	0.99
Glycine	36.62	0.96
L-Valine	27.87	0.73
L-Isoleucine	26.11	0.68
L-Leucine	23.72	0.62
L-Lysine.HCl	19.07	0.50
L-Arginine.HCl	13.89	0.36

<sup>a</sup>Regression coefficient relating weight gain to N intake of amino acid tested.

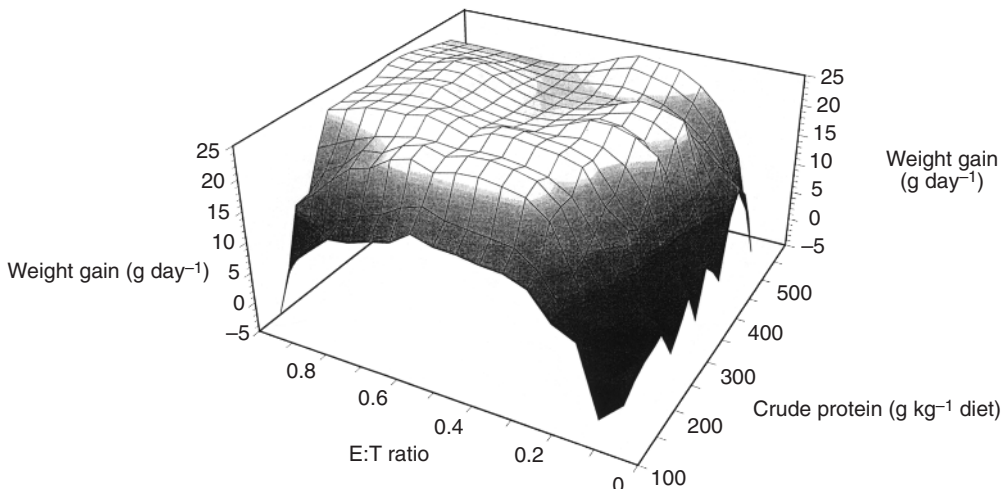
value. This suggests that arginine, lysine and sulphur amino acids are either a poor source of non-essential N or that their excess has an adverse effect on protein deposition.

To elucidate this problem in a greater detail, Taylor and his associates (Taylor *et al.*, 1996, 1997, 1998; Rogers *et al.*, 1998) conducted a series of experiments with kittens in which they studied the effect of E:T ratios ranging from 0.11 to 1.0 on weight gains and plasma amino acid pattern. In plasma of kittens fed on diets containing essential amino acids as a sole source of N, a much higher concentration of methionine and an increased concentration of arginine was found as compared to a control. This led Taylor *et al.* (1996) to conclude that the poor growth associated with diets having high E:T ratios was the result of an adverse effect of excess methionine and arginine and not an inability to synthesize non-essential amino acids. The subsequent experiments demonstrated that 'near maximal' weight gain could be achieved without any non-essential amino acids in the diet if excesses of methionine and arginine were avoided (Taylor *et al.*, 1996, 1998). As shown in Fig. 6.4 which is a compilation of data from six experiments by Taylor *et al.* (1997, 1998) adjusted relative to the performance of control groups, there is a broad

range of E:T values and dietary crude protein concentrations within which a high growth rate of kittens can be attained as long as an excess of amino acids causing growth depression is prevented.

To date, it is not clear whether these findings can be generalized or if there are some interspecific differences. It has been demonstrated that the negative effect of amino acid excess on growth rate is almost entirely due to the reduction of voluntary feed intake (Fisher *et al.*, 1960; Cieslak and Benevenga, 1984) as was also the case in experiments by Taylor *et al.* (1996). On the other hand, an increased intake of arginine, lysine or sulphur amino acids had no adverse effect on feed intake in rats or chicks (Allen and Baker, 1974; Heger, 1990). It seems therefore that poor growth and N retentions observed when feeding diets with high E:T ratios result at least partly from the low availabilities of these amino acids as sources of non-essential N.

The low utilization of arginine as a source of non-essential N is not surprising since this amino acid is closely associated with the synthesis of urea. Only about half the arginine supplied in the diet is available for the synthesis of non-essential amino acids, the rest being obligatorily converted into urea (Stein *et al.*, 1986). Urea itself is known to be a poor



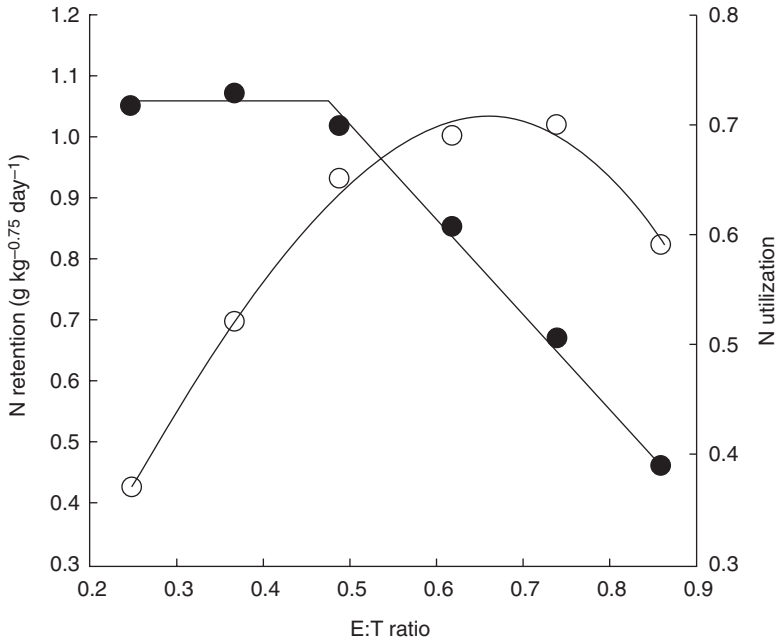
**Fig. 6.4.** Effect of E:T ratio and dietary crude protein on weight gains of kittens. (From Rogers *et al.*, 1998. Reproduced with permission of the American Society for Nutritional Sciences.)

source of N for the synthesis of non-essential amino acids (Allen and Baker, 1974). The nitrogen of sulphur amino acids is either incorporated into urea after it is released as ammonia or is used for the synthesis of polyamines and taurine. None of the catabolic pathways of methionine or cystine appears to be quantitatively important for amino acid synthesis in mammals (Stipanuk, 1986).

### Effect of E:T Ratio on Protein and Amino Acid Utilization

In studies with isonitrogenous diets, the estimates of optimum E:T ratios required for protein deposition did not differ from those for protein utilization (Sugahara and Ariyoshi, 1968; Wang and Fuller, 1989; Heger *et al.*, 1987, 1998; Gotterbarm *et al.*, 1998; Lenis *et al.*, 1999). However, when essential N was held constant and E:T ratio was altered by changing total dietary N, a considerably lower E:T ratio was needed for maximum N reten-

tion than for optimum N utilization. Thus in rats fed on diets meeting the requirements for essential amino acids, maximum N retention was attained at an E:T ratio of 0.38, whereas an E:T ratio of 0.51 was needed for maximum biological value of protein (Heger *et al.*, 1987). In a similarly designed experiment with pigs (Heger *et al.*, 1998) the highest N retentions were observed at E:T ratios not exceeding 0.48 whereas maximum total N utilization, measured as N retention relative to N ingested was found at an E:T ratio of 0.66 (Fig. 6.5). A similar response was observed by Roth *et al.* (1993) who estimated the minimum amount of total N required for maximum N retention in growing pigs. They used practical-type diets with constant concentrations of essential amino acids in which crude protein level was gradually reduced in seven steps from 170 g kg<sup>-1</sup> to 100 g kg<sup>-1</sup>. Maximum N retention was attained at an E:T ratio of 0.59 whereas an E:T ratio of 0.71 was needed for maximum biological value of protein. N excretion at maximum N retention



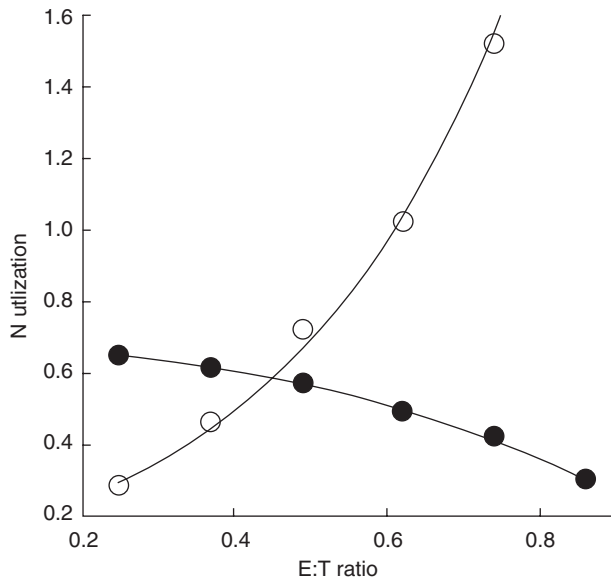
**Fig. 6.5.** Relationship between E:T ratio and N retention (●) or N utilization (○) in growing pigs at constant concentration of essential dietary N. (From Heger *et al.*, 1998. Reproduced with permission of The Nutrition Society.)

was significantly higher than that at maximum N utilization. Further studies by Roth and his associates (Roth *et al.*, 1994b, 1999) as well as those of other authors (Mitchell *et al.*, 1968; Lenis *et al.*, 1999) also demonstrated that, at essential amino acid intakes corresponding to the requirement, a lower E:T ratio and therefore higher total N intake was needed for maximum N retention than for maximum protein utilization.

The response of N retention to changes in E:T ratio at constant concentration of essential N (Fig. 6.5) indicates that protein deposition is maintained at the maximum level until either non-essential or total N becomes limiting. Then there is a linear decrease, apparently arising from the conversion of a proportion of essential amino acids into non-essential amino acids required for the synthesis of body protein. The low utilization of total N at low E:T ratios is presumably due to the surplus of non-essential amino acids, which are partly degraded under these conditions. On the other hand, when the optimum E:T ratio is exceeded, N utilization decreases as a result of non-essential amino acid deficiency. A signifi-

cantly lower E:T value corresponding to the breakpoint in N retention as compared to E:T value required for maximum N utilization suggests that non-essential N has a 'sparing effect' on the utilization of essential amino acids.

To clarify this phenomenon, it is useful to explore the relationships between the utilizations of essential, non-essential and total N. As shown in Fig. 6.6, the utilization of essential N gradually decreases as the E:T ratio increases whereas the utilization of non-essential N exhibits a sharp increase. At an E:T ratio of 0.66 corresponding to maximum total N utilization, less than 0.5 of essential amino acid N is utilized, whereas the non-essential N utilization exceeds 1.0. This implies that a proportion of the essential amino acids is used for the synthesis of non-essential amino acids under these conditions. Similar conclusions were drawn by Lenis *et al.* (1999) who studied the effects of three E:T ratios on total, essential and non-essential N utilization in growing pigs at three levels of total dietary N. This procedure allowed a comparison of the changes in N utilization at constant concentrations of both total and essential N. They



**Fig. 6.6.** Relationship between E:T ratio and the utilization of essential (●) or non-essential (○) N in growing pigs at constant concentration of essential dietary N. (From Heger *et al.*, 1998. Reproduced with permission of The Nutrition Society.)

found that the efficiency of essential N utilization decreased with increasing E:T ratio in both cases, but was compensated by an increased utilization of non-essential N, so that the total N utilization remained unchanged. A similar relationship between the essential and non-essential N utilization at constant concentrations of total or essential dietary N was found in experiments with rats (Heger and Frydrych, 1989) but the information regarding other species is lacking.

The low utilization of essential amino acids at the optimum E:T ratio for the utilization of total dietary N is rather surprising. It is generally accepted that the efficiency of utilization of essential amino acids is higher than that of non-essential amino acids (McFarlane and von Holt, 1969; Aguilar *et al.*, 1972). It has been shown, however, that a proportion of the essential amino acids is inevitably degraded even at suboptimal levels of intake (Kang-Lee and Harper, 1978; Harper and Benjamin, 1984; Tanaka *et al.*, 1995). These losses are supposed to be an inevitable consequence of the presence in tissues of amino acid-degrading enzymes that are part of the mechanisms regulating protein metabolism in response to quantitative and qualitative changes in protein supply (Heger and Frydrych, 1989). It seems that these inevitable losses can be partly or fully counterbalanced by the synthesis of non-essential amino acids from nitrogen released during essential amino acid catabolism. Thus the organism is able to conserve nitrogen that would otherwise be lost, thereby maximizing the overall efficiency of utilization of the ingested protein (Heger

and Frydrych, 1989; Roth *et al.*, 1993). Differences between optimum E:T ratios in diets and those calculated from amino acid composition of body protein may serve as an indirect evidence of this hypothesis. The E:T ratios of body protein (Table 6.2) tend to be lower than those required for maximum growth or protein deposition. This supports an assumption that a proportion of ingested essential amino acids is converted into the non-essential amino acids that are incorporated into body protein.

Another factor that may be related to the 'sparing effect' of non-essential amino acids is endogenous protein loss. The major part of endogenous protein originates from deconjugated bile salts and mucin glycoproteins that are resistant to enzymatic hydrolysis. While glycine accounts for more than 90% of the total amino acid content of bile (Souffrant, 1991), the mucin proteins contain high proportions of proline and serine (Robertson *et al.*, 1991). The E:T ratio calculated from the amino acid composition of endogenous protein is therefore lower than that of body protein and ranges from 0.43 to 0.52 (Leterme *et al.*, 1996; Hess and Sève, 1999; Stein *et al.*, 1999). It is possible that non-essential N is one of the factors limiting the utilization of amino acids released by protein breakdown. Thus an increased supply of non-essential N may increase N retention by optimizing the amino acid balance of the precursor pool available for the resynthesis of body protein. Even though this mechanism is more likely to operate at near-maintenance conditions, its effect at higher protein intakes cannot be excluded.

**Table 6.2.** E:T ratios of body and endogenous proteins.

	E:T ratio	Reference
Rat carcass	0.55	Pellet and Kaba (1972)
Pig whole body	0.54	Kyriazakis and Emmans (1993)
Pig empty body gain	0.54	Bikker <i>et al.</i> (1994)
Chick whole body	0.56	Moran (1995)
Turkey whole body	0.56	Moran (1995)
Pig endogenous protein <sup>a</sup>	0.44	Stein <i>et al.</i> (1999)
Pig endogenous protein <sup>b</sup>	0.47	Hodgkinson <i>et al.</i> (2000)

<sup>a</sup>Fed on protein-free diet.

<sup>b</sup>Fed on enzyme-hydrolysed casein 100 g kg<sup>-1</sup>.

The higher N retention at low E:T ratios and constant concentration of essential N might also result from the adaptive response of the organism to the excessive intake of non-essential amino acids. It has been demonstrated that the size and protein content of internal organs increase with increasing supply of dietary protein (Noblet *et al.*, 1987; Kerr *et al.*, 1995). An increased N retention was observed in chicks (Shapiro and Fisher, 1962) and pigs (Kerr and Easter, 1995) when non-essential amino acids were added to the diet. The accumulation of 'labile protein reserves' occurs over several days after a change in diet (Munro, 1964), and could affect N retention, particularly in short-term balance experiments. However, a 14-day adaptation period followed by a 7-day collection period, as used in the experiment of Lenis *et al.* (1999) seems to be long enough to counter the effect of 'labile protein' accumulation.

The current ideal protein concept is supposed to be equally applicable both to maximum N retention (or growth rate) and maximum N utilization (or minimum N excretion). This is undoubtedly the case of essential amino acid pattern. However, the optimum proportions of essential and non-essential amino acids for these functions are apparently different and the definition of ideal protein including the non-essential N requirement should reflect this fact. This could be of help in formulating practical diets aimed at achieving maximum growth rate or minimum N excretion.

### Optimum E:T Ratio for Maintenance

There is convincing evidence to show that the essential amino acid pattern required for maintenance differs considerably from that for protein deposition. Even though there are no quantitative estimates of optimum E:T ratio for maintenance available, indirect evidence suggests that, at near-maintenance conditions, a greater proportion of non-essential amino acids is needed than under conditions of rapid growth. As shown in Table 6.3 which summarizes amino acid requirement data for humans (FAO/WHO/UNU, 1985), the relative essential amino acid requirements gradually decrease with advancing age and with the increasing contribution of maintenance to total amino acid needs. In adults, requiring amino acids predominantly for maintenance purposes, the essential N to total dietary N ratio is only 0.11. Although the ratios presented in Table 6.3 are based on a 'safe level' of protein intake that exceeds the minimum required for attaining N equilibrium, they clearly show that the E:T ratio for maintenance is considerably lower than that for combined processes of maintenance and growth.

Estimates of essential N to total N ratios for maintenance in rats, pigs, and chicks derived from the minimal metabolic needs for essential amino acids and for total N are given in Table 6.4. The data are in general agreement with those calculated for humans, suggesting the importance of non-essential amino

**Table 6.3.** Estimates of essential amino acid requirements for humans ( $\text{mg g}^{-1}$  protein) and calculated essential N to total N ratios. (From FAO/WHO/UNU, 1985.)

Amino acid	Infant (3–4 months)	Preschool (2–5 years)	School (10–12 years)	Adult
Histidine	26	19	19	16
Isoleucine	46	28	28	13
Leucine	93	66	44	19
Lysine	66	58	44	16
Methionine + cystine	42	25	22	17
Phenylalanine + tyrosine	72	63	22	19
Threonine	43	34	28	9
Tryptophan	17	11	9	5
Valine	55	35	25	13
Essential N : total N	0.37	0.27	0.21	0.11



**Table 6.4.** Essential N to total N ratios for maintenance of various species calculated from maintenance requirements for essential amino acids and for total N.

	Essential N : total N	Source of data
Rat	0.23	NRC (1995)
Pig	0.13	Fuller <i>et al.</i> (1989)
Chick	0.26	McDonald and Morris (1985) <sup>a</sup> Leveille and Fisher (1958) <sup>b</sup>

<sup>a</sup>Essential amino acids.

<sup>b</sup>Total N.

acids for processes associated with maintenance. However, it should be pointed out that these estimates may be subject to considerable error. So far, only a few data on the maintenance requirement of essential amino acids are available and the experiments conducted gave rather variable results. The same is true for the maintenance requirement for total N. Thus in pigs, the estimates of obligatory N losses range from 150 mg N kg<sup>-0.75</sup> (ARC, 1981; Stranks *et al.*, 1988) to 268 mg N kg<sup>-0.75</sup> (Fuller *et al.*, 1989). Further studies are needed to establish the optimum E:T ratio for maintenance more precisely.

The differences in E:T ratios for growth and for maintenance presumably result from differences in protein metabolism under these physiological conditions. At nitrogen equilibrium, skeletal muscle proteins are degraded to provide amino acids for the synthesis of endogenous protein (De Lange *et al.*, 1989). Losses of endogenous N are the single most important factor contributing to the N requirement for maintenance (Nyachoti *et al.*, 1997). However, amino acid patterns and E:T ratios of muscle and endogenous proteins are different. Endogenous protein contains more sulphur amino acids and threonine but the sum of essential amino acids and consequently the E:T ratio is lower (Table 6.2). As a result of endogenous N losses, sulphur amino acids, threonine and non-essential N nitrogen may become a limiting factor for reutilization of other amino acids released during protein breakdown. Indeed, it has been shown that the addition of methionine and threonine to a nitrogen-free diet improved N retention in rats (Yoshida and Moritoki, 1974; Yokogoshi and Yoshida, 1976) and that the addition of non-

essential amino acids to a nitrogen-free diet supplemented with small amounts of methionine, threonine and tryptophan resulted in a marked increase in N retention in pigs (Křížová *et al.*, 2001). The importance of non-essential amino acids for maintenance was also indicated in studies with chicks by Baker *et al.* (1996) and Edwards *et al.* (1997, 1999) in which zero N retention was associated with negative retention of essential amino acids and positive retention of non-essential amino acids.

There is also increasing evidence that amino acids are involved in processes that are not directly related to protein metabolism itself. Since the free amino acid pool is derived from proteolysis of peripheral tissues under conditions close to protein equilibrium, all amino acids are equally limiting. Withdrawal of any single amino acid outside the protein metabolism limits the ability of the organism to reutilize all others (Reeds, 2000). In this respect, both essential and non-essential amino acids are equally important. The participation of amino acids in specific physiological functions not related to protein metabolism has not been sufficiently documented. Reeds and Hutchens (1994) and Reeds (2000) defined several systems critical for maintaining health and functional integrity of the organism such as the intestine, skeletal muscle, immune system and central nervous system and identified specific amino acids necessary for the functioning of these systems. It is noteworthy that the intermediates involved in the operation of these systems (e.g. ATP, creatine, nucleic acids, glutathione, nitric oxide, taurine, mucin) are almost exclusively the end products of the non-essential or semi-

essential amino acid metabolism. Although the production of some intermediates may be negligible from the quantitative point of view, the non-protein role of non-essential amino acids seems to be an important factor contributing to the increased needs for non-essential N under maintenance conditions.

### **The Importance of Individual Non-essential Amino Acids**

It is not quite clear so far to what extent the requirement for total non-essential N can be influenced by the presence or absence of different non-essential amino acids. There are a number of studies indicating that some amino acids, commonly classified as non-essential, may have essential character (Breuer *et al.*, 1964; Newburg *et al.*, 1975; Ball *et al.*, 1986; Roth *et al.*, 1994a) whereas some others are inferior as sources of non-specific N (Sugahara and Ariyoshi, 1967b; Allen and Baker, 1974). Therefore, both the specific requirements for non-essential amino acids and the value of these amino acids in supplying the organism with non-specific nitrogen should be taken into account when studying the optimum E:T ratio and formulating amino acid diets.

Results of studies aimed at identification of non-essential amino acids needed for normal performance have been controversial. The requirement for proline has been demonstrated in rats (Breuer *et al.*, 1964; Heger *et al.*, 1987), chicks (Sugahara and Ariyoshi, 1967a; Graber and Baker, 1973) and piglets (Ball *et al.*, 1986; Kirchgessner *et al.*, 1995), but in other experiments no effect of proline was found (Samuels *et al.*, 1989; Chung and Baker, 1993). This discrepancy might be due to the differences in dietary levels of metabolically related amino acids. Rogers *et al.* (1970) found in rats that if two amino acids of the proline-arginine-glutamate group were omitted from the diet, growth was markedly reduced. However, if the diet contained sufficient amounts of arginine and glutamate, the lack of proline had no effect on growth. Contrary to this finding, the adverse effects of proline deficiency in chicks were not eliminated even when the diet was supplemented with glutamate

(Bhargava *et al.*, 1971), arginine or ornithine (Austic, 1976). Glutamate plays an important role in protein metabolism since it serves as the main medium in amino-N exchange and is readily converted into other non-essential amino acids. There are some studies indicating the need for glutamate in rats (Hepburn and Bradley, 1964), chicks (Graber and Baker, 1973; Maruyama *et al.*, 1976) and piglets (Roth *et al.*, 1994a). It seems, however, that its presence in the diet is not necessary if the diet contains sufficient amounts of proline and arginine (Rogers *et al.*, 1970; Heger *et al.*, 1987).

The asparagine requirement has been demonstrated in growing rats by Breuer *et al.* (1966), Rogers and Harper (1965), Frankel *et al.* (1973) and Newburg *et al.* (1975), although Salmon (1964) and Ranhotra and Johnson (1965) failed to observe any requirement. In the study by Rogers *et al.* (1970) asparagine clearly stimulated growth in one experiment, yet was without any effect in another experiment. Newburg *et al.* (1975) investigated the effects of asparagine, aspartic acid, glutamine and glutamate in all possible combinations on growth of weanling rats, and concluded that only asparagine is essential regardless of the presence or absence of any combination of other related amino acids. No asparagine requirement has been reported for adult rats or other species.

Glycine is regarded as a good source of non-specific nitrogen (Allen and Baker, 1974) but there are no indications of its requirements for mammalian species (Heger *et al.*, 1987; Roth *et al.*, 1994a). A positive effect of glycine addition to diets with a high concentration of essential amino acids observed in kittens (Taylor *et al.*, 1996) probably resulted from the ability of glycine to alleviate the toxic effects associated with excessive intake of sulphur amino acids (Benevenga and Steele, 1984). In poultry, glycine has been classified as a semi-essential amino acid by some authors (Graber and Baker, 1973; NRC, 1994). An increased demand for glycine supply in poultry is associated with the synthesis of uric acid as the primary end product of protein catabolism in avian species that may consume a considerable amount of glycine, particularly when fed high-protein diets.

To date, it is not known whether there is a specific requirement for non-essential and semi-essential amino acids for maintenance. It is generally believed that, owing to the low needs for total N under maintenance conditions, both non-essential and semi-essential amino acids can be readily synthesized from their precursors. However, as discussed earlier, the maintenance requirement for non-essential N is relatively high and the synthesis of some non-essential or semi-essential amino acid(s) may not be sufficient to meet endogenous losses and specific requirements not related to protein metabolism. Indeed, preliminary studies with pigs (J. Heger, L. Křížová and K. Šimeček, unpublished observations) at near-maintenance conditions have shown that the deletion of arginine, proline or glutamate from a purified diet resulted in a significant decrease in N retention even though the concentration of total non-essential N was maintained at a sufficiently high level.

### Conclusions

The intake of non-essential amino acids is a quantitatively important part of total protein intake and the proportion of non-essential N in total dietary N can significantly affect animal performance. The contradictory data on the optimum ratio between essential and non-essential amino acids for growth and protein deposition published in the literature arise mostly from different ways of expressing their relationships and defining their essentiality. When expressing the relations between both amino acid groups as a ratio of essential N to total amino acid N (E:T), the estimates of optimum E:T values are similar both within and among species. Unlike the ideal essential

amino acid pattern which is independent of dietary factors and the type of response measured, the optimum E:T ratio is not universally valid. At a constant concentration of total dietary N, approximately the same E:T ratio is required for maximum growth rate, protein deposition or total protein utilization. However, at a constant concentration of essential N allowing rapid growth, higher non-essential N intake and consequently lower E:T ratio is needed for maximum N retention than for optimum protein utilization. Nutritional strategies aimed at achieving maximum growth rate or minimum N excretion should take these facts into consideration.

Most experiments investigating the relationships between essential and non-essential amino acids have been conducted with growing animals. Very little is known about optimum E:T ratios for other physiological functions such as maintenance or reproduction or about the role of non-essential and semi-essential amino acids in processes not directly related to protein metabolism. There is indirect evidence suggesting that the relative requirement for non-essential N for maintenance is considerably higher than that for growth. However, experimentally based estimates of optimum E:T ratio for maintenance are not available. It seems also that some non-essential amino acids may have essential character under certain conditions including maintenance but their physiological role has not been fully elucidated. Nevertheless, there is increasing evidence that the assumption of mutual interconversion of non-essential amino acids as sources of non-specific N may not be entirely valid and that a certain amount of non-essential amino acids must be supplied preformed in the diet to achieve maximum utilization of dietary protein.

### References

- Adkins, J.S., Wertz, J.M. and Hove, E.L. (1966) Influence of nonessential L-amino acids on growth of rats fed high levels of essential amino acids. *Proceedings of the Society for Experimental Biology and Medicine* 122, 519–523.
- Adkins, J.S., Wertz, J.M., Boffman, R.H. and Hove, E.L. (1967) Influence of addition of water or 'nonessential' nitrogen on growth of rats fed low levels of essential L-amino acids. *Proceedings of the Society for Experimental Biology and Medicine* 126, 500–504.
- AFRC (Agricultural and Food Research Council) (1987) Technical committee on responses to nutrients No

- 2, Characterisation of feedstuffs: nitrogen. *Nutrition Abstracts and Reviews, Series B: Livestock Feeds and Feeding* 57, 713–736.
- Aguilar, T.S., Harper, A.E. and Benevenga, N.J. (1972) Efficiency of utilization of indispensable amino acids for growth by the rat. *Journal of Nutrition* 102, 1199–1208.
- Aletor, V.A., Hamid, I., Niess, E. and Pfeffer, E. (2000) Low-protein amino acid-supplemented diets in broiler chickens: effects on performance, carcass characteristics, whole body composition and efficiencies of nutrient utilisation. *Journal of the Science of Food and Agriculture* 80, 547–554.
- Alleman, F., Michel, J., Chagneau, A.M. and Leclercq, B. (2000) The effects of dietary protein independent of essential amino acids on growth and body composition in genetically lean and fat chickens. *British Poultry Science* 41, 214–218.
- Allen, N.K. and Baker, D.H. (1974) Quantitative evaluation of nonspecific nitrogen sources for the growing chick. *Poultry Science* 53, 258–264.
- Anderson, P.A., Baker, D.H., Sherry, P.A. and Corbin, J.E. (1980) Nitrogen requirement of the kitten. *American Journal of Veterinary Research* 41, 1646–1649.
- Aqvist, S.E.G. (1951) Metabolic interrelationships among amino acids studied with isotopic nitrogen. *Acta Chimica Scandinavica* 5, 1046–1064.
- ARC (Agricultural Research Council) (1981) *The Nutrient Requirements of Pigs*. Commonwealth Agricultural Bureaux, Farnham Royal, Slough.
- Austic, R.E. (1976) Nutritional and metabolic interrelationships of arginine, glutamic acid and proline in the chicken. *Federation Proceedings* 35, 1914–1976.
- Baker, D.H., Fernandez, S.R., Parsons, C.M., Edwards, H.M., III, Emmert, J.L. and Webel, D.M. (1996) Maintenance requirement for valine and efficiency of its use above maintenance for accretion of whole body valine and protein in young chicks. *Journal of Nutrition* 126, 1844–1851.
- Ball, R.O., Atkinson, J.L. and Bayley H.S. (1986) Proline as an essential amino acid for the young pig. *British Journal of Nutrition* 55, 659–668.
- Batterham, E.S. (1994) Protein and energy relationships for growing pigs. In: Cole, D.J.A., Wiseman, J. and Varley, M.A. (eds) *Principles of Pig Science*. Nottingham University Press, Nottingham, pp. 107–121.
- Bedford, M.R. and Summers, J.D. (1985) Influence of the ratio of essential to non-essential amino acids on performance and carcass composition of the broiler chick. *British Poultry Science* 26, 483–491.
- Bedford, M.R. and Summers, J.D. (1986) Effect of altering the sources of nonessential nitrogen on performance and carcass composition of the broiler chick. *Canadian Journal of Animal Science* 66, 1097–1106.
- Bedford, M.R. and Summers, J.D. (1988) The effect of the essential to nonessential amino acid ratio on turkey performance and carcass composition. *Canadian Journal of Animal Science* 68, 899–906.
- Benevenga, N.J. and Steele, R.D. (1984) Adverse effects of excessive consumption of amino acids. *Annual Review of Nutrition* 4, 157–181.
- Bhargava, K.K., Shen, T.F., Bird, H.R. and Sunde, M.L. (1971) Effect of glutamic acid on chick's proline requirement. *Poultry Science* 50, 726–731.
- Bikker, P., Verstegen, M.W.A. and Bosch, M.W. (1994) Amino acid composition of growing pigs is affected by protein and energy intake. *Journal of Nutrition* 124, 1961–1969.
- Boisen, S. (1997) Ideal protein – and its suitability to characterize protein quality in pig feeds. A review. *Acta Agriculturae Scandinavica, Sect. A, Animal Science* 47, 31–38.
- Breuer, L.H., Pond, W.G., Warner, R.G. and Loosli, J.K. (1964) The role of dispensable amino acids in the nutrition of the rat. *Journal of Nutrition* 82, 499–506.
- Breuer, L.H., Warner, R.G., Benton, D.A. and Loosli, J.K. (1966) Dietary requirement for asparagine and its metabolism in rats. *Journal of Nutrition* 88, 143–150.
- Chung, T.K. and Baker, D.H. (1993) A note on the dispensability of proline for weanling pigs. *Animal Production* 56, 407–408.
- Cieslak, D.G. and Benevenga, N.J. (1984) The effect of amino acid excess on utilization by the rat of the limiting amino acid – lysine and threonine at equalized food intakes. *Journal of Nutrition* 114, 1878–1883.
- Cole, D.J.A. and Van Lunen, T.A. (1994) Ideal amino acid patterns. In: D'Mello, J.P.F. (ed.) *Amino Acids in Farm Animal Nutrition*. CAB International, Wallingford, UK, pp. 99–112.
- Daniel, V.A., Doraiswamy, T.R., Swaminathan, M. and Rajauakshmi, D. (1970) The effect of dilution of milk proteins with non-essential amino acids (L-alanine and L-glutamic acid) on nitrogen retention and biological value of the proteins in children. *British Journal of Nutrition* 24, 741–747.

- De Lange, C.F.M., Sauer, W.C. and Souffrant, W.B. (1989) The effect of protein status of the pig on the recovery and amino acid composition of endogenous protein in digesta collected from the distal ileum. *Journal of Animal Science* 67, 755–762.
- Deschepper, K. and de Groote, G. (1995) Effect of dietary protein, essential and non-essential amino acids on the performance and carcass composition of male broiler chickens. *British Poultry Science* 36, 229–245.
- Dove, H., Pearce, G.R. and Tribe, D.E. (1977a) Utilization of amino acids by preruminant lambs. I. The effect of alterations in total essential amino acid intake at constant nitrogen intake. *Australian Journal of Agricultural Research* 28, 917–932.
- Dove, H., Pearce, G.R. and Tribe, D.E. (1977b) Utilization of amino acids by preruminant lambs. II. The effects of independent alterations in total nitrogen and total essential amino acid intake. *Australian Journal of Agricultural Research* 28, 933–946.
- Edwards, H.M., III, Baker, D.H., Fernandez, S.R. and Parsons, C.M. (1997) Maintenance threonine requirement and efficiency of its use for accretion of whole-body threonine and protein in young chicks. *British Journal of Nutrition* 78, 111–119.
- Edwards, H.M., III, Fernandez, S.R. and Baker, D.H. (1999) Maintenance lysine requirement and efficiency of using lysine for accretion of whole-body lysine and protein in young chicks. *Poultry Science* 78, 1412–1417.
- Fancher, B.L. and Jensen, L. (1989) Male broiler performance during the starting and growing periods as affected by dietary protein, essential amino acids, and potassium levels. *Poultry Science* 68, 1385–1395.
- FAO/WHO/UNU (1985) *Energy and Protein Requirements. Report of a Joint FAO/WHO/UNU Expert Consultation*, Technical Report Series 724, World Health Organization, Geneva, 206 pp.
- Fisher, H., Griminger, P., Leveille, G.A. and Shapiro, R. (1960) Quantitative aspects of lysine deficiency and amino acid imbalance. *Journal of Nutrition* 71, 213–220.
- Frankel, D.L., Wells, H. and Fillios, L.C. (1973) Concentrations of asparagine in tissues of prepubertal rats after enzymic or dietary depletion of asparagine. *Biochemical Journal* 132, 645–648.
- Frost, D.V. and Sandy, H.R. (1951) Utilisation of non-specific nitrogen sources by the adult protein-depleted rat. *Journal of Biological Chemistry* 189, 249–260.
- Fuller, M.F., McWilliam, R., Wang, T.C. and Giles, L.R. (1989) The optimum dietary amino acid pattern for growing pigs. 2. Requirements for maintenance and for tissue protein accretion. *British Journal of Nutrition* 62, 255–267.
- Gotterbarm, G.G., Roth, F.X. and Kirchgessner, M. (1998) Influence of the ratio of indispensable:dispensable amino acids on whole-body protein turnover in growing pigs. *Journal of Animal Physiology and Animal Nutrition* 79, 174–183.
- Graber, G. and Baker, D.H. (1973) The essential nature of glycine and proline for growing chickens. *Poultry Science* 52, 892–896.
- Greenstein, J.P., Birnbaum, S.M., Winitz, M. and Otey, M.C. (1957) Quantitative nutritional studies with water-soluble chemically defined diet. I. Growth, reproduction and lactation in rats. *Archives of Biochemistry and Biophysics* 172, 396–416.
- Han, Y., Suzuki, H., Parsons, C.M. and Baker, D.H. (1992) Amino acid fortification of a low-protein corn and soybean meal diet for chicks. *Poultry Science* 71, 1168–1178.
- Harper, A.E. and Benjamin, E. (1984) Relationship between intake and rate of oxidation of leucine and  $\alpha$ -isocaproate in vivo in the rat. *Journal of Nutrition* 114, 431–440.
- Heger, J. (1990) Non-essential nitrogen and protein utilization in the growing rat. *British Journal of Nutrition* 64, 653–661.
- Heger, J. and Frydrych, Z. (1989) Efficiency of utilization of amino acids. In: Friedman, M. (ed.) *Absorption and Utilization of Amino Acids*. CRC Press, Boca Raton, Florida, pp 31–56.
- Heger, J., Frydrych, Z. and Fronek, P. (1987) The effect of nonessential nitrogen on the utilization of dietary protein in the growing rat. *Journal of Animal Physiology and Animal Nutrition* 57, 130–139.
- Heger, J., Mengesha, S. and Vodehnal, D. (1998) Effect of essential:total nitrogen ratio on protein utilization in the growing pig. *British Journal of Nutrition* 80, 537–544.
- Hegsted, D.M. (1944) Growth in chicks fed amino acids. *Journal of Biological Chemistry* 156, 247–252.
- Hepburn, F.N. and Bradley, W.B. (1964) The glutamic acid and arginine requirement for high growth rate of rats fed amino acid diets. *Journal of Nutrition* 84, 305–312.
- Hess, V. and Sève, B. (1999) Effects of body weight and feed intake level on basal ileal endogenous losses in growing pigs. *Journal of Animal Science* 77, 3281–3288.

- Hodgkinson, S.M., Moughan, P.J., Reynolds, G.W. and James, K.A.C. (2000) The effect of dietary peptide concentration on endogenous ileal amino acid loss in the growing pig. *British Journal of Nutrition* 83, 421–430.
- Huyghebaert, G. and Pack, M. (1996) Effects of dietary protein content, addition of nonessential amino acids and dietary methionine to cysteine balance on responses to dietary sulphur-containing amino acids in broilers. *British Poultry Science* 37, 623–639.
- Ikemoto, S., Miyashita, M., Yamanaka, C., Shizuka, F., Kido, Y., Kishi, K., Sogawa, Y., Kori, H. and Yamamoto, S. (1989) Optimal ratios of essential to total amino acids for amino acid mixtures given to rats. *Nutrition Reports International* 39, 477–486.
- Kang-Lee, Y.A. and Harper, A.E. (1978) Effect of histidine intake and hepatic histidase activity on the metabolism of histidine *in vivo*. *Journal of Nutrition* 107, 1427–1443.
- Kerr, B.J. and Easter, R.A. (1995) Effect of feeding reduced protein, amino acid-supplemented diets on nitrogen and energy balance in grower pigs. *Journal of Animal Science* 73, 3000–3008.
- Kerr, B.J. and Kidd, M.T. (1999) Amino acid supplementation of low-protein broiler diets: 1. Glutamic acid and indispensable amino acid supplementation. *Journal of Applied Poultry Research* 8, 298–309.
- Kerr, B.J., McKeith, F.K. and Easter, R.A. (1995) Effect on performance and carcass characteristics of nursery to finisher pigs fed reduced crude protein, amino acid-supplemented diets. *Journal of Animal Science* 73, 433–440.
- Kies, C.V. and Linkswiler, H.M. (1965) Effect on nitrogen retention of men of altering the intake of essential amino acids with total nitrogen held constant. *Journal of Nutrition* 85, 139–144.
- Kinsey, U.E. and Grant, W.M. (1944) Adequacy of the essential amino acids for growth of the rat. *Science* 99, 303–305.
- Kirchgessner, M., Fickler, J. and Roth, F.X. (1995) Einfluss der Prolinzufuhr auf die N-Bilanz von Ferkeln. 3. Mitteilung zur Bedeutung nicht-essentieller Aminosäuren für den Proteinansatz. *Journal of Animal Physiology and Animal Nutrition* 73, 57–65.
- Klain, G.J., Scott, H.M. and Johnson, B.C. (1959) Utilization of nutrients in a crystalline amino acid diet as influenced by certain non-essential amino acids. *Poultry Science* 38, 489–491.
- Křížová, L., Šimeček, K., Heger, J. and van Cauwenberghe, S. (2001) Effect of nonessential amino acids on nitrogen retention in growing pigs fed on a protein-free diet supplemented with sulphur amino acids, threonine and tryptophan. *Journal of Animal Physiology and Animal Nutrition* 85, 325–332.
- Kyriazakis, I. and Emmans, G.C. (1993) Whole body amino acid composition of the growing pig. *Journal of the Science of Food and Agriculture* 62, 29–33.
- Leclercq, B., Chagneau, A.M., Cochard, T. and Khoury, J. (1994) Comparative responses of genetically lean and fat chickens to lysine, arginine and non-essential amino acid supply. 1. Growth and body composition. *British Poultry Science* 35, 687–696.
- Lenis, N.P., van Diepen, H.T.M., Bikker, P., Jongbloed, A.G. and van der Meulen, J. (1999) Effect of the ratio between essential and nonessential amino acids in the diet on the utilization of nitrogen and amino acids by growing pigs. *Journal of Animal Science* 77, 1777–1787.
- Leterme, P., Monmart, T., Théwis, A. and Morandi, A. (1996) Effect of oral and parenteral N nutrition vs. N-free nutrition on the endogenous amino acid flow at the ileum of the pig. *Journal of the Science of Food and Agriculture* 71, 265–271.
- Leveille, G.A. and Fisher, H. (1958) The amino acid requirements for maintenance in the adult rooster. 1. Nitrogen and energy requirements in normal and protein-depleted animals receiving whole egg protein and amino acid diets. *Journal of Nutrition* 66, 441–454.
- Luckey, T.D., Moore, P.R., Elvehjem, C.A. and Hart, E.B. (1947) Growth of chicks on purified and synthetic diets containing amino acids. *Proceedings of the Society for Experimental Biochemistry and Medicine* 64, 348–351.
- Mambrini, M. and Kaushik, S.J. (1994) Partial replacement of dietary protein nitrogen with dispensable amino acids in diets of Nile tilapia, *Oreochromis niloticus*. *Comparative Biochemistry and Physiology*, part A, 109A, 469–477.
- Markert, W., Kirchgessner, M. and Roth, F.X. (1993) Bilanzstudien zur Reduzierung der N-Ausscheidung von Mastschweinen. 1. Optimal Versorgung mit essentiellen Aminosäuren. *Journal of Animal Physiology and Animal Nutrition* 70, 159–171.
- Maruyama, K., Sunde, M.L. and Harper, A.E. (1976) Is L-glutamic acid nutritionally a dispensable amino acid for the young chick? *Poultry Science* 55, 45–60.
- McDonald, M.W. and Morris, T.R. (1985) Quantitative review of optimum amino acid intakes for young laying pullets. *British Poultry Science* 26, 253–264.

- McFarlane, I.G. and von Holt, C. (1969) Metabolism of amino acids in protein-calorie-deficient rats. *Biochemical Journal* 111, 557–563.
- Mitchell, J.R., Jr, Becker, D.E., Harmon, B.G., Norton, H.W. and Jensen, A.H. (1968) Some amino acid needs of the young pig fed a semisynthetic diet. *Journal of Animal Science* 27, 1322–1326.
- Moran, E.T. (1995) Body composition. In: Hunton, P. (ed.) *Poultry Production*. Elsevier, Amsterdam, The Netherlands, pp. 139–156.
- Moran, E.T., Summers, J.D. and Pepper, W.F. (1967) Effect of non-protein nitrogen supplementation of low protein rations on laying hen performance with a note on essential amino acid requirements. *Poultry Science* 46, 1128–1144.
- Morris, T.R. (1989) The interpretation of response data from animal feeding trials. In: Cole, D.J.A. and Haresign, W. (eds) *Recent Developments in Poultry Nutrition*. Butterworths, London, pp. 1–11.
- Munro, H.N. (1964) General aspects of regulation of protein metabolism by diet and hormones. In: Munro, H.N. and Allison, J.B. (eds) *Mammalian Protein Metabolism*, vol. I. Academic Press, New York, pp. 382–481.
- Newburg, D.S., Frankel, D.L. and Fillios, L.C. (1975) An asparagine requirement in young rats fed the dietary combinations of aspartic acid, glutamine, and glutamic acid. *Journal of Nutrition* 105, 356–363.
- Noblet J., Henry, Y. and Dubois, S. (1987) Effect of protein and lysine levels in the diet on body gain composition and energy utilization in growing pigs. *Journal of Animal Science* 65, 717–726.
- NRC (National Research Council) (1994) *Nutrient Requirements of Poultry*, 9th edn. National Academy Press, Washington, DC, 155 pp.
- NRC (National Research Council) (1995) *Nutrient Requirements of Laboratory Animals*. National Academy Press, Washington, DC, 173 pp.
- Nyachoti, C.M., De Lange, C.F.M., McBride, B.W. and Schulze, H. (1997) Significance of endogenous gut nitrogen losses in the nutrition of growing pigs: a review. *Canadian Journal of Animal Science* 77, 149–163.
- Parr, J.F. and Summers, J.D. (1991) The effect of minimizing amino acid excess in broiler diets. *Poultry Science* 70, 1540–1549.
- Pellett, P.L. and Kaba, H. (1972) Carcass amino acids of the rat under conditions of determination of net protein utilization. *Journal of Nutrition* 102, 61–68.
- Ranhotra, G.S. and Johnson, B.C. (1965) Effect of feeding different amino acid diets on growth rate and nitrogen retention of weanling rats. *Proceedings of the Society for Experimental Biology and Medicine* 118, 1197–1201.
- Rechcigl, M., Loosli, J.K. and Williams, H.H. (1957) The net utilization of non-specific nitrogen sources for the synthesis of nonessential amino acids. *Journal of Nutrition* 63, 177–192.
- Reeds, P.J. (2000) Dispensable and indispensable amino acids for humans. *Journal of Nutrition* 130, 1835S–1840S.
- Reeds, P.J. and Hutchens, T.W. (1994) Protein requirements: from nitrogen balance to functional impact. *Journal of Nutrition* 124, 1754S–1764S.
- Robertson, A.M., Rabel, B., Harding, C.A., Tasman-Jones, C., Harris, P.J. and Lee, S.P. (1991) Use of the ileal conduit as a model for studying human small intestinal mucus glycoprotein secretion. *American Journal of Physiology* 261, G728–G734.
- Rogers, Q.R. and Harper, A.E. (1965) Amino acid diets and maximal growth in the rat. *Journal of Nutrition* 87, 267–273.
- Rogers, Q.R., Chen, D.M.-Y. and Harper, A.E. (1970) The importance of dispensable amino acids for maximal growth in the rat. *Proceedings of the Society for Experimental Biology and Medicine* 134, 517–522.
- Rogers, Q.R., Taylor, T.P. and Morris, J.G. (1998) Optimizing dietary amino acid patterns at various levels of crude protein for cats. *Journal of Nutrition* 128, 2577S–2580S.
- Rose, W.C., Oesterling, M.J. and Womack, M. (1948) Comparative growth on diets containing ten and nineteen amino acids, with further observations upon the role of glutamic and aspartic acids. *Journal of Biological Chemistry* 176, 753–762.
- Roth, F.X., Markert, W. and Kirchgessner, M. (1993) Zur optimalen Versorgung mit  $\alpha$ -Aminostickstoff von Mastschweinen. 2. Mitteilung über Bilanzstudien zur Reduzierung der N-Ausscheidung. *Journal of Animal Physiology and Animal Nutrition* 70, 196–206.
- Roth, F.X., Fickler, J. and Kirchgessner, M. (1994a) N-Bilanz von Ferkeln bei vollständigem Fehlen von einzelnen nicht-essentiellen Aminosäuren im Futter. 2. Mitteilung zur Bedeutung nicht-essentiellen

- Aminosäuren für den Proteinansatz. *Journal of Animal Physiology and Animal Nutrition* 72, 215–224.
- Roth, F.X., Markert, W. and Kirchgessner, M. (1994b) Zum Einfluss der Supplementierung von Niedrig-Protein-Rationen mit nicht-essentiellen Aminosäuren auf die N-Bilanz von Mastschweinen. 3. Mitteilung über Bilanzstudien zur Reduzierung der N-Ausscheidung. *Journal of Animal Physiology and Animal Nutrition* 71, 76–86.
- Roth, F.X., Gotterbarm, G.G., Windisch, W. and Kirchgessner, M. (1999) Einfluss des Gehalts an nicht-essentiellen Aminosäuren im Futter auf die Stickstoffbilanz und auf den Protein-turnover des Ganzkörpers von wachsenden Schweinen. *Journal of Animal Physiology and Animal Nutrition* 81, 232–238.
- Salmon, W.D. (1964) Relative potency of diets containing amino acids and proteins for promoting growth of rats. *Journal of Nutrition* 82, 76–82.
- Samuels, S.E., Aarts, H.L.M. and Ball, R.O. (1989) Effect of dietary proline on proline metabolism in the neonatal pig. *Journal of Nutrition* 119, 1900–1906.
- Schuhmacher, A., Muench, M. and Gropp, J. (1995) Non-essential amino acids sources in crystalline amino acid diets for trout (*Oncorhynchus mykiss*). *Journal of Applied Ichthyology* 11, 317–321.
- Shapiro, R. and Fisher, H. (1962) Protein reserves: relationship of dietary essential and nonessential amino acids to formation and maintenance in the fowl. *Journal of Nutrition* 76, 106–112.
- Souffrant, W.B. (1991) Endogenous nitrogen losses during digestion in pigs. In: Verstegen, M.W.A., Huisman, J. and Den Hartog, L.A. (eds) *Digestive Physiology in Pigs*. EAAP Publishers, Pudoc, Wageningen, pp. 147–166.
- Stein, H.H., Trottier, N.L., Bellaver, C. and Easter, R.A. (1999) The effect of feeding level and physiological status on total flow and amino acid composition of endogenous protein at the distal ileum in swine. *Journal of Animal Science* 77, 1180–1187.
- Stein, T.P., Settle, R.G., Albina, J.A., Dempsey, D.T. and Melnick, G. (1986) Metabolism of nonessential <sup>15</sup>N-labelled amino acids and the measurement of human whole-body protein synthesis rates. *Journal of Nutrition* 116, 1651–1659.
- Stipanuk, M.H. (1986) Metabolism of sulphur-containing amino acids. *Annual Review of Nutrition* 6, 179–209.
- Stranks, M.H., Cooke, B.C., Fairbairn, C.B., Fowler, N.G., Kirby, P.S., McCracken, K.J., Morgan, C.A., Palmer, F.G. and Peers, D.G. (1988) Nutrient allowances for growing pigs. *Research and Development in Agriculture* 5, 71–88.
- Stucki, W.P. and Harper, A.E. (1961) Importance of dispensable amino acids for normal growth of chicks. *Journal of Nutrition* 74, 377–383.
- Stucki, W.P. and Harper, A.E. (1962) Effects of altering the ratio of indispensable to dispensable amino acids in diets for rats. *Journal of Nutrition* 78, 278–286.
- Sugahara, M. and Ariyoshi, S. (1967a) The nonessentiality of glycine and the essentiality of L-proline in the chick nutrition. *Agricultural and Biological Chemistry* 31, 106–110.
- Sugahara, M. and Ariyoshi, S. (1967b) The nutritional value of the individual nonessential amino acid as the nitrogen source in the chick nutrition. *Agricultural and Biological Chemistry* 31, 1270–1275.
- Sugahara, M. and Ariyoshi, S. (1968) The role of dispensable amino acids for the maximum growth of chicks. *Agricultural and Biological Chemistry* 32, 153–160.
- Tanaka, H., Shibata, K., Mori, M. and Ogura, M. (1995) Metabolism of essential amino acids in growing rats at graded levels of soybean protein isolate. *Journal of Nutritional Science and Vitaminology* 41, 433–443.
- Taylor, T.P., Morris, J.G., Kass, P.H. and Rogers, Q.R. (1997) Increasing dispensable amino acids in diets for kittens fed essential amino acids at or below their requirement increases the requirement for arginine. *Amino Acids* 13, 257–272.
- Taylor, T.P., Morris, J.G., Kass, P.H. and Rogers, Q.R. (1998) Maximal growth occurs at a broad range of essential amino acids to total nitrogen ratios in kittens. *Amino Acids* 15, 221–234.
- Taylor, T.P., Morris, J.G., Willits, N.H. and Rogers, Q.R. (1996) Optimizing the pattern of essential amino acids as the sole source of dietary nitrogen supports near-maximal growth of kittens. *Journal of Nutrition* 126, 2243–2252.
- Wang, T.C. and Fuller, M.F. (1989) The optimum dietary amino acid pattern for growing pigs. 1. Experiments by amino acid deletion. *British Journal of Nutrition* 62, 77–89.
- Yokogoshi, H. and Yoshida, A. (1976) Some factors affecting the nitrogen sparing action of methionine and threonine in rats fed a protein free diet. *Journal of Nutrition* 106, 48–57.



Yoshida, A. and Moritoki, K. (1974) Nitrogen sparing action of methionine and threonine in rats receiving a protein free diet. *Nutrition Reports International* 9, 159-168.

Young, V.R. and Zamora, J. (1968) Effects of altering the proportion of essential to non-essential amino acids on growth and plasma amino acid levels in the rat. *Journal of Nutrition* 96, 21-27.

# 7 Adverse Effects of Amino Acids

**J.P.F. D'Mello\***

*Formerly of The Scottish Agricultural College, Edinburgh, UK*

---

## **Introduction**

Since amino acids are extensively metabolized (see Chapters 4 and 5), it is widely assumed that any surplus ingested by animals is disposed of without adverse effects. It has also been suggested that the ruminant is endowed with protective detoxification mechanisms by virtue of considerable microbial metabolism of amino acids within the rumen. However, there is now unequivocal evidence demonstrating that amino acids may precipitate profound deleterious effects in diverse classes of farm animals. Furthermore, these manifestations conform with the three categories of imbalances, antagonisms and toxicities embodied in the classification established with the rat (Harper, 1959; Harper *et al.*, 1970). This system has long existed as a conceptual model, largely confined to the academic domain by virtue of its origin in contrived experiments with laboratory animals. However, there is now enhanced perception of the wider and practical significance of adverse effects of amino acids in the nutrition of farm animals. Thus, concerted efforts are currently being directed at defining ideal dietary amino acid patterns for all classes of livestock (see for example Chapters 9 and 13) in order to pre-empt the deleterious effects of imbalances.

In this chapter the effects of imbalances, antagonisms and toxicities are reviewed with respect to their significance in the nutrition of farm livestock. In addressing these issues, importance has been attached to differences between various classes of animals in their responses to disproportionate intakes of amino acids. Attention has also been given to biochemical features underlying the adverse effects of amino acids, strategies for mitigation and innate detoxification mechanisms in animals.

## **Amino Acid Imbalance**

### **Definition**

This term was defined by Harper (1964) as a change in the pattern of amino acids in the diet precipitating depressions in food intake and growth, which are completely alleviated by supplementation with the first-limiting amino acid. The prerequisite for a limiting amino acid may be satisfied by the use of a suitably deficient protein such as gelatin, but more generally this condition may be fulfilled by the use of low-protein diets. The definition of imbalance was devised as a result of investigations with the rat but is now being widely applied to the nutrition of farm animals.

\*E-mail address: f.dmello@ed.sac.ac.uk

It is, therefore, instructive to recall some of the fundamental tenets embodied in this class of adverse effects. Two types of imbalance may be recognized (Table 7.1): that caused by the addition of a relatively small quantity of an indispensable amino acid to a low-protein diet, and that precipitated by an incomplete mixture of amino acids. In the former case, there is a specific requirement that the agent precipitating the imbalance should be the second-limiting amino acid (Winje *et al.*, 1954). A more reliable procedure involves the addition of an amino acid mixture devoid of one indispensable amino acid to a low-protein diet limiting in the same amino acid (Pant *et al.*, 1972). Other studies show that imbalances may also be created by employing mixtures of the dispensable amino acids (Tews *et al.*, 1980). In such instances, the most reliable technique involves the use of amino acids, individually or in mixtures, which compete with the dietary limiting amino acid for transport into the brain.

From experiments employing incomplete amino acid mixtures, Fisher *et al.* (1960) concluded that the chick is as sensitive to an imbalance as the growing rat (Table 7.1). The primary manifestation of adverse effects was a depression in food intake which consequently also decreased intake of the limiting amino acid, leading to reduced growth.

### Practical implications

The issue of amino acid imbalance assumed practical significance in poultry nutrition with the studies by Wethli *et al.* (1975) who invoked this phenomenon to explain the inferior utilization, by broiler chicks, of the first-limiting amino acid in low-quality protein sources. Wethli *et al.* (1975) designed a series of cereal-based diets containing increasing quantities of groundnut meal to provide crude protein (CP) levels ranging from 120 to 420 g kg<sup>-1</sup> diet. These diets were formulated with or without supplementary methionine plus lysine. Growth responses were compared with those of chicks fed on a series of control diets containing graded quantities of herring meal such that final dietary CP concentrations ranged from 120 to 240 g kg<sup>-1</sup>. Thus the assumed minimal amino acid needs of the young chick were considered to be satisfied at the high inclusion rates of either protein source. As expected, with the unsupplemented groundnut meal diets, growth rates improved as CP concentrations increased up to 360 g kg<sup>-1</sup> diet, but failed to match those of chicks fed lower levels of CP derived from herring meal. However, supplementation of the groundnut meal diets with methionine plus lysine induced progressive and more efficient gains at all CP levels up to 270 g kg<sup>-1</sup> diet. At this concentration of CP, the supplemented groundnut meal diet supported

**Table 7.1.** Effects of dietary amino acid imbalance on growth of rats and chicks fed low-protein diets.

Protein source; dietary protein level; and amino acid supplements	First-limiting amino acid	Method of precipitating imbalance	Diets	Growth response (proportion of control)	Reference
<b>Rats</b>					
Egg albumen; 80 g kg <sup>-1</sup> diet; Thr + Val	His	Addition of second- limiting amino acid (Lys)	Control	1.00	Winje <i>et al.</i> (1954)
			Imbalanced	0.65	
			Corrected	0.95	
Casein; 80 g kg <sup>-1</sup> diet; Met	Trp	Addition of amino acid mixture devoid of Trp	Control	1.00	Pant <i>et al.</i> (1972)
			Imbalanced	0.71	
			Corrected	1.10	
<b>Chicks</b>					
Sesame protein; 110 g kg <sup>-1</sup> diet; Lys (suboptimal)	Lys	Addition of Lys-free amino acid mixture	Control	1.00	Fisher <i>et al.</i> (1960)
			Imbalanced	0.87	
			Corrected	1.69	

growth approaching that observed with the best herring meal control diet containing 210 g CP kg<sup>-1</sup>. In a further experiment, Wethli *et al.* (1975) observed that diets based on soybean meal and maize were somewhat inferior to similar diets fortified with methionine even though the unsupplemented diets, at the higher CP concentrations, satisfied the calculated requirements for the first-limiting amino acid. Of several hypotheses examined, Wethli *et al.* (1975) concluded that the amino acids supplied by low-quality oilseed protein sources were in such disproportion to the needs of the chick as to impair utilization of the first-limiting amino acid. It was suggested that amino acid imbalances can occur in diets based on conventional ingredients and that pure supplements of limiting amino acids may be used to rectify these imbalances.

Further impetus to the study of imbalances emerged with the introduction of the diet-dilution technique to determine amino acid requirements of poultry. This method, originally devised to determine the methionine requirement of laying pullets, was adapted to investigate the growth responses of broiler chicks to different concentrations of an indispensable amino acid (Morris *et al.*, 1987; Abebe and Morris, 1990a,b). The procedure involved the sequential dilution of a high-protein 'summit' diet with an isoenergetic, protein-free mixture. The summit diet was formulated to contain a large excess, typically 185% of assumed requirements, of all indispensable amino acids except the one under test, which was set at around 145% of assumed requirements. On blending the summit diet with the protein-free mixture, the amino acid under test would be expected to be first-limiting at all levels of dilution. Although successive dilutions resulted in progressively lower CP concentrations, the dietary amino acid pattern remained constant throughout the diluted series. Interpretation of responses to the different dilutions were attributed specifically to intakes of the first-limiting amino acid. Thus, the diet-dilution technique involved the deliberate creation of an amino acid imbalance in the classical manner established by Harper (1964). Nevertheless, the diet-dilution technique was used to determine the responses of broiler chicks to lysine

(Morris *et al.*, 1987) and to tryptophan (Abebe and Morris, 1990b). As will be discussed at length later (Chapter 14), substantial disparity emerged between the growth responses obtained with the serial dilution of the summit diet and those observed with the addition of pure amino acid supplements (D'Mello, 1988). This incompatibility of responses was attributed to the effects of amino acid imbalance in the summit and diluted diets (Abebe and Morris, 1990a), but data by D'Mello (1990) question the validity of this interpretation. Since these issues relate to amino acid utilization by growing poultry, further discussion is reserved until Chapter 14.

Several studies with pigs indicate that amino acid imbalances may occur at the tissue level even though the diet may appear to be in ideal balance. Such imbalances are readily demonstrated on supplementation of cereal-based diets with crystalline amino acids. It has long been recognized that free amino acid supplements are absorbed more rapidly than protein-bound amino acids resulting in an imbalanced supply at sites of protein synthesis (Leibholz *et al.*, 1986; Leibholz, 1989). For example, Leibholz *et al.* (1986) observed that the concentration of free lysine in plasma of pigs increased 1–2 h after feeding a diet containing pure lysine, declining thereafter, whereas the circulating concentrations of other amino acids originating from the protein-bound fraction of the diet peaked at 2–6 h postprandial. In pigs fed once daily, this lack of synchrony in absorption would precipitate an amino acid imbalance at the cellular level. Under these circumstances growth and efficiency of dietary nitrogen (N) would be impaired, but the deleterious effects could be offset by more frequent feeding. This expectation was confirmed by Batterham (1974) who observed that the efficiency of utilization of free lysine supplements for growth of pigs fed once daily was only 0.43–0.67 of values recorded with pigs fed the same ration in six equal portions at 3-hourly intervals. In contrast, no such benefit occurred on feeding the unsupplemented control diet more frequently. Subsequent investigations by Partridge *et al.* (1985) extended the benefits of increased feeding frequency and lysine supplementation to improvements in N utilization.

With the commercial development of rumen protected amino acids (Chapter 16), the question of imbalances in cattle nutrition is relevant, particularly in view of the uncertainty associated with the duodenal delivery of feed and microbial amino acids. In studies with lactating dairy cows, Robinson *et al.* (2000) fed a basal diet co-limiting in intestinally absorbable supplies of methionine and lysine. On abomasal infusion with excess methionine, cows fed this diet ate less dry matter and produced less milk and lactose than unsupplemented controls. Evaluation of results with two metabolic models suggested that the basal diet may have been limiting in intestinally absorbable lysine, isoleucine or histidine. Thus the addition of methionine would have created an imbalance in the classical manner.

### Effects on food intake

Accounts of amino acid imbalances conventionally focus on the growth-depressing effects in animals (Harper, 1964; Tews *et al.*, 1979). However, it has been consistently recorded that a predisposing factor is a rapid and marked reduction in food intake. Thus Harper and Rogers (1965) reported that rats fed an imbalanced diet reduced their food intake within 3–6 h. These results implied that the depression in food intake was the primary event responsible for the ensuing retardation of growth. A considerable body of evidence supports this premise. If food intake in animals consuming imbalanced diets is increased

by force-feeding, by insulin injections, by adjusting dietary protein to energy ratios or by exposing animals to cold environmental temperatures, then commensurate improvements in growth also occur (see D'Mello, 1994).

The biochemical mechanisms underlying the anorectic effects of imbalanced diets have been described by Harper and Rogers (1965) following extensive studies with the rat. It was suggested that surplus amino acids arriving in the portal circulation after consumption of an imbalanced diet stimulate synthesis or suppress breakdown of protein in the liver leading to greater retention of the limiting amino acid relative to that in control groups (Table 7.2). The supply of the limiting amino acid for peripheral tissues such as muscle is thereby reduced, although protein synthesis in these tissues proceeds unimpeded. Eventually, however, the free amino acid patterns of both muscle and blood plasma become so deranged as to invoke the intervention of the appetite-regulating system to reduce food intake. Growth is reduced as a consequence of the depressed appetite and intake of nutrients. This hypothesis is still accepted as a satisfactory explanation for the effects of amino acid imbalance in the rat and is thought to have wider application to other animals including poultry (D'Mello, 1994).

Alterations in dietary preferences are another feature of amino acid imbalance, at least in the rat. Thus, when offered a choice, rats consume a balanced diet in preference to an imbalanced one, but more remarkably, select a protein-free diet incapable of supporting growth instead of an imbalanced diet

**Table 7.2.** Sequence of events during amino acid imbalance leading to depressed food intake. (Based on the hypothesis of Harper and Rogers, 1965.)

Site	Effects
Liver	Surplus amino acids stimulate synthesis or suppress breakdown of proteins; efficient utilization of limiting amino acid
Muscle	Protein synthesis continues normally; greater retention of limiting amino acid; deranged free amino acid pattern
Plasma	Deranged free amino acid pattern
Brain	Abnormal pattern in blood monitored by appetite-regulating regions
Whole animal	Depressed food intake Reduced nutrient intake Reduced growth

which would allow growth, albeit at a low level (Sanahuja and Harper, 1962; Leung and Rogers, 1987).

A central tenet in the hypothesis advanced by Harper and Rogers (1965) is the association between food intake depression and changes in tissue patterns of amino acids. In both blood plasma and muscle, concentrations of the limiting amino acid decline, whereas there is an accumulation of those amino acids added to precipitate the imbalance. Since these events occur within a few hours of ingestion of such diets, it has been suggested that changes in plasma amino acid pattern may provide the metabolic signal that ultimately results in anorexia and abnormal feeding behaviour. In subsequent attempts to validate this hypothesis, the role of the first-limiting amino acid has featured prominently. For example initial studies (Leung and Rogers, 1969) indicated that the depression in appetite may be prevented by the infusion of a small quantity of the first-limiting amino acid via the carotid artery whereas administration through the jugular vein was ineffective. Tobin and Boorman (1979) confirmed that the cockerel fed an imbalanced diet responded in a similar manner to the rat following infusion of the limiting amino acid.

The studies by Leung and Rogers (1969) provided the basis of the proposition that food intake and feeding behaviour may be associated with changes in brain uptake and metabolism of critical amino acids. It was soon established that the concentration of the first-limiting amino acid declined more rapidly in cerebral tissues than in plasma (Peng *et al.*, 1972). This observation led to the proposal that the fall in brain concentrations of the limiting amino acid initiates the signal which causes the changes in food intake and dietary choice, although the precise mechanisms remain obscure (Leung and Rogers, 1987). However, the regions of the central nervous system sensitive to amino acid imbalance have been delineated in the rat. These include the anterior prepyriform cortex, the medial amygdala and certain sites of the hippocampus and septum. In particular, the sensitivity of the prepyriform cortex to amino acid imbalance has been extensively investigated by Gietzen *et al.* (1986) and Beverly *et al.* (1990a,b,

1991a). Thus the selection of a protein-free diet in preference to an imbalanced one was reversed if the limiting amino acid was injected directly into the prepyriform cortex. Beverly *et al.* (1991b) showed that injected dose levels were important, exerting separate effects on dietary selection and on intake of imbalanced diets. Gietzen *et al.* (1998) developed this concept further by demonstrating that different neural circuits mediated the initial recognition and secondary conditioned responses to imbalanced diets.

Amino acid imbalance may affect food intake and dietary selection by modulating the synthesis and metabolism of neurotransmitters in the brain (Figs 4.10 and 4.11). In one study, feeding imbalanced diets reduced production of noradrenaline in the anterior prepyriform cortex of rats (Leung *et al.*, 1985). However, Harrison and D'Mello (1987) showed that an imbalance caused by the addition of mixture devoid of tyrosine and phenylalanine to a diet deficient in these amino acids reduced food intake in chicks without affecting noradrenaline or dopamine levels in brain homogenates. This discrepancy may have more to do with neurotransmitter synthesis and disposition at specific sites in the brain than with any genuine differences between species or type of imbalance used in the two studies.

### Effects on nutrient utilization

The effect of amino acid imbalance on nutrient utilization has been the subject of some debate. An imbalance would be expected to impair overall efficiency of utilization of dietary protein. Experiments with rats (Kumta *et al.*, 1958) confirm this expectation, with N retention efficiency declining from 0.60 to 0.44 on addition of an imbalancing amino acid mixture to a control diet. However, in rats pair-fed the control diet to match intakes of the imbalanced group, efficiency of N retention decreased to 0.33, indicating that the effects of imbalance are mediated via reductions in appetite. Despite these observations, the accepted consensus is that amino acid imbalances reduce the efficiency of protein utilization in farm animals. Thus, Moughan (1991) attributed the

low efficiency of protein utilization in pigs partly to dietary amino acid imbalance. In addition, Partridge *et al.* (1985) demonstrated that imbalances at the tissue level, induced by differential absorption of amino acids from crystalline and protein-bound sources, can reduce overall efficiency of protein utilization in pigs fed once daily. Furthermore, Wang and Fuller (1989) showed that manipulation of the composition of a mixture of amino acids to simulate the pattern in casein enhanced N retention in pigs by reducing imbalances. However, Langer and Fuller (1994) demonstrated that the addition of an imbalancing mixture containing leucine, isoleucine and valine to a diet limiting in methionine increased N efficiency in growing pigs. This somewhat unusual effect was attributed to a reduction in degradation of methionine by competitive inhibition of enzymes involved, leading to increased availability of methionine for body protein synthesis (Langer *et al.*, 2000). The concept of enhanced utilization of the limiting amino acid is not new; thus Harper and Rogers (1965) reported that rats fed a threonine-imbalanced diet reduced oxidation of  $^{14}\text{C}$ -labelled threonine. In subsequent studies, Yoshida *et al.* (1966) and Benevenga *et al.* (1968) demonstrated increased incorporation of the first-limiting amino acid into hepatic proteins of rats fed imbalanced diets. Thus, both whole-animal and biochemical studies with rats have demonstrated enhanced utilization and retention of the limiting amino acid following feeding of amino acid imbalanced diets. Despite this evidence, other investigators continue to invoke such imbalances to explain differences in utilization of limiting amino acids in chicks fed excess protein (Abebe and Morris, 1990a,b) or imbalanced diets (Yuan *et al.*, 2000). This issue is of sufficient practical significance to merit detailed attention (Chapter 14).

### Amino Acid Antagonisms

An amino acid antagonism may be defined as a deleterious interaction between structurally similar amino acids. This category of adverse effects was devised to accommodate the unique and separate effects of lysine and

leucine in the rat. Demonstrations of antagonisms have been extended to farm animals (D'Mello and Lewis, 1970a,b,c; Papet *et al.*, 1988a). In addition, it is now recognized that antagonisms may be precipitated by a wide range of analogues occurring naturally in crop plants as non-protein amino acids. In most cases, the action of these analogues is targeted at the metabolism and utilization of specific structurally related essential amino acids.

### Branched-chain amino acid antagonisms

Interest in the antagonisms involving the branched-chain amino acids (BCAA) has been sustained by the knowledge that maize by-products, sorghum, and blood meal contain disproportionate quantities of these amino acids. In addition, maintenance requirements of animals for BCAA may be influenced by these antagonisms.

#### *Specificity*

Following initial demonstrations of leucine-induced antagonisms in the rat, much evidence has emerged to confirm the specificity and complexity of interactions among BCAA in the chick and turkey poult. In one study, D'Mello and Lewis (1970b) showed that excess dietary leucine permitted the growth response of chicks to the first-limiting amino acid, methionine, only in the presence of supplementary isoleucine. The specificity of the leucine-isoleucine antagonism was thus established for the first time. However, other results led D'Mello and Lewis (1970b) to conclude that the leucine-valine interaction was relatively more potent. This conclusion was based on growth and plasma amino acid data (Table 7.3). The addition of excess leucine to a diet equally but marginally limiting in isoleucine and valine precipitated a severe growth depression in young chicks. Valine supplementation reversed this effect but isoleucine addition failed to elicit a response. Indeed, a combination of excess leucine and supplementary isoleucine impaired growth even further and precipitated a marked fall in plasma valine concentrations. In contrast, circulating levels of isoleucine remained undisturbed

**Table 7.3.** Branched-chain amino acid antagonisms in the young chick: effects of excess dietary leucine and supplements of valine and isoleucine on growth and plasma amino acid concentrations. (Adapted from D'Mello and Lewis, 1970b.)

Diet	Daily weight gain (g chick <sup>-1</sup> )	Plasma amino acid concentrations ( $\mu\text{mol } 100 \text{ ml}^{-1}$ )					
		Val	Ile	Leu	Gly	Lys	Arg
Basal <sup>a</sup>	16	15.7	5.1	12.2	43.2	66.9	16.9
Basal + Val	16	17.8	7.5	12.8	30.9	48.2	18.8
Basal + Ile	15	11.7	11.3	20.2	72.8	73.8	33.0
Basal + Val + Ile	17	—	—	—	—	—	—
Basal + Leu	13	10.7	7.9	37.7	63.0	91.3	23.6
Basal + Leu + Val	15	14.5	7.4	15.2	46.6	61.4	17.8
Basal + Leu + Ile	11	9.3	10.6	40.5	73.5	75.8	27.5
Basal + Leu + Val + Ile	17	—	—	—	—	—	—

<sup>a</sup>Basal diet marginally deficient in Val and Ile.

following individual or combined additions of leucine and valine. The efficacy of valine was further confirmed by its ability to reduce high plasma levels of leucine, whereas isoleucine addition was ineffective in this respect. The sensitivity of valine to leucine antagonism and its exacerbation by isoleucine was confirmed in a later study with chicks (D'Mello and Lewis, 1970c). Excess dietary leucine depressed plasma valine concentrations to the greatest extent when added with isoleucine. This reduction is of particular significance since dietary valine was set at adequate levels.

The specificity of the leucine–valine antagonism was further exemplified in studies with turkey poults fed diets supplemented with graded combinations of leucine and valine (D'Mello, 1975). Both amino acids accumulated in plasma following supplementation, but the extent of valine accretion was reduced as dietary levels of leucine increased. However, valine supplementation failed to suppress accumulation of leucine in plasma.

### Complexity

Despite the primacy of the leucine–valine antagonism, it is possible to devise dietary conditions demonstrating enhanced sensitivity of isoleucine in BCAA interactions. D'Mello (1974) showed that a diet supplemented with a small excess of leucine depressed chick growth, which was only par-

tially alleviated with valine additions. Examination of the plasma amino acid data indicated that circulating levels of isoleucine had declined most severely on combined addition of leucine with valine. The complexity of BCAA interactions is further illustrated by the response of laying pullets to excess dietary leucine (Bray, 1970). Egg production and egg yield were reduced by this excess but were restored to satisfactory levels only after isoleucine and valine were added in combination. Failure to recognize the complexity of these interactions may account for the lack of effect of isoleucine alone in alleviating a leucine-induced antagonism in pigs (Oestemer *et al.*, 1973). Inspection of the plasma data, however, indicated moderate decreases in the circulating levels of both isoleucine and valine, thus implying that combined supplements of these amino acids might have been more effective. However, in lactating sows, independent increases in litter weaning weights and changes in milk composition from valine and isoleucine supplements were assumed to imply separate modes of action for these amino acids in milk synthesis (Richert *et al.*, 1997).

### Mechanisms

From studies principally with the rat, Harper *et al.* (1984) attributed the leucine-induced changes in plasma levels of isoleucine and



valine to increased oxidation of these two amino acids, having discounted any effects emanating from competition for intestinal or renal transport. Limited studies with the chick support this view. Thus, Calvert *et al.* (1982) demonstrated that excess leucine failed to influence excretion of  $^{14}\text{C}$ -labelled isoleucine or valine, but markedly increased oxidation of these amino acids as indicated by enhanced *in vivo* output of  $^{14}\text{CO}_2$ . The catabolism of BCAA is initiated by a reversible aminotransferase reaction (Fig. 4.13). The branched-chain keto acids (BCKA) so formed then undergo irreversible oxidative decarboxylation to yield acyl-CoA compounds which are degraded further in a series of reactions analogous to those involved in fatty acid oxidation. Harper *et al.* (1984) suggested that enhanced BCKA oxidation might account for the depletion of plasma isoleucine and valine pools in animals fed excess leucine. Studies with preruminant lambs support this view in that marked reductions in plasma concentrations of keto acids derived from isoleucine and valine were recorded in response to excess intake of leucine (Papet *et al.*, 1988a). Subsequently, Papet *et al.* (1988b) observed that excess leucine increased activities of aminotransferases in the liver and jejunum and also activated BCKA dehydrogenase in the jejunum of lambs.

Excess BCAA may, additionally, induce depletion of brain pools of other amino acids, particularly those which are the precursors of the neurotransmitters. In this regard, Harrison and D'Mello (1986) showed that excesses of the three BCAA reduced brain concentrations of noradrenaline, dopamine and 5-hydroxytryptamine in the chick and that levels of these neurotransmitters were restored by dietary supplementation with their precursors, phenylalanine and tryptophan. The significance of these results awaits elucidation. Nevertheless, it is generally conceded that changes in brain metabolism of amino acids and neurotransmitters may be associated with alterations in food intake and feeding behaviour (Leung and Rogers, 1987). Consistent with this concept has been the observation that a substantial element of the adverse effects of excess leucine arises from the reduction in food intake (Calvert *et al.*, 1982;

Papet *et al.*, 1988a) which subjugates effects emanating from oxidative catabolism of isoleucine and valine.

### The lysine–arginine antagonism

The considerable variation in the arginine requirements of the chick has provided the impetus for extensive and sustained investigations on the lysine–arginine antagonism. In addition, a number of feedstuffs contain adverse ratios of lysine relative to arginine. Indications of a potent antagonism between lysine and arginine in the chick dates back to the studies by Jones (1961) on the toxicity of lysine. Since then considerable evidence has emerged to identify features such as specificity, reciprocity and mechanisms of action in this antagonism.

#### Specificity

The unique specificity of this antagonism was tested in several experiments by D'Mello and Lewis (1970a) who designed basal diets which were first-limiting in methionine, tryptophan, histidine or threonine, with arginine marginally deficient. Addition of excess lysine to each of these diets precipitated a severe growth depression in chicks which, in every case, was reversed by arginine supplementation and not by the amino acid originally deficient in the basal diet. A selection of the results relating to the threonine-deficient diet is shown in Table 7.4, which further illustrates the specific effect of lysine in reducing plasma levels of arginine. In contrast, circulating levels of threonine were unaffected by the precipitation of this antagonism. Evidence of specificity was also provided by Nesheim (1968) in studies with two strains of chicks differing substantially in their requirements for arginine. Chicks with a high arginine requirement were less able to tolerate dietary excesses of lysine than chicks with a low requirement for arginine. However, a number of factors can affect the severity of the lysine–arginine antagonism. Excess chloride augments the adverse effects, whereas alkaline salts of monovalent mineral cations reduce or eliminate the potency of this antagonism.

**Table 7.4.** Specificity of the lysine–arginine antagonism in the young chick: effects of excess dietary lysine on growth and plasma amino acid concentrations. (Adapted from D’Mello and Lewis, 1970a.)

Diet	Daily weight gain (g chick <sup>-1</sup> )	Plasma amino acid concentrations ( $\mu\text{mol } 100 \text{ ml}^{-1}$ )					
		Arg	Thr	Lys	Ile	Leu	Tyr
Basal <sup>a</sup>	13	16.6	26.6	83.8	15.8	22.4	27.8
Basal + Arg	13	20.0	23.4	91.4	12.0	22.0	27.6
Basal + Thr	20	13.6	81.6	58.8	12.0	18.6	24.6
Basal + Arg + Thr	21	28.8	94.8	80.0	15.4	23.6	24.8
Basal + Lys	8	7.4	33.6	119.8	11.8	19.0	24.2
Basal + Lys + Arg	13	10.8	40.4	169.6	12.8	23.8	23.4
Basal + Lys + Thr	10	6.8	133.6	115.0	10.8	18.8	25.0
Basal + Lys + Arg + Thr	17	7.6	80.0	120.0	9.0	18.2	21.0

<sup>a</sup>Basal diet first-limiting in Thr and second-limiting in Arg.

### Effects in mammals

Although the lysine–arginine antagonism has been demonstrated in rats fed casein diets (Jones *et al.*, 1966), its existence in the pig has been refuted (Edmonds and Baker, 1987). Relatively large excesses (35 g kg<sup>-1</sup> diet) of lysine were required to reduce food intake and efficiency of food utilization. This level of lysine failed to influence arginase activity in any of the tissues examined. Excess lysine depressed plasma arginine but did not affect its concentration in liver, kidney or muscle. On the basis of this evidence, Edmonds and Baker (1987) attributed the adverse effects of excess lysine in the pig to an amino acid imbalance rather than to a specific antagonism.

### Reciprocity

D’Mello and Lewis (1970c) showed that excess arginine depressed growth of chicks fed a lysine-deficient diet, an effect which was reversed by supplementary lysine. However, the specificity and metabolic basis of this effect remain unresolved. There is some evidence that alterations in arginine:lysine ratios may be beneficial in heat stress in broilers (Brake *et al.*, 1998; Balnave and Brake, 1999). In the pig, excess arginine is considered to precipitate its adverse effects through an imbalancing action rather than through a genuine antagonism (Anderson *et al.*, 1984).

### Mechanisms

By virtue of their uricotelism, avian species are unable to synthesize arginine and are particularly sensitive to the lysine–arginine antagonism. The most significant factor in the avian manifestation of this antagonism is the enhanced activity of kidney arginase which results in increased catabolism of arginine (see Fig. 4.2). If arginase activity is suppressed by the use of a specific inhibitor, then the severity of the antagonism is also attenuated. A second factor is the depression in food intake, presumably arising from lysine-induced disruption of brain uptake and metabolism of other amino acids and their biogenic amines. It should be noted, however, that in this antagonism, the depression in growth precedes the reduction in food intake (D’Mello and Lewis, 1971). Secondary mechanisms include enhanced urinary excretion of arginine and inhibition of hepatic transaminase activity (Fig. 4.8) with consequent reduction in endogenous synthesis of creatine (D’Mello, 1994).

### Antagonisms induced by non-protein amino acids

A wide array of amino acids occurring naturally in unconjugated forms in plants are capable of precipitating adverse effects in animals. The presence of these non-protein amino acids in economically important species of legumes and brassicae has

thwarted attempts to maximize utilization of these plants as sources of food for farm livestock. Non-protein amino acids may occur in all parts of the plant, but the seed is normally the most concentrated source (D'Mello, 1991). In many instances these compounds bear structural analogy with the nutritionally important amino acids or their neurotransmitter derivatives active in the central nervous system of animals. Consequently, manifestations of deleterious effects range from reductions in food intake and nutrient utilization to profound neurological disorders and even death (Table 7.5).

### Mimosine

The aromatic amino acid mimosine contributes significantly to the toxicity of the ubiquitous tropical forage legume, *Leucaena leucocephala*. Mimosine may be regarded as a structural analogue of tyrosine and its neurotransmitter derivatives, dopamine and nor-adrenaline. However, the effects on brain metabolism of these biogenic amines have yet

to be confirmed, and evidence that tyrosine may reverse the deleterious effects of mimosine is equivocal (D'Mello, 1994). The adverse properties of mimosine are extensive and include disruption of reproductive function, teratogenic effects, loss of hair and wool and even death. Similar effects may be induced by feeding *Leucaena* to cattle and sheep. Thus the defleecing effects in sheep may be precipitated by administration of pure mimosine or by feeding *Leucaena* forage.

Manifestations of *Leucaena* toxicity are determined by geographical differences in rumen microbial ecology and are critically dependent on the rate and extent of bacterial breakdown of mimosine (see Fig. 4.5). Following degradation, 3-hydroxy-4(1H)-pyridone (3,4-DHP) is synthesized; this itself is capable of causing loss of appetite, goitre and reductions of blood thyroxine concentrations (Jones, 1985). Another goitrogen and isomer, 2,3-DHP may also be synthesized in the rumen. Thus the association of mimosine with tyrosine metabolism appears to be mediated indirectly via the two forms of

**Table 7.5.** Distribution and adverse effects of some non-protein amino acids. (Adapted from D'Mello, 1991.)

Amino acid	Plant species	Concentration (g kg <sup>-1</sup> dry weight)	Adverse effects			
<b>Aromatic</b>						
Mimosine	<i>Leucaena leucocephala</i>	145 (seed) 25 (leaf)	Loss of wool; teratogenic effects; organ damage; death			
<b>Analogues of sulphur amino acids</b>						
Se-methylselenocysteine Selenocystathionine Selenomethionine	} <i>Astragalus</i>	?	'Blind staggers'; death			
S-methylcysteine sulphoxide				<i>Brassica</i>	40–60 (leaf)	Haemolytic anaemia; loss of appetite; reduced milk yield; organ damage; death
<b>Arginine analogues</b>						
Canavanine	<i>Canavalia ensiformis</i> <i>Gliricidia sepium</i> <i>Robinia pseudoacacia</i> <i>Indigofera spicata</i>	25–51 (seed) 40 (seed) 98 (seed) 9 (seed)	} Reduced growth and nitrogen retention			
Indospicine	<i>Indigofera spicata</i>	20 (seed)				
Homoarginine	<i>Lathyrus cicera</i>	12 (seed)	Teratogenic effects; liver damage Reduced growth and food intake			

DHP. Some rumen bacteria are capable of detoxifying both forms of DHP. Despite these reactions, considerable quantities of mimosine and 3,4-DHP may escape rumen degradation and other derivatives may also be excreted. Ruminants in Australia, the USA and Kenya lack the requisite bacteria involved in the detoxification of the two DHP isomers and, consequently, succumb to their goitrogenic effects if high intakes of *Leucaena* are maintained over a protracted period of time. On the other hand, in certain other regions where *Leucaena* is indigenous (Central America) or is naturalized (Hawaii and Indonesia), ruminants possess the full complement of bacteria that are required for DHP degradation, which accounts for the absence of *Leucaena* toxicity in these countries (Jones, 1985). However, the transfer of DHP-degrading bacteria to cattle in Australia has been achieved with complete success. Inoculated animals grazing *Leucaena* show markedly higher live-weight gains and serum thyroxine concentrations than untreated *Leucaena*-fed controls (Quirk *et al.*, 1988). Dosed cattle rapidly reduce urinary DHP excretion despite a doubling of *Leucaena* intake. The isolation of active DHP-degrading bacteria from the faeces of dosed animals implies that treatment of just a few animals may provide sufficient inoculum for the entire herd. This technique thus offers a viable strategy for maximizing utilization of *Leucaena* with the added benefit of improved cattle performance.

Despite its toxicity, mimosine may have a role to play in the removal of fibre from Angora goats (Reis *et al.*, 1999). However, further research is necessary to develop a convenient means of mimosine delivery to the goats in a manner that maximizes fibre yield and avoids toxicity.

#### *Analogues of sulphur-containing amino acids*

Striking analogues of the sulphur-containing amino acids exist naturally in plants (D'Mello, 1991), particularly in those species where the sulphur atom is replaced by selenium. The debilitating disorders associated with these selenoamino acids are manifestations of acute selenium poisoning.

Another analogue, S-methylcysteine sulphoxide (SMCO) occurs in forage and root brassica crops. The presence of this amino acid constitutes a significant deterrent to the exploitation of these crops as fodder for ruminant animals. The adverse effects of SMCO occur after its metabolism by rumen bacteria to dimethyl disulphide (Smith, 1980). A severe haemolytic anaemia appears within 1–3 weeks in animals fed mainly or exclusively on brassica forage. Initial overt indications of the disorder include loss of appetite and reduced milk production, whereas internal changes include the appearance of refractile, stainable granules (Heinz-Ehrlich bodies) within the erythrocytes and reduced blood haemoglobin concentrations. Extensive organ damage is an accompanying feature of this condition, with the liver becoming swollen, pale and necrotic. Critical daily intakes of SMCO range from 15 to 19 g kg<sup>-1</sup> body weight irrespective of the source of the amino acid. Surviving animals continuing to graze the crop may make spontaneous but incomplete recovery with further fluctuations in blood haemoglobin concentrations. Withdrawal of the forage usually results in the restoration of normal blood composition within 3–4 weeks.

#### *Analogues of arginine*

Of the three analogues of arginine (Table 7.5), canavanine is more widely distributed and present in higher concentrations in leguminous seeds. Canavanine contributes significantly to the toxicity of *Canavalia ensiformis* (jack bean, JB) for young chicks. Adverse effects may also arise through the synthesis of canaline, a structural analogue of ornithine, by the action of arginase on canavanine. The mammalian metabolism of canavanine corresponds with that of arginine in the urea cycle (see Fig. 4.4). Since this cycle is non-functional in avian species, they are unable to synthesize arginine and, consequently, readily succumb to the adverse effects of canavanine in jack beans (D'Mello *et al.*, 1989). As shown in Table 7.6, chicks fed JB, autoclaved to denature potent lectins, grew at reduced rates and utilized food and dietary N less efficiently than control animals. Canavanine appeared in the serum of JB-fed

**Table 7.6.** Whole-animal and metabolic responses of chicks fed a control diet or autoclaved jack bean (JB) diets containing canavanine.<sup>a</sup> (Adapted from D'Mello *et al.*, 1989.)

Diet	Daily weight gain (g chick <sup>-1</sup> )	Efficiency of food conversion (g gain g <sup>-1</sup> dry matter intake)	Efficiency of nitrogen retention (g N retained g <sup>-1</sup> N consumed)	Serum canavanine (mg l <sup>-1</sup> )	Serum urea (mg l <sup>-1</sup> )
Control	35	0.761	0.609	0.0	10.6
JB basal	22	0.681	0.547	14.2	20.9
JB basal + Lys	18	0.637	0.508	10.3	27.7
JB basal + Arg	25	0.698	0.532	12.0	45.8
JB basal + Lys + Arg	27	0.702	0.540	11.1	42.5

<sup>a</sup>Canavanine content of JB basal diet: 3.7 g kg<sup>-1</sup> diet dry matter.

chicks and, in addition, serum urea concentrations exceeded control values. Lysine supplementation aggravated the effects on growth and on food intake and utilization. In contrast, arginine supplementation enhanced weight gain and food intake. These results support the existence of a canavanine–arginine antagonism analogous to that between lysine and arginine. Similarities exist in several respects. Thus in both antagonisms, arginine requirements and urea excretion are enhanced, although the relative proportions of this additional urea arising from canavanine and arginine remain to be established. The failure of supplementary arginine to substantially reduce circulating levels of the respective antagonists is a feature common to both interactions. Creatine supplementation markedly improved the efficiencies of dry matter and N utilization in chicks fed JB (D'Mello *et al.*, 1990). It is noteworthy that Austic and Nesheim (1972) also reported improvements in food utilization efficiency with creatine supplementation in the lysine–arginine antagonism. However, differences between the two interactions are also apparent in that arginine enhanced efficiencies of utilization of food and N in chicks fed excess lysine but not in those fed diets containing canavanine. Homoarginine (Table 7.5) exacerbated the effects of canavanine-induced toxicity in chicks fed JB diets, serving to illustrate the diversity of interactions among the analogues and antagonists of arginine (D'Mello, unpublished).

### *Neurotoxic amino acids*

Neurotoxic non-protein amino acids occur in the form of the structurally related lathyrogens,  $\beta$ -(N)-oxalyl amino alanine and  $\alpha,\gamma$ -diaminobutyric acid. Their occurrence in certain legume seeds has been associated with the condition of neurolathyrisms in humans, but well-defined neurotoxic effects have also been observed on administration of the pure forms of these amino acids to animals (D'Mello, 1991). There is currently some interest in the use of *Lathyrus sativus* and *Vicia sativa* grains for poultry, but the occurrence of neurolathyrogenic amino acids in these seeds may represent a primary limiting factor. Ruminants may be able to degrade neurolathyrogens as shown by the absence of toxicity in wether lambs on feeding *Lathyrus sylvestris* hay with a relatively high diaminobutyric acid concentration of 12 g kg<sup>-1</sup> dry weight (Forster *et al.*, 1991).

### *Mechanisms*

There is overwhelming evidence to indicate that the adverse effects of the non-protein amino acids are mediated via diverse mechanisms. These are summarized in Table 7.7 and discussed at length by D'Mello (1991). The multimodal action of these amino acids is exemplified by the mechanisms proposed for canavanine. The increased urea output in chicks fed JB diets containing canavanine may reflect enhanced arginase activity in the

**Table 7.7.** Diverse mechanisms underlying the adverse effects of selected non-protein amino acids.

Amino acid	Biochemical changes	Effects
Canavanine	Enhanced arginase activity	Increased arginine catabolism
	Decreased activity of ornithine decarboxylase following synthesis of canaline	Reduced polyamine synthesis
	Competition with lysine and arginine for transport	Reduced intestinal absorption of lysine and arginine
	Inhibition of transamidinase activity	Reduced creatine synthesis
	Synthesis of aberrant proteins	Enhanced protein turnover <sup>a</sup>
	Inhibition of nitric oxide synthesis	Impaired immunocompetence <sup>a</sup> ; reduced food intake <sup>a</sup>
Mimosine	Reduced synthesis of high-tyrosine proteins	Reduced wool strength <sup>a</sup>
	Reduced DNA synthesis	Inhibition of wool biosynthesis
	Complex formation with pyridoxal phosphate-dependent enzymes	Cystathioninuria
S-methylcysteine sulphoxide	Blockage of sulphhydryl groups	Inactivation of key proteins

<sup>a</sup>Speculative.

kidney. Such an increase might lead to an inadvertent loss of arginine in a manner analogous to that observed in the lysine–arginine antagonism. Canavanine administration to rats induces substantial increases in serum and urinary concentrations of ornithine. Hepatic activity of ornithine decarboxylase is reduced by a factor of five in chicks fed JB diets containing canavanine (D'Mello, 1993). These effects may be attributed to the synthesis of canaline, which forms a covalent complex with pyridoxal phosphate, thereby inhibiting activities of enzymes such as ornithine decarboxylase which require the vitamin as a cofactor. Ornithine decarboxylase is a key enzyme in the synthesis of the polyamines (see Fig. 4.3) involved in the regulation of cell growth and differentiation. Canavanine may also act by competing with arginine and lysine for transport across membranes. Another focal point for toxic action may reside in the ability of canavanine to act, like lysine, by inhibiting transamidinase activity, resulting in reduced creatine synthesis. In addition, canavanine may replace arginine during protein synthesis leading to the formation of aberrant proteins with modified functional properties. However, the evidence is equivocal and D'Mello (1991) proposed that canavanil proteins may be

degraded as rapidly as they are formed leading to enhanced overall protein turnover rates, a feature which might contribute to the poor N retention efficiencies of chicks fed JB diets (Table 7.6). Canavanine may also inhibit nitric oxide synthesis which would impair immunocompetence and reduce food intake. Canavanine is now recognized to be a potent inhibitor of food intake in pigs (Enneking *et al.*, 1993).

Despite the economic importance of *Leucaena*, information concerning the mechanism of action of mimosine remains fragmentary (Table 7.7). Consistent with the action of several structural analogues, synthesis of high-tyrosine protein components of wool is reduced in sheep given intravenous infusions of mimosine (Frenkel *et al.*, 1975). The activities of several pyridoxal phosphate-dependent enzymes may be inhibited through the ability of mimosine to form complexes with the vitamin moiety. In addition, both mimosine and 3,4-DHP are known to cause inhibition of wool follicle DNA synthesis *in vitro* (Ward and Harris, 1976).

The mode of action of SMCO requires elucidation, although it is acknowledged that its derivative, dimethyl disulphide, inactivates key proteins through blockage of sulphhydryl

groups. The reaction with reduced glutathione, a key factor in the protection of red blood cells from oxidative injury, represents one mechanism for SMCO toxicity. Brassica-fed ruminants appear to compensate for inactivation of proteins by increasing synthesis of growth hormone and thyroxine which, in turn, stimulate production of replacement proteins (Barry *et al.*, 1985).

### Amino Acid Toxicity

Unique toxic effects may be precipitated on feeding excess quantities of individual amino acids by virtue of their particular structural or functional properties. Benevenga and Steele (1984) reviewed the evidence derived principally from observations with laboratory animals. The acute growth depressions caused by excesses of some individual amino acids may be accompanied by profound and specific lesions in organs and tissues. Toxicities may also be demonstrated in farm livestock, and Baker (1989) indicated that, at 40 g kg<sup>-1</sup> diet, methionine is the most growth-depressing amino acid. At this inclusion level, leucine, isoleucine, and valine do not impair growth when added to practical diets for pigs and poultry. Excess threonine depresses growth in chicks but not in pigs, whereas arginine is more toxic to the pig than the fowl. Scherer and Baker (2000) suggest that excess methionine may increase vitamin B<sub>6</sub> requirements of young chicks. In calves, manifestations of methionine toxicity include reduced food intake, depressed N retention and body weight loss (Abe *et al.*, 1999). Such instances of toxicity are, in the main, confined to experimental situations. However, Adeola and Ball (1992) reported that dietary excesses of tryptophan or tyrosine administered for 5 days prior to slaughter reduced stress in pigs, a response attributed to increased hypothalamic concentrations of several neurotransmitters.

Of some practical significance is the occasional incidence, under natural conditions, of interstitial pulmonary emphysema and oedema in ruminants subjected to sudden changes in diet. This syndrome is associated with the ruminal production of abnormal quantities of 3-methylindole (skatole) from

tryptophan. Oral or intraruminal administration of tryptophan or the indole to cattle can cause respiratory distress and pulmonary lesions similar to those seen in the natural disorder (Carlson *et al.*, 1968). Toxicity is mediated after the indole is metabolically activated by a mixed function oxidase to a reactive free radical product capable of initiating tissue damage in the lung. The severity of the syndrome may be reduced by dietary treatments which increase tissue glutathione. Tryptophan toxicity depends on the balance between metabolic activation of 3-methylindole and its conjugation with glutathione.

The unusual amino acid, lysinoalanine, may arise during alkali treatment of protein feedstuffs (Finot, 1983). The feeding of proteins containing lysinoalanine causes a reduction in biological values of diets for rats and in the induction of renal lesions. The significance of these observations in farm animal nutrition requires elucidation since alkali treatment may be used for denaturing antigenically active globular proteins in soybean meal.

### Conclusions

The categories of imbalances, antagonisms and toxicities elucidated in studies with the rat constitute a satisfactory basis for classifying the adverse effects of amino acids in farm livestock. Amino acid imbalances are ubiquitous in conventional diets fed to non-ruminants, causing reductions in growth and N utilization. In pigs fed once daily, imbalances may also occur at the tissue level due to differential rates of absorption of amino acids from crystalline and intact protein sources. With poultry, high-protein diets based on poor-quality ingredients may depress utilization of the first-limiting amino acid, an effect attributed to amino acid imbalance. Antagonisms occur widely in livestock nutrition due to adverse ratios of lysine and arginine and of the branched-chain amino acids in some common feedstuffs. Adverse effects may also arise from the presence of non-protein amino acid analogues such as mimosine in *Leucaena* and SMCO in brassica forages. Although ruminants are normally less susceptible to dietary amino acid imbalances and toxicities, there

are notable instances when ruminal metabolism serves to precipitate deleterious effects through the production of reactive metabolites from mimosine, SMCO, and tryptophan.

The adverse effects of amino acid imbalances are precipitated via reductions in food intake and alterations in the brain uptake and metabolism of amino acids, but the precise mechanisms await elucidation. In contrast, antagonisms are mediated via a diverse array of mechanisms including modulation of

enzyme activities and competition with specific indispensable amino acids for transport and protein synthesis.

Animals are able to adapt to disproportionate intakes of certain amino acids by enhancing disposition. However, the most striking example of degradation is that achieved by some rumen bacteria enabling *Leucaena*-fed cattle and goats in many regions of the tropics to metabolize mimosine to innocuous residues.

## References

- Abe, M., Iriki, T., Koresawa, Y., Inoue, K. and Funaba, M. (1999) Adverse effects of excess DL-methionine in calves with different body weights. *Journal of Animal Science* 77, 2837–2845.
- Abebe, S. and Morris, T.R. (1990a) Note on the effects of protein concentration on responses to dietary lysine by chicks. *British Poultry Science* 31, 255–260.
- Abebe, S. and Morris, T.R. (1990b) Effects of protein concentration on responses to dietary tryptophan by chicks. *British Poultry Science* 31, 267–272.
- Adeola, O. and Ball, R.O. (1992) Hypothalamic neurotransmitter concentrations and meat quality in stressed pigs offered excess dietary tryptophan and tyrosine. *Journal of Animal Science* 70, 1888–1894.
- Anderson, L.C., Lewis, A.J., Peo, E.R. and Crenshaw, J.D. (1984) Effects of excess arginine with and without supplemental lysine on performance, plasma amino acid concentrations and nitrogen balance of young swine. *Journal of Animal Science* 58, 369–377.
- Austic, R.E. and Nesheim, M.C. (1972) Arginine and creatine interrelationships in the chick. *Poultry Science* 51, 1098–1105.
- Baker, D.H. (1989) Amino acid nutrition of pigs and poultry. In: Haresign, W. and Cole, D.J.A. (eds) *Recent Advances in Animal Nutrition*. Butterworths, London, pp. 245–260.
- Balnave, D. and Brake, J. (1999) Responses of broilers to sodium bicarbonate supplementation of diets containing varying arginine:lysine ratios. *Australian Journal of Agricultural Research* 50, 425–430.
- Barry, T.N., Manley, T.R., Redekopp, C. and Allsop, T.F. (1985) Endocrine regulation of metabolism in sheep given kale (*Brassica oleracea*) and ryegrass (*Lolium perenne*)-clover (*Trifolium repens*) fresh forage diets. *British Journal of Nutrition* 54, 165–173.
- Batterham, E.S. (1974) The effect of frequency of feeding on the utilization of free lysine by growing pigs. *British Journal of Nutrition* 31, 237–242.
- Benevenga, N.J. and Steele, R.D. (1984) Adverse effects of excessive consumption of amino acids. *Annual Review of Nutrition* 4, 157–181.
- Benevenga, N.J., Harper, A.E. and Rogers, Q.R. (1968) Effects of an amino acid imbalance on the metabolism of the most limiting amino acid in the rat. *Journal of Nutrition* 95, 434–444.
- Beverly, J.L., Gietzen, D.W. and Rogers, Q.R. (1990a) Effect of the dietary limiting amino acid in the prepyriform cortex on food intake. *American Journal of Physiology* 259, R709–R715.
- Beverly, J.L., Gietzen, D.W. and Rogers, Q.R. (1990b) Effect of the dietary limiting amino acid in the prepyriform cortex on meal patterns. *American Journal of Physiology* 259, R716–R723.
- Beverly, J.L., Hrupka, B.J., Gietzen, D.W. and Rogers, Q.R. (1991a) Distribution of the dietary limiting amino acid injected into the prepyriform cortex. *American Journal of Physiology* 260, R525–R532.
- Beverly, J.L., Gietzen, D.W. and Rogers, Q.R. (1991b) Threonine concentration in the prepyriform cortex has separate effects on dietary selection and intake of a threonine-imbalanced diet by rats. *Journal of Nutrition* 121, 1287–1292.
- Brake, J., Balnave, D. and Dibner, J.J. (1998) Optimum dietary arginine:lysine ratio for broiler chickens is altered during heat stress in association with changes in intestinal uptake and dietary sodium chloride. *British Poultry Science* 39, 639–647.
- Bray, D.J. (1970) The isoleucine and valine nutrition of young laying pullets as influenced by excessive dietary leucine. *Poultry Science* 49, 1334–1341.



- Calvert, C.C., Klasing, K.C. and Austic, R.E. (1982) Involvement of food intake and amino acid catabolism in the branched chain amino acid antagonism in chicks. *Journal of Nutrition*, 112, 627–635.
- Carlson, J.R., Dyer, I.A. and Johnson, R.J. (1968) Tryptophan-induced interstitial pulmonary emphysema in cattle. *American Journal of Veterinary Research* 29, 1983–1989.
- D'Mello, J.P.F. (1974) Plasma concentrations and dietary requirements of leucine, isoleucine and valine: studies with the young chick. *Journal of the Science of Food and Agriculture* 25, 187–196.
- D'Mello, J.P.F. (1975) Amino acid requirements of the young turkey: leucine, isoleucine and valine. *British Poultry Science* 16, 607–615.
- D'Mello, J.P.F. (1988) Dietary interactions influencing amino acid utilization by poultry. *World's Poultry Science Journal* 44, 92–102.
- D'Mello, J.P.F. (1990) Lysine utilisation by broiler chicks. *Proceedings of VIII European Poultry Conference, Barcelona, Spain*, pp. 302–305.
- D'Mello, J.P.F. (1991) Toxic amino acids. In: D'Mello, J.P.F., Duffus, C.M. and Duffus, J.H. (eds) *Toxic Substances in Crop Plants*. The Royal Society of Chemistry, Cambridge, pp. 21–48.
- D'Mello, J.P.F. (1993) Non-protein amino acids in *Canavalia ensiformis* and hepatic ornithine decarboxylase. *Amino Acids* 5, 212–213.
- D'Mello, J.P.F. (1994) Amino acid imbalances, antagonisms and toxicities. In: D'Mello, J.P.F. (ed.) *Amino Acids in Farm Animal Nutrition*. CAB International, Wallingford, UK, pp. 63–97.
- D'Mello, J.P.F. and Lewis, D. (1970a) Amino acid interactions in chick nutrition. 1. The interrelationship between lysine and arginine. *British Poultry Science* 11, 299–311.
- D'Mello, J.P.F. and Lewis, D. (1970b) Amino acid interactions in chick nutrition. 2. The interrelationship between leucine, isoleucine and valine. *British Poultry Science* 11, 313–323.
- D'Mello, J.P.F. and Lewis, D. (1970c) Amino acid interactions in chick nutrition. 3. Interdependence in amino acid requirements. *British Poultry Science* 11, 367–385.
- D'Mello, J.P.F. and Lewis, D. (1971) Amino acid interactions in chick nutrition. 4. Growth, food intake and plasma amino acid patterns. *British Poultry Science* 12, 345–358.
- D'Mello, J.P.F., Acamovic, T. and Walker, A.G. (1989) Nutritive value of jack beans (*Canavalia ensiformis*) (L.) (DC.) for young chicks: effects of amino acid supplementation. *Tropical Agriculture (Trinidad)* 66, 201–205.
- D'Mello, J.P.F., Walker, A.G. and Noble, E. (1990) Effects of dietary supplements on the nutritive value of jack beans (*Canavalia ensiformis*) for the young chick. *British Poultry Science* 31, 759–768.
- Edmonds, M.S. and Baker, D.H. (1987) Failure of excess dietary lysine to antagonise arginine in young pigs. *Journal of Nutrition* 117, 1396–1401.
- Enneking, D., Giles, L.C., Tate, M.E. and Davies, R.L. (1993) Canavanine: a natural feed-intake inhibitor for pigs. *Journal of the Science of Food and Agriculture* 61, 315–325.
- Finot, P.A. (1983) Lysinoalanine in food proteins. *Nutrition Abstracts and Reviews* 53A, 67–80.
- Fisher, H., Griminger, P., Leveille, G.A. and Shapiro, R. (1960) Quantitative aspects of lysine deficiency and amino acid imbalance. *Journal of Nutrition* 71, 213–220.
- Forster, L.A., Fontenot, J.P., Perry, H.D., Foster, J.G. and Allen, V.G. (1991) Apparent digestibility and nutrient balance in lambs fed different levels of flatpea hay. *Journal of Animal Science* 69, 1719–1725.
- Frenkel, M.J., Gillespie, J.M. and Ries, P.J. (1975) Studies on the inhibition of synthesis of the tyrosine-rich proteins of wool. *Australian Journal of Biological Sciences* 28, 331–338.
- Gietzen, D.W., Leung, P.M.B. and Rogers, Q.R. (1986) Noradrenaline and amino acids in prepyriform cortex of rats fed imbalanced amino acid diets. *Physiology of Behaviour* 36, 1071–1080.
- Gietzen, D.W., Erecius, L.F. and Rogers, Q.R. (1998) Neurochemical changes after imbalanced diets suggest a brain circuit mediating anorectic responses to amino acid deficiency in rats. *Journal of Nutrition* 128, 771–781.
- Harper, A.E. (1959) Amino acid balance and imbalance. *Journal of Nutrition* 68, 405–418.
- Harper, A.E. (1964) Amino acid toxicities and imbalances. In: Munro, H.N. and Allison, J.B. (eds) *Mammalian Protein Metabolism*, Vol. II. Academic Press, New York, pp. 87–134.
- Harper, A.E. and Rogers Q.R. (1965) Amino acid imbalance. *Proceedings of the Nutrition Society* 24, 173–190.
- Harper, A.E., Benevenga, N.J. and Wohlheuter, R.M. (1970) Effects of ingestion of disproportionate amounts of amino acids. *Physiological Reviews* 50, 428–558.
- Harper, A.E., Miller, R.H. and Block, K.P. (1984) Branched-chain amino acid metabolism. *Annual Review of Nutrition* 4, 409–454.

- Harrison, L.M. and D'Mello, J.P.F. (1986) Large neutral amino acids in the diet and neurotransmitter concentrations in the chick brain. *Proceedings of the Nutrition Society* 45, 72A.
- Harrison, L.M. and D'Mello, J.P.F. (1987) Zinc deficiency, amino acid imbalance and brain catecholamine concentrations in the chick. *Proceedings of the Nutrition Society* 46, 58A.
- Jones, J.D. (1961) Lysine toxicity in the chick. *Journal of Nutrition* 73, 107–112.
- Jones, J.D., Wolters, R. and Burnett, P.C. (1966) Lysine–arginine–electrolyte relationships in the rat. *Journal of Nutrition* 89, 171–188.
- Jones, R.J. (1985) *Leucaena* toxicity and the ruminal degradation of mimosine. In: Seawright, A.A., Hegarty, M.P., James, L.F. and Keeler, R.F. (eds) *Plant Toxicology*. Queensland Poisonous Plants Committee, Yeerongpilly, pp. 111–119.
- Kumta, U.S., Harper, A.E. and Elvehjem, C.A. (1958) Amino acid imbalance and nitrogen retention in adult rats. *Journal of Biological Chemistry* 233, 1505–1508.
- Langer, S. and Fuller, M.F. (1994) The effect of excessive amounts of branched-chain amino acids on amino acid utilization in growing pigs. *Proceedings of the Nutrition Society* 53, 108A.
- Langer, S., Scislawski, P.W.D., Brown, D.S., Dewey, P. and Fuller, M.F. (2000) Interactions among the branched-chain amino acids and their effects on methionine utilization in growing pigs: effects on plasma amino- and keto-acid concentrations and branched-chain keto-acid dehydrogenase activity. *British Journal of Nutrition* 83, 49–58.
- Leibholz, J. (1989) The utilisation of the free and protein-bound lysine. In: Friedman, M. (ed.) *Absorption and Utilisation of Amino Acids*, Vol. III. CRC Press, Boca Raton, Florida, pp. 175–187.
- Leibholz, J., Love, R.J., Mollah, Y. and Carter, R.R. (1986) The absorption of dietary L-lysine and extruded L-lysine in pigs. *Animal Feed Science and Technology* 15, 141–148.
- Leung, P.M.B. and Rogers, Q.R. (1969) Food intake: regulation by plasma amino acid pattern. *Life Sciences* 8, 1–9.
- Leung, P.M.B. and Rogers, Q.R. (1987) The effect of amino acids and protein on dietary choice. In: Kawamura, Y. and Kate, M.R. (eds) *Umami: a Basic Taste*. Marcel Dekker, New York, pp. 565–610.
- Leung, P.M.B., Gietzen, D.W. and Rogers, Q.R. (1985) Alterations in the amino acid profile of prepyriform cortex from rats fed amino acid-imbalanced diets. *Federation Proceedings* 44, 1523.
- Morris, T.R., Al-Azzawi, K., Gous, R.M. and Simpson, G.L. (1987) Effects of protein concentration on responses to dietary lysine by chicks. *British Poultry Science* 28, 185–195.
- Moughan, P.J. (1991) Towards an improved utilization of dietary amino acids by the growing pig. In: Haresign, W. and Cole, D.J.A. (eds) *Recent Advances in Animal Nutrition*. Butterworths, London, pp. 45–64.
- Nesheim, M.C. (1968) Kidney arginase activity and lysine tolerance in strains of chickens selected for a high or low requirement of arginine. *Journal of Nutrition* 95, 79–87.
- Oestemer, G.A., Hanson, L.E. and Meade, R.J. (1973) Leucine–isoleucine interrelationship in the young pig. *Journal of Animal Science* 36, 674–678.
- Pant, K.C., Rogers, Q.R. and Harper, A.E. (1972) Growth and food intake of rats fed tryptophan-imbalanced diets with or without niacin. *Journal of Nutrition* 102, 117–130.
- Papet, I., Breuille, D., Glomot, F. and Arnal, M. (1988a) Nutritional and metabolic effects of dietary leucine excess in preruminant lambs. *Journal of Nutrition* 118, 450–455.
- Papet, I., Lezebot, N., Arnal, M. and Harper, A.E. (1988b) Influence of dietary leucine content on the activities of branched-chain amino acid aminotransferase (EC 2.6.1.42) and branched-chain  $\alpha$ -keto acid dehydrogenase (EC 1.2.4.4) complex in tissues of preruminant lambs. *British Journal of Nutrition* 59, 475–483.
- Partridge, I.G., Low, A.G. and Keal, H.D. (1985) A note on the effect of feeding frequency on nitrogen use in growing boars given diets with varying levels of free lysine. *Animal Production* 40, 375–377.
- Peng, Y., Tews, J.K. and Harper, A.E. (1972) Amino acid imbalance, protein intake and changes in rat brain and plasma amino acids. *American Journal of Physiology* 222, 314–321.
- Quirk, M.F., Bushell, J.J., Jones, R.J., Megaritty, R.G. and Butler, K.L. (1988) Liveweight gains on *Leucaena* and native grass pastures after dosing cattle with rumen bacteria capable of degrading DHP, a ruminal metabolite from *Leucaena*. *Journal of Agricultural Science, Cambridge* 11, 165–170.
- Reis, P.J., Puchala, R., Sahl, T. and Goetsch, A.L. (1999) Effects of mimosine and 2,3-dihydroxypyridine on fiber shedding in Angora goats. *Journal of Animal Science* 77, 1224–1229.
- Richert, B.T., Goodband, R.D., Tokach, M.D. and Nelssen, J.L. (1997) Increasing valine, isoleucine and total branched-chain amino acids for lactating sows. *Journal of Animal Science* 75, 2117–2128.

- Robinson, P.H., Chalupa, W., Sniffen, C.J., Julien, W.E., Sato, H., Fujieda, T., Ueda, T. and Suzuki, H. (2000) Influence of abomasal infusion of high levels of lysine or methionine, or both, on ruminal fermentation, eating behaviour, and performance of lactating dairy cows. *Journal of Animal Science* 78, 1067–1077.
- Sanahuja, J.C. and Harper, A.E. (1962) Effect of amino acid imbalance on food intake and preference. *American Journal of Physiology* 202, 165–170.
- Scherer, C.S. and Baker, D.H. (2000) Excess dietary methionine markedly increases the vitamin B-6 requirement of young chicks. *Journal of Nutrition* 130, 3055–3058.
- Smith, R.H. (1980) Kale poisoning: the brassica anaemia factor. *Veterinary Record* 107, 12–15.
- Tews, J.K., Kim, Y.W.L. and Harper, A.E. (1979) Induction of threonine imbalance by dispensable amino acids: relation to competition for amino acid transport into brain. *Journal of Nutrition* 109, 304–315.
- Tews, J.K., Kim, Y.W.L. and Harper, A.E. (1980) Induction of threonine imbalance by dispensable amino acids: relationships between tissue amino acids and diet in rats. *Journal of Nutrition* 110, 394–408.
- Tobin, G. and Boorman, K.N. (1979) Carotid or jugular amino acid infusions and food intake in the cockerel. *British Journal of Nutrition* 41, 157–162.
- Wang, T.C. and Fuller, M.F. (1989) The optimum dietary amino acid pattern for growth in pigs. 1. Experiments by amino acid deletion. *British Journal of Nutrition* 62, 77–89.
- Ward, K.A. and Harris, R.L.N. (1976) Inhibition of wool follicle DNA synthesis by mimosine and related 4(1H)-pyridones. *Australian Journal of Biological Sciences* 29, 189–196.
- Wethli, E., Morris, T.R. and Shresta, T.P. (1975) The effect of feeding high levels of low-quality proteins to growing chickens. *British Journal of Nutrition* 34, 363–373.
- Winje, M.E., Harper, A.E., Benton, D.A., Boldt, R.E. and Elvehjem, C.A. (1954) Effect of dietary amino acid balance on fat deposition in the livers of rats fed low protein diets. *Journal of Nutrition* 54, 155–166.
- Yoshida, A., Leung, P.M.B., Rogers, Q.R. and Harper, A.E. (1966) Effects of amino acid imbalance on the fate of the limiting amino acid. *Journal of Nutrition* 89, 80–90.
- Yuan, J.H., Davis, A.J. and Austic, R.E. (2000) Temporal response of hepatic threonine dehydrogenase in chickens to the initial consumption of a threonine-imbalanced diet. *Journal of Nutrition* 30, 2746–2752.

# 8 Methionine–Cystine Relationships in Pig Nutrition

A.J. Lewis\*

Department of Animal Science, University of Nebraska, Lincoln, Nebraska, USA

---

## Introduction

Among the 20 amino acids that constitute the primary structure of proteins, two, methionine and cysteine, contain a sulphur atom. Because of their interconversions, these two amino acids are usually classified together as sulphur-containing amino acids or sulphur amino acids.

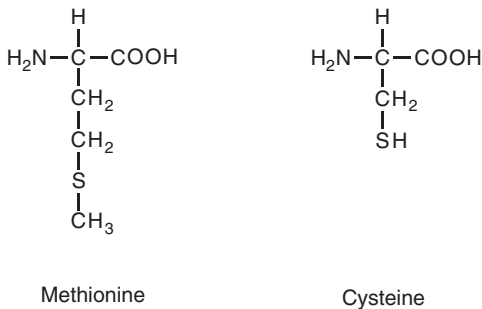
Methionine, whose name is derived from its chemical name, 2-amino-4-(methylthiol)butyric acid, is nutritionally essential for all animal species. Cysteine, like methionine, is incorporated into proteins based on the genetic code, however, from a nutritional point of view cysteine is classified as conditionally dispensable in most animal species, including pigs (Table 1.1). Cysteine is unstable in solution and is readily oxidized to the dimer form, cystine. Thus when proteins are hydrolysed cystine is produced, with the number of moles of cystine being equal to half the number of moles of cysteine within the protein structure. For this reason, it is cystine that is normally considered in a nutritional context, and the term sulphur amino acids usually means methionine + cystine. Cystine was first isolated from urinary bladder calculi and named from the Greek word (*kystis*), meaning bladder. The structures of methionine and cysteine are illustrated in Fig. 8.1, and the conversion of cysteine into cystine is shown in Fig. 8.2. The term 'cyst(e)ine' is used to refer to cysteine and/or cystine.

## Analytical Difficulties

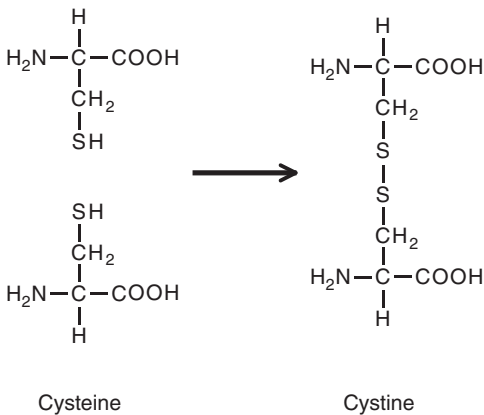
One of the challenges in reviewing the nutrition of methionine and cystine for pigs is the difficulty in analysis for these two amino acids. As discussed by Williams (1994), methionine and cyst(e)ine undergo oxidation during the 'standard method' of hydrolysis. Substantial amounts of methionine and cyst(e)ine are lost. To circumvent this, the sulphur amino acids must be protected before hydrolysis. The usual method is a controlled oxidation of methionine to methionine sulphone and cyst(e)ine to cysteic acid (Schram *et al.*, 1954). Performic acid is used to oxidize the amino acids and hydrogen bromide is added as the reducing agent to destroy the excess performic acid when the oxidation is complete (Moore, 1963).

In addition, the complete removal of HCl from the sample is critical when lithium-based, ion-exchange chromatography is used. The resolution of the early eluted peaks, which include cysteic acid, aspartic acid, methionine sulphone, and threonine, is very sensitive to the pH of the injected sample (Mondino *et al.*, 1972). A small change in sample pH can change the shape and size of the aspartic acid peak and can also change the retention times of both the methionine sulphone and threonine peaks affecting their resolution (Pickering, 1989; Grunau and Swiader, 1992).

\*E-mail address: alewis@unlnotes.unl.edu



**Fig. 8.1.** Structures of methionine and cysteine.



**Fig. 8.2.** Conversion of two molecules of cysteine into one molecule of cystine.

Analysis of methionine and cysteine in plasma and serum is also sensitive to the methods used before the chromatographic analysis. Plasma and serum should be deproteinized as soon as possible after collection because deproteinizing before freezing helps to prevent loss of methionine and cysteine (Stein and Moore, 1954; DeWolfe *et al.*, 1967).

Difficulties in analysis for the sulphur amino acids make it crucial that analytical methods are described in research papers. Unfortunately, much of the older research, and some more current research, failed to use adequate analysis methods and therefore the results of experiments can be difficult to interpret.

### Metabolic Conversions

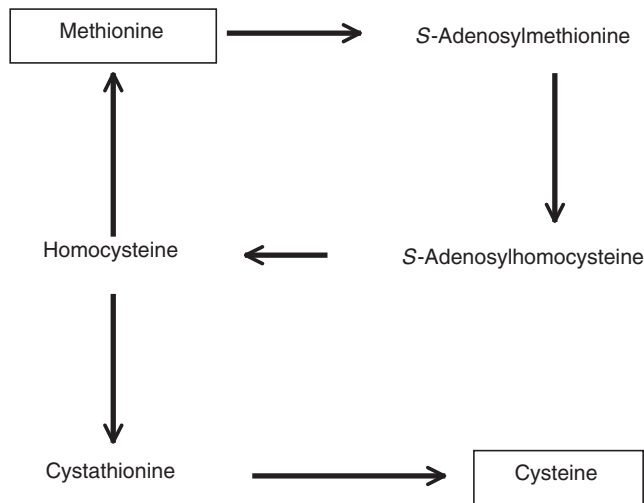
The metabolic relationships between methionine and cysteine are well established (Fig.

8.3). Methionine can be activated by ATP to S-adenosylmethionine. This compound readily donates its methyl group to a wide variety of acceptors. The resulting compound, S-adenosylhomocysteine, is then hydrolysed to homocysteine and adenosine. Homocysteine is a key intermediate because it can be remethylated to methionine or can condense with serine to form cystathionine and then cysteine. An important feature of these conversions is that the conversion of homocysteine into cysteine is not reversible. The net effect of these metabolic pathways is that methionine can be converted into cysteine, but cysteine cannot be converted into methionine. Several of the steps in the activated methyl cycle (in which methionine is demethylated to homocysteine and homocysteine is then remethylated to methionine) require B-vitamin coenzymes. Thus, there are important relationships between the sulphur amino acids and other nutrients.

### Nutritional Essentiality

The first study in which one of the sulphur amino acids was added to the diet of pigs was described by Bell *et al.* (1950). These authors reported that the addition of methionine at  $2.0 \text{ g kg}^{-1}$  to a semipurified diet in which soybean meal provided the sole source of protein improved biological value. The basal soybean meal diet contained  $100 \text{ g kg}^{-1}$  protein and  $0.7 \text{ g kg}^{-1}$  methionine, but the cystine content of this diet was not given. The biological value of the methionine-supplemented diet and the weight gain of the pigs fed this diet were equal to those of pigs fed a whole egg protein diet with  $100 \text{ g kg}^{-1}$  protein and  $2.7 \text{ g kg}^{-1}$  methionine. This study was the first to show that methionine was an essential amino acid for pigs. Previous research had shown that methionine was essential for rats, mice, chicks and humans.

One year later, Shelton *et al.* (1951) fed a semipurified diet containing  $210 \text{ g kg}^{-1}$  protein,  $1.0 \text{ g kg}^{-1}$  methionine, and  $0.1 \text{ g kg}^{-1}$  cysteine to growing pigs. They supplemented the diet with either methionine, cystine, or a mixture of the two amino acids. Supplementation with  $6.0 \text{ g kg}^{-1}$  cystine



**Fig. 8.3.** Metabolic pathways of sulphur amino acids.

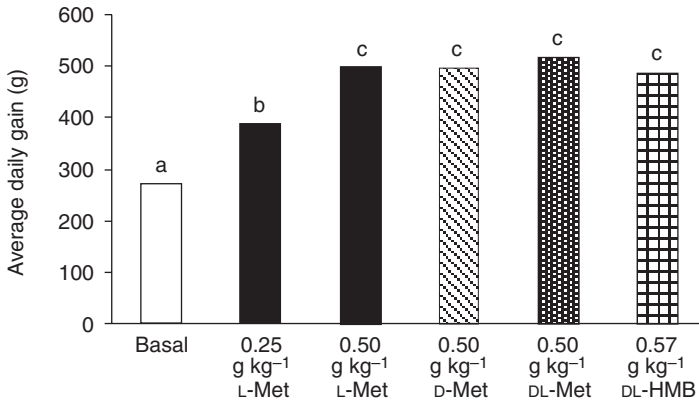
increased weight gain from 43 to 163 g day<sup>-1</sup>, whereas supplementation with 5.0 g kg<sup>-1</sup> methionine increased weight gain to 572 g day<sup>-1</sup>. Furthermore, supplementation with 2.0 g kg<sup>-1</sup> methionine and 3.0 g kg<sup>-1</sup> cystine was as effective as supplementation with 5.0 g kg<sup>-1</sup> methionine or 5.0 g kg<sup>-1</sup> methionine plus 6.0 g kg<sup>-1</sup> cysteine. These results confirmed the essentiality of methionine and placed cystine in the 'conditionally dispensable' category. These early results indicated that the total sulphur amino acid requirement of pigs weighing approximately 20 kg was 6.0 g kg<sup>-1</sup> of the diet and that all of this could be provided by methionine or half could be provided by methionine and half by cystine. Although these conclusions were based on very limited numbers of animals, and there was no evidence of statistical analysis, current estimates of sulphur amino acid requirements are remarkably similar to these early values.

### Bioavailability of D-Methionine and D-Cysteine

Unlike most other amino acids, which are produced commercially by fermentation, crystalline methionine is produced by chemical synthesis. This has an important biological implication because whereas fermentation

yields only the natural L-isomer, chemical synthesis yields a racemic (50:50) mixture of D- and L-isomers (DL-methionine). D-Amino acids are not used by animals for protein synthesis or for other metabolic purposes. Therefore, any ingested D-methionine must be converted into L-methionine before it can be utilized. The conversion (or inversion) consists of two steps: (1) oxidative deamination to the  $\alpha$ -keto acid (2-keto-4-(methylthio)butyric acid) and (2) transamination of an amino group from glutamate. Most animals except primates readily convert D-methionine into L-methionine, and this is true for pigs. Although an early study indicated that the D-form was used less effectively than the L-form by very young pigs (Kim and Bayley, 1983), later studies indicated that DL-methionine and L-methionine were nutritionally equivalent (Reifsnnyder *et al.*, 1984; Chung and Baker, 1992a). The results of Chung and Baker (1992a) show equal utilization of D-, L- and DL-methionine by 10-kg pigs (Fig. 8.4). Commercial feed-grade methionine is in the DL-form.

In contrast to methionine, the D-isomer of cysteine does not have bioactivity. Apparently, there is no metabolic pathway from D-cysteine to the  $\alpha$ -keto analogue of cysteine and therefore neither D-cysteine nor D-cystine has biological activity (Baker, 1994; Lewis and Baker, 1995).



**Fig. 8.4.** Average daily gain of 10-kg pigs fed a basal diet (containing 1.9 g kg<sup>-1</sup> methionine and 10 g kg<sup>-1</sup> cystine) supplemented with various sources of methionine (Chung and Baker, 1992a). The amount of 0.57 g kg<sup>-1</sup> HMB (2-hydroxy-4-(methylthio)butyric acid, also known as methionine hydroxy analogue) is equimolar to 0.5 g kg<sup>-1</sup> methionine. Bars without a common letter (a, b or c) differ ( $P < 0.05$ ).

### Bioavailability of Methionine Analogues

In addition to DL-methionine, which is marketed in a 99% pure feed-grade form (Degussa, 2001), other sources of supplemental methionine activity are available to the animal feed industry. In particular, 2-hydroxy-4-(methylthio)butyric acid (HMB), commonly known as methionine hydroxy analogue, has been manufactured in both solid and liquid forms. The solid consists of two moles of HMB bound to calcium by the two carboxyl carbons and generally contains 86% HMB. The liquid contains 88% HMB, which exists in monomer (77%), dimer (17.2%), trimer (4%), and oligomer (1.8%) forms (Novus International, 2001). All HMB products are 50% D-HMB and 50% L-HMB.

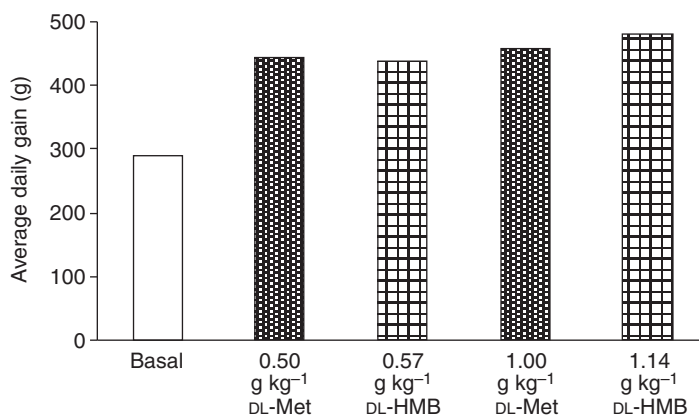
There has been considerable controversy about the biological value of HMB relative to DL-methionine. The controversy has been fuelled by the commercial importance of methionine supplements, especially in poultry. Although there has been a wide range of estimates, poultry seem to utilize HMB with lower molar efficiency than DL-methionine (see review by Lewis and Baker, 1995). In pigs, however, most, but not all, research supports the conclusion that HMB and DL-methionine are equal sources of methionine

activity on a molar basis (Becker *et al.*, 1955; Urbańczyk *et al.*, 1981; Reifsnnyder *et al.*, 1984; Steinhart and Kirchgessner, 1985; Roth and Kirchgessner, 1986; Chung and Baker, 1992a; Stockland *et al.*, 1992; Knight *et al.*, 1998; Römer and Abel, 1999). Although, this conclusion continues to be challenged (Pack and Höhler, 2000), data of Chung and Baker (1992a; Fig. 8.4) and Knight *et al.* (1998; Fig. 8.5) provide clear illustrations of equal efficacy of DL-methionine and the liquid form of HMB.

Because HMB does not contain nitrogen, supplementation with HMB results in less excretion of urinary nitrogen than supplementation with an equivalent amount of DL-methionine (Römer and Abel, 1999). This would obviously be advantageous when minimization of nitrogen excretion is important.

### Sulphur Amino Acid Requirements

In pig diets based on cereal grains and oilseed meals, sulphur amino acids are usually the second, third or fourth limiting amino acids (Lewis, 2001). The other limiting amino acids are lysine, threonine and tryptophan. Because of this importance, numerous experiments have investigated the sulphur amino acid requirements of pigs. A comprehensive review



**Fig. 8.5.** Average daily gain of 4-kg pigs fed a basal diet (containing 2.3 g kg<sup>-1</sup> methionine and 4.8 g kg<sup>-1</sup> cystine) supplemented with DL-methionine or 2-hydroxy-4-(methylthio)butyric acid (HMB) (Knight *et al.*, 1998). The amounts of HMB (0.57 and 1.14 g kg<sup>-1</sup>) are equimolar to 0.5 and 1.0 g kg<sup>-1</sup> DL-methionine. The contrasts basal vs. (0.50 g kg<sup>-1</sup> methionine + 0.57 g kg<sup>-1</sup> HMB) and (0.50 g kg<sup>-1</sup> methionine + 0.57 g kg<sup>-1</sup> HMB) vs. (1.0 g kg<sup>-1</sup> methionine + 1.14 g kg<sup>-1</sup> HMB) were significant ( $P < 0.05$ ); there was no difference between DL-methionine and HMB.

of sulphur amino acid requirements was published by NRC (1998). A computer model is included that enables requirements to be calculated for growing pigs with specific weights and lean growth rates or for sows with specified levels of reproductive performance.

To adjust for differences in bioavailability in amino acids among different feedstuffs, the NRC computer model uses true (or standardized) ileal digestible amino acids. However, output is also provided in terms of apparent ileal digestible amino acids and also as total amino acids. The NRC requirements (on a true ileal digestible basis) for methionine + cystine decrease from 7.6 to 3.1 g kg<sup>-1</sup> of the diet, as pigs increase in weight from the 3- to 5-kg range up to the 80- to 120-kg range. This is an increased requirement from 1.9 to 9.5 g day<sup>-1</sup> over the same weight ranges. For sows, methionine + cystine requirements range from 3.1 to 3.3 g kg<sup>-1</sup> (5.7–6.4 g day<sup>-1</sup>) during gestation and from 3.5 to 4.3 g kg<sup>-1</sup> (13.9–26.0 g day<sup>-1</sup>) during lactation, depending on the level of production.

Some additional research on sulphur amino acid requirements of pigs is available that was not included in the NRC review. Kirchgessner *et al.* (1994a) reported that in 7- to 30-kg pigs the optimal ratio of methionine

+ cystine:lysine depended on the dietary lysine concentration and thus the growth rates of the pigs. At the highest lysine concentrations fed (11 g kg<sup>-1</sup>) the optimal methionine + cystine:lysine ratio was 56–57%. This is identical to the NRC ratio for this weight range. In another experiment, Kirchgessner *et al.* (1994b) found that weight gain and feed efficiency of pigs weighing 20–60 kg were maximized when the total methionine content was 3.1 g kg<sup>-1</sup> (3.4 g kg<sup>-1</sup> of dry matter). For pigs weighing 60–95 kg, weight gains were maximized with 2.4 g kg<sup>-1</sup> total methionine (2.6 g kg<sup>-1</sup> of dry matter). These values are higher than the corresponding NRC values of 2.5 and 2.0 g kg<sup>-1</sup>, respectively. However the estimates of methionine + cystine requirements (4.9 and 4.1 g kg<sup>-1</sup>) were somewhat lower than the NRC requirements (5.4 and 4.4 g kg<sup>-1</sup>). Obviously, this implies a discrepancy in the proportion of methionine + cystine requirement that can be provided by cystine. This issue will be discussed more in a later section.

Knowles *et al.* (1998) reported that for pigs from approximately 75 to 110 kg the ratio of total sulphur amino acids:lysine required was no greater than 47% to maximize growth performance and carcass



muscling, although the ratio to minimize fat deposition was 65%. In comparison, the NRC value for 80–120 kg is 58%. Loughmiller *et al.* (1998) found that the apparent ileal digestible methionine requirement of gilts in the late finishing stages was  $1.25 \text{ g kg}^{-1}$  ( $\approx 3.0 \text{ g}$  of apparent ileal digestible methionine  $\text{day}^{-1}$ ) or 25% of the ileal digestible lysine requirement. These values are all lower than the NRC requirements of  $1.3 \text{ g kg}^{-1}$ ,  $4.1 \text{ g day}^{-1}$ , and 28% of lysine for apparent ileal digestible methionine.

Recently, Matthews *et al.* (2001c) determined that the sulphur amino acid requirement of pigs from 5 to 10 kg was  $6.4 \text{ g kg}^{-1}$  on an apparent ileal digestible basis. This is almost identical to the NRC requirement of  $6.3 \text{ g kg}^{-1}$ .

Thus, some of these additional results suggest requirements higher than those of the NRC and some suggest lower requirements. Overall, it seems that the NRC requirements are satisfactory, although there is some indication that the requirements during late finishing stages may be lower than indicated by NRC.

### Ileal Digestibility vs. Bioavailability

Batterham *et al.* (1993) found that ileal digestibility may not always provide a good estimate of methionine bioavailability, especially for protein supplements that have been heat processed. The proportion of apparent ileal digestible methionine retained by pigs differed among different protein sources. The proportions were 39% for cottonseed meal, 45% for meat and bone meal, and 47% for soybean meal. The authors concluded that in 'heat-processed meals a considerable proportion of the methionine is absorbed in a form(s) that is (are) inefficiently utilized'.

### Proportion of Sulphur Amino Acids That Can Be Provided by Cystine

An important question in the sulphur amino acid nutrition of animals is the extent to which cystine can meet the methionine + cystine requirements. Because methionine can be converted into cystine but there is no conver-

sion of cystine into methionine, it has been assumed that methionine can fulfil the need for both methionine and cystine but that cystine can only fulfil the cystine need and, therefore, only a portion of the methionine + cystine requirement. This issue has important practical implications because most feedstuffs included in swine diets are higher in cystine than methionine (NRC, 1998). Thus, diets can be relatively high in total sulphur amino acids but low in methionine. In addition, it has been suggested that a high cystine content may increase the methionine requirement (Kirchgessner *et al.*, 1994b). Although the question about the maximum proportion of total sulphur amino acids that can be provided by cystine seems simple at first sight, many issues have confounded estimates during the 50 years that this has been investigated. Some of the issues are methodological such as inappropriate response criteria, underestimation of sulphur amino acid content of diets because of improper analysis, and differences in bioavailability of sulphur amino acids in different feedstuffs (Chung and Baker, 1992b). In addition, however, there are two fundamental issues that can confound interpretation of results. First it is important to clarify whether the replacement of methionine with cystine is on a weight or molar basis. Because the molecular weight of methionine (149) is greater than that of cysteine (121), equal weights of these two amino acids provide only 81% as many moles of methionine as cysteine ( $121/149 = 0.81$ ). Thus, on a weight basis, increasing the methionine:cysteine ratio provides a decreasing number of moles of sulphur amino acids. Almost all estimates of the maximum portion of the methionine + cystine requirement that can be provided by cystine have been expressed on a weight basis and have ignored this issue. The second issue is that the proportion of methionine + cystine that can be provided by cystine is much greater for maintenance than for new tissue accretion. Consequently, the cystine replacement value increases as a pig matures and maintenance becomes a larger proportion of total amino acid need.

An initial estimate of the proportion of methionine + cystine that could be provided by cystine was proposed by Shelton *et al.*

(1951). Based on their experiment, they concluded that the methionine requirement of 20-kg growing pigs was  $6.0 \text{ g kg}^{-1}$  in the absence of cystine and  $3.0 \text{ g kg}^{-1}$  in the presence of adequate or excess cystine ( $6.0 \text{ g kg}^{-1}$  added cystine in their experiment). On the basis of these results, they concluded that 'approximately 50% of the methionine can be replaced with cystine in the diet of the weanling pig'. Although this study made an important initial contribution, both the number of animals and the number of treatments was very limited. There was no titration of either the methionine + cystine requirement or various methionine:cystine ratios.

In later work, Curtin *et al.* (1952a,b) found that the methionine + cystine requirement of 15-kg pigs was approximately  $7 \text{ g kg}^{-1}$  of the diet and that  $3.8 \text{ g kg}^{-1}$  cystine could replace a corresponding amount of methionine, suggesting that cystine could supply  $\geq 50\%$  of the methionine + cystine requirement. Becker *et al.* (1955) reported that the methionine requirement of 10-kg pigs was  $2.5 \text{ g kg}^{-1}$  in the presence of  $1.7 \text{ g kg}^{-1}$  cystine. From this, they concluded that cystine could provide 40% of the methionine + cystine requirement. Again, however, in both of these experiments there was no titration of various methionine:cystine ratios and therefore no direct determination of the maximum proportion of cystine that could be utilized.

During the 1960s, two additional papers were published by the research group at the University of Illinois. Mitchell *et al.* (1968) measured the nitrogen balance of 10-kg pigs. They studied methionine:cystine ratios from 96:4 to 30:70. Although there were no significant differences, there was a tendency for nitrogen balance to increase as cystine replaced methionine. This would be expected because of the increase in the moles of sulphur amino acids added. Based on these results, the authors concluded that 'cystine can replace at least 70% of the methionine need without decreasing nitrogen retention'. Despite this conclusion, there was a 6.5% reduction in nitrogen balance when the proportion of cystine was increased from 57 to 70%. In the following year, the same research group (Baker *et al.*, 1969) reported similar results for the nitrogen balance of 11-kg pigs.

Nitrogen balance tended to increase as the proportion of sulphur amino acids provided by cystine increased from 26 to 66%, although none of the differences were significant. In two growth assays, however, weight gain was reduced when the proportion of cystine was increased from 56 to 66%, leading the authors to conclude that 'regardless of assay procedure, cystine can provide at least 56% of the requirement for total dietary sulphur amino acids'. Differences between the two types of assays were attributed to the fact that feed intake was equalized in the nitrogen balance study, whereas *ad libitum* access to feed was allowed in the growth experiments.

In a comprehensive series of experiments, German researchers have also investigated methionine-cystine relationships. Based on growth experiments with pigs in weight ranges 30–60 kg and 60–90 kg, Roth and Kirchgessner (1987) concluded that the maximum proportion of sulphur amino acids that could be provided by cystine was 55%. The authors cautioned, however, that at higher performance levels the maximum permissible proportion of cystine may be lower than this. In a subsequent paper, Roth and Kirchgessner (1989) tested methionine:cystine ratios from 36:64 to 64:36. Pig performance improved as the methionine:cystine ratio increased from 36:64 to 40:60 to 45:55. There were no further significant increases in performance as ratios were increased to 50:50, 55:45, 60:40, and 64:36. These data support their earlier research, indicating that cystine can provide up to 55% of the methionine + cystine requirement. However, using quadratic regression analysis, the authors found that peak performance was obtained when the methionine:cystine ratio was 55:45, implying that not more than 45% of the methionine + cystine requirement should be furnished by cystine.

Chung and Baker (1992b) used a purified diet (to avoid issues of different bioavailability of amino acids among different feedstuffs) to study methionine:cystine ratios in 10-kg pigs. In two experiments, methionine:cystine ratios from 100:0 to 40:60 were examined. The authors concluded that no more than 50% of the methionine + cystine requirement could be supplied by cystine.

Thus, estimates of the maximum proportion of methionine + cystine that can be provided by cystine range from 40 to 70%, although the majority of estimates are from 45 to 55%. Some of the difference in estimates may relate to the differences in protein accretion and maintenance needs. The whole-body protein content of pigs contains approximately 1.9 g methionine per 100 g protein and 1.2 g cystine per 100 g protein (see review by Mahan and Shields (1998) of nine different studies). This represents a methionine:cystine ratio of 61:39. Fuller *et al.* (1989) calculated that the requirements for accretion of 100 g of body protein by 30- to 50-kg pigs were: methionine 1.9 g and cystine 1.7 g, or a methionine:cystine ratio of 53:47. Thus, both of these estimates suggest that less than 50% of the methionine + cystine requirement should be provided by cystine. On the other hand, the optimal proportions for maintenance are quite different. Fuller *et al.* (1989) estimated that the maintenance requirements in terms of mg kg<sup>-1</sup> body weight<sup>0.75</sup> per day were 9 for methionine and 40 for cystine. This is a methionine:cystine ratio of 18:82. Part of the reason for the large cystine requirement for maintenance is the high cystine content of hair and other keratin tissues (Baker *et al.*, 1966). These differences between protein accretion and maintenance are recognized in the NRC (1998) publication, which estimates methionine:cystine ratios of 49:51 for protein accretion and 23:77 for maintenance. Because of these differences, the overall ratio will shift as a growing pig matures and the maintenance needs become an increasing proportion of the overall nutrient needs.

Therefore, based on the results of several experiments and on more theoretical grounds, it seems that in most situations cystine can supply at least 50% of the methionine + cystine requirements. Although in some cases an even greater proportion could probably be provided by cystine, a good practical 'rule of thumb' remains that when formulating diets for growing pigs, one should ensure that no more than 50% of the sulphur amino acid requirement is furnished by cystine.

### **Can Methionine Satisfy the Total Need for Sulphur Amino Acids?**

Because methionine is readily converted into cystine, it is usually assumed that all of the sulphur amino acid needs can be provided by methionine and there is no need for inclusion of cystine in diets. Although this issue is not important in practical diets because of the relative abundance of cystine, when purified diets are formulated it is an important question. As pointed out by Creek (1968), it takes 1.24 times as much methionine as cystine to contribute the same number of moles of sulphur amino acids because of the difference in molecular weights. Thus, when sulphur amino acids are limiting and cystine replaces methionine on a weight basis, performance would be expected to increase up to the point at which cystine needs are fully met by dietary cystine. Several experiments (Mitchell *et al.*, 1968; Baker *et al.*, 1969; Chung and Baker, 1992b) have provided data that illustrate this effect, although in most cases differences were not statistically significant. The same effects have been reported in studies with chicks. Graber and Baker (1971) found that methionine and cystine were equivalent on a molar basis, but that on a weight basis methionine was only 78–79% as efficacious as cystine. To address the issue of differences in molecular weight, Chung and Baker (1992b) fed 10-kg pigs a series of diets in which cystine replaced methionine on a molar basis rather than a weight basis. Although there were no statistically significant differences in the performance of pigs fed the different diets, pigs fed a 50:50 proportion of methionine and cystine on a molar basis gained weight 8.5% faster than pigs fed a diet in which methionine provided the sole source of sulphur amino acids. Thus, although the data are limited, and cystine is not considered 'essential' in a classical sense, there may be some improvements in pig performance when at least a portion of the sulphur amino acid requirement is provided by cystine.

### Effects of Excess Methionine and Cystine

The negative effects of excess intakes of amino acids have been recognized for many years (see Chapter 7), and methionine is well known as one of the amino acids that causes the greatest growth depressions (Harper *et al.*, 1970). Work with pigs has confirmed observations in other species. Edmonds and Baker (1987) fed 8-kg pigs maize-soybean meal diets with 0, 5, 10, 20 or 40 g kg<sup>-1</sup> excesses of methionine. Additions of 5 or 10 g kg<sup>-1</sup> excess methionine did not affect weight gain, feed intake, or gain:feed ratios. However, additions of 20 or 40 g kg<sup>-1</sup> excess methionine resulted in reductions in feed intake and weight gain but not gain:feed. These results were considered typical of amino acid imbalances. In a comparative toxicity study, Edmonds *et al.* (1987) found that 40 g kg<sup>-1</sup> excess methionine reduced weight gain by 52%. This reduction was much greater than reductions elicited by 40 g kg<sup>-1</sup> excesses of arginine (31%), tryptophan (28%), lysine (16%) and threonine (5%).

In rats, excess cystine causes alterations of lipid metabolism and reductions in feed intake and weight gain (Aoyama *et al.*, 1992). Some of these changes can be prevented by supplementation with methionine or choline.

Whether similar effects occur in swine is unknown. It has been suggested (Kirchgessner *et al.*, 1994b) that a high cystine intake increases the total sulphur amino acid requirement in pigs. However, this may simply be to ensure that the methionine intake is adequate. There is no evidence that excess cystine interferes with methionine in pigs.

### Relationship of Methionine with Other Methyl Donors

In addition to its primary function as a constituent of proteins, methionine can be converted into S-adenosylmethionine and S-adenosylhomocysteine, as illustrated in Fig. 8.3. These reactions release a methyl group that is used in several metabolic processes, primarily DNA methylation and synthesis of carnitine from lysine, adrenaline from noradrenaline, and creatine from guanidine acetate (Simon, 1999). Thus, methionine is sometimes referred to as a 'methyl donor'. To regenerate methionine from homocysteine, a methyl group must be transferred back via either the tetrahydrofolate pathway (involving folates and vitamin B<sub>12</sub>) or the betaine pathway (Fig. 8.6). Betaine can be produced from choline by an irreversible two-step oxidation reaction that occurs in liver and kidney.

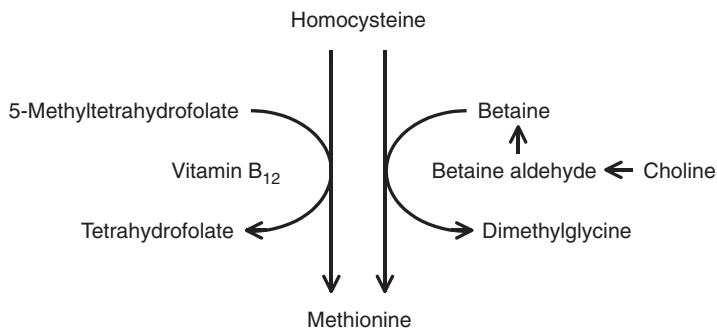


Fig. 8.6. Two metabolic pathways for the conversion of homocysteine into methionine.

The notion that some of the methionine requirement could be spared or reduced by increasing the intake of choline or betaine has attracted attention for several years. The idea is appealing because replacement of DL-methionine or protein sources with betaine, which is commercially available to the feed industry (Danisco, 2001), could reduce diet costs. Unfortunately, experiments with pigs have not been encouraging. Simon (1999) reviewed ten papers and abstracts, published between 1990 and 1998, in which betaine was supplemented in pig diets. The conclusions reached in this review were that 'in none of these studies did supplementation with betaine (1.0–1.25 g kg<sup>-1</sup>) exert any consistent and significant effect on growth or carcass traits' and 'under normal conditions, carcass traits cannot be improved in pigs by adding extra betaine or choline to the diets during the finishing period'. Since the review by Simon (1999) several additional papers (Emmert *et al.*, 1998; Matthews *et al.*, 1998, 2001a,b,c; Øverland *et al.*, 1999) and abstracts (Casarin *et al.*, 1997; Hall *et al.*, 1997; Cromwell *et al.*, 1999, 2000; Kitt *et al.*, 1999, 2000; Pettey *et al.*, 2001; Schrama *et al.*, 2001) have reported experiments in which the effects of betaine have been evaluated in terms of growth, carcass traits, and pork quality measures. Although positive effects have been observed in some experiments, results have been variable and inconsistent. Furthermore, few of the experiments have been designed to measure directly whether betaine can substitute for a portion of the methionine requirement. Kitt *et al.* (2000) attempted to do this, but were unable to demonstrate a response to added methionine and therefore unable to evaluate the effect of betaine. The paper by Matthews *et al.* (2001c) seems to be the only report in which a direct comparison of the replacement value of betaine for methionine is possible. In a diet that was shown to be limiting in methionine, supplemental betaine did increase weight gain. However, the response was due to an increase in feed intake and

therefore sulphur amino acid intake. The authors concluded that betaine did not spare methionine in their experiment. Thus, although supplementation of pig diets with betaine has been shown to be beneficial in some situations, the effects are probably not due to methionine sparing, but are more likely due to other factors such as effects on osmoregulation or energy metabolism. Normal pig diets that are adequately supplemented with choline should contain adequate amounts of methyl donors.

## Conclusions

Sulphur amino acids are important in pig nutrition because they can be the limiting nutrient, especially when crystalline amino acids such as lysine, tryptophan, and threonine are supplemented. Methionine supplements for the feed industry are available as DL-methionine and 2-hydroxy-4-(methylthiol)butyric acid, commonly known as methionine hydroxy analogue, and both are nutritionally equivalent to L-methionine. Requirements for sulphur amino acids are difficult to determine because of analytical difficulties and differences in bioavailability among feedstuffs. However, the requirements listed by the NRC (1998) are satisfactory for most purposes. A portion of the sulphur amino acid requirement can be provided by cystine. Although the actual amount will depend on a number of factors, the recommendation that not more than 50% (on a weight basis) of the methionine + cystine requirement should be provided by cystine is a good guideline for practical diet formulation. In theory, all of the sulphur amino acid needs can be provided by methionine, but it seems that there may be some advantage to including at least some cystine in diets. All diets based on cereal grains will normally contain plenty of cystine. Attempts to replace part of the methionine requirement with other methyl donors have not proved promising.

## References

- Aoyama, Y., Ishikawa, T., Amano, N. and Yoshida, A. (1992) Lipid accumulation in the liver of rats fed a soy protein isolate diet with excess cystine, and its prevention by methionine or choline. *Bioscience, Biotechnology, and Biochemistry* 56, 656–659.
- Baker, D.H. (1994) Utilization of precursors for L-amino acids. In: D'Mello, J.P.F. (ed.) *Amino Acids in Farm Animal Nutrition*. CAB International, Wallingford, UK, pp. 37–61.
- Baker, D.H., Becker, D.E., Norton, H.W., Jensen, A.H. and Harmon, B.G. (1966) Quantitative evaluation of the tryptophan, methionine and lysine needs of adult swine for maintenance. *Journal of Nutrition* 89, 441–447.
- Baker, D.H., Clausing, W.W., Harmon, B.G., Jensen, A.H. and Becker, D.E. (1969) Replacement value of cystine for methionine for the young pig. *Journal of Animal Science* 29, 581–584.
- Batterham, E.S., Andersen, L.M. and Baigent, D.R. (1993) Utilization of ileal digestible amino acids by growing pigs: methionine. *British Journal of Nutrition* 70, 711–720.
- Becker, D.E., Jensen, A.H., Terrill, S.W. and Norton, H.W. (1955) The methionine-cystine need of the young pig. *Journal of Animal Science* 14, 1086–1094.
- Bell, J.M., Williams, H.H., Loosli, J.K. and Maynard, L.A. (1950) The effect of methionine supplementation of a soybean oil meal-purified ration for growing pigs. *Journal of Nutrition* 40, 551–561.
- Casarin, A., Forat, M. and Zabarar-Krick, B.J. (1997) Interrelationships between betaine (Betafin-BCR) and level of feed intake on the performance parameters and carcass characteristics of growing-finishing pigs. *Journal of Animal Science* 75 (Suppl. 1), 75 (Abstract).
- Chung, T.K. and Baker, D.H. (1992a) Utilization of methionine isomers and analogs by the pig. *Canadian Journal of Animal Science* 72, 185–188.
- Chung, T.K. and Baker, D.H. (1992b) Maximal portion of the young pig's sulfur amino acid requirement that can be furnished by cystine. *Journal of Animal Science* 70, 1182–1187.
- Creek, R.D. (1968) Non equivalence in mass in the conversion of phenylalanine to tyrosine and methionine to cystine. *Poultry Science* 47, 1385–1386.
- Cromwell, G.L., Lindemann, M.D., Randolph, J.R., Monegue, H.J., Laurent, K.M. and Parker, G.R. (1999) Efficacy of betaine as a carcass modifier in finishing pigs fed normal and reduced energy diets. *Journal of Animal Science* 77 (Suppl. 1), 179 (Abstract).
- Cromwell, G.L., Lindemann, M.D., Randolph, J.R., Laurent, K.M., Parker, G.R. and Coffey, R.D. (2000) Effects of betaine levels in reduced energy diets for finishing pigs. *Journal of Animal Science* 78 (Suppl. 1), 189 (Abstract).
- Curtin, L.V., Loosli, J.K., Abraham, J., Williams, H.H. and Maynard, L.A. (1952a) The methionine requirement for the growth of swine. *Journal of Nutrition* 48, 499–508.
- Curtin, L.V., Loosli, J.K., Willman, J.P. and Williams, H.H. (1952b) Methionine as a supplement to soybean oil meal for weanling pigs. *Journal of Animal Science* 11, 459–464.
- Danisco (2001) Betaine. Available at: [www.ingredients.danisco.com/products](http://www.ingredients.danisco.com/products). Accessed 29 November 2001.
- Degussa (2001) Degussa feed additives. Available at: [www.aminoacidsandmore.com](http://www.aminoacidsandmore.com). Accessed 13 November 2001.
- DeWolfe, M.S., Baskurt, S. and Cochrane, W.A. (1967) Automatic amino acid analysis of blood serum and plasma. *Clinical Biochemistry* 1, 75–81.
- Edmonds, M.S. and Baker, D.H. (1987) Amino acid excesses for young pigs: effects of excess methionine, tryptophan, threonine or leucine. *Journal of Animal Science* 64, 1664–1671.
- Edmonds, M.S., Gonyou, H.W. and Baker, D.H. (1987) Effect of excess levels of methionine, tryptophan, arginine, lysine or threonine on growth and dietary choice in the pig. *Journal of Animal Science* 65, 179–185.
- Emmert, J.L., Webel, D.M., Biehl, R.R., Griffiths, M.A., Garrow, L.S., Garrow, T.A. and Baker, D.H. (1998) Hepatic and renal betaine-homocysteine methyltransferase activity in pigs as affected by dietary intakes of sulphur amino acids, choline, and betaine. *Journal of Animal Science* 76, 606–610.
- Fuller, M.F., McWilliam, R., Wang, T.C. and Giles, L.R. (1989) The optimum dietary amino acid pattern for growing pigs. 2. Requirements for maintenance and for tissue protein accretion. *British Journal of Nutrition* 62, 255–267.

- Graber, G. and Baker, D.H. (1971) Sulfur amino acid nutrition of the growing chick: quantitative aspects concerning the efficacy of dietary methionine, cysteine and cystine. *Journal of Animal Science* 33, 1005–1011.
- Grunau, J.A. and Swiader, J.M. (1992) Chromatography of 99 amino acids and other ninhydrin-reactive compounds in the Pickering lithium gradient system. *Journal of Chromatography* 594, 165–171.
- Hall, D.D., Orr, D.E., Wilson, M.E., Moser, R.L. and Whittington, K.A. (1997) Effect of betaine in finishing pig diets. *Journal of Animal Science* 75 (Suppl. 1), 75 (Abstract).
- Harper, A.E., Benevenga, N.J. and Wohlheuter, R.M. (1970) Effects of ingestion of disproportionate amounts of amino acids. *Physiological Reviews* 50, 428–558.
- Kim, K.-I. and Bayley, H.S. (1983) Amino acid oxidation by young pigs receiving diets with varying levels of sulphur amino acids. *British Journal of Nutrition* 50, 383–390.
- Kirchgessner, M., Roth, F.X., Stangl, G.I. and Koch, F. (1994a) Effect of different lysine levels on the methionine and cystine requirements of piglets. *Journal of Animal Physiology and Animal Nutrition* 72, 123–131.
- Kirchgessner, M., Roth, F.X., Stangl, G.I. and Koch, F. (1994b) Effect of methionine supply at high and low dietary methionine to cystine ratios on the performance of growing pigs. *Journal of Animal Physiology and Animal Nutrition* 72, 14–25.
- Kitt, S.J., Miller, P.S., Lewis, A.J. and Chen, H.-Y. (1999) Effects of betaine and space allocation on growth performance, plasma urea concentration, and carcass characteristics of growing and finishing barrows. *Journal of Animal Science* 77 (Suppl. 1), 53 (Abstract).
- Kitt, S.J., Miller, P.S., Lewis, A.J. and Fischer, R.L. (2000) Effects of dietary betaine and methionine on growth performance, carcass characteristics, and plasma metabolites of finishing barrows. *Journal of Animal Science* 78 (Suppl. 2), 64 (Abstract).
- Knight, C.D., Atwell, C.A., Wuelling, C.W., Ivey, F.J. and Dibner, J.J. (1998) The relative effectiveness of 2-hydroxy-4-(methylthio) butanoic acid and DL-methionine in young swine. *Journal of Animal Science* 76, 781–787.
- Knowles, T.A., Southern, L.L. and Bidner, T.D. (1998) Ratio of total sulfur amino acids to lysine for finishing pigs. *Journal of Animal Science* 76, 1081–1090.
- Lewis, A.J. (2001) Amino acids in swine nutrition. In: Lewis, A.J. and Southern, L.L. (eds) *Swine Nutrition*, 2nd edn. CRC Press, Boca Raton, Florida, pp. 131–150.
- Lewis, A.J. and Baker, D.H. (1995) Bioavailability of D-amino acids and DL-hydroxymethionine. In: Ammerman, C.B., Baker, D.H. and Lewis, A.J. (eds) *Bioavailability of Nutrients for Animals*. Academic Press, New York, pp. 67–81.
- Loughmiller, J.A., Nelssen, J.L., Goodband, R.D., Tokach, M.D., Titgemeyer, E.C. and Kim, I.H. (1998) Influence of dietary total sulfur amino acids and methionine on growth performance and carcass characteristics of finishing gilts. *Journal of Animal Science* 76, 2129–2137.
- Mahan, D.C. and Shields, R.G. Jr. (1998) Essential and nonessential amino acid composition of pigs from birth to 145 kilograms of body weight, and comparison to other studies. *Journal of Animal Science* 76, 513–521.
- Matthews, J.O., Southern, L.L., Pontif, J.E., Higbie, A.D. and Bidner, T.D. (1998) Interactive effects of betaine, crude protein, and net energy in finishing pigs. *Journal of Animal Science* 76, 2444–2455.
- Matthews, J.O., Southern, L.L., Higbie, A.D., Persica, M.A. and Bidner, T.D. (2001a) Effects of betaine on growth, carcass characteristics, pork quality, and plasma metabolites of finishing pigs. *Journal of Animal Science* 79, 722–728.
- Matthews, J.O., Southern, L.L., Bidner, T.D. and Persica, M.A. (2001b) Effects of betaine, pen space, and slaughter handling method on growth performance, carcass traits, and pork quality of finishing barrows. *Journal of Animal Science* 79, 967–974.
- Matthews, J.O., Southern, L.L. and Bidner, T.D. (2001c) Estimation of the total sulfur amino acid requirement and the effect of betaine in diets deficient in total sulfur amino acids for the weanling pig. *Journal of Animal Science* 79, 1557–1565.
- Mitchell, J.R., Jr, Becker, D.E., Harmon, B.G., Norton, H.W. and Jensen, A.H. (1968) Some amino acid needs of the young pig fed a semisynthetic diet. *Journal of Animal Science* 27, 1322–1326.
- Mondino, A., Bongiovanni, G. and Fumero, S. (1972) Effect of the pH of the test solution on amino acid ion-exchange chromatography in a lithium cycle. *Journal of Chromatography* 71, 363–366.
- Moore, S. (1963) On the determination of cystine as cysteic acid. *Journal of Biological Chemistry* 238, 235–237.
- Novus International (2001) Alimet® feed supplement. Available at: [www.novusint.com/Public/Products/Alimet.asp](http://www.novusint.com/Public/Products/Alimet.asp). Accessed 13 November 2001.

- NRC (National Research Council) (1998) *Nutrient Requirements of Swine*, 10th edn. National Academy Press, Washington, DC, 189 pp.
- Øverland, M., Rørvik, K.-A. and Skrede, A. (1999) Effect of trimethylamine oxide and betaine in swine diets on growth performance, carcass characteristics, nutrient digestibility, and sensory quality of pork. *Journal of Animal Science* 77, 2143–2153.
- Pack, M. and Höhler, D. (2000) Letter to the editor. *Animal Feed Science and Technology* 88, 129–131.
- Petty, L.A., Cromwell, G.L., Lindemann, M.D., Randolph, J.H., Monegue, H.J., Laurent, K.M., Parker, G.R. and Coffey, R.D. (2001) Efficacy of betaine as a carcass modifier in finishing pigs fed normal and low protein diets supplemented with amino acids. *Journal of Animal Science* 79 (Suppl. 1), 183 (Abstract).
- Pickering, M.V. (1989) Ion-exchange chromatography of free amino acids. *LC•GC* 7, 484–490.
- Reifsnyder, D.H., Young, C.T. and Jones, E.E. (1984) The use of low protein liquid diets to determine the methionine requirement and the efficacy of methionine hydroxy analogue for the three-week-old pig. *Journal of Nutrition* 114, 1705–1715.
- Römer, A. and Abel, H. (1999) Effects of DL-methionine hydroxyanalogue (MHA) or DL-methionine (DL-Met) on N-retention in broiler chickens and pigs. *Animal Feed Science and Technology* 81, 193–203.
- Roth, F.X. and Kirchgessner, M. (1986) Relative biological efficiency of methionine hydroxy analogue-free acid for growing pigs. *Journal of Animal Physiology and Animal Nutrition* 55, 93–100.
- Roth, F.X. and Kirchgessner, M. (1987) Biological efficiency of dietary methionine or cystine supplementation with growing pigs – a contribution to the requirement for S-containing amino acids. *Journal of Animal Physiology and Animal Nutrition* 58, 267–280.
- Roth, F.X. and Kirchgessner, M. (1989) Influence of the methionine:cystine relationship in the feed on the performance of pigs. *Journal of Animal Physiology and Animal Nutrition* 61, 265–274.
- Schram, E., Moore, S. and Bigwood, E.J. (1954) Chromatographic determination of cystine as cysteic acid. *Biochemical Journal* 57, 33–37.
- Schrama, J.W., Simmins, P.H. and Gerrits, W.J.J. (2001) Effect of dietary betaine supplementation on energy partitioning in pigs. *Journal of Animal Science* 79 (Suppl. 1), 184 (Abstract).
- Shelton, D.C., Beeson, W.M. and Mertz, E.T. (1951) The effect of methionine and cystine on the growth of weanling pigs. *Journal of Animal Science* 10, 57–64.
- Simon, J. (1999) Choline, betaine and methionine interactions in chickens, pigs and fish (including crustaceans). *World's Poultry Science Journal* 55, 353–374.
- Stein, W.H. and Moore, S. (1954) The free amino acids of human blood plasma. *Journal of Biological Chemistry* 211, 915–926.
- Steinhart, H. and Kirchgessner, M. (1985) Biological efficiency of DL-methionine-Na and DL-2-hydroxy-4-methylmercaptobutyric acid in piglets. *Zeitschrift für Tierphysiologie, Tierernährung und Futtermittelkunde* 53, 104–110.
- Stockland, W.L., Asche, G.L., Robey, W.W. and Pierson, E.E. (1992) Methionine hydroxy analogue-calcium effective for growing pigs. *Feedstuffs* 64(2), 11–12.
- Urbańczyk, J., Ryś, R., Hanczakowska, E., Kościńska, A. and Morstin, E. (1981) The use of Ca-methionine hydroxyanalogue as substitute for DL-methionine in pig feeding. *Acta Agraria et Silvestria, Series Zootechnica* 20, 241–250.
- Williams, A.P. (1994) Recent developments in amino acid analysis. In: D'Mello, J.P.F. (ed.) *Amino Acids in Farm Animal Nutrition*. CAB International, Wallingford, UK, pp. 11–36.





# 9 Ideal Dietary Amino Acid Profiles for Pigs

**S. Boisen\***

*Department of Animal Nutrition and Physiology, Research Centre Foulum, Tjele, Denmark*

---

## Introduction

The optimal dietary supply of amino acids to farm animals has been intensively studied for many years. Most studies have focused on the establishment of the requirement for one single amino acid, in particular, for one of those essential amino acids that are most commonly limiting in practical diets (for references see NRC, 1988, 1998).

Lysine is generally the first-limiting amino acid in practical cereal-based pig diets and has also been the most investigated. Thus, in a survey of studies on lysine requirements published in international journals from 1985 to 1995, NRC (1998) refer to estimations of lysine requirement for piglets up to about 20 kg live weight from 18 publications, for growing pigs in the live-weight range 20–50 kg from 23 publications, and for finishing pigs in live-weight range 50–100 kg from 26 publications.

Nevertheless, a general agreement on the amino acid requirements for pigs has not yet been established. The major reason for this is probably a number of different factors that may influence the actual requirement of each individual amino acid and, consequently, the results obtained in the specific study. Obviously, if these factors are not understood or properly considered the obtained results will not have general validity.

Among these factors, the dietary supply of the other amino acids, in particular all the essential amino acids, is of significant importance. In fact, the requirement for one specific amino acid can only be established if the dietary supply of all other essential amino acids, as well as crude protein, is adequate, i.e. is not limiting responses of variable supply of the investigated amino acid in the actual study.

It follows that when the requirement for one single amino acid is determined all other essential amino acids need to be considered. Consequently, some knowledge of the ideal profile of all essential amino acids other than the one investigated is necessary in order to secure proper experimental diets.

The concept of ideal protein and proposals for its composition were introduced more than 20 years ago (ARC, 1981). The continuous research on amino acid requirements has led to several proposals for modified ideal proteins for growing pigs as reviewed by, for example, Cole and Van Lunen (1994) and Boisen (1997). Furthermore, the officially recommended dietary amino acid profile used in different countries is still relatively variable.

The aims of this chapter are: (i) to discuss the expression and establishment of the ideal dietary amino acid profile for pigs; (ii) to demonstrate how this profile can be utilized for characterizing the protein quality in feeds,

\*E-mail address: Sigurd.Boisen@agrsci.dk

and finally (iii) to discuss how experimental conditions may be optimized and standardized for obtaining a generally agreed ideal dietary amino acid profile for pigs. Because the ideal protein for sows is discussed in Chapter 12, the present chapter will focus on growing pigs from weaning to slaughter.

### Expression of the Ideal Dietary Amino Acid Profile

#### Essential and non-essential amino acids

The twenty amino acids commonly occurring in proteins are given in Fig. 9.1. Together with the different properties (chemically reactive groups), by which the different amino acids can be characterized, Fig. 9.1 also illustrates the non-essential amino acids that can be synthesized by simple transamination, or in some cases more complex reactions, of metabolites from the oxidation products of glucose or, as for arginine, from the urea cycle in mammals.

In piglets, the synthesis rate of arginine,

and probably also of proline that include several synthetic steps, may not be sufficiently high to fully satisfy the requirements for these amino acids during the first rapid growth phase (Fuller, 1994). On the other hand, the dietary supply of these two amino acids appear always to be in surplus in relevant practical diets for piglets. Therefore, this possible insufficiency will not be considered as a matter of practical relevance.

Figure 9.1 also illustrates that the two amino acids, cysteine and tyrosine can be synthesized from the essential amino acids, methionine and phenylalanine, respectively. Thus, an undersupply of cysteine and tyrosine can be compensated by an oversupply of methionine and phenylalanine, respectively. On the other hand, cysteine and tyrosine cannot compensate for undersupply of methionine and phenylalanine, respectively. Consequently, a complete composition of ideal protein for pigs includes also the sum of sulphur amino acids (methionine + cysteine) and aromatic amino acids (phenylalanine + tyrosine) together with methionine and phenylalanine, respectively.

In the ideal amino acid profile suggested by

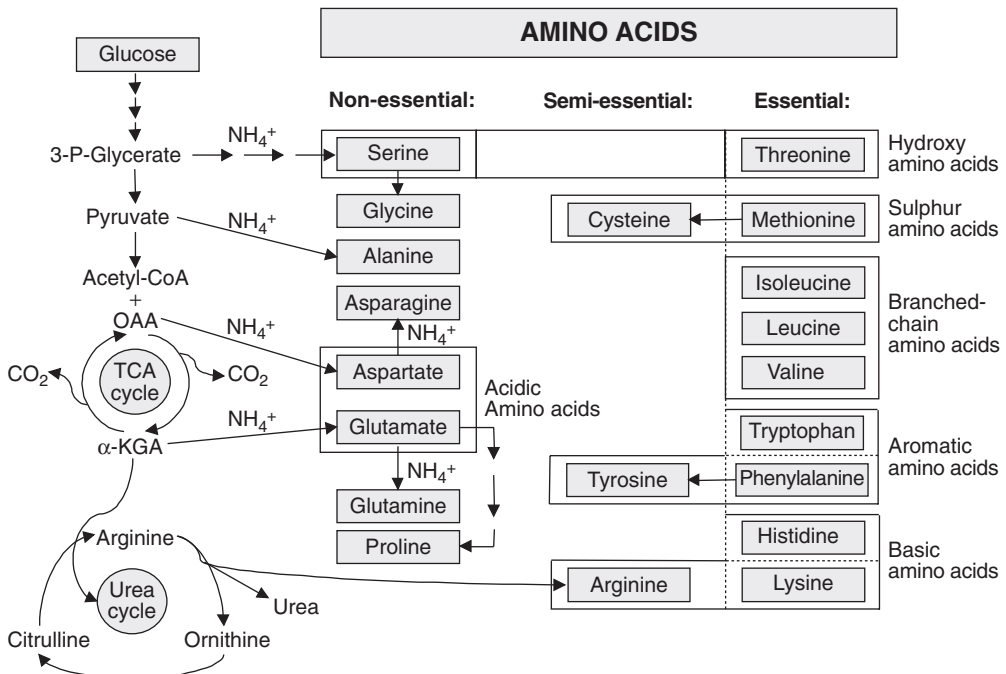


Fig. 9.1. Essential amino acids and synthesis routes of semi-essential and non-essential amino acids.

the ARC (1981) lysine was used as reference for the other amino acids. Tryptophan has also been suggested as a reference for the other essential amino acids (NRC, 1988). However, it is now generally accepted that lysine is most suitable (ARC, 1991; NRC, 1998). Some very good reasons for using lysine as reference are: (i) lysine is commonly the first limiting amino acid in practical diets, (ii) lysine is the most investigated amino acid with respect to requirement; (iii) the requirement for lysine is, together with leucine, higher than the other amino acids; and (iv) lysine does not contribute quantitatively to other specific functions than protein synthesis.

### Order of essential amino acids according to their degree of limitation

The order of essential amino acids describing the ideal amino acid profile in relation to their general order of limitation in common cereal-based diets is given together with their specific properties in Table 9.1. Furthermore, the essential amino acids can be separated into two groups according to their general degree of limitation.

**1.** A primary limiting group which includes lysine, threonine, methionine (and sulphur amino acids) and tryptophan. The requirements for these amino acids can generally be met after supplementation of industrial products of lysine, threonine, methionine and tryp-

tophan. These amino acids are generally used for improving the protein quality in the diets in practical pig feed production.

**2.** A secondary limiting group which includes: (i) isoleucine, leucine and valine (all branched-chain amino acids); (ii) histidine, and (iii) phenylalanine (and aromatic amino acids). Each of these amino acids can become limiting when the diets are supplemented with amino acids from the primary limiting group. However, at present the amino acids from the secondary limiting group are not commercially available at reasonable prices. Furthermore, due to the present insufficient knowledge on their precise requirements the benefit for a further reduction in the dietary protein level by their supplementation is difficult to assess.

### Definition of the ideal dietary amino acid profile

The first proposals for ideal amino acid profiles referred directly to the concentration of amino acids in the diet. However, due to variations in the availability of the individual amino acids in dietary proteins the profile should rather be related to the available amino acids in the diet. Generally, the ileal digestibility is considered to be the most correct measure for availability, although the availability of some amino acids, e.g. lysine, may be overestimated by this method, in particular in heat treated feedstuffs (Batterham, 1994, Moughan and Rutherford, 1996).

**Table 9.1.** Essential amino acids according to their general order of limitation in common practical diets for growing pigs.

Essential amino acid	Chemical property	Order of limitation
Lysine	Basic amino acid	Primary
Threonine	Hydroxy amino acid	
Methionine	Sulphur amino acid	
Methionine + cystine	Sulphur amino acid	
Tryptophan	Indole amino acid	
Isoleucine	Branched-chain amino acid	Secondary
Leucine	Branched-chain amino acid	
Valine	Branched-chain amino acid	
Histidine	Imidazole amino acid	
Phenylalanine	Aromatic amino acid	
Phenylalanine + tyrosine	Aromatic amino acid	

Several tables of apparent ileal digestibility of amino acids were published about 10 years ago and ideal amino acid profiles have been suggested on this basis. However, as discussed by, for example, Boisen and Moughan (1996a,b) and Mosenthin *et al.* (2000) values of apparent digestibility are influenced by the total, i.e. basal plus extra feed specific, endogenous protein losses during the digestion processes and, therefore, are influenced by the protein level in the experimental diets used for their determination. On the other hand, values of standardized (or true) digestibility only include the feed-specific losses which are correctly debited on the feedstuff itself. Therefore, for obtaining maximal accuracy (and general validity) in the ideal dietary amino acid profile, it should be related to values of standardized digestibility of the individual amino acids.

It is now generally accepted that values of standardized ileal digestibility of amino acids are those to be used in practical feed evaluation. Recently, several tables on true or standardized ileal digestibility of amino acids in common feedstuffs for pigs have been published (NRC, 1998; Rademacher *et al.*, 1999; CVB, 1999; AmiPig, 2000; Pedersen and Boisen, 2002).

Furthermore, in order to optimize efficiency, and also to reduce surplus-N, the optimal ratio between essential amino acids (EAA) and non-essential amino acids (NEAA) has been defined (Wang and Fuller, 1989; see also Chapter 6). On the other hand, experimentally determined EAA/NEAA ratios are influenced by the composition of the NEAA in the experimental diets, as well as of other available N-compounds, e.g. nucleic acids. Therefore, a more precise characterization would be the ratio obtained from the amounts of standardized digestible EAA-N and total-N, respectively.

Alternatively, the ideal profile of essential amino acids can be directly expressed in relation to crude protein ( $\text{g kg}^{-1}$  CP or  $\text{g 160 g}^{-1}$  N). This results in a simple and more informative definition of the dietary ideal amino acid profile. Furthermore, from these values the theoretical biological value (BV) of the diet, as well as the single protein sources, can be directly calculated as discussed later.

In conclusion, the ideal dietary amino acid profile refers to the optimal composition of the available amounts, i.e. ileal standardized digestible, of all the essential amino acids and N in the diet. Then, the dietary supply of all individual essential amino acids, as well as of N, should be equally limiting for covering the actual requirements for a certain production.

### **Establishment of the Ideal Dietary Amino Acid Profile for Pigs**

Basically, it would be expected that sow's milk, which can be considered to be optimized for suckling piglets during evolution, would also provide the weaned piglets with an ideal amino acid profile. This assumption is supported by the fact that the profile is very constant in sow's milk and apparently not influenced by the dietary composition (Boisen, 1997).

Furthermore, this composition is very close to the amino acid composition in the body as well as in the deposited protein during growth (Table 9.2). Because the composition of deposited protein, during growth up to 100 kg live weight is relatively constant and, furthermore, the requirements for protein deposition account for a dominating portion of the total amino acid requirements, it would also be expected that the ideal dietary amino acid profile is relatively constant during this period. The residual amino acid requirements are related to maintenance requirement, which appear to be dominated by the ileal endogenous protein loss during the digestion processes (Fuller, 1991, 1994; Boisen and Moughan, 1996a). Compared with sow's milk ileal endogenous protein losses are low in most essential amino acids except threonine, cystine and tryptophan (Table 9.2). The concentration of cystine is furthermore very high in hair (Table 9.2) which is lost continuously during growth. Tryptophan and tyrosine are precursors for important hormones, i.e. serotonin, tyroxine and adrenaline. After weaning, the requirements for these amino acids may increase due to extra losses of endogenous protein when dietary fibre and antinutritional factors in the feed are increased and a generally increased hormone production. On the other hand, the higher concentration of histidine in deposited protein than in sow's milk

**Table 9.2.** Amino acid composition (g 160 g<sup>-1</sup> N) of sow's milk compared with the composition in whole body and deposited protein during growth, ileal endogenous protein loss and hair, respectively.

Essential and semi-essential amino acids	Sow's milk <sup>a</sup>	Whole body <sup>b</sup>	Deposited <sup>c</sup>	Endogenous protein <sup>d</sup>	Hair <sup>e</sup>
Lysine	71	66	69	30	33
Threonine	39	39	38	45	59
Methionine	18	19	19	10	4
Cystine	13	11	10	16	134
Tryptophan	12	8	n.d. <sup>e</sup>	12	n.d.
Isoleucine	41	35	40	25	35
Leucine	81	72	77	40	77
Valine	54	48	51	35	60
Histidine	25	29	32	15	11
Phenylalanine	39	39	37	30	23
Tyrosine	42	27	28	20	9

<sup>a</sup>Mean of 32 samples (Boisen, 1997).

<sup>b</sup>Determined at 20 kg live weight (Fuller, 1994).

<sup>c</sup>From 20 to 90 kg live weight (Jørgensen *et al.*, 1988).

<sup>d</sup>Mean of 36 determinations (Boisen and Moughan, 1996a).

<sup>e</sup>n.d., not determined.

may be explained by its ability to be stored in carnosine when there is a dietary surplus (Fuller *et al.*, 1989).

The amino acid profile (relative to lysine) of sow's milk is compared with proposals for ideal protein from the literature in Table 9.3. Characteristically, amino acids in the primary limiting group are generally represented at a higher ratio, whereas those in the secondary limiting group are often represented at a lower ratio in the proposals than found in sow's milk. As described in the introduction, all amino acids in the first limiting group have been intensively studied. Nevertheless, there is still some disagreement about the relative requirements for these amino acids, in particular for the sulphur amino acids, which vary by up to 30% between the different proposals.

The amino acids in the secondary limiting group are much less investigated. However, there is no obvious reason for a lower ratio of these amino acids in the ideal profile than found in sow's milk.

It is generally believed that, due to the increasing contribution of maintenance requirements of protein, which is relatively

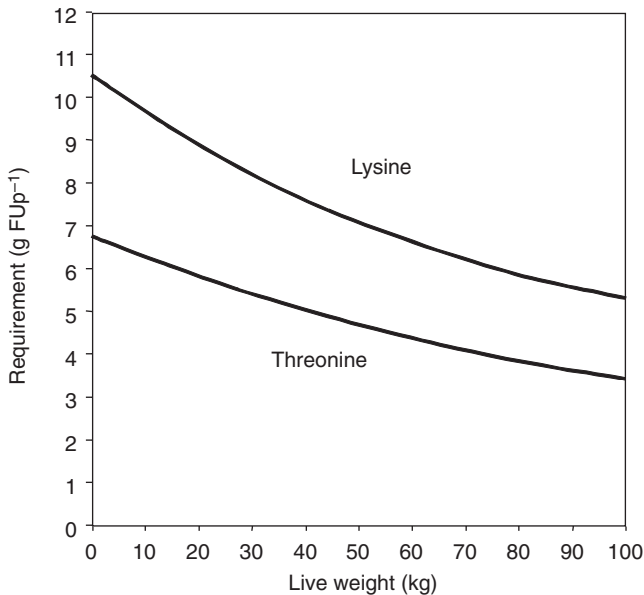
high in threonine, sulphur amino acids and tryptophan, the ideal dietary amino acid profile changes during growth (e.g. Rademacher *et al.*, 1999). However, for fast-growing pigs this may be of little practical importance before 100 kg live weight (Boisen, 1997). A major portion of the extra maintenance amino acid requirements may derive from the feed-specific extra endogenous ileal protein losses which is compensated for when using values of standardized ileal digestible amino acids as discussed above. Thus, the optimal threonine:lysine ratio was not found to increase significantly up to 100 kg live weight in a recent study (Pedersen *et al.*, 2003). On the other hand, the requirements of amino acids relative to energy appear to be generally reduced with almost 50% from the extrapolated value at zero to 100 kg live weight (for lysine and threonine from 10.5 and 6.8, respectively to 5.25 and 3.4, respectively) as shown in Fig. 9.2.

In conclusion, sow's milk can be considered as a valuable guide for establishment of ideal dietary amino acid profile for growing pigs after weaning and until slaughter at 100 kg live weight in fast growing pigs.

**Table 9.3.** Proposals for ideal dietary amino acid profile (relative to lysine) for growing pigs compared with the profile of sow's milk.

	A <sup>a</sup>	B	C	D	E	F	G
Primary limiting amino acids							
Lysine	100	100	100	100	100	100	100
Threonine	55	60	75	65	66	60	64
Methionine	25	26	27	31	–	–	26
Met + Cys	44	50	59	60	50	55	52
Tryptophan	17	15	19	18	18	18	17
Secondary limiting amino acids							
Isoleucine	58	55	61	60	50	54	57
Leucine	114	100	110	100	100	102	114
Valine	76	70	75	68	70	68	74
Histidine	35	33	32	32	33	32	35
Phenylalanine	55	49	59	51	–	–	57
Phe + Tyr	114	96	122	95	100	93	114
Arginine	62	–	–	42	–	48	–

<sup>a</sup>A: Sow's milk (Table 9.2); B: ARC (1981); C: Fuller *et al.* (1989); D: Chung and Baker (1992); E: Cole and van Lunen (1994); F: NRC (1998); G: Boisen *et al.* (2000).

**Fig. 9.2.** Requirements for lysine and threonine (g per FUp (feed units for pigs)) relative to dietary energy of fast growing pigs until 100 kg live weight.

### Ideal Dietary Amino Acid Profile and Biological Value of Dietary Protein Sources

The biological value (BV) of dietary protein is only related to the first limiting amino acid and can be determined experimentally in N-

balance studies in which N-intake and N-excretion with faeces and urine, respectively, are determined. This information is often relevant for complete diets, whereas for single protein sources traditional BV is of less use for feed evaluation and diet formulation.

Table 9.4 shows different proposals for the ideal profile of dietary amino acids in relation to crude protein. When using this profile (from column G in Table 9.4) relative to the composition of available amino acids in single protein sources a detailed characterization of protein quality is obtained. Table 9.5 describes the protein quality of two single feedstuffs and a simple diet, based only on those two protein sources.

**Table 9.4.** Proposals for amino acid composition (g 160 g<sup>-1</sup> N) of ideal protein for growing pigs.

	A <sup>a</sup>	B	C	D	E	F	G
Primary limiting amino acids							
Lysine	70	65	59	81	(70) <sup>b</sup>	(70) <sup>b</sup>	70
Threonine	42	47	44	53	46	42	45
Methionine	18	–	16	25	–	–	18
Met + Cys	35	41	35	49	35	39	36
Tryptophan	10	12	11	15	13	13	12
Secondary limiting amino acids							
Isoleucine	38	39	36	49	35	38	40
Leucine	70	72	65	81	70	71	80
Valine	49	49	44	55	49	48	52
Histidine	23	–	–	26	23	22	25
Phenylalanine	34	–	35	41	–	–	40
Phe + Tyr	67	78	72	77	70	65	80

<sup>a</sup>A: ARC (1981); B: Wang and Fuller (1989); C: Fuller *et al.* (1989); D: calculated from Chung and Baker (1992); E: Cole and van Lunen (1994); F: NRC (1998); G: Boisen *et al.* (2000).

<sup>b</sup>Calculated from Table 9.2 assuming lysine is 70 g 160 g<sup>-1</sup> N.

**Table 9.5.** Protein quality of protein sources and diets in relation to the ideal dietary amino acid pattern.

	Barley		Soybean meal		Digestible (g kg <sup>-1</sup> )			AA pattern <sup>d</sup>		
	Total <sup>a</sup>	SD (%) <sup>b</sup>	Total <sup>1</sup>	SD (%) <sup>b</sup>	Barley	SBM	Diet <sup>c</sup>	Barley	SBM	Diet
Primary limiting amino acids										
Lysine	3.8	75	28.6	92	2.9	26.3	5.1	48	92	64
Threonine	3.6	75	18.2	88	2.7	16.0	3.9	71	88	78
Methionine	1.8	84	6.6	93	1.5	6.1	1.9	99	83	94
Cystine	2.4	84	6.9	89	2.0	6.1	2.3	–	–	–
Met + Cys	–	–	–	–	3.5	12.2	4.2	116	83	105
Tryptophan	1.2	79	5.9	92	1.0	5.4	1.4	94	111	100
Secondary limiting amino acids										
Isoleucine	3.7	81	20.8	91	3.0	18.9	4.4	89	116	99
Leucine	7.3	83	35.7	90	6.1	32.1	8.4	90	99	93
Valine	5.2	80	21.6	90	4.2	19.4	5.5	95	92	94
Histidine	2.4	81	12.5	92	1.9	11.5	2.8	92	113	100
Phenylalanine	5.5	84	23.7	91	4.6	21.6	6.1	137	133	136
Tyrosine	3.3	83	17.4	92	2.7	16.0	3.9	–	–	–
Phe + Tyr	–	–	–	–	7.3	37.6	10.0	109	116	112
Crude protein (N× 6.25)	105.5	80	456.4	89	84.4	406.2	112.3	–	–	–

<sup>a</sup>Degussa (1996).

<sup>b</sup>Standardized digestibility (Amipig, 2000).

<sup>c</sup>85% barley + 10% soybean meal + 5% non-protein ingredients.

<sup>d</sup>Relative to proposal for ideal protein (Table 9.4, column G).



According to the amino acid profile of the diet only supplementation with lysine and threonine is needed to assure high dietary protein quality. Furthermore, these calculations indicate that leucine and valine from the secondary limiting group are equally limiting with methionine from the first limiting group. Thus, a much more informative characterization of protein sources and diets is obtained by this simple method than the traditional BV.

### **Optimization and Standardization of Experimental Conditions**

The accumulating knowledge from experimental determinations of requirements for amino acids has not yet led to a generally agreed standard ideal dietary amino acid profile. One reason for this is that a large number of factors influence amino acid requirements in practical pig production. Obviously, many of these factors also influence experimental results when estimating requirements. Furthermore, the specific experimental basis may influence the results obtained and, consequently, the conclusions drawn. Therefore, all influencing factors should always be considered appropriately when estimating amino acid requirements. Below, some generally influencing factors are discussed and possible ways of standardization of future studies on amino acid requirements are suggested.

#### **Verification and control of available amino acids in the experimental diets**

Firstly, the amounts of available amino acids, i.e. standardized digestible amino acids, in the actual batches of ingredients for the experimental diets should be known by using: (i) 100% digestible protein sources; (ii) table values of protein sources which are known to vary only little; (iii) direct *in vivo* digestibility measurements of the actual batches; or (iv) analyses for *in vitro* digestibility of protein from which the digestibility of the amino acids may be calculated with sufficient accuracy (Boisen, 2000).

Generally, supplementation of industrial amino acids is needed, in particular of the investigated amino acid because of the necessity of a series of experimental diets only varying in the composition of the investigated amino acid. These amino acids are generally expected to be 100% utilized. However, free amino acids may be more susceptible to reactions with other compounds in the feed than protein-bound ones. In particular, free methionine and tryptophan are known to be sensitive to destruction from free radicals produced from oxidation of unsaturated fatty acids during storage.

The content of supplemented free amino acids should, therefore, generally be controlled throughout the experiment.

#### **Utilization of free amino acids supplemented directly into the actual diet**

Possible destruction of free amino acids can be avoided by direct supplementation to the diet immediately before feeding. However, because free amino acids may be quickly fermented in liquid feed, they would also be expected to be susceptible to the possible fermentation which may occur in the stomach before the digesta enter the small intestine. Furthermore, free amino acids may not be absorbed as efficiently as peptides actually generated after normal protein digestion. Thus, studies by van der Meulen *et al.* (1998) indicate that the efficiency in the recovery of free dietary amino acids in the portal vein may vary considerably, from 100% for isoleucine, to about 80% for lysine, threonine, methionine and tryptophan and only 60% for cystine.

The different possible influencing factors question the general expectation that industrial amino acids are 100% utilized and free amino acids may in some cases be utilized even less efficiently than protein-bound amino acids. Obviously, this possible overestimation of the actual concentration and utilization of supplemented industrial amino acids may result in overestimation of the amino acid requirements which are commonly based on experimental diets with increasing levels of the investigated amino acid supplemented in its free form.

### **Other factors influencing experimental determinations of amino acid requirements**

Many natural compounds in common feedstuffs may influence amino acid requirements. Thus, antinutritional factors like trypsin inhibitors increase the requirements for sulphur amino acids due to increased losses of cystine-rich proteolytic enzymes (Liener, 1979). On the contrary, feedstuffs containing choline or betaine may reduce the requirements of sulphur amino acids due to their function as methyl-donors, which may replace this function of methionine.

Animal factors can also influence the determination of amino acid requirements. Thus, the health status of the experimental animals, e.g. inflammatory processes, increases the requirement for methionine for extra production of antibodies (Williams and Stahly, 1996). This may also affect responses obtained with newly operated cannulated pigs (Pedersen and Boisen, 2001).

### **Basic principles for experimental diets**

In growing pigs, protein deposition is closely associated with deposition of water and bone development, resulting in a weight increase of 4.4 kg for each kg deposited protein (Boisen and Verstegen, 2000). Growth and feed utilization are therefore often used as response parameters in studies on amino acid requirements. However, many different factors influence these responses, in particular the growth of the pig and, consequently, its actual amino acid requirements.

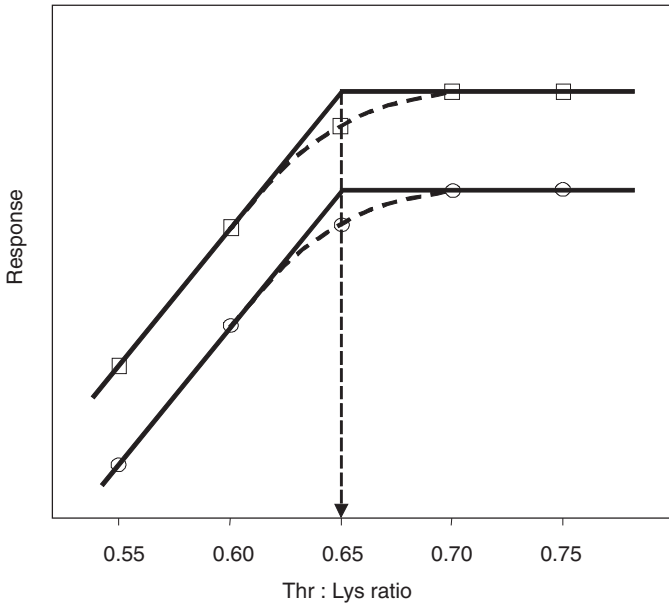
The most fundamental factor is the dietary energy supply which usually limits protein deposition up to at least 40 kg live weight (Black, 2000). Consequently, amino acid requirements should basically be related to the optimal composition of available amino acids relative to available energy in the diet. On the other hand, feed evaluations throughout the world are based on many different energy evaluation systems (Boisen and Verstegen, 1998) and a number of factors may influence the correct determination of available energy

in the actual experimental diets. Furthermore, it is necessary to consider that the amino acid requirements relative to the energy supply rapidly decrease during growth (Fig. 9.2).

Therefore, in order to simplify the presumptions on which the experiments are based, experimental determinations of individual amino acid requirements relative to a reference amino acid, i.e. lysine, using the concept of an ideal dietary amino acid profile, may generally improve validity of the obtained results on amino acid requirements.

For a proper experimental determination of the optimal ratio between a specific amino acid, e.g. threonine, and lysine, five diets, only varying in the composition of threonine, are needed. Figure 9.3 illustrates the principle in the prediction of the optimal Thr:Lys ratio in a theoretically perfect experiment with five levels of threonine and each series is performed at two different levels of lysine. In both series lysine is limiting in relation to energy supply. However, threonine is only limiting at the two lowest levels, which describe the slope of the response curves, whereas the two sets with the highest levels of threonine describe the plateau when lysine is limiting, and threonine is in a relative surplus. The intercept between the two linear curves corresponds exactly to the ratio at which threonine and lysine are equally limiting and, consequently, the optimal ratio between the two amino acids. This ratio is not considered to be influenced by the concentration of the amino acids when they are only slightly below their requirements relative to the energy requirement.

For establishing the optimal ratio between a specific amino acid, e.g. threonine and lysine, the latter needs to be undersupplied throughout the experimental period. Furthermore, all other essential amino acids need to be slightly oversupplied. Otherwise, the determined ratio between the investigated amino acid and lysine will be underestimated. According to Fig. 9.2 this is a particular problem in younger pigs where the amino acid requirements relative to the energy requirement are rapidly decreasing. The practical solution for this can be a 10% deficit of lysine and a 10% surplus of each of the other essential amino acids. This may be performed by using a multiphase feeding system in which



**Fig. 9.3.** Theoretically perfect experimental data for determining the optimal Thr:Lys ratio in diets for growing pigs at two different limiting levels of lysine (for further details see text).

the protein concentration is gradually decreased (Boisen, 1993).

### Conclusions

The ideal amino acid profile is a valuable tool for characterizing the amino acid requirements for pigs as well as the protein quality of feedstuffs and diets. In practical feed evaluation systems there appears to be a tendency to higher recommendations for amino acids from the primarily limiting group than for those in the secondary limiting group, which are also generally much less studied. This may be related to a tendency to experimental overestimations of the requirement for the investigated amino acid.

Sow's milk appears to be a relevant and

useful reference for most amino acid requirements for growing pigs, with the exception of threonine, sulphur amino acids and tryptophan. These have relatively high requirements after weaning due to increased maintenance requirements, which also increase relatively when the relative protein deposition decreases in the finishing period of slaughter pigs. However, for practical feed production the ideal dietary amino acid profile for fast growing pigs may be considered to be constant.

Because experimental determinations of amino acid requirements are influenced by a large number of factors, more standardization and improved optimization of the experimental conditions is generally needed before differences in the ideal dietary amino acid profile for growing pigs from weaning to 100 kg live weight can be identified and documented.

### References

- AmiPig (2000) Ileal standardized digestibility of amino acids in feedstuffs for pigs. AFZ, Ajinomoto Eurolysine, Aventis Animal Nutrition, INRA; ITCF, France.
- ARC (1981) *The Nutrient Requirements of Pigs*. Commonwealth Agricultural Bureau, Farnham Royal, UK.

- Batterham, E.S. (1994) Ileal digestibilities of amino acids in feedstuffs for pigs. In: D'Mello, J.P.F. (ed.) *Amino Acids in Farm Animal Nutrition*. CAB International, Wallingford, UK, pp. 113–131.
- Black, J. (2000) Amino acid and energy requirements. In: Moughan, P.J., Verstegen, M.W.A. and Visser, M. (eds) *New Developments in Feed Evaluation*. Wageningen Pers, The Netherlands, pp. 189–207.
- Boisen, S. (1993) New strategy for optimizing amino acid supply to growing pigs. In: Verstegen, M.W.A., den Hartog, L.A., van Kempen, G.J.M. and Metz, J.H.M. (eds) *Nitrogen Flow in Pig Production and Environmental Consequences*. Pudoc, Wageningen, pp. 157–162.
- Boisen, S. (1997) Ideal protein – and its suitability to characterize protein quality in pig feeds. A review. *Acta Agriculturae Scandinavica A, Animal Science* 47, 31–38.
- Boisen, S. (2000) *In vitro* digestibility methods: history and specific approaches. In: Moughan, P.J., Verstegen, M.W.A. and Visser, M. (eds) *New Developments in Feed Evaluation*. Wageningen Pers, The Netherlands, pp. 153–168.
- Boisen, S. and Moughan, P.J. (1996a) Dietary influences on endogenous ileal protein and amino acid loss in the pig – a review. *Acta Agriculturae Scandinavica A, Animal Science* 46, 154–164.
- Boisen, S. and Moughan, P.J. (1996b) Different expressions of dietary protein and amino acid digestibility in pig feeds and their application in protein evaluation: a theoretical approach. *Acta Agriculturae Scandinavica A, Animal Science* 46, 165–172.
- Boisen, S. and Verstegen, M.W.A. (1998) Evaluation of feedstuffs and pig diets. Energy or nutrient based evaluation systems? 1. Limitations of present energy evaluation systems. *Acta Agriculturae Scandinavica A, Animal Science* 48, 86–94.
- Boisen, S. and Verstegen, M.W.A. (2000). Developments in the measurement of the energy content of feeds and energy utilisation in animals. In: Moughan, P.J., Verstegen, M.W.A. and Visser, M. (eds) *New Developments in Feed Evaluation*. Wageningen Pers, The Netherlands, pp. 57–76.
- Boisen, S., Hvelplund, T. and Weisbjerg, M.R. (2000) Ideal amino acid profiles as a basis for feed protein evaluation. *Livestock Production Science* 64, 239–251.
- Chung, T.K and Baker, D.H. (1992) Ideal amino acid pattern for 10-kilogram pigs. *Journal of Animal Science*. 70, 3102–3111.
- Cole, D.J.A. and Van Lunen, T.A. (1994) Ideal amino acid patterns. In: D'Mello, J.P.F. (ed.) *Amino Acids in Farm Animal Nutrition*. CAB International, Wallingford, UK, pp. 99–112.
- CVB (1999) *Veevoedertabel 1999*. Central Veevoederbureau, Lelystad, The Netherlands.
- Degussa (1996) *The Amino Acid Composition of Feedstuffs*, 4th revised edn. Degussa Feed Additives, Frankfurt am Main, Germany.
- Fuller, M.F. (1991) Present knowledge of amino acid requirements for maintenance and production: non-ruminants. In: Eggum, B.O., Boisen, S., Børsting, C., Danfær, A. and Hvelplund, T. (eds) *Protein Metabolism and Nutrition*. EAAP publ. no 59, vol. 1. Herning, Denmark, pp. 116–126.
- Fuller, M.F. (1994) Amino acid requirements for maintenance, body protein accretion and reproduction in pigs. In: D'Mello, J.P.F. (ed.) *Amino Acids in Farm Animal Nutrition*. CAB International, Wallingford, UK, pp. 155–184.
- Fuller, M.F., McWilliam, R., Wang, T.C. and Giles, L.R. (1989) The optimum dietary amino acid pattern for growing pigs. 2. Requirements for maintenance and for tissue protein accretion. *British Journal of Nutrition* 62, 255–267.
- Jørgensen, H., Fernandez, J.A. and Bech-Andersen, S. (1988) *Deposition and Amino Acid Contents in Slaughter Pigs* [in Danish]. Communication no 701 from the National Institute of Animal Science, Denmark, 4 pp.
- Liener, I.E. (1979) The nutritional significance of plant protease inhibitors. *Proceedings of the Nutrition Society* 38, 109–113.
- Mosenthin, R., Sauer, W.C., Blank, R., Huisman, J. and Fan, M.Z. (2000) The concept of digestible amino acids in diet formulation for pigs. *Livestock Production Science* 64, 265–280.
- Moughan, P.J. and Rutherford, S. (1996) A new method for determining digestible reactive lysine in foods. *Journal of Agricultural Food Chemistry* 44, 2202–2209.
- NRC (1988) *Nutrient Requirements of Swine*, 9th revised edn. National Academy Press, Washington, DC, 93 pp.
- NRC (1998) *Nutrient Requirements of Swine*, 10th revised edn. National Academy Press, Washington DC, 189 pp.
- Pedersen, C. and Boisen, S. (2001) Studies on the response time for plasma urea nitrogen as a rapid measure for dietary protein quality in pigs. *Acta Agriculturae Scandinavica A, Animal Science* 51, 209–216.

- Pedersen, C. and Boisen, S. (2002) Establishment of table values for standardised ileal digestibility of crude protein and essential amino acids in common feedstuffs for pigs. *Acta Agricultural Scandinavica Section A. Animal Science* 52, 121–140.
- Pedersen, C., Lindberg, J.E. and Boisen, S. (2003) Determination of the optimal dietary threonine: lysine ratio for finishing pigs. *Livestock Production Science* (in press).
- Rademacher, M., Sauer, V.C and Jansman, A.J.M. (1999) *Standardized Ileal Digestibility of Amino Acids in Pigs. The New System, 1999*. Degussa-Hüls, Frankfurt am Main, Germany. 20 pp.
- van der Meulen, J.J., Bakker, J.G.M., Jager, L.P. and van der Meulen, J. (1998) Absorption and elimination kinetics of free essential amino acids in pigs. *Journal of Animal Physiology and Animal Nutrition* 79, 237–247.
- Wang, T.C. and Fuller, M.F. (1989) The optimum dietary amino acid pattern for growing pigs. 1. Experiments by amino acid deletion. *British Journal of Nutrition* 62, 77–89.
- Williams, N.H. and Stahley, T.S. (1996) Impact of immune system activation on the lysine and sulphur amino acid needs of pigs. 1995 *Swine Research Report*. Iowa State University, Ames, Iowa, pp. 31–34.

# 10 Digestible Amino Acids in Diet Formulation for Pigs

R. Mosenthin<sup>1\*</sup> and M. Rademacher<sup>2</sup>

<sup>1</sup>*Institute of Animal Nutrition, Hohenheim University, Stuttgart, Germany;* <sup>2</sup>*Feed Additives Division, Degussa AG, Applied Technology, Hanau, Germany*

---

## Introduction

It is generally accepted that the protein requirement of the pig is primarily a requirement for indispensable amino acids (Table 1.1). The amount of these amino acids in the diet and their relative proportions determine the deposition of protein in the pig. However, feedstuffs used in diets for pigs vary not only in their amino acid composition but also in their digestibility. Depending on the type and source of feedstuff variable amounts of amino acids disappear from the gastrointestinal tract to be utilized by the pig for maintenance and tissue accretion. As a result, digestibility of amino acids between feed components varies considerably. For example, amino acids originating from casein are almost completely released during digestion whereas for certain cereal by-products more than half of the amino acids may remain undigested and unabsorbed from the animal's gastrointestinal tract. Consequently, accurate data on the digestibility of amino acids in feedstuffs are needed to meet the pig's daily requirement for indispensable amino acids more precisely from both a physiological and an economic point of view.

Protein supplements usually represent 20% of the diet but make up approximately 35% of the cost of the diet. One way to lower

the cost of protein is to reduce the concentration of protein in the diets or to reduce the quantity of amino acids possibly provided in excess of the actual requirement, i.e. to reduce the margin of safety. However, this cannot be done efficiently without affecting optimum performance unless the quantity of available amino acids in the diet and the quantity required by the pig are known.

Animal growth and digestibility assays are the two major evaluation systems for assessing the bioavailability of amino acids in feed ingredients for pigs. At this point it is important to distinguish between the concepts of digestible and available amino acids. By definition, apparent amino acid digestibility is calculated as the percentage of amino acid intake that does not appear in digesta or faeces. Using the term 'apparent' implies that no correction for endogenous amino acid losses has been made. On the other hand, bioavailability of amino acids is defined as the proportion of amino acids in the diet not associated with compounds which may interfere with digestion, absorption or utilization for maintenance or tissue accretion (ARC, 1981). For example, certain amino acids such as lysine, threonine, methionine and tryptophan are susceptible to the effect of heat treatment. As a result, they may be partly damaged and absorbed in a form which renders these

\*E-mail address: rhmosent@uni-hohenheim.de

complexes unavailable for protein metabolism by the pig. In this case, ileal amino acid digestibility values usually overestimate amino acid availability values (Wiseman *et al.*, 1991; Batterham, 1992). Batterham *et al.* (1979) introduced the animal growth assay, also referred to as the slope-ratio technique, for measuring the availability of amino acids for maintenance and tissue accretion. This growth assay provides a combined estimate of digestibility and postabsorptive utilization of amino acids at the tissue level.

However, many other factors including amino acid balance, dietary protein level, energy level, chronology of appearance of absorbed amino acids at the tissue level as well as genotype and physiological stage of the animal may have an impact on protein metabolism and therefore may affect the results (e.g. Adeola, 1996). Furthermore, the animal growth assay is rather expensive, time consuming and provides an estimate of the availability of only one amino acid per assay (e.g. Austic, 1983; Sibbald, 1987). On the other hand, Batterham (1992) concluded that particularly for cereals ileal digestibility values were the most appropriate as these account for losses in digestibility. Moreover, Laplace *et al.* (1989) have shown that apparent ileal digestibility coefficients accurately describe the extent of amino acid absorption, at least for a range of commonly used feed ingredients which have not been subjected to high temperature treatment during feed manufacturing. Finally, according to Williams (1995) the use of ileal digestibility values represents a compromise between total amino acid values in feed ingredients and amino acid availability that will improve the accuracy of diet formulation.

The main focus of this review is directed to the development of different concepts of amino acid digestibilities and the use of true digestible amino acids in diet formulation for pigs.

### **Expression of Apparent Ileal and Faecal Amino Acid Digestibilities**

The digestion of amino acids in the large intestine is the result of microbial activity. The disappearance of amino acids from this

part of the digestive tract would not be necessarily a problem if disappearance represented absorption of amino acids. However, several studies have clearly demonstrated that protein digestion through microbial activity does not contribute to maintenance or tissue accretion since the absorbed end products of microbial fermentation are ultimately excreted in the urine (Zebrowska, 1973; Wünsche *et al.*, 1982; Mosenthin *et al.*, 1992). In conclusion, due to microbial metabolism of nitrogenous material both from exogenous (dietary) and endogenous sources, only a relatively small proportion of the amino acid excretion in faeces is directly related to the amino acids recovered at the distal ileum. According to Low (1982), amino acids of dietary origin appear to account for less than 10% of the total amino acids at the faecal level, the main part consisting of microbial and endogenous sources. Depending on diet composition, between 50 and 90% of total nitrogen in faeces can be attributed to bacterial nitrogen assimilation (Poppe *et al.*, 1983; Kreuzer *et al.*, 1989; Sauer *et al.*, 1991).

There is general agreement that in most cases apparent ileal digestibility values of most indispensable amino acids are lower than corresponding digestibilities determined at the faecal level. For example, cystine, threonine and tryptophan usually disappear to a considerable extent in the large intestine (Zebrowska *et al.*, 1978; Sauer *et al.*, 1982; Mosenthin *et al.*, 1994). On the other hand, microbial net synthesis for methionine and sometimes for lysine has been reported in some studies resulting in lower faecal than ileal digestibility values (Sauer *et al.*, 1982; Tanksley and Knabe, 1982; Sauer *et al.*, 1991). Thus, depending on the amino acid and on the feedstuff, digestibility values obtained by the faecal analysis method overestimate (which is usually the case) or underestimate those obtained by the ileal analysis method. Therefore, it is now recognized that the ileal analysis method should be considered as an improvement over the faecal analysis method which was originally developed by Kuiken and Lyman (1948) for rats and which thereafter has been used extensively in studies with pigs (Dammers, 1964; Eggum, 1973).

A comparison of apparent faecal and ileal amino acid digestibilities in raw and heated soy flakes illustrates the inadequacy of the faecal analysis method for measuring amino acid digestibility values (Table 10.1). The difference between faecal and ileal digestibility values of amino acids in raw soy flakes averaged 30% whereas the corresponding difference in heated soy flakes was approximately 7%. Although faecal digestibilities indicated that heated soy flakes were a better nutrient source than raw soy flakes, the magnitude of this difference was substantially underestimated (Vandergrift *et al.*, 1983).

It is obvious that apparent ileal amino acid digestibilities are a more sensitive approach to describe the nutritive value of feedstuffs than faecal digestibilities. The poorer the protein quality of feed, the more important ileal digestibility values are compared to faecal digestibility values. Convincing evidence that ileal rather than faecal digestibility values should be used in practical diet formulation for growing pigs was provided by Dierick *et al.* (1988). In this study the performance of pigs was related to digestibility measurements. There was a higher correlation between average daily gain and ileal rather than faecal protein digestibility ( $r = 0.76$  vs.  $r = 0.34$ ). In the same order, for feed efficiency ( $\text{kg feed kg}^{-1}$  carcass gain) the correlation coefficients were  $-0.87$  and  $-0.65$ , respectively. In agreement with these findings, apparent ileal lysine digestibility coefficients

were found to accurately indicate the amount of dietary lysine available for growth (Moughan and Smith, 1985; Schulz and Böhme, 1994; Rademacher *et al.*, 1995). These results provide sufficient evidence that nitrogen absorbed in the large intestine does not contribute significantly to protein synthesis in growing pigs.

There is, however, a need to focus on some potential drawbacks in the interpretation and the use of apparent ileal amino acid digestibilities in diet formulation for pigs. It has to be emphasized that the impact of microbial fermentation in the small intestine on protein digestion and amino acid absorption is probably underestimated (Bergner *et al.*, 1986; Torrallardona *et al.*, 1994; De Lange and Fuller, 2000). It can be assumed that in particular threonine that accounts for approximately 25% of mucus protein (Lien *et al.*, 1997) is the preferential source of endogenous nitrogen for microbes attached to the intestinal surface. Furthermore, it has to be stressed that apparent ileal digestibility estimates are not corrected for endogenous nitrogen and amino acid losses that contribute at different levels to the total flow of nitrogen and amino acids at the distal ileum. As a result, apparent ileal protein and amino acid digestibility values may vary considerably, depending on the relative contribution of endogenous nitrogen and amino acids to non-digested dietary (exogenous) sources of nitrogen and amino acids. Approaches for adjust-

**Table 10.1.** Apparent ileal and faecal amino acid digestibility values of the indispensable amino acids in raw and heated soy flakes. (From Vandergrift *et al.*, 1983.)

Amino acid	Digestibility (%)					
	Faecal		Ileal		Difference (%) <sup>a</sup>	
	Raw	Heated	Raw	Heated	Raw	Heated
His	80	90	48	82	32	8
Ile	68	84	43	78	25	6
Leu	68	87	37	80	31	7
Lys	72	87	44	85	28	2
Met	61	83	47	82	14	1
Thr	65	83	32	72	33	11
Trp	75	87	25	72	50	15
Val	64	85	35	78	29	7

<sup>a</sup>Difference between faecal and ileal digestibility values.



ments of endogenous nitrogen and amino acid recoveries that allow for the determination of true ileal protein and amino acid digestibilities are discussed here.

## Expression of True Ileal Amino Acid Digestibilities

### Sources of variation in apparent ileal digestibility values

Several studies have shown that apparent ileal protein and amino acid digestibilities increased curvilinearly with the level of protein and/or amino acids in the assay diet (e.g. Furuya and Kaji, 1989; Li *et al.*, 1993; Fan *et al.*, 1994). This observation gave rise to some concern about possible underestimation of amino acid digestibility values from low-protein feedstuffs such as cereal grains through measurement and expression of apparent digestibility.

However, it comes somewhat as a surprise to note considerable variation in apparent ileal amino acid digestibility values among different samples of the same feedstuff rather than between feedstuffs (Sauer *et al.*, 1990). For example, as summarized by Mosenthin *et al.* (1997) for protein and the indispensable amino acids, the differences were relatively large for protein, lysine, methionine and threonine within wheat and barley, ranging from 71 to 86%, 62 to 84%, 79 to 92%, and 51 to 78%, respectively, in wheat, and from 45 to 80%, 38 to 79%, 67 to 88% and 44 to 76%, respectively, in barley (Table 10.2). However, as shown in Table 10.2, there were relatively small differences in the average apparent ileal protein and amino acid digestibility values between different cereal grains compared to differences within the same cereal grain. For instance, the digestibility values ranged from 70 to 81%, 66 to 73%, 78 to 85%, and 64 to 72% for protein, lysine, methionine and threonine, respectively, between wheat and barley. Similar to cereal grains there were in most cases relatively small differences in the average apparent ileal protein and amino acid digestibility values between different protein supplements and legume seeds in comparison to differences in digestibility coefficients within the same feedstuff (Table 10.2).

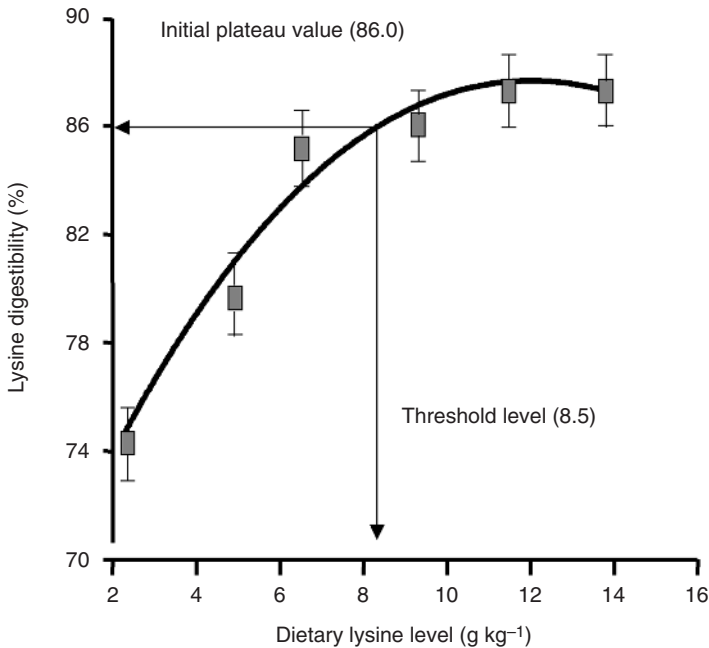
In conclusion, the rather larger within than between variation in different feedstuffs indicates that methodological rather than other factors such as inherent factors (e.g. fibre level, antinutritional compounds, fertilizer application) may be responsible for a large proportion of this variation (Sauer and Ozimek, 1986; Gatel, 1992; Sauer *et al.*, 2000). Therefore, a major part of the variation in apparent ileal digestibility values of protein and amino acids within the same feedstuff may be simply a reflection of experimental error, and this variation may misrepresent the real variation among samples of the same feedstuff. In fact, Fan *et al.* (1994) identified differences in the protein and amino acid content of the assay diets as the largest single contributor to the variation of apparent ileal protein and amino acid digestibility values within the same feedstuff. Feeding maize-starch-based diets with graded levels of crude protein from soybean meal (4, 8, 12, 16, 20 and 24%) to growing pigs resulted in curvilinear effects of protein and individual amino acids on apparent ileal digestibility values. The analysis of the digestibility values according to a segmented quadratic with plateau model resulted in quadratic relationships between the apparent ileal amino acid digestibility values and the amino acid content in the assay diet as illustrated in Fig. 10.1 for lysine. Initially, the apparent ileal digestibility values increased sharply; thereafter the increases became smaller and reached their individual plateau values after which there were no further increases which means that the digestibility coefficients became independent of the dietary amino acid levels. In this model lower endpoints of 95% confidence intervals of the plateau digestibility values were defined to be the initial plateau digestibility values. By definition, the dietary protein and amino acid contents, corresponding to the initial plateau digestibility values, were referred to as the dietary threshold levels.

Sauer *et al.* (2000) concluded from a comprehensive literature review that the total contents of crude protein and amino acids in assay diets containing cereal grains were usually far below these threshold levels. As a result, small differences in dietary contents of crude protein and amino acids below the cor-

**Table 10.2.** Apparent ileal digestibilities (%) of crude protein and indispensable amino acids in cereal grains, protein supplements and legume seeds. (Adapted from Mosenthin *et al.*, 1997.)

Ingredients	<i>n</i> <sup>a</sup>	N × 6.25			Lys			Met			Thr		
		DC <sup>b</sup>	Range	SD <sup>c</sup>	DC	Range	SD	DC	Range	SD	DC	Range	SD
Cereal grains													
Wheat	22	81	71–86	4.2	73	62–84	6.5	85	79–92	3.5	72	51–78	6.7
Barley	20	70	45–80	8.2 [19] <sup>d</sup>	66	38–79	10.1	78	67–88	6.0 [18]	64	44–76	8.6
Maize	8	70	49–82	11.7 [7]	68	50–82	5.9	85	79–92	4.3	65	53–79	9.6
Triticale	6	78	76–82	3.0 [4]	72	62–81	6.7	82	77–85	3.1	62	46–74	11.1
Protein supplements													
Soybean meal	30	80	72–89	3.7	84	76–91	3.4	86	77–97	4.3 [27]	75	68–83	3.9
Canola meal	14	69	64–73	2.5	73	69–81	3.1	82	76–93	4.7 [11]	67	60–74	3.7
Cottonseed meal	12	75	67–86	5.7	66	42–87	11.5	77	65–87	8.6 [11]	66	55–79	7.7
Meat and bone meal	16	67	57–82	6.8	70	56–85	8.5	77	66–85	6.6 [7]	64	50–81	9.2
Fishmeal	7	76	72–82	3.9	83	77–89	5.0	88	82–94	5.2 [4]	78	73–84	3.6
Legume seeds													
Peas	9	73	69–76	2.7	81	73–84	3.6	73	68–76	2.5	65	60–74	4.1
Faba beans	6	74	69–77	2.8	80	77–87	3.6	67	61–77	7.1 [4]	73	57–84	11.5

<sup>a</sup>Number of observations.<sup>b</sup>Digestibility coefficient, mean values and range of values.<sup>c</sup>Standard deviation.<sup>d</sup>Values in parentheses following protein and methionine digestibility values indicate the number of samples in which the protein and methionine digestibility was determined.



**Fig. 10.1.** The quadratic with plateau relationship between the apparent ileal lysine digestibility and the level of lysine in the diet. (Fan *et al.*, 1994.)

responding threshold levels will result in relatively large variations in the digestibility coefficients of amino acids, as dietary amino acid levels quadratically affect ileal amino acid digestibilities. Those amino acids present at low levels in cereal grains (lysine, threonine and tryptophan) and/or amino acids of which the ileal endogenous recovery is relatively high (e.g. threonine) will be especially affected.

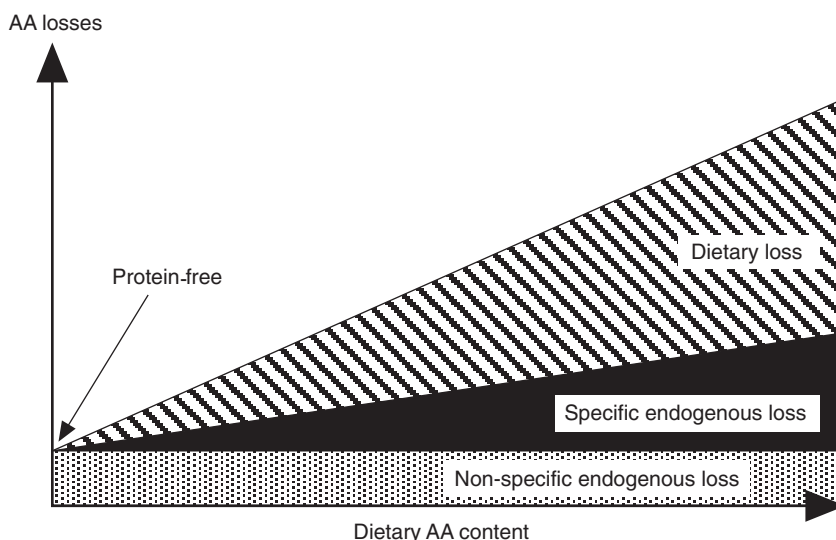
In conclusion this variation of apparent digestibility in relation to the level of dietary protein and amino acids is consistent with the hypothesis of a non-specific endogenous loss proportional to dry matter intake rather than proportional to the level of protein and/or amino acid intake.

#### **Transformation of apparent into true digestibility values**

If one accepts that the determination of amino acid digestibility values should be based on the ileal analysis method, these digestibility coefficients should be consistent

with two main specifications. First, they must allow feed ingredients to be accurately compared, thus being independent of experimental and dietary conditions. Secondly, they must include any variation of the endogenous fraction related to the feedstuff itself, which is one of its attributes and must be considered in diet formulation. These specifications hold true for estimates of true ileal protein and amino acid digestibility.

At this point it is important to distinguish between specific and non-specific endogenous protein and amino acid losses that originate from various sources such as saliva, pancreatic and bile secretions, sloughed off epithelial cells and from mucus (Souffrant, 1991). As illustrated in Fig. 10.2, the non-specific recovery – also referred to as basal recovery or minimum gut loss – is related to the dry matter intake only but independent of dietary and experimental conditions. The level of non-specific endogenous amino acid losses, expressed as g kg<sup>-1</sup> dry matter is constant at different dietary amino acid levels. The transformation of apparent ileal amino acid



**Fig. 10.2.** Sources of amino acid (AA) losses in ileal digesta.

digestibility values into values of true digestibility by correction for non-specific amino acid losses is described by the equation:

$$\text{TID (\%)} = \frac{\text{AA intake} - (\text{AA excretion} - \text{non-specific AA})}{\text{AA intake}} \times 100$$

where TID = true ileal digestibility and AA = amino acid.

Apparent digestibility values that have been transformed into true digestibility values according to this equation were originally referred to as 'standardized ileal digestibility values' (Mariscal-Landin, 1992).

In contrast to the non-specific protein and amino acid recoveries the specific recovery – also referred to as extrarecovery – is

variable and related to the presence of inherent factors in the feedstuff such as fibre, lectins, tannins and protease inhibitors. Corrections of apparent ileal digestibility values for both specific and non-specific protein and amino acid losses would allow for the calculation of the so-called 'real' ileal protein and amino acid digestibility coefficients (Low, 1982). The data presented in Table 10.3 clearly indicate that the specific rather than the non-specific nitrogen and amino acid losses compensate for the differences in apparent digestibility between field peas and soy protein isolate. The difference in specific endogenous losses between these feedstuffs can be attributed to variable amounts of inherent factors such as protease inhibitors. There

**Table 10.3.** Comparison of apparent, true and real nitrogen and amino acid digestibilities in field peas and soy protein isolate. (Adapted from Huisman *et al.*, 1992; Sève *et al.*, 1994.)

Item	Huisman <i>et al.</i> (1992)	Sève <i>et al.</i> (1994)
	Field peas (g 100 g <sup>-1</sup> nitrogen)	Soy protein isolate (g 100 g <sup>-1</sup> amino acids)
Apparent digestibility	74.1	89.3
Non-specific endogenous loss	7.8	3.5
True digestibility	81.9	92.8
Specific endogenous loss	11.0	4.5
Real digestibility	92.9	97.3

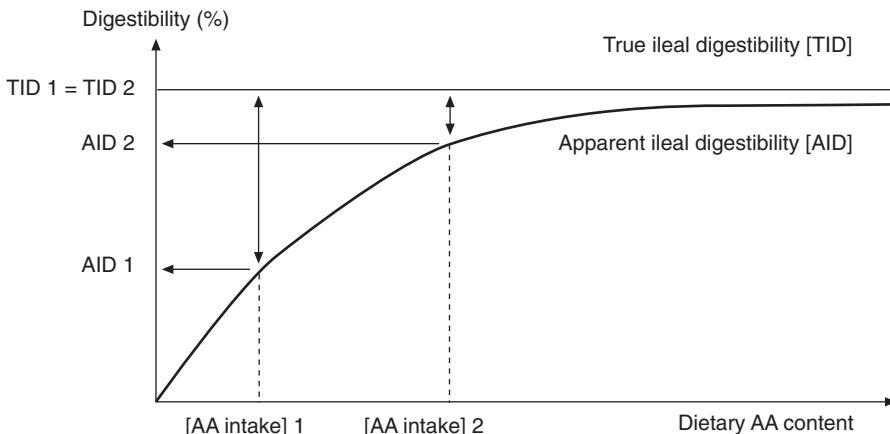
is of great interest in the evaluation of real digestibilities from a scientific point of view (e.g. De Lange *et al.*, 1990; Mosenthin *et al.*, 1993). However, the use of these values in practical diet formulation for pigs is limited since any variation of the endogenous fraction related to the feedstuff itself as one of its specific attributes is completely eliminated from the digestibility values.

True ileal protein and amino acid digestibility has the advantage over both apparent and real digestibility in that it represents a fundamental property of the individual feedstuff. In other words, true digestibility values include any variation of the endogenous fraction related to the feedstuff itself. Figure 10.3 shows that true digestibility values are not affected by the level of amino acid intake or amino acid content of the assay diet, whereas the corresponding apparent digestibility values increase exponentially with higher levels of intake because the non-specific amino acid recoveries, as percentage of total recovery, decrease proportionally.

There is growing evidence that non-specific endogenous amino acid losses are likely to interfere with additivity of apparent amino acid digestibilities in mixtures of feed ingredients (Imbeah *et al.*, 1988; Fan *et al.*, 1995; Nyachoti *et al.*, 1997a,b). For example, Nyachoti *et al.* (1997b) concluded from the results of their study that there may be a lack

of additivity in apparent ileal amino acid digestibilities when low-protein feedstuffs such as barley are combined with high-protein feed ingredients such as canola meal (Table 10.4). The correction of apparent ileal amino acid digestibilities for non-specific amino acid losses that are assumed not to be affected by differences in diet composition, will eliminate these effects. The resulting true amino acid digestibilities are more likely to be additive than the corresponding apparent digestibility values (Mariscal-Landin, 1992; Jondreville *et al.*, 1995; Boisen and Moughan, 1996; NRC, 1998; Rademacher *et al.*, 1999). Additivity of amino acid digestibility values in the diet formulation for pigs by least-cost formulation programmes is essential since these programmes use individual digestibility coefficients for each feedstuff to fulfil the amino acid specifications. True digestibility values allow feed ingredients to be accurately compared and contribute to the precision of diet formulation.

The key issue for the quantification of true ileal protein and amino acid digestibilities is the quantification of the non-specific protein and amino acid recoveries in ileal digesta. The data presented in Table 10.5 reveal considerable variation between estimates of non-specific protein and amino acid recoveries in the literature. Surprisingly, even when the same methodological approach was used for



**Fig. 10.3.** Expression of apparent and true ileal amino acid digestibilities as a function of amino acid (AA) intake.

**Table 10.4.** Observed and calculated apparent and true ileal digestibilities for selected amino acids in barley, canola meal and a mixture of barley and canola meal. (Adapted from Nyachoti *et al.*, 1997b.)

Item	Barley	Canola meal	Mixture of barley and canola meal		
			Observed	Calculated <sup>a</sup>	Difference <sup>b</sup>
Apparent ileal digestibility (%)					
Lys	53.5	62.6	63.6	59.0	4.6
Thr	63.7	62.4	67.7	62.9	4.8
Ile	65.3	73.2	78.6	70.6	8.0
Val	67.6	69.5	72.1	65.7	6.4
True ileal digestibility <sup>c</sup> (%)					
Lys	87.1	84.6	85.8	85.8	0.0
Thr	97.0	97.8	96.6	97.5	-0.9
Ile	95.1	99.7	100.2	97.4	2.8
Val	89.1	97.4	96.4	93.1	3.3

<sup>a</sup>Calculated from observed digestibilities in the pure ingredients and their contents in the mixture of barley and canola meal.

<sup>b</sup>Calculated as observed minus calculated values.

<sup>c</sup>Determined with the homoarginine method.

**Table 10.5.** Comparison of non-specific endogenous protein and amino acid recoveries in ileal digesta of growing pigs (g kg<sup>-1</sup> dry matter intake).

Item	AmiPig (2000)			Rademacher <i>et al.</i> (1999)
	Lab <sup>a</sup> A	Lab B	Lab C	
N × 6.25	8.66	7.22	9.67	11.82
Lys	0.29	0.24	0.41	0.40
Met	0.08	0.05	0.13	0.11
Met + Cys	0.22	0.22	0.30	0.32
Thr	0.33	0.27	0.39	0.61
Trp	0.09	0.09	0.17	0.14

<sup>a</sup>Laboratory.

estimating non-specific protein and amino acid recoveries, these estimates exhibited a large variation between laboratories (AmiPig, 2000). Boisen and Moughan (1996) concluded from a literature review that differences in methods, including analytical procedures to estimate these losses, and between animal variation are major factors contributing to the considerable variation between estimates for non-specific protein and amino acid recoveries. For example, more conventional approaches are based on the feeding of protein-free diets, the use of the regression analysis method or the feeding of diets containing protein sources (e.g. casein) with an assumed 100%

ileal protein digestibility. Other methods include the peptide alimentation ultrafiltration method, also referred to as the enzymatically hydrolysed casein (EHC) method, the homoarginine method and calculation methods based on the difference between the *in vitro* and *in vivo* digestibility of protein and amino acids. Comprehensive descriptions and evaluations of these methods were provided by Tamminga *et al.* (1995), Boisen and Moughan (1996) and Nyachoti *et al.* (1997a). According to Nyachoti *et al.* (1997a) estimates of endogenous protein and amino acid recoveries in ileal digesta are not only affected by animal and dietary factors but also differ for

various methods. For example, Boisen and Moughan (1996) reported that the non-specific endogenous protein recoveries varied between 10 and 15 g kg<sup>-1</sup> dry matter intake when protein-free diets were fed. However, under more physiologically normal conditions (i.e. when protein-containing diets were given), the non-specific recoveries accounted for about 20 g kg<sup>-1</sup> dry matter intake. Nyachoti *et al.* (1997a) concluded that estimates of endogenous protein and amino acid recoveries obtained with the regression method as well as by feeding protein-free diets should be referred to as the minimum values that are not related to the protein and amino acid content of the diet.

Different estimates for the correction of non-specific protein and amino acid losses are currently used in feed tables in which true ileal protein and amino acid digestibilities are summarized (Jondreville *et al.*, 1995; CVB, 1998; NRC, 1998; Rademacher *et al.*, 1999; AmiPig, 2000). For example, in AmiPig (2000), promoted by AFZ, Ajinomoto Eurolysine, Aventis Animal Nutrition, Institut National de la Recherche Agronomique (INRA) and Institut Technique des Céréales et des Fourrages (ITCF), the calculations for the correction of non-specific endogenous ileal protein and amino acid recoveries are based on data that were obtained by feeding protein-free diets to growing pigs. On the other hand, Rademacher *et al.* (1999) transformed values of apparent ileal protein and amino acid digestibility into values of true digestibility by using existing literature data on endogenous recoveries of protein and amino acids in ileal digesta. These authors selected 33 experiments from the literature that were based on different experimental approaches. These included conventional methods such as feeding protein-free diets without ( $n=16$ ) or with parenteral infusion of amino acids ( $n=1$ ) (e.g. De Lange *et al.*, 1989a,b), the regression method ( $n=3$ ) (e.g. Fan *et al.*, 1995) and the feeding of highly digestible protein sources such as wheat gluten or casein ( $n=11$ ) (e.g. Chung and Baker, 1992). In addition, the corrections for non-specific protein and amino acid recoveries in ileal digesta were based on the EHC method ( $n=2$ ) (e.g. Butts

*et al.*, 1993). It was claimed that the diets in the experiments selected by Rademacher *et al.* (1999) contained no specific anti-nutritional factors and not more than 8% cellulose or purified neutral detergent fibre (NDF). The data from these experiments were pooled and mean values for non-specific losses of protein and amino acid recoveries were calculated. As discussed by De Lange and Fuller (2000), extreme care should be taken in combining true digestibility values from different feed tables since differences in the methods used to estimate the non-specific endogenous protein and amino acid losses may affect the relationship between dietary amino acid levels and corrected amino acid digestibilities across studies and within ingredient.

The feeding of protein-free diets as proposed by AmiPig (2000) gives generally lower estimates of non-specific endogenous protein and amino acid recoveries as compared to estimates by Rademacher *et al.* (1999) which were based on different experimental approaches. The data presented in Table 10.5 reveal that these differences were considerably higher for threonine which is present in relatively large concentrations in endogenous protein (Holmes *et al.*, 1974; De Lange *et al.*, 1989a; Mosenthin *et al.*, 1994).

As can be expected, the method used for correction of apparent digestibility values has little effect on true digestibility estimates in high-protein feedstuffs with a relatively high apparent digestibility of amino acids and protein such as soybean meal (Table 10.6). Differences in true digestibility values in relation to the method used for estimating non-specific protein and amino acid recoveries are more pronounced in feed ingredients with lower apparent protein and amino acid digestibilities, in particular with respect to threonine and tryptophan.

### The Use of True Digestible Amino Acids in Diet Formulation

In practical terms, the digestibility concept chosen for the evaluation of the individual feed ingredients will have a major impact on the ranking of these feedstuffs. For example,

**Table 10.6.** Comparison of true ileal protein and amino acid digestibility values (%) in selected feedstuffs.

Ingredients	Barley	Wheat	Peas	Rapeseed meal	Soybean meal	Sugarbeet pulp
Crude protein						
NRC (1998)	–	–	–	–	–	–
Rademacher <i>et al.</i> (1999)	80	89	79	73	87	46
AmiPig (2000)	80	88	80	76	87	53
Lys						
NRC (1998)	79	81	88	78	89	51
Rademacher <i>et al.</i> (1999)	76	84	81	74	89	55
AmiPig (2000)	75	81	83	75	89	50
Met						
NRC (1998)	86	90	84	86	91	64
Rademacher <i>et al.</i> (1999)	82	90	74	81	90	59
AmiPig (2000)	84	89	80	87	88	61
Met + Cys						
NRC (1998)	86	90	83	84	87	44
Rademacher <i>et al.</i> (1999)	81	89	70	75	86	53
AmiPig (2000)	84	90	75	84	87	43
Thr						
NRC (1998)	81	84	83	76	85	30
Rademacher <i>et al.</i> (1999)	80	86	76	71	86	28
AmiPig (2000)	75	83	76	75	86	31
Trp						
NRC (1998)	80	90	81	75	87	41
Rademacher <i>et al.</i> (1999)	77	88	70	71	87	50
AmiPig (2000)	79	88	73	80	86	41

apparent and true ileal lysine and threonine digestibilities in some low- and high-protein feedstuffs, are ranked in Tables 10.7 and 10.8, respectively, in relation to soybean meal as a reference. In comparison to true ileal digestibility values the corresponding apparent digestibility coefficients systematically underestimate the digestibility of both, lysine and threonine (and other amino acids), in low protein grain cereals such as wheat, barley, maize and triticale. On the other hand, the consequences of different digestibility estimates on the ranking of high-protein feedstuffs such as oilseed meals and legume seeds are much less pronounced.

It is claimed that the application of true protein and amino acid digestibility values in diet formulation for growing pigs will promote the use of alternative low-protein feedstuffs and various by-products of the food processing industry. In the following two examples, two commercially available diets, referred to as reference diets, are formulated to contain as main ingredients maize and soybean meal (Table 10.9) or barley, wheat and soybean meal (Table 10.10). These diets contained equal levels of ME (13.5 MJ kg<sup>-1</sup>), N × 6.25 (183 g kg<sup>-1</sup>) and total lysine (10.5 g kg<sup>-1</sup>). Through complete or partial replacement of maize, barley, wheat and soybean meal in the



**Table 10.7.** Ranking of feed ingredients based on apparent and true ileal lysine digestibility values. (Adapted from Rademacher *et al.*, 1999.)

Ingredients	Apparent digestibility		True digestibility	
	Absolute (%)	Relative <sup>a</sup> (%)	Absolute (%)	Relative <sup>a</sup> (%)
Soybean meal	88	100	89	100
Wheat	75	85	84	94
Triticale	75	85	83	93
Barley	67	76	76	85
Maize	62	70	76	85
Sunflower meal	76	86	79	89
Rapeseed meal	71	81	74	83
Peas (field)	79	90	81	91
Beans (field)	80	91	82	92

<sup>a</sup>Relative to soybean meal.

**Table 10.8.** Ranking of feed ingredients based on apparent and true ileal threonine digestibility values. (Adapted from Rademacher *et al.*, 1999.)

Ingredients	Apparent digestibility		True digestibility	
	Absolute (%)	Relative <sup>a</sup> (%)	Absolute (%)	Relative <sup>a</sup> (%)
Soybean meal	83	100	86	100
Wheat	72	87	86	100
Triticale	65	78	79	92
Barley	65	78	80	93
Maize	63	76	80	93
Sunflower meal	76	92	80	93
Rapeseed meal	67	81	71	83
Peas (field)	69	83	76	88
Beans (field)	71	86	77	90

<sup>a</sup>Relative to soybean meal.

reference diets by alternative protein sources such as cottonseed meal, canola meal and peas and by-products such as wheat bran and rice bran, two types of diets were formulated, referred to as mixed diets type A and B (Tables 10.9 and 10.10).

The mixed diets type A were formulated to contain the same level of ME (13.5 MJ kg<sup>-1</sup>), N × 6.25 (183 g kg<sup>-1</sup>) and total lysine (10.5 kg<sup>-1</sup>) as the corresponding reference diets in Tables 10.9 and 10.10. However, due to the substitution of dietary components with a relatively high true ileal digestibility of lysine by those with lower digestibility coefficients, lower contents of true ileal digestible lysine in the mixed diets type A in comparison to the corresponding reference diets were obtained.

The level of true ileal digestible lysine in the mixed diets type A declined from 9.2 to 8.8 g kg<sup>-1</sup> (Table 10.9) and from 9.4 to 8.7 g kg<sup>-1</sup> (Table 10.10) as compared to the reference diets based on maize and soybean meal and barley, wheat and soybean meal, respectively. This decline in the content of true ileal digestible lysine would certainly have a negative effect on the growth performance of pigs, provided that these figures are below the actual lysine requirement of the pigs.

As a further example, two mixed diets type B were formulated that contained the same level of ME (13.5 MJ kg<sup>-1</sup>) and N × 6.25 (183 g kg<sup>-1</sup>) as compared to the reference diets and the mixed diets type A (Tables 10.9 and 10.10). However, to compensate

**Table 10.9.** The use of true ileal digestible lysine in the formulation of a maize–soybean meal-based diet and two types of mixed diets.

	Maize–soybean meal	Mixed diet A <sup>a</sup>	Mixed diet B <sup>b</sup>
Ingredient (g kg <sup>-1</sup> )			
Maize	543	380	356
Wheat middlings	200	170	210
Soybean meal (440 g CP kg <sup>-1</sup> )	223	149	177
Rice bran	–	200	190
Cottonseed meal	–	63	30
Tallow	–	7.4	06.8
D,L-Methionine	0.8	0.7	01.0
L-Lysine•HCl	2.4	3.0	03.0
L-Threonine	0.6	0.8	00.8
Vitamins and minerals	30.2	26.1	25.4
Energy and nutrients			
ME (MJ kg <sup>-1</sup> )	13.5	13.5	13.5
N × 6.25 (g kg <sup>-1</sup> )	183	183	183
Lysine (g kg <sup>-1</sup> )	10.5	10.5	108
Lysine, true ileal digestible (g kg <sup>-1</sup> )	9.2	8.8	92
Feed cost (US\$ per 100 kg) <sup>c</sup>	12.56	11.46	11.45

<sup>a</sup>Formulated to contain equal levels of crude protein and total lysine as maize–soybean meal diet.

<sup>b</sup>Formulated to contain equal levels of crude protein and true ileal digestible lysine as the maize–soybean meal diet.

<sup>c</sup>Based on US ingredient prices, February 2002.

for the lower content of true ileal digestible lysine in the mixed diets type A, the total dietary lysine level was elevated by supplemental lysine addition. As a result, there was no difference in the level of true ileal digestible lysine between the reference diets and the corresponding mixed diets type B. Consequently, no negative impact on growth performance of pigs could be expected.

Formulating more complex mixed diets according to type A, while maintaining the same level of total lysine as in the reference diets based on maize and soybean meal or barley, wheat and soybean meal, significantly reduced feed costs by approximately 8–9% (Tables 10.9 and 10.10). However, replacements of grain cereals and soybean meal by increasing proportions of alternative protein sources and by-products resulted in a pronounced decline in the level of true ileal digestible lysine which, in turn, most likely will result in a loss of growth performance.

On the other hand, formulating more complex diets according to type B by maintaining the same levels of true ileal digestible

lysine as in the reference diets decreased feed costs by approximately 9 and 3% as compared to the reference diets based on maize and soybean meal (Table 10.9) and barley, wheat and soybean meal, respectively (Table 10.10). In other words, savings in feed costs varied between 3 and 9% compared with standard diets based on cereal grains and soybean meal while maintaining the same content of true ileal digestible lysine in the diets. Therefore, the use of true ileal amino acid digestibility values in diet formulation for growing pigs offers the potential not only to improve the precision of diet formulation but also to improve the productivity in pig production through lower feed costs.

## Conclusions

It has been recognized that differences in dietary amino acids level are likely to be the largest single contributor to the variation in apparent ileal amino acid digestibility values

**Table 10.10.** The use of true ileal digestible lysine in the formulation of a wheat–barley–soybean meal-based diet and two types of mixed diets.

	Wheat–barley– soybean meal	Mixed diet A <sup>a</sup>	Mixed diet B <sup>b</sup>
Ingredient (g kg <sup>-1</sup> )			
Barley	288	–	–
Wheat	450	153	300
Soybean meal (440 g CP kg <sup>-1</sup> )	194	93	195
Rye	–	300	250
Canola meal	–	189	
Triticale		200	117
Wheat bran	–	–	80
Tallow	31.6	35.0	23.5
DL-Methionine	1.0	0.5	1.0
L-Lysine•HCl	3.0	2.1	2.8
L-Threonine	1.0	0.3	1.1
Vitamins and minerals	31.4	27.1	29.6
Energy and nutrients			
ME (MJ kg <sup>-1</sup> )	13.5	13.5	13.5
N × 6.25 (g kg <sup>-1</sup> )	183	183	183
Lysine (g kg <sup>-1</sup> )	10.5	10.5	10.6
Lysine, true ileal digestible (g kg <sup>-1</sup> )	9.4	8.7	9.4
Feed cost (Euros per 100 kg) <sup>c</sup>	16.24	14.99	15.84

<sup>a</sup>Formulated to contain equal levels of crude protein and total lysine as wheat–barley–soybean meal diet.

<sup>b</sup>Formulated to contain equal levels of crude protein and true ileal digestible lysine as the wheat–barley–soybean meal diet.

<sup>c</sup>Based on European ingredient prices, February 2002.

within the same feed ingredient. For a given amino acid, the apparent digestibility increases curvilinearly with the ingested quantity since the non-specific endogenous losses, as a proportion of total endogenous losses, decreases proportionally. The transformation of apparent into true ileal amino acid digestibility values is based on estimates for the correction of non-specific amino acid losses. True ileal amino acid digestibility coefficients are independent of the amino acid level in the assay diet and reflect a fundamental property of the feedstuff itself, not being influenced by differences in dietary conditions. Consequently, true amino acid digestibility values can be used in diet formulation for growing pigs to quantify the amino acids available for maintenance and tissue accretion at least for a wide range of commonly used feed ingredients which have not been subjected to high temperature treatment during feed processing.

The use of true ileal digestible amino acids in diet formulation will contribute to (i) a more accurate evaluation of the cost/benefit value of ingredients; (ii) an improved additivity of digestibility values in least cost formulation programmes; (iii) a more efficient use of alternative feedstuffs; (iv) an improved utilization of protein (nitrogen) and amino acids for maintenance and protein deposition; (v) a better prediction of growth performance of pigs; and finally (vi) a more cost-effective pig production.

However, there is considerable variation between estimates of non-specific amino acid losses at the ileal level. Consequently, different estimates are used in various tables in which true ileal amino acid digestibility values are summarized. Since the results from different feed tables are not compatible when being used in diet formulation for growing pigs, there is a need to standardize the estimates used for correction of apparent

digestibility values. Finally, the expression of true ileal amino acid digestibility and their use in diet formulation requires the assessment of the animal's requirement on digestible amino acids. In other words, the non-specific endogenous amino acid losses have to be taken into account when expressing amino acid requirements according to the concept of ideal protein which is discussed elsewhere.

## References

- Adeola, O. (1996) Bioavailability of tryptophan in soybean meal for 10-kg pigs using the slope-ratio assay. *Journal of Animal Science* 74, 2411–2419.
- AmiPig (2000) Ileal standardised digestibility of amino acids in feedstuffs for pigs. AFZ, Ajinomoto Eurolysine, Aventis Animal Nutrition, INRA and ITCF. Association Française de Zootechnie, Paris, France.
- ARC (Agriculture Research Council) (1981) *The Nutrient Requirements of Pigs*. Commonwealth Agricultural Bureaux, Slough, UK.
- Austic, R.E. (1983) The availability of amino acids as an attribute of feeds. In: Robards, G.E. and Packham, R.G. (eds) *Feed Information and Animal Production – Proceedings of the 2<sup>nd</sup> Symposium of the International Network of Feed Information Centres*. Commonwealth Agricultural Bureaux, Slough, UK, pp. 175–189.
- Batterham, E.S., Murison, R.D. and Lewis, C.E. (1979) Availability of lysine in protein concentrates as determined by the slope-ratio assay with growing pigs and rats and by chemical techniques. *British Journal of Nutrition* 41, 383–391.
- Batterham, E.S. (1992) Availability and utilization of amino acids for growing pigs. *Nutrition Research and Reviews* 5, 1–18.
- Bergner, H., Simon, O., Zebrowska, T. and Münchmeyer, R. (1986) Studies on the secretion of amino acids and of urea into the gastrointestinal tract of pigs. *Archiv für Tierernährung* 36, 479–490.
- Boisen, S. and Moughan, P.J. (1996) Dietary influences on endogenous ileal protein and amino acid loss in the pig – a review. *Acta Agriculturae Scandinavica, Section A Animal Science* 46, 154–164.
- Butts, C.A., Moughan, P.J., Smith, W.C. and Carr, D.H. (1993) Endogenous lysine and other amino acid flows at the terminal ileum of the growing pig (20 kg body weight): the effect of protein-free, synthetic amino acid, peptide and protein alimentation. *Journal of the Science of Food and Agriculture* 61, 31–40.
- Chung, T.K. and Baker, D.H. (1992) Apparent and true amino acid digestibility of a crystalline amino acid mixture and of casein: comparison of values obtained with ileal-cannulated pigs and cecectomized cockerels. *Journal of Animal Science* 70, 3781–3790.
- CVB (Centraal Veevoeder Bureau) (1998) *Veevoedertabel*. Centraal Veevoeder Bureau, Lelystad, The Netherlands.
- Dammers, J. (1964) Veteringsstudies bij het varken. Factoren van invloed op de vertering der veevoedercomponenten en de verteerbaarheid der aminozuren. PhD thesis, University of Leuven, Belgium.
- De Lange, C.F.M. and Fuller, M.F. (2000) Advances in feed evaluation for pigs. In: Moughan, P.J., Verstegen, M.W.A. and Visser-Reyneveld, M.I. (eds) *Feed Evaluation Principles and Practice*. Wageningen Pers, Wageningen, The Netherlands, pp. 221–241.
- De Lange, C.F.M., Sauer, W.C. and Souffrant, W.B. (1989a) The effect of protein status of the pig on the recovery and amino acid composition of endogenous protein in digesta collected from the distal ileum. *Journal of Animal Science* 67, 755–762.
- De Lange, C.F.M., Sauer, W.C., Mosenthin, R. and Souffrant, W.B. (1989b) The effect of feeding different protein-free diets on the recovery and amino acid composition of endogenous protein collected from the distal ileum and feces in pigs. *Journal of Animal Science* 67, 746–754.
- De Lange, C.F.M., Souffrant, W.B. and Sauer, W.C. (1990) Real ileal protein and amino acid digestibilities in feedstuffs for growing pigs as determined with the <sup>15</sup>N-isotope dilution technique. *Journal of Animal Science* 68, 409–418.
- Dierick, N., Vervaeke, I., Decuyper, J., Van der Heyde, H. and Henderickx, H.K. (1988) Correlation of ileal and fecal digested protein and organic matter to production performance in growing pigs. *Wissenschaftliche Zeitschrift WPU, Rostock. N-Reihe* 37, 50–51.
- Eggum, B.O. (1973) A study of certain factors influencing protein utilization in feedstuffs in rats and pigs. PhD thesis, Copenhagen, Denmark.

- Fan, M.Z., Sauer, W.C., Hardin, R.T. and Lien, K.A. (1994) Determination of apparent ileal amino acid digestibility in pigs: effect of dietary amino acid level. *Journal of Animal Science* 72, 2851–2859.
- Fan, M.Z., Sauer, W.C. and McBurney, M.I. (1995) Estimation by regression analysis of endogenous amino acid levels in digesta collected from the distal ileum of pigs. *Journal of Animal Science* 73, 2319–2328.
- Furuya, S. and Kaji, Y. (1989) Estimation of the true ileal digestibility of amino acids and nitrogen from their apparent values for growing pigs. *Animal Feed Science and Technology* 26, 271–285.
- Gatel, F. (1992) Protein quality of legume seeds for monogastric animals. In: *Proceedings of the First European Conference on Grain Legumes*. Angers, France, pp. 461–473.
- Holmes, J.H.G., Bayley, H.S., Leadbeater, P.A. and Horney, F.D. (1974) Digestion of protein in small and large intestine of the pig. *British Journal of Nutrition* 32, 479–489.
- Huisman, J., Heinz, T., Van der Poel, A.F.B., Van Leeuwen, P., Souffrant, W.B. and Verstegen, M.W.A. (1992) True protein digestibility and amounts of endogenous protein measured with the <sup>15</sup>N dilution technique in piglets fed on peas (*Pisum sativum*) and common beans (*Phaseolus vulgaris*). *British Journal of Nutrition* 68, 101–110.
- Imbeah, M., Sauer, W.C. and Mosenthin, R. (1988) The prediction of the digestible amino acid supply in barley–soybean meal or canola meal diets and pancreatic enzyme secretion in pigs. *Journal of Animal Science* 66, 1409–1417.
- Jondreville, C., Van den Broecke, J., Gatel, F. and Van Cauwenberghe, S. (1995) Ileal digestibility of amino acids in feedstuffs for pigs. *Eurolysine / ITCF publication*, Paris, France.
- Kreuzer, M., Roth, F.X. and Kirchgessner, M. (1989) Mikrobielle Umsetzungen im Enddarm von Sauen bei intracaecaler Infusion hoher Mengen an verschiedenen reinen Substraten. 1. Veränderung der Verdaulichkeit von Stickstoff und Aminosäuren. *Landwirtschaftliche Forschung* 42, 72–92.
- Kuiken, K.A. and Lyman, C.M. (1948) Availability of amino acids in some foods. *Journal of Nutrition* 36, 359–368.
- Laplace, J.P., Darcy-Vrillon, B., Perez, J.M., Henry, Y., Giger, S. and Sauvant, D. (1989) Associative effects between two fibre sources on ileal and overall digestibilities of amino acids, energy and cell-wall components in growing pigs. *British Journal of Nutrition* 61, 75–87.
- Li, S., Sauer, W.C. and Fan, M.Z. (1993) The effect of dietary crude protein level on amino acid digestibility in early weaned pigs. *Journal of Animal Physiology and Animal Nutrition* 70, 26–37.
- Lien, K., Sauer, W.C., Mosenthin, R., Souffrant, W.B. and Dugan, M.E.R. (1997) Evaluation of the <sup>15</sup>N-isotope dilution technique for determining the recovery of endogenous protein in ileal digesta of pigs: effect of dilution in the precursor pool for endogenous nitrogen secretion. *Journal of Animal Science* 75, 148–158.
- Low, A.G. (1982) Digestibility and availability of amino acids from feedstuffs for pigs: a review. *Livestock Production Science* 9, 511–520.
- Mariscal-Landin, G. (1992) Facteurs de variation de l'utilisation digestive des acides aminés chez le porc. PhD thesis, Rennes University, France.
- Mosenthin, R., Sauer, W.C., Henkel, H., Ahrens, F. and De Lange, C.F.M. (1992) Tracer studies of urea kinetics in growing pigs. II. The effect of starch infusion at the distal ileum on urea recycling and bacterial nitrogen excretion. *Journal of Animal Science* 70, 3467–3472.
- Mosenthin, R., Sauer, W. C., Lien, K.A. and De Lange, C.F.M. (1993) Apparent, true and real ileal protein and amino acid digestibilities in growing pigs fed two varieties of faba beans (*Vicia faba* L.) different in tannin content. *Journal of Animal Physiology and Animal Nutrition* 70, 253–265.
- Mosenthin, R., Sauer, W.C. and Ahrens, F. (1994) Dietary pectin's effect on ileal and fecal amino acid digestibility and exocrine pancreatic secretions in growing pigs. *Journal of Nutrition* 124, 1222–1229.
- Mosenthin, R., Rademacher, M. and Sauer, W.C. (1997) Zur scheinbaren präzäkalen Verdaulichkeit von Aminosäuren in Futtermitteln für Schweine. *Übersichten zur Tierernährung* 25, 41–85.
- Moughan, P.J. and Smith, W.C. (1985) Determination and assessment of apparent ileal amino acid digestibility coefficients for the growing pigs. *New Zealand Journal of Agricultural Research* 28, 365–370.
- NRC (National Research Council) (1998) *Nutrient Requirements of Swine*, 10th edn. National Academy Press, Washington, DC.
- Nyachoti, C.M., De Lange, C.F.M., McBride, B.W. and Schulze, H. (1997a) Significance of endogenous gut nitrogen losses in the nutrition of growing pigs: a review. *Canadian Journal of Animal Science* 77, 149–163.

- Nyachoti, C.M., De Lange, C.F.M. and Schulze, H. (1997b) Estimating endogenous amino acid flows at the terminal ileum and true ileal amino acid digestibilities in feedstuffs for growing pigs using the homoarginine technique. *Journal of Animal Science* 75, 3206–3213.
- Poppe, S., Meier, H., Bennke, H.J. and Stüwe, E. (1983) Zur Protein- und Aminosäurenverdaulichkeit in verschiedenen Darmabschnitten beim Schwein. 3. Mitteilung: Aminosäurenzusammensetzung von Chymus und Kotprotein. *Archiv für Tierernährung* 33, 743–748.
- Rademacher, M., Mosenthin, R. and Sauer, W.C. (1995) The use of apparent ileal lysine digestibility in diet formulation for the growing pig. In: Nunes, A.F., Portugal, A.V., Costa, J.P. and Ribeiro, J.R. (eds) *Proceedings of the 7<sup>th</sup> International Symposium on Protein Metabolism and Nutrition*. Vale de Santarem, Portugal, EAAP-Publication No. 81, pp. 123–127.
- Rademacher, M., Sauer, W.C. and Jansman, A.J.M. (1999) *Standardized Ileal Digestibility of Amino Acids in Pigs*. Degussa-Hüls AG, Feed Additives Division, Hanau, Germany.
- Sauer, W.C., Cichon, R. and Misir, R. (1982) Amino acid availability and protein quality of canola and rapeseed meal for pigs and rats. *Journal of Animal Science* 54, 292–301.
- Sauer, W.C. and Qzimek, L. (1986) Digestibility of amino acids in swine: results and their practical application. A review. *Livestock Production Science* 15, 367–387.
- Sauer, W.C., Imbeah, M. and Dugan, M. (1990) Amino acid digestibility in swine. In: *Proceedings of 26<sup>th</sup> Nutrition Conference for Feed Manufacturers*. Guelph, Ontario, pp. 1–15.
- Sauer, W.C., Mosenthin, R., Ahrens, F. and Den Hartog, L.A. (1991) The effect of source of fiber on ileal and fecal amino acid digestibility and bacterial nitrogen excretion in growing pigs. *Journal of Animal Science* 69, 4070–4077.
- Sauer, W.C., Fan, M.Z., Mosenthin, R. and Drochner, W. (2000) Methods for measuring ileal amino acid digestibility in pigs. In: D'Mello, J.P.F. (ed.) *Farm Animal Metabolism and Nutrition*. CAB International, Wallingford, UK, pp. 279–306.
- Schulz, E. and Böhme, H. (1994) The relevance of the prececal digestibility of lysine from different sources for pigfeeding under practical conditions. In: Souffrant, W.B. and Hagemester, H. (eds) *Proceedings of the 6<sup>th</sup> International Symposium on Digestive Physiology in Pigs*. Bad Doberan, Germany, EAAP Publication 80, pp. 140–142.
- Sève, B., Mariscal-Landin, G., Colléaux, Y. and Lebreton, Y. (1994) Ileal endogenous amino acid and amino sugar flows in pigs fed graded levels of protein or fibre. In: Souffrant, W.B. and Hagemester, H. (eds) *Proceedings of the 6<sup>th</sup> International Symposium on Digestive Physiology in Pigs*, Bad Doberan, Germany, EAAP Publication 80, pp. 35–38.
- Sibbald, I.R. (1987) Estimation of bioavailable amino acids in feedingstuffs for poultry and pigs: a review with emphasis on balance experiments. *Canadian Journal of Animal Science* 67, 221–300.
- Souffrant, W.B. (1991) Endogenous nitrogen losses during digestion in pigs. In: Verstegen, M.W.A., Huisman, J. and Den Hartog, L.A. (eds) *Proceedings of the 5<sup>th</sup> International Symposium on Digestive Physiology in Pigs*. Wageningen, The Netherlands, EAAP-Publication No. 54, pp. 147–166.
- Taminga, S., Schulze, H., Van Bruchem, J. and Huisman, J. (1995) Review. The nutritional significance of endogenous N-losses along the gastro-intestinal tract of farm animals. *Archives of Animal Nutrition* 48, 9–22.
- Tanksley, T.D., Jr and Knabe, D.A. (1982) Amino acid digestibility of some high protein feedstuffs and possible use in formulating swine diets. *Feedstuffs* 54, 16–21.
- Torrallardona, D., Haris, C.I., Milne, E. and Fuller, M.F. (1994) The contribution of intestinal microflora to amino acid requirements in pigs. In: Souffrant, W.B. and Hagemester, H. (eds) *Proceedings of the 6<sup>th</sup> International Symposium on Digestive Physiology in Pigs*. Bad Doberan, Germany, EAAP Publication No. 80, pp. 245–248.
- Vandergrift, W.L., Knabe, D.A., Tanksley, T.D., Jr and Anderson, S.A. (1983) Digestibility of nutrients in raw and heated soyflakes for pigs. *Journal of Animal Science* 57, 1215–1224.
- Williams, P.E.V. (1995) Digestible amino acids for non-ruminant animals: theory and recent challenges. *Animal Feed Science and Technology* 53, 173–187.
- Wiseman, J., Jaggert, S., Cole, D.J.A. and Haresign, W. (1991) Digestion and utilization of amino acids of heat-treated fish meal by growing/finishing pigs. *Animal Production* 53, 215–224.
- Wünsche, J., Hennig, U., Meinel, M., Kreienbring, F. and Bock, H.D. (1982) Investigation of the absorption and utilization of amino acids infused into cecum of growing pigs. I. N-balance measurement with regard to the utilization of lysine and isoleucine and requirement of growing pigs. *Archives of Animal Nutrition* 32, 337–348.

- Zebrowska, T. (1973) Digestion and absorption of nitrogenous compounds in the large intestine of pigs. *Roczniki Nauk Rolniczych* B95, 85–90.
- Zebrowska, T., Buraczewska, L., Pastuszewska, B., Chamberlain, A.G. and Buraczewski, S. (1978) Effect of diet and method of collection on amino acid composition of ileal digesta and digestibility of nitrogen and amino acids in pigs. *Roczniki Nauk Rolniczych* B99, 75–83.

# 11 Modelling Amino Acid Metabolism and the Estimation of Amino Acid Requirements

**P.J. Moughan\* and M.F. Fuller**

*Institute of Food, Nutrition and Human Health, Massey University,  
Palmerston North, New Zealand*

---

## **Introduction**

The accurate determination of 'requirement' values for each of the dietary essential amino acids and the dietary non-essential amino acid complement, is a fundamental aspect of animal nutrition and feeding. Consequently, much effort has been expended over the years in estimating amino acid requirement values for different classes of livestock. There has been an evolution in thinking and in the approaches used, for what has proven to be a relatively complex problem. Classical dose-response studies, which provided useful preliminary information, have now given way to often quite sophisticated metabolic models, which allow a more flexible and specific approach to amino acid requirement estimation. The present contribution reviews the traditional approaches to determining amino acid requirements in the pig, places these into an overall context and then introduces and discusses the simulation of amino acid metabolism and how mathematical models can be used to provide estimates of amino acid requirements. The discussion is restricted to the growing pig, though the principles established are general and may be applied to mature, reproducing and lactating animals.

## **Determination of Amino Acid Requirements**

### **Requirement estimation from dose-response experiments – an empirical approach**

The 'requirement' of an animal for a nutrient may be thought of as a point on a dose-response curve relating the level of intake of that nutrient and some measure of productivity of the animal or some indicator of metabolism. In the case of protein the 'requirement' is best considered as the requirement for individual amino acids rather than for the protein as a whole.

Although accurate estimates of the amino acid requirements for growth in the pig are necessary for efficient dietary formulation, considerable variation in the published experimentally determined recommendations is evident. The comprehensive reviews by Rérat and Loughon (1968) and Rérat (1972) demonstrate the degree of this variation. The Agricultural Research Council (1981), in a technical review, emphasized the inadequacies of information concerning amino acid requirements of the growing pig. Estimates of requirements for amino acids were presented and some values are given in Table 11.1.

\*E-mail address: P.J.Moughan@massey.ac.nz



**Table 11.1.** Determined requirements of the growing pig for some amino acids. (Agricultural Research Council, 1981.)

Amino acid	Range of requirement (g kg <sup>-1</sup> air-dry weight of diet)
Methionine + cystine	3.2–6.7
Tryptophan	1.2–2.2
Threonine	4.7–6.0
Isoleucine	2.7–6.7

Differences in factors such as the age, gender, breed and genetic strain of pig, physical environment, feeding level, dietary composition and experimental methods used are undoubtedly responsible for a great deal of the variation shown in Table 11.1. The methods adopted and the relative importance of experimental factors in the determination of amino acid requirements have been discussed in detail by Rérat and Lougnon (1968) and Fuller (1978). Most estimates of amino acid requirements have been made from empirically derived dose–response relationships. The successful estimation of amino acid requirements using this approach is reliant on the formulation of a basal diet deficient in the amino acid being studied but adequate in all other nutrients. Graded additions of the limiting amino acid are made to the basal diet and responses are measured. Several problems are apparent. First, to ensure adequate levels of all nutrients excepting the amino acid being examined, implies that the requirements for all other nutrients are previously known. Unfortunately, this is not the case. To circumvent the problem, nutrients other than the one being examined may be supplied in generous excess of the best estimates of requirements. This practice, however, may lead to imbalance effects. The feeding of imbalanced mixtures of amino acids is likely to affect the growth rate of animals (Harper *et al.*, 1970). Imbalance may affect the utilization of the limiting amino acid (Chapter 7) and under conditions of *ad libitum* feeding a primary effect on growth due to decreased food intake may be observed. Secondly, there is no generally accepted single measurement of response and

consequently the amino acid requirement determined will vary as to the type of response measured. Thirdly, assumptions need to be made concerning the shape of the response function. A linear plateau response may be appropriate for an individual animal, but will not be appropriate for the mean response of a group of animals (Fuller, 1994; Fisher, 1994). Further, some workers equate amino acid requirement with the input level corresponding to the point of maximum response whereas others choose the minimum input of the amino acid which produces a response not statistically significantly less than the maximum, as the required level. The latter approach is likely to lead to considerably lower estimates of amino acid requirements in cases whereby a large deviation of amino acid input from the input corresponding to maximum response, produces only a small alteration in response. Particularly where practical diets are used, comprising commonly used feedstuffs, there can be important differences between the available and gross amounts of a dietary amino acid, and this is a further significant source of variation.

#### Requirement estimation based on models of amino acid utilization – a theoretical approach

Because of the inherent errors associated with the empirical approach, and the difficulties in extrapolating results, attention has been given to developing causally based models describing the absorption and subsequent utilization of amino acids and other dietary nutrients. Such models are more general in their application. The simplest of these models are the early static factorial models which summed the metabolic losses of absorbed amino acids (often bulked together into a crude estimate of a ‘maintenance’ requirement) and the amino acids deposited in new proteinaceous tissue and then corrected the sum to take into account the inefficiency of utilization of absorbed amino acids. Such models were particularly popular in poultry nutrition (Hurwitz and Bornstein, 1973; Smith, 1978; Hurwitz *et al.*, 1983). An example in pig nutrition is the early modelling work of Whittemore and

Fawcett (1974). This pioneering work paved the way for more sophisticated models that take into account not only the amino acids but also the non-protein dietary energy and the interaction between amino acids and metabolizable energy (ME). These biological models include parameters affected by the nutritional history of the growing animal and incorporate adaptive control processes and impose limits on physiological and biochemical processes. A strength of the factorial approach, is that being causally based or deductive, the predictions from the model are general and the extrapolation problems associated with empirical results are not encountered. The approach allows amino acid requirements to be estimated for animals differing in their productive state. For these reasons, the factorial approach, and the development of mathematical models of nutrient utilization which build on the same principles, have gained acceptance as a means of estimating requirements for all amino acids simultaneously, which does not require prior estimates of requirements and which can be applied to other populations with different performance potentials. Of course, and although having the advantage of generality, the estimates of requirement are only as accurate as the model is an accurate representation of the real biological system. Over the last two decades considerable progress has been made in developing validated mathematical models describing pig growth at a physiological and biochemical level. These models have considerable potential for providing a flexible and dynamic approach to the estimation of amino acid requirements. Importantly, biological models, in addition to generating estimates of requirements also provide insight into the underlying biological mechanisms giving rise to these requirements.

Quite apart from the technical shortcomings of the empirical dose-response approach to requirement estimation, there is a further limitation in that the approach is usually confined to the measurement of physical or metabolic performance measures, that are often difficult to relate to financial outcomes. Thus, conventional feeding standards give estimates of the amount of each of the nutrients, required to maintain health of the animal and provide for near-maximal performance but do

not guarantee that profit will be maximized for a given situation. The production of pigs is not simply a process aimed at maximizing or minimizing certain physical performance measures but is rather a complex interaction between physical and financial effects, ultimately concerned with the maximization of profit.

What is required is the ability to derive production functions (Heady and Dillon, 1961) to enable the prediction of pig performance (defined in various ways) over a range of nutrient input levels. Ultimately, it is necessary to be able to predict the monetary value of output for given levels of nutrient intake, then by considering the respective costs (linear programming) of daily nutrient intakes, generate profit curves (Heady *et al.*, 1966; Dent, 1972). The levels of nutrient intake which maximize profit may be determined for different types of animal and environment, and the levels redetermined over time as situations change. This approach replaces the traditional concept of a static requirement with a spatially and temporally dynamic one.

For any class of pig, however, there is a multitude of production curves for different situations. Moreover, it is impractical and undesirable to attempt to conduct production trials to encompass the entire response surface. Fortunately, these curves can be readily generated using computerized models which simulate pig performance (Moughan and Verstegen, 1988).

### **The Modelling of Dietary Amino Acid Utilization**

Mathematical models which simulate the uptake, metabolism and partitioning of dietary nutrients, can be used ultimately to derive relationships between the monetary value of production and levels of nutrient intake for different types of pigs growing under different physical and financial conditions. Several biological models simulating growth in the pig have been developed and applied in commercial practice (Whittemore and Fawcett, 1976; Stombaugh and Oko, 1980; Moughan, 1981; Phillips and MacHardy, 1982; Tess *et al.* 1983; Whittemore, 1983; Moughan and Smith, 1984; Black *et al.*, 1986; Emmans,

1986; Moughan, *et al.*, 1987; Watt *et al.*, 1987; Burlacu *et al.*, 1988; Pettigrew *et al.*, 1989; Pomar *et al.*, 1991; Bridges *et al.*, 1992; Ferguson *et al.*, 1994; de Lange, 1995; Knap, 1996; van Milgen *et al.*, 2000) As the field of pig growth modelling develops, there is a tendency for models to become more causal (less empirical) and to further differentiate among the dietary nutrients and their ultimate metabolic fates (Boisen and Verstegen, 2000; Black, 2000a; Birkett and de Lange 2001). Models can provide predictions of the net utilization of individual nutrients, such as amino acids, glucose, fatty acids and volatile fatty acids. It is critical, in any biological pig growth model, to accurately simulate amino acid flow and thus be able to predict net body protein deposition and the supply of net energy from degraded amino acids. Implicit in this is the need to simulate the ingestion, digestion, absorption and metabolism of amino acids. The absorption and metabolism of amino acids in mammals is complex and highly integrated with continuous flux within and between body cells and compartments (see Chapters 1, 3, 4 and 5). It is useful, however, and inherently necessary

when constructing a model of metabolism, to view amino acid metabolism as several discrete physiological processes (Table 11.2) which underlie or are causative to amino acid utilization. These processes, and how they can be modelled are discussed briefly below. The reader is referred to the recent reviews by Moughan (1999), Black (2000b) and Whittemore *et al.* (2001) for a more comprehensive treatment of the topics.

In Table 11.2, a distinction is made between the 'maintenance' or 'basal' processes and those associated with growth. However, the maintenance and growth processes are highly interrelated. For example, gut endogenous amino acid losses are often considered part of the maintenance cost, but increase substantially with food dry-matter intake and are thus correlated with growth. For the growing pig, 'maintenance' is a concept rather than a reality and by definition does not exist as a sole state for a growing animal. If an animal is forced to a state of zero dietary nitrogen balance, it is no longer growing, and at least in the short term is in a highly catabolic state with respect to body lipid reserves.

**Table 11.2.** Biological processes underlying amino acid utilization in the growing pig.

1. Ingestion of dietary amino acids	
2. Amino acid absorption	
3. Maintenance <sup>a</sup>	<ul style="list-style-type: none"> <li>– Turnover of body protein</li> <li>– Integumental amino acid loss</li> <li>– Gut endogenous amino acid loss</li> <li>– Synthesis of non-protein nitrogen-containing compounds</li> <li>– Urinary amino acid losses</li> </ul>
4. Growth	<ul style="list-style-type: none"> <li>Body protein accretion</li> <li>Inevitable amino acid catabolism</li> <li>Gut endogenous amino acid loss</li> <li>Turnover of body protein</li> <li>Synthesis of non-protein nitrogen-containing compounds</li> <li>Preferential amino acid catabolism</li> </ul>
	Support costs {

<sup>a</sup>A distinction is made between basal or maintenance processes (i.e. those occurring in the hypothetical state whereby body tissue is neither being gained, nor lost) and those processes associated with the accretion of new body tissue. The rate of a process at 'maintenance' is defined as that rate commensurate with a daily food intake under which body weight is neither being gained nor lost. Rates of the processes during growth are variable. It should be noted that for most of the metabolic processes there is actually a natural continuum between maintenance and growth and that the distinction between states is arbitrary and reliant on definition.

Nevertheless, it is considered helpful to conceptualize and represent overall metabolism in two parts: maintenance and growth. At zero nitrogen retention there are still costs associated with body protein metabolism and these are the classical 'basal' or 'maintenance' costs. For positive nitrogen retention, there are extra costs incurred associated with maintaining the proteinaceous body tissues, but these may be better classified as 'support costs for growth' (Table 11.2), rather than 'maintenance'. The partitioning of overall amino acid metabolism into a relatively constant 'basal' or 'maintenance' component and a separate, more variable component associated with production (protein deposition plus support costs) is consistent with the early arguments of Folin (1905) reiterated by Mitchell (1959).

### **Predicting food intake and the ingestion of amino acids**

The amount of an amino acid ingested, is a function of the quantity of food ingested and the amino acid composition of that food. Under restricted feeding regimens the calculation of the daily amino acid intake is straightforward. However, under modern conditions of pig production, animals are often fed diets *ad libitum*. Here a prediction of the daily *ad libitum* food intake is required. The approach to predicting food intake is based on the assumption that each animal has a potential voluntary intake that is determined by its requirement for nutrients, and particularly energy, to meet potential rates of tissue gain, when reared under ideal, thermoneutral, disease-free and stress-free conditions.

The predicted actual food intake of an animal may be different from the predicted potential intake due to the effects of numerous dietary, climatic, social and disease factors which can be modelled (Black, 1995, 2000b; Emmans, 1995; Kyriazakis and Emmans, 1999).

### **Amino acid absorption**

The usual approach to modelling amino acid uptake has been to apply a mean digestibility coefficient, for the amino acid, based on

empirically derived digestibility coefficients for the amino acid in the respective dietary ingredients (Chapter 10). Although this approach does not afford a representation of the kinetics of amino acid absorption following a meal, and thus the dynamics of metabolism, it does appear to give acceptably accurate predictions of amino acid uptake and subsequent tissue deposition (Moughan, 1995). Coefficients of amino acid digestibility determined at the terminal ileum of the pig (ileal coefficients) should be used and depending on how a model represents gut endogenous amino acid losses, either 'true' or 'real' digestibility coefficients should be applied (Boisen and Moughan 1996a; Hodgkinson and Moughan 2000a). In pursuit of a greater generality of prediction of amino acid absorption, some modellers have recently attempted to simulate the mechanisms known to underlie the digestive and absorptive processes (Bastianelli and Sauvant, 1995; Rivest *et al.*, 2000).

For feedstuffs that have been processed or stored for prolonged periods of time, and at least for the highly reactive amino acid lysine, concentrations of lysine in the feed and ileal digesta found using conventional amino acid analysis will be misleading and the conventional true ileal digestibility assay will generally overestimate lysine availability. For such feedstuffs, alternative methods are needed to describe the dietary lysine content and the uptake of 'available' lysine molecules (Moughan and Rutherford, 1996; Rutherford *et al.*, 1997a,b).

### **Maintenance**

In the hypothetical state whereby a 'growing' pig is neither gaining nor losing net body protein, metabolic processes occur leading to the loss of proteinaceous material from the body. This gives rise to the 'maintenance' amino acid requirement.

The maintenance requirement for dietary amino acids reflects the continuous loss of amino acids via the skin and hair, a loss of amino acid nitrogen in the urine due to inefficiencies in the turnover of body protein, basal gut endogenous amino acid losses, the use of amino acids by cells to synthesize essential

non-amino acid and non-protein nitrogenous metabolites or the irreversible alteration of an amino acid (e.g. lysine to hydroxylysine), and the loss of free amino acids in the urine. The latter two processes are quantitatively minor and are usually ignored for modelling purposes. The other three processes are reasonably well understood and can be described quantitatively. Moughan (1999) has calculated values for the dietary maintenance protein requirement (PM) for the growing pig of:  $PM_1 = 105 \text{ mg kg}^{-0.75} \text{ day}^{-1}$  (integumental losses);  $PM_2 = 361 \text{ mg kg}^{-0.75} \text{ day}^{-1}$  (inefficiency in protein turnover);  $PM_3 = 637 \text{ mg kg}^{-0.75} \text{ day}^{-1}$  (basal gut losses) and  $PM = 1731 \text{ mg kg}^{-0.75} \text{ day}^{-1}$ . It is evident that for a rapidly growing animal, the maintenance amino acid requirement is only a small proportion (<10%) of the total daily amino acid requirement.

### Growth

The growth processes account for most (>90%) of the daily amino acid requirement for the growing pig, and the amino acids required to meet the need for new tissue deposition have a predominant role. However, the support costs of new protein synthesis (inevitable amino acid catabolism, gut endogenous amino acid losses, the turnover of body protein associated with new protein synthesis, the synthesis of non-amino and non-protein nitrogen-containing compounds, and the process of preferential amino acid catabolism) are certainly quantitatively important and need to be considered in a model of amino acid utilization.

To be able to predict the deposition of new protein, either requires a description of the processes of protein synthesis and protein degradation, with protein retention being found as a difference, or as is more commonly adopted, specifying the daily rate of protein retention (as some proportion of a genetically determined maximal rate of protein retention,  $Pd_{\text{max}}$ ) as a model input. Such a rate of retention combined with information on the amino acid composition of whole body protein can be used to calculate rates of amino acid deposition in newly synthesized tissues. Because the relationship between

daily carcass protein deposition and daily viscera protein deposition is not constant, gains in predictive accuracy can be made by modelling these two components separately.

The intrinsic upper limit to body protein retention ( $Pd_{\text{max}}$ ) is an important constraint on growth. The cell has a finite capacity for protein synthesis and is not able to store amino acids as such, for later use. If, after a meal, the uptake of balanced amino acids exceeds the animal's capacity for protein synthesis, the surplus amino acids will be deaminated and the carbon skeletons eventually degraded.  $Pd_{\text{max}}$  is influenced by genotype, gender, and age and mean values range from as low as  $90 \text{ g day}^{-1}$  to values exceeding  $200 \text{ g day}^{-1}$  (Whittemore, 1983; Campbell, 1985). The effect of age on  $Pd_{\text{max}}$  needs to be modelled and several different approaches have been used (Moughan, 1999; Whittemore *et al.*, 2001). It is also apparent that under practical growing conditions, pigs may not achieve the  $Pd_{\text{max}}$  value for their strain/breed as determined under breeding station conditions, because of effects due to factors such as sub-clinical disease and social conditions. For this reason the term 'operational  $Pd_{\text{max}}$ ' has been coined (Moughan *et al.*, 1995) and operational  $Pd_{\text{max}}$  can be determined on-farm (Morel *et al.*, 1993).

In addition to the amino acids required for the basal (maintenance) processes and for direct body protein deposition, the growing pig needs amino acids to fuel metabolic processes directly associated with protein deposition (the support costs). By way of example, as an animal eats more food and can thus deposit more body protein, there is an associated increase in the loss of gut endogenous amino acids. Also, as the rate of body protein deposition increases so too does the turnover of body protein (Milligan and Summers, 1986; Knap and Schrama, 1996) and presumably losses associated with turnover. There is a greater demand for metabolites, as the pig grows faster and thus the use of amino acids for the synthesis of other non-amino and non-protein compounds also increases. Moreover, there is an inevitable loss of absorbed amino acids to catabolic pathways, regardless of the animal's energy status (inevitable catabolism). These

various costs are described here as being support costs. The endogenous gut losses can be described directly whereas the 'other' support costs (excluding preferential amino acid catabolism, Table 11.2) are normally included together (as a measure of inefficiency of utilization of absorbed amino acids) for purposes of quantitation. Methods used for determining gut endogenous amino acid losses have been recently reviewed (Hodgkinson and Moughan, 2000b). The gut losses are related to food dry matter intake and are influenced by dietary composition, especially the type and amount of dietary fibre and antinutritional factors (e.g. tannins, lectins, trypsin inhibitors; see de Lange *et al.*, 2000). There is a considerable amount of published quantitative data on endogenous protein and amino acid loss in the growing pig (Boisen and Moughan, 1996b). The 'other' support costs (see above) reflect inefficiencies in the utilization of the absorbed first-limiting amino acid. Published estimates of the postabsorptive efficiency of utilization of the first-limiting amino acid point to a value of around 80%, but this value is not well characterized. The efficiency of utilization may vary among the absorbed amino acids and may be affected by the absorbed amount of the amino acid relative to the amount required for maximal body protein synthesis (Moughan, 1989; Seve and Henry, 1995). Inadequate information on the process of inevitable amino acid catabolism and the other processes (including protein turnover) contributing to inefficiency in utilization of the absorbed first-limiting amino acid is viewed as a major weakness in current models of amino acid utilization (Fuller, 1994).

The term 'preferential' as opposed to 'inevitable' catabolism is used to distinguish the catabolism of amino acids for the express purpose of energy supply (ATP generation). Preferential catabolism will occur in metabolic states whereby the supply of ATP from non-amino acid compounds becomes limiting in relation to the animal's needs. The preferential catabolism of amino acids can be quantitatively significant and must be described in models of amino acid utilization. Both empirical and deductive approaches have been used (Moughan, 1999).

## The Application of Models of Amino Acid Utilization

Mathematical models simulating dietary amino acid uptake and postabsorptive utilization can be used to estimate amino acid requirements for different types of pigs growing under different conditions and moreover provide the model user with insight as to why a particular requirement value is found. The utility of models is illustrated in the following three examples.

### The efficiency of utilization of dietary protein

Model predictions (Moughan and Smith, 1984) for the utilization of dietary crude protein and lysine (the first limiting amino acid) for a range of commercial pig grower diets, given to 50 kg live weight gilts ( $Pd_{\max} = 115 \text{ g day}^{-1}$ ) at two food intake levels (see Moughan, 1984, for details) are given in Table 11.3. The predictions show that the different diets, formulated for optimal growth, actually support very different rates of daily body protein deposition and illustrate the low and variable efficiencies of utilization. At the higher feeding level only three of the formulated diets supported maximal protein growth. The efficiency of utilization of dietary crude protein intake ( $Pe$ ) ranged from 20 to 42% at the lower level of meal intake and from 22 to 34% at the higher level. On average the ingested dietary protein was utilized with an efficiency close to 30%. The equivalent of around 70% of the ingested nitrogen was excreted from the pig's body. Part of this inefficiency can be explained by dietary amino acid imbalance, which may be purposeful and economically justifiable. Lysine was the first-limiting amino acid in each of the six diets, so it is pertinent to examine (Table 11.3) the efficiency of utilization of ingested lysine ( $Le$ ), whereby the effect of amino acid imbalance is removed. As expected, the values for  $Le$  are higher than the comparable values for  $Pe$ . On average the ingested lysine was utilized with an efficiency close to 44%, but still over half the dietary lysine was not used for the net deposition of lean tissue. Modelled data, such as these, highlight the importance of under-

**Table 11.3.** Efficiency of utilization<sup>a</sup> of dietary crude protein (CP) and lysine in six commercial pig growers diets, given at two feeding levels to 50 kg live weight gilts.

	Diet					
	1	2	3	4	5	6
Feeding level = 1710 g meal day <sup>-1</sup>						
Digestible CP intake (g day <sup>-1</sup> )	175	281	235	232	182	215
Protein deposited (g day <sup>-1</sup> )	48.9	110.0	73.5	106.9	74.3	115.0
Pe (%) <sup>b</sup>	20.4	30.0	23.1	33.8	32.3	42.1
Le (%) <sup>c</sup>	37.2	38.3	38.5	43.5	54.0	59.0
Feeding level = 2270 g meal day <sup>-1</sup>						
Digestible CP intake (g day <sup>-1</sup> )	232	374	312	309	242	285
Protein deposited (g day <sup>-1</sup> )	71.4	115.0	104.1	115.0	105.2	115.0
Pe (%) <sup>b</sup>	22.4	23.7	24.6	27.4	34.4	31.7
Le (%) <sup>c</sup>	40.9	30.2	41.1	35.3	59.0	45.0

<sup>a</sup>Predicted values (Moughan, 1984) from a pig growth simulation model. Assumes healthy animals growing in a thermoneutral environment.

$${}^b\text{Pe} = \frac{\text{Body protein deposited}}{\text{Diet crude protein intake}} \times \frac{100}{1}$$

$${}^c\text{Le} = \frac{\text{Body lysine deposited}}{\text{Diet total lysine intake}} \times \frac{100}{1}$$

standing the physiological processes which lead to losses of amino acids from the body, thus allowing better estimation of amino acid requirements and refined dietary formulation.

### The relative quantitative importance of physiological processes underlying dietary amino acid utilization

An important application of a model of amino acid metabolism is to provide a deeper quantitative understanding of the inherent metabolic and physiological processes. A model can be used to quantify the significance of different aspects of the growth process.

Having broadly described the processes in protein metabolism, a mechanistic model, describing amino acid flow in the 50 kg live weight pig and embodying the concepts discussed in this chapter, is now applied to give an overall appreciation of amino acid transactions. The deterministic model was based around that described by Moughan (1989) except that in the presently described model daily body protein deposition was predicted rather than given as a model input and daily food intake was a model input, with dietary energy partitioning being simulated. The model allows for specifi-

cation of total and chemically available dietary amino acid intakes and predicts absorbed amino acids based on true ileal digestibility coefficients. It describes cutaneous amino acid loss as a function of metabolic body weight and endogenous gut amino acid losses as a function of dry matter intake. The model includes a weighting factor for gut endogenous amino acid flow to allow expression of the effect of elevated amounts of antinutritional factors or dietary fibre. The fractional rate of whole body protein synthesis is given as a function of the mean daily protein deposition rate ( $P_d$ ) over the 3 days of growth preceding the day of simulation (assumed in this exercise to equal  $P_d$  on the day of simulation). The loss of protein nitrogen in the urine at maintenance is a set proportion of whole body protein synthesis and amino acids are assumed to be catabolized in proportion to their occurrence in body protein. Some amino acids (e.g. lysine) are assumed to be retained in the cell following protein breakdown and their catabolisms are discounted. The rates of inevitable catabolism are described as curvilinear functions of the amounts of amino acids absorbed in relation to the potential amino acid depositions (based on the genetic upper limit to protein retention,  $P_{d_{\max}}$ ). The model predicts the amount of each amino

acid available for growth (after maintenance and inevitable catabolism costs have been met) and the pattern of amino acids available for growth is compared with body protein amino acid composition to identify the first-limiting amino acid and to determine the imbalanced amino acids. In the model, if balanced protein available for growth is greater than  $Pd_{max}$  then excess amino acids are catabolized.

Net energy yields from amino acid catabolism are predicted, and with the non-protein digested energy, give metabolizable energy (ME). The daily ME is partitioned, ultimately to daily protein and lipid, facing a required minimal ratio of total lipid: protein in the body, to model the process of preferential catabolism.

The simulated flow of lysine in the 50 kg live weight pig, given a commercial grower diet (Table 11.4), is given in Table 11.5. The simulation data allow consideration of the modelled effects of level of food intake and  $Pd_{max}$ . In the model, feed intake does not influence the urinary loss of nitrogen at maintenance but  $Pd_{max}$  has a small effect. Inevitable catabolic nitrogen loss in the urine increases with increasing food intake and generally declines at a given food intake with increasing  $Pd_{max}$  but remains constant at high food intakes. The loss of urine nitrogen from catabolism due to excess amino acid supply is quantitatively significant at high food intakes, with the opposite being true for preferential catabolic loss. Cutaneous amino acid loss is unaffected by feeding level or  $Pd_{max}$  and gut loss is influenced by feed intake but not  $Pd_{max}$ . The loss of lysine due to imbalance was zero or minimal for the examples shown in

Table 11.5 as lysine was generally the first-limiting dietary amino acid.

The data in Table 11.5 demonstrate that, particularly at higher food intakes, the process of inevitable catabolism may have an important effect on the utilization of the first-limiting amino acid. Absorption and endogenous gut loss are also of importance, with body protein turnover being of lesser significance and cutaneous loss of only minor significance. Preferential catabolism may contribute relatively significantly to amino acid loss in situations where metabolizable energy limits protein deposition. Similarly, excess amino acid supply can make a major contribution to inefficiency.

The influence that the different processes have on overall protein metabolism will, of course, vary with the type of diet, age and weight of the animal. Nevertheless, application of the above simplified model gives a general view of amino acid dynamics and allows a ranking of the importance of the respective processes.

### Application of a pig growth model to determine economically optimal amino acid requirements

The principles of the economic approach to estimating nutrient requirements will be demonstrated here by reference to a biological pig growth model. The model (a revised version of that described by Moughan and Smith, 1984, and Moughan *et al.*, 1987) is a deterministic biological model which simulates the performance of an average healthy pig, growing from 20 to 100 kg live weight under thermoneutral conditions.

The programme requires information on: diet type (digestible nutrient content), diet cost and the feeding level (proportion of *ad libitum* digestible energy (DE) intake) and feed wastage; the sex and genotype (i.e. upper-limit to whole body protein retention,  $Pd_{max}$ ) of the pig, weaner cost and body condition; slaughter live weight, slaughter policy and grading specifications with current carcass prices. In turn, the model generates estimates of nutrient utilization, average daily live weight gain, mean feed conversion ratio, average carcass weight, P2 back-fat thickness, distribution of carcass grades and

**Table 11.4.** Ingredient composition of a commercial barley-based diet<sup>a</sup> formulated for growing pigs.

Ingredient	Composition (g kg <sup>-1</sup> air-dry weight)
Barley	732.5
Peas	165.0
Meat-and-bone meal	50.0
Fish meal	50.0
Vitamins, minerals	2.5

<sup>a</sup>Crude protein, 178 g kg<sup>-1</sup>; apparent digestible energy, 13.26 MJ kg<sup>-1</sup>; total lysine, 9.2 g kg<sup>-1</sup>.



**Table 11.5.** Predicted (simulation model) utilization of dietary lysine by the 50 kg live weight growing pig, at three feeding levels<sup>a</sup> and three maximal rates of body protein deposition ( $Pd_{max}$ ).

Feeding level (g day <sup>-1</sup> )	$Pd_{max}$	Losses (g day <sup>-1</sup> )											Deposition (g day <sup>-1</sup> )		
		Diet intake (g day <sup>-1</sup> )		Unabsorbed available lysine	Urine						Total Cutaneous	Gut endogenous	Total lysine	Protein	Lipid
		Total lysine	Available lysine		Protein turnover	Inevitable catabolism	Imbalance	Excess supply	Preferential catabolism						
1505	100	13.8	13.1	1.8	0.7	3.2	0	0	1.0	4.9	0.08	1.6	4.78	72	72
	130	13.8	13.1	1.8	0.8	2.5	0.2	0	1.4	4.9	0.08	1.6	4.83	73	73
	160	13.8	13.1	1.8	0.8	2.1	0	0	1.8	4.7	0.08	1.6	4.91	74	74
2069	100	18.9	17.9	2.3	0.7	4.7	0	1.6	0	7.0	0.08	1.9	6.63	100	162
	130	18.9	17.9	2.3	0.8	4.7	0	0	0	5.5	0.08	1.9	8.20	124	145
	160	18.9	17.9	2.3	0.8	3.9	0.1	0	0	4.8	0.08	1.9	8.84	133	138
2633	100	24.1	22.9	3.1	0.7	6.0	0	4.4	0	11.1	0.08	2.1	6.63	100	277
	130	24.1	22.9	3.1	0.8	6.0	0	2.3	0	9.1	0.08	2.1	8.62	130	255
	160	24.1	22.9	3.1	0.8	6.0	0	0.3	0	7.1	0.08	2.1	10.61	160	233

<sup>a</sup>Correspond to 8, 11 and 14% metabolic live weight, kg<sup>0.75</sup>.

financial return expressed as a gross margin. The gross margin is calculated as the average return per pig (a function of carcass weight and pig meat price averaged over grades) less weaner and feed costs and is expressed in terms of \$ per pig and \$ per pig place per year.

The model allows determination of an economically optimal feeding regimen (i.e. daily intakes of lysine as a proxy for balanced protein, and digestible energy, DE) for pigs growing under defined conditions. This application will be demonstrated by reference to the results of a case study. The case study described here (see Moughan and Smith, 1987, for a detailed description) is for a farm growing pigs between 20 and 80 kg live weight (all in/all out policy) of a specified genotype ( $Pd_{max} = 140 \text{ g day}^{-1}$  for entire males,  $130 \text{ g day}^{-1}$  for gilts). It is assumed that the pigs were disease free and were in a thermoneutral environment. The unit is designed for *ad libitum* feeding and there is interest in maximizing pig throughput as well as the financial return per pig.

Least-cost diets were formulated to contain a range of lysine/energy ratios and DE densities. The predicted gross margin returns for the entire-males and gilts fed *ad libitum* are shown in Table 11.6. Particularly for the high lysine/DE ratio diets the entire-males were

more profitable than gilts. Gross margin was maximized by feeding a ration containing  $9.7 \text{ g kg}^{-1}$  lysine and  $13.50 \text{ MJ DE kg}^{-1}$ . It is interesting to examine the growth characteristics of the gilts and entire-males fed the latter diet (Table 11.7). Dietary protein available for body protein deposition ( $Pg$ ) exceeds potential protein deposition ( $Pd_{max}$ ) at live weights greater than 50 kg for the entire-males and 40 kg for the gilts. Above these live weights excess amino acids are deaminated and the surplus energy is stored as lipid. In this case, the growth model was used to evaluate the effect on profit from the entire-males and gilts, respectively, consequent upon introducing a lower-protein finisher ration. The results of this analysis are presented in Table 11.8. Feeding strategies E and J allowed the entire-males and gilts, respectively, to make efficient use of the dietary protein available for growth ( $Pg$ ). These regimens are the most profitable of those analysed. For this particular farm it would be advised that gilts and entire-male pigs be penned separately; the entire-males should be given a  $9.7 \text{ g kg}^{-1}$  lysine,  $13.50 \text{ MJ DE kg}^{-1}$  diet from 20 to 60 kg live weight followed by a  $7.6 \text{ g kg}^{-1}$  lysine,  $13.50 \text{ MJ DE kg}^{-1}$  diet to slaughter at 80 kg live weight, whereas the gilts should be fed a  $9.7 \text{ g kg}^{-1}$  lysine,  $13.50 \text{ MJ DE kg}^{-1}$  diet to

**Table 11.6.** The gross margins (NZ\$/pig place/year) obtained by simulating growth in entire-male pigs and gilts given diets of varying lysine:DE ratio and DE density under *ad libitum* feeding.

Lysine:DE <sup>a</sup>	0.88	0.72	0.56	0.40
12.50 MJ DE kg <sup>-1</sup>				
GM <sup>b</sup> (entire)	150.21	168.04	127.43	32.16
GM (gilt)	134.74	151.21	126.38	32.17
13.00 MJ DE kg <sup>-1</sup>				
GM (entire)	153.36	175.18	144.31	40.90
GM (gilt)	137.84	158.28	138.30	40.90
13.50 MJ DE kg <sup>-1</sup>				
GM (entire)	153.51	178.08	151.46	47.49
GM (gilt)	136.78	160.66	144.70	47.49
14.00 MJ DE kg <sup>-1</sup>				
GM (entire)	148.09	174.37	154.08	51.26
GM (gilt)	128.06	156.28	144.20	51.26
14.50 MJ DE kg <sup>-1</sup>				
GM (entire)	139.92	166.06	146.10	49.06
GM (gilt)	122.70	148.83	138.96	49.06

<sup>a</sup>DE, digestible energy.

<sup>b</sup>GM, gross margin.

**Table 11.7.** Simulated values of dietary protein available for body protein deposition (Pg; g day<sup>-1</sup>), protein deposited (Pd; g day<sup>-1</sup>) and lipid deposited (Ld; g day<sup>-1</sup>) for gilts and entire-male pigs fed a diet containing 9.7 g kg<sup>-1</sup> lysine and 13.50 MJ DE kg<sup>-1</sup> *ad libitum*.

Live weight (kg)	Entire-male (Pd <sub>max</sub> = 140 g day <sup>-1</sup> )			Gilt (Pd <sub>max</sub> = 130 g day <sup>-1</sup> )		
	Pg	Pd	Ld	Pg	Pd	Ld
20	101	101	132	101	101	132
30	117	117	139	117	117	139
40	138	138	154	138	130	161
50	156	140	178	156	130	186
60	172	140	199	172	130	209
70	187	140	217	187	130	227
80	200	140	232	200	130	244

Pd<sub>max</sub>, upper genetic-limit to body protein retention.

50 kg live weight followed by a 7.6 g kg<sup>-1</sup> lysine, 13.50 MJ DE kg<sup>-1</sup> diet. Split-sex dual-diet feeding gives an extra NZ\$7.54 per pig place per year for the gilts and NZ\$1.08 for the entire-males, over the optimal feeding regimen for the mixed-sex, single-diet situation.

The analysis highlights the use of models to derive nutrient requirements, based on maximizing economic return. It also demonstrates that the daily requirement for amino acids changes throughout the growth period, underlining a further shortcoming of using static 'text book' estimates of average requirements.

The above outlines a systematic approach to devising optimal feeding programmes but should be viewed strictly as an 'example' of the type of analysis that can be undertaken using a computerized growth model. Management strategies guided by results obtained from a logical analysis of specific 'on-farm' situations are likely to yield real and worthwhile economic benefits. It should be realized that each farming situation is unique and situations change with time, both physically and financially. It is recommended that analyses, such as the above, be undertaken for individual farms and the situation be re-analysed whenever the values of model inputs change to an appreciable extent. Optimal solutions will vary between farms and over time thus suggesting the dynamic nature of the approach. It should be stressed that the validity of this method for estimating nutrient requirements is completely dependent on the predictive accuracy of the model, thus suggesting the need for thorough testing of models

before their use in practice. Also and considering the greater flexibility afforded by model use, it is likely that future nutritional research in monogastric species will move away from empirical dose-response type trials towards studies of the underlying causative factors of animal growth. As more sophisticated growth models are developed, the scope and accuracy of the economic analysis will be heightened.

## Conclusions

To achieve the objectives of modern pig production, amino acid requirements are best defined as the daily amounts of amino acids, that, when fed as part of an optimal mixture of nutrients in a diet, maximize financial gross margins. This concept introduces a spatial and temporal dynamism to requirement estimation. Amino acid requirements vary among farms and over time. The development and application of mathematical models which describe amino acid and nutrient utilization at the whole animal level, are necessary to achieve the degree of flexibility required to allow a dynamic estimation of amino acid requirements. Such models are driven by a mechanistic understanding of amino acid utilization embodied into mathematical algorithms simulating the physiological and biochemical processes, which interact to drive the outcomes of nutrient metabolism. These deductive growth models offer a powerful approach to the estimation of amino acid and nutrient requirements.

**Table 11.8.** Simulated values of dietary protein available for growth (Pg; g day<sup>-1</sup>), protein deposited (Pd; g day<sup>-1</sup>), lipid deposited (Ld; g day<sup>-1</sup>) and gross margins (NZ\$/pig place/year) for gilts and entire-male pigs fed grower/finisher diets *ad libitum*.

Entire male Live weight (kg)	Diet combination																				
	A				B				C				D				E				
	D <sup>a</sup>	Pg	Pd	Ld	D	Pg	Pd	Ld	D	Pg	Pd	Ld	D	Pg	Pd	Ld	D	Pg	Pd	Ld	
20	1	101	101	132	1	101	101	132	1	101	101	132	1	101	101	132	1	101	101	132	
30	1	117	117	139	1	117	117	139	1	117	117	139	1	117	117	139	1	117	117	139	
40	1	138	138	154	1	138	138	154	1	138	138	154	1	138	138	154	1	138	138	154	
50	1	158	140	178	2	154	140	177	3	119	119	208	4	78	78	249	1	158	140	178	
60	1	172	140	199	2	170	140	198	3	131	131	221	4	87	87	273	1	172	140	199	
70	1	187	140	217	2	184	140	216	3	142	140	235	4	93	93	293	3	141	140	230	
80	1	200	140	232	2	197	140	232	3	151	140	252	4	100	100	311	3	151	140	249	
Gross margin =		178.08				178.17				173.43				101.28				181.16			
Gilt Live weight (kg)	F				G				H				I				J				
	D	Pg	Pd	Ld	D	Pg	Pd	Ld	D	Pg	Pd	Ld	D	Pg	Pd	Ld	D	Pg	Pd	Ld	
	20	1	101	101	132	1	101	101	132	1	101	101	132	1	101	101	132	1	101	101	132
30	1	117	117	139	1	117	117	139	1	117	117	139	1	117	117	139	1	117	117	139	
40	1	138	130	161	2	136	130	160	3	105	105	190	4	70	70	225	1	138	130	161	
50	1	156	130	186	2	154	130	186	3	119	119	209	4	79	79	254	1	156	130	186	
60	1	172	130	209	2	170	130	209	3	131	130	223	4	87	87	277	3	131	130	221	
70	1	187	130	227	2	184	130	226	3	141	130	244	4	93	93	297	3	142	130	242	
80	1	200	130	244	2	197	130	243	3	151	130	262	4	100	100	315	3	151	130	260	
Gross margin =		160.66				160.75				160.88				87.23				167.54			

<sup>a</sup>D, diet fed over the specified live-weight range, where diet 1 contains 9.7 g kg<sup>-1</sup> lysine, 13.50 MJ DE kg<sup>-1</sup>; diet 2, 9.4 g kg<sup>-1</sup> lysine, 13.00 MJ DE kg<sup>-1</sup>; diet 3, 7.6 g kg<sup>-1</sup> lysine, 13.50 MJ DE kg<sup>-1</sup>, and diet 4, 5.6 g kg<sup>-1</sup> lysine 14.00 MJ DE kg<sup>-1</sup>.

## References

- Agricultural Research Council (1981) *The Nutrient Requirements of Pigs*. Commonwealth Agricultural Bureaux, Farnham Royal, UK, p 307.
- Bastianelli, D. and Sauvand, D. (1995) Modelling digestion and absorption in the pig. In: Danfaer, A. and Lescoat, P. (eds) *Proceedings of the IVth International Workshop on Modelling Nutrient Utilisation in Farm Animals*. National Institute of Animal Sciences, Foulum, Denmark, pp. 107–115.
- Birkett, S.H. and de Lange, C.F.M. (2001) Limitations of conventional models and a conceptual framework for a nutrient flow representation of energy utilization by animals. *British Journal of Nutrition* 86, 647–659.
- Black, J.L. (1995) Modelling energy metabolism in the pig – critical evaluation of a simple reference model. In: Moughan, P.J., Verstegen M.W.A. and Visser-Reyneveld, M.I. (eds) *Modelling Growth in the Pig*. Wageningen Pers, Wageningen, The Netherlands, pp. 87–102.
- Black, J.L. (2000a) Bioavailability: the energy component of a ration for monogastric animals. In: Moughan, P.J., Verstegen, M.W.A. and Visser-Reyneveld M.I. (eds) *Feed Evaluation Principles and Practice*. Wageningen Pers, Wageningen, The Netherlands, pp. 133–152.
- Black, J.L. (2000b) Amino acid and energy requirements. In: Moughan, P.J., Verstegen, M.W.A. and Visser-Reyneveld, M.I. (eds) *Feed Evaluation Principles and Practice*. Wageningen Pers, Wageningen, The Netherlands, pp. 189–207.
- Black, J.L., Campbell, R.G., Williams, I.H., James, K.J. and Davies, G.T. (1986) Simulation of energy and amino acid utilization in the pig. *Research and Development in Agriculture* 3 121–145.
- Boisen, S. and Moughan, P.J. (1996a) Different expressions of dietary protein and amino acid digestibility in pig feeds and their application in protein evaluation – a review. *Acta Agriculturae Scandinavica* 46, 165–172.
- Boisen, S. and Moughan, P.J. (1996b) Dietary influences on endogenous ileal protein and amino acid loss in the pig – a review. *Acta Agriculturae Scandinavica* 46 154–164.
- Boisen, S. and Verstegen, M.W.A. (2000) Developments in the measurement of the energy content of feeds and energy utilisation in animals. In: Moughan, P.J., Verstegen, M.W.A. and Visser-Reyneveld, M.I. (eds) *Feed Evaluation Principles and Practice*. Wageningen Pers, Wageningen, The Netherlands, pp. 57–76.
- Bridges, T.C., Turner, L.W., Stahly, T.S., Usry, J.L. and Loewer, O.J. (1992) Modeling the physiological growth of swine, Part I: Model logic and growth concepts. *American Society of Agricultural Engineers* 35, 1019–1028.
- Burlacu, G., Burlacu, R., Columbeanu, I. and Alexandru, G. (1988) Contributions to the study of mathematical modelling of energy and protein balance simulation in non-ruminant animals. *Bulletin of the Academy of Agriculture and Forestry Sciences* 17, 185–200.
- Campbell, R.G. (1985) Effects of sex and genotype on energy and protein metabolism in the pig. In: Cumming, R.B. (ed.) *Recent Advances in Animal Nutrition in Australia*. University of New England, Armidale.
- de Lange, C.F.M. (1995) Framework for a simplified model to demonstrate principles of nutrient partitioning for growth in the pig. In: Moughan, P.J., Verstegen, M.W.A. and Visser-Reyneveld, M.I. (eds) *Modelling Growth in the Pig*. Wageningen Pers, Wageningen, The Netherlands.
- de Lange, C.F.M., Nyachoti, C.M. and Verstegen, M.W.A. (2000) The significance of antinutritional factors in feedstuffs for monogastric animals. In: Moughan, P.J., Verstegen, M.W.A. and Visser-Reyneveld, M.I. (eds) *Feed Evaluation Principles and Practice*. Wageningen Pers, Wageningen, pp. 169–188.
- Dent, J.B. (1972) Technical and economic considerations in diet formulation. In: Cole, D.J.A. (ed.) *Pig Production*. Butterworths, London, pp. 259–277.
- Emmans, G.C. (1986). A model of the food intake, growth and body composition of pigs fed *ad libitum*. *Animal Production* 42, 471.
- Emmans, G.C. (1995) Energy systems and the prediction of energy and feed intakes. In: Moughan, P.J., Verstegen, M.W.A. and Visser-Reyneveld, M.I. (eds) *Modelling Growth in the Pig*. Wageningen Pers, Wageningen, pp. 115–122.
- Ferguson, N.S., Gous, R.M. and Emmans, G.C. (1994) Preferred components for the construction of a new simulation model of growth, feed intake and nutrient requirements of growing pigs. *South African Journal of Animal Science* 24, 10–17.
- Fisher, C. (1994) Responses of laying hens to amino acids. In: D'Mello, J.P.F. (ed.) *Amino Acids in Farm Animal Nutrition*. CAB International, Wallingford, UK, pp. 245–280.

- Folin, O. (1905) A theory of protein metabolism. *American Journal of Physiology* 13, 117–138.
- Fuller, M.F. (1978) Amino acids in the nutrition of the pig. In: *The Rowett Research Institute Annual Report of Studies in Animal Nutrition and Allied Sciences*, Vol. 34, The Rowett Research Institute, Aberdeen, pp. 116–128.
- Fuller, M.F. (1994) amino acid requirements for maintenance, body protein accretion and reproduction in pigs. In: D'Mello, J.P.F. (ed.) *Amino Acids in Farm Animal Nutrition*. CAB International, Wallingford, UK, pp. 155–184.
- Harper, A.E., Benevenga, N.J. and Wohlhueter, R.M. (1970). Amino acid imbalances. *Physiological Reviews* 50, 428–558.
- Heady, E.O. and Dillon, J.L. (1961) *Agricultural Production Functions*. Iowa State University Press, Ames, Iowa.
- Heady, E.O., Balloun, S. and Townsley, R.J. (1966) Co-operative research on input–output relationships in poultry production. *O.E.C.D. Documentation in Agriculture and Food*. No. 81, 125 pp.
- Hodgkinson, S.M. and Moughan, P.J. (2000a). Amino acids: digestibility, availability and metabolism. In: Moughan, P.J., Verstegen, M.W.A. and Visser-Reyneveld, M.I. (eds) *Feed Evaluation Principles and Practice*. Wageningen Pers, Wageningen, pp. 125–132.
- Hodgkinson, S.M. and Moughan, P.J. (2000b) Amino acids – the collection of ileal digesta and characterisation of the endogenous component. In: Moughan, P.J., Verstegen, M.W.A. and Visser-Reyneveld, M.I. (eds) *Feed Evaluation Principles and Practice*. Wageningen Pers, Wageningen, pp. 105–124.
- Hurwitz, S and Bornstein, S. (1973) The protein and amino acid requirements of laying hens: suggested models for calculation. *Poultry Science* 52, 1124–1134.
- Hurwitz S., Frisch, Y., Bar, A., Eisner, U., Bengal, I. and Pines, M. (1983) The amino acid requirements of growing turkeys. 1. Model construction parameter estimation. *Poultry Science* 62, 2208–2217.
- Knap, P.W. (1996) Stochastic simulation of growth in pigs: protein turn-over-dependent relations between body composition and maintenance requirements. *Animal Science* 63, 549–561.
- Knap, P.W. and Schrama, J.W. (1996) Simulation of growth in pigs: approximation of protein turn-over parameters. *Animal Science* 63, 533–547.
- Kyriazakis, I. and Emmans, G.C. (1999) Voluntary food intake and diet selection. In: Kyriazakis, I. (ed.) *A Quantitative Biology of the Pig*. CAB International, Wallingford, UK, pp. 229–248.
- Milligan, L.P. and Summers, M. (1986) The biological basis of maintenance and its relevance to assessing responses to nutrients. *Proceedings of the Nutrition Society*. 45, 185–193.
- Mitchell, H.H. (1959) Some species and age differences in amino acid requirements. In: Albanese, A.A. (ed.) *Protein and Amino Acid Nutrition*. Academic Press, New York, pp. 11–43.
- Morel, P.C.H., Pearson, G., Derix, H., Schutte, B. and Moughan, P.J. (1993) On-farm determination of the upper-limit to body protein deposition in growing pigs. In: Batterham, E.S. (ed.) *Manipulating Pig Production IV*. Australasian Pig Science Association, Canberra, p. 221.
- Moughan P.J. (1981) A model to simulate the utilisation of dietary amino acids by the growing pig (20–100 kg). *Research Bulletin*. Massey University, Palmerston North, New Zealand.
- Moughan, P.J. (1984) Aspects of dietary protein quality for the growing pig. PhD thesis, Massey University, Palmerston North, New Zealand.
- Moughan P.J. (1989) Simulation of the daily partitioning of lysine in the 50kg liveweight pig – a factorial approach to estimating amino acid requirements for growth and maintenance. *Research and Development in Agriculture* 6, 7–14.
- Moughan, P.J. (1995) Modelling protein metabolism in the pig – first principles. In: Moughan, P.J., Verstegen, M.W.A. and Visser-Reyneveld, M.I. (eds) *Modelling Growth in the Pig*. EAAP Publication No. 78. Wageningen Pers, Wageningen, The Netherlands, pp. 59–70.
- Moughan, P.J. (1999) Protein metabolism in the growing pig. In: Kyriazakis, I. (ed.) *A Quantitative Biology of the Pig*. CAB International, Wallingford, UK, pp. 299–331.
- Moughan, P.J. and Rutherford, S.M. (1996) A new method for determining digestible reactive lysine in foods. *Journal of Agricultural and Food Chemistry* 514, 2202–2209.
- Moughan, P.J. and Smith, W.C. (1984) Prediction of dietary protein quality based on a model of the digestion and metabolism of nitrogen in the growing pig. *New Zealand Journal of Agricultural Research* 27, 501–507.
- Moughan, P.J. and Smith, W.C. (1987) A dynamic approach to estimating nutrient requirements for growth in pigs and poultry. *Proceedings of the 4<sup>th</sup> AAAP Animal Science Congress*, Hamilton, New Zealand. Publ. The Organising Committee, AAAP Congress, pp 23–26.
- Moughan, P.J. and Verstegen, M.W.A. (1988) The modelling of growth in the pig. *Netherlands Journal of Agricultural Science* 36, 145–166.

- Moughan, P.J., Smith, W.C. and Pearson, G. (1987) Description and validation of a model simulating growth in the pig (20–90 kg liveweight). *New Zealand Journal of Agricultural Research* 30, 481–489.
- Moughan, P.J., Kerr, R.T. and Smith, W.C. (1995) The role of simulation models in the development of economically-optimal feeding regimens for the growing pig. In: Moughan, P.J., Verstegen, M.W.A. and Visser-Reyneveld, M.I. (eds) *Modelling Growth in the Pig*. Wageningen Pers, Wageningen, pp. 209–222.
- Pettigrew, J.E., Gill, M., France, J. and Close, W.H. (1989) A mathematical model of sow energy and protein metabolism. In: *Energy Metabolism of Farm Animals*. Publication No. 43. European Association of Animal Production, pp. 119–201.
- Phillips, P.A. and MacHardy, F.V. (1982) Modelling protein and lipid gains in growing pigs exposed to low temperature. *Canadian Journal of Animal Science* 62, 109–121.
- Pomar, C., Harris, L. and Minvielle, F. (1991) Computer simulation model of swine production systems. I. Modeling the growth of young pigs. *Journal of Animal Science* 69, 1468–1488.
- Rérat, A. (1972) Protein nutrition and metabolism in the growing pig. *Nutrition Abstracts and Reviews* 42, 13–39.
- Rérat, A. and Lounnon, J. (1968) Amino acid requirements of growing pigs. *World Review of Animal Production* 4 (17), 84–95; 4 (19), 66–74.
- Rivest, J., Bernier, J.F. and Pomar, C. (2000) A dynamic model of protein digestion in the small intestine of pigs. *Journal of Animal Science* 78, 328–340.
- Rutherford, S.M., Moughan, P.J. and Morel, P.C.H. (1997a) Assessment of the true ileal digestibility of reactive lysine as a predictor of lysine uptake from the small intestine of the growing pig. *Journal of Agricultural and Food Chemistry* 45, 4378–4383.
- Rutherford, S.M., Moughan, P.J. and van Osch, L. (1997b) Digestible reactive lysine in processed feed-stuffs: application of a new bioassay. *Journal of Agricultural and Food Chemistry* 45, 1189–1194.
- Seve, B. and Henry, Y. (1995) Protein utilization in non ruminants. In: Nunes, A.F., Portugal, A.V., Costa, J.P. and Ribeiro, J.R. (eds) *Protein Metabolism and Nutrition*, EAAP Publication No. 81, Published EZN, pp. 59–82.
- Smith, W.K. (1978). The amino acid requirements of laying hens: models for calculation. 1 Physiological background. *World's Poultry Science Journal* 34, 81–96.
- Stombaugh, D.P. and Oko, A. (1980). Simulation of nutritional–environmental interactions in growing swine. In: Mount, L.E. (ed.) *Energy Metabolism*. Butterworths, London, pp. 209–215.
- Tess, M.W., Bennett, G.L. and Dickerson, G.E. (1983) Simulation of genetic changes in life cycle efficiency of pork production. *Journal of Animal Science* 56, 336–353.
- van Milgen, J., Quiniou, N. and Noblet, J. (2000) Modelling the relation between energy intake and protein and lipid deposition in growing pigs. *Animal Science* 71, 119–130.
- Watt, D.L., DeShazer, J.A., Ewan, R.C., Harrold, R.L., Mahan, D.C. and Schwab, G.D. (1987) NCCISWINE: housing nutrition and growth simulation model. *Applied Agricultural Research* 2, 218–223.
- Whittemore, C.T. (1983) Development of recommended energy and protein allowances for growing pigs. *Agricultural Systems* 11, 159–186.
- Whittemore, C.T. and Fawcett, R.H. (1974) Model responses of the growing pig to the dietary intake of energy and protein. *Animal Production* 19, 221–231.
- Whittemore, C.T. and Fawcett, R.H. (1976) Theoretical aspects of a flexible model to simulate protein and lipid growth in pigs. *Animal Production* 22, 87–96.
- Whittemore, C.T., Green, D.M. and Knap, P. (2001) Technical review of the energy and protein requirement of growing pigs: protein. *Animal Science* 73, 363–373.

# 12 Amino Acid Utilization for Reproduction in Sows

S.W. Kim<sup>1\*</sup> and R.A. Easter<sup>2</sup>

<sup>1</sup>Department of Animal and Food Sciences, Texas Tech University, Lubbock, Texas, USA; <sup>2</sup>College of Agricultural, Consumer and Environmental Sciences, University of Illinois, Urbana, Illinois, USA

---

## Introduction

Amino acids are essential nutrients which need to be supplied from dietary sources because of continuous protein turnover and catabolism in the body. Amino acids are needed not only for maintenance and growth but also for reproduction in pigs. Pigs receive amino acids from different sources such as numerous kinds of feed ingredients. Feed ingredients contain amino acids that are all unique and different in contents and profiles.

The required amount of dietary amino acids to support reproduction in pigs has been widely investigated. The concept of focusing on the quality of dietary amino acids is, however, relatively less characterized. Identifying ideal profiles of amino acids for breeding pigs has been investigated rather recently. Some of the reasons are due to the complexity of nutrient metabolism and reproduction interaction in breeding pigs. It is too early to conclude that we understand amino acid metabolism in breeding pigs. Intensive research efforts need to be continued in this area.

In this chapter, the currently available information in amino acid metabolism for breeding pigs is reviewed, and a concept of feeding amino acids to breeding pigs is suggested.

## Amino Acids for Developing Gilts

The major objective of feeding amino acids to gilts during the prepubertal period is to support and balance the growth of gilts with reproductive maturity. Gilts in the prepubertal stage gain lean tissue rapidly. However, as gilts approach puberty, lean tissue gain starts decelerating whereas fat tissue gain starts accelerating. Due to the extensive genetic selection of pigs for a high leanness over the last decades, breeding pigs are also leaner than those in 1979 (MLC, 1979, 1999). As consequences of the selection for leanness, growth rate, feed efficiency and mature size have been improved, whereas voluntary feed intake has been reduced (Kanis, 1990; Smith *et al.*, 1991). Genetically increased leanness appears to be unfavourable to reproductive performance through an association with delayed physiological maturity (Kirkwood and Aherne, 1985).

Gilts from five different genetic lines were used in efforts to affect the overall reproductive performance by changing the body composition of gilts through manipulation of dietary protein levels (Stalder *et al.*, 2000). Feeding diets with different protein levels produced females with different lean and fat gains. The effects were inconsistent. For gilts from two genetic lines, dietary

\*E-mail address: sungwoo.kim@ttu.edu



modification influenced reproductive performance quantified as the number of pigs born and litter birth weight. However, these effects were not evident in gilts from three generic lines. This supports the conclusion that nutrition interacts with genotype as it affects reproductive performance of lean-type pigs.

### **Amino acids and onset of puberty**

Gaughan *et al.* (1995, 1997) have described the effects on reproductive maturation of long-term genetic selection for lean. But, the extent to which nutrition directly affects the onset of puberty remains controversial. Some work appears to indicate that there are minimum thresholds for body weight and body composition that must be achieved prior to the onset of puberty (Dickerson *et al.*, 1964; Kirkwood and Aherne, 1985), whereas other work suggests that the gilt must reach a certain age before the advent of puberty (Burnett *et al.*, 1988; Rozeboom *et al.*, 1995).

It is relatively simple to change the fat content of breeding pigs through manipulation of daily energy intake. More complex is the relationship between energy and amino acid intake and the consequent effects on both lean and fat growth. Cia *et al.* (1998) fed diets to the gilts with lysine/energy ratios of 0.9, 0.6 and 0.3 g lysine per MJ DE to test a hypothesis that modification of body composition which favours fat deposition in lean-type gilts would encourage early puberty. However, restricting dietary amino acids to increase body fat content did not improve reproductive performance of lean-type gilts but delayed puberty. Jones and Maxwell (1974) and den Hartog and Verstegen (1990) also found that amino acid restriction during the prepubertal period did not advance the appearance of puberty. Others have reported that providing a low-protein diet during the rearing period depresses growth rate and delays puberty (Wahlstrom and Libal, 1977; Cunningham *et al.*, 1974). Mild amino acid restriction, however, does not appear to influence the age at puberty (den Hartog and van Kempen, 1980).

### **Amino acids and ovulation rate**

Ovulation rate is the initial determinant of litter size (King and Williams, 1984a). Improving ovulation rate through nutritional management has been widely investigated. Providing additional nutrients for 2 weeks before breeding, i.e. flushing, has been shown to increase ovulation rate (Anderson and Melampy, 1972; Hughes and Pearce, 1989; Beltranena *et al.*, 1991) by increasing progesterone level (Prunier *et al.*, 1993) and by increasing the number of large follicles (Dailey *et al.*, 1975). However, flushing to increase ovulation rate is primarily due to energy, not amino acid intake (Aherne and Kirkwood, 1985).

Delaying breeding to the second or third postpubertal oestrus provides time to manipulate feeding to improve ovulation rate (Aherne and Kirkwood, 1985). Whittemore (1996) suggests that well-fed and heavy gilts do not need to delay breeding; it is useful only for young and light-weight gilts.

Whether increasing dietary amino acids affects ovulation rate is not clear. Changing dietary protein levels from 12.5 and 16% did not affect ovulation rate (Zimmerman *et al.*, 1967) and short-term protein deprivation (21 days) had no effect although long-term deprivation decreased ovulation rate (McGillivray *et al.*, 1964). Fowler and Robertson (1954) and Zimmerman *et al.* (1967) demonstrated that providing diets with various amino acid patterns from different protein sources, i.e. animal vs. plant sources, did not affect ovulation rate.

### **Concept of providing amino acids during the prepubertal period**

Balancing dietary amino acid patterns to meet the amino acid needs for gilts is essential for optimizing prepubertal growth and early reproductive maturity. Pioneering work from Fowler and Robertson (1954) found that gilts fed a diet with animal-source proteins, such as meat meal, reached puberty at an earlier age than gilts fed a diet with plant-source proteins, such as soybean meal, indicating that dietary amino acid pattern affects the reproductive performance of gilts. Later Friend (1973)

reevaluated the effect of adding crystalline lysine and methionine to improve the amino acid balance of gilts to reduce the age at puberty. Supplementing crystalline amino acids to improve the performance was not successful mainly because the experimental diets were too deficient in protein (94–97g kg<sup>-1</sup>) to support normal development and because the experimental period was not long enough to obtain the treatment effect. There have been no further investigations to determine if the dietary amino acid pattern during the prepubertal period affects reproductive performance. Recent nutrient requirements from the NRC (1998) do not indicate the ideal amino acid pattern for developing gilts. One is needed to test the hypothesis that the ideal pattern for maximal lean growth also supports optimum reproductive development.

### Amino Acids for Gestating Sows

Providing amino acids to the pigs during gestation should target balancing amino acid needs for various components such as the growth of the fetus, reproductive tract and mammary tissue and, at the same time, optimizing body condition of sows at farrowing as body condition at farrowing is closely related to lactation performance (Baker *et al.*, 1968; Mullan and Williams, 1989; O'Dowd *et al.*, 1997). In the case of first parity sows, the amino acid needs for adequate maternal lean growth should also be considered, whereas mature sows do not need additional amino acids for the maternal gain during gestation. Extensive genetic selection for pigs has resulted in breeding pigs that are leaner and produce larger litters than those in 1979 (MLC, 1979, 1999). The consequences of genetic selection would affect protein metabolism during gestation, in turn, affecting dietary amino acid requirements for improving reproductive performance of sows.

In this section, amino acid nutrition during gestation is discussed in relation to the reproductive performance. Recent research data for feeding amino acids to the lean-type sows during gestation are reviewed in an attempt to assess amino acid requirements and ideal dietary amino acid patterns.

### Amino acids for fetal growth and birth weight

Maternal intake is an important amino acid source for fetal growth and litter birth weight. Amino acids are needed for synthesizing necessary elements for fetal growth such as hormones and nucleotides (Reeds and Hutchens, 1994) as well as for building fetal tissue proteins and peptides. Amino acids are also an important energy source for fetal growth (Bell *et al.*, 1989).

Dwyer and Stickland (1994) investigated the effect of supplemental protein and energy on fetal growth from severely underfed sows during gestation and found that protein supplementation rehabilitated fetal growth more than the effects obtained from energy supplementation. This result agrees with the previous finding from Atinmo *et al.* (1974) who showed that protein restriction caused greater impairment of fetus growth than energy restriction. Pond *et al.* (1991) also demonstrated that severe protein restriction reduced fetus weight at day 50 of gestation as well as birth weight. Maternal body weight was also reduced whereas backfat thickness increased for protein-restricted sows. This result indicates that the effect of maternal protein restriction on fetal growth can be initiated by early- and mid-gestation that is even before the period of most rapid fetal growth (late-gestation). Protein deficiency during early- and mid-gestation affects the fetal growth more detrimentally than during the late-gestation (Pond *et al.*, 1992). Effect of protein restriction on reduced fetal growth can be explained by decreased amino acid concentration in fetal plasma whereas maternal plasma amino acid concentration was not affected (Wu *et al.*, 1998a). Atinmo *et al.* (1976) also demonstrated that maternal protein restriction decreased plasma growth hormone level in the fetus.

Placental development is an important factor in supporting fetal growth. The fetus receives nutrients through placental blood vessels (Ford, 1995; Ott *et al.*, 1997). Placental angiogenesis occurs rapidly during placental development (Reynolds *et al.*, 1992). Knight *et al.* (1977) demonstrated that placental growth was maximized by day 60 of gestation.

Placental growth is affected by maternal protein intake. Wu *et al.* (1998b) showed that severe protein restriction to gilts during gestation decreased placental amino acid content.

The number of fetal muscle fibres is one of key determinants for postnatal growth (Handel and Stickland, 1987; Rehfeldt *et al.*, 1993). Development of fetal muscle fibre is well reviewed by Lefaucheur and Gerrard (1998) and Wigmore and Dungleison (1998). Nutritional modification can alter the number of secondary muscle fibres whereas primary fibre numbers are resistant to environmental influences (Wigmore and Stickland, 1983). It was shown that hyperplasia of muscle fibre was completed by day 90 of gestation. Secondary fibre hyperplasia began at approximately day 50 of gestation in the pig and continues until day 85–90 (Wigmore and Stickland, 1983). Dwyer *et al.* (1994) showed that increasing maternal nutrient intake from day 25 to 50 of gestation increased muscle fibre hyperplasia by 13% and suggested that increasing sow feed intake in early pregnancy may improve the mean postnatal growth rate of the litter in the later growth phases to slaughter. Several other investigators also agree that providing sufficient amino acids before day 60 of gestation is critical for fetal and placental growth (Bazer, 1992; Pond *et al.*, 1992; Scholknecht *et al.*, 1994).

Arginine may be important for fetal growth. Sparks *et al.* (1985) and Wu *et al.* (1999) demonstrated that the rate of arginine deposition to fetal tissue proteins was one of the greatest among amino acids. Arginine was efficiently metabolized to nitric oxide. The metabolic importance of nitric oxide to the fetal growth as an endothelium-derived relaxing factor, a neurotransmitter, and a modulator of the immune response (Wu *et al.*, 1996) makes the role of arginine significant. Reducing the maternal dietary protein level decreased placental free arginine concentration and, therefore, reduced nitric oxide synthesis (Wu *et al.*, 1998c) that may impair placental and endometrial angiogenesis and growth. Wu *et al.* (1998c) suggested that reduced arginine concentration in placenta leads to reduction in placental–fetal blood flow, nutrient supply from mother to fetus, and ultimately fetal growth retardation. Conventional maize and

soybean meal-based diets normally contain arginine abundantly. Whether increasing dietary arginine content raises placental arginine uptake is not known yet.

### Amino acids for mammary gland development

Mammary glands undergo physiological and morphological changes at the onset of pregnancy and grow substantially during gestation. The size of mammary glands increases almost fourfold during gestation as indicated by DNA content (Kensinger *et al.*, 1982), which involves 148 g protein gain per gland. Based on the assumption that sows normally have 14 functional glands, that is 2066 g mammary protein gain during gestation which is calculated as 18 g day<sup>-1</sup> protein. It is then easily calculated that 1.4 g of lysine day<sup>-1</sup> (or 8.1 g of essential amino acids day<sup>-1</sup>) accumulated to mammary tissue during gestation based on the amino acid pattern in mammary tissue from Kim *et al.* (1999a).

Hacker and Hill (1972) and Kensinger *et al.* (1982) indicate that mammary gland growth occurs mostly during days 75–90 of gestation. This suggests that additional amino acid provision during this period may help an optimal mammary gland growth. However, Weldon *et al.* (1990) showed that increased dietary amino acid level during days 75–90 did not affect mammary gland growth.

Kusina *et al.* (1999) fed gilts different levels of amino acids during gestation. Daily lysine intakes were 4, 8 or 16 g day<sup>-1</sup> during gestation. Additional amino acid provision during gestation also failed to improve gestational mammary gland growth (Kusina *et al.*, 1999). Restricting amino acid intake, however, reduced the mammary gland of gilts during gestation (Head and Williams, 1991).

### Concept of providing amino acids during gestation

Characterizing an ideal amino acid pattern (IAAP) for gestating sows is one of the primary factors for improving overall reproduction performance. It is well documented that gestation

nutrition is closely correlated to the performance during lactation. Obese pigs at farrowing possess a low voluntary feed intake during lactation (Yang *et al.*, 1989; Revell *et al.*, 1998a; Sinclair *et al.*, 2001). Low feed intake during lactation results in excessive body tissue loss at weaning which often causes delayed days return to oestrus after weaning or even reproduction failure (King and Dunkin, 1986; Jones and Stahly, 1995). Restricting nutrient intake during gestation to prevent excessive fat deposition is the most popular practice. However, severe feed restriction would not be beneficial either. Obtaining accurate nutrient requirements, therefore, is a key factor for the successful management of gestating sows. An unbalanced amino acid pattern in diets can cause excessive oxidation of amino acids during metabolism by allowing redundant amino acids to be oxidized or deaminated (Voet and Voet, 1990). Thus, employing an IAAP helps to reduce overall amino acid oxidation. Oxidized amino acids are mainly utilized as energy sources and may be used for the fat deposition during gestation. Providing a diet with an IAAP to gestating sows will reduce unnecessary loss of essential amino acids and reduce unnecessary fat deposition. Meanwhile, matching dietary amino acid patterns to the actual needs will also allow an increase of protein deposition in fetal tissue by increasing the efficiency of amino acid uptake by the placenta when one considers that transplacental ratio and fetal

uptakes are unique among amino acids (Eaton *et al.*, 1982; Yudilevich and Sweiry, 1985). It has been demonstrated that fetal tissue uses amino acids as major energy sources (Schaefer and Krishnamurti, 1984; Hatfield *et al.*, 1984), which illustrates that increasing transplacental amino acids would be beneficial for fetal growth.

Thus, applying an IAAP for establishing nutrient requirements of gestating sows will provide a maximal efficiency for fetal growth but minimize unnecessary maternal amino acid oxidation and fat deposition. Accurate estimation of amino acid requirements for gestation will allow nutritionists to set an advanced feeding strategy for gestating sows in relation to improving lactation performance, such as litter weight gain and days return to oestrus. Measuring amino acid needs for gestation should be based on the clear understanding of amino acid changes in metabolically active tissues during gestation. At conception, amino acid metabolism is directed at supporting fetal growth and growth of other related tissues, such as uterus, mammary glands and placenta. Gastrointestinal tract and liver are also important tissues during gestation in that they are intimately involved in amino acid digestion, absorption and metabolism. In the case of gilts or young sows, amino acid metabolism is also directed at supporting maternal growth.

The quantities of amino acids that are needed for tissue accumulation or mainte-

**Table 12.1.** Amino acid patterns in various tissues of sows during gestation<sup>a</sup>.

Tissue	Maternal tissue <sup>b</sup>	Mammary gland <sup>c</sup>	Fetus <sup>d</sup>	Uterus <sup>e</sup>	Placenta <sup>f</sup>
Lysine	100	100	100	100	100
Threonine	44	58	54	58	53
Tryptophan	12	16	18	22	22
Methionine	38	26	31	14	14
Valine	53	75	72	76	49
Isoleucine	51	54	49	52	67
Leucine	84	111	110	109	38

<sup>a</sup>Relative ratio to lysine.

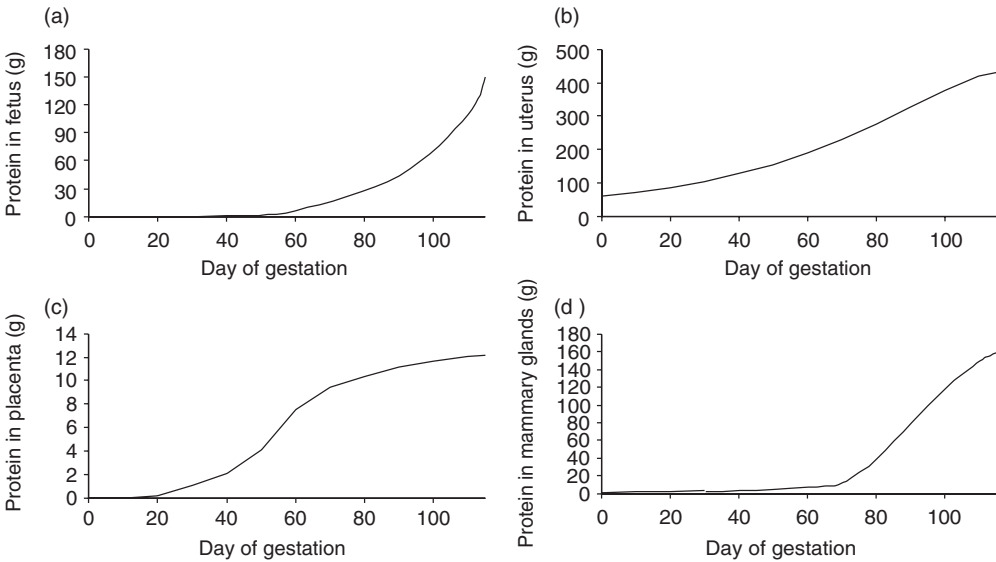
<sup>b</sup>Adapted from Zarkadas *et al.* (1992).

<sup>c</sup>Adapted from Kim *et al.* (1999a).

<sup>d</sup>Adapted from Wu *et al.* (1998a).

<sup>e</sup>Adapted from Kim and Easter (2001).

<sup>f</sup>Adapted from Wu *et al.* (1998b).



**Fig. 12.1.** Protein content in (a) fetus, (b) uterus, (c) placenta, (d) individual mammary glands during gestation in sows. Adapted from (a) Wu *et al.* (1998a), (b) Walker and Young (1993), (c) Wu *et al.* (1998b), (d) Kensinger *et al.* (1982).

nance will differ among tissues and also change as gestation progresses. Amino acid patterns in these tissues differ as well (Table 12.1). Dietary amino acid patterns should consider all of these factors to match the actual amino acid needs during the specific stages of gestation (Fig. 12.1). Components of the amino acid gain from uterus, fetus, placenta, and mammary glands should balance with dietary components together with carcass, gastrointestinal tract and liver. The order of limiting amino acids can be obtained from

the balance between IAAP and major feed ingredients.

Considering both amino acid patterns in various tissues (Table 12.1) and changes of amino acid quantities in various tissues during gestation (Fig. 12.1), ideal dietary amino acid patterns can be estimated. For convenience, gestation was divided into two periods as examples, i.e. 0–70 days and 71–115 days. The amounts of amino acids accumulated into uterus, placenta, fetus, mammary gland and maternal carcass during both periods were

**Table 12.2.** Estimates of ideal dietary amino acid pattern for gestating sows<sup>a</sup>.

Maternal protein gain	Estimation						NRC (1998)	
	2 kg			0 kg			2 kg	0 kg
	day	day	day	day	day	day	day	
Gestational period	0–115	0–70	71–115	0–115	0–70	71–115	0–115	0–115
Lysine	100	100	100	100	100	100	100	100
Threonine	50	48	51	55	56	55	75	83
Tryptophan	16	15	16	19	20	18	19	19
Methionine	32	32	32	27	21	28	25	26
Valine	63	59	65	72	69	72	67	66
Isoleucine	51	52	50	51	54	50	56	57
Leucine	96	88	100	106	96	109	87	82

<sup>a</sup>Based on a scenario that the sow has 11 fetuses.

calculated based on an assumption that amino acid patterns in those tissues do not change during each period (Table 12.2). Estimated patterns suggest a concept that the ideal dietary amino acid pattern is changing depending on the stage of gestation and the amount of maternal protein gain. The most recent and comprehensive concept in ideal amino acid patterns for gestating sows would be estimates from NRC (1998). The ideal dietary amino acid pattern suggested from NRC (1998) stays the same during the whole gestation period and does not respond sensitively to the level of maternal protein gain. Based on a simple calculation in Table 12.2, it is shown that the ideal dietary amino acid pattern from NRC (1998) does not represent the actual amino acid needs for gestating sows. The problem in the NRC ideal amino acid pattern is that the suggested ideal pattern is a fixed and single profile and does not consider changes of growth rates among individual tissues as gestation progresses.

Wu *et al.* (1998b) measured the actual amounts of each amino acid taken up by the uterus during gestation (Table 12.3). When the ratios for the actual amino acid accretion in the fetus, uterus and placenta are considered, lysine was used most efficiently for tissue accretion followed by valine and isoleucine. Factors for uterine amino acid uptake need to be further investigated and identifying those factors will improve accuracy in estimating amino acid requirements in gestating sows.

Assessing detailed information on changes of amino acid quantities and patterns

in the uterus, placenta, fetus and mammary glands, as well as maternal carcass, gastrointestinal tract, liver and other viscera during different stages of gestation will provide an important basis for estimating an accurate ideal dietary amino acid pattern for gestating sows. At this time, however, it is a hypothesis that the ideal dietary amino acid pattern is dynamic as gestation progresses.

### Amino Acids for Lactating Sows

Lactation is physiologically and nutritionally unique and distinct from other stages of a pig's life. During lactation, amino acid metabolism is directed favourably to milk production through mammary glands. When there are not enough amino acids available from dietary sources, a sow starts mobilizing her body protein to provide amino acids for synthesizing milk protein. Excessive tissue protein mobilization during lactation reduces the sow's body condition that impairs the normal reproductive performance for the subsequent parities, such as delayed return to oestrus, reduced litter size in subsequent litters, or even reproduction failure (Reese *et al.*, 1982; King and Williams, 1984; Kirkwood *et al.*, 1987). Focusing lactation feeding strategies on minimizing weight loss is, therefore, important.

During lactation, a common problem in sow management is low voluntary feed intake, especially for the primiparous sows. In addition, genetic selection for high milk production

**Table 12.3.** Amino acid uptake by uterus and the amount of amino acids used for tissue accretion.

	Uterine amino acid uptake <sup>a</sup>		Amino acid pattern from tissue accretion <sup>c</sup> (% <sup>b</sup> )	% <sup>b</sup> of amino acid accretion (uptake/accretion)
	mg day <sup>-1</sup> fetus <sup>-1</sup>	% <sup>b</sup>		
Lysine	762	100	100	100
Threonine	482	63	55	115
Tryptophan	204	27	19	142
Methionine	245	32	27	119
Valine	585	77	71	108
Isoleucine	416	55	51	108
Leucine	1031	135	105	129

<sup>a</sup>Adapted from Wu *et al.* (1998b).

<sup>b</sup>Relative ratio to lysine.

<sup>c</sup>Adapted from Table 12.2 and Fig. 12.1. Tissues include fetus, uterus and placenta.

and large litter size has burdened sows to deplete amino acids to support increased milk protein synthesis. Low dietary amino acid intake in relation to the increased milk protein synthesis causes a massive tissue protein mobilization during lactation. Lactating sows are, therefore, often in a catabolic status until weaning. To prevent excessive and extensive amino acid catabolism during lactation, one strategy will be to increase amino acid intake. Designing a nutritionally well-balanced 'ideal' diet for lactating sows would be another important strategy. The goals of these strategies should not be limited to maximizing milk production for nursing pigs but also should be extended to maintaining optimum body condition for normal or improved reproductive performance. In designing a diet with an ideal amino acid pattern for lactating sows, clear understanding of amino acid requirements is a critical starting point. In this section, the role of amino acids in the metabolism of lactating sows is discussed, especially focusing on reproductive performance. A concept in designing an ideal lactation diet is also discussed.

### Amino acids for mammary gland growth

The mammary glands are the key tissue organ that cannot be ignored in discussing lactating sows because of their metabolic importance in synthesizing and secreting milk that is directly related to litter weight gain and litter weaning weight. Mammary glands take up amino acids from the bloodstream, synthesize milk proteins and secrete milk to nursing pigs. Understanding the metabolism and biology of mammary glands is, therefore, a crucial initial point for improving reproductive performance of lactating sows and overall swine production.

At the onset of parturition, the mammary gland undergoes major physiological changes. Mammary epithelial cells actively synthesize and secrete milk into lumen that is then released to nursing pigs. During colostrum secretion, lactation is continuous but it becomes periodic within a couple of days after farrowing as colostrum secretion ends and milk secretion begins. As sows milk periodically, their nursing pigs establish a unique

teat order which is relatively strong (McBride, 1963; De Passille and Rushen, 1989). Some mammary glands are used by nursing pigs whereas the other remaining glands are not being used. The numbers of lactating and non-lactating mammary glands depends on litter size and total number of mammary glands. Suckled mammary glands are functional and continue to lactate, whereas non-suckled mammary glands undergo substantial regression during the first 7–10 days of lactation (Kim *et al.*, 2001a). A lactating mammary gland clearly continues to grow as lactation continues (Kim *et al.*, 1999a).

It has been shown that  $1.0 \text{ g day}^{-1}$  of lysine (or  $7.0 \text{ g day}^{-1}$  of essential amino acids) is incorporated into mammary tissue protein for sows with ten nursing pigs (Kim *et al.*, 1999a). However, the actual amount of amino acids needed for the tissue growth would be higher than that deposited in mammary tissue protein. Regressing non-suckled mammary glands may provide a small amount of lysine ( $0.4 \text{ g day}^{-1}$  or  $2.1 \text{ g essential amino acids day}^{-1}$ ) to other suckled lactating mammary glands (Kim *et al.*, 2001a). Trottier *et al.* (1997) measured the amount of essential amino acids taken up by mammary glands ( $188.5 \text{ g day}^{-1}$ ), secreted as milk proteins ( $139.5 \text{ g day}^{-1}$ ), and finally retained in mammary gland ( $49.0 \text{ g day}^{-1}$ ). It is, then, calculated that only 14% of essential amino acids were actually used for tissue growth (Kim *et al.*, 1999a) and the remaining 76% of essential amino acids was either transformed to other non-essential amino acids or oxidized as energy sources (Richert *et al.*, 1998). For individual amino acids, oxidation rates were different among essential amino acids (Table 12.4). It was shown that branched-chain amino acids are highly oxidizable relative to other essential amino acids in mammary glands. High oxidation rate in valine suggests that sows may need a higher valine requirement ( $11.5 \text{ g kg}^{-1}$ ) than the requirement from NRC recommendation (Richert *et al.*, 1996; NRC, 1998).

The amount of amino acids in lactating mammary glands increases during lactation as mammary glands grow continuously (Kim *et al.*, 1999a). However, mammary amino acids increase at different rates depending on the stage of lactation (Kim *et al.*, 2000a). In a

**Table 12.4.** Amino acids retained or accumulated in mammary gland of lactating sows<sup>a</sup>.

	Retained EAA (g day <sup>-1</sup> )	Tissue EAA (g day <sup>-1</sup> )	Oxidation rate (%)
Lysine	3.2	1.01	68.2
Threonine	4.8	0.56	88.4
Tryptophan	0.8	0.15	80.0
Methionine	1.7	0.28	83.2
Valine	6.9	0.79	88.5
Leucine	12.9	1.16	91.0
Isoleucine	7.4	0.58	92.2

<sup>a</sup>Adapted from Trottier *et al.* (1997) and Kim *et al.* (1999a).

normal nutritional status, growth rate is maximized during the first 2 weeks of lactation, and then slows down until weaning.

The amount of dietary amino acids affects mammary gland growth. It has been shown that amino acid and energy intakes during lactation affect the growth of mammary glands (Kim *et al.*, 1999b). Mammary gland growth in lactating sows was maximized when a sow consumed 55 g total lysine and 70.7 MJ ME per day during lactation. Suggested energy requirement is about the same level as suggested by NRC (1998), whereas lysine (or essential amino acids) requirement for maximal mammary gland growth was about 10% higher than the NRC recommendation. One explanation for this difference is that the NRC recommendation did not consider amino acid needs for mammary gland growth in establishing requirements that were shown to be between 3.2 and 7.14 g day<sup>-1</sup> (Trottier *et al.*, 1997; Kim *et al.*, 1999a). Jackson *et al.* (2000) and Hurley *et al.* (2000) reported that the cellular transport systems for lysine and valine should not be limiting factors in lysine and valine uptakes suggesting that increased dietary amino acids would increase amino acid uptake by mammary cells that can be used for tissue and milk protein synthesis. However, increasing intakes of specific amino acids should be achieved with a consideration of the balance with other essential amino acids.

Sows with different litter sizes had different rates of mammary gland growth during lactation. For the sows with the larger litter size, i.e. up to 12, the growth of individual

suckled mammary glands were smaller than sows with smaller litter size, i.e. down to 6, whereas the total size of suckled mammary glands was definitely greater (Kim *et al.*, 1999c). There was a 0.13 g lysine (or 0.80 g essential amino acids) increase in mammary tissue for one pig increase to a litter during 21 day lactation. Amino acid needs for an increased litter would be greater when amino acid oxidation is considered. Nielsen *et al.* (1997) measured the changes of amino acid quantity taken up by mammary glands from the sows with different litter sizes. Considering Nielsen's data, amino acid needs for additional pigs in the litter would be higher than actual tissue accumulation (Table 12.5).

Lactational mammary gland growth was also affected by the anatomical location of each mammary gland in the sow. The first five pairs of suckled mammary glands grew faster than other posterior glands during lactation and pigs that suckled the first five pairs of mammary glands also grew faster than other pigs during lactation (Kim *et al.*, 2000b). There was a clear relationship between protein content in suckled mammary gland and the growth of pigs during lactation (Kim *et al.*, 2000b; Nielsen *et al.*, 2001) indicating benefits of encouraging mammary gland growth during lactation for improving pig production.

#### **Amino acids for milk production and litter growth**

Milk production is relatively unaffected by dietary protein restriction because a sow has a



**Table 12.5.** Amino acid use by mammary gland as litter size increased (g day<sup>-1</sup>). (Adapted from Kim *et al.*, 1999c, and Nielsen *et al.*, 1997.)

	Lys	Thr	Trp	Met	Val	Leu	Ile
Tissue	0.13	0.18	0.05	0.08	0.24	0.35	0.17
Uptake	1.92	1.00	–	0.47	1.35	2.08	0.83

remarkable capacity to buffer by mobilizing her body protein to support amino acids needed for milk protein synthesis (Revell *et al.*, 1998b). However, severe protein restriction during lactation caused decreased milk production (Brendemuhl *et al.*, 1987; King *et al.*, 1993; Knabe *et al.*, 1996; Jones and Stahly, 1999). Milk production also responded to a high protein diet to a certain degree (King *et al.*, 1993). In attempting to increase milk production through high protein diet, it will be important to consider the balance of dietary amino acids especially among limiting essential amino acids (Knabe *et al.*, 1996; Copper *et al.*, 2001). Dietary protein fortification through stomach cannula did not increase milk production but instead decreased maternal tissue loss during lactation (Pluske *et al.*, 1998).

Amino acid content in the milk is relatively consistent. Mature sow milk contains 5.2% protein (Tilton *et al.*, 1999; Renaudeau and Noblet, 2001) which is substantially higher than in bovine milk. Milk protein contains a unique amino acid pattern that is synthesized in mammary epithelial cells.

Mammary glands take up amino acids from the bloodstream for milk synthesis. Amino acid patterns among different pools are shown in Table 12.6. It can be easily seen that the amino acid pattern in the bloodstream (Wu *et al.*, 1999) and the amino acid pattern taken up by the mammary glands (Trottier *et al.*, 1997) are different (Table 12.6). The differences in amino acid patterns among different pools indicate that amino acid transporters in mammary tissue may have specific efficiencies for each amino acid. However, the amino acid pattern in milk (King *et al.*, 1993) and those in mammary tissue (Kim *et al.*, 1999a) are very similar. Unique amino acid patterns in various amino acid pools are important components in constructing a concept of feeding lactating sows that will be discussed later in this chapter.

### Amino acids for optimal body condition

As mentioned earlier, lactation is a unique period when metabolic flow is primarily directed to milk production. In a situation

**Table 12.6.** Typical amino acid patterns in milk, mammary tissue and plasma<sup>a</sup>.

	Milk <sup>b</sup>	Mammary tissue <sup>c</sup>	Retained in mammary gland <sup>d</sup>	Plasma <sup>e</sup>
Lysine	100	100	100	100
Threonine	59	58	150	86
Tryptophan	77	78	25	69
Methionine	114	116	53	32
Valine	60	58	216	166
Leucine	56	58	403	164
Isoleucine	65	89	231	72

<sup>a</sup>Values are relative to lysine.

<sup>b</sup>Adapted from King *et al.* (1993).

<sup>c</sup>Adapted from Kim *et al.* (1999a).

<sup>d</sup>Adapted from Trottier *et al.* (1997).

<sup>e</sup>Adapted from Wu *et al.* (1999); plasma samples obtained from uterine artery.

when sows do not receive enough dietary amino acids, maternal tissue amino acids are mobilized from the body tissues to support milk production. Excessive maternal protein mobilization often results in reproduction failure for the next parity (Reese *et al.*, 1982; King and Dunkin, 1986; Jones and Stahly, 1995). Establishing nutrient requirements for lactating sows, therefore, is not limited to maximizing milk yield for nursing pigs, but extends also to maintaining optimum body condition for subsequent parities (Noblet *et al.*, 1990; Pettigrew *et al.*, 1992; NRC, 1998).

Offering a low protein diet or restricting amino acid intake in sows during lactation, clearly increased weight loss during lactation (Brendemuhl *et al.*, 1989; Jones and Stahly, 1999; Kim and Easter, 2001). Decreasing lysine content in a lactation diet also increased protein mobilization during lactation (Touchette *et al.*, 1998). Amino acid mobilization occurs from various tissues of the sows at different rates (Brendemuhl *et al.*, 1989; Escobar, 1998; Kim and Easter, 2001). Muscle is the major amino acid donor during mobilization, whereas the reproductive tract contributes the largest portion of its amino acids (Kim and Easter, 2001).

Dourmad *et al.* (1998) reported that high-producing sows need at least 55 g day<sup>-1</sup> of dietary lysine for the minimal weight loss and 45 g day<sup>-1</sup> of dietary lysine is needed for the normal sows and these requirements are close to the lysine requirement for the maximal mammary gland growth (55 g day<sup>-1</sup>) suggested by Kim *et al.* (1999b). However, keeping sows in an anabolic status during lactation did not show any benefit to improve sow's fertility (Zak *et al.*, 1998). Thus, the target should be minimizing excessive body weight loss rather than keeping sows in an anabolic status. It has been shown that the effect of increasing protein intake during mid- or late-lactation on decreased lactation weight loss was greater than the effect of increasing protein intake during early lactation (Koketsu *et al.*, 1997). This may reflect the fact that catabolism is more severe during late-lactation than during early-lactation due to higher milk production during late-lactation.

### Amino acids for return to oestrus

The number of days return-to-oestrus is closely related to a sow's body condition at weaning. When sows lose significant tissue proteins through mobilization during lactation, they often show delayed return-to-oestrus or, in extreme cases, shut down the reproduction cycle (Reese *et al.*, 1982; Mullan and Williams, 1989; Jones and Stahly, 1995). King and Dunkin (1986) demonstrated that both low energy and low protein intakes lengthened the number of days return-to-oestrus and, from an extensive review, King (1987) concluded that the primary nutritional factor influencing days return-to-oestrus is maternal protein loss related to low amino acid intake. Low amino acid intake during lactation impaired follicular development and maturation during the pro-oestrus period (Yang *et al.*, 2000). Increasing protein intake during lactation reduced the number of days return-to-oestrus and that improvement was greater when intake was increased during mid-lactation rather than late-lactation (Koketsu *et al.*, 1997).

Luteinizing hormone (LH) may be a more fundamental driving factor related to the length of days return-to-oestrus by affecting progesterone release, ovulation and oestrus activity (Parvizi *et al.*, 1976). Amino acid intake influences circulatory LH. Sows with a low protein intake had a low circulatory LH (Kirkwood *et al.*, 1990; Baidoo *et al.*, 1992a; Mullan *et al.*, 1992) and the circulatory LH level was negatively related to the number of days return-to-oestrus (Shaw and Foxcroft, 1985; Tokach *et al.*, 1992; Baidoo *et al.*, 1992b).

### Concept of providing amino acids during lactation: ideal protein

As mentioned in Chapter 9, an ideal protein is the profile of amino acids that would be perfectly in 'harmony' with the pig's requirement that is a perfect balance. After Dr H.H. Michell at the University of Illinois developed the concept of ideal protein in the 1930s, there has been a large amount of research done to identify ideal protein in swine diets.

The concept of ideal protein for lactating sows was understood and established more recently than those for pigs in other stages of life. Nutritional and physiological complexity may have contributed to the lack of research data and delayed identifying an ideal protein for lactating sows. A more comprehensive ideal amino acid pattern for lactating sows was suggested in the recent publication by NRC (1998). The NRC recommendation for ideal protein was established mainly based on four sets of data (Monegue *et al.*, 1993; Pettigrew, 1993; Boyd *et al.*, 1995; Richert *et al.*, 1996) considering amino acid needs for maintenance, milk production and contributions from the sow's body. The ideal dietary amino acid pattern for lactating sows from the NRC (1998) is a fixed, single amino acid profile.

Recent research from the University of Illinois introduces a new concept of ideal protein, the so-called 'Dynamic Ideal Protein' for lactating sows that reflects changes in limiting order of essential amino acids. Kim *et al.* (2001b) identified an ideal dietary amino acid pattern for lactating sows with the concept that different amino acid patterns among tissue protein, milk protein and dietary protein would affect the ideal amino acid pattern during lactation. As it is shown in Table 12.7, the content of some essential

amino acids in milk protein is relatively higher than those in amino acids from tissue mobilization and in a common maize-soybean meal-based diet. Amino acids needed for mammary gland growth would also affect the ideal dietary amino acid pattern. Considering these factors, the ideal dietary amino acid patterns for lactating sows are 'dynamic' responding to the expected maternal protein loss during lactation (Table 12.8). The body condition and expected level of amino acid mobilization are important factors that must be considered in designing diets for lactating sows. The application of the Dynamic Ideal Protein concept would allow a more precise estimation of amino acid needs for lactating sows. For sows possessing a low voluntary feed intake and substantial tissue mobilization during lactation, threonine is a critical amino acid, whereas valine becomes increasingly important for sows having a high feed intake and limited tissue mobilization during lactation (Kim *et al.*, 2001b). However, lysine is the primary limiting amino acid in both cases. To apply the dynamic ideal protein pattern and the order of limiting amino acids, lactation diets can be designed for individual cases based on the expected mobilization levels of sows during lactation.

**Table 12.7.** Amino acid patterns relative to lysine from tissue mobilization, milk protein, mammary tissue gain, and maize-soybean meal-based lactation diet<sup>a</sup>. (Adapted from Kim *et al.*, 2001a.)

	Tissue mobilization <sup>b</sup>	Milk production <sup>c</sup>	Mammary gland growth <sup>d</sup>	Dietary source <sup>e</sup>
Lysine	100	100	100	100
Threonine	42	59	58	70
Valine	77	77	78	90
Leucine	101	114	116	176
Isoleucine	59	60	58	78
Phenylalanine	56	56	58	95
Arginine	124	65	89	125
Histidine	43	40	35	53

<sup>a</sup>Numbers are relative ratios to lysine.

<sup>b</sup>Relative ratio from the summation of each essential amino acid mobilized from carcass, gastrointestinal tract, liver, reproductive tract and other viscera.

<sup>c</sup>Adapted and modified from King *et al.* (1993).

<sup>d</sup>Adapted from Kim *et al.* (1999a).

<sup>e</sup>Amino acid ratio relative to lysine that is provided in a conventional maize-soybean meal diet (711 g kg<sup>-1</sup> maize and 228 g kg<sup>-1</sup> soybean meal containing 170 g kg<sup>-1</sup> CP and 8.7 g kg<sup>-1</sup> lysine) based on true ileal amino acid digestibility values for lactating sows (Stein *et al.*, 1999, 2001).

**Table 12.8.** Ideal dietary amino acid patterns and the order of limiting amino acids for lactating sows.

	Level of tissue mobilization					
	Kim <i>et al.</i> (2001b)					NRC (1998) <sup>a</sup>
	100% <sup>b</sup>	80%	40%	10%	0%	100 to 0%
Ideal amino acid pattern relative to lysine						
Lysine	100	100	100	100	100	100
Threonine	75	69	63	60	59	62
Valine	78	78	78	77	77	85
Leucine	128	123	118	115	115	114
Isoleucine	60	59	59	59	59	56
Phenylalanine	57	57	56	56	56	54
Arginine	22	38	59	69	72	56
Histidine	34	36	38	38	39	41
Order of limiting amino acids <sup>c</sup>						
First-limiting	Thr	Lys	Lys	Lys	Lys	Lys
Second-limiting	Lys	Thr	Thr	Val	Val	Val
Third-limiting	Val	Val	Val	Thr	Thr	Thr

<sup>a</sup>Ideal amino acid pattern from NRC (1998) does not respond to the level of tissue mobilization.

<sup>b</sup>100% level means when about 50% of amino acids in milk were quantitatively equivalent to the amount of amino acids from tissue protein mobilization.

<sup>c</sup>Based on assumption that sows were provided maize (710 g kg<sup>-1</sup>) and soybean meal (230 g kg<sup>-1</sup>) based diet.

### Amino Acids for Sows During the Postweaning Period

After weaning, milk production shuts down as involution of mammary tissue occurs within 7 days (Atwood and Hartmann, 1995; Ford *et al.*, 2000) and sows are ready for return to the oestrus cycle. During the postweaning period, sows can have a chance to recover from tissue amino acid depletion during lactation. If sows receive a sufficient amount of amino acids through the diet, their metabolism can be redirected toward tissue protein gain from catabolic status.

Whether increasing amino acid intake during the postweaning period affects the number of days return-to-oestrus is not well understood. Increasing protein intake shortened the days return-to-oestrus (Brooks and Cole, 1972) whereas other reports showed no effect on the length of days return-to-oestrus (Brooks *et al.*, 1975; King and Williams, 1984b). Extensive studies from Texas Tech University showed no improvement in shortening days return-to-oestrus by increasing protein intake in multiparous sows, however, there was a tendency to

decrease the length in the case of primiparous sows (Tribble and Orr, 1982). It is possible that one reason for this inconsistency can be from the different metabolic status of sows during lactation. Sows with a moderate amino acid catabolism during lactation may respond to postweaning protein intake more sensitively than sows with a good lactation protein intake. Primiparous sows, which normally have a lower appetite than multiparous sows may respond to postweaning dietary amino acid level whereas multiparous sows do not. The nutritional status of sows during lactation, therefore, should be considered in understanding the effect of the postweaning dietary amino acid level on the number of days return-to-oestrus. A comprehensive study by Baidoo *et al.* (1992a) showed that postweaning dietary amino acid level did not affect the number of days return-to-oestrus of multiparous sows when lactation protein intake was the same but lactation protein intake affected the days return-to-oestrus (Table 12.9).

It is clear that providing sufficient amino acids during the postweaning period would affect the ovulation rate in primiparous sows.

**Table 12.9.** Lactation performance of sows as affected by the levels of protein intake. (Adapted from Baidoo *et al.*, 1992a.)

Lactation	Full-fed (F; 5.5 kg day <sup>-1</sup> )		Restricted (R; 3.0 kg day <sup>-1</sup> )		SD
	F (4.7 kg day <sup>-1</sup> )	R (3.0 kg day <sup>-1</sup> )	F (5.2 kg day <sup>-1</sup> )	R (3.0 kg day <sup>-1</sup> )	
Lactation wt loss (kg)	16.3 <sup>a</sup>	15.9 <sup>a</sup>	38.9 <sup>b</sup>	39.2 <sup>b</sup>	2.3
Days return-to-oestrus	6.0 <sup>a</sup>	5.9 <sup>a</sup>	7.1 <sup>b</sup>	7.5 <sup>b</sup>	1.8

<sup>a,b</sup> $P < 0.05$ .

Increasing dietary protein improved ovulation rate (Anderson and Melampy, 1972; King and Williams, 1984b) and increased litter size (Brooks and Cole, 1972). However, others reported no improvement in ovulation rate (Baidoo *et al.*, 1992a) or litter size (Dyck, 1974) of multiparous sows.

It seems that postweaning protein intake does not affect the reproductive performance of multiparous sows (Dyck, 1972; Brooks *et al.*, 1975). When it is considered that the 'modern' high-prolific sows are lean and have a low appetite especially during the first parity, amino acid provision for primiparous sows during the postweaning period can be more emphasized than that for multiparous sows. However, there is not much information available for characterization of the effects of postweaning feeding on the modern high-prolific multiparous sows. This will be one of the areas to be investigated to improve swine productivity in general.

Sufficient tissue protein gain may be closely related to improvement of the reproductive performance in the long term. Practically, full feeding is often applied to the sows during the postweaning period, but the research data do not consistently support the benefits of this practice.

## Conclusions

Amino acids are important essential nutrients that affect overall reproductive performance of breeding pigs. Recent genetic selection challenges nutritionists to update or reevaluate amino acid requirements for breeding pigs. Establishing amino acid requirements should consider balancing the pattern among amino acids as well as quantity of those

amino acids. Ideal dietary amino acid patterns for gestating and lactating sows are newly established concepts. However, those suggestions often include assumptions and omissions and do not clearly represent various scenarios that breeding pigs face at practical production settings. Ideal dietary amino acids for gestating and lactating sows should be further defined.

Recent research data suggest that the ideal dietary amino acid pattern is not fixed but rather changes as gestation or lactation progresses and as maternal condition changes. Factors affecting those ideal dietary amino acid patterns during gestation and lactation need to be determined. Identification of those factors, such as age, genetics, stages of gestation or lactation, will allow an accurate determination of ideal dietary amino acid patterns for breeding pigs. New feeding strategies for breeding pigs need to be designed to effectively apply this defined ideal dietary amino acid pattern to real swine production. For instance, separating sows into different groups based on their maturity or body condition at farrowing can practically facilitate the application of dynamic ideal dietary amino acid patterns to a group of lactating sows in a commercial setting. Applying a phase feeding programme during gestation, which provides diets with different amino acid profiles for each stage of gestation, can also facilitate a practical application of dynamic ideal dietary amino acid patterns for gestating sows. Feeding breeding pigs with a programme including accurate nutrient requirements and ideal dietary amino acid patterns based on the clear understanding of metabolism and biology of pigs will improve overall efficiency of swine production.

## References

- Aherne, F.X. and Kirkwood, R.N. (1985) Nutrition and sow prolificacy. *Journal of Reproduction and Fertility* 33, 169–183.
- Anderson, L.L. and Melampy, R.M. (1972) Factors affecting ovulation rate in the pig. In: Cole, D.J.A. (ed.) *Pig Production*. Butterworth, London, pp. 329–366.
- Atinmo, T., Pond, W.G. and Barnes, R.H. (1974) Effect of maternal energy vs. protein restriction on growth and development of progeny in swine. *Journal of Animal Science* 39:703–711.
- Atinmo, T., Baldijao, C., Pond, W.G. and Barnes, R.H. (1976) Decreased dietary protein or energy intake and plasma growth hormone levels of the pregnant pig, its fetuses and developing progeny. *Journal of Nutrition* 106, 940–946.
- Atwood, C.S. and Hartmann, P.E. (1995) The assessment of mammary gland metabolism in the sow: III. Cellular metabolites in the mammary secretion and plasma during weaning. *Journal of Dairy Research* 62, 221–236.
- Baidoo, S.K., Lythgoe, E.S., Kirkwood, R.N., Aherne, F.X. and Foxcroft, G.R. (1992a) Effect of lactation feed intake on endocrine status and metabolite levels in sows. *Canadian Journal of Animal Science* 72:799–807.
- Baidoo, S.K., Aherne, F.X., Kirkwood, R.N. and Foxcroft, G.R. (1992b). Effect of feed intake during lactation and after weaning on sow reproductive performance. *Canadian Journal of Animal Science* 72, 911–917.
- Baker, D.H., Becker, D.E., Norton, H.W., Sasse, C.E., Jensen, A.H. and Harmon, B.G. (1968) Reproductive performance and progeny development in swine as influenced by feed intake during pregnancy. *Journal of Nutrition* 97, 489.
- Bazer, F.W. (1992) Mediators of maternal recognition of pregnancy in mammals. *Proceedings of the Society for Experimental Biology and Medicine* 199, 373–384.
- Bell, A.W., Kennaugh, J.M., Battaglia, F.C. and Meschia, G. (1989) Uptake of amino acids and ammonia at mid-gestation by the fetal lamb. *Quarterly Journal of Experimental Physiology* 74, 635–643.
- Beltranena, E., Foxcroft, G.R., Aherne, F.X. and Kirkwood, R.N. (1991) Endocrinology of nutritional flushing gilts. *Canadian Journal of Animal Science* 71, 1063–1071.
- Boyd, R.D., Kensingler, R.S., Harrell, R.J. and Bauman, D.E. (1995) Nutrient uptake and endocrine regulation of milk synthesis by mammary tissue of lactating sows. *Journal of Animal Science* 73 (Suppl. 2), 36–54.
- Brendemuhl, J.H., Lewis, A.J. and Peo, E.R. Jr (1987) Effect of protein and energy intake by primiparous sows during lactation on sow and litter performance and sow serum thyroxine and urea concentrations. *Journal of Animal Science* 64, 1060–1069.
- Brendemuhl, J.H., Lewis, A.J. and Peo, E.R. Jr (1989) Influence of energy and protein intake during lactation on body composition of primiparous sows. *Journal of Animal Science* 67, 1478–1488.
- Brooks, P.H. and Cole, D.J.A. (1972) Studies in sow reproduction. 1. The effect of nutrition between weaning and remating on the reproductive performance of primiparous sows. *Animal Production* 15, 259–264.
- Brooks, P.H., Cole, D.J.A., Rowlinson, P., Croxson, V.J. and Luscombe, J.R. (1975) Studies in sow reproduction. 3. The effect of nutrition between weaning and remating on the reproductive performance of multiparous sows. *Animal Production* 20, 407–412.
- Burnett, P.J., Walker, N. and Kilpatrick, D.J. (1988) The effect of age and growth traits on puberty and reproductive performance in the gilts. *Animal Production* 46, 427–436.
- Cia, M.C., Edwards, S.A., Glasgow, V.L., Shanks, M. and Fraser, H. (1998) Modification of body composition by altering the dietary lysine to energy ratio during rearing and the effect on reproductive performance of gilts. *Animal Science* 66, 457–463.
- Copper, D.R., Patience, J.F., Zijlstra, R.T. and Rademacher, M. (2001) Effect of nutrient intake in lactation on sow performance: determining the threonine requirement of the high-producing lactating sow. *Journal of Animal Science* 79, 2378–2387.
- Cunningham, P.J., Naber, C.H., Zimmerman, D.R. and Peo, E.R. Jr (1974) Influence of nutritional regime on age at puberty in gilts. *Journal of Animal Science* 39, 63–67.
- Dailey, R.A., Clark, J.R., First, N.L., Chapman, A.B. and Casida, L.E. (1975) Effect of short-term 'flushing' on follicular development at estrus and ovulation rate of gilts of different genetic groups. *Journal of Animal Science* 41, 842–847.
- den Hartog, L.A. and van Kempen, G.J.M. (1980) Relation between nutrition and fertility in pigs. *Netherlands Journal of Agricultural Science* 28, 211–227.

- den Hartog, L.A. and Verstegen, M.W.A. (1990) Nutrition of gilts during rearing. *Pig News and Information* 11, 523–525.
- DePassille, A.M.B. and Rushen, J. (1989) Suckling and teat disputes by neonatal piglets. *Applied Animal Behavioural Science* 22, 23–38.
- Dickerson, J.W.T., Gresham, G.A. and McCance, R.A. (1964) The effect of undernutrition and rehabilitation on the development of reproductive organs: pigs. *Journal of Endocrinology* 29, 11–XX.
- Dourmad, J.Y., Noblet, J. and Etienne, M. (1998) Effect of protein and lysine supply on performance, nitrogen balance, and body composition changes of sows during lactation. *Journal of Animal Science* 76, 542–550.
- Dwyer, C.M. and Stickland, N.C. (1994) Supplementation of a restricted maternal diet with protein or carbohydrate alone prevents a reduction in fetal muscle fibre number in the guinea-pig. *British Journal of Nutrition* 72, 173–180.
- Dwyer, C.M., Stickland, N.C. and Fletcher, J.M. (1994) The influence of maternal nutrition on muscle fiber number development in the porcine fetus and on subsequent postnatal growth. *Journal of Animal Science* 72, 911–917.
- Dyck, G.W. (1972) Effects of postweaning level of feeding on return to estrus in sows. *Canadian Journal of Animal Science* 52, 570–572.
- Dyck, G.W. (1974) The effects of stage of pregnancy, mating at the first and second estrus after weaning and level of feeding on fetal survival in sows. *Canadian Journal of Animal Science* 54, 277–285.
- Eaton, B.M., Mann, G.E. and Yudilevich, D.L. (1982) Transport specificity for neutral and basic amino acids at maternal and fetal interfaces of the guinea-pig placenta. *Journal of Physiology* 328, 245–258.
- Escobar, J. (1998) Modeling changes in the body composition of primiparous lactating sows as affected by four dietary regimes. M.S. thesis. University of Illinois, Urbana.
- Ford, J.A. Jr, Kim, S.W. and Hurley, W.L. (2000) Postweaning changes in the porcine mammary gland parenchymal wet weight. *Journal of Animal Science* 78 (Suppl. 1), 166 (Abstr.).
- Ford, S.P. (1995) Control of blood flow to the gravid uterus of domestic livestock species. *Journal of Animal Science* 73, 1852–1860.
- Fowler, S.H. and Robertson, E.L. (1954) Some effects of source of protein and antibiotic on reproductive performance in gilts. *Journal of Animal Science* 13, 949–954.
- Friend, D.W. (1973) Influence of dietary amino acids on the age of puberty of Yorkshire gilts. *Journal of Animal Science* 37, 701–707.
- Gaughan, J.B., Cameron, R.D.A., Dryden, G.M. and Josey, M.J. (1995) Effect of selection for leanness on overall reproductive performance in Large White sows. *Animal Science* 61, 561–564.
- Gaughan, J.B., Cameron, R.D.A., Dryden, G.M. and Young, B.A. (1997) Effect of body composition at selection on reproductive development in large white gilts. *Journal of Animal Science* 75, 1764–1772.
- Hacker, R.R. and Hill, D.L. (1972) Nucleic acid content of mammary glands of virgin and pregnant gilts. *Journal of Dairy Science* 55, 1295–1299.
- Handel, S.E. and Stickland, N.C. (1987) The growth and differentiation of porcine skeletal muscle fibre types and the influence of birthweight. *Journal of Anatomy* 152, 107–119.
- Hatfield, G.M., Joyce, J., Jeacock, M.K. and Shepherd, D.A.L. (1984) The irreversible loss of alanine and of glycine in fetal and sucking lambs. *British Journal of Nutrition* 52, 529–543.
- Head, R.H. and Williams, I.H. (1991) Mammogenesis is influenced by pregnancy nutrition. In: Batterham, E.S. (ed.) *Manipulating Pig Production* III. Australian Pig Science Association, Weibee, 33 pp.
- Hughes, P.E. and Pearce, G.P. (1989) The endocrine basis of nutrition-reproduction interactions. In: Barnett, J.L. and Hennessey, D.P. (eds) *Manipulating Pig Production* II. Australian Pig Science Association, Werribee, pp. 290–295.
- Hurley, W.L., Wang, H., Bryson, J.M. and Shennan, D.B. (2000) Lysine uptake by mammary gland tissue from lactating sows. *Journal of Animal Science* 78, 391–395.
- Jackson, S.C., Bryson, J.M., Wang, H. and Hurley, W.L. (2000) Cellular uptake of valine by lactating porcine mammary tissue. *Journal of Animal Science* 78, 2927–2932.
- Jones, D.B. and Stahly, T.S. (1995) Impact of amino acid nutrition during lactation on subsequent reproductive function of sows. *Journal of Animal Science* 73 (Suppl. 1), 183 (Abstr.).
- Jones, D.B. and Stahly, T.S. (1999) Impact of amino acid nutrition during lactation on body nutrient mobilization and milk nutrient output in primiparous sows. *Journal of Animal Science* 77, 1513–1522.
- Jones, R.D. and Maxwell, C.V. (1974) Effect of protein level on growth, nitrogen balance and reproductive performance in gilts. *Journal of Animal Science* 39, 1067–1072.

- Kim, S.W. (1990) Effect of food intake capacity on genotype by feeding regimen interactions in growing pigs. *Animal Production* 50, 343–351.
- Kensinger, R.S., Collier, R.J., Bazer, F.W., Ducsay, C.A. and Becker, H.N. (1982) Nucleic acid, metabolic and histological changes in gilt mammary tissue during pregnancy and lactogenesis. *Journal of Animal Science* 54, 1297–1308.
- Kim, S.W. and Easter, R.A. (2001) Nutrient mobilization from body tissues as influenced by litter size in lactating sows. *Journal of Animal Science* 78, 2172–2178.
- Kim, S.W., Hurley, W.L., Han, I.K. and Easter, R.A. (1999a) Changes in tissue composition associated with mammary gland growth during lactation in the sow. *Journal of Animal Science* 77, 2510–2516.
- Kim, S.W., Hurley, W.L., Han, I.K., Stein, H.H. and Easter, R.A. (1999b) Effect of nutrient intake on mammary gland growth in lactating sows. *Journal of Animal Science* 77, 3304–3315.
- Kim, S.W., Osaka, I., Hurley, W.L. and Easter, R.A. (1999c) Mammary gland growth as affected by litter size in lactating sows: impact on lysine requirement. *Journal of Animal Science* 77, 3316–3321.
- Kim, S.W., Grossman, M., Stein, H.H., Han, I.K. and Easter, R.A. (2000a) A nonlinear model for mammary gland changes in lactating sows. *Growth, Development, and Aging* 64, 71–81.
- Kim, S.W., Hurley, W.L., Han, I.K. and Easter, R.A. (2000b) Growth of nursing pigs related to the characteristics of nursed mammary glands. *Journal of Animal Science* 78, 1313–1318.
- Kim, S.W., Easter, R.A. and Hurley, W.L. (2001a) Regression of non-suckled mammary glands during lactation in sows as influenced by the stage of lactation, dietary nutrients, and litter size. *Journal of Animal Science* 79, 2659–2668.
- Kim, S.W., Baker, D.H. and Easter, R.A. (2001b) Dynamic ideal protein and limiting amino acids for lactating sows: Impact of amino acid mobilization. *Journal of Animal Science* 79, 2356–2366.
- King, R.H. (1987) Nutritional anoestrus in young sows. *Pig News and Information* 8, 15–22.
- King, R.H. and Dunkin, A.C. (1986) The effect of nutrition on the reproductive performance of first-litter sows. *Animal Production* 42, 119–125.
- King, R.H. and Williams, I.H. (1984) The effect of nutrition on the reproductive performance of first-litter sows. 1. Feeding level during lactation, and between weaning and mating. *Animal Production* 38, 241–247.
- King, R.H. and Williams, I.H. (1984a) The effect of nutrition on the reproductive performance of first-litter sows. 2. Protein and energy intakes during lactation. *Animal Production* 38, 249–256.
- King, R.H., Rayner, C.J. and Kerr, M. (1993) A note on the amino acid composition of sow's milk. *Animal Production* 57, 500–502.
- Kirkwood, R.N. and Aherne, F.X. (1985) Energy intake, body composition and reproductive performance of the gilt. *Journal of Animal Science* 60, 1518–1529.
- Kirkwood, R.N., Lythgoe, E.S. and Aherne, F.X. (1987) Effect of lactation feed intake and gonadotrophin-releasing hormone on the reproductive performance of sows. *Canadian Journal of Animal Science* 67, 715–719.
- Kirkwood, R.N., Baidoo, S.K. and Aherne, F.X. (1990) The influence of feeding level during lactation and gestation on the endocrine status and reproductive performance of second parity sows. *Canadian Journal of Animal Science* 70, 1119–1126.
- Knabe, D.A., Brendemuhl, J.H., Chiba, L.I. and Dove, C.R. (1996) Supplemental lysine for sows nursing large litters. *Journal of Animal Science* 74, 1635–1640.
- Knight, J.W., Bazer, F.W., Thatcher, W.W., Franke, D.E. and Wallace, H.D. (1977) Conceptus development in intact and unilaterally hysterectomized-overiectomized gilts: interrelationships among hormonal status, placental development, fetal fluids and fetal growth. *Journal of Animal Science* 44, 620–637.
- Koketsu, Y., Dial, G.D., Pattigrew, J.E. and King, V.L. (1997) Influence of feed intake during individual weeks of lactation on reproductive performance of sows on commercial farms. *Livestock Production Science* 49, 217–225.
- Kusina, J., Pettigrew, J.E., Sower, A.F., Hathaway, M.R., White, M.E. and Crooker, B.A. (1999) Effect of protein intake during gestation on mammary development of primiparous sows. *Journal of Animal Science* 77, 925–930.
- Lefaucheur, L. and Gerrard, D. (1998) Muscle fiber plasticity in farm mammals. *Proceedings of the American Society of Animal Science* pp. 1–19.
- McBride, G. (1963) The 'teat order' and communication in young pigs. *Animal Behaviour* 11, 53–56
- McGillivray, J.J., Nalbandov, A.V., Jensen, A.H., Norton, H.W., Harmon, B.G. and Becker, D.E. (1964) Effect of source and level of protein on early reproductive performance in gilts. *Journal of Animal Science* 23, 1214 (Abstr.).



- MLC (1979) *Pig Yearbook 1979*. Meat and Livestock Commission, London.
- MLC (1999) *Pig Yearbook 1999*. Meat and Livestock Commission, London.
- Monegue, H.J., Cromwell, G.L., Coffey, R.D., Carter, S.D. and Cervantes, M. (1993) Elevated dietary lysine levels for sows nursing large litters. *Journal of Animal Science* 71 (Suppl. 1):67 (Abstr.).
- Mullan, B.P. and Williams, I.H. (1989) The effect of body reserves at farrowing on the reproductive performance of first-litter sows. *Animal Production* 48, 449–457.
- Mullan B.P., Close, W.H. and Foxcroft, G.R. (1992) Metabolic state of the lactating sow influences plasma LH and FSH before and after weaning. In: Batterham, E.S. (ed.) *Manipulating Pig Production III*. APSA, Attwood, Victoria, Australia, 31pp.
- Nielsen, O.L., Pedersen, A.R. and Sorensen, M.T. (2001) Relationship between piglet growth rate and mammary gland size of the sow. *Livestock Production Science* 67, 273–279.
- Nielsen, T.T., Trottier, N.L., Bellaver, C., Hans, H.H. and Easter, R.A. (1997) Effect of litter size on mammary gland amino acid uptake in lactating sows. *Livestock Production Science* 50, 167 (Abstr.).
- Noblet, J., Dourmad, J.Y. and Etienne, M. (1990) Energy utilization in pregnant and lactating sows: modeling of energy requirements. *Journal of Animal Science* 68, 562–572.
- NRC (1998) *Nutrient Requirements of Swine*, 10th edn. National Academy Press, Washington, DC.
- O'Dowd, S., Hoste, S., Mercer, J.T., Fowler, V.R. and Edwards, S.A. (1997) Nutritional modification of body composition and the consequences for reproductive performance and longevity in genetically lean sows. *Livestock Production Science* 52, 155.
- Ott, T.L., Wiley, A.A. and Bartol, F.F. (1997) Effects of stage of gestation and uterine ligation on ovine placental development and glycosaminoglycans. *Journal of Animal Science* 75, 1053–1062.
- Parvizi, N., Elsaesser, F., Smidt, D. and Ellendorf, F. (1976) Plasma luteinizing hormone and progesterone in the adult female pig during the oestrus cycle, late pregnancy and lactation and after ovariectomy and pentobarbitone treatment. *Journal of Endocrinology* 69, 193–203.
- Pettigrew, J.E. (1993) Amino acid nutrition of gestating and lactating sows. *BioKyowa Technical Review* 5. NutriQuest, Chesterfield, Missouri.
- Pettigrew, J.E., Gill, M., France, J. and Close, W.H. (1992) A mathematical integration of energy and amino acid metabolism of lactating sows. *Journal of Animal Science* 70, 3742–3761.
- Pluske, J.R., Williams, I.H., Zak, L.J., Clowes, E.J., Cegielski, A.C. and Aherne, F.X. (1998) Feeding lactating primiparous sows to establish three divergent metabolic states. III. Milk production and pig growth. *Journal of Animal Science* 76, 1165–1171.
- Pond, W.G., Maurer, R.P. and Klindt, J. (1991) Fetal organ response to maternal protein deprivation during pregnancy in swine. *Journal of Nutrition* 121, 504–509.
- Pond, W.G., Maurer, R.R., Mersmann, H.J. and Cummins, S. (1992) Response of fetal and newborn piglets to maternal protein restriction during early or late pregnancy. *Growth Development and Aging* 56, 115–127.
- Prunier A., Dourmad, J.Y. and Etienne, M. (1993) Feeding level, metabolic parameters and reproductive performance of primiparous sows. *Livestock Production Science* 37, 185–196.
- Reeds, P.J. and Hutchens, T.W. (1994) Protein requirements: from nitrogen balance to functional impact. *Journal of Nutrition* 124, 1754S–1764S.
- Reese, D.E., Moser, B.D., Peo, E.R. Jr, Lewis, A.J., Zimmerman, D.R., Kinder, J.E. and Stroup, W.W. (1982) Influence of energy intake during lactation on the interval from weaning to first estrus in sows. *Journal of Animal Science* 55, 590–598.
- Rehfeldt, C., Fiedlet, I., Weikard, R., Kanitz, E. and Ender, K. (1993) It is possible to increase skeletal muscle fibre *in utero*. *Bioscience Reports* 13, 213–220.
- Renaudeau, D. and Noblet, J. (2001) Effects of exposure to high ambient temperature and dietary protein level on sow milk production and performance of piglets. *Journal of Animal Science* 79, 1540–1548.
- Revell, D.K., Williams, I.H., Mullan, B.P., Ranford, J.L. and Smits, R.J. (1998a) Body composition at farrowing and nutrition during lactation affect the performance of primiparous sows. I. Voluntary feed intake, weight loss and plasma metabolites. *Journal of Animal Science* 76, 1727–1737.
- Revell, D.K., Williams, I.H., Mullan, B.P., Ranford, J.L. and Smits, R.J. (1998b) Body composition at farrowing and nutrition during lactation affect the performance of primiparous sows. II. Milk composition, milk yield, and pig growth. *Journal of Animal Science* 76, 1738–1743.
- Reynolds, L.P., Killilea, S.D. and Redmer, D.A. (1992) Angiogenesis in the female reproductive system. *FASEB Journal* 6:886–892.
- Richert, B.T., Tokach, M.D., Goodband, R.D., Nelssen, J.L., Pettigrew, J.E., Walker, R.D. and Johnston,

- L.J. (1996) Valine requirement of the high-producing lactating sow. *Journal of Animal Science* 74, 1307–1313.
- Richert, B.T., Goodband, R.D., Tokach, M.D. and Nelssen, J.L. (1998) *In vitro* oxidation of branched chain amino acids by porcine mammary tissue. *Nutrition Research* 18, 833–840.
- Rozeboom, D.W., Pettigrew, J.E., Moser, R.L., Cornelius, S.G. and El Kandelgy, S.M. (1995) Body composition of gilts at puberty. *Journal of Animal Science* 73, 2524–2531.
- Schaefer, A.L. and Krishnamurti, C.R. (1984) Whole body and tissue fractional protein synthesis in the ovine fetus *in utero*. *British Journal of Nutrition* 52, 359–369.
- Scholknecht, P.A., Newton, G.R., Weise, D.E. and Pond, W.G. (1994) Protein restriction in early pregnancy alters fetal and placental growth and allantoic fluid proteins in swine. *Theriogenology* 42, 217–226.
- Shaw, H.J. and Foxcroft, G.R. (1985) Relationship between LH, FSH, and prolactin secretion and reproductive activity in the weaned sow. *Journal of the Reproduction and Fertility* 75, 17–28.
- Sinclair, A.G., Bland, V.C. and Edwards, S.A. (2001) The influence of gestation feeding strategy on body composition of gilts at farrowing and response to dietary protein in a modified lactation. *Journal of Animal Science* 79, 2397–2405.
- Smith, W.C., Ellis, M., Chadwick, J.P. and Laird, R. (1991) The influence of index selection for improved growth and carcass characteristics on appetite in a population of Large White pigs. *Animal Production* 52, 193–199.
- Sparks, J.W., Pegorier, J.P., Girard, J. and Battaglia, F.C. (1985) Growth of fetal guinea pigs: physical and chemical characteristics. *American Journal of Physiology* 248, E132–E139.
- Stalder, K.J., Long, T.E., Goodwin, R.N., Wyatt, R.L. and Halstead, J.H. (2000) Effect of gilt development diet on the reproductive performance of primiparous sows. *Journal of Animal Science* 78, 1125–1131.
- Stein, H.H., Aref, S. and Easter, R.A. (1999) Comparative protein and amino acid digestibilities in growing pigs and sows. *Journal of Animal Science* 77, 1169–1179.
- Stein, H.H., Kim, S.W., Nielsen, T.T. and Easter, R.A. (2000) Comparative standardized ileal protein and amino acid digestibilities by growing pigs and sows. *Journal of Animal Science* 79, 2113–2122.
- Tilton, S.L., Miller, P.S., Lewis, A.J., Reese, D.E. and Ermer, P.M. (1999) Addition of fat to the diets of lactating sows. I. Effects on milk production and composition and carcass composition of the litter at weaning. *Journal of Animal Science* 77, 2491–2500.
- Tokach, M.D., Pettigrew, J.E., Dial, G.D., Wheaton, J.E., Crooker, B.A. and Johnston, L.J. (1992) Characterization of luteinizing hormone secretion in the primiparous sow: relationship to blood metabolites and return-to-estrus. *Journal of Animal Science* 70, 2195.
- Touchette, K.J., Allee, G.L., Newcomb, M.D. and Boyd, R.D. (1998) The use of synthetic lysine in the diet of lactating sows. *Journal of Animal Science* 76, 1437–1442.
- Tribble, L.F., and Orr, D.E. Jr (1982) Effect of feeding level after weaning on reproduction in sows. *Journal of Animal Science* 55, 608–612.
- Trottier, N.L., Shipley, C.F. and Easter, R.A. (1997) Plasma amino acid uptake by the mammary gland of the lactating sows. *Journal of Animal Science* 75, 1266–1278.
- Voet, D. and Voet, J.G. (1990) *Biochemistry*. John Wiley, New York.
- Wahlstrom, R.C. and Libal, G.W. (1977) Effect of dietary protein during growth and gestation on development and reproductive performance of gilts. *Journal of Animal Science* 45, 94–99.
- Walker, B. and Young, B.A. (1993) Prediction of protein accretion, support costs and lipid accretion in the growing female pig and dry sow. *Agricultural Systems* 42, 343–358.
- Weldon, W.C., Thulin, A.J., MacDougald, O.A., Johnson, L.J., Miller, E.R. and Tucker, H.A. (1990) Effects of elevated dietary energy and protein during late gestation on mammary development in gilts. *Research Report*. Michigan State University 502, 41–50.
- Whittemore, C.T. (1996) Nutrition reproduction interactions in primiparous sows. *Livestock Production Science* 46, 65.
- Wigmore, P.M. and Dungleison, G.F. (1998) The generation of fiber diversity during myogenesis. *International Journal of Developmental Biology* 42, 117–125.
- Wigmore, P.M. and Stickland, N.C. (1983) Muscle development in large and small pig fetuses. *Journal of Anatomy* 137, 235–245.
- Wu, G., Bazer, F.W., Tuo, W. and Flynn, S.P. (1996) Unusual abundance of arginine and ornithine in porcine allantoic fluid. *Biology of Reproduction* 54, 1261–1265.
- Wu, G., Pond, W.G., Ott, T.L. and Bazer, F.W. (1998a) Maternal dietary protein deficiency decreases amino acid concentrations in fetal plasma and allantoic fluid of pigs. *Journal of Nutrition* 128, 894–902.

- 
- Wu, G., Pond, W.G., Flynn, S.P., Ott, T.L. and Bazer, F.W. (1998b) Maternal dietary protein deficiency decreases nitric oxide synthase and ornithine decarboxylase activities in placenta and endometrium of pigs during early gestation. *Journal of Nutrition* 128, 2395–2402.
- Wu, G., Pond, W.G., Flynn, S.P., Ott, T.L. and Bazer, F.W. (1998c) Maternal dietary protein deficiency decreases nitric oxide synthase and ornithine decarboxylase activities in placenta and endometrium of pigs during early gestation. *Journal of Nutrition* 128, 2395–2402.
- Wu, G., Ott, T.L., Knabe, D.A. and Bazer, F.W. (1999) Amino acid composition of the fetal pig. *Journal of Nutrition* 129, 1031–1038.
- Yang, H., Eastham, P.R., Phillips, P. and Whittemore, C.T. (1989) Reproductive performance, body weight and body condition of breeding sows with differing body fatness at parturition, differing nutrition during lactation and differing litter size. *Animal Production* 48, 181–201.
- Yang, H., Foxcroft, G.R., Pettigrew, J.E., Johnson, L.J., Shurson, G.C., Costa, A.N. and Zak, L.J. (2000) Impact of dietary lysine intake during lactation on follicular development and oocyte maturation after weaning in primiparous sows. *Journal of Animal Science* 78, 993–1000.
- Yudilevich, D.L. and Sweiry, J.H. (1985) Transport of amino acids in the placenta. *Biochimica et Biophysica Acta* 822, 169–201.
- Zak, L.J., Williams, I.H., Foxcroft, G.R., Pluske, J.R., Cegielski, A.C., Clowes, E.J. and Aherne, F.X. (1998) Feeding lactating primiparous sows to establish three divergent metabolic status: I. Associated endocrine changes and postweaning reproductive performance. *Journal of Animal Science*. 76, 1145–1153.
- Zarkadas, C.G., Larmond, E., Elliot, J.I., Khalili, A.D. and Beddard-Neil, C. (1992) Effect of dietary restriction during gestation on amino acid composition and myofibrillar and collagen contents of skeletal muscle in gilts mated at puberty. *Journal of Agricultural and Food Chemistry* 40, 98–106.
- Zimmerman, D.R., Peo, E.R. and Hudman, D.B. (1967) Plant vs. animal protein as a source of supplemental protein for the gilt. *Journal of Animal Science*. 26, 514–517.

# 13 Ideal Amino Acid Patterns for Broiler Chicks

David H. Baker\*

Department of Animal Sciences, University of Illinois, Urbana, Illinois, USA

---

## Introduction

Early workers in the protein–amino acid area conceptualized the concept of an ideal protein in which amino acid (AA) needs could be proportioned one to another (Almquist and Grau, 1944; Mitchell, 1964; Dean and Scott, 1965). The concept was first popularized for practical diet formulation of pigs by the British Agricultural Research Council (ARC, 1981), after Cole (1980) proposed that ideal AA ratios could be used to formulate pig diets. Today, ideal AA ratios, with lysine as the reference amino acid, are used throughout the world for diet formulation of pigs (ARC, 1981; Chung and Baker, 1992; Fuller, 1994; NRC, 1998), and increasingly for poultry (Baker and Han, 1994; NRC, 1994; Baker, 1997; Emmert and Baker, 1997; Mack *et al.*, 1999; Baker *et al.*, 2002).

There are numerous reasons why ideal AA ratios are appealing for diet formulation. The old system of attempting to list requirements for all essential AA at various stages of growth, maintenance, and egg production was, at best, open to wide interpretation. Requirements for many AA were not known, nor could those that were known be applied to all animals fed diets with varying levels of energy and protein. If one could focus, however, on the requirement for just one AA, i.e. lysine, and if one had reliable information on

the proper ratios of the other AA to lysine, it would be possible to set a lysine requirement based on empirical evidence and then calculate what the other requirements should be for a given set of environmental, dietary, gender, age and body compositional circumstances. Hence, the ideal ratios, unlike the requirements, would not change based on whether diets contained high or low levels of energy or protein, and they also would not change based on whether animals had greater or lesser potential for lean growth. Moreover, stress factors such as heat, cold, crowding and disease that likely would affect voluntary feed intake should not affect the ideal ratios, though they might affect the lysine requirement. Recent evidence, however, supports the view that the lysine requirement expressed as a percentage of the diet or calories probably changes very little due to heat stress (Han and Baker, 1993) or disease stress (Webel *et al.*, 1998), although sex of broilers represents a factor that must be considered in setting the lysine requirement, i.e. males have higher requirements than females, particularly at younger ages (Han and Baker, 1993, 1994).

## Ratio Estimates for Broiler Chicks

Data in Table 13.1 show, with the exception of NRC (1994) estimates, empirical

\*E-mail address: [dhbaker@uiuc.edu](mailto:dhbaker@uiuc.edu)

**Table 13.1.** Ideal ratios (%) of essential amino acids for broiler chicks as proposed by various investigators.

Amino acid	Baker (1997) <sup>a</sup>	NRC (1994) <sup>b</sup>	Mack <i>et al.</i> (1999) <sup>c</sup>	Baker <i>et al.</i> (2002) <sup>d</sup>
Lysine	100	100	100	100
Methionine	36	42	ND <sup>e</sup>	ND
Cystine	36	33	ND	ND
SAA <sup>f</sup>	72	75	70	ND
Threonine	67	67	59	56
Valine	77	75	76	78
Isoleucine	67	67	66	61
Leucine	109	100	ND	ND
Tryptophan	16	17	17	17
Arginine	105	104	104	105
Histidine	35	29	ND	ND
Phe + Tyr	105	112	ND	ND

<sup>a</sup>Calculated on a true digestible basis based on numerous requirement studies using crystalline amino acid diets fed to chicks during the second and third week of life (see also Baker and Han, 1994).

<sup>b</sup>Ratio of requirements on a total amino acid basis for chicks fed a maize–soybean meal diet from 0 to 3 weeks of age, with the lysine requirement corrected to 12 g kg<sup>-1</sup> (instead of 10 g kg<sup>-1</sup>).

<sup>c</sup>Recalculation of data from Mack *et al.* (1999) using the broken-line true digestible lysine requirement estimate (9.2 g kg<sup>-1</sup>) for maximal feed efficiency as a reference point. Data were obtained from chicks fed low protein (172 g CP kg<sup>-1</sup>) maize–soybean meal diets from 20 to 40 days of age.

<sup>d</sup>Based on true digestible requirement ratios presented herein. The broken-line requirement was taken to be the higher of individual estimates for gain and gain/feed ratio.

<sup>e</sup>ND, not determined.

<sup>f</sup>SAA, sulphur amino acids.

estimates of ideal AA ratios. Our original estimates (Baker and Han, 1994) were modified only slightly (Baker, 1997), and these estimates are compared to estimates of NRC (1994), many of which were based on the Han and Baker (1994) data, and to recent estimates made by Mack *et al.* (1999), as recalculated, and to new information that is presented in this review. The fact that different stages of broiler growth are represented would seem to present problems in comparing the ratio estimates shown in Table 13.1. However, this is based on the assumption that ideal ratios (relative to lysine) for maintenance of certain amino acids (e.g. threonine, tryptophan, sulphur amino acids (SAA)) may greatly exceed the ideal ratio of these same amino acids for protein accretion *per se*. Recent evidence, however, showed that the maintenance requirement for lysine was much higher than had been previously assumed (Edwards and Baker, 1999). This, then, suggested that the ideal ratios for tryptophan and SAA may not change at all during the 6-, 8- or 10-week growth period of a broiler chick

(Emmert and Baker, 1997), and also that the threonine:lysine ratio may increase only slightly with advancing age.

Legitimate estimates of ideal AA ratios have several prerequisites: (i) the same basal diet, same sex and strain of chicks, and same assay period should be used in all requirement bioassays, (ii) true digestibility of AA in the basal diet must be known, (iii) clear-cut graded responses should occur to the limiting AA being studied, and (iv) objective and consistent curve-fitting procedures should be used to predict the requirement for each AA being investigated. For the most part, these criteria were met in the study by Mack *et al.* (1999). However, the low protein maize–soybean meal diet (172 g kg<sup>-1</sup> CP) used in their study did not allow good and clear-cut graded responses to some of the AA (e.g. tryptophan and isoleucine) they investigated. Also, they observed as have we (Han and Baker, 1991, 1993, 1994; Baker *et al.*, 2002) that lysine requirement estimates for maximal feed efficiency consistently exceed those for maximal weight gain. For most AA, the requirement for maximal weight gain is very similar to the

requirement for maximal feed efficiency (Mack *et al.*, 1999; Baker *et al.*, 2002). However, SAA requirements may be similar to lysine in that gain/feed requirements often exceed weight gain requirements (Schutte and Pack, 1995; Baker *et al.*, 1996; Mack *et al.*, 1999). Because, Mack *et al.* (1999) provided broken-line requirement estimates for both gain and feed efficiency for only lysine (only gain requirements were given for the other AA), the recalculated ratios for the Mack *et al.* (1999) data are based on the broken-line requirement estimates for maximal gain/feed for lysine, but for maximal weight gain for the other AA. In their paper, broken-line requirement estimates for maximal gain (for all AA) were used to estimate ratios, and this is likely to have overestimated the ideal ratios. Indeed, using gain/feed requirements for lysine and gain requirements for the other AA, despite questionable responses to tryptophan and isoleucine, resulted in ratio estimates (with the exception of threonine) that were in good agreement with our original estimates (Baker, 1997). The new empirical estimates from our laboratory (Baker *et al.*, 2002) shown in Table 13.1 will form the basis for the discussion that follows.

### New Ratio Estimates for Threonine, Tryptophan, Isoleucine, Valine and Arginine

A semipurified diet (Table 13.2) based on AA-fortified maize gluten meal (CGM) was developed in our laboratory (Peter *et al.*, 2000) for use in studying the requirements for several AA. True digestibility of AA was determined in the high-protein CGM sample used (Table 13.3), and the same sample of CGM was used for all AA bioassays. Using 10.7 g kg<sup>-1</sup> digestible lysine as a requirement reference point (Han and Baker, 1991, 1993), the CGM basal diet was fortified with essential AA so that all essential AA other than the one being studied would meet or slightly exceed the ideal AA ratios of Baker (1997) shown in Table 13.1. Levels of leucine and aromatic AA (phenylalanine + tyrosine), however, exceeded their ideal levels because of the surfeit levels of these AA in CGM. L-Glutamate

**Table 13.2.** Composition (as-fed basis) of complete (fortified) diet used to determine amino acid requirements of chicks fed a maize gluten meal semi-purified diet<sup>a,b</sup>.

Ingredient	g kg <sup>-1</sup>
Maize starch	275.35
Dextrose	282.00
Maize gluten meal (CGM) <sup>c</sup>	183.40
Soybean oil	40.00
Mineral mix <sup>d</sup>	53.70
NaHCO <sub>3</sub>	15.00
Vitamin mix <sup>d</sup>	2.00
Choline chloride	2.00
L-Glutamate	109.40
L-Lysine·HCl (FG) <sup>e</sup>	11.93
L-Tryptophan (FG) <sup>e</sup>	1.34
L-Arginine	8.08
L-Cystine	1.87
L-Threonine (FG) <sup>e</sup>	3.91
L-Isoleucine	2.77
L-Valine	3.68
L-Histidine·HCl·H <sub>2</sub> O	1.38
DL-Methionine	1.69
Bacitracin MD premix <sup>f</sup>	0.50
DL- $\alpha$ -tocopheryl acetate (50 mg kg <sup>-1</sup> )	+
Ethoxyquin (125 mg kg <sup>-1</sup> )	+

<sup>a</sup>The diet contained 14.2 MJ kg<sup>-1</sup> ME and 120 g CP kg<sup>-1</sup> furnished by maize gluten meal (CGM) and was fortified to 225 g CP kg<sup>-1</sup> using glutamic acid and essential amino acids (Phe + Tyr, and Leu from CGM exceeded NRC (1994) requirements). Individual amino acids whose requirements were determined were adjusted downward to facilitate graded dose levels.

<sup>b</sup>The digestible AA profile met or exceeded the Illinois Ideal ratios for poultry (Baker and Han, 1994; Baker, 1997) during 0–3 weeks of age (Lys, 100; Met, 36; Cys, 36; Arg, 105; Val, 77; Thr, 67; Trp, 16; Ile, 67; His, 35; Phe + Tyr, 105; Leu, 109).

<sup>c</sup>The CGM was analysed to contain 653.1 g CP kg<sup>-1</sup>. It was obtained from ADM Corp., Decatur, Illinois.

<sup>d</sup>Peter *et al.* (2000).

<sup>e</sup>FG, feed grade.

<sup>f</sup>Contributed 27.5 mg kg<sup>-1</sup> bacitracin methylene disalicylate.

was then added as a source of non-specific amino nitrogen to achieve a final dietary crude protein level (nitrogen  $\times$  6.25) of 225 g kg<sup>-1</sup>. Also, as the level of an essential AA was varied within (and between) individual bioassays, L-glutamate was varied so that all diets within and between bioassays would be isoni-

**Table 13.3.** Essential amino acid composition and true digestibility values of maize gluten meal.

Amino acid	Composition (g kg <sup>-1</sup> ) <sup>a</sup>	Digestibility (%) <sup>b</sup>	True digestible level (g kg <sup>-1</sup> )
Lysine	11.1	79.7	8.85
Arginine	20.8	94.9	19.74
Threonine	20.9	90.4	18.89
Valine	28.7	96.8	27.78
Isoleucine	24.9	98.6	24.55
Histidine	12.8	88.0	11.26
Cystine	11.4	73.4	8.37
Methionine	15.0	93.2	13.98
Phenylalanine	41.1	95.8	39.37
Tyrosine	28.0	95.5	26.74
Leucine	105.6	98.0	103.49
Tryptophan	3.40	97.0 <sup>c</sup>	3.30

<sup>a</sup>Average of duplicate determinations; data expressed as a percentage of as-fed maize gluten meal (880 g kg<sup>-1</sup> dry matter).

<sup>b</sup>Means of five caeectomized cockerels.

<sup>c</sup>Not determined; value obtained from *Rhodimet*<sup>TM</sup> *Nutrition Guide* (Rhône-Poulenc, 1993).

trogenous. All bioassays were done using male New Hampshire × Columbian chicks during a 12–14 day growth period representing the second and third weeks of life. Previous work in our laboratory had established that lysine requirements (g kg<sup>-1</sup> of diet) as well as protein gain as a proportion of total weight gain were similar in this strain compared with commercial broiler strains (Han and Baker, 1991, 1993). For each of the requirement bioassays, four pens of four male chicks were fed each of six AA dose levels, and chicks were fed in battery pens located in an environmentally controlled building with constant lighting. Other details of the bioassay procedures have been described by Baker *et al.* (2002).

Data in Table 13.4 show that (i) the completely fortified CGM diet produced weight gain and feed efficiency levels that were not different ( $P > 0.10$ ) from those obtained with a methionine-fortified maize–soybean meal positive-control diet, and (ii) the CGM diet could be made markedly deficient in at least eight essential AA. Thus, the CGM diet was deemed a very useful bioassay tool for dose–response studies with several essential AA.

Weight gain and gain/feed responded quadratically ( $P < 0.01$ ) in all requirement bioassays. Both weight gain and feed effi-

ciency pen means data were subjected to one-slope broken-line and quadratic curve-fitting procedures, with dietary AA concentration serving as the independent variable (Robbins *et al.*, 1979; Draper and Smith, 1981). We considered the breakpoint of fitted broken lines the best basis for predicting ideal AA ratios, and Mack *et al.* (1999) came to the same conclusion. The fits of our broken-line responses were excellent in all cases, and quadratic fits were also very good (Baker *et al.*, 2002). Inflection points of best-fit broken lines predict minimal requirement values, and this is viewed as desirable for calculating AA ratios. Another advantage of the fitted broken-line approach is that the inflection point is established objectively rather than subjectively. Quadratic fits do not produce objective breakpoints, and therefore one must subjectively select some percentage of the upper asymptote (e.g. 90%) as an estimate of the requirement.

It is possible, however, to take advantage of both broken-line and quadratic response curves to arrive at realistic objective estimates of AA requirements. If one superimposes the best-fit quadratic response curve on the best-fit broken-line response curve, the quadratic curve will intersect the broken line in at least three places: once (or twice)

**Table 13.4.** Limiting amino acids in maize gluten meal for young chicks as determined by amino acid deletion<sup>a,b</sup>.

Diet	12-day weight gain (g)	Gain/feed (g kg <sup>-1</sup> )
1. Maize gluten meal complete diet <sup>c</sup>	268 <sup>r,s</sup>	687 <sup>r</sup>
2. As 1 – Lys	6 <sup>z</sup>	64 <sup>z</sup>
3. As 1 – Trp	32 <sup>y</sup>	238 <sup>y</sup>
4. As 1 – Arg	49 <sup>x</sup>	296 <sup>x</sup>
5. As 1 – Thr	82 <sup>w</sup>	408 <sup>w</sup>
6. As 1 – Val	104 <sup>v</sup>	468 <sup>v</sup>
7. As 1 – Ile	156 <sup>u</sup>	550 <sup>u</sup>
8. As 1 – His	171 <sup>u</sup>	601 <sup>s,t</sup>
9. As 1 – Met – Cys	194 <sup>t</sup>	574 <sup>t,u</sup>
10. As 1 – Met	209 <sup>t</sup>	620 <sup>s</sup>
11. As 1 – Gly	256 <sup>s</sup>	685 <sup>r</sup>
12. Maize–soybean meal positive control <sup>d</sup>	284 <sup>r</sup>	683 <sup>r</sup>
Pooled SEM	6	14

<sup>a</sup>Data represent means of triplicate groups of five New Hampshire × Columbian male chicks during the period 8–20 days posthatching; average initial weight was 89 g (Peter *et al.*, 2000).

<sup>b</sup>All diets were formulated to be isonitrogenous by varying the L-Glu level.

<sup>c</sup>Maize gluten meal diet fortified with essential amino acids and L-Glu to 225 g CP kg<sup>-1</sup> (see Table 13.2).

<sup>d</sup>Maize–soybean meal positive control diet, supplemented with 2 g kg<sup>-1</sup> DL-Met, contained 230 g CP kg<sup>-1</sup> and 13.4 MJ kg<sup>-1</sup> ME.

<sup>r,s,t,u,v,w,x,y,z</sup>Within a column, means lacking common superscript letters differ ( $P < 0.05$ ).

on the ascending and twice on the plateau (zero slope) portion of the broken line. The first intercept  $x$  (AA level) value where the quadratic curve intersects the plateau of the broken line can be calculated, and we feel that this value is a realistic and objective estimate of the requirement for a population of animals. This procedure is illustrated in the discussion that follows.

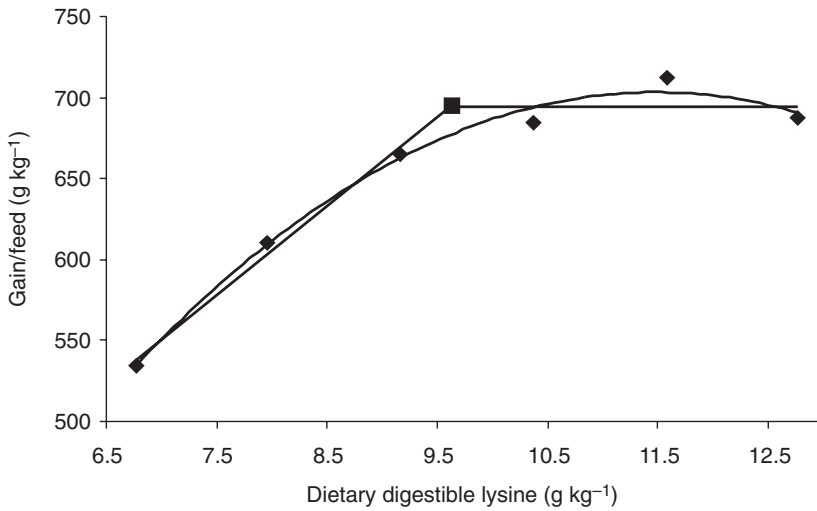
### Lysine assays

Because lysine is used as a reference AA for calculating ideal ratios, it is critical to obtain clear and accurate information on the lysine requirement. Therefore, we completed two identical bioassays (at different times) in which graded levels of digestible lysine (6.77–12.78 g kg<sup>-1</sup>) were fed (Figs 13.1 and 13.2). The broken-line requirement estimates for gain/feed ratio were 9.64 (Assay 1) and 9.56 g kg<sup>-1</sup> (Assay 2), both values being substantially

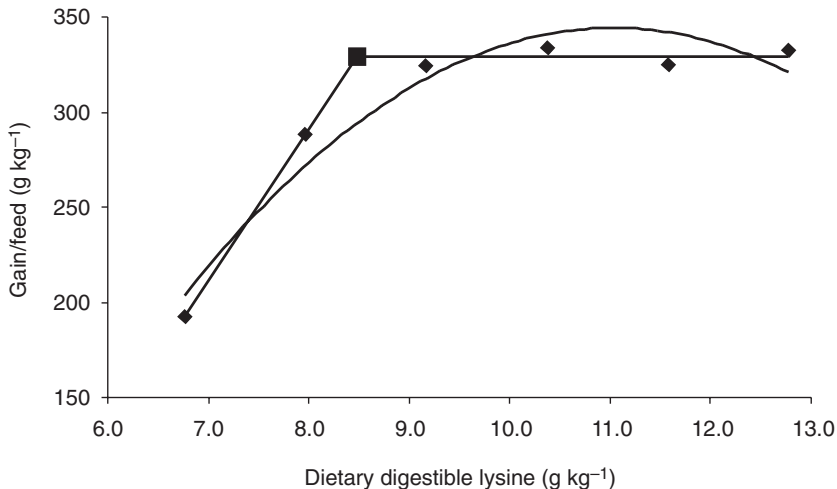
higher than the broken-line requirement estimates for weight gain of 8.46 and 8.49 g kg<sup>-1</sup> in Assays 1 and 2, respectively (Baker *et al.*, 2002). The first intercept  $x$  value of the broken line (on the plateau) and the quadratic fitted line for feed efficiency occurred at 10.1 g kg<sup>-1</sup> (Assay 1) and 10.4 g kg<sup>-1</sup> (Assay 2) digestible lysine (Figs 13.1 and 13.2), and these requirement estimates closely approximated those obtained by taking 90% of the upper asymptote  $x$  value from the quadratic response curve. Regardless of the curve-fitting procedure used to estimate lysine requirements, the requirements obtained herein using a CGM semipurified diet containing about one-half of the dietary nitrogen from CGM and the other half from free AA were lower than those estimated previously in our laboratory for male chicks of the same age (Han and Baker, 1991, 1993).

The lysine requirement estimates of Mack *et al.* (1999) were done using a low protein maize–soybean meal diet. In two





**Fig. 13.1.** Fitted broken-line and quadratic plots of gain/feed as a function of true digestible Lys in the diet (Assay 1). Data points are means of four pens of four male chicks during the period 8–21 days posthatching. The minimal digestible Lys requirement determined by broken-line analysis using least squares methodology was  $9.64 \text{ g kg}^{-1}$  ( $y = 694.4 + 54.90 (x < 9.64)$ ;  $r^2 = 0.885$ ). The pen means data also were fitted to a quadratic regression equation  $y = -300.2 + 174.68x - 7.60x^2$  ( $r^2 = 0.899$ ). The level of digestible Lys that maximized feed efficiency (i.e. upper asymptote) was calculated to be  $11.49 \text{ g kg}^{-1}$ , with 90% of this value being  $10.34 \text{ g kg}^{-1}$ . The first intercept  $x$  value of the broken-line (on the plateau) and the quadratic fitted line occurred at  $10.40 \text{ g kg}^{-1}$ .



**Fig. 13.2.** Fitted broken-line and quadratic plots of gain/feed ratio as a function of true digestible Lys in the diet (Assay 2). Data points are means of four pens of four male chicks during the period 8–21 days posthatching. The minimal digestible Lys requirement determined by broken-line analysis using least squares methodology was  $9.56 \text{ g kg}^{-1}$  ( $y = 665.83 + 59.90 (x < 9.56)$ ;  $r^2 = 0.870$ ). The pen means data also were fitted to a quadratic regression equation ( $y = -502.70 + 210.88x - 9.42x^2$ ;  $r^2 = 0.897$ ). The level of digestible Lys that maximized feed efficiency (upper asymptote) was calculated to be  $11.20 \text{ g kg}^{-1}$ , with 90% of this value being  $10.08 \text{ g kg}^{-1}$ . The first intercept  $x$  value of the broken-line (on the plateau) and the quadratic fitted line occurred at  $10.10 \text{ g kg}^{-1}$ .

separate bioassays they found that the lysine requirement for maximal feed efficiency was substantially higher than that required for not only maximal weight gain, but also for maximal breast-meat yield. In our previous lysine work with 3–6-week-old broiler chicks (Han and Baker, 1994), the lysine requirement for maximal feed efficiency was similar to that required for maximal breast-meat yield.

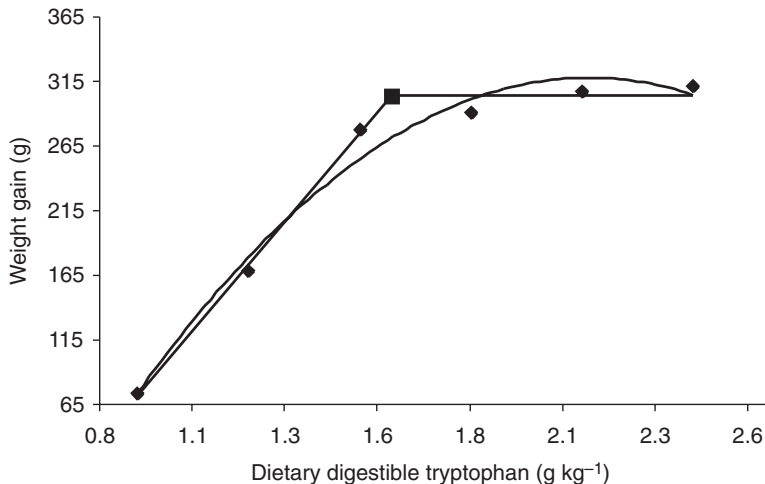
### Tryptophan assay

Based on the broken-line inflection point (Fig. 13.3), the digestible tryptophan requirement for maximal weight gain was  $1.59 \text{ g kg}^{-1}$ , which is in very close agreement with the broken-line requirement estimate ( $1.57 \text{ g kg}^{-1}$ ) using feed efficiency as the response criterion (Baker *et al.*, 2002). The digestible tryptophan requirement ( $1.59 \text{ g kg}^{-1}$ ) ratioed to the average digestible lysine requirement of  $9.60 \text{ g kg}^{-1}$  (i.e. from Assays 1 and 2) was 16.6%,

in close agreement with our earlier estimate of 16% (Baker, 1997).

The digestible tryptophan requirement estimated by taking the first intercept  $x$  value of the broken line (on the plateau) and the quadratic fitted line was  $1.83 \text{ g kg}^{-1}$  (Fig. 13.3). This requirement estimate parallels the  $1.91 \text{ g kg}^{-1}$  estimate obtained by taking 90% of the upper asymptote  $x$  value from the quadratic response curve.

Using the 16.6% Trp:Lys ratio determined herein together with our best estimate of the digestible lysine requirement ( $10.7 \text{ g kg}^{-1}$ ) for broiler chicks during the first 3 weeks of life (mixed sex feeding) as determined previously in chicks fed diets with an metabolizable energy (ME) level of  $13.4 \text{ MJ kg}^{-1}$  (Han and Baker, 1991, 1993), one arrives at a digestible tryptophan requirement of  $1.78 \text{ g kg}^{-1}$ . This agrees well with the requirement estimates of  $1.83 \text{ g kg}^{-1}$  obtained by determining the first intercept  $x$  value of the broken line (on the plateau) and the quadratic fitted line (Fig. 13.3). With a tryptophan digestibility of 86%



**Fig. 13.3.** Fitted broken-line and quadratic plots of 13-day weight gain as a function of true digestible Trp in the diet (Assay 3). Data points are means of four pens of four male chicks during the period 8–21 days posthatching. The minimal true digestible Trp requirement determined by broken-line analysis using least squares methodology was  $1.59 \text{ g kg}^{-1}$  ( $y = 302.8 + 339.58(x < 1.59)$ ;  $r^2 = 0.934$ ). The pens means data also were fitted to a quadratic regression equation  $y = -423.7 + 697.14x - 164.03x^2$  ( $r^2 = 0.922$ ). The level of digestible Trp that maximized weight gain (i.e. upper asymptote) was calculated to be  $2.12 \text{ g kg}^{-1}$ , with 90% of this value being  $1.91 \text{ g kg}^{-1}$ . The first intercept  $x$  value of the broken-line (on the plateau) and the quadratic fitted line occurred at  $1.83 \text{ g kg}^{-1}$ .

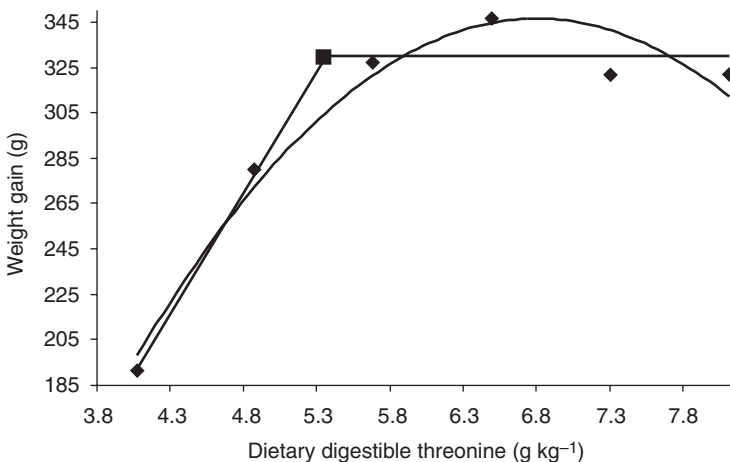
in maize–soybean meal broiler diets (Rhone-Poulenc, 1993), the total tryptophan requirement calculates to be  $2.07 \text{ g kg}^{-1}$  for chicks consuming conventional maize–soybean meal diets. This value is in good agreement with the NRC (1994) tryptophan requirement estimate of  $2.00 \text{ g kg}^{-1}$ .

### Threonine assay

The digestible threonine requirement for maximal weight gain (Fig. 13.4) and feed efficiency was  $5.35$  and  $5.33 \text{ g kg}^{-1}$ , respectively, based on the inflection points of single-slope broken-line fits (Baker *et al.*, 2002). Using the higher of broken-line requirement estimates for weight gain and feed efficiency, the ideal threonine:lysine ratio was  $55.7\%$ , considerably lower than our original estimate of  $67\%$  (Baker, 1997). The recalculated threonine:lysine ratio from the Mack *et al.* (1999) study was  $59\%$  (Table 13.1) for chicks between 20 and 40 days posthatching. Thus, both our work herein and the data of Mack *et al.* (1999) suggest that the ideal ratio

of threonine:lysine is less than  $60\%$  for broiler chicks for growth periods ranging from hatching to 40 days posthatching. That the ideal ratio calculated from the Mack *et al.* (1999) data was somewhat higher than our estimate of  $55.7\%$  was likely due to the fact that older broilers exhibit slightly higher threonine:lysine ratios than younger broilers (Emmert and Baker, 1997).

Our threonine ratio of  $55.7\%$  multiplied by the digestible lysine requirement ( $10.7 \text{ g kg}^{-1}$ ) of 0–21-day-old chicks (mixed sex feeding) predicts a digestible threonine requirement of  $5.96 \text{ g kg}^{-1}$ , which closely approximates the  $5.90 \text{ g kg}^{-1}$  threonine requirement estimate obtained using the plateau intercept value of the broken line and the quadratic fitted line (Fig. 13.4). If one assumes that the digestibility of threonine in a maize–soybean meal diet is  $87\%$  (NRC, 1994), the predicted total threonine requirement would be  $6.85 \text{ g kg}^{-1}$  for chicks during the first 3 weeks posthatching. This estimate is well below the NRC (1994) requirement estimate of  $8.0 \text{ g kg}^{-1}$ . Work from Kidd *et al.* (1997) and Smith and Waldroup (1988) suggests, also, that the



**Fig. 13.4.** Fitted broken-line and quadratic plots of 14-day weight gain as a function of true digestible Thr in the diet (Assay 4). Data points are means of four pens of four male chicks during period 8–22 days posthatching. The minimal digestible Thr requirement determined by broken-line analysis using least squares methodology was  $5.35 \text{ g kg}^{-1}$  ( $y = 328.8 + 108.44(x - 5.35)$ ,  $r^2 = 0.867$ ). The pens means gain data also were fitted to a quadratic regression equation:  $y = -559.3 + 265.86x - 19.54x^2$  ( $r^2 = 0.855$ ). The level of true digestible Thr that maximized weight gain (i.e. upper asymptote) was calculated to be  $6.80 \text{ g kg}^{-1}$ , with  $90\%$  of this value being  $6.12 \text{ g kg}^{-1}$ . The first intercept  $x$  value of the broken-line (on the plateau) and the quadratic fitted line occurred at  $5.90 \text{ g kg}^{-1}$ .

NRC (1994) threonine requirement estimate for 0- to 3-week-old chicks is too high.

The ideal threonine:lysine ratio for young chicks of 55.7% is lower than the ideal threonine:lysine ratio of 65% for young pigs (Chung and Baker, 1992; Baker, 1997). Relative to pigs, avians have a very short gastrointestinal tract, and a large portion of the total threonine requirement is needed for gut protein synthesis (Bertollo *et al.*, 1998). This could explain why avians require lower levels of threonine (relative to lysine) than pigs.

### Isoleucine assay

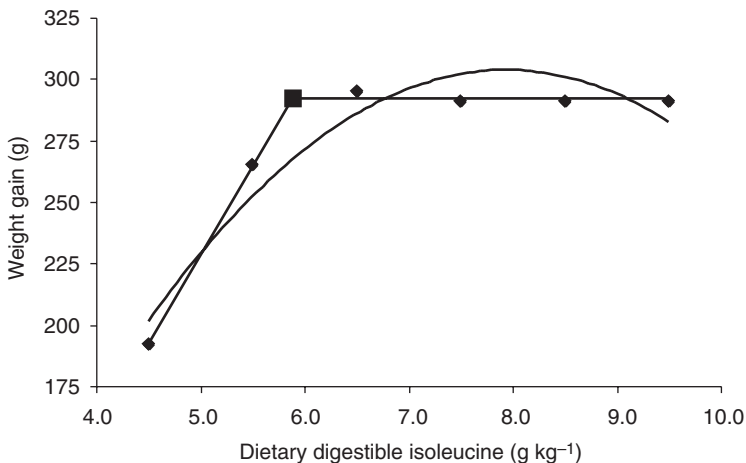
Graded doses of digestible isoleucine (4.5–9.5 g kg<sup>-1</sup>) resulted in quadratic ( $P < 0.01$ ) responses in both weight gain and feed efficiency (Fig. 13.5). The broken-line requirement estimates were 5.89 g kg<sup>-1</sup> for weight gain and 5.81 g kg<sup>-1</sup> for gain/feed ratio (Baker *et al.*, 2002). Thus, the ideal ratio of isoleucine:lysine was determined to be 61.4% ( $5.89 \div 9.60 \times 100$ ). This value

is lower than our original estimate of 67% (Baker, 1997).

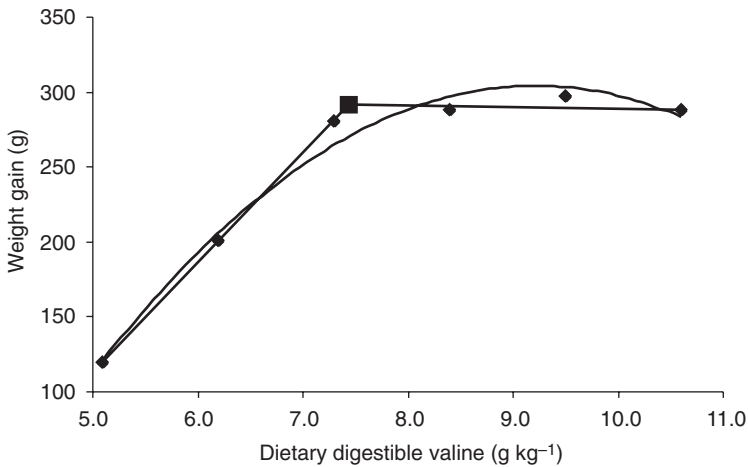
The predicted digestible isoleucine requirement for chicks for 0–3 weeks posthatching is 6.57 g kg<sup>-1</sup> ( $0.614 \times 10.7$ ) which is similar to the 6.79 g kg<sup>-1</sup> requirement predicted from the first intercept value of the broken line plateau with the quadratic fitted line (Fig. 13.5). Extrapolation of this requirement estimate to chicks fed a maize–soybean meal diet where isoleucine digestibility is 91% (NRC, 1994) results in a total predicted isoleucine requirement of 7.22 g kg<sup>-1</sup>, which is lower than the 8.0 g kg<sup>-1</sup> estimate of NRC (1994).

### Valine assay

Quadratic ( $P < 0.01$ ) responses in weight gain (Fig. 13.6) and feed efficiency occurred when graded doses (5.1–10.6 g kg<sup>-1</sup>) of digestible valine were fed (Baker *et al.*, 2002). The broken-line digestible requirement estimates were 7.44 and 7.43 g kg<sup>-1</sup> for weight gain and feed efficiency, respectively. The valine requirement (7.44 g kg<sup>-1</sup>) ratioed to the lysine requirement



**Fig. 13.5.** Fitted broken-line and quadratic plots of 13-day weight gain as a function of true digestible Ile in the diet (Assay 5). Data points are means of four pens of four male chicks during the period 8–21 days posthatching. The minimal digestible Ile requirement determined by broken-line analysis using least squares methodology was 5.89 g kg<sup>-1</sup> ( $y = 292.0 + 72.25(x < 5.89)$ ;  $r^2 = 0.876$ ). The pen means data also were fitted to a quadratic regression equation:  $y = -239.08 + 136.54x - 8.59x^2$ ;  $r^2 = 0.810$ . The level of digestible Ile that maximized weight gain (i.e. upper asymptote) was calculated to be 7.95 g kg<sup>-1</sup>, with 90% of this value being 7.15 g kg<sup>-1</sup>. The first intercept  $x$  value of the broken-line (on the plateau) and the quadratic fitted line occurred at 6.79 g kg<sup>-1</sup>.



**Fig. 13.6.** Fitted broken-line and quadratic plots of 13-day weight gain as a function of true digestible Val in the diet (Assay 6). Data points are means of four pens of four male chicks during the period 8–21 days posthatching. The minimal digestible Val requirement determined by broken-line analysis using least squares methodology was  $7.44 \text{ g kg}^{-1}$  ( $y = 290.83 + 73.18 (x < 7.44)$ ;  $r^2 = 0.963$ ). The pen means data also were fitted to a quadratic regression equation:  $y = -618.42 + 200.39x - 10.88x^2$ ;  $r^2 = 0.950$ . The level of digestible Val that maximized weight gain (i.e. upper asymptote) was calculated to be  $9.21 \text{ g kg}^{-1}$  of the diet, with 90% of this value being  $8.29 \text{ g kg}^{-1}$ . The first intercept  $x$  value of the broken-line (on the plateau) and the quadratic fitted line occurred at  $8.11 \text{ g kg}^{-1}$ .

( $9.60 \text{ g kg}^{-1}$ ) was 77.5%, closely agreeing, therefore, with our original estimate of 77% (Baker, 1997) and with the recalculated ratio estimate (76%) of Mack *et al.* (1999), (see Table 13.1). Why the ideal valine:lysine ratio of broiler chicks is higher than that for pigs (68%) is not known (Baker, 1997).

Using 77.5% as an ideal ratio for valine, the predicted digestible valine requirement would be  $8.29 \text{ g kg}^{-1}$  ( $0.775 \times 10.7$ ), and this estimate agrees well with those calculated from the broken line/quadratic curve intercept method ( $8.11 \text{ g kg}^{-1}$ ) as well as the value obtained by taking 90% of the upper asymptote from the quadratic fitted line ( $8.2 \text{ g kg}^{-1}$ ). Dividing the  $8.29 \text{ g kg}^{-1}$  digestible valine requirement estimate by a maize-soybean meal valine digestibility value of 90% (NRC, 1994) yields a total valine requirement estimate of  $9.21 \text{ g kg}^{-1}$  for 0–21-day-old chicks fed a maize-soybean meal diet. The NRC (1994) total valine requirement estimate (maize-soybean meal basis) is  $9.0 \text{ g kg}^{-1}$ . Thus, our  $9.21 \text{ g kg}^{-1}$  estimate herein is slightly higher. Previous work from our laboratory established that valine is among the four most limiting AA in soybean meal and in

reduced protein maize-soybean meal diets (Han *et al.*, 1992; Fernandez *et al.*, 1994).

### Arginine assay

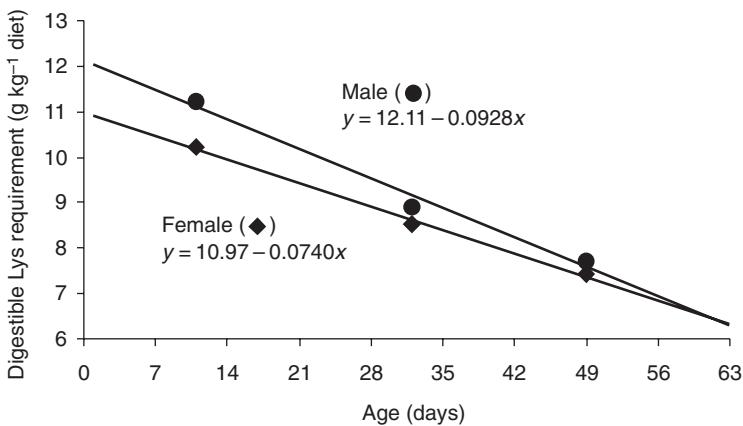
To avoid complications of lysine-arginine antagonism (Chapter 7), we fed graded doses of digestible arginine from 7.2 to  $12.2 \text{ g kg}^{-1}$ , and at each level of arginine the digestible lysine level was set  $1.0 \text{ g kg}^{-1}$  higher. Thus, both arginine and lysine were incremented, but arginine was always lower and first limiting. Although the weight gain response range for the 13-day assay was large (179–338 g), as was the gain/feed response range ( $446\text{--}702 \text{ g kg}^{-1}$ ), the data were not clear-cut in terms of predicting requirement values. Our best estimate of the digestible arginine requirement for maximal weight gain (broken-line inflection point) was  $10.14 \text{ g kg}^{-1}$ . We view this, however, as a preliminary estimate, and a repeat bioassay is needed. Nonetheless, a preliminary estimate of the arginine:lysine ideal ratio was calculated at 105.6% (Table 13.1), a value in good agreement with earlier empirical estimates of 105%

(Baker, 1997) and 104% (Mack *et al.*, 1999, as recalculated). Work from Labadan *et al.* (2001) showed that the arginine requirement was similar to the lysine requirement of broiler chicks during the periods 0–2, 2–4, 3–6 and 5–8 weeks posthatching.

### Applications of Ideal Amino Acid Ratios

Best estimates of digestible lysine requirements of male and female broiler chicks as a

function of age are presented in Fig. 13.7. Requirements are expressed as  $\text{g kg}^{-1}$  for diets containing  $13.4 \text{ MJ kg}^{-1}$  metabolizable energy. Using the revised and updated ideal AA ratios shown in Tables 13.5 and 13.6 together with the regression equations presented in Fig. 13.7, one can calculate digestible AA requirements for broiler chicks at any age period. This was done for three different age periods in Table 13.6 using average ages of 10.5 days (0–21 days), 31.5 days (21–42 days) and 49 days (42–56 days) for substitution into the regression equations for



**Fig. 13.7.** Plot of the digestible Lys requirement ( $y$ ) of male (●) and female (◆) broiler chicks as a function of age ( $x$ ) for diets containing  $13.4 \text{ MJ kg}^{-1}$  metabolizable energy (ME). The requirement values for 0–21 days of age (average = 10.5 days) came from Han and Baker (1991, 1993), for 21–42 days of age (average = 31.5 days) from Han and Baker (1994), and for 42–56 days of age (average = 49 days) from NRC (1994).

**Table 13.5.** Summary of true digestible requirements of male chicks fed a maize gluten meal semipurified diet during the second and third week of life: extrapolation to ideal ratios relative to lysine.

Amino acid	Assay	Broken-line requirement estimate ( $\text{g kg}^{-1}$ )		Ratio (%) <sup>a</sup>
		Weight gain	Gain/feed	
Lysine	1	8.46	9.64	100
Lysine	2	8.49	9.56	100
Tryptophan	3	1.59	1.57	16.6
Threonine	4	5.35	5.33	55.7
Isoleucine	5	5.89	5.81	61.4
Valine	6	7.44	7.43	77.5
Arginine	7	10.14	–	105.6

<sup>a</sup>Based on Assays 1–6, using the higher of requirement estimates for gain and gain/feed ratio. Requirement values were ratioed to the average Lys requirement for gain/feed of  $9.60 \text{ g kg}^{-1}$ .

**Table 13.6.** Predicted requirements ( $\text{g kg}^{-1}$ ) for digestible amino acids in broiler chicks at three different growth periods<sup>a</sup>.

Amino acid	Ideal ratio (%)	0–21 days		21–42 days		42–56 days	
		Male	Female	Male	Female	Male	Female
Lysine	100	11.1	10.2	9.2	8.6	7.6	7.3
Methionine	36	4.0	3.7	3.3	3.1	2.7	2.6
Cystine	36	4.0	3.7	3.3	3.1	2.7	2.6
SAA <sup>b</sup>	72	8.0	7.4	6.6	6.2	5.4	5.2
Threonine	56 (58) <sup>c</sup>	6.2	5.7	5.3	5.0	4.4	4.2
Tryptophan	17	1.9	1.7	1.6	1.5	1.3	1.2
Valine	78	8.7	8.0	7.2	6.7	5.9	5.7
Isoleucine	61	6.8	6.2	5.6	5.2	4.6	4.5
Leucine	109	12.1	11.1	10.0	9.4	8.3	8.0
Arginine	105	11.7	10.7	9.7	9.0	8.0	7.7
Histidine	35	3.9	3.6	3.2	3.0	2.7	2.6
Phe + Tyr	105	11.7	10.7	9.7	9.0	8.0	7.7

<sup>a</sup>The digestible Lys requirement for each age group was calculated based on the equations presented in Fig. 13.7, after which the ideal AA ratios were used to calculate requirements for the other amino acids. A dietary ME value of  $13.4 \text{ MJ kg}^{-1}$  is assumed for all age periods.

<sup>b</sup>SAA, sulphur amino acids.

<sup>c</sup>Based on the report of Emmert and Baker (1997), the ideal Thr:Lys ratio is projected to be 2 percentage units higher for the 21–42 day and 42–56 day age periods than for the 0–21-day age period.

purposes of calculating the digestible lysine requirement.

It is noteworthy that among the AA evaluated by Baker *et al.* (2002), only lysine resulted in a higher requirement for feed efficiency than for weight gain. However, the SAA requirement may be similar to the lysine requirement in this regard (Schutte and Pack, 1995; Baker *et al.*, 1996; Mack *et al.*,

1999). Mack *et al.* (1999) evaluated breast yield as well as weight gain and feed efficiency in their AA requirement studies. Among the AA studied (lysine, methionine, threonine, tryptophan, arginine, isoleucine and valine), there was little evidence that the requirements for maximal breast yield were higher than the requirements predicted for either weight gain or feed efficiency.

## References

- Agricultural Research Council (1981) *The Nutrient Requirements of Pigs*. Commonwealth Agricultural Bureaux, Farnham Royal, UK.
- Almquist, H.J. and Grau, C.R. (1944) The amino acid requirements of the chick. *Journal of Nutrition* 28, 325–331.
- Baker, D.H. (1997) Ideal amino acid profiles for swine and poultry and their applications in feed formulation. *Biokyowa Technical Review* 9, 1–24.
- Baker, D.H. and Han, Y. (1994) Ideal amino acid profile for broiler chicks during the first three weeks posthatching. *Poultry Science* 73, 1441–1447
- Baker, D.H., Fernandez, S.R., Webel, D.M. and Parsons, C.M. (1996) Sulfur amino acid requirement and cystine replacement value of broiler chicks during the period three to six weeks posthatching. *Poultry Science* 75, 737–742.
- Baker, D.H., Batal, A.B., Parr, T.M., Augspurger, N.R. and Parsons, C.M. (2002) Ideal ratio (relative to lysine) of tryptophan, threonine, isoleucine and valine for chicks during the second and third week of life. *Poultry Science* 81, 485–494.

- Bertollo, R.F., Chen, C.Z., Law, G., Pencharz, P.B. and Ball, R.O. (1998) Threonine requirement of neonatal piglets receiving total parenteral nutrition is considerably lower than that of piglets receiving an identical diet intragastrically. *Journal of Nutrition* 128, 1752–1759.
- Chung, T.K. and Baker, D.H. (1992) Ideal amino acid pattern for 10-kilogram pigs. *Journal of Animal Science* 70, 3102–3111.
- Cole, D.J.A. (1980) The amino acid requirements of pigs. The concept of an ideal protein. *Pig News and Information* 1, 201–205.
- Dean, W.F. and Scott, H.M. (1965) The development of an amino acid reference diet for the early growth of chicks. *Poultry Science* 44, 803–808.
- Draper, N.R. and Smith, H. (1981) *Applied Regression Analysis*, 2nd edn. John Wiley & Sons, New York.
- Edwards, H.M., III and Baker, D.H. (1999) Maintenance lysine requirement and efficiency of using lysine for accretion of whole-body lysine and protein in young chicks. *Poultry Science* 78, 1412–1417.
- Emmert, J.L. and Baker, D.H. (1997) Use of the ideal protein concept for precision formulation of amino acid levels in broiler diets. *Journal of Applied Poultry Research* 6, 462–470.
- Fernandez, S.R., Aoyagi, S., Han, Y., Parsons, C.M. and Baker, D.H. (1994) Limiting order of amino acids in maize and soybean meal for growth of the chick. *Poultry Science* 73, 1887–1896.
- Fuller, M.F. (1994) Amino acid requirements for maintenance, body protein accretion and reproduction in pigs. In: D'Mello, J.P.F. (ed.) *Amino Acids in Farm Animal Nutrition*. CAB International, Wallingford, UK, pp. 155–184.
- Han, Y. and Baker, D.H. (1991) Lysine requirement of fast and slow growing broiler chicks. *Poultry Science* 70, 2108–2114.
- Han, Y. and Baker, D.H. (1993) Effects of sex, heat stress, body weight and genetic strain on the lysine requirement of broiler chicks. *Poultry Science* 72, 701–708.
- Han, Y. and Baker, D.H. (1994) Lysine requirement of male and female broiler chicks during the period three to six weeks posthatching. *Poultry Science* 73, 1739–1745.
- Han, Y., Suzuki, H., Parsons, C.M. and Baker, D.H. (1992) Amino acid fortification of a low protein corn-soybean meal diet for maximal weight gain and feed efficiency of the chick. *Poultry Science* 71, 1168, 1178.
- Kidd, M.T., Kerr, B.J. and Anthony, N.B. (1997) Dietary interactions between lysine and threonine in broilers. *Poultry Science* 76, 608–614.
- Labadan, M.C., Hsu, K.-N. and Austic, R.E. (2001) Lysine and arginine requirements of broiler chickens at two to three-week intervals to eight weeks of age. *Poultry Science* 80, 599–606.
- Mack, S., Bercovici, D., DeGroot, G., Leclercq, B., Lippens, M., Pack, M., Schutte, J.B. and Van Cauwenbergh, S. (1999) Ideal amino acid profile and dietary lysine specification for broiler chickens of 20 to 40 days of age. *British Poultry Science* 40, 257–265.
- Mitchell, H.H. (1964) *Comparative Nutrition of Man and Domestic Animals*. Academic Press, New York.
- National Research Council (1994) *Nutrient Requirements of Poultry*, 9th edn. National Academy Press, Washington, DC.
- National Research Council (1998) *Nutrient Requirements of Swine*, 10th edn. National Academy Press, Washington, DC.
- Peter, C.M., Han, Y., Boling-Frankenbach, S.D., Parsons, C.M. and Baker, D.H. (2000) Limiting order of amino acids and the effects of phytase on protein quality in maize gluten meal fed to young chicks. *Journal of Animal Science* 78, 2150–2156.
- Rhone-Poulenc (1993) *Rhodimet<sup>TM</sup> Nutrition Guide*. Rhône-Poulenc Animal Nutrition, Antony Cedex, France.
- Robbins, K.R., Norton, H.W. and Baker, D.H. (1979) Estimation of nutrient requirements from growth data. *Journal of Nutrition* 109, 1710–1714.
- Schutte, J.B. and Pack, M. (1995) Sulfur amino acid requirement of broiler chicks from fourteen to thirty-eight days of age. 1. Performance and carcass yield. *Poultry Science* 74, 480–487.
- Smith, N.K. and Waldroup, P. (1988) Investigations of threonine requirements of broiler chicks fed diets based on grain sorghum and soybean meal. *Poultry Science* 67, 108–112.
- Webel, D.M., Johnson, R.W. and Baker, D.H. (1998) Lipopolysaccharide-induced reductions in food intake do not decrease the efficiency of lysine and threonine utilization for protein accretion in chickens. *Journal of Nutrition* 128, 1760–1766.





# 14 Responses of Growing Poultry to Amino Acids

**J.P.F. D'Mello\***

*Formerly of The Scottish Agricultural College, Edinburgh, UK*

---

## **Introduction**

In common with other vertebrate animals, poultry (chickens, turkeys, ducks and geese) require a core of ten amino acids for optimum growth and food utilization (see Table 1.1). These amino acids must be supplied in the diet in balanced proportions if growth performance is to be maximized. In addition, some combination of the non-essential amino acids should be provided to maximize growth potential. The issue of dietary essential to non-essential amino acid ratios has been presented in Chapter 6. As regards broilers, the data of Bedford and Summers (1985) suggest an ideal ratio of 55:45 for optimal growth performance, efficiency of food utilization and carcass protein accretion.

This chapter reviews the methods used to determine the responses of growing poultry to essential amino acids and attempts to evaluate the wide range of factors that modify these responses. Estimation of 'requirements' for individual amino acids will not be considered here since such information is of limited interpretive value. As Morris (1983) aptly stated: 'what the practical nutritionist needs to know is the rate at which an animal in a given class, in a reasonably well-defined nutritional and environmental context, will respond to incre-

mental inputs of a given nutrient. Armed with this information, and a knowledge of his marginal costs and the value of the extra output, he can calculate an optimum dose.'

## **Methodology**

As with other farm animals, the methods used to determine the responses of growing poultry to an essential amino acid fall into two major categories: empirical and factorial. The latter is often projected as the method for the future as research funds for dose-response studies decline. However, cognizance should be taken of the mass of empirically derived data which serve not only as a means of evaluating responses but also as a source of components of factorial models (see Boorman and Burgess, 1986). There is little doubt that factorial models will contribute significantly to future thinking since they provide a means of assessing requirements in flexible and economic terms. It is claimed that the model approach provides a mechanism for identifying important gaps in existing knowledge. However, empirical methods have contributed significantly to current understanding of factors which genuinely affect the responses of growing poultry to amino acids.

\*E-mail address: f.dmello@ed.sac.ac.uk

It is conventional to consider responses of growing poultry in relation to dietary concentrations of amino acids (e.g. g kg<sup>-1</sup> diet). This appears to be a convenient and satisfactory approach for a number of purposes, including the practical formulation of diets. Another way is to express requirements as a proportion of crude protein (CP) in the diet. However, the use of dietary concentrations may obscure important issues when attempts are made to reconcile the effects of different factors on growth responses to individual amino acids. This is due to the well-known but neglected observation that responses depend not only on dietary amino acid concentration but also on food intake. Food intake, in turn, is affected by a variety of factors including environmental temperature, dietary energy concentration and breed and species of animal. The measurement of food intake is thus crucial in any investigation of amino acid responses in animals fed *ad libitum*. The expression of input in terms of daily intake of an amino acid overcomes the constraints outlined above and provides a means of discriminating between those factors which genuinely influence responses and those which exert their effects through alterations in voluntary food intake.

## Empirical methods

### *Graded supplementation technique*

The empirical method most commonly used to determine amino acid responses in growing poultry involves the addition of graded supplements of the amino acid under test to a basal diet deficient in that amino acid (D'Mello, 1982). These graded additions are accomplished with the crystalline form of the amino acid. A number of criteria must be fulfilled for satisfactory results. It is imperative that the basal diet is sufficiently deficient in the amino acid under investigation and that graded doses of the pure amino acid are employed to generate a smooth and full response curve encompassing both growth-limiting doses and those that elicit a maximum response. It follows that data derived from supplementation experiments involving just one or two additions or those from bioassays which lack maximum

response values are unsuitable for assessing optimal economic doses. In certain instances it may be necessary to use different combinations of those amino acids involved in antagonistic relationships. The measurement of food intake is essential for complete interpretation of data. Providing these criteria are satisfied, the response curve may be used to estimate optimal doses for given rates of growth or food efficiency. In addition, the response curve may be used to determine estimates of slope and plateau values required as important components for the Reading model (Fisher, 1994).

### *Diet-dilution technique*

Fisher and Morris (1970) proposed an alternative empirical method based on the sequential dilution of a high-protein 'summit' diet with an isoenergetic protein-free mixture. This method has been described at length in Chapter 7 since the technique relies on the deliberate creation of an imbalance in the summit diet. The imbalance is accomplished by maintaining large dietary excesses of all essential amino acids except the one under test, which is fixed at a markedly lower level.

### *Limitations*

Neither method is without its limitations. In particular, the graded supplementation technique has been criticized on several counts (Fisher and Morris, 1970; Gous, 1980). Firstly, it is claimed that that dietary amino acid balance changes with each successive dose of the limiting amino acid and that the response may be influenced by this factor. The exact mechanism by which changing amino acid balance might affect the response has never been amplified by the critics. Since any change in amino acid balance would affect food intake rather than the efficiency of utilization of the limiting amino acid (see Chapter 7), the first criticism may be discounted. It is also argued that at high levels of supplementation, the amino acid under test may no longer be first-limiting and that further responses to that amino acid might be prevented by the second-limiting amino acid(s). An additional criticism centres on the alleged difficulty in devising a suitable basal diet which

is sufficiently deficient to allow the use of a wide range of input levels of the limiting amino acid. The final criticism relates to the cost of certain synthetic amino acids which, Gous (1980) maintains, might prevent supplementation studies with the more expensive amino acids.

It is argued that none of the disadvantages just described apply to the diet-dilution technique. Indeed, Fisher and Morris (1970) claimed that this technique satisfied 'all the requirements for a successful assay' and Gous (1980) described it as an 'improved method'. These assertions imply that the diet-dilution technique is capable of yielding more valid response data than the graded supplementation method but no evidence has yet emerged to substantiate this claim.

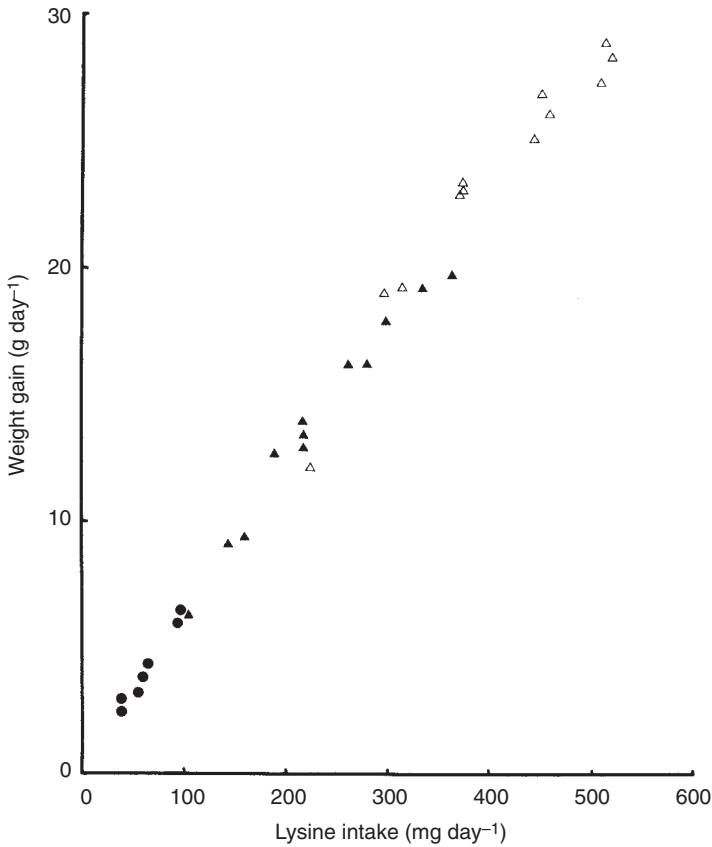
It is instructive to recall that although the initial description of the diet-dilution technique appeared over 30 years ago, the graded supplementation procedure still remains the method of choice in the vast majority of studies on the amino acid responses of growing poultry (Hewitt and Lewis, 1972; Boomgaardt and Baker, 1973; D'Mello and Emmans, 1975; Edwards and Baker, 1999; Tesseraud *et al.*, 1999). It is clear that the cost of amino acids has not been a major deterrent to this research where the primary costs are likely to be capital expenditure and labour. The other criticisms levelled at the graded supplementation technique may also be rejected. In particular, it is possible to discount the assertion that other limiting amino acids may inhibit the maximum response to the first-limiting amino acid. It is now common practice to include generous levels of protein in the diet, and by judicious supplementation it should be possible to ensure adequacy of all other amino acids. In addition, the use of combined supplements of the first- and second-limiting amino acids may be employed (D'Mello and Lewis, 1970; D'Mello and Emmans, 1975). Such an approach has yielded satisfactory responses to arginine and lysine in turkey poults (D'Mello and Emmans, 1975), with maximum growth rates comparable to those observed in groups fed a standard diet. Furthermore, in many studies a wide range of input levels of the first-limiting amino acid

have been ensured (Hewitt and Lewis, 1972; Boomgaardt and Baker, 1973; D'Mello and Emmans, 1975; D'Mello, 1990). Thus there appears to have been little difficulty in devising suitably deficient basal diets or in providing a satisfactory range of intakes of the limiting amino acid. The most serious criticism levelled at the graded supplementation technique relates to the systematic variation in amino acid balance of successive diets within a supplementation series. However, it will be apparent from the account in Chapter 7 that the diet-dilution technique relies on the deliberate imposition of an amino acid imbalance in the summit diet by the provision of all amino acids, except that under test, in substantial excess. This is the precise method for the precipitation of deleterious effects in amino acid imbalance (Harper, 1964; D'Mello and Lewis, 1971; D'Mello, 1990).

D'Mello (1982) stated that although it is relatively straightforward to generate response curves to a single amino acid by the diet-dilution technique, considerable difficulties may emerge when responses to interacting pairs such as lysine and arginine or leucine and valine are to be determined. It was suggested that the responses to arginine or valine would be unreliable owing to the constraint to design the summit diet with large excesses of other amino acids including lysine and leucine. The adverse effects of lysine and leucine are well documented and will be addressed later in this chapter. Gous (1980), however, argues that this issue is readily resolved by formulating a number of dilution series each containing different concentrations of the antagonizing amino acid. The degree of interaction would be indicated by the resultant difference in slope of individual response curves across the series.

### *Comparison of techniques*

In a direct comparison of the two methods, D'Mello (1982) used data obtained by the diet-dilution procedure (Gous, 1980) and by the graded supplementation technique (Boomgaardt and Baker, 1973) with respect to growth responses of broiler chicks to varying lysine intakes (Fig. 14.1). The data of Stockland *et al.* (1970), obtained with rats fed graded supplements of lysine, were also



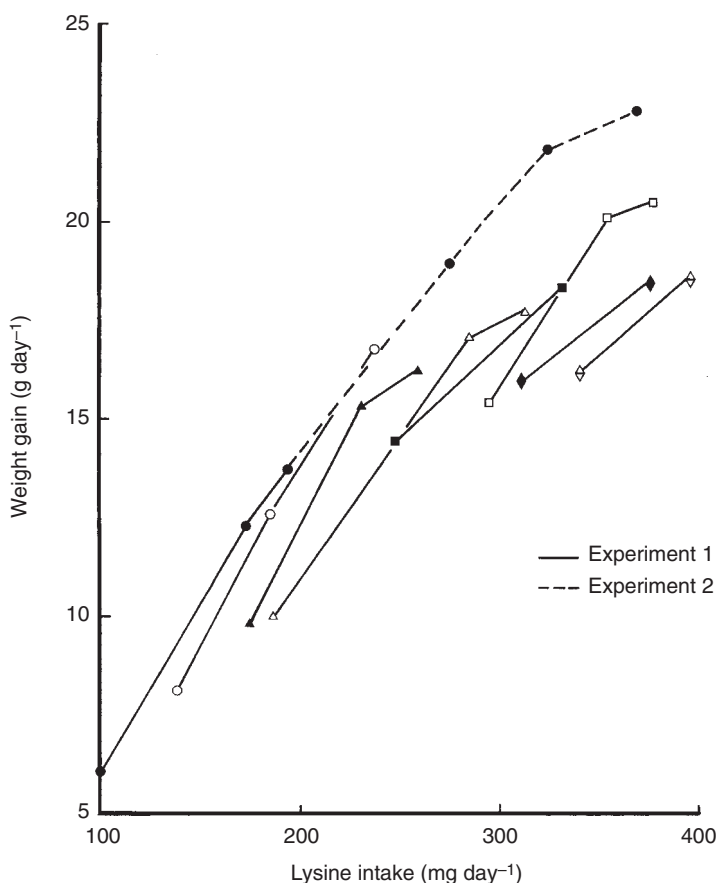
**Fig. 14.1.** Daily weight gain of growing rats and chicks in relation to daily lysine intake. (From D'Mello, 1982; source of data: rats (●), Stockland *et al.*, 1970; chicks (▲), Boomgaardt and Baker, 1973; chicks (△), Gous, 1980. Reproduced with permission of The World's Poultry Science Association.)

incorporated in this figure. It became clear that when growth increments were considered in relation to daily lysine intake both methods yielded similar results with all 'limiting points' contributing to a single response curve. In a subsequent examination of data obtained with turkey poults, D'Mello (1983) confirmed the high degree of compatibility between the two methods. If the diet-dilution technique is a superior method, then the responses generated by the supplementation procedure would be displaced positively with respect to the data of Gous (1980). The agreement between the rat and chick data, irrespective of the method used to elicit responses, is noteworthy. Such interspecies compatibility in amino acid response data is reviewed later in this chapter, but it should

be recognized here that these similarities were obtained with the graded supplementation technique despite wide differences in dietary amino acid balance and in the nature of protein ingredients used. On the basis of the evidence presented in Fig. 14.1, D'Mello (1982) concluded that the lack of confidence in the graded supplementation technique and the projection of the diet-dilution procedure as an improved method could not be justified since both methods yielded concordant growth responses. Boorman and Burgess (1986) arrived at a similar conclusion after a detailed analysis of 15 data sets derived by the supplementation technique and 11 data sets obtained by the diet-dilution method in studies on lysine responses in broiler chicks.

Since the reviews of D'Mello (1982) and Boorman and Burgess (1986), a disquieting feature of the diet-dilution technique has emerged with far-reaching consequences which question the authenticity of earlier attempts to validate the technique (Gous, 1980; Gous and Morris, 1985). It is a condition of this procedure that growth responses are not confounded by the deliberate variation in dietary CP content which occurs on dilution of the summit diet. The method relies on the interpretation of responses to different rates of dilution as responses to the first-limiting amino acid and not to changing dietary CP contents. In this particular respect, Gous and Morris (1985) confirmed that the response in gain when lysine was added to diets

in the dilution series 'corresponded almost exactly to the level of lysine in the diet, irrespective of protein content'. Indeed, multiple regression analysis of the data indicated that CP intake did not contribute significantly to the best-fit model. Gous and Morris (1985) proceeded to question the need to use isonitrogenous diets when determining responses of growing poultry to individual amino acids. However, in subsequent and more detailed investigations with chicks, these authors (Morris *et al.*, 1987; Abebe and Morris, 1990a,b) demonstrated that CP level unequivocally influenced the growth response to an amino acid. The interaction between dietary CP level and lysine intake, shown in Fig. 14.2, represents a



**Fig. 14.2.** Daily weight gain and lysine intake of chicks fed diets containing 140 (●), 160 (○), 180 (▲), 200 (△), 220 (■), 240 (□), 260 (◆) and 280 (◇) g crude protein kg<sup>-1</sup>. (From D'Mello, 1988; source of data: Morris *et al.*, 1987. Reproduced with permission of The World's Poultry Science Association.)

reassessment by D'Mello (1988) of the original data published by Morris *et al.* (1987). In this study, the summit diet containing 280 g CP kg<sup>-1</sup>, first-limiting in lysine, was diluted with a basal diet containing 140 g CP kg<sup>-1</sup> of identical amino acid balance and metabolizable energy (ME) content to yield a series of diets varying in CP content and first-limiting in lysine. Each diluted diet was supplemented with graded levels of pure lysine which, in theory, should have produced responses compatible with those obtained merely by diluting the summit diet. However, it is readily seen (Fig. 14.2) that the growth response obtained on dilution is quite distinct from that obtained on supplementation of each diluted diet with pure lysine. The displacement of response curves at each CP level and the appearance of discrete responses to lysine supplementation question the rigour of the initial procedures used to validate the diet-dilution technique. The CP effect on growth responses to amino acids also holds for tryptophan (Abebe and Morris, 1990b) and methionine (Morris *et al.*, 1992).

Discrepancies recorded between the two techniques are not just restricted to growth responses. As will be seen later in this chapter, marked differences also occur in carcass fat contents of chicks on diluted and amino acid supplemented regimes.

### Factorial methods

In view of the doubts concerning the diet-dilution technique and the criticisms levelled at the supplementation method, it may well be argued that future prospects lie in the development of factorial models for the prediction of growth responses to amino acids. Such a view would imply a clear distinction between empirical and factorial approaches which is not justified in practice since factorial calculations invariably rely on empirically derived values. Thus factorial models depend upon some estimate of maintenance requirements for individual amino acids. For example, in the factorial method proposed by Hurwitz *et al.* (1978), estimates of maintenance requirements of chicks were derived from the empirical values of Leveille *et al.*

(1960) obtained with the adult rooster. Again, in the mathematical model used by Gous and Morris (1985) an estimate of the lysine requirement for maintenance was derived from empirical studies.

In factorial calculations, it is common practice to use single maintenance requirement values for each amino acid. Although such an approach may be justified for most amino acids, in cases of those involved in deleterious interactions maintenance requirements may not be constant. Ousterhout (1960) showed that young chicks fed a diet devoid of lysine survived longer and lost less weight than those fed a diet lacking in arginine. Chicks fed a diet devoid of the three branched-chain amino acids survived longer and lost less weight than those fed diets devoid of either isoleucine or valine. In other studies (Okumura *et al.*, 1985) chicks were fed graded quantities of a standard diet or diets containing only half the recommended concentrations of leucine, isoleucine or valine. Chicks fed the leucine-deficient diet grew at a similar rate to those given similar quantities of the standard diet. In contrast, chicks fed either the valine- or isoleucine-deficient diet grew at a markedly reduced rate than control animals. Overall, these observations imply that amino acid antagonisms may operate in deficiency states and point to the dominant role of leucine in its interactions with its structural analogues. These observations also suggest that the maintenance requirements for valine are unlikely to remain constant and may be influenced to a considerable degree by the relative proportions of the other two branched-chain amino acids (BCAA). For similar reasons, the isoleucine requirement for maintenance may also vary. However, Burnham and Gous (1992) discounted any such effects of branched-chain antagonisms on maintenance isoleucine requirements of adult chickens despite observing an unexpectedly low value for the efficiency of utilization of isoleucine for maintenance. It is not unreasonable to propose that the maintenance requirement for arginine may depend upon the lysine content of the diet. Methodological factors can influence the choice of maintenance requirement values for individual amino acids (Chapter 1).

Thus, Edwards and Baker (1999) showed that the daily total sulphur amino acid (SAA) requirement of chicks for zero protein accretion was  $9.4 \text{ mg kg}^{-0.75}$ , whereas the requirement for zero SAA accretion was  $15.3 \text{ mg kg}^{-0.75}$ .

Factorial models, in general, are constrained to ignore the effects of interactions between amino acids. Thus, Hurwitz *et al.* (1978) specifically excluded such considerations from their model. However, in the computerized mathematical model based on a four-parameter kinetic equation, Muramatsu *et al.* (1991) claim that full account is taken of amino acid antagonisms. Assumptions were included on the basis of the experimental evidence of Austic and Scott (1975) for the lysine-arginine antagonism and of Allen and Baker (1972) for the branched-chain amino acid interactions, further emphasizing the interdependence between factorial and empirical methods.

Another problematic issue in factorial methodology concerns the efficiency of utilization of amino acids for protein gain and for live-weight gain. Boorman and Burgess (1986) illustrate the dilemma for lysine, estimating a net efficiency of utilization of lysine for protein gain as 0.89 whereas a much lower efficiency of 0.71 emerged for live-weight gain. In the cases of several other amino acids, including threonine, leucine and valine, efficiency could not be estimated from existing data and an assumed value of 0.70 was used in the factorial calculations. In actual determinations (Chapter 1), efficiencies of utilization were found to be 0.82 for threonine (Edwards *et al.*, 1997) and 0.73 for valine (Baker *et al.*, 1996).

### Factors Affecting Responses to Amino Acids

The responses of growing poultry to individual amino acids are influenced by a wide range of factors. These include: environmental temperature, immunological stress, sex, age, species and several dietary factors. Critical evaluation indicates that these factors readily resolve into those that influence food intake and those that reduce efficiency

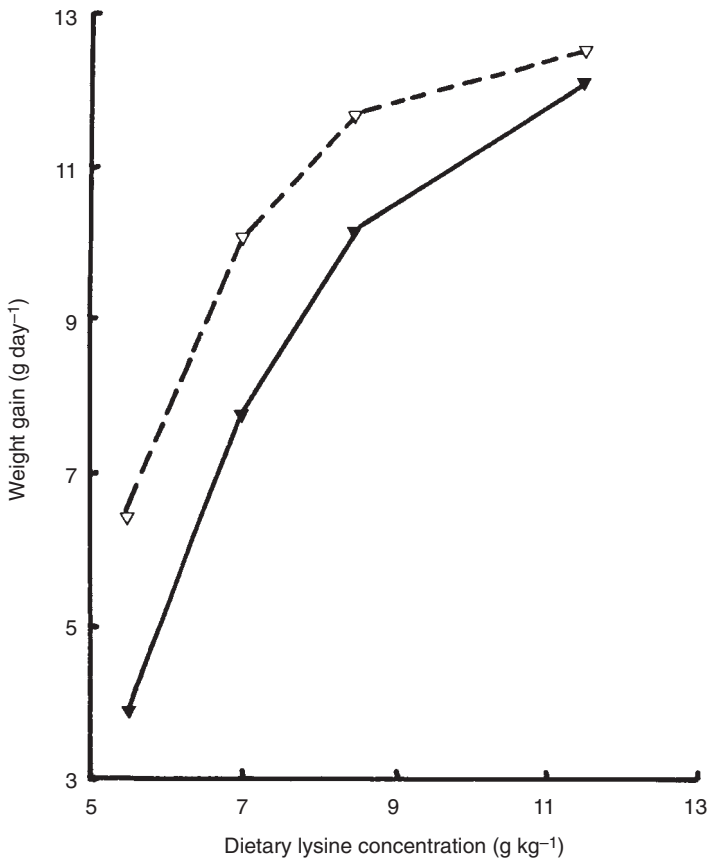
of utilization of the amino acid in question. The distinction between the two categories of factors only emerges if responses are considered in relation to amino acid intake. Food intake-mediated factors may elicit differences in responses when these are plotted against dietary amino acid concentrations. However, any disparity effectively disappears on considering responses in terms of amino acid intake as data points merge into a single response curve. On the other hand, factors reducing the efficiency of utilization of an amino acid induce differences that are sustained even when responses are viewed in the context of amino acid intake. In particular, the appearance of discrete response curves, within the range of limiting intakes, is clear evidence that efficiency of utilization has been affected, whereas differences in asymptote are not relevant in this respect.

### Food intake-mediated factors

#### *Environmental temperature*

March and Biely (1972) and McNaughton *et al.* (1978) investigated the effects of environmental temperature on the growth responses of cockerels fed graded levels of lysine. The results of March and Biely (1972), shown in Fig. 14.3, indicate that when growth is considered in relation to dietary lysine content, two discrete curves are obtained for 20°C and 31.1°C, implying a decrease in the efficiency of lysine utilization at the higher temperature. However, if the same responses are plotted against daily lysine intake (Fig. 14.4) it becomes apparent from the single response curve that lysine utilization has not changed. Chicks at 31.1°C merely consumed less food and higher dietary concentrations of lysine were therefore required to compensate for this reduction in appetite. The daily intake of lysine required to support a given rate of growth was similar at the two temperatures. It is likely that the data of McNaughton *et al.* (1978) would conform with this pattern when responses are considered as a function of lysine intake.



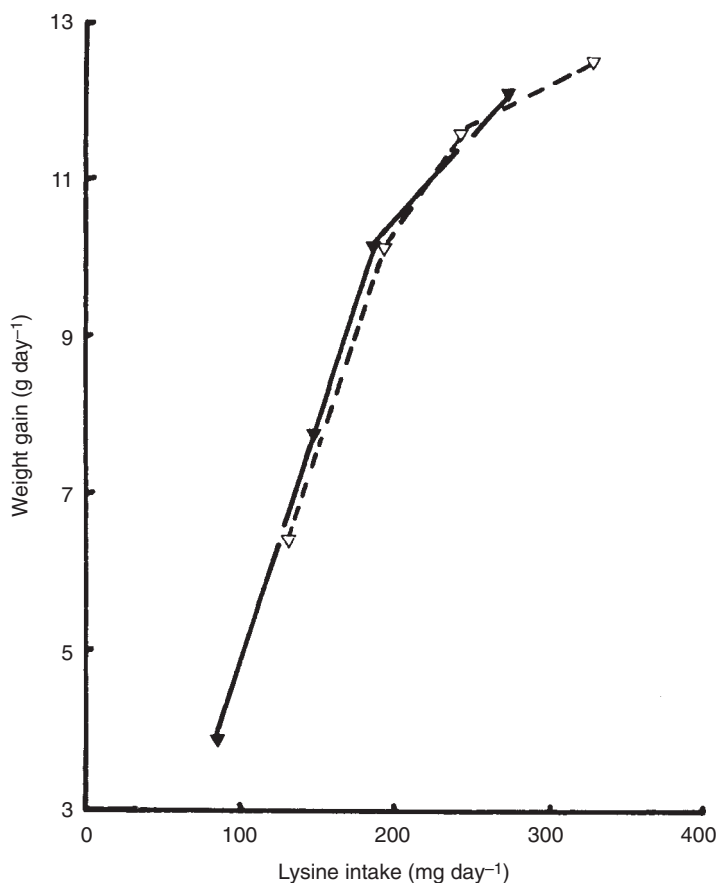


**Fig. 14.3.** The effects of two environmental temperatures (20°C, ∇, and 31.1°C, ▼) on daily weight gain of chicks fed graded concentrations of lysine. (From D'Mello, 1979; source of data: March and Biely, 1972. Reproduced with permission from Butterworth-Heinemann Ltd.)

#### *Immunological stress*

Klasing and Barnes (1988) suggested reduced requirements of growing chicks for SAA and for lysine following immunological challenge with injected bacterial antigens. The immunogens injected included *Escherichia coli* lipopolysaccharide, *Salmonella typhimurium* lipopolysaccharide and heat-treated *Staphylococcus aureus* singly or in rotation. On the basis of the growth results, it was suggested that the lysine requirements of saline-injected control chicks were in excess of 9.5 g kg<sup>-1</sup> diet, whereas immunogen-injected chicks required lysine concentrations of 7–9.5 g kg<sup>-1</sup> diet. However, when the growth responses are

plotted against lysine intake (Fig. 14.5) it becomes apparent that the principal effect of the immunogens is to reduce food intake. Lysine utilization remains largely unaffected since much of the data, particularly those relating to lysine deficiency, appear along a single response curve. The data points for immunogen-treated chicks yield a lower plateau than that for the control group, but this is associated with factors other than lysine intake. If lysine utilization had been affected by immunogen challenge then any differences would have been reflected in discrete response curves over the entire range of lysine intake. Notwithstanding the evidence presented in Fig. 14.5, it should be recognized that growth and food utilization



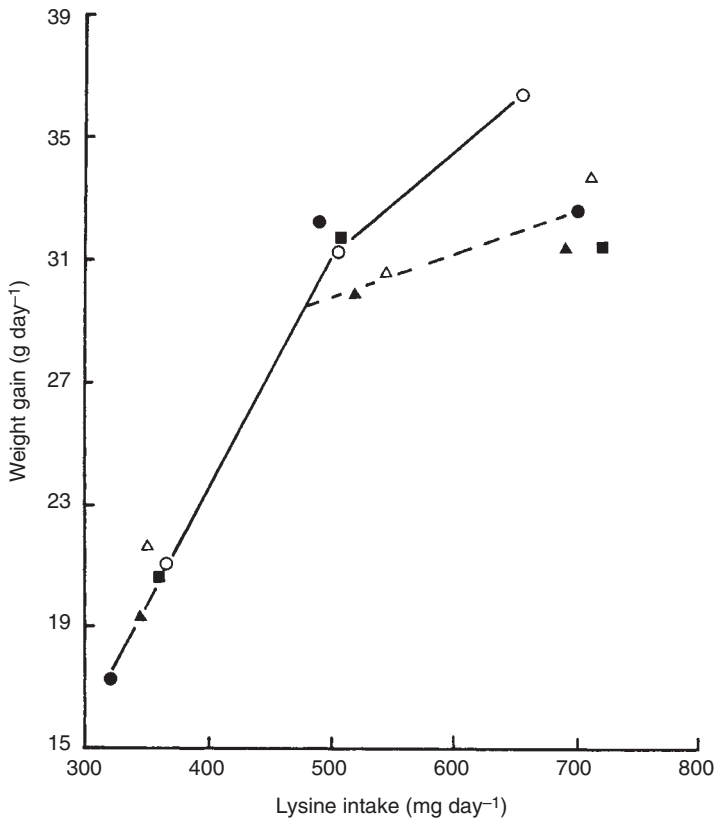
**Fig. 14.4.** Daily weight gain and lysine intake of chicks maintained at two environmental temperatures (20°C, ▽, and 31.1°C, ▲) (From D'Mello, 1979; source of data: March and Biely, 1972. Reproduced with permission from Butterworth-Heinemann Ltd.)

may not represent the most appropriate criteria for quantifying the effects of immunological stress on amino acid requirements (Swain and Johri, 2000). There are reports that amino acid deficiency impairs immune function in broiler chicks and that dietary cysteine and the branched-chain amino acids may exert particular effects in the modulation of immune responses (Konashi *et al.*, 2000; Takahashi *et al.*, 1997).

#### Sex

The responses of male and female broilers to available lysine concentrations in the diet

have been published by Thomas *et al.* (1977). Viewed in terms of dietary concentrations of total lysine, two growth response curves are apparent (Fig. 14.6) implying genuine differences in lysine utilization between males and females. Indeed, having arrived at this conclusion, Thomas *et al.* (1977) developed two regression equations for lysine requirements of male and female broilers. However, when the responses are considered as a function of daily lysine intake (Fig. 14.7) similarities in lysine utilization are seen. Thus, an intake of 600 mg day<sup>-1</sup> would support equivalent growth rates in both males and females.

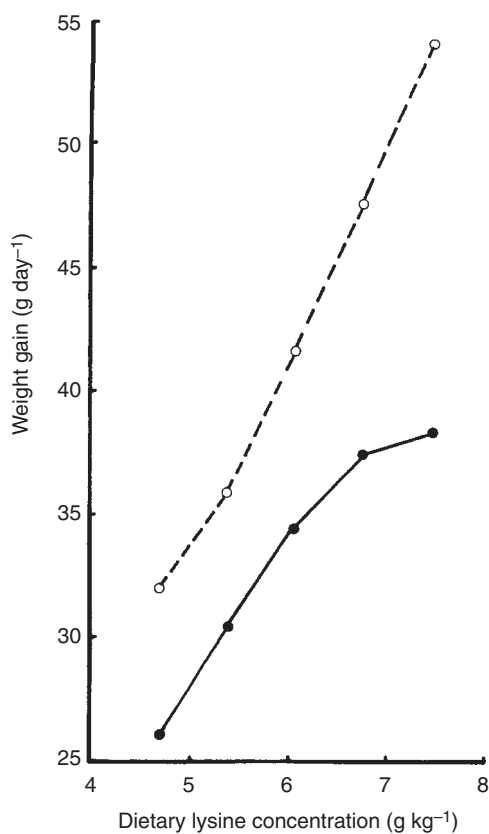


**Fig. 14.5.** Daily weight gain and lysine intake of chicks injected with saline (○) or with immunogens in the form of *E. coli* lipopolysaccharide (●), *S. typhimurium* lipopolysaccharide (▲), or heat-killed *S. aureus* (△). Additional groups of chicks (■) received the three immunogens in rotation. (Source of data: Klasing and Barnes, 1988.)

### Age

It is consistently recorded that amino acid requirements, expressed as proportions of the diet, decrease with age (see National Research Council, 1994). D'Mello (1983) summarized published estimates for the SAA requirements of turkeys of different ages and these are reproduced in Table 14.1. A selection of the response data of Murillo and Jensen (1976) and of Behrends and Waibel (1980) are shown in Fig. 14.8. Expressed in these terms, there is little doubt that dietary requirements do decline with age. Of some concern, however, are the wide discrepancies in recommendations offered by different authors. Viewed in terms of dietary concentrations, the

responses in Fig. 14.8 and the estimates in Table 14.1 appear irreconcilable. However, a different and more reassuring pattern emerges when growth responses from these experiments are considered in relation to daily intakes of SAA (Fig. 14.9). Considering the wide differences in dietary CP contents, ratios of methionine to cystine and ages of turkeys used, there appears to be a marked degree of homogeneity among the different data sets. This agreement is all the more significant in view of the widely held belief that empirical data obtained under one particular set of conditions are unlikely to have universal application. Irrespective of data source, the responses in Fig. 14.9 indicate that turkeys growing at about 30 g day<sup>-1</sup> require 500 mg SAA



**Fig. 14.6.** Daily weight gain of male (○) and female (●) broiler chicks in relation to total dietary lysine concentration. (From D'Mello, 1979; source of data: Thomas *et al.*, 1977. Reproduced with permission from Butterworth-Heinemann Ltd.)

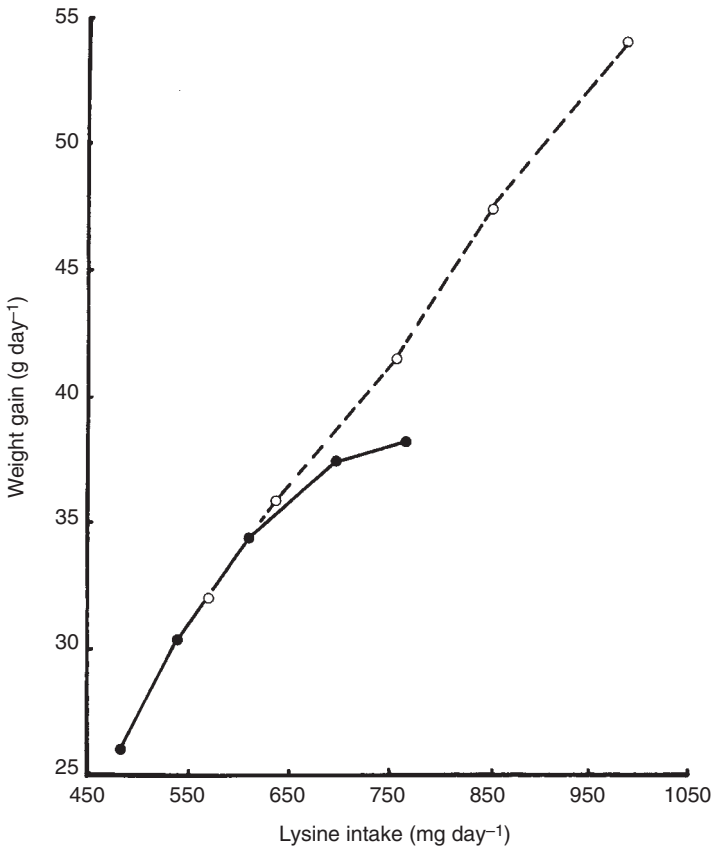
day<sup>-1</sup>, whereas older turkeys growing at 90 g day<sup>-1</sup> require approximately 1700 mg SAA day<sup>-1</sup>. The improved agreement between the data of Behrends and Waibel (1980) and Murillo and Jensen (1976) when responses are considered in relation to SAA intake (Fig. 14.9) may be attributed to variations in food intake caused by differences in the environmental temperatures used in the two studies.

### Species

The amino acid requirements of different species of growing poultry are reviewed on a

regular basis. When expressed as dietary concentrations, differences in requirements are evident, particularly for arginine. Thus, the arginine requirement is estimated to be 12.5 g kg<sup>-1</sup> diet for broiler chicks and 16.0 g kg<sup>-1</sup> diet for turkey poults (National Research Council, 1994). The question arises as to whether these differences reflect genuine variations in amino acid utilization. D'Mello (1979) addressed this issue at some length using evidence from studies specifically designed to compare amino acid utilization in young turkeys and chicks. With respect to arginine (Fig. 14.10) it was suggested that turkey poults and chicks respond similarly to different intakes of this amino acid. Potential growth rates in the turkey, however, are much greater and consequently responses occur to higher intakes of arginine. Food intake per unit of liveweight gain is higher in the chick than in the poult and these two factors together contribute to the much lower arginine requirement of the chick when this value is expressed in terms of dietary concentrations (D'Mello and Emmans, 1975). There is no evidence of any differences in the efficiency of arginine utilization between the two species. Any such difference would have been represented by two discrete response curves in Fig. 14.10. Interspecies similarities were later extended to isoleucine and valine responses for turkey poults and chicks (D'Mello, 1975) whereas in the case of the SAA (D'Mello, 1976), it was observed that data obtained with the laboratory rat also conformed with the responses seen in poultry (Fig. 14.11). The plateaux for the various sets of data indicate the maximum growth possible in the respective experiments with the animals and diets used (Stockland *et al.*, 1973; Boomgaardt and Baker, 1973; D'Mello, 1973a, 1976).

The demonstration of strain differences in arginine utilization by chicks (Nesheim, 1968) is less readily explained and may represent an exception to the general rule. It should be noted that the strains differing in arginine requirements were selected on the basis of their responses to high-casein diets containing excess lysine. Under these conditions there is a clear difference in responses



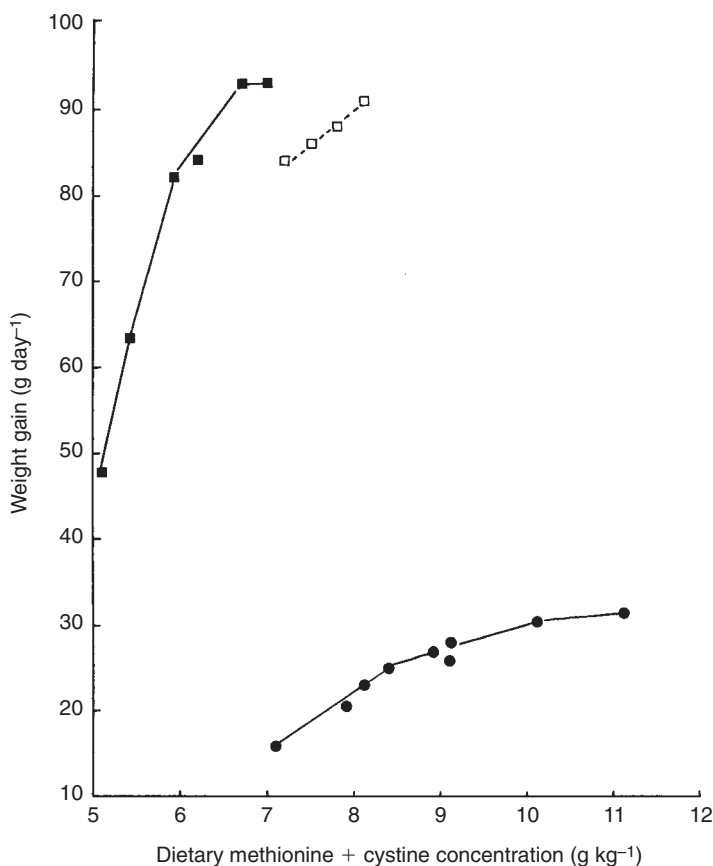
**Fig. 14.7.** Daily weight gain and lysine intakes of male (○) and female (●) broiler chicks. (From D'Mello, 1979; source of data: Thomas *et al.*, 1977. Reproduced with permission from Butterworth-Heinemann Ltd.)

**Table 14.1.** Published estimates of the requirements of turkeys (g kg<sup>-1</sup> diet) for methionine + cystine. (From D'Mello, 1983.)

Reference	Age of turkey (weeks)						
	1-3	1-4	0-4	0-7	4-8	8-12	16-20
D'Mello (1976)	8.3	-	-	-	-	-	-
Murillo and Jensen (1976)	-	-	-	-	-	8.1	-
Potter and Shelton (1976)	-	-	-	10.3	-	-	-
Potter <i>et al.</i> (1977)	-	-	-	11.0-12.0	-	-	-
Potter and Shelton (1978)	-	-	-	9.5	-	-	-
Potter and Shelton (1979)	-	-	11.0	-	10.0	-	-
Behrends and Waibel (1980)	-	9.5-10.1	-	-	-	7.0	4.3-4.8

whether these are considered in relation to dietary concentrations or daily intakes of arginine. But when an arginine-deficient amino acid mixture is used in place of

casein, the strain differences in responses to this deficiency largely disappear. The absence of breed differences in arginine responses of commercial broiler stocks was

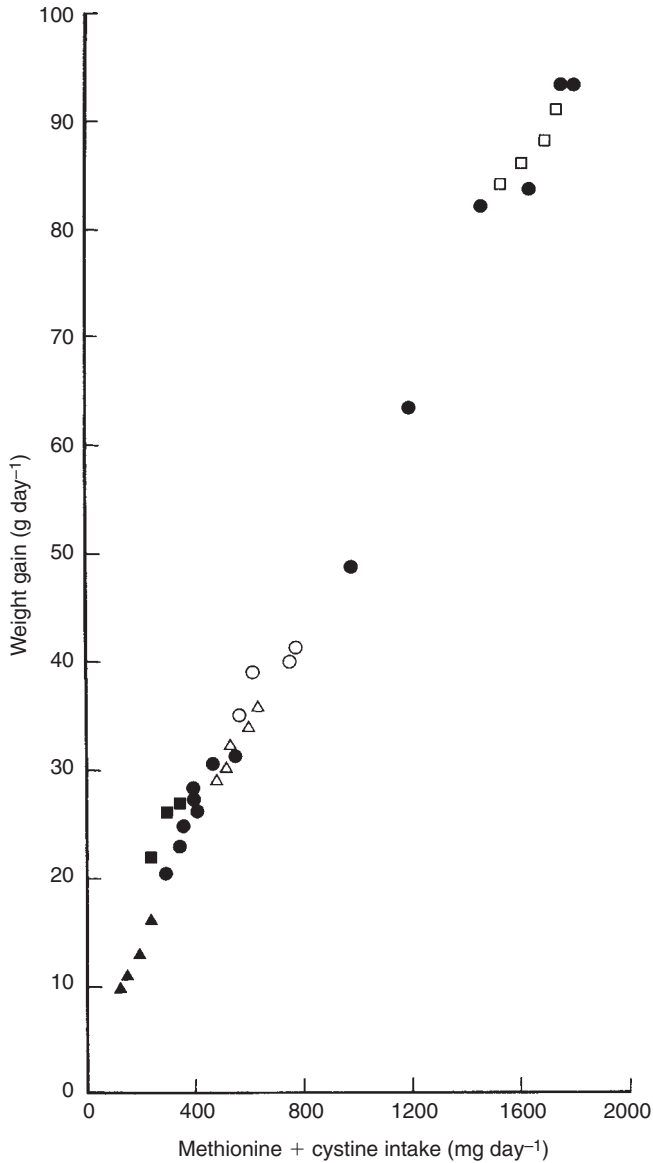


**Fig. 14.8.** The effects of dietary methionine + cystine concentration and age on daily weight gain in turkeys. (Source of data: Behrends and Waibel (1980), 1–4 (●) and 8–12 (■) weeks of age; Murillo and Jensen (1976), 8–12 weeks of age (□).)

demonstrated by Wilburn and Fuller (1975). Their studies with Cobb and Hubbard chicks, fed high-casein diets to accentuate any potential breed effects, indicated only minor differences when growth responses were considered in relation to dietary concentrations. Any discrepancies virtually disappeared when responses were plotted against arginine intake (D'Mello, 1979), suggesting that variations in food intake were primarily responsible for the differences in dietary requirements.

There is currently some interest in the amino acid requirements of genetically lean and fat chickens. In a study of SAA utilization, Leclercq *et al.* (1993) were unable to

distinguish between the two genotypes when growth was considered as a function of SAA intake, although lean chickens deposited these amino acids more efficiently in feather and body proteins. Food intake was depressed and feather synthesis enhanced in lean relative to fat chickens. In addition, Alleman *et al.* (1999) concluded that threonine utilization was very similar in both lines. However, Tesseraud *et al.* (1999) claimed that lysine utilization was more efficient in a low-fat line of broiler chickens than in a control line. Efficiency was assessed by plotting weight gain and muscle protein deposition against lysine intake. The reasons for this discrepancy await elucidation.

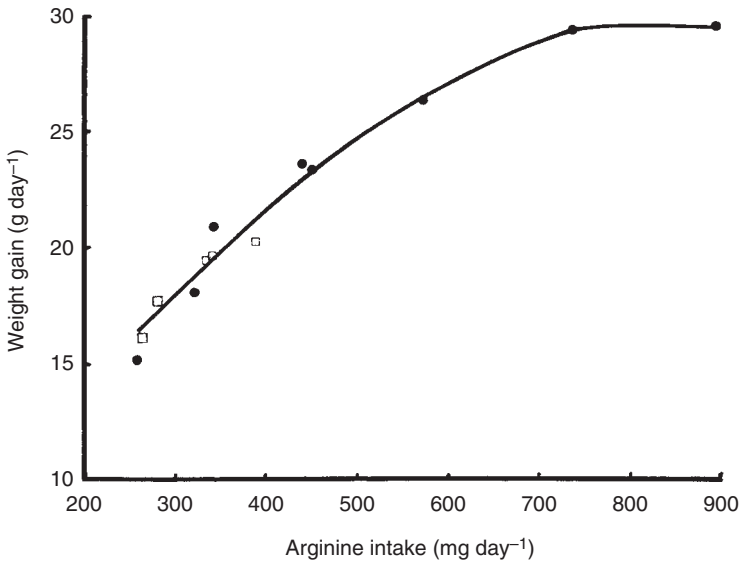


**Fig. 14.9.** Daily growth rates of turkeys in relation to daily intake of methionine + cystine. (From D'Mello, 1983; source of data: Behrends and Waibel, 1980 (●); D'Mello, 1976 (■); Murillo and Jensen, 1976 (□); Potter and Shelton, 1978 (△); Potter and Shelton, 1979 (▲); Potter *et al.*, 1977 (○).)

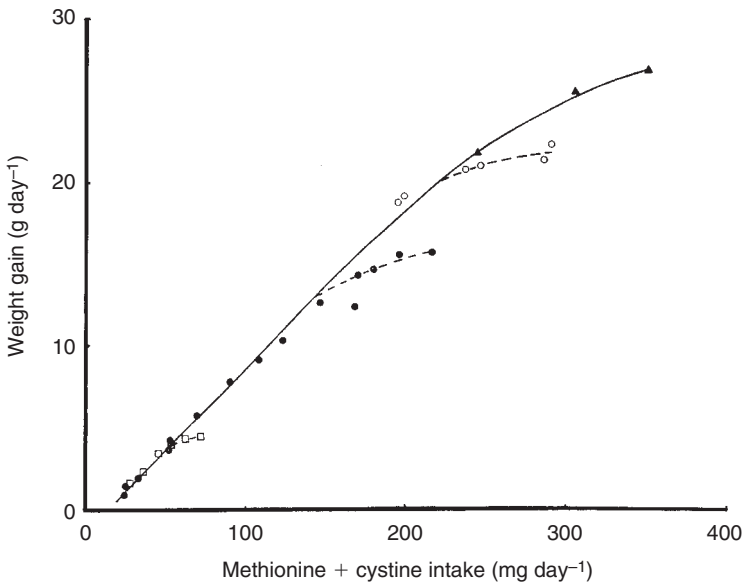
#### *Dietary factors*

**METABOLIZABLE ENERGY CONCENTRATION.** Dietary ME content is widely acknowledged to exert a dominant role in the regulation of food intake in growing poultry. Boomgaardt

and Baker (1973) examined the effects of dietary ME concentration on the response of chicks to graded doses of SAA. cursory evaluation of their results indicates three distinct growth response curves for the three ME concentrations used (Fig. 14.12). However, the

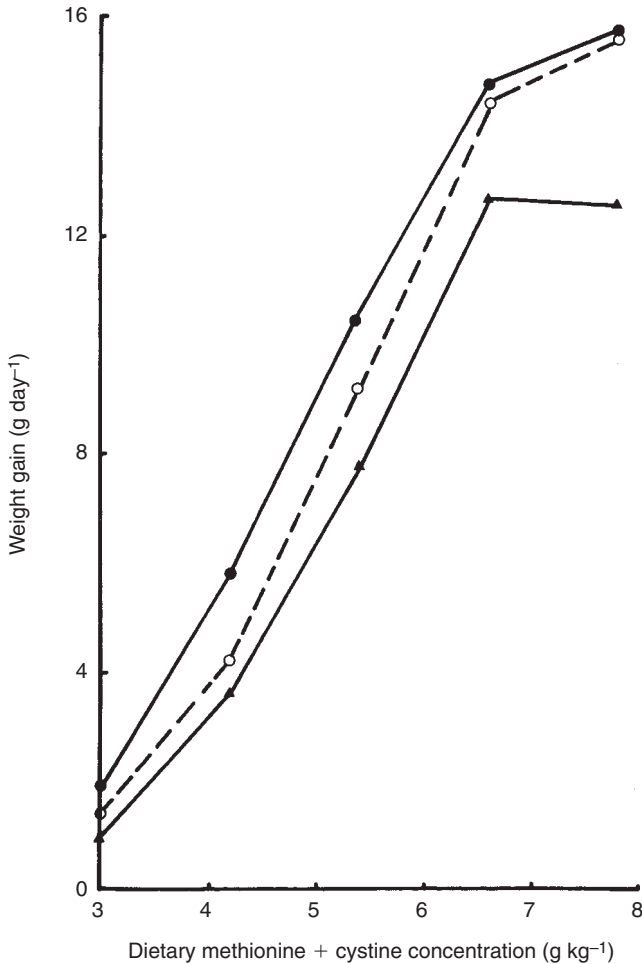


**Fig. 14.10.** Daily weight gain responses of turkey poults (●) and young chicks (□) in relation to daily arginine intake. (From D'Mello and Emmans, 1975; source of data: turkeys, D'Mello and Emmans, 1975; chicks, D'Mello and Lewis, 1970. Reproduced with permission of British Poultry Science Ltd.)



**Fig. 14.11.** Weight gain responses of growing rats (□), slow-growing chicks (●), fast-growing chicks (○) and turkey poults (▲) in relation to methionine and cystine intake. (From D'Mello, 1976; source of data: rats, Stockland *et al.*, 1973; slow-growing chicks, Boomgaardt and Baker, 1973; fast-growing chicks, D'Mello, 1973b; turkeys, D'Mello, 1976. Reproduced with permission of British Poultry Science Ltd.)



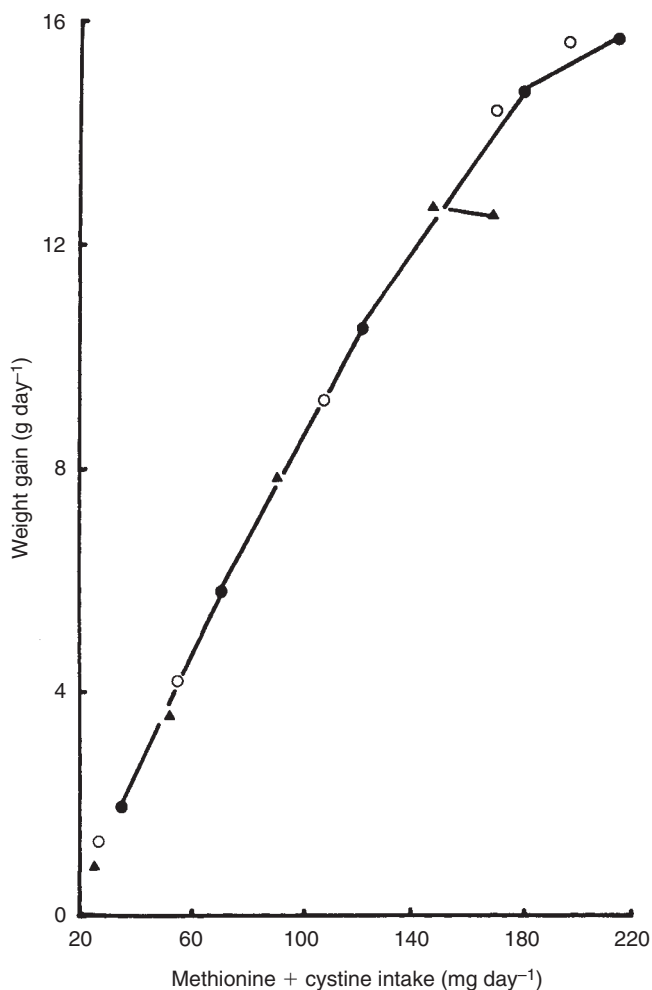


**Fig. 14.12.** Daily growth rates of young chicks in relation to dietary methionine + cystine and metabolizable energy concentrations. Energy levels (MJ kg<sup>-1</sup>): (●) 10.9; (○) 12.6; (▲) 14.2. (From D'Mello, 1979; source of data: Boomgaardt and Baker, 1973. Reproduced with permission from Butterworth-Heinemann Ltd.)

efficiency of utilization of these amino acids is unaffected by energy content of the diet since a single response curve is obtained on plotting weight gain against methionine + cystine intake (Fig. 14.13). It is clear that dietary ME, within the range tested, exerts its effects principally through alterations in food intake and without affecting amino acid utilization.

**AMINO ACID IMBALANCE.** As discussed in Chapter 7, dietary amino acid imbalance precipitates its adverse effects by reducing food intake while the efficiency of amino acid utilization remains

unimpaired (Harper and Rogers, 1965). However, the results of Morris *et al.* (1987) presented in Fig. 14.2 and those of Mendonca and Jensen (1989) and Abebe and Morris (1990b) appear to challenge this universally accepted rule. The responses in Fig. 14.2 indicate that as CP content increases from 140 to 280 g kg<sup>-1</sup> diet there is a marked and progressive reduction in the efficiency of utilization of the first-limiting amino acid, lysine. Both the positive displacement of the response curves and the reduction in the slope of these curves, particularly at the higher CP concen-



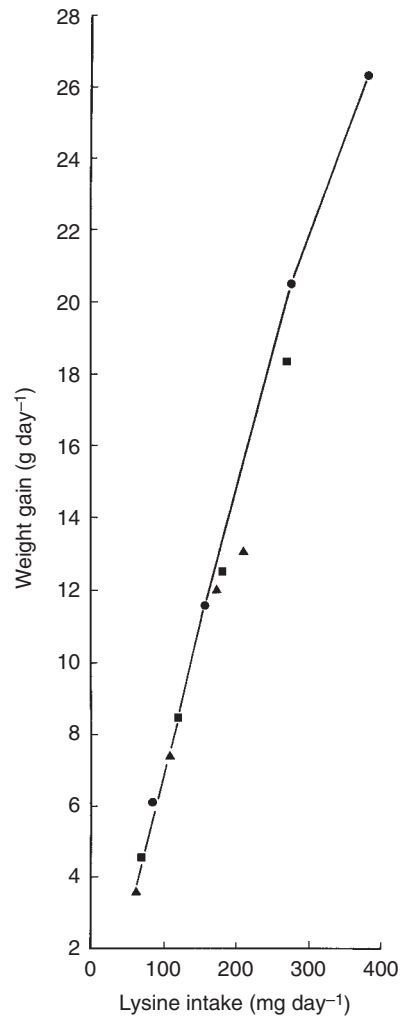
**Fig. 14.13.** Daily chick growth and methionine + cystine intake at three dietary concentrations of metabolizable energy ( $\text{MJ kg}^{-1}$ ): (●) 10.9; (○) 12.6; (▲) 14.2. (From D'Mello, 1979; source of data: Boomgaard and Baker, 1973. Reproduced with permission from Butterworth-Heinemann Ltd.)

trations ( $260$  and  $280 \text{ g kg}^{-1}$  diet) imply substantial decreases in the efficiency of utilization of lysine. It will be noted that the displacement of the response curves occurs even at suboptimal levels of dietary CP. Abebe and Morris (1990b) attributed these responses to an effect of 'general imbalance caused by the excess of amino acids absorbed following digestion of a high protein diet'. Such an explanation is inconsistent with the evidence and with the hypothesis of Harper and Rogers (1965). This hypothesis was originally developed on the basis of metabolic studies with rats and has not

been exhaustively tested in supplementation trials with pure amino acids. Accordingly, D'Mello (1990) conducted an investigation employing crystalline amino acids to bring about changes in CP concentrations and degree of imbalance in lysine-deficient diets fed to young chicks. Three basal diets composed mainly of maize gluten meal, wheat, glucose and amino acids were each formulated to contain  $5.1 \text{ g lysine kg}^{-1}$  dry matter (DM). The first, containing  $225 \text{ g CP kg}^{-1}$  DM served as the control diet. The second and third basal diets were similar to the control apart from the

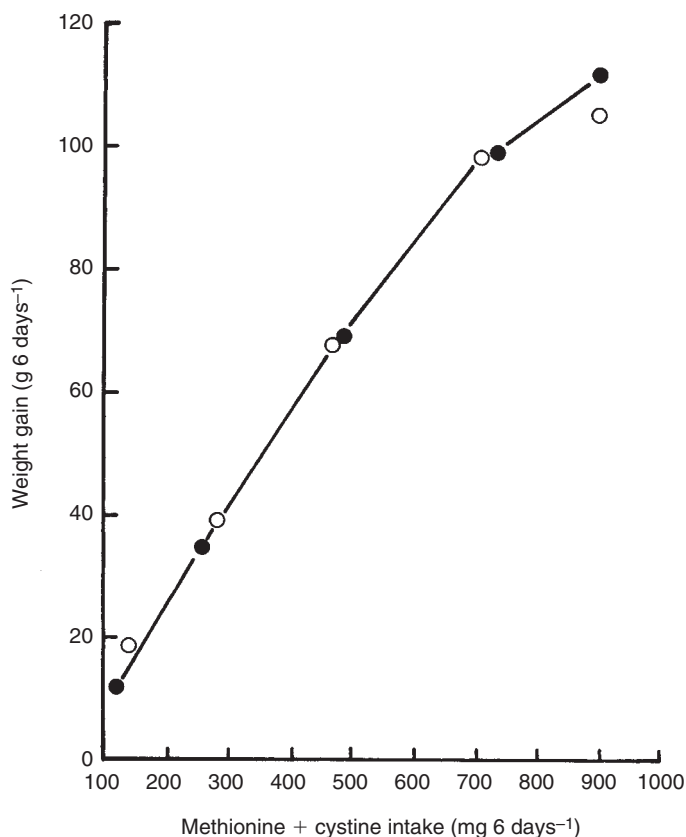
inclusion of a moderately or severely imbalanced mixture of amino acids devoid of lysine. These mixtures were added at the expense of glucose thereby increasing CP concentrations to  $315 \text{ g kg}^{-1} \text{ DM}$ . Each of the three basal diets was supplemented with graded levels of lysine. The relatively poor growth performance of chicks fed the control diet was depressed further by additions of the two amino acid mixtures lacking lysine (Fig. 14.14). This follows the classic pattern established with the rat (Harper and Rogers, 1965). The severity of the adverse effects was directly proportional to the degree of imbalance in the mixtures. In all three dietary regimes graded growth responses occurred to lysine supplementation but chicks in the two imbalanced series failed to attain growth rates comparable to those in the control regimes at equivalent levels of lysine addition. Consequently, growth remained depressed, relative to control, in the imbalanced groups at all levels of lysine addition, the retardation being particularly marked in the severely imbalanced groups. However, a highly significant linear relationship was observed between lysine intake and weight gain with all data points contributing to a single response curve. The appearance on a single response curve of all data points drawn from three diverse dietary regimes suggests that neither CP level nor severity of amino acid imbalance exerts any effect on lysine utilization. This finding is entirely consistent with the observations by Harper and Rogers (1965) and their hypothesis therefore remains intact. It thus appears unlikely that amino acid imbalance is a satisfactory explanation for the protein effect on lysine utilization (Fig. 14.2) and the issues raised by the data of Morris *et al.* (1987) and others (Mendonca and Jensen, 1989; Abebe and Morris, 1990a,b) remain essentially unresolved.

**EFFECTS OF VITAMINS AND COCCIDIOSTATS.** A number of other nutritional factors affect the growth responses of poultry to amino acids by modulating food intake. Thus differences in responses to methionine + cystine induced by feeding chicks adequate or vitamin  $B_{12}$ -deficient diets may be explained in terms of variations in food intake (D'Mello, 1979). Although Willis and Baker (1980) suggested the existence of a strik-



**Fig. 14.14.** Daily weight gain and lysine intake of chicks fed diets containing  $225 \text{ g crude protein kg}^{-1} \text{ dry matter}$  (●) or similar diets supplemented with a moderately (■) or severely (▲) imbalanced mixture of amino acids lacking lysine which increased crude protein content to  $315 \text{ g kg}^{-1} \text{ dry matter}$ . (Source of data: D'Mello, 1990.)

ing interaction between lasalocid (an ionophore coccidiostat) and SAA in diets severely limiting in these amino acids, inspection of Fig. 14.15 indicates that SAA utilization is unaffected by lasalocid supplementation. The coccidiostat merely enhances food intake in chicks fed the deficient diets resulting in higher intakes of SAA with consequent improvements in growth.



**Fig. 14.15.** Weight gain and methionine + cystine intake of chicks fed purified diets without (●) or with (○) lasalocid, 125 mg kg<sup>-1</sup>. (From D'Mello, 1988; source of data: Willis and Baker, 1980. Reproduced with permission of The World's Poultry Science Association.)

### Factors reducing amino acid utilization

Clear reductions in arginine and BCAA utilization have been demonstrated with broiler chickens and turkey poults. These reductions are the result of specific antagonisms (Chapter 7).

#### *Lysine–arginine antagonism*

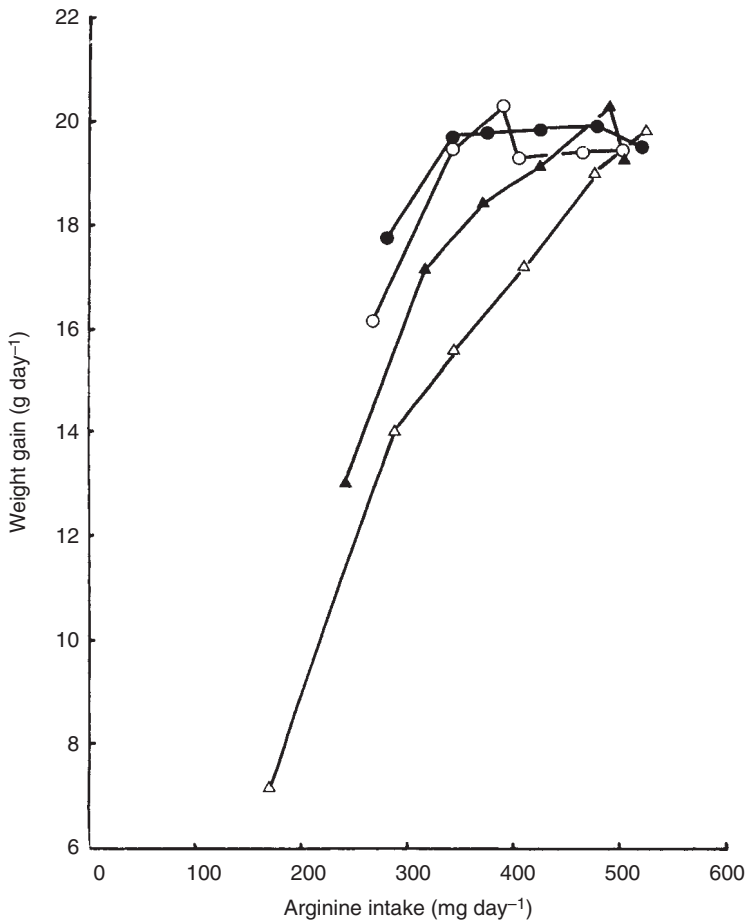
The lysine–arginine antagonism provides a distinctive, but not unique, example of how one amino acid may reduce the efficiency of utilization of another. The results of one such study (D'Mello and Lewis, 1970) are shown in Table 14.2. A basal diet marginally deficient in arginine but adequate in lysine was used. Addition of excess lysine to this basal diet to give concentrations of 13.5, 16.0 and 18.5 g

kg<sup>-1</sup>, progressively reduced growth performance and enhanced the quantity of arginine required to reverse these adverse effects. Thus, at lysine concentrations of 16.0 and 18.5 g kg<sup>-1</sup> diet arginine requirements had increased from 10.0 to 14.5 and 16.0 g kg<sup>-1</sup> diet, respectively. These increases in arginine requirements remained prominent even after responses were considered in relation to arginine intake (Fig. 14.16). The discrete response curves and the changes in slope indicate that arginine utilization is markedly reduced by excess dietary lysine.

The response of growing chicks to the lysine–arginine interaction may be modified by at least two dietary factors. Supplementation with electrolytes, particularly potassium acetate, reduces the severity of this antagonism (O'Dell

**Table 14.2.** Effects of dietary lysine and arginine on daily weight gain (g) of chicks. (From D'Mello and Lewis, 1970.)

Dietary arginine (g kg <sup>-1</sup> )	Dietary lysine (g kg <sup>-1</sup> )			
	11.0	13.5	16.0	18.5
8.5	17.7	16.1	13.0	7.2
10.0	19.6	19.5	17.1	14.0
11.5	19.8	20.3	18.4	15.6
13.0	19.8	19.3	19.1	17.2
14.5	19.9	19.4	20.3	19.0
16.0	19.5	19.4	19.4	19.8

**Fig. 14.16.** Daily growth rates and arginine intake of chicks fed 11.0 (●), 13.5 (○), 16.0 (▲) and 18.5 (△) g lysine kg<sup>-1</sup> diet. (From D'Mello, 1973c. Reproduced with permission of British Poultry Science Ltd.)

and Savage, 1966). A second factor influencing the lysine-arginine antagonism is the presence of other structural analogues of arginine

in the diet. Canavanine is one such analogue occurring naturally in the seed of the legume *Canavalia ensiformis*. The existence of a

canavanine-arginine antagonism in chicks fed this seed has been proposed, with lysine exacerbating the deleterious effects of this interaction (D'Mello *et al.*, 1989; see also Chapter 7).

The practical significance of the lysine-arginine antagonism emanates not only from its relevance to the assessment of arginine requirements of growing poultry but also from its effects in determining the nutritive value of certain feedingstuffs. Thus, Miller and Kifer (1970) noted that the nutritive value of an aged sample of fishmeal could be enhanced by arginine supplementation and impaired by addition of lysine or methionine. Leslie *et al.* (1976) reported the existence of an adverse lysine:arginine ratio in rapeseed meal when it served as the sole source of dietary protein. Under these conditions, arginine supplementation improved the nutritive value of rapeseed meal whereas lysine addition precipitated severe arginine-responsive growth depressions. Arginine supplementation is also beneficial when chicks are fed diets containing single-cell protein sources such as hydrocarbon-grown yeast (D'Mello, 1973b) and methanol-grown bacteria (D'Mello, 1978). Another interesting feature of the bacterial source has been the observation that chicks also respond to supplementation with electrolytes, which act by reducing mortality (Talbot, 1978). It remains to be established whether this represents another dimension of the lysine-arginine-electrolyte interactions discussed earlier.

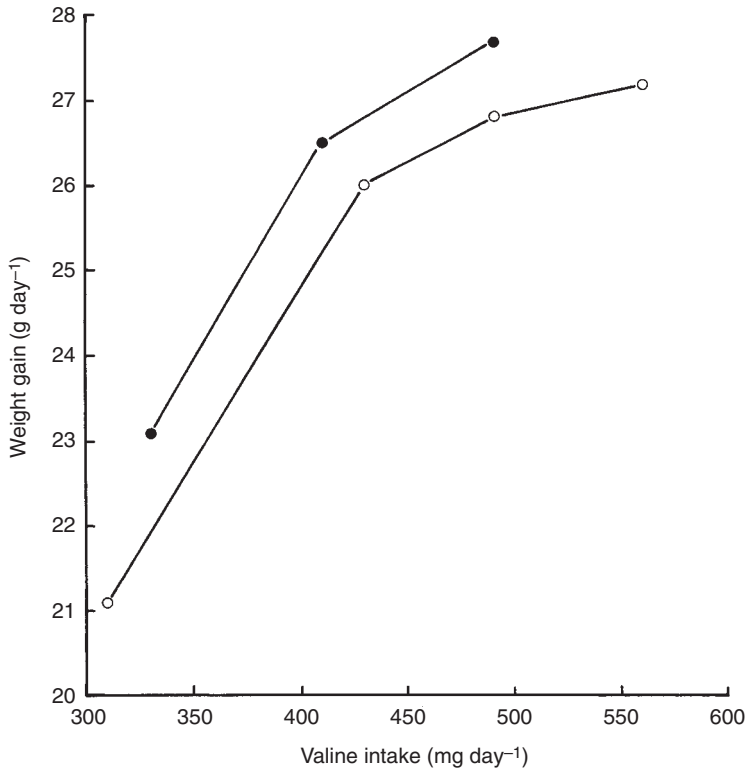
#### *Branched-chain amino acid antagonisms*

Several studies with the young chick and the turkey poult illustrate clear patterns of interdependence in the metabolism of and requirements for BCAA. For example, dietary leucine exerts a profound effect on the valine requirements of the chick. Thus, for leucine concentrations of 14, 24 and 34 g kg<sup>-1</sup> diet, valine requirements are 7.7, 8.9 and 10.1 g kg<sup>-1</sup> diet, respectively (D'Mello and Lewis, 1970). The leucine-isoleucine antagonism has also been described in quantitative terms. Increasing leucine levels from 14 to 21.5 and 29.0 g kg<sup>-1</sup> diet enhances isoleucine requirements of the chick from 5.8 to 6.2 and 6.5 g kg<sup>-1</sup>

diet, respectively (D'Mello and Lewis, 1970). It should be noted that the leucine-isoleucine antagonism is considerably less potent than that between leucine and valine, a feature alluded to by D'Mello and Lewis (1970). Consequently, the observation by Burnham *et al.* (1992) that dietary leucine at 1.76 times requirement depressed chick growth without enhancing isoleucine requirements is consistent with the weak antagonism between these two amino acids. The complexity of antagonistic effects among the BCAA is further illustrated by the impact of dietary isoleucine on valine and leucine requirements. Thus, an isoleucine concentration of 5.2 g kg<sup>-1</sup> diet permitted satisfactory chick growth and efficiency of food utilization with the concentrations of leucine and valine set at 9.8 and 6.3 g kg<sup>-1</sup> diet, respectively. However, an isoleucine concentration of 7.6 g kg<sup>-1</sup> diet increased requirements for leucine and valine to 11.0 and 7.5 g kg<sup>-1</sup> diet respectively (D'Mello, 1974). The extent to which BCAA utilization is affected by mutual antagonisms may be gauged by the growth responses of turkey poults to excess leucine (Fig. 14.17). As the leucine content is increased from 14.2 to 20.2 g kg<sup>-1</sup> diet, there is a positive displacement in the response curve to valine, indicating that valine utilization is impaired by excess leucine (D'Mello, 1988). The lower plateau in the response curve to excess leucine suggests that isoleucine may now be the limiting factor.

#### **Effects of Dietary Amino Acids on Carcass Composition**

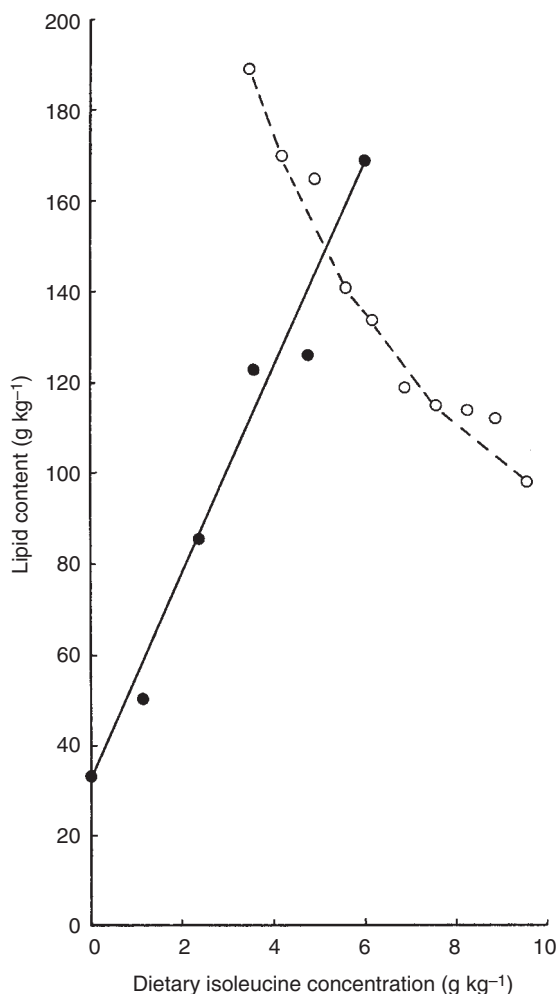
The effects of varying dietary concentrations of amino acids on body composition of growing poultry are imperfectly documented. However, the results of three studies indicated striking effects of dietary isoleucine and lysine on fat content of 3-week-old broiler chicks. Contrasting effects were observed, depending on the degree of deficiency of either amino acid (Figs 14.18 and 14.19). At very low levels of isoleucine or lysine, fat content was relatively low but this increased progressively with graded additions of either amino acid.



**Fig. 14.17.** Daily weight gain and valine intake of turkey poult fed 14.2 (●) and 20.2 (○) g leucine kg<sup>-1</sup> diet. (From D'Mello, 1988; source of data: D'Mello, 1975. Reproduced with permission of The World's Poultry Science Association.)

This, presumably, is a reflection of extremely low food intakes which are a characteristic feature of severe amino acid deficiency (D'Mello and Lewis, 1978; Chapter 7). However, a point was reached for each amino acid when further dietary additions reduced carcass fat content. Thus the effect of an amino acid on carcass fat concentrations depends upon the extent of deficiency, a severe inadequacy eliciting much lower fat concentrations than moderate deficiency. It may be argued that it would be more instructive to consider lipid gain in relation to amino acid intake. However, the lack of requisite data in the paper by Velu *et al.* (1972) does not permit such an approach without employing untenable assumptions. In any event, it is unlikely that any manipulation of data would substantially alter the pattern of contrasting responses shown in Figs 14.18 and 14.19.

It should be noted that the responses relating to severe deficiency (Velu *et al.*, 1972) were derived by the graded supplementation procedure with purified diets. Responses referring to moderate deficiency were obtained by the diet-dilution technique using diets based largely on conventional protein sources (Gous and Morris, 1985; Burnham *et al.*, 1992). The carcass fat data shown in Fig. 14.19 obtained by the diet-dilution method are markedly different from those observed by Seaton *et al.* (1978) with the graded supplementation technique. Their data indicated no effect of lysine, within the range 7.2–16.8 g kg<sup>-1</sup> diet, on carcass fat content of 3-week-old chicks despite continuing growth increments up to 10.4 g lysine kg<sup>-1</sup> diet. Thus methodological aspects should be considered in any interpretation of carcass fat responses to dietary amino acid concentrations.



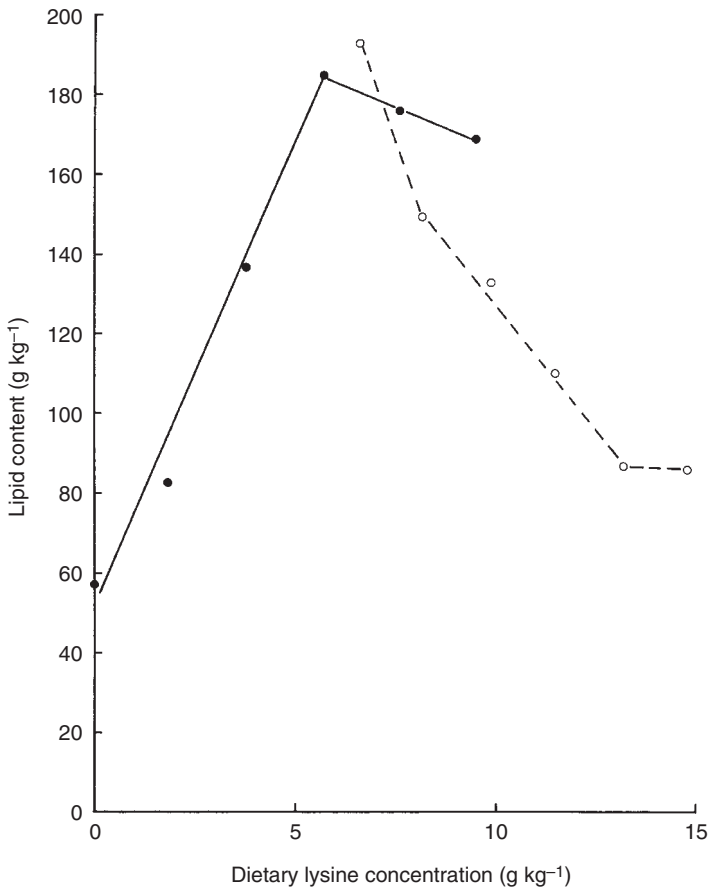
**Fig. 14.18.** The effects of dietary isoleucine concentration on lipid content of broiler chicks at 3 weeks of age. Experimental diets were fed from 8 days of age. (Source of data: Velu *et al.*, 1972 (●); Burnham *et al.*, 1992 (○).)

## Conclusions

The responses of growing poultry to individual amino acids may be determined empirically by the graded supplementation technique or by the diet-dilution method. Although initial evaluation procedures indicated considerable compatibility in growth responses derived by these methods, subsequent research revived the debate concerning the validity of the diet-dilution technique. It is a condition of this procedure that responses

are not confounded by the unavoidable variation in protein contents of diluted diets. It is now known that this condition is not fulfilled since distinct and disparate responses occur to graded supplements of the limiting amino acid at each protein level in the diluted series. Indeed, it has now been concluded that the amino acid requirements of the growing chick are 'a simple linear function of the dietary protein content' (Morris *et al.*, 1987). Their results also implied reduced utilization of the first-limiting amino acid as dietary crude





**Fig. 14.19.** The effects of dietary lysine concentration on lipid content of broiler chicks at 3 weeks of age. Experimental diets were fed from 7 or 8 days of age. (Source of data: Velu *et al.*, 1972 (●); Gous and Morris 1985 (○).)

protein increased. This protein effect on amino acid utilization was attributed to amino acid imbalance. However, a study by D'Mello (1990) employing the supplementation technique indicated that moderate or severe imbalance exerted no effect on the utilization of the first-limiting amino acid. The biochemical basis of the protein effect on amino acid responses of growing chicks remains elusive. A limited analysis of data reveals that the diet-dilution and graded supplementation techniques may elicit contrasting effects on carcass fat content of chicks fed varying dietary concentrations of individual amino acids.

A critical review of factors affecting amino acid responses in growing poultry indicates that environmental temperature, immunological stress, sex, age, species, dietary energy content and dietary amino acid imbalance all exert their effects by altering food intake. However, in the case of deleterious antagonisms such as those involving BCAA or that between lysine and arginine, there are indications of genuine changes in the efficiency of amino acid utilization. In addition, there is limited evidence of genetic differences in amino acid utilization in growing chicks. The implications for other genetic models, including lean and fat lines and transgenic poultry are still unfolding.

## References

- Abebe, S. and Morris, T.R. (1990a) Note on the effects of protein concentration on responses to dietary lysine by chicks. *British Poultry Science* 31, 255–260.
- Abebe, S. and Morris, T.R. (1990b) Effects of protein concentration on responses to dietary tryptophan by chicks. *British Poultry Science* 31, 267–272.
- Alleman, F., Michel, J., Chagneau, A.M. and Leclercq, B. (1999) Comparative responses of genetically lean and fat broiler chickens to dietary threonine concentration. *British Poultry Science* 40, 485–490.
- Allen, N.K. and Baker, D.H. (1972) Quantitative efficacy of dietary isoleucine and valine for chick growth as influenced by variable quantities of excess dietary leucine. *Poultry Science* 51, 1291–1298.
- Austic, R.E. and Scott, R.L. (1975) Involvement of food intake in the lysine–arginine antagonism in chicks. *Journal of Nutrition* 105, 1122–1131.
- Baker, D.H., Fernandez, S.R., Parsons, C.M., Edwards, H.M., III, Emmert, J.L. and Webel, D.M. (1996) Maintenance requirement for valine and efficiency of its use above maintenance for accretion of whole-body valine and protein in young chicks. *Journal of Nutrition* 126, 1844–1851.
- Bedford, M.R. and Summers, J.D. (1985) Influence of the ratio of essential to non-essential amino acids on performance and carcass composition of the broiler chick. *British Poultry Science* 26, 483–491.
- Behrends, B.R. and Waibel, P.E. (1980) Methionine and cystine requirements of growing turkeys. *Poultry Science* 59, 849–859.
- Boomgaardt, J. and Baker, D.H. (1973) Effect of dietary energy concentration on sulphur amino acid requirements and body composition of young chicks. *Journal of Animal Science* 36, 307–311.
- Boorman, K.N. and Burgess, A.D. (1986) Responses to amino acids. In: Fisher, C. and Boorman, K.N. (eds) *Nutrient Requirements of Poultry and Nutritional Research*. Butterworths, London, pp. 99–123.
- Burnham, D. and Gous, R.M. (1992) Isoleucine requirements of the chicken: requirement for maintenance. *British Poultry Science* 33, 59–69.
- Burnham, D., Emmans, G.C. and Gous, R.M. (1992) Isoleucine requirements of the chicken: the effect of excess leucine and valine on the response to isoleucine. *British Poultry Science* 33, 71–87.
- D'Mello, J.P.F. (1973a) Aspects of threonine and glycine metabolism in the chick (*Gallus domesticus*). *Nutrition and Metabolism* 15, 357–363.
- D'Mello, J.P.F. (1973b) Amino acid supplementation of hydrocarbon-grown yeast in diets for young chicks. *Nutrition Reports International* 8, 105–109.
- D'Mello, J.P.F. (1973c) Amino acid interactions in poultry nutrition. In: *Proceedings of 4th European Poultry Conference*. World's Poultry Science Association, London, pp. 331–336.
- D'Mello, J.P.F. (1974) Plasma concentrations and dietary requirements of leucine, isoleucine and valine: studies with the young chick. *Journal of the Science of Food and Agriculture* 25, 187–196.
- D'Mello, J.P.F. (1975) Amino acid requirements of the young turkey: leucine, isoleucine and valine. *British Poultry Science* 16, 607–615.
- D'Mello, J.P.F. (1976) Requirements of the young turkey for sulphur amino acids and threonine: comparison with other species. *British Poultry Science* 17, 157–162.
- D'Mello, J.P.F. (1978) Responses of young chicks to amino acid supplementation of methanol-grown dried microbial cells. *Journal of the Science of Food and Agriculture* 29, 453–460.
- D'Mello, J.P.F. (1979) Factors affecting amino acid requirements of meat birds. In: Haresign, W. and Lewis, D. (eds) *Recent Advances in Animal Nutrition*. Butterworths, London, pp. 1–15.
- D'Mello, J.P.F. (1982) A comparison of two empirical methods of determining amino acid requirements. *World's Poultry Science Journal* 38, 114–119.
- D'Mello, J.P.F. (1983) Amino acid requirements of the turkey poult. In: Larbier, M. (ed.) *Proceedings of the 4th European Symposium on Poultry Nutrition*. World's Poultry Science Association, Tours, France, pp. 66–73.
- D'Mello, J.P.F. (1988) Dietary interactions influencing amino acid utilization by poultry. *World's Poultry Science Journal* 44, 92–102.
- D'Mello, J.P.F. (1990) Lysine utilisation by broiler chicks. *Proceedings of VIII European Poultry Conference, Barcelona, Spain*, pp. 302–305.
- D'Mello, J.P.F. and Emmans, G.C. (1975) Amino acid requirements of the young turkey: lysine and arginine. *British Poultry Science* 16, 297–306.
- D'Mello, J.P.F. and Lewis, D. (1970) Amino acid interactions in chick nutrition. 3. Interdependence in amino acid requirements. *British Poultry Science* 11, 367–385.

- D'Mello, J.P.F. and Lewis, D. (1971) Amino acid interactions in chick nutrition. 4. Growth, food intake and plasma amino acid patterns. *British Poultry Science* 12, 345–358.
- D'Mello, J.P.F. and Lewis, D. (1978) Effect of nutrient deficiencies in animals: amino acids. In: Rechcigl, M. (ed.) *CRC Handbook Series in Nutrition and Food, Section E; Nutritional Disorders*, Vol. II. CRC Press, Boca Raton, Florida, pp. 441–490.
- D'Mello, J.P.F., Acamovic, T. and Walker, A.G. (1989) Nutritive value of jack beans (*Canavalia ensiformis* (L.) (DC.) for young chicks: effects of amino acid supplementation. *Tropical Agriculture (Trinidad)* 66, 201–205.
- Edwards, H.M. III, Baker, D.H., Fernandez, S.R. and Parsons, C.M. (1997) Maintenance threonine requirement and efficiency of its use for accretion of whole-body threonine and protein in young chicks. *British Journal of Nutrition* 78, 111–119.
- Edwards, H.M., III and Baker, D.H. (1999) Maintenance sulphur amino acid requirements of young chicks and efficiency of their use for accretion of whole-body sulphur amino acids and protein. *Poultry Science* 78, 1418–1423.
- Fisher, C. (1994) Responses of laying hens to amino acids. In: D'Mello, J.P.F. (ed.) *Amino Acids in Farm Animal Nutrition*. CAB International, Wallingford, UK, pp. 245–280.
- Fisher, C. and Morris, T.R. (1970) The determination of the methionine requirement of laying pullets by a diet dilution technique. *British Poultry Science* 11, 67–82.
- Gous, R.M. (1980) An improved method for measuring the response of broiler chickens to increasing dietary concentrations of an amino acid. In: *Proceedings of 6<sup>th</sup> European Poultry Conference*, World's Poultry Science Association, Hamburg, Vol. III, pp. 32–39.
- Gous, R.M. and Morris, T.R. (1985) Evaluation of a diet dilution technique for measuring the response of broiler chickens to increasing concentrations of lysine. *British Poultry Science* 26, 147–161.
- Harper, A.E. (1964) Amino acid toxicities and imbalances. In: Munro, H.N. and Allison, J.B. (eds) *Mammalian Protein Metabolism*, Vol. II. Academic Press, New York, pp. 87–134.
- Harper, A.E. and Rogers Q.R. (1965) Amino acid imbalance. *Proceedings of the Nutrition Society* 24, 173–190.
- Hewitt, D. and Lewis, D. (1972) The effect of dietary lysine level, restriction of food intake and sampling time on levels of amino acids in the blood plasma of chicks. *British Poultry Science* 13, 387–398.
- Hurwitz, S., Sklan, D. and Bartov, I. (1978) New formal approaches to the determination of energy and amino acid requirements of chicks. *Poultry Science* 57, 197–205.
- Klasing, K.C. and Barnes, D.M. (1988) Decreased amino acid requirements of growing chicks due to immunologic stress. *Journal of Nutrition* 118, 1158–1164.
- Konashi, S., Takahashi, K. and Akiba, Y. (2000) Effects of dietary essential amino acid deficiencies on immunologic variables in broiler chickens. *British Journal of Nutrition* 83, 449–456.
- Leclercq, B., Chagneau, A.M., Cochard, T., Hamzaoui, S. and Larbier, M. (1993) Comparative utilization of sulphur amino acids by genetically lean or fat chickens. *British Poultry Science* 34, 383–391.
- Leslie, A.J., Summers, J.D., Grandhi, R. and Leeson, S. (1976) Arginine–lysine relationship in rapeseed meal. *Poultry Science* 55, 631–637.
- Leveille, G.A., Shapiro, R. and Fisher, H. (1960) Amino acid requirements for maintenance in the adult rooster. *Journal of Nutrition* 72, 8–15.
- March, B.E. and Biely, J. (1972) The effect of energy supplied from the diet and from environment heat on the response of chicks to different levels of dietary lysine. *Poultry Science* 51, 665–668.
- McNaughton, J.L., May, J.D., Reece, F.N. and Deaton, J.W. (1978) Lysine requirement of broilers as influenced by environmental temperatures. *Poultry Science* 57, 57–64.
- Mendonca, C.X. and Jensen, L.S. (1989) Influence of protein concentration on the sulphur-containing amino acid requirement of broiler chickens. *British Poultry Science* 30, 889–898.
- Miller, D. and Kifer, R.R. (1970) Factors affecting protein evaluation of fish meal by chick bioassay. *Poultry Science* 49, 999–1004.
- Morris, T.R. (1983) The interpretation of response data from animal feeding trials. In: Haresign, W. (ed.) *Recent Advances in Animal Nutrition*. Butterworths, London, pp. 13–23.
- Morris, T.R., Al-Azzawi, K., Gous, R.M. and Simpson, G.L. (1987) Effects of protein concentration on responses to dietary lysine by chicks. *British Poultry Science* 28, 185–195.
- Morris, T.R., Gous, R.M. and Abebe, S. (1992) Effects of dietary protein concentration on the response of growing chicks to methionine. *British Poultry Science* 33, 795–803.

- Muramatsu, T., Ohshima, H., Goto, M., Mori, S. and Okumura, J. (1991) Growth prediction of young chicks: do equal deficiencies of essential amino acids produce equal growth responses? *British Poultry Science* 32, 139–149.
- Murillo, M.G. and Jensen, L.S. (1976) Methionine requirement of developing turkeys from 8–12 weeks of age. *Poultry Science* 55, 1414–1418.
- National Research Council (1994) *Nutrient Requirements of Poultry*. National Academy Press, Washington, DC.
- Nesheim, M.C. (1968) Genetic variation in arginine and lysine utilization. *Federation Proceedings* 27, 1210–1214.
- O'Dell, B.L. and Savage, J.E. (1966) Arginine–lysine antagonism in the chick and its relationship to dietary cations. *Journal of Nutrition* 90, 364–370.
- Okumura, J., Mori, S. and Muramatsu, T. (1985) Relationship between food consumption and energy and nitrogen utilisation by chicks given varying amounts of standard and leucine-, isoleucine- and valine-deficient diets. *British Poultry Science* 26, 519–525.
- Ousterhout, L.E. (1960) Survival time and biochemical changes in chicks fed diets lacking different essential amino acids. *Journal of Nutrition* 70, 226–234.
- Potter, L.M. and Shelton, J.R. (1976) Protein, methionine, lysine and a fermentation residue as variables in diets of young turkeys. *Poultry Science* 55, 1535–1543.
- Potter, L.M. and Shelton, J.R. (1978) Evaluation of maize fermentation solubles, menhaden fish meal, methionine and hydrolyzed feather meal in diets of young turkeys. *Poultry Science* 57, 1586–1593.
- Potter, L.M. and Shelton, J.R. (1979) Methionine and protein requirements of young turkeys. *Poultry Science* 58, 609–615.
- Potter, L.M., Shelton, J.R. and Pierson, E.E. (1977) Menhaden fish meal, dried fish solubles, methionine and zinc bacitracin in diets of young turkeys. *Poultry Science* 56, 1189–1200.
- Seaton, K.W., Thomas, O.P., Gous, R.M. and Bossard, E.H. (1978) The effect of diet on liver glycogen and body composition in the chick. *Poultry Science* 57, 692–698.
- Stockland, W.L., Meade, R.J. and Melliere, A.L. (1970) Lysine requirement of the growing rat: plasma-free lysine as a response criterion. *Journal of Nutrition* 100, 925–933.
- Stockland, W.L., Meade, R.J., Wass, D.F. and Sowers, J.E. (1973) Influence of levels of methionine and cystine on the total sulfur amino acid requirement of the growing rat. *Journal of Animal Science* 36, 526–530.
- Swain, B.K. and Johri, T.S. (2000) Effect of supplemental methionine, choline and their combination on the performance and immune response of broilers. *British Poultry Science* 41, 83–88.
- Takahashi, K., Ohta, N. and Akiba, Y. (1997) Influence of dietary methionine and cysteine on metabolic responses to immunological stress by *Escherichia coli* lipopolysaccharide injection, and mitogenic response in broiler chickens. *British Journal of Nutrition* 78, 815–821.
- Talbot, C.J. (1978) Sodium, potassium and chloride imbalance in broiler diets. *Proceedings of the Nutrition Society* 37, 53A.
- Tesseraud, S., Le Bihan-Duval, E., Peresson, R., Michel, J. and Chagneau, A.M. (1999) Response of chick lines selected on carcass quality to dietary lysine supply: live performance and muscle development. *Poultry Science* 78, 80–84.
- Thomas, O.P., Twining, P.V. and Bossard, E.H. (1977) The available lysine requirement of 7–9 week old sexed broiler chicks. *Poultry Science* 56, 57–60.
- Velu, J.G., Scott, H.M. and Baker, D.H. (1972) Body composition and nutrient utilization of chicks fed amino acid diets containing graded amounts of either isoleucine or lysine. *Journal of Nutrition* 102, 741–748.
- Wilburn, D.R. and Fuller, H.L. (1975) The effect of methionine and lysine levels on the arginine requirement of the chick. *Poultry Science* 54, 248–256.
- Willis, G.M. and Baker, D.H. (1980) Lasalocid-sulphur amino acid interrelationship in the chick. *Poultry Science* 59, 2538–2543.



# 15 Metabolism and *De Novo* Synthesis of Amino Acids by Rumen Microbes

Cengiz Atasoglu and R. John Wallace\*  
Rowett Research Institute, Aberdeen, UK

---

## Introduction

Since the earliest microscopic description of 15–20 species of ‘animalcules’ in the rumen (Gruby and Delafond, 1843), a few landmark discoveries have changed scientists’ understanding of the rumen, its microbial ecosystem and the relations between rumen fermentation and ruminant nutrition. The demonstration that cellulose was digested by microbial activity in the rumen (von Tappeiner, 1884) was a seminal discovery, as was the importance of the microbial fermentation products, the volatile fatty acids, as nutrients for the host animal (Barcroft *et al.*, 1944). By applying habitat-simulating principles to growth medium formulations Hungate (1947) was able to grow the strictly anaerobic rumen bacteria *in vitro*, an accomplishment that had hitherto been impossible and which enabled rumen bacteriology to begin in earnest. Orpin’s (1975) discovery that strictly anaerobic fungi were significant commensal organisms also changed our perception of the rumen in a very significant way.

In terms of rumen protein and amino acid metabolism, there have been no comparable strides forward, rather a steady increase in understanding. The most elegant demonstration of the biosynthetic power of rumen microbes, in terms of amino acid biosynthesis, was made by

Virtanen (1966), who maintained lactating cows on a protein-free diet for many months, the microbial amino acids being synthesized from urea-N. This result was to some degree predictable, however, based on the many *in vitro* studies carried out by Bryant and his colleagues (Bryant, 1973). The review by Chalmers and Synge (1954) was among the first to assemble all known information about nitrogen metabolism in the rumen; it is worth returning occasionally to this excellent review as a historical perspective to appreciate how our impressions of rumen N metabolism have changed.

Amino acid metabolism in the rumen is studied principally because of its nutritional implications. The ruminant relies for its amino acids on the mixture of microbial and surviving feed protein which result from rumen fermentation (Fig. 15.1). Only a fraction of the protein consumed, and to a limited degree some peptides arising from proteolysis, escape rumen fermentation. Once released, amino acids do not survive in the free form for long. They are either incorporated into microbial protein or deaminated to ammonia; free amino acid concentrations are low. In order to maximize the efficiency of amino acid production from the rumen, we would wish to minimize degradation of feed protein to the point where all the protein which is degraded is incorporated by the

\*E-mail addresses: rjw@rri.sari.ac.uk

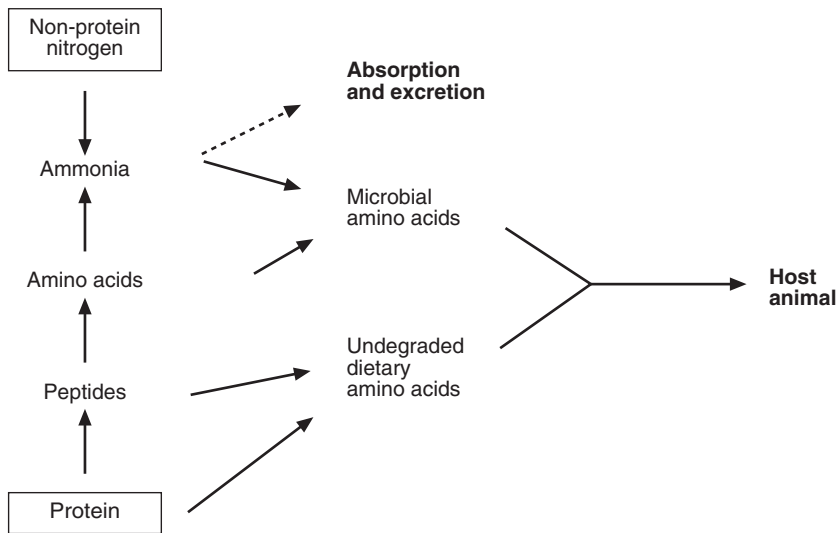


Fig. 15.1. Protein metabolism in the rumen.

microbes. This might not achieve the goals of animal production, however, if providing more amino acids were to increase the rate of fermentation of the energy source and thereby increase feed intake. This chapter aims to review amino acid metabolism by rumen microbes, both in pure and in mixed culture, in a nutritional context.

### Catabolic Sequence of Protein Breakdown to Ammonia in the Rumen

#### Protein breakdown

Protein is the most abundant source of N in most ruminant diets. Feed protein is usually broken down rapidly by the microbial proteases secreted by ruminal bacteria, protozoa and fungi present in the rumen, giving rise to peptides and amino acids, which are then taken up by the microbial cells (Fig. 15.1) (Nolan, 1975; Wallace, 1996; Wallace *et al.*, 1997; Cotta and Russell, 1997). A number of factors, which affect the precise rate and extent of breakdown, ultimately determine the nutritive value of the protein (Wallace *et al.* 1997). Various chemical and physical characteristics of proteins, such as solubility, the

degree of secondary and tertiary structure and the presence of disulphide bonds (Henderickx, 1976; Mahadevan *et al.*, 1980; Wallace, 1983) are important determinants of the susceptibility of proteins to digestion by ruminal microorganisms. Because some proteins are fermented faster than others in the rumen (Wallace, 1994), the rate and extent of protein breakdown to generate peptides and amino acids which are then either incorporated into microbial protein or broken down to ammonia by the ruminal microorganisms is thought to affect ammonia incorporation patterns significantly in the rumen (Hristov and Broderick, 1994). Hristov and Broderick (1994) found that soluble proteins such as casein favoured greater amino acid and lower  $\text{NH}_3$  incorporation in to microbial protein.

A number of different types of proteolytic enzymes are produced and secreted by many strains and species of ruminal ciliate protozoa, bacteria and fungi which have been found to be proteolytic (Wallace, 1994; Wallace *et al.*, 1997). The type of diet is also known to have a major influence on proteolytic activity and the microbial species responsible for that activity (Nugent and Mangan, 1981; Siddons and Paradine, 1981; Hazlewood *et al.*, 1983). Fresh herbage was reported to promote higher proteolytic activity than dry rations, the higher

soluble-protein content of the herbage enriching proteolytic bacteria (Nugent and Mangan, 1981; Hazlewood *et al.*, 1983; Nugent *et al.*, 1983). Cereal diets were also reported to encourage higher proteolytic activities than dry forage diets, probably because these diets are suitable for the proliferation of amylolytic ruminal species which are known to be proteolytic rather than cellulolytic (Siddons and Paradine, 1981). It is noteworthy that the pattern of proteolytic enzymes has been quite variable in animals offered the same or similar diets and housed together (Wallace *et al.*, 1997; Falconer and Wallace, 1998).

Recently, a new suggestion has been put forward that proteolysis is carried out not only by ruminal microorganisms, but also by endogenous plant proteases, which may play a significant role in the breakdown of fresh herbage protein in the rumen (Zhu *et al.*, 1999). Plant proteinases play a significant role in protein breakdown in the silo, and it is logical that they may also have a role in the rumen of grazing ruminants.

### Peptide breakdown

Peptides are intermediates in the degradation of protein to ammonia. The mixed ruminal population breaks down different peptides at different rates (Broderick *et al.*, 1988; Wallace *et al.*, 1990a,b, 1993). Low concentrations of peptides are found in the rumen during the degradation of proteins such as ovalbumin and fraction I protein (Mangan, 1972; Nugent and Mangan, 1981; Broderick and Wallace, 1988), but peptides accumulate when more rapidly degraded proteins are broken down, reaching a peak concentration 1–2 h after feeding and declining thereafter (Chen *et al.*, 1987a,b; Broderick and Wallace, 1988). Chen *et al.* (1987b) reported that hydrophilic peptides are more rapidly broken down by the mixed ruminal bacteria than hydrophobic ones, and concluded that the hydrophobicity of peptides determines their rate of degradation. However, Wallace *et al.* (1990a) found that the structure of the N-terminal end of the peptide chain has the greatest influence on the rate of peptide hydrolysis. The conclusion of Chen *et al.* (1987b) has not been recently sus-

tained by Depardon *et al.* (1995), who indicated that hydrophobicity is not a major factor in the rate of peptide degradation, based on the study with a soy protein hydrolysate. Peptides which are more resistant than others to degradation have a predominant amino acid sequence, typically appear to be Gly-Gly, Pro-X or X-Pro residues at the N-terminus or >1 acidic residue in the peptide (Wallace *et al.*, 1990a; Yang and Russell, 1992; Wallace, 1996). Peptides which survive for a long period of time in rumen fluid tend to be enriched in these amino acids (Wallace and McKain, 1990).

The great majority of peptidase activity is aminopeptidase (Wallace *et al.*, 1990a), a property that confers a high degree of resistance to ruminal degradation on N-terminally blocked peptides (Wallace *et al.*, 1993). Wallace and McKain (1990) found a low response of some of the peptides present in ruminal fluid several hours after feeding to the peptide reagent, fluorescamine, which requires a free  $-NH_2$  group to react. Hence some of these peptides may survive degradation because they are naturally N-formylated or -acetylated. Other peptides are broken down extremely rapidly (Wallace, 1996), and it is the breakdown of these peptides that is of greatest concern.

Peptide hydrolysis in the rumen consists of two steps. The first is an aminopeptidase activity which cleaves dipeptides rather than single amino acids from the peptide chain (Wallace *et al.*, 1990a; Depardon *et al.*, 1995; Wallace, 1996). Enzymes that carry out this process are classified as dipeptidyl peptidases (Webb, 1992). Studies using synthetic peptidase substrates demonstrated that dipeptidyl-X substrates are much more rapidly broken down than amino acyl-X substrates (Wallace, 1996). The dipeptides are then cleaved to amino acids by separate dipeptidases (Fig. 15.2).

Ionophores such as monensin and tetracycline cause an accumulation of peptides in ruminal fluid or *in vitro* fermentations (Whetstone *et al.*, 1981; Newbold *et al.*, 1990; Wallace, 1992a). However, the acute addition of such ionophores did not effect the rate of peptide breakdown (Wallace *et al.*, 1990b), suggesting that time is needed for



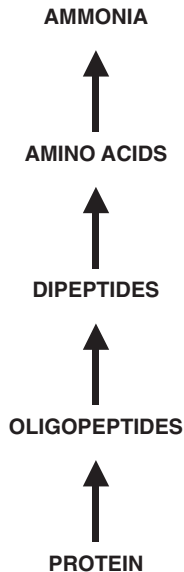
**Possible interventions**

Monensin  
LY29  
Essential oils  
Diaryl iodonium  
compounds

Chelators

Benserazide  
GlyPhe-diazomethylketone  
Acetylation of peptides

Physical or chemical  
protection  
Decrease plant proteinases

**Microbes responsible**

HAP bacteria: *Clostridium*, *Eubacterium*,  
*Peptostreptococcus*, *Acidaminococcus* spp.  
Non-HAP bacteria: *Prevotella*, *Butyrivibrio*,  
*Megasphaera*, *Selenomonas* spp.  
Protozoa: *Entodinium* spp.

Bacteria: *Prevotella*, *Fibrobacter*, *Butyrivibrio*,  
*Lachnospira*, *Megasphaera*, *Selenomonas* spp.  
Protozoa: *Entodinium*, *Isotricha*, *Dasytricha* spp.

Bacteria: *Prevotella* spp., *Ruminobacter amylophilus*,  
*Streptococcus bovis*

Bacteria: *Prevotella*, *Butyrivibrio*, *Clostridium*,  
*Eubacterium*, *Fusobacterium*, *Lachnospira*,  
*Selenomonas* spp., *R. amylophilus*, *S. bovis*  
Fungi: *Neocallimastix*, *Piromyces* spp.  
Protozoa: *Entodinium*, *Ophryoscolex*, *Epidinium*,  
*Isotricha*, *Polyplastron*, *Dasytricha* spp.

**Fig. 15.2.** The catabolic sequence from protein to ammonia in the rumen: microbes and interventions. HAP, hyper-ammonia producing.

adaptation. It is possible that the composition of the microbial population in the rumen is altered as a result of ionophore use, resulting in a change in peptide metabolism. Alternatively, the mode of action of ionophores may be on the membrane permeability of *Prevotella ruminicola*, the only common bacterial species that possesses high dipeptidyl peptidase activity, which decreases its membrane permeability upon prolonged exposure to ionophores, and slows its rate of peptide metabolism (Newbold *et al.*, 1992).

### Amino acid breakdown

Amino acid breakdown is the final step in the conversion of dietary protein into ammonia. The rate of amino acid degradation is usually greater than that of amino acid utilization by the ruminal microorganisms, excess amino acids being broken down, and amino acids are therefore the most important source of ammonia in the rumen (Al-Rabbat *et al.*,

1971; Chalupa, 1976). Low concentrations of amino acids are found in ruminal fluid even just after feeding (Leibholz, 1969; Chalupa, 1976; Wallace, 1979). This observation might be misleading, because the extent to which peptide-bound amino acids are taken up into cells may be quite different from that of the corresponding free amino acids (Prins *et al.*, 1979). Glutamate, for example, is present almost totally as intracellular pools (Wright and Hungate, 1967; Wallace, 1979). The extent to which peptides accumulate varies with diet, with the highest concentrations observed after feeding lucerne hay (Leibholz, 1969). Accumulation of amino acids from rapidly degraded, but not slowly degraded, protein was demonstrated by Broderick and Wallace (1988). Hino and Russell (1985) compared the deaminase activity of intact microorganisms and cell extracts, and concluded that the high capacity for deamination implied that the rate of uptake of peptides or amino acids into cells might limit the rate of ammonia production.

It has been demonstrated that specific amino acids are broken down at different rates and interaction between certain amino acids exists. Chalupa (1976) provided information on the degradation of physiological quantities of amino acids under *in vitro* and *in vivo* conditions, and demonstrated that of the amino acids essential to the animal, arginine and threonine are broken down rapidly ( $0.5\text{--}0.9\text{ mmol h}^{-1}$ ), lysine, phenylalanine, leucine and isoleucine are broken down at  $0.2\text{--}0.3\text{ mmol h}^{-1}$  and formed an intermediate group, whereas valine and methionine are least rapidly degraded ( $0.10\text{--}0.14\text{ mmol h}^{-1}$ ). Interaction in the degradation of amino acids was also demonstrated in the same study; although methionine had a minor influence on valine breakdown, its degradation significantly decreased in the presence of valine. Similarly, non-essential amino acids were also metabolized at least as rapidly as essential amino acids (Broderick and Balthrop, 1979).

More recently, a major focus of research has been directed to the nature of the microbial population that is primarily responsible for ammonia production *in vivo* (Table 15.1). There has been a long-held assumption for many years that a large group of bacteria identified by Bladen *et al.* (1961) was responsible for deamination in the rumen, but Russell and his colleagues at Cornell University found that these bacteria do not have sufficient activity for observed rates of ammonia production, and isolated a group of bacteria that were much less numerous than the others, but which possessed exceptionally high ammonia-producing activity (Chen and Russell, 1988, 1989a; Russell *et al.*, 1988, 1991). These new isolates were asaccharolytic, relying on the fermentation of amino acids for growth. Moreover, unlike the others, they were highly sensitive to monensin, and since ammonia concentrations are lower when this dietary ionophore is received by ruminants, it was concluded that they must be significant ammonia producers *in vivo*. The species isolated, *Peptostreptococcus anaerobius*, *Clostridium sticklandii* and *Clostridium aminophilum* (Paster *et al.*, 1993), were atypical of the main ruminal species, although a large number of clostridia have been isolated from the rumen over the years (Stewart *et al.*, 1997). These

bacteria did not ferment sugars but used amino acids as their main source of carbon and energy as well as nitrogen source. Thus it can be concluded that amino acid deamination could be carried out predominantly by numerically abundant bacteria each having low activity, or by relatively few species with exceptionally high deaminative activity.

Subsequently, similar 'ammonia-hyper-producing' (HAP) species – were isolated in New Zealand (Attwood *et al.*, 1998) and Australia (McSweeney *et al.*, 1999). In the former study, Attwood *et al.* (1998) isolated 14 morphologically different species from pasture-grazed cows, sheep, and deer. The isolates were similar in function to the HAP species isolated previously, but all were genotypically different. A greater diversity of HAP species was also indicated in the isolates made by McSweeney *et al.* (1999) from goats receiving tannin-rich *Calliandra calothyrsus*. Furthermore, some of the isolates were saccharolytic and/or proteolytic, suggesting that the HAP niche is not occupied only by asaccharolytic organisms, but also by organisms with wider biochemical functions. As in other areas of microbial ecology, the population size of the amino acid fermenters, and the effects of diet, inhibitors, etc., will in future be determined more easily by the use of molecular techniques (Krause and Russell, 1996).

### Urea breakdown

Ammonia is formed extremely rapidly from the breakdown of urea in the rumen and can then be used for amino acid synthesis. This activity enables ruminants to utilize urea entering the rumen either with the feed (Virtanen, 1966; Salter *et al.*, 1979; Roffler and Satter, 1975), or endogenous salivary secretion, or by diffusion across the rumen wall (Kennedy and Milligan, 1980). The enzyme mechanism is a simple hydrolysis by urease, which can be inhibited *in vitro* by acetohydroxamic acid (Makkar *et al.*, 1981). The ruminal enzyme is probably similar to jackbean urease in its Ni content, judging by the stimulation of ruminal urease activity by dietary Ni (Spears *et al.*, 1977; Spears and Hatfield, 1978). Urease is associated with the particulate microbial

**Table 15.1.** 'Hyper-ammonia producing', amino acid-fermenting bacteria isolated from the rumen.

Study	Location	Source	Isolates	Properties
Russell <i>et al.</i> (1988)	Cornell, USA	Cow consuming timothy hay/concentrate mixture	<i>Peptostreptococcus anaerobius</i>	Non-saccharolytic iso-acids producer
Chen and Russell (1989a)	Cornell, USA	Cow consuming timothy hay/ concentrate mixture	<i>Clostridium aminophilum</i> <i>Clostridium sticklandii</i>	Non-saccharolytic acetate, butyrate producer Non-saccharolytic acetate, iso-acids producer
Attwood <i>et al.</i> (1998)	New Zealand	Grazing cow Grazing deer  Grazing sheep	<i>Eubacterium</i> spp. <i>Peptostreptococcus</i> spp. <i>Fusobacterium</i> spp. <i>Peptostreptococcus</i> spp.	Non-saccharolytic acetate, butyrate producer Non-saccharolytic iso-acids producer Non-saccharolytic acetate, butyrate producer Non-saccharolytic acetate, butyrate producer
McSweeney <i>et al.</i> (1999)	Queensland, Australia	Sheep and goats receiving <i>Calliandra</i>	<i>Clostridium</i> spp.	Non-saccharolytic, proteolytic, lactate, propionate, butyrate, valerate producer
Eschenlauer <i>et al.</i> (2002)	Aberdeen, UK	Sheep consuming mixed grass hay/concentrate diet	<i>Clostridium/Eubacterium</i> spp. <i>Acidaminococcus</i> spp. <i>Desulfomonas</i> spp.	Non-saccharolytic butyrate, valerate, caproate producer Non-saccharolytic acetate, butyrate producer Non-saccharolytic lactate producer

fraction of ruminal fluid, and is predominantly of microbial origin (Gibbons and McCarthy, 1957; Jones *et al.*, 1964; Mahadevan *et al.*, 1976). No urease activity was found in either starved, antibiotic-treated ciliate protozoa (Onodera *et al.*, 1977) or in *Piromyces* or *Neocallimastix* fungal isolates (Sakurada *et al.*, 1994). Urea is not hydrolysed in the absence of the microbial population, when its concentration in the rumen is the same as that in blood (Cheng and Wallace, 1979).

Urease is one of the most variable enzyme activities in ruminal contents. Many factors influence urease activity, such as Ni in the diet. Ammonia may suppress activity (Cheng and Wallace, 1979), and urea is an inducer (Czerkawski and Breckenridge, 1982). It is of interest to understand urease regulation, because the principal disadvantage of urea as a source of non-protein nitrogen is that it is broken down too rapidly, resulting in ammonia overflow and inefficient nitrogen retention.

## Manipulating the Catabolic Sequence

### Protein

The diversity and variability of microbial species and their proteolytic enzymes, described above and elsewhere (Wallace *et al.*, 1997) suggests that no means of rational manipulation of the microbial population will be possible that will influence the rate of breakdown of dietary protein. Physical or chemical protection methods which affect the protein itself are required (Wallace, 1994). A possible benefit in grazing animals would be a grass with less proteolytic activity, as the proteinases of the plant may be significant in early proteolytic digestion of plant protein in the rumen (Zhu *et al.*, 1999). In contrast, the breakdown of bacterial protein, which leads to inefficient microbial protein yields in the mixed population, can be almost abolished if rumen ciliate protozoa are eliminated from the rumen. The benefit in terms of microbial protein flow from the rumen can be 20% or more (e.g. Hsu *et al.*, 1991). This manipulation, known as defaunation, therefore offers an extremely promising strategy for improving amino acid nutrition in ruminants. Many other

issues are involved, however – too numerous to describe here – and the reader is directed to the extensive literature surrounding the issue of defaunation (see Williams and Coleman, 1992; Ivan *et al.*, 2000).

### Peptides

There is the possibility of protecting peptides physically as there is for the protection of protein and amino acids (see below). Chemical protection, by N-terminal acylation, is also effective (Wallace, 1992b; Wallace *et al.*, 1998; Witt *et al.*, 1998) because peptides are broken down by rumen microbial aminopeptidases. In terms of enzyme inhibition, the two steps of peptide hydrolysis can be considered separately. The breakdown of oligopeptides, catalysed mainly by dipeptidyl peptidases of *Prevotella* spp. (Wallace and McKain, 1991; McKain *et al.*, 1992) can be inhibited by a variety of structural-analogue inhibitors, including benserazide, GlyPhe-diazomethylketone, Ala<sub>2</sub>-chloromethylketone and diproton A (H.R. Wang, N. McKain, N.D. Walker and R.J. Wallace, unpublished). Dipeptidase activity is strongly cation-dependent, and is sensitive to metal-ion chelators such as 1,10-phenanthroline (Wallace and McKain, 1996; Wallace *et al.*, 1996). Both of these groups of peptidase inhibitors inhibit the rate of ammonia production from peptides and protein in rumen fluid, but whether they would prove to be suitable feed additives remains to be established.

### Amino acids

Monensin, an ionophore which is widely used as a feed additive, manipulates carbohydrate fermentation by shifting the products of carbohydrate fermentation from acetate to propionate production. It has been also found to be effective in reducing ammonia concentrations (Yang and Russell, 1993; Cotta and Russell, 1997; Wallace *et al.*, 1997), partly by inhibiting the growth of HAP bacteria, as described above. Other feed additives, including an amino acid analogue LY29 (1-[(E)-2-(2-methyl-4-nitrophenyl)diaz-1-enyl]pyrrolidine-2-car-

boxylic acid; Floret *et al.*, 1999) and essential oils (McIntosh *et al.*, 2000) target HAP bacteria more specifically. Diphenyliodonium chloride (DIC) does not inhibit HAP species (Floret *et al.*, 1999), but is an effective deaminase inhibitor (Chalupa *et al.*, 1983).

### Transport of Peptides, Amino Acids and Ammonia by Rumen Microbes

Many rumen microorganisms are able to transport either peptides or amino acids, but the relative importance of peptide and amino acid transport *in vivo* is not clear (Russell *et al.*, 1991). It is speculated that the energy cost of peptide transport could be less than that of amino acids (Russell *et al.*, 1991). Pittman *et al.* (1967) studied the uptake of <sup>14</sup>C-labelled peptides by *P. ruminicola*, a Gram-negative ruminal bacterium, and suggested that peptides containing as many as 16 amino acids could be taken up. Larger peptides were preferred for growth in pure culture studies with *P. ruminicola* (Pittman and Bryant, 1964) and peptides up to a molecular weight of 2000 Da were taken up much more rapidly than free amino acids (Pittman *et al.*, 1967). Russell *et al.* (1991) later argued that peptide size might be a crucial factor in peptide transport by the ruminal bacteria. They suggested that the majority of ruminal bacteria are Gram-negative, and the outer membrane of these species is a selective barrier to many substrates. They pointed out the possibility that long peptides are broken down to shorter ones before their transport. Peptides containing more than five amino acids are likely to be excluded by the cell membrane structure and transport mechanisms in Gram-negative bacteria (Higgins and Gibson, 1986). Chen and Russell (1989b) found that *Peptostreptococcus anaerobius* took up Leu, Val and Ile by a common carrier which was dependent on Na<sup>+</sup>. Similarly, Chen and Russell (1990) reported that the amino acid-fermenting ruminal bacterium strain F, subsequently named *Clostridium aminophilum* (Paster *et al.*, 1993), had separate transport systems for glutamate, glutamine, histidine and serine which could be driven by a chemical gradient of Na<sup>+</sup> and was unable to grow or produce ammonia in the presence of monensin.

Reports on the preferential utilization of peptides and amino acids by the mixed microbial population in the rumen are quite variable. Studies by Prins *et al.* (1979) and Cooper and Ling (1985) indicated that peptides rather than free amino acids are preferentially incorporated by the mixed microbial population. In contrast, an amino acid preference over peptides was reported by Armstead and Ling (1993) in rumen fluid from some sheep much more than in others, and they suggested that it may be due to a dependence on the composition of the bacterial population. *Streptococcus bovis* was found to be more active in amino acid transport than peptide transport (Westlake and Mackie, 1990) and free amino acids were the preferred form of amino acids incorporated by *S. bovis*, *Selenomonas ruminantium*, *Fibrobacter succinogenes* and *Anaerovibrio lipolytica*, whereas peptides were preferred only by *Prevotella ruminicola* (Ling and Armstead, 1995; Atasoglu *et al.*, 1998). Ling and Armstead (1995) argued that conflicting reports on the preferential utilization of peptides or amino acids may be due to the proportions of the bacteria which have a preference for peptides or amino acids as the composition of the rumen microflora changes under different dietary conditions. *Prevotella* spp. as a group form one of the most numerous groups of ruminal bacteria and is found in the rumen of animals offered different diets (Stewart *et al.*, 1997). These species can comprise 60% of a ruminal flora in silage-fed cattle (Van Gylswyk, 1990) and utilize peptides more efficiently than amino acids (Wright, 1967; Cooper and Ling, 1985; Ling and Armstead, 1995; Atasoglu *et al.*, 1998). *Selenomonas ruminantium* is mainly found in high numbers in the rumen of the animals receiving cereal grains (Stewart *et al.*, 1997) and can account for up to 51% of a rumen flora (Caldwell and Bryant, 1966). This species has been reported to have a preference for amino acids (Ling and Armstead, 1995).

Little is known about the mechanisms of ammonia transport into rumen microbes. It is generally assumed that ammonia transport is rapid and occurs mostly by diffusion across cell membranes. However, Russell and Strobel (1987) calculated that intracellular accumulation may occur, indicating that more specific, carrier-mediated transport may occur.

## Microbial Protein Synthesis

### Ammonia assimilation

A large but variable proportion (60–90%) of dietary protein is fermented by the microorganisms to ammonia in the rumen (Russell *et al.*, 1992; Wallace *et al.*, 1997). This ammonia is then utilized through biosynthetic pathways to form amino acids.

More than 90% of the bacteria isolated from the rumen are able to utilize ammonia as the main source of N, whereas it is essential for the growth of 25% of the isolates tested (Bryant and Robinson, 1962, 1963). There are several different enzymatic mechanisms for ammonia uptake into amino acids, each having a different affinity for its substrate. The mechanisms vary as ruminal  $\text{NH}_3$  concentration changes. The highest-affinity enzyme system for ammonia assimilation is the glutamine synthetase–glutamate synthase (GS-GOGAT) couple when ammonia concentrations are limiting (Wallace, 1979). Ammonia is first incorporated into the amide group of Gln, using Glu as substrate, and ATP is hydrolysed. The amide- $\text{NH}_2$  is then transferred to  $\alpha$ -ketoglutarate to form two molecules of Glu (Wallace *et al.*, 1997). Salter *et al.* (1979), who infused [ $^{15}\text{N}$ ]urea into the rumen of steers receiving diets with the nitrogen supplied mainly as decorticated groundnut meal, urea or a mixture of equal amounts of decorticated groundnut meal and urea, found that the labelling of bacterial amide-N from  $^{15}\text{NH}_3$  was greater (by about 2–20 times) than that of bacterial non-amide-N, implying that ammonia-N is first incorporated into bacterial amide-N, which is used for subsequent amination of  $\alpha$ -ketoglutarate to form glutamate. Initial rates of  $^{15}\text{N}$  incorporation into glutamate, aspartate and alanine were similar to each other and faster than those into other non-amide-N components. Erfle *et al.* (1977) found GOGAT activity in ruminal microorganisms under ammonia-limited conditions, but it was not significant at higher ammonia concentrations (Wallace, 1979; Lenartova *et al.*, 1985). Under conventional feeding conditions, rumen ammonia concentration *in vivo* would be higher than 1 mM. As the high affinity of the GS-GOGAT couple mechanism is needed for

effective ammonia assimilation only at lower concentrations, it is usually induced only at those lower concentrations (Brown, 1980). Other enzyme systems, which do not utilize ATP, would be therefore expected to operate in ruminal microorganisms.

Lower-affinity systems present in rumen microorganisms include NADP-glutamate dehydrogenase (NADP-GDH), whose  $K_m$  for ammonia is 1.8–3.1 mM, and NAD-GDH (20–33 mM) and alanine dehydrogenase (AlaDH) (70 mM) (Wallace, 1979). Significant levels of both NADP- and NAD-linked GDH activities were demonstrated in studies using ruminal contents and *in vitro* mixed ruminal bacterial cultures (Chalupa *et al.*, 1970; Erfle *et al.*, 1977). In general, NADP-linked GDH is assumed to have a biosynthetic role and functions efficiently at high ammonia concentrations, whereas the NAD-linked GDH enzyme has a catabolic function when ammonia is limiting and Glu is used for ammonia generation (Brown, 1980).

### Influence of N source on ammonia assimilation enzymes

Estimates of the contribution of ammonia versus preformed amino acids to protein synthesis by the mixed ruminal population have been highly variable.  $^{15}\text{N}$  studies using  $^{15}\text{N}$ -ammonia or urea (which rapidly releases ammonia) infused into the rumen or added as a single dose indicated values of microbial N derived from ammonia that ranged from 18 to 100% (summarized by Salter *et al.*, 1979). Dietary factors responsible for these differences are the availability of readily fermentable energy source (Ben-Ghedalia *et al.*, 1978) and the presence of amino acids and peptides (Argyle and Baldwin, 1989). However, little progress has been made on understanding the biochemical basis of this variation in the proportion of microbial N derived from ammonia in the rumen.

The influence of nitrogen source on activities of ammonia assimilating enzyme systems has been studied in a number of ruminal bacteria. The activity of GS has been reported to depend on the N source and concentration in

the cells of *Prevotella bryantii* B<sub>14</sub> (Kirk *et al.*, 2000). It appeared that the bacteria became N-limited when N concentration in the growth medium was 0.5 mM for ammonia or peptides and 2.5 mM for casein. In the N-limited treatments, the highest GS activity was detected from the cells of the bacterium grown on pepticase, followed by ammonia and casein. No activity was detectable in the non-limited N treatments, however. The study also indicated that *P. bryantii* proteinase activity increased when N availability decreased in the medium, indicating that GS activity could be an indicator of N availability and thus could be involved in the regulation of protease activity in *P. bryantii*.

Wen and Morrison (1996) found that addition of trypticase (peptides) to the cultures of *P. bryantii*, *P. ruminicola* and *P. brevis* already growing on ammonia resulted in substantial reductions in NADP-linked GDH activity, although they differed in the time required for the decrease in the activity. However, the NAD-linked GDH specific activity in *P. ruminicola* and *P. brevis* appeared to increase after the peptides had been added to the growth medium. The authors later confirmed that *P. brevis* produces a second, NAD-linked GDH in response to growth on peptides (Wen and Morrison, 1997). Likewise, provision of peptides (15 g l<sup>-1</sup>) to *P. bryantii* decreased NADP-linked GDH activity by tenfold as compared to the cells grown in the presence of 1 mM ammonia (Wen and Morrison, 1996). Our studies with predominant species of non-cellulolytic ruminal bacteria have demonstrated that provision of peptides at differing concentrations decreased the activity of the NADP-linked GDH activity in *P. bryantii*, *Selenomonas ruminantium* and *Streptococcus bovis*, and NAD-linked GDH activity in *P. bryantii* in a concentration-dependent manner (Table 15.2). A similar pattern was found in <sup>15</sup>NH<sub>3</sub>-uptake experiments with the same species in that the proportion of bacterial cell-N and amino acid-N derived from ammonia fell as the concentration of peptides and amino acids increased in the growth medium (Atasoglu *et al.*, 1998). Thus, in view of the published reports and the results of our studies, it is certain that the form and concentration of N sources present

in the microbial environment are involved in the regulation of enzymes of ammonia assimilation in ruminal bacteria, thus are partly responsible for the variation in the utilization of ammonia for microbial protein synthesis.

### Amino acid biosynthesis

The rumen microbes depend to a large extent on *de novo* synthesis of amino acids from ammonia and carbon precursors derived from products of carbohydrate fermentation (Sauer *et al.*, 1975). Amino acid families are based on the source of carbon used for their synthesis (Wallace *et al.*, 1997): the glutamate family – glutamate, glutamine, proline, arginine; the serine family – serine, glycine, cysteine; the aspartate family – aspartate, lysine, methionine, threonine, isoleucine; the pyruvate family – alanine, isoleucine, leucine, valine; the aromatic family – phenylalanine, tyrosine, tryptophan and histidine. Although the pathways of amino acid synthesis in ruminal bacteria have not been studied to the same extent as in enteric bacteria, evidence is available for a number of these pathways and radioactive tracer studies on amino acid biosynthesis by mixed ruminal bacteria provided amino acids with labelling patterns consistent with the pathways described by Umbarger (1978) for the synthesis of amino acids by bacteria and fungi (Sauer *et al.*, 1975; Wallace *et al.*, 1997). As described above, glutamate plays a central role in the nitrogen metabolism of organisms, and thus the generation of  $\alpha$ -ketoglutarate is of great importance to nitrogen metabolism in ruminal bacteria (Wallace *et al.*, 1997). Since the rumen is an anaerobic environment, ruminal microbes contain an incomplete Krebs cycle, in which  $\alpha$ -ketoglutarate is not generated as an intermediate of energy metabolism as it is in aerobic organisms (Patterson, 1992). Milligan (1970) demonstrated the labelling of glutamate in the C-1, C-2 and C-5 positions when ruminal contents were incubated with NaH<sup>14</sup>CO<sub>3</sub>. This labelling pattern suggested that  $\alpha$ -ketoglutarate is formed by both reductive carboxylation of succinic acid for the reverse Krebs cycle and condensation of oxaloacetic acid and acetyl CoA to form

**Table 15.2.** Effect of peptide concentration on the GDH activity of *Prevotella bryantii*, *Selenomonas ruminantium* and *Streptococcus bovis*<sup>a</sup>. (Atasoglu and Wallace, unpublished data.)

Medium	GDH activity ( $\mu\text{mol min}^{-1} \text{mg}^{-1}$ ) <sup>b</sup>					
	<i>P. bryantii</i>		<i>S. ruminantium</i>		<i>S. bovis</i>	
	NADP	NAD	NADP	NAD	NADP	NAD
Basal	3.53 $\pm$ 0.42	0.11 $\pm$ 0.02	3.65 $\pm$ 0.91	ND <sup>c</sup>	3.16 $\pm$ 0.58	ND
Basal + 1 g l <sup>-1</sup> Try <sup>d</sup>	2.72 $\pm$ 0.39	0.10 $\pm$ 0.02	2.74 $\pm$ 0.68	ND	2.55 $\pm$ 0.19	ND
Basal + 5 g l <sup>-1</sup> Try	1.80 $\pm$ 0.37	0.06 $\pm$ 0.01	1.06 $\pm$ 0.06	ND	1.19 $\pm$ 0.10	ND
Basal + 10 g l <sup>-1</sup> Try	1.28 $\pm$ 0.03	0.04 $\pm$ 0.01	1.43 $\pm$ 0.07	ND	0.92 $\pm$ 0.18	ND
Basal + 30 g l <sup>-1</sup> Try	1.20 $\pm$ 0.33	0.03 $\pm$ 0.01	1.04 $\pm$ 0.21	ND	0.84 $\pm$ 0.20	ND
Basal + 10 g l <sup>-1</sup> Try <sup>e</sup>	0.87 $\pm$ 0.17	0.02 $\pm$ 0.01	1.09 $\pm$ 0.19	ND	0.94 $\pm$ 0.03	ND
Medium M2	1.20 $\pm$ 0.22	0.03 $\pm$ 0.00	2.41 $\pm$ 0.32	ND	0.36 $\pm$ 0.01	ND

<sup>a</sup>Results are the means of triplicate cultures.

<sup>b</sup>NADP and NAD-linked specific activity is defined as  $\mu\text{mol}$  of NAD(P)H oxidized  $\text{min}^{-1} \text{mg}^{-1}$  of protein.

<sup>c</sup>ND, not detectable.

<sup>d</sup>Try, trypticase.

<sup>e</sup>Basal medium contained 10 g l<sup>-1</sup> trypticase without added ammonia.



citrate and subsequent forward Krebs cycle activities. In addition, the continuous culture study with mixed ruminal microorganisms by Sauer *et al.* (1975) provided evidence for the synthesis of  $\alpha$ -ketoglutarate by forward and reverse Krebs cycle reactions. The presence of reductive carboxylation of succinate to form  $\alpha$ -ketoglutarate was demonstrated by Allison and Robinson (1970) in *P. ruminicola* as well as in *Veillonella*, *Selenomonas* and *Bacteroides* spp. (Allison *et al.*, 1979). Likewise, when cells of *F. succinogenes* were incubated with [1- $^{13}$ C]glucose,  $^{13}$ C-labelled Asp, Glu, Ala and Val were detected by Matheron *et al.* (1999), who concluded that the labelling of amino acids was consistent with the proposed amino acid synthesis pathway and with the reversal of the succinate synthesis pathway.

Biosynthesis of alanine results from the amination of pyruvate and can be catalysed by alanine dehydrogenase and glutamate-pyruvate transaminase using glutamate as the nitrogen donor. Pyruvate is generated in the energy metabolism of the majority of ruminal bacteria and can be produced by the reductive carboxylation of acetate (Allison, 1969). Serine is produced from phosphoglyceric acid, which is a glycolytic intermediate, by conversion of this compound into phosphohydroxypyruvate and then phosphoserine and serine (Sauer *et al.*, 1975). Aspartate is formed from oxaloacetate and ammonia by aspartate dehydrogenase or by the glutamate-oxaloacetate transaminase reaction using glutamate as the nitrogen donor (Wallace *et al.*, 1997; Morrison and Mackie, 1997).

Experiments in which bacterial amino acids were labelled with  $^{15}$ N revealed that glutamate and alanine, together in most experiments with aspartate, were the most rapidly labelled amino acids with  $^{15}$ N, confirming the importance of these amino acids as the initial recipients of amino groups for subsequent transfer to other amino acids in the ruminal microorganisms (Salter *et al.*, 1979; Atasoglu *et al.*, 1999). Glutamate was found to be the most abundant amino acid in the free amino acid pool into which ammonia would be assimilated (Wallace, 1979; Blake *et al.*, 1983). High enrichment of glutamate with  $^{15}$ N was also observed in ruminal microorganisms,

which is consistent with glutamate dehydrogenase being the main ammonia-assimilating enzyme in ruminal bacteria, as described above. However, despite the low activity of alanine dehydrogenase and glutamate-pyruvate aminotransferase (Wallace, 1979), alanine was surprisingly observed to be prominent in these pools and often exceeded glutamate, particularly when ammonia concentrations were high. [ $^{15}$ N]Ammonium chloride enriched alanine more than glutamate or other amino acids in the microbial pool after only 2 min (Blake *et al.*, 1983), implying that alanine dehydrogenase is extremely active under the conditions of high ammonia concentrations, consistent with the findings of Wallace (1979). Other investigators, using  $^{15}$ N-labelled urea or ammonium chloride also found alanine to be one of the most labelled amino acids (Shimbayashi *et al.*, 1975; Blake *et al.*, 1983; Atasoglu *et al.*, 1999). Blake *et al.* (1983) postulated that alanine may be the primary product and high concentration of alanine may be important to the ruminal bacteria as a short term storage mechanism for ammonia, as a control mechanism within the bacterium to prevent excess levels of ammonia accumulation, and a route of removing excess pyruvate from the bacterium when available energy is in excess and bacterial metabolism is rapid.

Phenylacetate, hydroxyphenylacetate, and indoleacetate are substrates for reductive carboxylation and can be used for the biosynthesis of phenylalanine, tyrosine and tryptophan, respectively (Allison, 1969). The reductive carboxylation pathways present in some ruminal bacteria appear to be in addition to the biosynthesis of these aromatic amino acids from a common precursor, chorismate (Morrison and Mackie, 1997). The biosynthesis of chorismate requires phosphoenolpyruvate and erythrose-4-phosphate as substrates and proceeds via the shikimate pathway. The presence of both pathways for the biosynthesis of aromatic amino acids was also demonstrated by Sauer *et al.* (1975). Interconversion of aromatic amino acids also occurs in the rumen, tyrosine being formed from phenylalanine (Khan *et al.*, 1999).

Ruminal bacteria are known to synthesize branched-chain amino acids from branched-chain fatty acids (Allison, 1969). Isovalerate, 2-

methylbutyrate and isobutyrate are reductively carboxylated, then aminated to produce leucine, isoleucine and valine, respectively. One or more of these branched-chain fatty acids is required for the synthesis of branched-chain amino acids by the predominant cellulolytic ruminal bacteria, *Fibrobacter succinogenes*, *Ruminococcus albus* and *R. flavefaciens* (Bryant and Robinson, 1962; Allison *et al.*, 1962). *Prevotella ruminicola* and *Megasphaera elsdenii*, which produce branched-chain fatty acids, can also utilize these for the synthesis of amino acids (Allison, 1969). In rumen bacteria, the availability of branched-chain fatty acids has also been demonstrated to modulate the flux of glucose carbon into amino acids. Allison *et al.* (1984) found that growing cultures of *P. ruminicola* utilized carbon from [<sup>14</sup>C]glucose for the synthesis of leucine and other cellular amino acids when the growth medium was not supplied with isovalerate. When unlabelled isovalerate was available, however, utilization of [<sup>14</sup>C]glucose for leucine synthesis was markedly reduced. Similarly, provision of phenylacetate and 2-methylbutyrate reduced the utilization of glucose carbon for phenylalanine and isoleucine synthesis, respectively (Allison *et al.*, 1984). The authors concluded that this organism has the ability to regulate alternative pathways for the synthesis of certain amino acids, and will utilize preformed intermediates of these amino acids in preference to *de novo* synthesis. Furthermore, because these intermediates are often present in the rumen fluid, pathways that involve reductive carboxylations are likely to be predominant for the synthesis of these amino acids in the rumen (Allison *et al.*, 1984; Wallace *et al.*, 1997). <sup>15</sup>N enrichment in valine, leucine and isoleucine was lower than that of most of the other amino acids in mixed ruminal microorganisms, when peptides or amino acids were present in the growth medium (Atasoglu *et al.*, 1999), a finding consistent with the conclusion of Allison *et al.* (1984) for *P. ruminicola*.

The glutamate family of amino acids includes proline and arginine. The biosynthesis of these amino acids is likely to be similar to the pathways described for the enteric bacteria (Morrison and Mackie, 1997). The biosynthesis of proline and arginine requires that the  $\gamma$ -carboxyl group of glutamate be acti-

vated, then reduced, to yield glutamic- $\gamma$ -semialdehyde (Morrison and Mackie, 1997). Glutamic- $\gamma$ -semialdehyde gives rise to pyrroline-5-carboxylate, which is reduced to proline. The semialdehyde also gives rise to ornithine, which is converted into arginine.

Other examples of amino acids being formed from C-skeleton precursors in the rumen include histidine from imidazole compounds (Wadud *et al.*, 2001), threonine from homoserine (Or-Rashid *et al.*, 2001), lysine from diaminopimelic acid by protozoa (Onodera and Kandatsu, 1973; Onodera 1986), and tryptophan from indolepyruvic acid (Okuuchi *et al.*, 1993).

### Amino Acid Composition of Microbial Protein

Formulation of non-ruminant diets for amino acid requirements is easier than that of ruminant diets since amino acid requirements of non-ruminant animals are provided only by dietary protein. In contrast, amino acid requirements of ruminants are met by a mixture of dietary protein and microbial protein. Briefly, the challenge is to predict: (i) what the requirements of the animal are, and (ii) the amino acids available for absorption in the small intestine. Therefore, the amino acid composition of rumen microbes is a crucial element of ruminant protein nutrition, as is the digestibility of microbial protein. A recent review (Hvelplund *et al.*, 2001) describes these issues in detail.

The calculations of the nutritive value of the amino acids in point (ii) focus mainly on the essential amino acids, principally lysine, methionine and histidine, which are first-limiting (Lobley, 1994). Microbial protein has a higher content of lysine and methionine than plant protein sources (Wallace, 1994), hence knowing its composition is vital. The general view for some time has been that rumen microbial protein has a fairly constant amino acid composition (Purser and Buechler, 1966; Bergen *et al.*, 1967). However, Hvelplund *et al.* (2001) provided new data based on 70 estimations (Table 15.3) suggesting that there is a genuine variation in amino acid composition of microbial protein. Unfortunately, the variation was particularly acute for lysine, for

**Table 15.3.** Dependence on energy substrate of the response in microbial protein yield (g) to amino acids in sheep. (From Chikunya *et al.*, 1996.)

Energy substrate	Nitrogen source	
	Urea	Casein
Grass hay	5.88	6.51
Sugarbeet pulp	7.41	13.46

which the highest measured concentration was almost twice the lowest concentration. Significant variation occurred also in methionine composition, exacerbating problems in diet formulation. Clearly an important research priority must be to explain, and then to predict, the reasons for this variation.

Ciliate protozoa have a greater content of lysine and methionine than bacteria (Czerkawski, 1976). However, protozoa are selectively retained in the rumen (Veira, 1986), which may explain why defaunation has been reported to have a minor effect on the composition of amino acids flowing to the small intestine (Merchen and Titgemeyer, 1992).

### Protected Amino Acids

Ruminally protected amino acids (RPAA), mainly methionine and lysine, are potentially highly important in improving animal performance, because, unlike in non-ruminants, it is not possible to correct imbalances in absorbed amino acids composition by adding free amino acids to the diet – they are metabolized in the rumen. Reports on the effects of RPAA in ruminant diets are inconsistent in the literature (Merchen and Titgemeyer, 1992). In contrast, dry-matter intake, yields of milk, milk fat, fat-corrected milk and energy-corrected milk of Jersey cows given cottonseed were not significantly different from those of the animals receiving RPAA in addition to cottonseed in their diet (Bertrand *et al.*, 1998). Many other examples exist. In some cases, the protection may have been ineffective (Chalupa, 1975); in others, the animals may not have been in a metabolic condition to respond.

Protection of amino acids can be afforded either by physical encapsulation, or by chemical modification. The methods and effectiveness have been reviewed elsewhere (Wallace, 1994).

### Toxicity from Amino Acid Metabolism in the Rumen

The metabolism of certain amino acids is known, or has the possibility, to release amino acid derivatives that are toxic to the host animal. The formation of 3-hydroxy-4(1H)-pyridone (DHP) from mimosine and of 3-methylindole from tryptophan are the principal reactions that are known to exist and potentially be hazardous.

The mimosine story is one of the most celebrated in rumen microbiology (see Chapters 4 and 7). Mimosine is an amino acid not found in protein but present in some plant materials, notably *Leucaena leucocephala*, a tropical leguminous shrub. It is hydrolysed in the rumen to form DHP, which is a potent goitrogen (Hegarty *et al.*, 1976). If bacteria which degrade DHP further are not present in the rumen, as was the case in Australia (Jones and Megarthy, 1986), toxicity resulting from the consumption of *Leucaena* is severe. The success for microbiology was to inoculate animals with a flora containing the organisms able to metabolize DHP; toxicity was avoided in inoculated animals (Allison *et al.*, 1990; Hammond, 1995). The bacterium responsible was named *Synergistes jonesii* (Allison *et al.*, 1992).

3-Methylindole formation from tryptophan is also the consequence of the action of a single organism, in this case a *Lactobacillus* sp. (Yokoyama *et al.*, 1977). A high tryptophan intake can lead to the accumulation of 3-methylindole (skatole) in the rumen, which causes 'fog fever', pulmonary emphysema and oedema (Hammond *et al.*, 1978). The ionophore, monensin, kills the *Lactobacillus* and thereby decreases the incidence of the disease (Hammond *et al.*, 1978).

Another possible effect on the host animal, not yet confirmed, may arise from the breakdown of lysine by rumen protozoa, to form pipercolic acid (Onodera and Kandatsu, 1974). Pipercolic acid has effects on animal behaviour via its action in the brain (Takagi *et al.*, 2001).

## Amino Acid Requirements of Ruminant Microorganisms

### The mixed population

Rumen microorganisms, as a population, have no absolute requirement for amino acids (Virtanen, 1966; Salter *et al.*, 1979). Individual species within the population do have amino acid requirements, however, which can be met by the breakdown of bacterial protein in the rumen, and by synthesis from a number of C-skeletons as described above. There is, however, plentiful evidence that providing amino acids, peptides or protein stimulates growth rate and yield of both the mixed population and individual species. Whether the influence on growth rate results from relieving an absolute amino acid requirement in a small number of individual species in the population, or whether it reflects a rate-limiting biosynthetic step in general, is not clear.

Many studies have demonstrated the benefits of supplying preformed amino acids to ruminal microbes (reviewed in Chikunya *et al.*, 1996). Stimulation did not occur, however, when the energy substrate was high in plant fibre (Cruz Soto *et al.*, 1994; Chikunya *et al.*, 1996), suggesting that the response to amino acids depends on the rate of degradation of the energy source. Such a difference is part of the Cornell model (Russell *et al.*, 1992), which divides the bacterial population into two populations, one which is fibrolytic and does not respond to amino acids, the other which is sugar- and starch-fermenting and does respond to amino acids (see below).

The effect on growth yield is one that might be expected from bioenergetic considerations of the energy requirements of amino acid synthesis under anaerobic conditions (Barker, 1981). An increased yield approaching 20% was observed by Russell and Sniffen (1984), who used glucose as the energy source. Maeng *et al.* (1976) observed an 18% increase in growth yield on glucose when casein was added, compared to a 53% increase when cellobiose was the energy source. The Cornell model (Russell *et al.*, 1992) assumes a variable increase in yield, depending on the ratio of amino acids to total organic matter, up to 18%.

Three main approaches have been taken so far in attempts to identify the key amino acids which limit rumen fermentation. One involves adding amino acids to a fermentation mixture in which ammonia is the only other source of N. Maeng *et al.* (1976) and Argyle and Baldwin (1989) added single or groups of amino acids to ruminal fermentations *in vitro*. They found that only complete mixtures of amino acids gave maximum responses. Groups of amino acids, such as aromatic amino acids, gave intermediate responses. Another approach has involved attempting to find, by isotopic labelling methods, which amino acid biosynthesis limits growth. Salter *et al.* (1979) found that different amino acids are formed *de novo* to differing extents when protein is available. Proline biosynthesis was affected particularly strongly when preformed proline was present. Similar *in vitro* experiments by Atasoglu *et al.* (1999) using  $^{15}\text{NH}_3$  confirmed the unusual sensitivity of proline biosynthesis to the provision of preformed amino acids, and identified glycine, valine and threonine as other amino acids whose biosynthesis was most sensitive to repression by added amino acids. Supplementation with these amino acids failed to replicate the stimulatory effects of a complete mixture of amino acids, however, indicating that the true nature of the amino acid limitation had not been identified. The third method involves a deletion approach, which has proved to be useful both in identifying and quantifying amino acid requirements in animals. In theory, deletion of only the first-limiting amino acid from a complete mixture should cause a decline in N retention, until the limitation imposed by the second-limiting amino acid is reached, and so on. The deletion approach applied to rumen fermentation (Atasoglu *et al.*, 2002) confirmed that no single amino acid limits ruminal fermentation, and identified phenylalanine, leucine and serine as key amino acids whose synthesis may be rate-limiting.

### Rumen bacteria

Early cultural studies by Bryant and Robinson (1962) established that most of the species of rumen bacteria they tested

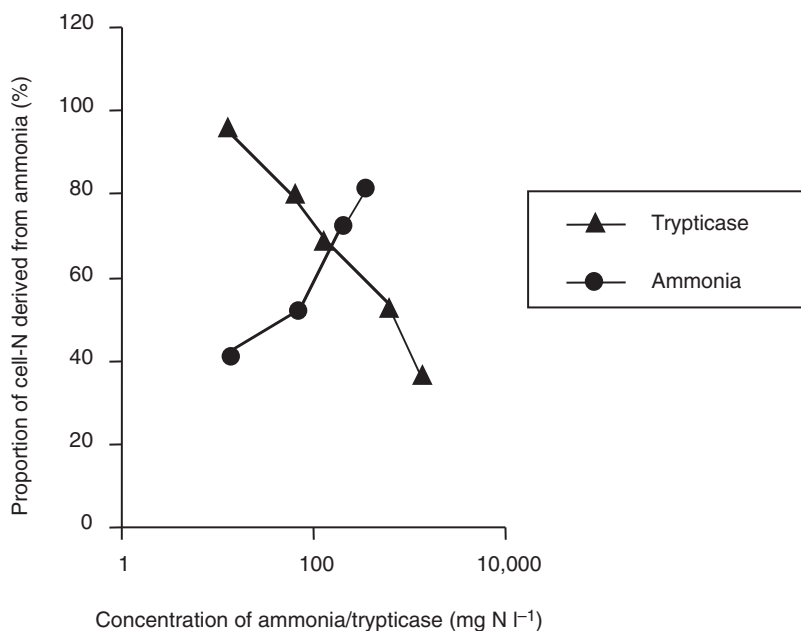
required amino acids for growth. Exactly which amino acid(s) are required has not received systematic analysis. Some rumen *Prevotella* spp. require methionine (Pittman and Bryant, 1964), whereas *Fibrobacter succinogenes* requires phenylalanine (Bryant *et al.*, 1959; Atasoglu *et al.*, 2001), which can be supplied in the form of phenylacetic acid (Allison, 1965). Stimulation of growth of *Ruminococcus* spp. by phenylalanine or its precursors, phenylacetic acid and phenylpropionic acid, is also well established (Allison, 1965; Morrison *et al.*, 1990; Stack *et al.*, 1983). The cellulolytic species are stimulated by short-chain fatty acid precursors of aliphatic amino acids (Allison *et al.*, 1958). Otherwise, absolute auxotrophic amino acid requirements are not known, to our knowledge. The question then moves on to which amino acids stimulate growth rate/yield, similar to the mixed population above.

Bacteria appear to fall into two categories with respect to their amino acid requirements for optimum growth, namely cellulolytic bacteria and non-structural carbohydrate (NSC) fermenters (Russell *et al.*, 1992). Generally speaking, the cellulolytic bacteria use ammonia for growth, whereas NSC fermenters use many more amino acids when they are available. Why amino acid requirements should be linked to cellulolytic activity has never been explained. Perhaps the slow growth that is inevitable on cellulose because of its resistant structure has meant, as the cellulolytic bacteria evolved, that the use of amino acids did not provide a selective advantage over ammonia use. The short-chain fatty acid precursors of various amino acids which stimulate cellulolytic species occur in rumen fluid as a result of amino acid catabolism by other species, so the energetic advantage of preformed C skeletons is not necessarily lost by not taking up the intact amino acid.

It is sometimes assumed that rumen cellulolytic bacteria, because they do not require amino acids, do not benefit from or incorporate amino acids. Early studies by Bryant and Robinson (1961, 1962, 1963) with pure cultures of cellulolytic bacteria indicated that *Ruminococcus albus* and *R. flavefaciens* incorporated large amounts of ammonia and

very small amounts of amino acids into cell N. Several recently published results are not consistent with the conclusion that cellulolytic bacteria do not use amino acids, however. The amino acid transport experiments of Ling and Armstead (1995) indicated that *F. succinogenes* accumulated radioactivity from  $^{14}\text{C}$ -labelled peptides and amino acids. Furthermore, there is experimental evidence that preformed amino acids stimulate fibre digestion in the mixed population *in vivo* and *in vitro* (Merry *et al.*, 1990; Chikunya *et al.*, 1996; Griswold *et al.*, 1996; Carro and Miller, 1999), and pure cellulolytic species grow faster on cellobiose when peptides are added to the medium (Cruz Soto *et al.*, 1994). In addition, bacteria most closely associated with solids derived a substantial proportion of their cell N from sources other than ammonia (Komisarczuk *et al.*, 1987; Carro and Miller, 1999; Dixon and Chanchai, 2001). The explanation may lie in the concentration of amino acids available to the bacteria under different conditions. The proportion of cell N formed from amino acids and ammonia has been shown to vary according to the concentrations of both. In the mixed population, increasing the concentration of ammonia increased the proportion of microbial protein derived from ammonia; conversely, as the peptide concentration increased, the proportion of cell-N derived from ammonia declined (Fig. 15.3; Atasoglu *et al.*, 1999). At amino acid concentrations typical of the liquid phase of rumen fluid, ammonia would account for 80% or more of amino acid-N in the cellulolytic bacteria (Atasoglu *et al.*, 2001). If the concentration in a microenvironment increased tenfold above the liquid phase, less than half the amino acid-N would be derived from ammonia (Atasoglu *et al.*, 2001). The high peptide concentration in bacterial culture media may therefore provide misleading information about N metabolism of rumen microbes *in vivo*.

The influence of growth conditions on *de novo* amino acid synthesis was determined in pure cultures of cellulolytic (Atasoglu *et al.*, 2001) and non-cellulolytic bacteria (Atasoglu *et al.*, 1998) by following the incorporation of  $^{15}\text{N}$  from  $^{15}\text{NH}_3$  into individual amino acids. Different patterns emerged with the two



**Fig. 15. 3.** Influence of peptide concentration on ammonia uptake by mixed rumen microbes. Based on the data of Atasoglu *et al.* (1999).

categories of bacteria. Phenylalanine synthesis was insignificant in *F. succinogenes*, and was generally lower than that of the other amino acids in the ruminococci. In contrast, proline synthesis was most responsive to preformed amino acids in non-cellulolytic bacteria. The most enriched amino acids in both types of bacteria were glutamate, aspartate and alanine, reflecting the predominant mechanisms of ammonia assimilation and transamination in these bacteria.

The Cornell model (Russell *et al.*, 1992) assumes that bacteria which ferment NSC derive 66% of their N from preformed amino acids and the remaining 34% from ammonia when both are available. The situation may be more variable because of the recently discovered concentration-dependence, described above. The results of other studies (Hristov and Broderick, 1994; Atasoglu *et al.* 1999) demonstrate the dependence of bacterial N assimilation on the type of protein and concentration of amino acids present, also as described above, which in turn may be a concentration-dependence effect.

### Rumen protozoa

Ciliate protozoa are important inhabitants of the microbial ecosystem in the rumen. Despite the common idea that protozoa rely on bacteria for their amino acid requirements and do not use ammonia as a nitrogen source for protein synthesis (Nolan, 1993), there is some evidence for *de novo* synthesis of amino acids in protozoa (Williams and Coleman, 1992). <sup>14</sup>C-labelled monosaccharides were incorporated into the protein of holotrichs (Williams and Harfoot, 1976; Williams, 1979), as was <sup>14</sup>C-labelled sodium carbonate, which was incorporated into alanine, histidine, threonine, glutamate and aspartate (Harmeyer, 1965). Ciliates form lysine from diaminopimelic acid which is present in the cell wall peptidoglycan of the bacteria which they ingest (Onodera and Kandatsu, 1974; Onodera *et al.*, 1974; Masson and Ling, 1986), and presumably many of the other amino acids are incorporated direct, after the digestion of bacteria, or are formed from pre-existing carbon skeletons derived from the bacteria.

Because the ciliate protozoa harbour bacteria in their cytoplasm, which are impossible to remove completely, it is difficult to distinguish genuine *do novo* amino acid biosynthesis from a secondary uptake via the biosynthetic activity of the cytoplasmic bacteria and the subsequent digestion of the bacteria by protozoal enzymes. Recently, however, a biosynthetic NAD-linked GDH was cloned from *Entodinium caudatum*, sequenced and the kinetic properties of its gene product measured (Eschenlauer *et al.*, 1999). The cloned gene appeared to be biosynthetic because it had a low affinity for glutamate and a high affinity for ammonia, indicating that ciliate protozoa have the capability for ammonia assimilation. The quantitative significance of ammonia uptake by ciliate protozoa remains to be determined.

### Rumen fungi

The anaerobic fungi are an important component of the cellulolytic flora of the rumen (Orpin and Joblin, 1997). Ruminal fungi, unlike ruminal cellulolytic bacteria, are known to be proteolytic (Wallace and Joblin, 1985), which probably favours the disruption of the proteinaceous layer that prevents cellulolytic bacteria from gaining access to the secondary cell wall (Engles and Brice, 1985).

Rumen fungi are able to grow in media lacking preformed amino acids and therefore must be able to form the needed amino acids, but information on amino acid biosynthesis is lacking (Lowe *et al.*, 1985). Amino acids, particularly aromatic amino acids, were stimulatory to growth (Orpin and Greenwood, 1986), however little published information is available concerning the amino acid metabolism of rumen fungi (Wallace *et al.*, 1997).

Recently, a nutritional study using  $^{15}\text{N-NH}_3$  was undertaken with two predominant species of rumen fungi, *Piromyces communis* and *Neocallimastix frontalis*, to determine the influence of nitrogen source and concentration on *de novo* synthesis of amino acids (C. Atasoglu and R.J. Wallace, unpublished data). The proportions of cell-N and amino acids formed *de novo* from ammonia decreased as the concentration of peptides

and amino acids increased, in a manner not dissimilar to the non-cellulolytic bacteria. Glutamate was the most highly enriched amino acid, implying that as in rumen bacteria glutamate dehydrogenase is the main pathway for ammonia uptake. *De novo* synthesis of lysine was much less than that of the other amino acids in both species, indicating preferential utilization of this amino acid. Phenylalanine was the second amino acid whose synthesis was affected most by the presence of peptides.

### Conclusions and Prospects

The catabolic sequence from protein to amino acids, and then the breakdown of amino acids to ammonia, has now been characterized fairly well in terms of reactions and microbes. To date, however, relatively few studies have probed the reactions at the molecular/regulatory level, certainly in comparison with the flood of molecular studies on fibrolytic digestion. Given the significance of *Prevotella* spp. in rumen N metabolism, sequencing a *Prevotella* genome now seems overdue. Analysis of how the genetic information for catabolic N metabolism is organized at the chromosomal level may lead to new ideas about slowing the catabolic flux. 'Natural' means, new plants or plant extracts for example, of regulating the catabolic flux also require more attention.

The issue of selective supplementation of ruminant diets with the amino acids that limit microbial growth and ruminal fermentation remains to be resolved, if indeed a solution is possible. That there is no single amino acid which limits rumen fermentation is now very clear. This review has summarized the results of different studies which looked into the biosynthesis of individual amino acids in ruminal microorganisms. Whether a subset of amino acids will be found that can achieve the stimulatory capability of the complete mixture seems improbable. The implications of the information that *de novo* amino acid synthesis has different regulatory characteristics in microbes with different functions – the *de novo* syntheses most sensitive to the presence of preformed amino acids were phenylalanine for

cellulolytic bacteria, proline for non-cellulolytic bacteria, and lysine for the fungi – are not yet clear and should be investigated further.

Recent mechanistic models have taken many factors regarding the quantitative aspects of ruminal fermentation into account, but they have not matched with the productivity of ruminants (Sauvant, 1997). One of the problems is that different species respond differently to various N sources, reflecting the diversity of the microbial ecosystem in the metabolism of amino acids. This factor alone could affect the efficiency of ruminal fermenta-

tion and the outcome of the models. Molecular techniques based on 16S rDNA analysis of microbial ecosystems offer a unique opportunity to provide population analysis of the microbial ecosystem under dietary conditions (Teather *et al.*, 1997). The new information about the concentration-dependence of amino acid and ammonia assimilation also further complicates nutritional models. Whether mechanistic nutritional models need to embrace such detail is not a judgement the present authors feel qualified to make. The challenge will be enormous.

## References

- Allison, M.J. (1965) Phenylalanine biosynthesis from phenylacetic acid by anaerobic bacteria from the rumen. *Biochemical and Biophysical Research Communications* 18, 30–35.
- Allison, M.J. (1969) Biosynthesis of amino acids by ruminal microorganisms. *Journal of Animal Science* 29, 797–807.
- Allison, M.J. and Robinson, I.M. (1970) Biosynthesis of  $\alpha$ -ketoglutarate by the reductive carboxylation of succinate in *Bacteroides ruminicola*. *Journal of Bacteriology* 104, 50–56.
- Allison, M.J., Bryant, M.P. and Doetsch, R.N. (1958) Volatile fatty acid growth factor for cellulolytic cocci of bovine rumen. *Science* 128, 474–475.
- Allison, M.J., Bryant, M.P. and Doetsch, R.N. (1962) Studies on the metabolic function of branched-chain volatile fatty acids, growth factors for *Ruminococci*. Incorporation of isovalerate into leucine. *Journal of Bacteriology* 83, 523–532.
- Allison, M.J., Robinson, I.M. and Baetz, A.L. (1979) Synthesis of  $\alpha$ -ketoglutarate by reductive carboxylation of succinate in *Veillonella*, *Selenomonas* and *Bacteroides*. *Journal of Bacteriology* 140, 980–986.
- Allison, M.J., Baetz, A.L. and Wiegel, J. (1984) Alternative pathways for biosynthesis of leucine and other amino acids in *Bacteroides ruminicola* and *Bacteroides fragilis*. *Applied and Environmental Microbiology* 48, 1111–1117.
- Allison, M.J., Hammond, A.C. and Jones, R.J. (1990) Detection of ruminal bacteria that degrade toxic dihydroxypridine compounds produced from mimosine. *Applied and Environmental Microbiology* 56, 590–594.
- Allison, M.J., Mayberry, W.R., McSweeney, C.S. and Stahl, D.A. (1992) *Synergistes jonesii*, gen. nov., sp. nov.: a rumen bacterium that degrades toxic pyridinediols. *Systematic and Applied Microbiology* 15, 522–529.
- Al-Rabbat, M.F., Baldwin, R.L. and Weir, W.C. (1971) *In vitro* nitrogen tracer technique for some kinetic measurements of ruminal ammonia. *Journal of Dairy Science* 54, 1150–1161.
- Argyle, J.L. and Baldwin, R.L. (1989) Effect of amino acids and peptides on rumen microbial growth yields. *Journal of Dairy Science* 72, 2017–2027.
- Armstead, I.P. and Ling, J.R. (1993) Variations in the uptake and metabolism of peptides and amino acids by mixed ruminal bacteria *in vitro*. *Applied and Environmental Microbiology* 59, 3360–3366.
- Atasoglu, C., Valdés, C., Walker, N.D., Newbold, C.J. and Wallace, R.J. (1998) *De novo* synthesis of amino acids by the ruminal bacteria *Prevotella bryantii* B<sub>14</sub>, *Selenomonas ruminantium* HD4 and *Streptococcus bovis* ES1. *Applied and Environmental Microbiology* 64, 2836–2843.
- Atasoglu, C., Valdés, C., Newbold, C.J. and Wallace, R.J. (1999) Influence of peptides and amino acids on fermentation rate and *de novo* synthesis of amino acids by mixed rumen micro-organisms from the sheep rumen. *British Journal of Nutrition* 81, 307–314.
- Atasoglu, C., Newbold, C.J. and Wallace, R.J. (2001) Incorporation of [<sup>15</sup>N]ammonia by the cellulolytic ruminal bacteria *Fibrobacter succinogenes* BL2, *Ruminococcus albus* SY3 and *Ruminococcus flavefaciens* 17. *Applied and Environmental Microbiology* 67, 2819–2822.



- Atasoglu, C., Guliye, A.Y. and Wallace, R.J. (2002) Use of a deletion approach to assess the amino acid requirements for optimum fermentation by mixed microorganisms from the sheep rumen. *Animal Science*, in press.
- Attwood, G.T., Klieve, A.V., Ouwkerk, D. and Patel, B.K.C. (1998) Ammonia-hyperproducing bacteria from New Zealand ruminants. *Applied Environmental Microbiology* 64, 1796–1804.
- Barcroft, J., McAnally, R.A. and Phillipson, A.T. (1944) Absorption of volatile fatty acids from the alimentary tract of the sheep and other animals. *Journal of Experimental Biology* 20, 120–129.
- Barker, H.A. (1981) Amino acid degradation by anaerobic bacteria. *Annual Review of Biochemistry* 50, 23–40.
- Ben-Ghedalia, D., McMeniman, N.P. and Armstrong, D.G. (1978) The effect of partially replacing urea nitrogen with protein-N on N capture in the rumen of sheep fed a purified diet. *British Journal of Nutrition* 39, 37–44.
- Bergen, W.G., Purser, D.B. and Cline, J.H. (1967) Enzymatic determination of the protein quality of individual rumen bacteria. *Journal of Nutrition* 92, 357–364.
- Bertrand, J.A., Pardue, F.E. and Jenkins, T.C. (1998) Effect of ruminally protected amino acids on milk yield and composition of Jersey cows fed whole cottonseed. *Journal of Dairy Science* 81, 2215–2220.
- Bladen, H.A., Bryant, M.D. and Doetsch, R.N. (1961) A study of bacterial species from the rumen which produce ammonia from protein hydrolyzate. *Applied Microbiology* 9, 175–180.
- Blake, J.S., Salter, D.N. and Smith, R.H. (1983) Incorporation of nitrogen into rumen bacterial fractions of steers given protein- and urea-containing diets. Ammonia assimilation into intracellular bacterial amino acids. *British Journal of Nutrition* 50, 769–782.
- Broderick, G.A. and Balthrop, J.E. (1979) Chemical inhibition of amino acid deamination by ruminal microbes *in vitro*. *Journal of Animal Science* 49, 1101–1111.
- Broderick, G.A. and Wallace, R.J. (1988) Effects of dietary nitrogen source on concentrations of ammonia, free amino acids and fluoreamine-reactive peptides in the sheep rumen. *Journal of Animal Science* 66, 2233–2238.
- Broderick, G.A., Wallace, R.J. and McKain, N. (1988) Uptake of small neutral peptides by mixed rumen microorganisms *in vitro*. *Journal of the Science of Food and Agriculture* 42, 109–118.
- Brown, C.M. (1980) Ammonia assimilation and utilization in bacteria and fungi. In: Payne, J.W. (ed.) *Microorganisms and Nitrogen Sources*. John Wiley & Sons, Chichester, UK, pp. 511–535.
- Bryant, M.P. (1973) Nutritional requirements of the predominant rumen cellulolytic bacteria. *Federation Proceedings* 32, 1809–1813.
- Bryant, M.P. and Robinson, I.M. (1961) Studies of the nitrogen requirements of some ruminal cellulolytic bacteria. *Applied Microbiology* 9, 96–103.
- Bryant, M.P. and Robinson, I.M. (1962) Some nutritional characteristics of predominant culturable ruminal bacteria. *Journal of Bacteriology* 84, 605–614.
- Bryant, M.P. and Robinson, I.M. (1963) Apparent incorporation of ammonia and amino acid carbon during growth of selected species of ruminal bacteria. *Journal of Dairy Science* 46, 150–154.
- Bryant, P.M., Robinson, I.M. and Chu, H. (1959) Observations on the nutrition of *Bacteroides succinogenes* – a ruminal cellulolytic bacterium. *Journal of Dairy Science* 42, 1831–1847.
- Caldwell, D.R. and Bryant, M.P. (1966) Medium without rumen fluid for non-selective enumeration and isolation of rumen bacteria. *Applied Microbiology* 14, 794–801.
- Carro, M.D. and Miller, E.L. (1999) Effect of supplementing a fibre basal diet with different nitrogen forms on ruminal fermentation and microbial growth in an *in vitro* semi-continuous culture system (RUSITEC). *British Journal of Nutrition* 82, 149–157.
- Chalmers, M.I. and Syngé, R.L.M. (1954) The digestion of nitrogenous compounds in ruminants. *Advances in Protein Chemistry* 9, 93–120.
- Chalupa, W. (1975) Rumen bypass and protection of proteins and amino acids. *Journal of Dairy Science* 58, 1198–1218.
- Chalupa, W. (1976) Degradation of amino acids by the mixed rumen microbial population. *Journal of Animal Science* 43, 828–834.
- Chalupa, W., Clark, J., Opliger, P. and Lavker, R. (1970) Ammonia metabolism in rumen bacteria and mucosa from sheep fed soya protein or urea. *Journal of Nutrition* 100, 161–169.
- Chalupa, W., Patterson, J.A., Parish, R.C. and Chow, A.W. (1983) Effects of diaryliodonium compounds on nitrogen metabolism in growing steers. *Journal of Animal Science* 57, 195–200.
- Chen, G. and Russell, J.B. (1988) Fermentation of peptides and amino acids by a monensin-sensitive ruminal *Peptostreptococcus*. *Applied and Environmental Microbiology* 54, 2742–2749.

- Chen, G. and Russell, J.B. (1989a) Sodium-dependent transport of branched chain amino acids by a monensin-sensitive ruminal *Peptostreptococcus*. *Applied and Environmental Microbiology* 55, 2658–2663.
- Chen, G. and Russell, J.B. (1989b) More monensin-sensitive, ammonia producing bacteria from the rumen. *Applied and Environmental Microbiology* 55, 1052–1057.
- Chen, G. and Russell, J.B. (1990) Transport and deamination of amino acids by a gram positive, monensin-sensitive ruminal bacterium. *Applied and Environmental Microbiology* 56, 2186–2192.
- Chen, G., Russell, J.B. and Sniffen, C.J. (1987a) A procedure of measuring peptides in the rumen fluid and evidence that peptide uptake can be a rate-limiting step in ruminal protein degradation. *Journal of Dairy Science* 70, 1211–1219.
- Chen, G., Sniffen, C.J. and Russell, J.B. (1987b) Concentration and estimated flow of peptides from the rumen of dairy cattle: effects of protein quality, protein solubility, and feeding frequency. *Journal of Dairy Science* 70, 983–992.
- Cheng, K.-J. and Wallace, R.J. (1979) The mechanism of passage of endogenous urea through the rumen wall and the role of ureolytic epithelial bacteria in the urea flux. *British Journal of Nutrition* 42, 553–557.
- Chikunya, S., Newbold, C.J., Rode, L., Chen, X.B. and Wallace, R.J. (1996) Influence of dietary rumen-degradable protein on bacterial growth in the rumen of sheep receiving different energy sources. *Animal Feed Science and Technology* 63, 333–340.
- Cooper, P.B. and Ling, J.R. (1985) The uptake of peptides and amino acids by rumen bacteria. *Proceedings of the Nutrition Society* 44, 144A.
- Cotta, M.A. and Russell, J.B. (1997) Digestion of nitrogen in the rumen. In: Mackie, R.I. and White, B.A. (eds) *Gastrointestinal Microbiology*. Chapman and Hall, New York, pp. 424–469.
- Cruz Soto, R., Muhammed, S.A., Newbold, C.J., Stewart, C.S. and Wallace, R.J. (1994) Influence of peptides, amino acids and urea on microbial activity in the rumen of sheep receiving grass hay on the growth of rumen bacteria *in vitro*. *Animal Feed Science and Technology* 49, 151–161.
- Czerkawski, J.W. (1976) Chemical composition of microbial matter in the rumen. *Journal of the Science of Food and Agriculture* 27, 621–632.
- Czerkawski, J.W. and Breckenridge, G. (1982) Distribution and changes in urease (EC 3.5.1.5) activity in the rumen simulation technique (Rusitec). *British Journal of Nutrition* 47, 331–348.
- Depardon, N., Debroas, D. and Blanchart, G. (1995) Breakdown of peptides from a soya protein hydrolysate by rumen bacteria. Simultaneous study of enzyme activities and of two physico-chemical parameters: molecular weight and hydrophobicity. *Journal of the Science of Food and Agriculture* 68, 25–31.
- Dixon, R.M. and Chanchai, S. (2000) Colonization of source of N substrates used by microorganisms digesting forages incubated in synthetic fibre bags in the rumen. *Animal Feed Science and Technology* 83, 261–272.
- Engles, F.M. and Brice, R.E. (1985) A barrier covering lignified cell walls of barley straw that resists access by rumen microorganisms. *Current Microbiology* 12, 217–224.
- Erfle, J.D., Sauer, F.D. and Mahadevan, S. (1977) Effect of ammonia concentration on activity of enzymes of ammonia assimilation and on synthesis of amino acids by mixed bacteria in continuous culture. *Journal of Dairy Science* 60, 1064–1072.
- Eschenlauer, S.C.P., McEwan, N.R., Nelson, N., Calza, R.E., Wallace, R.J. and Newbold, C.J. (1999) An NAD-dependent glutamate dehydrogenase cloned from the rumen ciliate protozoan, *Entodinium caudatum*. *Proceedings of IX International Symposium on Ruminant Physiology*, Pretoria, South Africa, p. 58.
- Eschenlauer, S.C.P., McKain, N., Walker, N.D., McEwan, N.R., Newbold, C.J. and Wallace, R.J. (2002) Ammonia production by ruminal microorganisms, and enumeration, isolation and characterization of bacteria capable of growth in peptides and amino acids from the sheep rumen. *Applied Environmental Microbiology* 68, 4925–4931.
- Falconer, M.L. and Wallace, R.J. (1998) Variation in proteinase activities in the rumen. *Journal of Applied Microbiology* 84, 377–382.
- Floret, F., Chaudhary, L.C., Ellis, W.C., El Hassan, S., McKain, N., Newbold, C.J. and Wallace, R.J. (1999) Influence of 1-[(E)-2-(2-methyl-4-nitrophenyl)diaz-1-enyl]pyrrolidine-2-carboxylic acid and diphenyliodonium chloride on ruminal protein metabolism and ruminal microorganisms. *Applied and Environmental Microbiology* 65, 3258–3260.
- Gibbons, R.J. and McCarthy, R.D. (1957) Obligately anaerobic urea-hydrolyzing bacteria in the bovine rumen. *University of Maryland Agricultural Experimental Station Miscellaneous Publications* 291, 12–16.

- Griswold, K.E., Hoover, W.H., Miller, T.K. and Thayne, W.V. (1996) Effect of form of nitrogen on growth of ruminal microbes in continuous culture. *Journal of Animal Science* 74, 483–491.
- Gruby, D. and Delafond, H.M.O. (1843) Recherches sur des animalcules se développant en grand nombre dans l'estomac et dans les intestins pendant la digestion des animaux herbivores et carnivores. *Comptes Rendus Hebdomadaires des Séances de l'Académie des Sciences, Paris* 17, 1304–1308.
- Hammond, A.C. (1995) *Leucaena* toxicosis and its control in ruminants. *Journal of Dairy Science* 73, 1487–1492.
- Hammond, A.C., Carlson, J.R. and Breeze, R.G. (1978) Monensin and the prevention of tryptophan-induced acute bovine pulmonary edema and emphysema. *Science* 201, 153–155.
- Harmeyer, J. (1965) Fixation of carbon dioxide in amino acids by isolated rumen protozoa (*Iso-tricha prostoma* and *I. intestinalis*). *Zentralblatt für Veterinärmedizin* 12, 10–17.
- Hazlewood, G.P., Orpin, C.G., Greenwood, Y. and Black, M.E. (1983) Isolation of proteolytic rumen bacteria by use of selective medium containing leaf fraction I protein (ribulose bis phosphate carboxylase). *Applied and Environmental Microbiology* 45, 1780–1784.
- Hegarty, M.P., Court, R.D., Christie, G.S. and Lee, C.P. (1976) Mimosine in *Leucaena leucocephala* is metabolised to a goitrogen in ruminants. *Australian Veterinary Journal* 52, 490.
- Henderickx, H.K. (1976) Quantitative aspects of the use of non-protein nitrogen in ruminant feeding. *Cuban Journal of Agricultural Science* 10, 1–18.
- Higgins, C.F. and Gibson, M.M. (1986) Peptide transport in bacteria. *Methods in Enzymology* 125, pp. 365–377.
- Hino, T. and Russell, J.B. (1985) Effect of reducing-equivalent disposal and NADH/NAD on deamination of amino acids by intact rumen microorganisms and their cell extracts. *Applied and Environmental Microbiology* 50, 1368–1374.
- Hristov, A.N. and Broderick, G.A. (1994) *In vitro* determination of ruminal protein degradability using [<sup>15</sup>N]ammonia to correct for microbial nitrogen uptake. *Journal of Dairy Science* 72, 1344–1354.
- Hsu, J.T., Fahey, G.C., Jr, Berger, L.L., Mackie, R.I. and Merchen, N.R. (1991) Manipulation of nitrogen digestion by sheep using defaunation and various nitrogen supplementation regimens. *Journal of Animal Science* 69, 1290–1299.
- Hungate, R.E. (1947) Studies on cellulose fermentation. III The culture and isolation of cellulose-decomposing bacteria from the rumen of cattle. *Journal of Bacteriology* 53, 631–645.
- Hvelplund, T., Misciattelli, L. and Weisbjerg, M.R. (2001) Supply of the dairy cow with amino acids from dietary protein. *Journal of Animal and Feed Sciences* 10 (Suppl. 1), 69–85.
- Ivan, M., Neill, L. and Entz, T. (2000) Ruminal fermentation and duodenal flow following progressive inoculations of fauna-free wethers with major individual species of ciliate protozoa or total fauna. *Journal of Animal Science* 78, 750–759.
- Jones, G.A., MacLeod, R.A. and Blackwood, A.C. (1964) Ureolytic rumen bacteria: characteristics of the microflora from a urea-fed sheep. *Canadian Journal of Microbiology* 10, 371–378.
- Jones, R.J. and Megarrity, R.G. (1986) Successful transfer of DHP-degrading bacteria from Hawaiian goats to Australian ruminants to overcome the toxicity of *Leucaena*. *Australian Veterinary Journal* 63, 259–262.
- Kennedy, P.M. and Milligan, L.P. (1980) The degradation and utilization of endogenous urea in the gastrointestinal tract of ruminants: a review. *Canadian Journal of Animal Science* 60, 205–221.
- Khan, R.I., Onodera, R., Amin, M.R. and Mohamed, N. (1999) Production of tyrosine and other aromatic compounds from phenylalanine by rumen microorganisms. *Amino Acids* 17, 335–346.
- Kirk, J.M., Woodward, C.L., Ellis, W.C. and Ricke, S.C. (2000) Glutamine synthetase and protease enzyme activities and growth response of ruminal bacterium *Prevotella ruminicola* strain B<sub>4</sub> to nitrogen source and concentration. *Journal of Environmental Science and Health* 1, 103–120.
- Komisarczuk, S., Durand, M., Beaumatin, Ph. and Hannequart, G. (1987) Utilisation de l'azote 15 pour la mesure la protéosynthèse microbienne dans les phases solide et liquide d'un fermenteur semi-continu (Rusitec) (The use of nitrogen-15 for determination of microbial synthesis in the solid and liquid phase of a semi-continuous fermenter (Rusitec)). *Reproduction, Nutrition, Development* 27, 261–262.
- Krause, D.O. and Russell, J.B. (1996) An rRNA approach for assessing the role of obligate amino acid fermenting bacteria in ruminal amino acid deamination. *Applied and Environmental Microbiology* 62, 815–821.
- Leibholz, J. (1969) Effect of diet on the concentration of free amino acids, ammonia and urea in the rumen and blood plasma of the sheep. *Journal of Animal Science* 29, 628–633.
- Lenartova, V., Holovska, K., Havassy, I., Javorsky, P. and Rybosova, E. (1985) Ammonia-utilising enzymes of adherent bacteria in the sheep's rumen. *Physiologia Bohemoslov* 34, 512–517.

- Ling, J.R. and Armstead, I.P. (1995) The *in vitro* uptake and metabolism of peptides and amino acids by five species of rumen bacteria. *Journal of Applied Bacteriology* 78, 116–124.
- Lobley, G.E. (1994) Amino acid and protein metabolism in the whole body and individual tissues of ruminants. In: Asplund, J.M. (ed.) *Principles of Protein Nutrition of Ruminants*. CRC Press, London, pp. 147–178.
- Lowe, S.E., Theodorou, M.K., Trinci, A.P.J. and Hespell, R.B. (1985) Growth of anaerobic rumen fungi on defined and semi-defined media lacking rumen fluid. *Journal of General Microbiology* 131, 2225–2229.
- Maeng, W.J., Van Nevel, C.J., Baldwin, R.L. and Morris, J.G. (1976) Rumen microbial growth rates and yields: effects of amino acids and proteins. *Journal of Dairy Science* 59, 68–79.
- Mahadevan, S., Sauer, F. and Erfle, J.D. (1976) Studies on bovine rumen bacterial urease. *Journal of Animal Science* 42, 745–753.
- Mahadevan, S., Erfle, J.D. and Sauer, F.D. (1980) Degradation of soluble and insoluble proteins by *Bacteroides amylophilus* protein and by rumen microorganisms. *Journal of Animal Science* 50, 723–728.
- Makkar, H.P.S., Sharma, O.P., Dawra, R.K. and Negi, S.S. (1981) Effect of acetohydroxamic acid on rumen urease activity *in vitro*. *Journal of Dairy Science* 64, 643–648.
- Mangan, J.L. (1972). Quantitative studies on nitrogen metabolism in the bovine rumen. The rate of proteolysis of casein and ovalbumin and the release and metabolism of free amino acids. *British Journal of Nutrition* 27, 261–283.
- Masson, H.A. and Ling, J.R. (1986) The *in vitro* metabolism of free and bacterially bound 2,2'-diaminopimelic acid by rumen microorganisms. *Journal of Applied Bacteriology* 60, 341–349.
- Matheron, C., Delort, A.M., Gaudet, G., Liptaj, T. and Forano, E. (1999) Interactions between carbon and nitrogen metabolism in *Fibrobacter succinogenes* S85: a H-1 and C-13 nuclear magnetic resonance and enzymatic study. *Applied and Environmental Microbiology* 65, 1941–1948.
- McIntosh, F.M., Newbold, C.J., Losa, R., Williams, P. and Wallace, R.J. (2000) Effects of essential oils on rumen fermentation. *Reproduction, Nutrition, Development* 40, 221–222.
- McKain, N., Wallace, R.J. and Watt, N.D. (1992) Selective isolation of bacteria with dipeptidyl aminopeptidase type I activity from the sheep rumen. *FEMS Microbiology Letters* 95, 169–174.
- McSweeney, C.S., Palmer, B., Bunch, R. and Krause, D.O. (1999) Isolation and characterization of proteolytic ruminal bacteria from sheep and goats fed the tannin-containing shrub legume *Calliandra calothyrsus*. *Applied and Environmental Microbiology* 65, 3075–3083.
- Merchen, N.R. and Titgemeyer, E.C. (1992) Manipulation of amino acid supply to the growing ruminant. *Journal of Animal Science* 70, 3238–3247.
- Merry, R.J., McAllan, A.B. and Smith, R.H. (1990) *In vitro* continuous culture studies on the effect of nitrogen source on microbial growth and fibre digestion. *Animal Feed Science and Technology* 31, 55–64.
- Milligan, L.P. (1970) Carbon dioxide fixing pathways of glutamic acid synthesis in the rumen. *Canadian Journal of Biochemistry* 48, 463–468.
- Morrison, M. and Mackie, R.I. (1997) Biosynthesis of nitrogen-containing compounds. In: Mackie, R.I. and White, B.A. (eds) *Gastrointestinal Microbiology*. Chapman and Hall, New York, pp. 424–469.
- Morrison, M., Mackie, R.I. and Smith, R.H. (1990) 3-Phenylpropanoic acid improves the affinity of *Ruminococcus albus* for cellulose in continuous culture. *Applied and Environmental Microbiology* 56, 3220–3222.
- Newbold, C.J., Wallace, R.J. and McKain, N. (1990) Effect of the ionophore tetronasin, on nitrogen metabolism of rumen microorganisms *in vitro*. *Journal of Animal Science* 68, 1103–1109.
- Newbold, C.J., Wallace, R.J. and Watt, N.D. (1992) Properties of ionophore-resistant *Bacteroides rumicola* enriched by cultivation in the presence of tetronasin. *Journal of Applied Bacteriology* 72, 65–70.
- Nolan, J. V. (1975) Quantitative models of nitrogen metabolism in sheep. In: McDonald, I.W. and Warner, A.C.I. (eds) *Digestion and Metabolism in the Ruminant*. University of New England, Armidale, pp. 416–431.
- Nolan, J.V. (1993) Nitrogen kinetics. In: Forbes, J.M. and France, J. (eds) *Quantitative Aspects of Ruminant Digestion and Metabolism*. CAB International, Wallingford, UK, pp. 123–143.
- Nugent, J.H.A. and Mangan, J.L. (1981) Characteristics of the rumen proteolysis of fraction I (18S) leaf protein from lucerne (*Medicago sativa* L). *British Journal of Nutrition* 46, 39–58.

- Nugent, J.H.A., Jones, W.T., Jordan, D.J. and Mangan, J.L. (1983) Rates of proteolysis in the rumen of the soluble proteins casein, fraction I (18S) leaf protein, bovine serum albumin and bovine submaxillary mucoprotein. *British Journal of Nutrition* 50, 357–368.
- Okuuchi, K., Nagasawa, T., Tomita, Y. and Onodera, R. (1993) *In vitro* metabolism of tryptophan by rumen microorganisms: the interrelationship between mixed rumen protozoa and bacteria. *Animal Science Technology (Japan)* 64, 1079–1086.
- Onodera, R. (1986) Contribution of protozoa to lysine synthesis in the *in vitro* rumen microbial ecosystem. *Applied and Environmental Microbiology* 51, 1350–1351.
- Onodera, R. and Kandatsu, M. (1973) Synthesis of lysine from  $\alpha,\epsilon$ -diaminopimelic acid by mixed ciliated rumen protozoa. *Nature New Biology* 244, 31–32.
- Onodera, R. and Kandatsu, M. (1974) Formation of lysine from  $\alpha,\epsilon$ -diaminopimelic acid and negligible synthesis of lysine from some other precursors by rumen ciliate protozoa. *Agricultural and Biological Chemistry* 38, 913–920.
- Onodera, R., Shinjo, T. and Kandatsu, M. (1974) Formation of lysine from  $\alpha,\epsilon$ -diaminopimelic acid contained in rumen bacterial cell walls by rumen ciliate protozoa. *Agricultural and Biological Chemistry* 38, 921–926.
- Onodera, R., Nakagawa, Y. and Kandatsu, M. (1977) Ureolytic activity of the washed cell suspension of rumen ciliate protozoa. *Agricultural and Biological Chemistry* 41, 2177–2182.
- Orpin, C.G. (1975) Studies on the rumen flagellate *Neocallimastix frontalis*. *Journal of General Microbiology* 91, 249–262.
- Orpin, C.G. and Greenwood, Y. (1986) Nutritional and germination requirements of the rumen chytrid-omycete *Neocallimastix frontalis*. *Transactions of the British Mycological Society* 86, 103–109.
- Orpin, C.G. and Joblin, K.N. (1997) The rumen anaerobic fungi. In: Hobson, P.N. and Stewart, C.S. (eds) *The Rumen Microbial Ecosystem*. Blackie Academic and Professional, London, pp. 140–195.
- Or-Rashid, M.M., Onodera, R. and Wadud, S. (2001) Biosynthesis of threonine from homoserine by mixed rumen microorganisms: an *in vitro* study. *Current Microbiology* 42, 73–77.
- Paster, B.J., Russell, J.B., Yang, C.M.J., Woese, C.R. and Tanner, R. (1993) Phylogeny of the ammonia-producing ruminal bacteria *Peptostreptococcus anaerobius*, *Clostridium sticklandii* and *Clostridium aminophilum* sp.nov. *International Journal of Systematic Bacteriology* 43, 107–110.
- Patterson, J.A. (1992) Rumen microbiology. In: Lederberg, J. (ed.) *Encyclopedia of Microbiology*. Academic Press, London.
- Pittman, K.A. and Bryant, M.P. (1964) Peptides and other nitrogen sources for growth of *Bacteroides rumenicola*. *Journal of Bacteriology* 88, 401–410.
- Pittman, K.A., Lakshmanan, S. and Bryant, M.P. (1967) Oligopeptide uptake by *Bacteroides rumenicola*. *Journal of Bacteriology* 93, 1499–1508.
- Prins, R.A., Van Gestel, J.C. and Counotte, G.H.M. (1979) Degradation of amino acids and peptides by mixed rumen microorganisms. *Zeitschrift für Tierphysiologie, Tierernaehrung und Futtermittelkunde* 42, 333–339.
- Purser, D.B. and Buechler, S.M. (1966) Amino acid composition of rumen organisms. *Journal of Dairy Science* 49, 81–84.
- Roffler, R.E. and Satter, L.D. (1975) Relationship between ruminal ammonia and nonprotein nitrogen utilization by ruminants. II Application of published evidence to the development of a theoretical model for predicting non-protein nitrogen utilization. *Journal of Dairy Science* 58, 1889–1998.
- Russell, J.B. and Sniffen, C.J. (1984) Effect of carbon-4 and carbon-5 volatile fatty acids on growth of mixed rumen bacteria *in vitro*. *Journal of Dairy Science* 67, 987–994.
- Russell, J.B. and Strobel, H.J. (1987) Concentration of ammonia across cell membranes of mixed ruminal bacteria. *Journal of Dairy Science* 70, 970–976.
- Russell, J.B., Strobel, H.J. and Chen, G. (1988) Enrichment and isolation of a ruminal bacterium with a very high specific activity of ammonia production. *Applied and Environmental Microbiology* 54, 872–877.
- Russell, J.B., Onodera, R. and Hino, T. (1991) Ruminal protein fermentation: new perspectives on previous contradictions. In: Tsuda, T., Sasaki, Y. and Kawashima, R. (eds) *Physiological Aspects of Digestion and Metabolism in Ruminants*. Academic Press, Tokyo, pp. 681–697.
- Russell, J.B., O'Connor, J.D., Fox, D.G., Van Soest, P.J. and Sniffen, C.J. (1992) A net carbohydrate and protein system for evaluating cattle diets – I. Ruminal fermentation. *Journal of Animal Science* 70, 3551–3561.

- Sakurada, M., Morgavi, D.P., Tomita, Y. and Onodera, R. (1994) Ureolytic activity of anaerobic rumen fungi, *Piromyces* sp. OTS3 and *Neocallimastix* sp. OTS4. *Animal Science and Technology (Japan)* 65, 950–955.
- Salter, D.N., Daneshvar, K. and Smith, R.H. (1979) The origin of nitrogen incorporated into compounds in the rumen bacteria of steers given protein- and urea-containing diets. *British Journal of Nutrition* 41, 197–209.
- Sauer, F.D., Erfle, J.D. and Mahadevan, S. (1975) Amino acid biosynthesis in the mixed rumen cultures. *Biochemical Journal* 150, 357–372.
- Sauvant, D. (1997) Rumen mathematical modelling. In: Hobson, P.N. and Stewart, C.S. (eds) *The Rumen Microbial Ecosystem*. Blackie Academic and Professional, London, pp. 685–708.
- Shimbayashi, K., Obara, Y. and Yonemura, T. (1975) Changes of free amino acids during rumen fermentation and incorporation of urea  $^{15}\text{N}$  into microorganisms *in vitro*. *Japanese Journal of Zootechnical Science* 46, 243–250.
- Siddons, R.C. and Paradine, J. (1981) Effect of diet on protein degrading activity in the sheep rumen. *Journal of the Science of Food and Agriculture* 32, 973–981.
- Spears, J.W. and Hatfield, E.E. (1978) Nickel for ruminants I. Influence of dietary nickel on ruminal urease activity. *Journal of Animal Science* 47, 1345–1350.
- Spears, J.W., Smith, C.J. and Hatfield, E.E. (1977) Rumen bacterial urease requirement for nickel. *Journal of Dairy Science* 60, 1073–1076.
- Stack, R.J., Hungate, R.E. and Opsahl, W.P. (1983) Phenylacetic acid stimulation of cellulose digestion by *Ruminococcus albus* 8. *Applied and Environmental Microbiology* 46, 539–544.
- Stewart, C.S., Flint, H.J. and Bryant, M.P. (1997) The rumen bacteria. In: Hobson, P.N. and Stewart, C.S. (eds) *The Rumen Microbial Ecosystem*. Blackie Academic and Professional, London, pp. 10–72.
- Takagi, T., Ando, R., Ohgushi, A., Yamashita, T., Dobashi, E., Hussain-Yusuf, H., Onodera, R., Bungo, T., Sato, H. and Fursue, M. (2001) Intracerebroventricular injection of pipercolic acid inhibits food intake and induced sleep-like behaviors in the neonatal chick. *Neuroscience Letters* 310, 97–100.
- Teather, R.M., Hefford, M.A. and Forster, R.J. (1997) Genetics of rumen bacteria. In: Hobson, P.N. and Stewart, C.S. (eds) *The Rumen Microbial Ecosystem*. Blackie Academic and Professional, London, pp. 427–466.
- Umbarger, H.E. (1978) Amino acid biosynthesis and its regulation. *Annual Review of Biochemistry* 47, 533–606.
- Van Gylswyk, N.O. (1990) Enumeration and presumptive identification of some functional groups of bacteria in the rumen of dairy cows fed grass silage-based diets. *FEMS Microbiology Ecology* 73, 243–254.
- Veira, D.M. (1986) The role of ciliate protozoa in nutrition of the ruminant. *Journal of Animal Science* 63, 1547–1560.
- Virtanen, A.I. (1966) Milk production of cows on protein-free feed. *Science* 153, 1603–1614.
- Von Tappeiner, H. (1884) *Zeitschrift für Biologie* 20, 52–134.
- Wadud, S., Onodera, R. and Or-Rashid, M.M. (2001) Studies on the possibility of histidine biosynthesis from histidinol, imidazolepyruvic acid, imidazoleacetic acid, and imidazolelactic acid by mixed ruminal bacteria, protozoa, and their mixture *in vitro*. *Applied Microbiology and Biotechnology* 55, 219–225.
- Wallace, R.J. (1979) Effect of ammonia concentration and the composition, hydrolytic activity and nitrogen metabolism of the microbial flora of the rumen. *Journal of Applied Bacteriology* 47, 443–455.
- Wallace, R.J. (1983) Hydrolysis of  $^{14}\text{C}$  labelled proteins by rumen microorganisms and by proteolytic enzymes prepared from rumen bacteria. *British Journal of Nutrition* 50, 345–355.
- Wallace, R.J. (1992a) Gel filtration studies of peptide metabolism by rumen microorganisms. *Journal of the Science of Food and Agriculture* 58, 177–184.
- Wallace, R.J. (1992b) Acetylation of peptides inhibits their degradation by rumen microorganisms. *British Journal of Nutrition* 68, 365–372.
- Wallace, R.J. (1994) Amino acid and protein synthesis, turnover and breakdown by ruminal microorganisms. In: Asplund, J.M. (ed.) *Principles of Protein Nutrition of Ruminants*. CRC Press, Florida.
- Wallace, R.J. (1996) Ruminant microbial metabolism of peptides and amino acids. *Journal of Nutrition* 126, 1326S–1334S.
- Wallace, R.J. and Joblin, K.N. (1985) Proteolytic activity of a rumen anaerobic fungus. *FEMS Microbiology Letters* 29, 19–25.
- Wallace, R.J. and McKain, N. (1990) A comparison of methods for determining the concentration of extracellular peptides in rumen fluid of sheep. *Journal of Agricultural Science, Cambridge* 114, 101–105.

- Wallace, R.J. and McKain, N. (1991) A survey of peptidase activity in rumen bacteria. *Journal of General Microbiology* 137, 2259–2264.
- Wallace, R.J. and McKain, N. (1996) Influence of 1,10-phenanthroline and its analogues, other chelators, and transition metal ions on dipeptidase activity of the rumen bacterium, *Prevotella ruminicola*. *Journal of Applied Bacteriology* 81, 42–47.
- Wallace, R.J., Newbold, C.J. and McKain, N. (1990a) Patterns of peptide metabolism by rumen microorganisms. In: Hoshino, S., Onodera, R., Minato, H. and Itabashi, H. (eds) *The Rumen Ecosystem. The Microbial Metabolism and its Control*. Japan Scientific Societies Press, Tokyo, pp. 43–50.
- Wallace, R.J., McKain, N. and Newbold, C.J. (1990b) Metabolism of small peptides in rumen fluid. Accumulation of intermediates during hydrolysis of alanine oligomers, and comparison of peptidolytic activities of bacteria and protozoa. *Journal of the Science of Food and Agriculture* 50, 191–199.
- Wallace, R.J., Frumholtz, P.P. and Walker, N.D. (1993) Breakdown of N-terminally modified peptides and an isopeptide by rumen microorganisms. *Applied and Environmental Microbiology* 59, 3147–3149.
- Wallace, R.J., Newbold, C.J. and McKain, N. (1996) Inhibition by 1,10-phenanthroline of the breakdown of peptides by rumen bacteria and protozoa. *Journal of Applied Bacteriology* 80, 425–430.
- Wallace, R.J., Onodera, R. and Cotta, M.A. (1997) Metabolism of nitrogen containing compounds. In: Hobson, P.N. and Stewart, C.S. (eds) *The Rumen Microbial Ecosystem*. Blackie Academic and Professional, London, pp. 283–328.
- Wallace, R.J., Min, W.K., Witt, M.W., Grant, G., MacRae, J.C., Maeng, W.J., Newbold, C.J. and Rode, L.M. (1998) Uptake of acetylated peptides from the small intestine in sheep and their nutritive value in rats. *British Journal of Nutrition* 80, 101–108.
- Webb, E.C. (1992) *Enzyme Nomenclature 1992*. Academic Press, London.
- Wen, Z. and Morrison, M. (1996) The NAD(P)H-dependent glutamate dehydrogenase activities of *Prevotella ruminicola* B<sub>14</sub> can be attributed to one enzyme (GdhA), and *gdhA* expression is regulated in response to the nitrogen source available for growth. *Applied and Environmental Microbiology* 62, 3826–3833.
- Wen, Z. and Morrison, M. (1997) Glutamate dehydrogenase activity profiles for type strains of ruminal *Prevotella* spp. *Applied and Environmental Microbiology* 63, 3314–331.
- Westlake, K. and Mackie, R.I. (1990) Peptide and amino acid transport in *Streptococcus bovis*. *Applied Microbiology and Biotechnology* 34, 97–102.
- Whetstone, H.D., Davis, C.L. and Bryant, M.P. (1981) Effect of monensin on breakdown of protein by rumen microorganisms *in vitro*. *Journal of Animal Science* 53, 803–809.
- Williams, A.G. (1979) The selectivity of carbohydrate assimilation in the anaerobic rumen ciliate *Dasytricha ruminantium*. *Journal of Applied Bacteriology* 47, 511–520.
- Williams, A.G. and Coleman, G.S. (1992) *The Rumen Protozoa*. Springer-Verlag, New York.
- Williams, A.G. and Harfoot, C.G. (1976) Factors affecting the uptake and metabolism of soluble carbohydrates by the rumen ciliate *Dasytricha ruminantium* isolated from ovine rumen contents by filtration. *Journal of General Microbiology* 96, 125–136.
- Witt, M.W., Newbold, C.J. and Wallace, R.J. (1998) Influence of dietary acetylated peptides on fermentation and peptidase activities in the sheep rumen. *Journal of Applied Microbiology* 84, 847–851.
- Wright, D.E. (1967) Metabolism of peptides by rumen microorganisms. *Applied Microbiology* 15, 148–151.
- Wright, D.E. and Hungate, R.E. (1967) Amino acid concentrations in rumen fluid. *Applied Microbiology* 15, 148–151.
- Yang, C.M.J. and Russell, J.B. (1992) Resistance of proline-containing peptides to ruminal degradation *in vitro*. *Applied and Environmental Microbiology* 58, 3954–3958.
- Yang, C.M.J. and Russell, J.B. (1993) Effect of monensin on the specific activity of ammonia production by ruminal bacteria and disappearance of amino nitrogen from the rumen. *Applied and Environmental Microbiology* 59, 3250–3254.
- Yokoyama, M.T., Carlson, J.R. and Holdeman, L.V. (1977) Isolation and characteristics of a skatole-producing *Lactobacillus* sp. from the bovine rumen. *Applied and Environmental Microbiology* 34, 837–842.
- Zhu, W.Y., Kingston-Smith, A.H., Troncoso, D., Merry, R.J., Davies, D.R., Pichard, G., Thomas, H. and Theodorou, M.K. (1999) Evidence of a role for plant proteases in the degradation of herbage proteins in the rumen of grazing cattle. *Journal of Dairy Science* 82, 2651–2658.

# 16 Modelling Amino Acid Metabolism in Ruminants

**R.L. Baldwin\*, C.C. Calvert, P.H. Robinson and H.A. Johnson**  
*Department of Animal Science, University of California, Davis, California, USA*

---

## Introduction

The development and documentation of models are most often intellectually demanding, laborious and tedious processes. Consider a model in which 30 transactions among ten state variables are addressed (consider 20 amino acids with five transactions each). In such a model, defensible equation forms for each of the transactions (30) must be formulated based upon concepts and data relating to each transaction. Data sufficient to estimate, on average, two parameter values for each equation and to set initial values for each of the state variables must be collected; e.g. 70 numerical values must be established. At a minimum, 100 publications would have to be consulted in formulation of the first version of the model. Then a test data set to challenge the model must be formulated based upon another, preferably, 100 plus independent experimental studies. In this context, it is very daunting to attempt summarizations and evaluations of models of protein and amino acid metabolism in ruminants. Only a few, more or less, representative models can be considered and only then in part and possibly and unfairly out of context. These considerations were clearly in our minds when we selected models, or rather parts thereof, for consideration in this chapter.

We elected to start with models of ruminant digestive processes varying in complexity but all leading to estimates of protein availability to the ruminant animal. We started with the current US National Research Council model for lactating dairy cows (NRC, 1989), which is simple, static and highly empirical. We then considered the Cornell model, which is static but incorporates a number of mechanistic elements (Search: Agriculture, 1990) followed by a discussion of ruminally protected amino acids. We then consider of the UC Davis model (Baldwin *et al.*, 1987a,b,c), which is dynamic and incorporates mechanistic elements similar to those in the Cornell model. This includes recent modifications in which the amino acid pool is now represented as four distinct pools and provisions for computing the stoichiometry of amino acid degradation dynamically.

A major concern in the formulation of models of amino acid and protein metabolism over time is that accurate estimates of protein synthesis and degradation and of reutilization of amino acids arising from degradation in protein resynthesis be available. The specific methods and analytical models used to interpret the data obtained impact on estimates of protein synthesis. Therefore, a section of the chapter is dedicated to consideration of potential sources of error in estimates of protein synthesis and the complexity of data and

\*E-mail address: RLBaldwin@UCDavis.Edu



analytical models required to overcome the problems. This section is followed by a discussion of a rodent model of protein turnover. The rodent model serves as a basis for the development of a ruminant model of protein turnover, and also serves as the analytical tool for the interpretation of data generated to estimate protein turnover and identifies the appropriate designs for further experimentation.

## Digestive Elements

### NRC model

Rumen digestion of crude protein (CP), and protein available at the intestinal absorptive site as metabolizable protein (MP), is predicted using static equations in the NRC model (NRC, 2001). There are a number of required feedstuff chemical analyses and feedstuff biological determinations, as well as some characteristics of the animals to which the feedstuffs and ration are to be fed, that are required as model input. The process proceeds stepwise to create numerous empirical equations that are finally combined to constitute an evaluative/predictive model.

The first step is to predict microbial crude protein (MCP) from 'discounted' total digestible nutrients (TDN) intake ( $\text{g day}^{-1}$ ) as:

$$\text{MCP} = \text{TDN} \times 0.13 \quad [16.1]$$

Calculation of discounted TDN is itself a summative equation utilizing several feedstuff chemical assays, as well as an estimate of ruminal digestion of neutral detergent fibre. The 'discount' refers to the reduction in the energy (TDN) content of the diet as its relative intake increases. Microbial crude protein production is subsequently used to calculate the rumen degraded protein (RDP) requirement using the assumption that 18% more RDP is required than appears as MCP. It is assumed that the oversupply of RDP is lost from the rumen as ammonia. However, if the supply of RDP is less than 118% of TDN predicted MCP, then MCP is calculated as:

$$\text{MCP} = \text{RDP} \times 0.85 \quad [16.2]$$

These relationships are based on the assumption that RDP composition and availability in the rumen does not affect rates of micro-

bial growth. This simplification fails to capture interactions between protein and carbohydrate availability, although NRC (2001) addresses this issue by the statement that '... when rumen fermentation is normal, there is little additional benefit of altering carbohydrate or protein degradation rates, or their level of synchrony, on microbial protein synthesis'. The assumption that the required oversupply of RDP is a constant proportion of RDP is probably inadequate as well, since this flux is largely dependent upon rumen ammonia concentrations.

Difficulties with these calculations are that fat in the diet contributes to discounted TDN, whereas there is no experimental evidence that this occurs, and that there is no limit to the proportion of RDP that can be provided from non-protein nitrogen (NPN) sources, such as urea, to support microbial growth. Thus, high fat diets will elicit a calculated RDP deficiency for microbial growth that can be corrected by dietary addition of urea.

Once the RDP requirement of the ruminal microorganisms is calculated, the RDP and rumen undegraded protein (RUP) proportions of feed CP are calculated based on the assumption that feed CP can be divided into three fractions, referred to as A, B and C, with a first order rate of degradation constant for fraction B. The *in situ* approach is recommended to determine these fractions, with the assumption that fraction A crude protein is rapidly and completely degraded in the rumen, fraction B crude protein is potentially degraded at a first order rate ( $k_d$ ) and fraction C crude protein is indigestible. That the *in situ* procedure is highly variable among and within labs, which has led to its widespread abandonment in the scientific literature, and that all accepted assumptions relative to fractions A, B and C have been found to be false, is little addressed. Nevertheless the feed proportions of RDP are undegraded dietary protein (UDP) are calculated as:

$$\text{RDP} = A + B(k_d/(k_d+k_p)) \quad [16.3]$$

$$\text{UDP} = B(k_p/(k_d+k_p)) + C \quad [16.4]$$

Where the rates of passage ( $k_p$ ) of various feedstuffs are calculated from three equations for wet forages (eqn 16.5), dry forages (eqn 16.6) and concentrate feeds (eqn 16.7) as:

$$k_p = 3.054 + 0.614(X_1) \quad [16.5]$$

$$k_p = 3.362 + 0.479(X_1) - 0.007(X_2) - 0.017(X_3) \quad [16.6]$$

$$k_p = 3.904 + 1.375(X_1) - 0.002(X_2) \quad [16.7]$$

where  $X_1$  = DM intake, % of body weight;  $X_2$  = concentrate, % of diet DM;  $X_3$  = NDF %, % of DM.

Questions related to how to define feed-stuffs into the three categories, the origin of the data used to generate these calculations (except that they are based on unspecified experiments using rare earth elements), and any validation of the equations, are not addressed.

Endogenous CP (ECP) is calculated directly from DM intake as:

$$\text{ECP} = \text{DMI}(\text{kg day}^{-1}) \times 11.88 \quad [16.8]$$

After all sources of CP flowing to the intestine (i.e. MCP, UDP, ECP) have been estimated, their MP fractions are estimated as fixed constants of 0.64 for MCP and 0.40 for ECP. Intestinal digestibility of RUP is considered to be predictable based on the mobile bag technique, or a two-stage *in vitro* digestion procedure, but not as acid detergent insoluble CP which was judged unacceptable. The conversion of digestible UDP into MP is considered to be 100%. That the mobile bag procedure is known to overestimate the MP content of RUP, as it measures CP disappearing from the bag in the large intestine to be MP, is not addressed.

In the NRC (2001) system, microbial growth is a function of discounted TDN and (or) RDP intake. Feed protein escape from the rumen depends on its division into soluble, degradable and undegradable fractions, with a first order rate of degradation of the degradable fraction, as well as calculated rates of rumen passage which are based on total DM intake of the target animal, its concentrate proportion and the neutral detergent fibre (NDF) content of the feedstuff. Endogenous protein is calculated as a function of DM intake. Conversion of these three crude protein flows into the intestine into MP assumes separate constants. Numerous assumptions are inherent to all of these calculations and virtually all of them have been shown to be false.

The calculations depend exclusively on empirical equations derived from data sets, of variable sizes and degrees of definition, derived from published studies. Validation of these empirical equations by use of independent data sets is not attempted.

### Cornell model

Bacterial yield in the Cornell model (Search: Agriculture, 1990) is defined as a static function of feed inputs. Inputs required to predict bacterial yield include: (i) a complete fibre analysis (Van Soest); (ii) total nitrogen and NPN; (iii) acid-detergent-insoluble nitrogen; (iv) neutral-detergent-insoluble nitrogen; (v) protein solubility; (vi) solvent soluble fat; and (vii) ash. These inputs are used to predict the growth rates of three separate pools of microbes as defined by the following equations:

$$\text{Bact}_j = \text{NSCBact}_j + \text{SCBact}_j \quad [16.9]$$

where  $\text{SCBact}_j$  = the yield of structural carbohydrate (SC)-fermenting bacteria from the  $j$ th feedstuff ( $\text{g day}^{-1}$ ) and  $\text{NSCBact}_j$  = the yield of non-structural carbohydrate (NSC)-fermenting bacteria from the  $j$ th feedstuff ( $\text{g day}^{-1}$ ). The NSC bacterial pool is further divided into starch-fermenting and sugar-fermenting pools. The efficiency of bacterial yield is calculated according to the following equation:

$$\frac{1}{Y_{aj}} = \frac{Km_a + 1}{Kd_{aj} YG_a} \quad [16.10]$$

where  $Km_a$  = the maintenance requirement of the  $a$ th pool of bacteria ( $a$  = SC-fermenting, sugar-fermenting, or starch- and pectin-fermenting;  $\text{g carbohydrate g}^{-1}$  bacteria  $\text{h}^{-1}$ ),  $Kd_{aj}$  = the rate of fermentation or growth of the  $a$ th pool of bacteria on the  $j$ th feed ( $\text{h}^{-1}$ ), and  $YG_a$  is the theoretical maximal yield of the  $a$ th pool of bacteria ( $\text{g bacteria g}^{-1}$  carbohydrate). This type of equation captures the principle that slowly fermented feeds will have a greater proportion of fermentable substrate utilized to maintain bacterial populations than feeds that are fermentable at higher rates. Similar equations are used for sugar- and starch-fermenting bacteria. Nitrogen availability affects the bacterial yield of  $\text{NSCBact}$  according to the following equations:

$$Y_{aj} = Y_{aj} \times (1 + IMP_j \times 0.01) \quad [16.11]$$

$$IMP_j = \exp(0.404 \times \ln(Ratio_j \times 100) + 1.942) \quad [16.12]$$

$$Ratio_j = \frac{RDPEp_j}{RDSugar_j + RDStarch_j + RDPEp_j} \quad [16.13]$$

$$RDPEp_j = RDPB_{bj} + RDPB_{bj} + RDPB_{bj} \quad [16.14]$$

$$RDPB_{bj} = DietPB_{bj} \times \frac{Kd_{bj}}{Kd_{bj} + Kp_j} \quad [16.15]$$

where  $RDPB_{bj}$  = rumen degradable protein ( $b$  = slow, intermediate, or fast rates of degradation) of protein in the  $j$ th feed,  $Kd_j$  = factorial degradation of the  $b$ th protein compartment of the  $j$ th, feed, and  $Kp_j$  = the rate of passage from the rumen of protein in the  $j$ th feed. The quantity of protein escaping rumen degradation or bypassing the rumen is a function of rates of degradation in and passage from the rumen, which are specified by input constants. NSCBact utilize peptides generated by protein degradation in support of their growth whereas growth is dependent on carbohydrate availability as described above. Equations describing peptide uptake are of the same form as those used for protein degradation where uptake is a constant function of rumen available peptides. Peptides generated in excess of requirements for NSCBact growth are subject to deamination on passage from the rumen. Therefore, when NSCBact growth rates are slow, rates of peptide use for microbial growth are low and rates of deamination are high. Nitrogen retained by microbes is calculated using the assumptions that microbes are 10% nitrogen and a maximum of 66% of the nitrogen requirement of NSCBact can be provided by peptides. Peptides taken up in excess of this requirement are deaminated and can be used to meet ammonia requirements of growing microbes. Effects of ionophores are accommodated by reducing the rate of peptide uptake by the NSCBact pool in a stepwise manner. SCBact utilize all of their nitrogen as ammonia.

Rumen ammonia is calculated using the following static, factorial, empirical equation:

$$RAN = (Y + RDPA + NPN) - (PEPUPNR + NSCAMMNR + SCAMMNR) \quad [16.16]$$

where  $Y$  = recycled nitrogen ( $Y = 121.7 - 12.01X + 0.3235X^2$ ;  $X = IP$  and is expressed as per cent of DM),  $RDPA$  = rumen degraded protein,  $NPN$  = non-protein nitrogen derived from the diet,  $PEPUPNR$  = peptide nitrogen retained by microbes,  $NSCAMMNR$  = ammonia nitrogen retained by NSCBact, and  $SCAMMNR$  = ammonia nitrogen retained by SCBact.

Bacterial nitrogen is algebraically divided into true protein, cell wall-associated nitrogen, and nucleic acid nitrogen. These various nitrogenous fractions and fractions derived directly from feed leave the rumen and are digested and absorbed as separate entities allowing specification of unique digestion coefficients for each pool of nitrogen.

This approach overcomes a number of deficiencies inherent in the NRC model. These include linkage of microbial yields, rates of particle and fluid passage, and chemical composition of diets; division of microbial populations by substrate; allowance for variance in ruminal and postruminal digestion of nitrogenous components due to changes in rates of particle passage; and estimates of rumen ammonia concentration.

### Prospects for ruminally protected amino acids

The concept of balancing rations for swine and poultry with pure amino acids has been a part of commercial feed formulation programmes for many years. This has led to lower nitrogen levels of diets, improved efficiencies of nitrogen utilization and, in general, lower ration costs. However the use of pure amino acids in ruminant rations has lagged far behind.

There are a number of reasons that commercial application of amino acid nutritional concepts to ruminant ration formulation has not reached the level attained in the swine and poultry industries. The most obvious reason is that the action of rumen microbes sharply changes the amino acid profile of the

ration consumed to create a different one that reaches the intestinal absorptive site. This has made prediction of metabolizable amino acid delivery to the intestine highly inaccurate and, for practical purposes, values cannot be validated due to procedural difficulties with the only *in vivo* systems available to do so. In addition, there has been a lack of research on metabolizable amino acid requirements of dairy cattle, due equally to the high cost of the research and variability of the data generated. This led NRC (2001) to conclude that insufficient data exists to predict metabolizable amino acid requirements for any amino acids, save lysine and methionine for which relatively large data sets exist from which empirical relationships could be developed. There can be no reasonable expectation that this lack of information will be addressed in the near future, at least partly due to worldwide degradation of the applicable research infrastructure.

Other reasons for a failure to balance dairy rations for metabolizable amino acids are more mundane. In most parts of the developed world, where high producing dairy cattle are concentrated, the costs of proteins have been near historical lows for many years thereby removing the economic incentive for dairy nutritionists to reduce nitrogen levels of rations. In addition, only dairy producers in a very few areas of the world (e.g. The Netherlands) have been forced through government action to pay, in some form, for the environmental impact of nitrogen excretion from their dairies. Under these circumstances, it makes economic sense for the ruminant nutritionist to elevate the protein concentration of the ration by 5–10% over calculated requirements with high UDP sources, known to be rich in potentially limiting amino acids, thereby virtually guaranteeing that metabolizable amino acid supplies will not limit animal performance.

Finally, even if a dairy nutritionist wished to balance dairy rations based on metabolizable amino acids, the tools available are limited. Only one amino acid, methionine, is commercially available in a rumen protected (RP) form and its cost is very high per gram of metabolizable amino acid. There is little evidence from published research to support

enhanced performance, and(or) improved nitrogen efficiency, with RP methionine supplementation of dairy cattle rations (Robinson, 1996), which tends to be primarily associated with modest increases in the milk protein proportion. The low market penetration of the available RP methionine products, developed at very high expense by corporate groups, has not encouraged these, or other, corporate groups to invest in development of other RP amino acids, particularly in the absence of research results showing repeatable commercially substantive benefits to dietary addition of these amino acids. Although a few studies have reported some benefits to dietary supplementation with isoleucine (Robinson *et al.*, 1999) and histidine (Vanhatalo *et al.*, 1999), this literature base is very limited in nature and volume.

However, the commercial situation is changing in two key dairy areas, and this may force commercial dairies in many parts of the developed world to change their nutrient management practices. The environmental impact of dairies in many parts of Europe and America is being scrutinized as never before. In America, the Environmental Protection Agency is under increasing pressure from public interest groups to both enforce current regulations, and introduce more restrictive regulations. The focus seems to be inexorably moving, albeit slowly, to site-specific criteria that will evaluate dairies individually for nutrient, particularly nitrogen and phosphorus, efficiency and penalize those that do not meet defined criteria/goals. These penalties could take the form of fines and(or) taxes, as well as limits on nutrient excretion that could force individual dairies to reduce animal numbers. The other critical recent change has been the elimination of the entire class of animal and marine source high UDP feedstuffs in Europe, and most animal feedstuffs in America, that have played a critical role in allowing dairies to economically overfeed dietary protein, relative to predicted requirements, in order to assure that metabolizable protein and amino acids do not limit animal performance. The elimination of this class of feedstuffs has had a major negative impact on the ability of dairy nutritionists to formulate rations

designed to deliver high calculated levels of specific amino acids, most notably lysine, to the intestinal absorptive site.

In combination, the increasing severity of site specific environmental regulations, particularly in America, and the elimination of all (Europe) or many (America) animal and marine source protein feedstuffs has increased commercial production, and use by commercial dairies, of protein-rich feedstuffs treated to resist rumen degradation. It is likely that the future will see renewed interest in both producing cost-effective RP amino acids, quite likely beyond methionine and lysine, as well as completing research into better defining metabolizable protein and amino acid requirements of dairy cattle. Together these events, if they occur, will allow more predictable formation of rations designed to optimize both animal productivity and nitrogen efficiency.

### UC Davis model

The dynamic model of Baldwin *et al.* (1987a,b,c) is more complex than the NRC and Cornell models, and, therefore, requires more inputs. These include soluble sugars, organic acids, pectins, soluble and insoluble starch, plant lipids, feed fats, soluble and insoluble protein, non-protein nitrogen, hemicellulose, cellulose, lignin, and soluble and insoluble ash. The various feed components enter large particle, small particle or soluble pools of the rumen depending on their chemical and physical characteristics. Rates of rumination influence rates of conversion of large into small particles. Components of small particles are hydrolysed to chemical constituents by associated microbes or passed from the rumen. The inclusion of three pools for feed inputs and association and growth of microbes in association with small particles is required to explicitly accommodate digestion lag times as observed *in vivo*.

Cellulose and hemicellulose digestion are dependent on microbial attachment and are influenced by rumen pH and peptide concentrations. As concentrations of cellulolytic microbes increase, rates of attachment to small particle-structural carbohydrate increase and rates of hydrolysis of feed particles

increase. This results in concomitant increases in rates of entry of peptide and amino acid nitrogen into the soluble pool. Utilization of peptide N is handled somewhat differently compared with the Cornell model. Peptides and amino acids act to enhance theoretical maximal yields of microbes and are used for SC-bacterial growth with a maximal yield of SC-bacteria from peptide and amino acid nitrogen of 50%. The following equations describe the microbial growth components of the model.

$$dMi/dt = U_{MiG} - U_{MiP} \quad [16.17]$$

where  $dMi/dt$  represents the change in the microbial pool (kg) with respect to time. The size of the Mi pool is determined at any time by integrating the equation. Mi partitioning between large particle small particle, and soluble pools is based on the proportion of DM present in each pool.  $U_{MiG}$  represents the input of microbes to the pool due to microbial growth where:

$$U_{MiG} = YATP \times ATP_G \times NH_4Adj \times FatAdj \quad [16.18]$$

$YATP$  represents the theoretical maximal yield of bacteria per unit of ATP derived from available nutrients:

$$YATP = 0.012 + \frac{RYATP}{1 + kRAa/cRAa} \quad [16.19]$$

where  $RYATP$  represents the maximal additional yield of Mi that could be realized with infinitely high concentrations of amino acids and peptides ( $cRAa$ ) and  $kRAa$  represents the apparent affinity constant for rumen amino acids and peptides.

$ATP_G$  represents ATP available for growth after maintenance needs have been met where:

$$ATP_M = Mi/FATP_M \quad [16.20]$$

$FATP_M$  represents the moles of ATP used per kilogram of Mi per day for maintenance where  $FATP_M$  is equal to 20 if  $pH \geq 6.2$ , 40 if  $pH \leq 5.4$ , and  $20 + (20(0.8 - (RpH - 5.4)/0.8))$  if  $5.4 < pH < 6.2$ .

$NH_4Adj$  and  $FatAdj$  represent the adjustment factors associated with rumen ammonia concentrations and the additional fat added to

the diet. The  $NH_4Adj$  function is Michaelis-Menten in nature with a  $V_{max}$  of 1 and ruminal ammonia as a substrate. The  $FatAdj$  function is a linear equation with an intercept of 1 and a slope of 0.3. Therefore, maximal yield of microbes is reduced when ammonia concentrations are low and enhanced when fat is added to the diet.

$U_{MIP}$  represents the outflow of microbes from the pool due to passage from the rumen. Microbial outflow is associated with passage of the soluble and small particle pools and is calculated from liquid and particulate passage rates, respectively.

Rumen amino acid concentrations are estimated using the following equation:

$$\frac{dRAa}{dt} = \frac{U_{Ps,Aa} + U_{Pi,Aa} + U_{SPs,Aa} - U_{Aa,VFA} - U_{Aa,Mi} - U_{Aa,P}}{[16.21]}$$

where  $U_{Ps,Aa}$ ,  $U_{Pi,Aa}$  and  $U_{SPs,Aa}$  represent fluxes into the rumen amino acid (RAa) pool from soluble feed protein degradation, degradation of insoluble feed protein in the small particle pool, and salivary protein degradation, respectively.  $U_{Aa,VFA}$ ,  $U_{Aa,Mi}$  and  $U_{Aa,P}$  represent effluxes from the pool due to degradation of amino acids to volatile fatty acids and ammonia, use for microbial growth, and passage from the rumen in the soluble phase. Insoluble protein degradation is a linear function of protein concentration and microbial concentration in the small particle pool. Added dietary fat inhibits protein degradation. Degradation of amino acids (Aa) to VFA is a function of amino acid concentrations. This equation utilizes saturation kinetic arguments. The maximal rate of degradation is affected by microbial concentration in the soluble pool.

Rumen ammonia concentrations are calculated directly from rates of protein hydrolysis, feed and salivary NPN entry, microbial utilization, and loss from the rumen. Urea entry is calculated from circulating concentrations of urea.

These equations capture the concepts that low pH inhibits microbial growth by increasing the maintenance requirement of the microbes, and high peptide concentrations enhance rates of growth of SC-fermenting microbes.

The updated version of the dynamic,

mechanistic model of digestion and metabolism (MOLLY) that was originally reported by Baldwin *et al.* (1987a,b,c) was published (Baldwin, 1995); descriptions of underlying detailed models of metabolism in adipose tissue, liver, and mammary glands were included. A specific limitation of MOLLY was that amino acids were represented as a single aggregate pool. As a result, dietary limitations of specific amino acids and responses to supplementation with specific amino acids could not be simulated. Recently, modifications were incorporated to form a new version, AAMOLLY. In this version, four amino acid pools are represented: sulphur amino acids (methionine + cystine), lysine, histidine and the other amino acids as an aggregate pool. Any of these can limit the body, visceral or milk protein synthesis. In addition, provisions for computing the stoichiometry of amino acid degradation dynamically based on the current mix of amino acids in circulation was added based on the balance data presented in Table 16.1. An example of the behaviour of the revised model is presented in Fig. 16.1.

The primary advantage of the UC Davis model is the dynamic tracking of the rumen environment, most particularly the microbial pool size. Dynamic solutions of rumen functions provide an explicit means of simulating reductions in digestibility associated with increased DMI, effects of particle size and solubility on protein and carbohydrate availability in the rumen, and effects of diet form and composition on microbial growth and yield. Additionally, they allow utilization of measurements made in non-steady-state conditions and where amino acid supplementation and the utilization of specific amino acids are traced. This provides additional dimensions to previously utilized methods and, thereby, more power in terms of model parameterization.

## Analytical Models of Protein Turnover in Animals and Tissues

### Protein synthesis measurements

Characterization of tissue protein turnover and metabolism must encompass both protein syn-

**Table 16.1.** Stoichiometric balances for amino acid degradation<sup>a</sup>.

Amino acid	Glc <sup>b</sup>	Ac-CoA	NADH <sub>2</sub>	FADH <sub>2</sub>	O <sub>2</sub> UP	ATAD	CO <sub>2</sub>	Urea <sup>c</sup>	Others + notes
Ala	0.5					5	-0.5	0.5	
Arg	0.5		4	1		5	1	2	
Asp	0.5					4	0.5	0.5	
Cys	0.5		-1		1	4	-0.5	0.5	+SO <sub>4</sub>
Glu	0.5		2	1		3	1.5	0.5	
Gly	0.25					3.5		0.5	
His	0.5		2	1		7	0.5	1.5	
Ile	0.5	1	3	2		4	0.5	0.5	
Leu		3	2	1		5	-0.5	0.5	
Lys		2	5	1		4	1	1	
Met	1			1		12		1	-CH <sub>3</sub> <sup>d</sup> , Ser <sup>e</sup> (-1)
Pro	0.5		3	1	0.5	3	1.5	0.5	
Phe	0.5	2			3	6	1.5	0.5	
PT <sup>f</sup>	0.5	2			2.5	6	1.5	0.5	
SAA <sup>g</sup>	0.75		-0.5	0.5	0.5	8.0	-0.25	0.75	-0.5 Ser, +0.5 SO <sub>4</sub>
Ser	0.5		-1			5	-0.5	0.5	
Thr	0.5			1		5	0.5	0.5	via propionyl CoA
Tyr	0.5	2			2	6	1.5	0.5	
Val	0.5		4	2		4	0.5	0.5	

<sup>a</sup>Trp was neglected because amounts are small and degradation is usually incomplete.

<sup>b</sup>Glc, glucose; CoA, coenzyme A; O<sub>2</sub>UP, oxygen uptake; ATAD, total ATP use in animal.

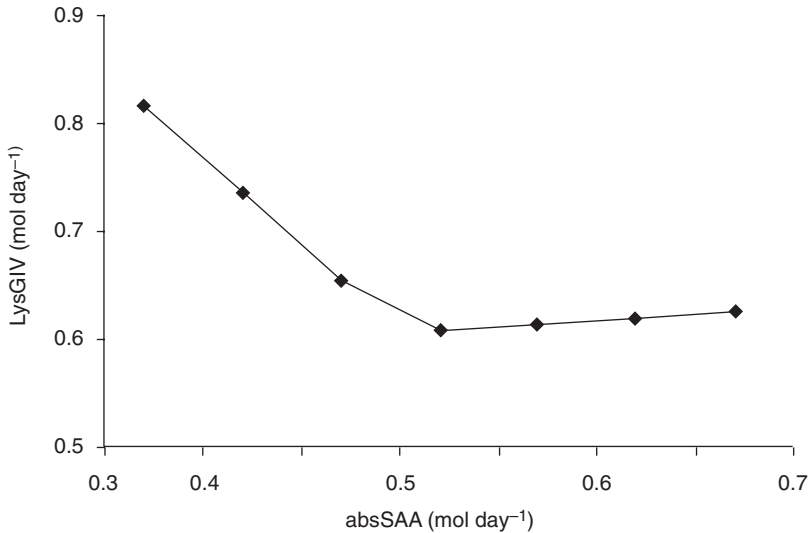
<sup>c</sup>NH<sub>4</sub><sup>+</sup> and NH<sub>3</sub> considered identical.

<sup>d</sup>Methyl acceptor neglected.

<sup>e</sup>Serine input to path is considered, in program, as in average amino acid.

<sup>f</sup>PT, Phe and Tyr (50:50, wt/wt).

<sup>g</sup>SAA, sulphur amino acids.



**Fig. 16.1.** A model simulation of the effect of increasing sulphur amino acid availability (absSAA) on blood lysine concentration (LysGIV). The simulation was conducted using MOLLY, a model of digestion and metabolism in lactating dairy cattle. (Kindly provided by John Cant, University of Guelph, Canada.)

thesis and degradation. Classical techniques for studying protein metabolism use radioisotopes or other markers and various mathematical models to describe the rates of protein synthesis and degradation. However, due to the difficulty in measuring rates of protein degradation, most work has focused on protein synthesis. In the live animal, protein degradation rates are usually inferred from measurements of protein synthesis and accretion. Protein synthesis rate can be defined and expressed as the amount of protein synthesized per unit time or as fractional synthesis rate (FSR), the fraction of total protein synthesized per unit time. Both are measured using precursor-product analysis of the precursor and protein pools of amino acids (Zak *et al.*, 1979) and depend on accurate identification of the precursor and product pool. It is well recognized that neither extracellular (EC) nor intracellular (IC) pools of amino acids are representative of the direct precursor pool of amino acids used for protein synthesis. Rather, amino acids which have been esterified to aminoacyl-tRNA are used to synthesize protein. Unfortunately, this pool is very small relative to total free amino acids in the cytoplasm and has a half-life of 2 s or less (Airhart *et al.*,

1974). Thus, measurement of the specific radioactivity of an amino acid in this pool is both technically difficult and time consuming.

The vast majority of published rates of protein synthesis are based on the assumption that specific radioactivities (SRA) of amino acids in the aminoacyl-tRNA ( $SA_t$ ), the EC ( $SA_e$ ) and the IC ( $SA_i$ ) pools are similar. Only rarely have investigators measured  $SA_t$ , or attempted to quantitate the specific radioactivity differences between amino acid pools used for calculation of protein synthetic rates. However, when such measurements have been made, inconsistent results have been obtained. In some *in vitro* studies,  $SA_t$  has been shown to be intermediate to  $SA_i$  and  $SA_e$ , (Airhart *et al.*, 1974, 1981; McKee *et al.*, 1978; Hammer and Rannels, 1981), whereas in others  $SA_t$  was lower than  $SA_i$  and  $SA_e$  (Airhart *et al.*, 1981; Hildebran *et al.*, 1981; Hall and Yee, 1989; Opsahl and Ehrhart, 1987; Schneible and Young, 1984). The interpretation of such data is difficult. Some data support the view that tRNAs are charged by intracellular (IC) amino acids, some that extracellular (EC) amino acids charge tRNAs, and other data that tRNA is acylated by amino acids from protein degrada-



tion which do not mix with the IC pool. Hod and Hershko (1976) used the time course of label incorporation into protein to describe a model where the precursor of protein synthesis, aminoacyl-tRNA, is charged from both the IC and EC pools of amino acid. Similar models have been proposed by Khairallah and Mortimore (1976) and Khairallah *et al.* (1977). However, there has been no attempt to quantitatively evaluate these models and theories. Additionally, these models do not account for observations when  $SA_t$  is less than either  $SA_i$  or  $SA_e$ .

Measurements of protein synthetic rates *in vivo* are complicated by the fact that specific radioactivities of radiolabelled amino acids generally change during the course of experiments. In the pulse dose method, a tracer dose of radiolabelled amino acid injected intravenously causes a rapid rise in  $SA_e$  and  $SA_i$  to a peak followed by a convex decay with time whereas protein specific radioactivity is a function of the kinetics associated with the change in radiolabel of the amino acid in the precursor pool, the number of proteins in the pool, and the rate of turnover of each of those individual proteins in the total pool of protein. This method has numerous disadvantages, which include the large number of time points and animals required to derive the complex and rapidly changing curves and the complexity of the analytical models needed to interpret the data (Haider and Tarver, 1969; Garlick, 1980).

To reduce the complexity of mathematical models necessary to calculate protein synthesis, techniques were developed which simplified specific radioactivity curves. One such method was the constant infusion of radiolabelled amino acid, as developed by Stephen and Waterlow (1965; Waterlow and Stephen, 1966), wherein the infusion of a tracer amino acid causes the amino acid specific radioactivity in plasma and tissues to reach a plateau. However, the plateau reached in tissues is lower than that in plasma due to the intracellular contribution of amino acids from protein degradation. The use of the constant infusion method requires several assumptions including: (i) that either  $SA_e$  or  $SA_i$  is quantitatively equal to  $SA_t$ , and (ii) that there is no recycling of the labelled amino

acid from the protein pool back to the precursor pool. This method also suffers from the disadvantage that many measurements are required to accurately define the shape of the curve during the rise to plateau. However, if the infusion is long enough, the rise to plateau can be estimated by a single exponential (Garlick, 1978). This method addresses the problem of reutilization by assuming that, at plateau, a steady state exists and  $SA_i$  represents the contribution of proteolysis and extracellular amino acids.

The protein fractional synthetic rate (FSR) in a tissue is calculated as described by Waterlow *et al.* (1978) using the model:

$$S_B/S_f = (\lambda_f/\lambda_t - k_s) ((1 - e^{-k_s t}) / (1 - e^{-\lambda_f t})) - (k_s/\lambda_t - k_s) \quad [16.22]$$

where  $S_B$  is the SRA of the protein-bound amino acid,  $S_f$  is the SRA of the free amino acid pool in the tissue,  $k_s$  is the FSR per day,  $t$  is the period of infusion (days) and  $\lambda_t$  is the rate constant describing the rise to plateau of the SRA of free amino acid in the tissue.

Because  $\lambda_f = Rk_s$  where  $R$  is the concentration ratio, protein-bound amino acid:free amino acid in the tissue and in some tissues,  $\lambda_t = \lambda_p$ , where  $\lambda_p$  is the rate constant in the formula describing the rise to the plateau of amino acid specific radioactivity in plasma (Sp):

$$Sp = Sp_{max} (1 - e^{-\lambda_p t}) \quad [16.23]$$

where  $Sp_{max}$  is the plasma amino acid plateau specific radioactivity and  $t$  is the period of infusion (d).

Although this is the case in perfused liver and lung (Khairallah and Mortimore, 1976; Watkins and Rannels, 1980; Kelley *et al.*, 1984), the relationship between  $SA_e$ ,  $SA_i$  and  $SA_t$  *in vivo* have not been reported.

The flooding or loading dose method seeks to circumvent the need to measure aminoacyl-tRNA by decreasing the differences in specific radioactivities among amino acid pools. First used by Henshaw *et al.* (1971), this method combines a large dose of labelled and unlabelled amino acid (McNurlan *et al.*, 1979; Garlick, 1980). The flooding dose is used to expand the intracellular pool of tracer amino acid such that  $SA_i$  becomes equivalent to  $SA_e$  (Garlick *et al.*, 1980), supposedly forcing  $SA_t$  to be equivalent to  $SA_e$  and  $SA_i$ .

Using the flooding dose method protein fractional synthesis rate ( $k_s$ ) is calculated as:

$$k_s = S_B/S_f t \quad [16.24]$$

where  $S_B$  is the specific radioactivity of the amino acid in protein,  $S_f$  is the specific radioactivity of the amino acid in the precursor of amino acids used for protein synthesis, and  $t$  is expressed as days (McNurlan *et al.*, 1979). This assumes  $S_f$  does not change over time. If, however,  $S_f$  changes over time  $k_s$  is calculated using  $S_f$  which represents the average  $S_f$  over time during which incorporation occurred (Bernier and Calvert, 1987).

However,  $SA_i$  is not necessarily similar to  $SA_e$  or  $SA_i$  even when a flooding dose is given. Airhart *et al.* (1981) examined the effect of extracellular amino acid concentration on  $SA_i$  and  $SA_e$  in chick skeletal muscle cells *in vitro*. They found that a flooding concentration (5.0 mM) of radiolabelled leucine forced  $SA_e$  and  $SA_i$  to equality, while cells in a physiologically normal extracellular concentration (0.2 mM) of leucine had a  $SA_i$  that was 41.4% of  $SA_e$ .  $SA_i$  was less than half  $SA_e$  at both 0.2 and 5.0 mM extracellular leucine. They concluded that expansion of cellular amino acid pools was not successful in flooding the aminoacyl-tRNA pool with radioactive amino acid, and proposed that this failure was due to direct charging of tRNA with amino acids arising from protein degradation without mixing with a common intracellular pool. Similarly, Schneible and Young (1984) found that they could not force leucyl-tRNA specific radioactivities to a level equal to either  $SA_e$  or  $SA_i$  in cultured chick muscle cells. They concurred with Airhart *et al.* (1981) that accurate quantitation of protein synthesis required measurement of  $SA_i$ . Barnes (1990) reached the same conclusion using the flooding dose method with growing chicks. He reported that failure to consider  $SA_i$  resulted in underestimation of FSR by 3.9-, 1.7-, 1.3- and 2.25-fold in the gastrointestinal tract, liver, pectoralis muscle and thigh muscle, respectively.

To examine the possibility that tRNA is directly charged by amino acids resulting from protein degradation prior to the mixing of these amino acids with the general IC pool, Barnes *et al.* (1992) prelabelled chicken HD11 macrophage proteins with [ $^3$ H]leucine. After removal of [ $^3$ H]leucine, the cells were

washed and incubated in media with either 0.23 mM or 2.3 mM cold leucine.  $SA_e$  was constant for the first 30 min and increased 58% and 32% for the 0.23 mM and 2.3 mM levels of leucine, respectively, during the second 30 min.  $SA_i$  did not change with time for the tracer level of leucine; however, for the flooding dose,  $SA_i$  decreased 40% during the course of the experiment.  $SA_i$  was not affected by increasing extracellular leucine concentration and remained well above  $SA_i$  or  $SA_e$ . However, when HD11 cells which had not been prelabelled were incubated with either a tracer or flooding dose of [ $^3$ H]leucine,  $SA_e$  and  $SA_i$  were higher compared to  $SA_i$ . These data strongly implicate tRNA charging with amino acids released from protein degradation.

In light of the previous discussion, the limitations of protein synthesis measurements obtained from  $SA_e$  or  $SA_i$  must be resolved if truly quantitative rates of protein synthesis are to be obtained. It is documented from direct measurements that tracer amino acid specific radioactivities in extracellular, intracellular and tRNA pools can be very dissimilar. Previously discussed data strongly suggest that neither the IC nor EC pools are the sole source of amino acids used to charge the tRNA pool. Thus, protein synthesis rates calculated from either  $SA_e$  or  $SA_i$  will not provide an accurate estimate of synthesis rate.

### Cellular metabolism

Evidence strongly suggests that amino acids are channelled either from extracellular sources or from protein degradation directly to protein synthetic machinery without mixing with intracellular amino acids and being exposed to enzymes involved in amino acid oxidation. Thus, the extent of amino acid channelling may be a critical determinant of the fate (oxidation versus protein synthesis) of amino acids arriving from the digestive tract and those arriving from the turnover of existing proteins.

### Amino acid channelling

The organization of multienzyme complexes can result in compartmentalization or channelling of specific metabolites from one

enzyme to another without equilibration with other pools of that metabolite. Channelling of metabolites is important for many metabolic pathways, including fatty acid synthesis, glycolysis and the urea cycle (Srere, 1987; Watford, 1989; Srere and Ovadi, 1990). Channelling has the potential of increasing the efficiency of a metabolic pathway by limiting loss of substrate. Additionally, the transport of substrates across cell membranes often depends on the coupling of an enzyme of that metabolite's utilization to the transport protein. Consequently, the channelling of substrates through complex metabolic pathways often begins at the cell membrane. One prerequisite for channelling is the existence of a structural organization for the components of the pathway that can lead to the catalysis of sequential reactions without the dissociation of intermediates. A second prerequisite for channelling is the demonstration of distinct pools of substrate and intermediates that do not freely mix with the respective general intracellular pools. Evidence supporting these two prerequisites implicates the channelling of amino acids arising from proteolysis towards protein synthesis.

The structural organization that implicates the channelling of aminoacyl-tRNA to protein synthesis is well documented. Aminoacyl-tRNA synthetases are enzymes that activate amino acids and esterify them to tRNAs. Many of the aminoacyl-tRNA synthetases exist in a multienzyme complex. Presently, ten of the 21 synthetase activities have been isolated from the multienzyme complex (isoleucine, leucine, lysine, methionine, arginine, proline, phenylalanine, glutamine, glutamate, aspartate) and it is suspected that additional enzymes are lost in the purification procedure (Schimmel, 1987; Yang and Jacobo-Molina, 1990). The enzyme complex has been identified in many cell lines as well as myoblasts (Shi *et al.*, 1991). The synthetase complex is physically associated with elongation factor eEF1 (Sarisky and Yang, 1991), one of the primary regulators of rate of protein translation. Several of the enzymes in this multienzyme complex have amino terminal hydrophobic regions that associate with lipids, presumably in one of the cell membranes (Huang and Deutscher, 1991). With

gentle homogenization of chick embryos, aminoacyl-tRNA synthetases purify in the microsomal fraction. Although it has not been shown which membrane the complex is associated with, the linkage between tRNA charging enzymes and amino acid transport across membranes is implicated. Quay *et al.* (1975) have shown that the transport of leucine is linked to and regulated by leucyl-tRNA synthetase activity.

Distinct substrate pools have also been identified. Sivaram and Deutscher (1990) provided evidence for two pools of arginyl-tRNA, one which is free in the cytosol and is involved in the post-translational modification of proteins, and a second which is a component of the aminoacyl-tRNA synthetase complex. Further, neither free arginyl-tRNA nor free phenylalanyl-tRNA are used for ribosomal protein synthesis, but the tRNAs formed in the multienzyme complex are efficiently used (Negrutskii and Deutscher, 1991). This suggests that aminoacyl-tRNAs formed in the multienzyme complex are transferred directly from the synthetase to the elongation factor and the ribosome without mixing with the total fluid of the cell, representing the channelling of aminoacyl-tRNA for protein synthesis.

As previously described, distinct substrate pools of free amino acids are apparently used for the charging of tRNA. This pool is separate from the total intracellular pool of free amino acids. The extent and time course of dilution of the specific activity of the radio-tracer by unlabelled free amino acids in the cell or from proteolysis, as reflected in aminoacyl-tRNA, indicates the source of amino acids used for protein synthesis. Further work is needed to determine the extent of this amino acid partitioning and the method of its regulation.

Putative charging of tRNA from amino acids channelled directly from protein degradation is understandable both energetically and nutritionally. By directly reutilizing a significant proportion of the amino acids released from protein degradation, the cell can prevent the efflux of essential amino acids from the cell and minimize their loss to catabolic pathways. Efficient reutilization of amino acids could result in decreased energy requirements associated with their transport into the cell. Additionally,

efficient channelling of amino acids arising from the diet or other tissues across the cell membrane directly to the aminoacyl-tRNA synthetases would preclude the possibility of loss of the amino acid to oxidation.

### Amino acid recycling

Since it appears likely that amino acids are preferentially channelled from protein degradation to the immediate precursor pool for protein synthesis, the assumption that there is no recycling of the tracer amino acid, which is required if one uses the precursor-product relationship to quantitate protein synthesis from a radiolabelled amino acid, is not true. The fact that, as a part of cellular metabolism, amino acids are recycled through the precursor pool and back to protein impacts on the determined rate of protein synthesis. If one considers rate of protein synthesis in a whole body, it must be recognized that the body pool of proteins consists of a multitude of protein pools with half-lives ranging from minutes to weeks or months. For proteins with relatively short half-lives, the issue of recycling is very important and can impact on estimates of protein synthesis rates. The more rapidly a protein turns over the more rapidly the specific radioactivity of the amino acid in the protein approaches equality with the specific radioactivity of the precursor pool. Thus, specific radioactivity of the tracer amino acid released from the fast turnover protein approaches equality with that of the precursor pool. As the specific radioactivity of the amino acid in the protein approaches the specific radioactivity of the precursor pool, it becomes impossible to measure incorporation of label into that protein (as an increase in protein radioactivity). Thus, over time, measured rates of protein synthesis decrease. The longer the time period allowed for incorporation of labelled amino acids into the protein pool, the lower the estimate of protein synthesis rate. Short-time incorporation experiments bias the results towards fast turnover times with rapidly turning over proteins exerting a significant influence on the result. On the other hand, longer incorporation times bias the results toward proteins with slower

turnover rates since specific radioactivity of the amino acids in the fast turnover proteins comes into equality with the precursor pool amino acid specific radioactivity such that no measurable incorporation is now taking place. Using the data of Bernier and Calvert (1987), it can be demonstrated that the protein FSR calculated at 30 min postinjection of a flooding dose of [ $1\text{-}^{14}\text{C}$ ]leucine is 33.6% that calculated at 2 min postinjection.

### Conclusions

Obviously, if one is to obtain data which truly reflect rate of protein synthesis in any given system, accurate and precise measures of precursor specific radioactivities are essential. The relationships among the extracellular, intracellular and tRNA pools must be described in greater detail. The complexity of amino acid pools and relationships among them precludes the interpretation of tracer data using simple empirical and static models. In order to adequately describe and analyse amino acid tracer data, dynamic (time-variant) and mechanistic (causal, theoretical) models must be developed. Such models must represent the dynamic relationships among EC, IC, tRNA and protein-bound amino acids, as well as the formation of catabolic intermediates.

In order to accommodate the several confounding factors discussed above, a generally applicable analytical model of protein synthesis must incorporate each of the entities and transactions depicted in Fig. 16.1. The number of measurements required to solve such a complex model would include: extracellular amino acid specific radioactivity; intracellular amino acid specific radioactivity; aminoacyl-tRNA amino acid specific radioactivity; specific radioactivity of the amino acid in the protein pool; fluxes of amino acid from the intracellular pool to the aminoacyl-tRNA pool to protein and from protein to the intracellular aminoacyl-tRNA pool; and size of protein pool, aminoacyl-tRNA pool and intracellular amino acid pool. Such measurements may be prohibitively expensive. However, until results from such an experiment are available estimates of protein synthesis and degradation based on simpler data sets and analytical models must be inter-

preted with great care. Further, these measurements must be made at varying concentrations of extracellular amino acids.

### **Models of Amino Acid Metabolism in Intact Animals**

Three methods have commonly been used to estimate fractional synthetic rate (FSR) by measuring the incorporation of radiolabelled amino acids into protein relative to the specific radioactivity in the precursor pool (flooding dose, pulse dose, and continuous infusion). While numerous assumptions must be accepted to calculate FSR using any of the three methods identified, three of the assumptions are known to impact, and compromise, the accuracy of the estimated FSR. Specifically the assumptions that the free amino acid pool is homogeneous, that the protein pool is homogenous, and that there is no recycling of amino acids from the precursor to protein back to precursor pool of free amino acids are all well recognized as assumptions that are not correct, but made to simplify the estimation of FSR from tracer data.

As previously discussed, in the intact animal, free amino acid pools include plasma, extracellular, intracellular and aminoacyl-tRNAs. Clearly, there is not one homogenous pool of amino acids in the animal. In addition, it is likely that the intracellular pool of amino acids is not a homogeneous pool. There is considerable evidence that the specific radioactivities of an amino acid vary between the free amino acid pools and that the differences between pools are impacted by physiological state. Thus, no simple algorithm can be applied to convert the measured specific radioactivity of, for example, the extracellular pool, into the estimated specific radioactivity of the aminoacyl-tRNA pool, the amino acid pool that more truly represents the pool of amino acids used for protein synthesis compared to the other identified amino acid pools. In attempting to correct for this deficiency, the loading dose method has been used to 'force' the specific radioactivities if the various free amino acid pools are not to be as diver-

gent. Still, research has shown that, depending on the tissue and the physiological state of the animal, the specific radioactivity of the aminoacyl-tRNA may be in between that of the extracellular pool and the intracellular pool, or may be lower relative to both of those pools. Given that the specific radioactivity of the precursor pool is used to calculate FSR, it is necessary for improved accuracy to 'know' the specific radioactivity of the true precursor pool for protein synthesis, at present assumed to be aminoacyl-tRNA. This can be accomplished in one of two ways. First, one can actually measure the specific radioactivity of the aminoacyl-tRNA. However, it may also be possible to develop a more mechanistic understanding of the relationships between the various free amino acid pools and the effects of physiological state upon charging tRNA with amino acids. Although the former should provide the most accurate specific radioactivity of the aminoacyl-tRNA, determination of specific radioactivity of tRNA is a laborious procedure fraught with its own difficulties and necessary assumptions. On the other hand, it may be possible to develop a more mechanistic understanding of the relationships that exist between the various amino acid pools and describe those relationships in quantitative terms so that it is possible to predict more accurately the specific radioactivity pool of the amino acylated-tRNA.

It is also recognized that the body is not one homogenous pool of protein. Rather, there are multiples of protein pools in the body, each with their own FSR and turnover rate. Thus, it must be recognized that, unless one is dealing with a specific identified protein, the estimated FSR is the result of the 'average' of FSR from multiple pools of proteins, each with their own characteristic FSR. Whereas the impact of the simplifying assumption of one homogenous protein pool is fairly easy to understand at this level, there is another more significant impact when the assumption of a single homogenous protein pool is considered in conjunction with the assumption that there is no recycling of amino acids from the protein pool back to the precursor pool. Recycling of amino acids

from protein to the precursor, or free amino acid pool(s) does occur as a consequence of protein turnover. Thus, with increasing time of radiolabelled amino acid incorporation, there is an increase in the amount of that amino acid that is recycled, through protein degradation, to the supposed precursor pool. The consequence is that as one calculates FSR during time allowed for incorporation, it is noticed that FSR changes with time. The only solution would be to calculate FSR at time zero when the radiolabelled amino acid is injected into the system. Of course, that is an impossible measurement as there would be no specific radioactivity in the protein pool. To overcome the problems associated with recycling, some have elected to allow incorporation of the radiolabelled amino acid for short periods. This tends to bias the resulting estimated FSR towards the more rapid turnover tissue, as it has relatively rapid uptake of the radiolabelled amino acid compared to that of slower turnover tissue. Here again, it seems that the most reasonable approach to improve accuracy is to account more adequately for the changes in precursor and product specific radioactivities over time, as influenced by recycling of the radiolabelled amino acid. In that regard, there is the additional issue as to which amino acid pool the amino acids arising from protein degradation are directed. There is evidence that amino acids arising from protein degradation can be preferentially channelled directly back to tRNA without entering the general cellular pool of amino acids (Barnes *et al.*, 1994). Thus, both the issue of amino acid recycling and amino acid channelling must be explicitly included in the estimation of FSR if accuracy is to improve. As with the problems associated with the precursor pools previously discussed, both recycling and channelling must be quantitatively described. Given that the changes in the system occur over time, not only must the quantitative methods for estimating FSR include the mechanistic descriptions of how protein synthesis occurs, but the estimation methods must be dynamic as well. The conclusion is that the relatively empirical models

used to estimate protein synthesis or FSR are inadequate to the task.

In an effort to improve the quantitative methodology available to estimate FSR, Johnson *et al.* (1999a) developed a dynamic mechanistic model of protein turnover in the non-growing mouse. The model consisted of three amino acid pools (extracellular, intracellular and aminoacyl-tRNA), three protein pools (fast, medium and slow turnover), and had three amino acid sources that could charge tRNA (extracellular amino acids, intracellular amino acids, and amino acids resulting from protein degradation). Three methods (flooding dose, pulse dose and continuous infusion) of introducing radiolabelled amino acid into the model were used to estimate FSR. Predications of specific radioactivities using flooding dose, continuous infusion or pulse dose indicated that the model would be useful in estimating rates of channelling and recycling. Interestingly, the model indicated that the use of data obtained from flooding dose injections might cause inaccurate predictions of some fluxes. In a companion paper (Johnson *et al.*, 1999b) the model predicted that time was critical to the estimated FSR. For example, using the pulse-dose method, FSR was underestimated by 40–50% at 5 min and underestimated by 9–10% at 60 min.

The value of a mechanistic model is that it can be a useful tool in experimental design. Johnson *et al.* (2000) used the previously discussed rodent model of protein turnover to design experiments to examine channelling, recycling and FSR. The model indicated that the pulse dose is the experimental design that yields the best estimates of channelling, recycling and FSR. The model suggested that changes in amino acid specific radioactivities in extracellular, aminoacyl tRNA and protein pools were greatest at 2, 6, 10, 40, 70 and 100 min. The model has also been used to perform simulations (Johnson *et al.*, 2001). In that effort, it was clear that identification and separation of the source specific radioactivity is required in order to estimate FSR accurately.

## References

- Airhart, J., Vidrich, A. and Khairallah, E.A. (1974) Compartmentation of free amino acids for protein synthesis. *Biochemical Journal* 140, 539–545.
- Airhart, J., Arnold, J.A., Bulman, C.A. and Low, R.B. (1981) Protein synthesis in pulmonary alveolar macrophages. *Biochimica Biophysica Acta* 653, 108–117.
- Baldwin, R.L. (1995) *Modeling Ruminant Digestion and Metabolism*. Chapman and Hall, London, UK.
- Baldwin, R.L., France, J. and Gill, M. (1987a) Metabolism of the lactating cow. I. Animal elements of a mechanistic model. *Journal of Dairy Research* 54, 77–106.
- Baldwin, R.L., Thornley, J.H.M. and Beever, D.E. (1987b) Metabolism of the lactating cow. II. Digestive elements of a mechanistic model. *Journal of Dairy Research* 54, 107–131.
- Baldwin, R.L., France, J., Beever, D.E., Gill, M. and Thornley, J.H.M. (1987c) Metabolism of the lactating cow. III. Properties of mechanistic models suitable for evaluation of energetic relationships and factors involved in the partition of nutrients. *Journal of Dairy Research* 54, 133–145.
- Barnes, D.M. (1990) Determination of aminoacyl-tRNA specific activity for the measurement of protein synthesis *in vivo* and *in vitro*. PhD dissertation, University of California, Davis.
- Barnes, D.M., Calvert, C.C. and Klasing, K.C. (1992) Source of amino acids for tRNA acylation, implications for measurement of protein synthesis. *Biochemical Journal* 283, 583–589.
- Barnes, D.M., Calvert, C.C. and Klasing, K.C. (1994) Source of amino acids for tRNA acylation in growing chicks. *Amino Acids* 7, 267–278.
- Bernier, J.F. and Calvert, C.C. (1987) Effect of a major gene for growth on protein synthesis in mice. *Journal of Animal Science* 65, 982–995.
- Garlick, P.J. (1978) An analysis of errors in estimation of the rate of protein synthesis by constant infusion of labeled amino acids. *Biochemical Journal* 176, 402–405.
- Garlick, P.J. (1980) Protein turnover in the whole animal and specific tissues. In: Florin, M., Neuberger, A. and Van Deena, L.L.H. (eds) *Comprehensive Biochemistry*, Vol. 19B. Elsevier, London, pp. 77–152.
- Garlick, P.J., McNurlan, M.A. and Preedy, V.R. (1980) A rapid and convenient technique for measuring the rate of protein synthesis in tissues by injection of [<sup>3</sup>H]phenylalanine. *Biochemical Journal* 192, 719–723.
- Haider, M. and Tarver, H. (1969) Effect of diet on protein synthesis and nucleic acid levels in rat liver. *Journal of Nutrition* 99, 433–445.
- Hall, G.E., and Yee, J.A. (1989) Pamthyroid hormone alteration of free and tRNA-bound proline specific activities in cultured mouse osteoblast-like cells. *Biochemical and Biophysical Research Communications* 161, 994–1000.
- Hammer, J.A. and Rannels, D.E. (1981) Protein turnover in pulmonary macrophages. *Biochemistry Journal* 198, 53–65.
- Henshaw, E.C., Hirclic, C.A., Morton, B.E. and Hiatt, H.H. (1971) Control of protein synthesis in mammalian tissues through changes in ribosome activity. *Journal of Biological Chemistry* 246, 435–446.
- Hildebran, J.N., Airhart, J., Stirewalt, W.S. and Low, R.B. (1981) Prolyl-tRNA-based rates of protein and collagen synthesis in human lung fibroblasts. *Biochemical Journal* 198, 249–258.
- Hod, Y. and Hershko, A. (1976) Relationship of the pool of intracellular valine to protein synthesis and degradation in cultured cells. *Journal of Biological Chemistry* 251, 4458–4467.
- Huang, S. and Deutscher, M.P. (1991) The NH<sub>2</sub>-terminal extension of rat liver arginyl-tRNA synthetase is responsible for its hydrophobic properties. *Biochemical and Biophysical Research Communications* 180, 702–708.
- Johnson, H. A., Baldwin, R.L., France, J. and Calvert, C.C. (1999a) A model of whole-body protein turnover based on leucine kinetics in rodents. *Journal of Nutrition* 129, 728–739.
- Johnson, H. A., Baldwin, R.L., France, J. and Calvert, C.C. (1999b) Recycling, channeling and heterogeneous protein turnover estimation using a model of whole-body protein turnover based on leucine kinetics in rodents. *Journal of Nutrition* 129, 740–750.
- Johnson, H. A., Baldwin, R.L., Klasing, K.C., France, J. and Calvert, C.C. (2000) A Rodent model of protein turnover used to design an experiment for measuring the rates of channeling, recycling and protein synthesis. *Journal of Nutrition* 130, 3097–3102.
- Johnson, H. A., Baldwin, R.L., Klasing, K.C. and Calvert, C.C. (2001) Impact of separating amino acids between plasma, extracellular and intracellular compartments on estimating protein synthesis in rodents. *Amino Acids* 20, 389–400.
- Kelley, J., Stirewalt, W.S. and Chrin, L. (1984) Protein synthesis in fat lung. *Biochemical Journal* 222, 77–83.

- Khairallah, E.A. and Mortimore, G.E. (1976) Assessment of protein turnover in perfused rat liver. *Journal of Biological Chemistry* 251, 1375–1384.
- Khairallah, E.A., Airhart, J., Bruno, M.K., Puchalsky, K. and Khairallah, L. (1977) Implications of amino acid compartmentation for the determination of rates of protein catabolism in livers of meal fed rats. *Acta Biologica et Medica Germanica* 36, 1735–1745.
- McKee, E.E., Cheung, J.Y., Rannels, D.E. and Morgan, H.E. (1978) Measurement of the rate of protein synthesis and compartmentation of heart phenylalanine. *Journal of Biological Chemistry* 253, 1030–1040.
- McNurlan, M.A., Tompkins, A.M. and Garlick, P.J. (1979) The effect of starvation on the rate of protein synthesis in rat liver and small intestine. *Biochemical Journal* 178, 373–379.
- Negrutskii, B.S. and Deutscher, M.P. (1991) Channeling of aminoacyl-tRNA for protein synthesis *in vivo*. *Proceedings of the National Academy of Sciences USA* 88, 4991–4995.
- NRC (National Research Council) (1989) *Nutrient Requirements of Dairy Cattle*, 6th edn. National Academy Press, Washington, DC.
- NRC (National Research Council) (2001) *Nutrient Requirements of Dairy Cattle*, 7th rev. edn. National Academy Press, Washington, DC.
- Opsahl, W.P. and Ehrhart, L.A. (1987) Compartmentalization of prolific pools and apparent rates of collagen and non-collagen protein synthesis in arterial smooth muscle cells in culture. *Biochemical Journal* 243, 137–144.
- Payne, J.M., Rowlands, G.J., Manston, R., Dew, S.M and Parker, W.H. (1974) A statistical appraisal of the results of 191 herds in the B.V.A./A.D.S.A. joint exercise in animal health and production. *British Veterinary Journal* 130, 34–43.
- Quay, S.C., Kline, E.L. and Oxender, D.L. (1975) Role of leucyl-tRNA synthetase in regulation of branched-chain amino-acid transport. *Proceedings of the National Academy of Sciences USA* 72 (10), 3921–3924.
- Robinson, P.H. (1996) Rumen protected amino acids for dairy cattle: what is the future? *Animal Feed Science and Technology* 59, 81–86.
- Robinson, P.H., Chalupa, W., Sniffen, C.J., Julien, W.E., Sato, H., Fujieda, T., Watanabe, K. and Suzuki, H. (1999) Influence of post-ruminal supplementation of methionine and lysine, isoleucine, or all three amino acids on intake and chewing behavior, ruminal fermentation, and milk and milk component production. *Journal of Animal Science* 77, 2781–2792.
- Sarisky, V. and Yang, D.C.H. (1991) Co-purification of the aminoacyl-tRNA synthetase complex with the elongation factor eEF1. *Biochemical and Biophysical Research Communications* 177, 757–763.
- Schimmel, P. (1987) Aminoacyl tRNA synthetases: general scheme of structure-function relationships in the polypeptides; and recognition of transfer RNAs. *Annual Review of Biochemistry* 56, 125–158.
- Schneible, P.A. and Young, R.B. (1984) Leucine pools in normal and dystrophic chicken skeletal muscle cells in culture. *Journal of Biological Chemistry* 259 (3), 1436–1440.
- Search: Agriculture (1990) *Number 34*. Cornell University Agriculture Experiment Station, Ithaca, New York, pp. 1–128.
- Shi, M.H., Tsui, F.W.L. and Rubin, L.A. (1991) Cellular localization of the target structures recognized by the anti-jo-1 antibody-immunofluorescence studies on cultured human myoblasts. *Journal of Rheumatology* 18, 252–258.
- Sivaram, P. and Deutscher, M.P. (1990) Existence of two forms of rat arginyl-tRNA synthetase suggests channeling of aminoacyl-tRNA for protein synthesis. *Proceedings of the National Academy of Sciences USA* 87, 3665–3669.
- Srere, P.A. (1987) Complexes of sequential metabolic enzymes. *Annual Review of Biochemistry* 56, 89–124.
- Srere, P.A. and Ovadi, J. (1990) Enzyme-enzyme interactions and their metabolic role. *FEBS Letters* 268, 360–364.
- Stephen, J.M.L. and Waterlow, J.C. (1965) Protein turnover in the rat measured with <sup>14</sup>C-lysine. *Journal of Physiology (London)* 178, 40–41.
- Vanhatalo, A., Huhtanen, P., Toivonen, V. and Varvikko, T. (1999) Response of dairy cows fed grass silage diets to abomasal infusions of histidine alone or in combinations with methionine and lysine. *Journal of Dairy Science* 82, 2674–2685.
- Waterlow, J.C. and Stephen, M.L. (1966) Adaptation of the rat to a low-protein diet: the effect of a reduced protein intake on the pattern of incorporation of <sup>14</sup>C-lysine. *British Journal of Nutrition* 20, 461–471.



- Waterlow, J.C., Garlick, P.J. and Millward, D.J. (1978) *Protein Turnover in Mammalian Tissue and in the Whole Body*. Elsevier, North Holland, Amsterdam.
- Watford, M. (1989) Channeling in the urea cycle: a metabolon spanning two compartments. *Trends in Biochemical Sciences* 14(8), 313–314.
- Watkins, C.A. and Rannels, D.E. (1980) Measurement of protein synthesis in the rat lung perfused *in situ*. *Biochemical Journal* 188, 269–278.
- Yang, D.C.H. and Jacobo-Molina, A. (1990) Organization of mammalian protein biosynthetic machinery revealed from the amino acyl-tRNA synthetase complex. In: Srere, P.A., Jones, M.E. and Mathews, C.K. (eds) *Structural and Organizational Aspects of Metabolic Regulation*. Alan R. Liss, New York, pp. 199–214.
- Zak, R., Martin, A.F. and Blough, R. (1979) Assessment of protein turnover by use of radioisotopic tracers. *Physiological Reviews* 59, 407–447.

# 17 Amino Acid Utilization for Wool Production

**Shimin M. Liu\* and David G. Masters**

*CSIRO Livestock Industries, Wembley, Western Australia, Australia*

---

## **Introduction**

Wool is almost entirely composed of protein with very high levels of cysteine (Cys) and serine (Ser) compared with other body tissues. Growth of wool requires more protein relative to energy, and draws amino acids, in particular methionine (Met) and Cys, disproportionately from the body pool. This creates a relative imbalance of amino acids available for synthesis of other body tissues. On the other hand, the exogenous supply of amino acids from the diet and microorganisms in the rumen do not usually provide sufficient Met and Cys to support maximum wool growth rates. A combination of these factors results in a lower utilization efficiency of amino acids for wool growth compared with the efficiencies for body-mass growth and reproduction (AFRC Technical Committee on Responses to Nutrients, 1993). This chapter reviews the utilization efficiency of dietary protein and amino acids for wool growth and describes the partitioning of amino acids to the skin and wool. Specific attention is given to Met catabolism, its relations to wool growth, and the effects of supplementation on wool growth and protein metabolism in general. Some possibilities to improve the utilization efficiency of amino acids are also discussed.

## **Characteristics of the Wool Follicle and Protein and Amino Acid Concentrations in Wool Protein**

Wool fibre is produced from follicles embedded 500–600  $\mu\text{m}$  below the skin surface. The follicular tissue in the skin of Merino sheep amounts to about 50 g, or 0.1% of live weight (Williams, 1995). The follicle has three regions: the bulb is the end most deeply embedded in the dermis and is where cell proliferation occurs; cells migrate into the keratogenous zone where protein synthesis occurs and cell volume increases 10- to 20-fold. Further up, the cell reaches the zone of hardening where the hard disulphide linkages of the keratin are formed. Some cells from the bulb differentiate into the inner or outer root sheath (Black, 1988). The turnover time of the bulb (total number of bulb cells/new germinated cells per hour) ranges from 19 to 42 h (Wilson and Short, 1979). The inverse of turnover time (i.e.  $0.024\text{--}0.053\text{ h}^{-1}$ , or  $0.57\text{--}1.26\text{ day}^{-1}$ ) is the turnover rate of the bulb (in terms of a proportion of new germinated cells to the total number of the bulb). This value indicates that the follicle has one of the highest turnover rates of all the tissues in the body.

The wool fibre is primarily protein with as little as 0.5% lipids and minerals (Williams,

\*E-mail address: Shimin.Liu@csiro.au

1995). Wool protein is grouped into three main types: the low sulphur proteins making up about 60–70% of total protein, the high-sulphur proteins that account for up to 20–40% of total protein and contain very high levels of Cys but no Met, and the high-tyrosine (Tyr) proteins that make up about 1–12% of the total protein and are characterized by high levels of Tyr and no Met, lysine (Lys), isoleucine (Ile), histidine (His) or glutamate (Glu) (Table 17.1; Reis, 1979). The keratin wool protein is synthesized just above the bulb, then assembled into microfibrils and matrix, and finally hardened by formation of disulphide bonds within and between protein chains (Williams, 1995).

Cys accounts for about 10% (8.6–13.1%) of the amino acids in wool protein (Reis, 1979) compared with 1.3% in the whole body (MacRae *et al.*, 1993) (Table 17.1). The concentration of Met in wool is low, about half that in the whole body. Met is contained in the filament proteins, but not in the matrix protein. Ser concentrations are also high in wool protein, approximately double that in the whole body. The function of Ser in the fibre is not clear. Possibly, the hydroxyl group of Ser forms hydrogen bonds that help to consolidate the fibre structure.

### Efficiency of Dietary Protein Use for Wool Growth

The efficiency of utilization of dietary protein for ruminant livestock can be quantified using factorial analysis (Agricultural Research Council, 1984). The net efficiency for wool production is defined as the ratio of wool protein increment to the absorbed amino acids partitioned to wool growth. Absorbed amino acids for wool growth are calculated by subtracting the maintenance and weight gain requirement from the total absorption in non-reproductive animals (Standing Committee on Agriculture, 1990). Alternatively, the gross efficiency, defined as wool protein over the total absorbed amino acids, may be used.

The gross efficiency of dietary protein for wool growth is very low. Hogan *et al.* (1979) calculated an efficiency of 0.10–0.15 from a few experiments with adult Merino sheep. As

a result, 0.13 is accepted as the average gross efficiency for wool growth (Standing Committee on Agriculture, 1990). Considering clean wool contains about 11% moisture (Adams *et al.*, 2000), the efficiency for the wool protein ranges from 0.09–0.13, a value confirmed by an experimental estimate of 0.12 in mature Merinos (Mata and Masters, 1999).

The net efficiency of dietary protein for wool growth in Merino sheep has been estimated to be 0.20–0.25 (Standing Committee on Agriculture, 1990), substantially lower than the efficiencies of 0.59, 0.85 and 0.68 for weight gain, pregnancy and lactation (AFRC Technical Committee on Responses to Nutrients, 1993). Where the net efficiency has been measured, an increase in wool growth is usually coupled with a gain in body weight (Black *et al.*, 1973; Masters *et al.*, 1998; Mata *et al.*, 1999). During weight loss, body protein could be partially used for wool growth, so both the net and gross efficiencies will be high as wool growth continues at the expense of body protein.

Protein efficiency for fibre production varies substantially between fibre producing species such as sheep, goats and rabbits (Table 17.2). There are major differences in fibre yield relative to body weight. Merino sheep grow 6–13 g day<sup>-1</sup> clean wool and the annual wool production is 0.06–0.08 of live weight (40–65 kg, Hogan *et al.*, 1979). Fibre growth rate in Angora goats is 15–18 g day<sup>-1</sup> and the annual yield is about 0.18 of live weight (about 33 kg, Sahlu *et al.*, 1999). The total wool production of Angora rabbits per annum varies between 1.2 and 1.4 kg or about 0.3–0.4 of live weight of 3.5–4 kg (Liu *et al.*, 1992). The metabolic and regulatory mechanisms which determine such significant differences in capacity of the skin to grow wool fibre between species have not been defined.

### Efficiency of Individual Amino Acids for Wool Growth

As with protein, utilization efficiency of individual amino acids for wool growth is defined as amino acids incorporated into wool, with or without weight gain-related amino acid

**Table 17.1.** Amino acid concentrations (g kg<sup>-1</sup> protein) of microbial protein in the rumen, the whole-body of sheep (excluding wool) and wool protein.

	Microbial protein <sup>(a,b)</sup>	Whole-body protein <sup>(c)</sup>	Wool protein <sup>(c,d)</sup>			
			Whole wool	Low-sulphur proteins	High-sulphur proteins	High-tyrosine proteins
His	16–21	24	8–13	6	7–13	0
Ile	54–62	36	27–32	38	17–26	0
Leu	74–83	73	67–79	102	14–34	35–64
Lys	81–115	67	27–35	41	6–9	0
Met	16–25	18	4.4–6.3	6	0	0
Phe	49–57	39	25–36	20	5–16	27–96
Thr	52–66	49	54–66	48	102–111	0–34
Val	53–65	43	46–57	64	43–53	0–47
Ala	34–62	80	32–52	77	20–29	0–31
Arg	46–53	73	62–91	78	62–69	35–47
Asp	112–129	86	55–66	96	6–23	19–22
Cys	20–26	13	86–131	60	221–229	64–102
Glu	127–141	132	111–142	169	79	0
Gly	49–65	96	46–86	52	42–62	265–388
Pro	34–40	63	53–75	33	126–128	17–67
Ser	41–47	42	83–108	81	127–132	124–126
Tyr	44–51	31	38–63	27	18–21	180–208

<sup>a</sup>Storm and Ørskov (1983).<sup>b</sup>Martin *et al.* (1996).<sup>c</sup>MacRae *et al.* (1993). Calculated from the amino acid profiles of the individual tissues and their protein contents by the authors.<sup>d</sup>Reis (1979).

**Table 17.2.** Estimated net efficiency of digested crude protein (DCP) for wool/fibre protein growth.

Species	Efficiency	References
Merino sheep	0.20–0.25	Standing Committee on Agriculture, 1990
Angora goats	0.39	Sahlu <i>et al.</i> (1999) <sup>a</sup>
Angora rabbits	0.43	Liu <i>et al.</i> (1992)

<sup>a</sup>Angora goats: DCP (g day<sup>-1</sup>) = 26.5 + 0.25 LWG (g day<sup>-1</sup>) + 2.58 Clean fibre growth (g day<sup>-1</sup>).

deposition, relative to the absorption of amino acids from the digestive tract. However, a significant practical difference is that protein efficiency is a single term whereas efficiency of amino acids becomes 20, corresponding to 20 different amino acids, or for wool growth 18 efficiencies for 18 amino acids in wool protein (Reis, 1979). Zebrowska *et al.* (1987) measured the efficiencies in growing Merino lambs using comparative slaughtering techniques and the highest efficiency was obtained when the animals were fed a diet containing 140 g CP kg<sup>-1</sup> compared to another two diets containing 110 and 170 g CP kg<sup>-1</sup>. The values of the gross efficiency for weight gain plus wool growth for nine indispensable amino acids were: His 0.33, Ile 0.21, Leu 0.27, Lys 0.33, Met 0.21, Phe 0.23, Thr 0.32, Trp 0.22 and Val 0.26. The arithmetic mean was 0.26. The mean efficiency for nine dispensable amino acids (Ala, Arg, Asp, Cys, Glu, Gly, Pro, Ser and Tyr) was 0.36 and the efficiency for Cys was 0.55. Hogan *et al.* (1979) estimated absorption of amino acids in mature Merinos and, by assuming that all Met was converted into Cys in the body, calculated an efficiency for Cys 0.45–0.63 at the highest wool growth rate.

There are two difficulties related to using this efficiency system. The first is in defining the 'maintenance requirement' for individual amino acids, that is, the determination of the amino acid composition for the maintenance protein requirement. This is usually derived from the endogenous loss of nitrogen in urine and in the digestive tract. The average amino acid composition of the whole body may be used, as in a simulation of amino acid utilization in pigs (Black *et al.*, 1986), but the reliability of this method has not been experimentally confirmed. The second prob-

lem is the interconversion of some amino acids and synthesis *de novo* making quantification of the efficiency very complex. For example, the high efficiency of Cys, was calculated from Cys retention and absorption. The amount of Cys converted from Met was not included in the efficiency calculation, so the efficiency is overestimated.

Because of the problems described above, a new approach to the measurement of amino acid requirements for human beings has been proposed (Young and Borgonha, 2000). In this system the oxidation of amino acids in response to varying levels of amino acid intakes was measured directly using isotope-labelling techniques and the requirement was defined from the minimum intake to balance the daily rate of the irreversible oxidation of the amino acid. The oxidation, from any of the catabolic pathways, accounts for the net loss of amino acids from the metabolic pool. This net loss can be measured directly and has to be matched by dietary supply. Using this system the requirements for humans of Leu, Ile, Lys, Met, Cys, Phe, Tyr, Thr and Trp have been measured (Young, 1998; Raguso *et al.*, 1999; Young and Borgonha, 2000).

The requirements of amino acids for animals must include amino acids used for maintenance-related protein synthesis, the outputs of products (increment of body protein mass, milk, or wool) and the oxidative (or catabolic) loss. Liu and Masters (2000) proposed a conceptual model to quantitate the requirements and utilization efficiencies of Met and Cys for wool growth in the growing Merino sheep. In this model the oxidation rate was defined as the ratio of the total oxidation to the flux per kg live weight to account for variations in the live weights from different experiments. Oxidation rate was found to be closely associ-

ated with the flux per unit of live weight. The total oxidative loss was then quantified, using published data, from the whole-body flux multiplied by the oxidation rate. Both the flux rate and oxidation were based on measurements using isotopic techniques for Met (Egan *et al.*, 1984) and for Cys (Lee *et al.*, 1995; McNabb *et al.*, 1993; Sun *et al.*, 1994). In the model the factors used for the calculation of the requirement and the utilization efficiency included Met and Cys compositions in both the body and wool, rates of weight gain and wool growth, a fractional degradation rate of the whole-body protein, oxidation rates and a conversion rate of Met into Cys. A sensitivity analysis of the model indicated that the oxidation rate was the major factor in the determination of the requirement and efficiency (Liu and Masters, 2000). This suggests that differences in oxidation rates of individual amino acids could indicate their relative order of limitation to production. For this purpose published data on oxidation (catabolism) of some amino acids, as measured using isotope-labelling techniques in sheep, were collected, the oxidation rate was estimated using a linear regression analysis and is shown in Table 17.3.

Among the indispensable amino acids, Met had the highest oxidation rate, followed by Lys. The size of the free Met pool in the body is much smaller than that of Lys (0.8 vs. 3.0 mmol kg<sup>-1</sup> day<sup>-1</sup> in Suffolk cross wethers; Lobley *et al.*, 1996b). A small pool coupled with a high oxidation rate for Met indicates that there is less Met available for protein synthesis in the body, and therefore Met supply could be more limiting, compared with Lys, for protein utilization efficiency in sheep. A very high oxidation rate of Cys in combination with high demand for wool protein synthesis would indicate that Cys supply will be the limiting factor to wool production.

### Partition of Amino Acids Between Wool Growth and Body Weight Gain

Partition of amino acids between wool growth and weight gain of growing animals is determined by their relative growth rates. Black *et al.* (1973) observed that N retained

in the wool accounted for 0.34–0.49 of the total N accretion (including wool) in Merino wethers in response to abomasal supplementation of various levels of casein (from 20 g day<sup>-1</sup> up to 100 g day<sup>-1</sup> for 32 kg lambs) at an appropriate level of energy intake (0.37 MJ gross energy kg<sup>-1</sup> W<sup>0.75</sup> day<sup>-1</sup>). The relationship between the wool N retention and total N retention appeared to be linear, suggesting that dietary protein level does not alter the partition of N between wool growth and body gain (Black *et al.*, 1973). A regression analysis on Black's data demonstrated that wool N : body N ratio was 0.31 : 0.69; MacRae *et al.* (1993) measured the total N in the body (including wool) and N in the wool in Suffolk–Finn Dorset lambs weighing 25, 40 or 55 kg. Calculations on the ratio of increased wool N to increased total N from 25 kg to 40 kg was 0.34, and from 40 kg to 55 kg was 0.36. In recent studies with Cashmere-yielding and Angora goats (Souri *et al.*, 1998a) N accretion in the fibre was 0.37 of the total N accretion (including fibre), and did not change (0.38) when the growth rate of fibre was increased by 69% in response to a supplementation of 2.5 g day<sup>-1</sup> rumen protected Met (Galbraith, 1998). These figures from different animals are surprisingly close to each other, suggesting that in weight-gaining wool-producing animals the partition of N to wool or fibre growth seems reasonably stable.

With both the wool and body N responses to various levels of protein intake measured (Black *et al.*, 1973) the partition of amino acids between wool growth and weight gain of growing animals can be calculated using amino acid compositions of wool (Reis, 1979) and the whole body (MacRae *et al.*, 1993). With a regression analysis of the retention of an amino acid in the wool against total retention, the partition of Met, Lys, Leu, Cys, Ser or Arg to wool was estimated, and is shown in Table 17.4. Only small proportions, 0.13 and 0.15, of Met and Lys are retained in the wool because of their low concentrations in wool protein. The majority of Cys retention occurs in the wool, indicating that the availability of Cys to the wool follicle is critical to wool production.

**Table 17.3.** Calculated oxidation rate of amino acids in sheep. The rate is expressed as the proportion of the flux that is oxidized, and calculated as the regression coefficient of oxidation rate against the whole-body amino acids flux ( $\text{mmol kg}^{-1} \text{day}^{-1}$ ). The group means of oxidation rate and flux in the original publications were used in the analysis. All the regression coefficients are statistically significant ( $P < 0.001$ ) except for Lys which had only two data points. The constant was excluded in the regression analysis because none of them were significantly different from zero ( $P > 0.05$ ).

	Animals	Flux range ( $\text{mmol kg}^{-1} \text{day}^{-1}$ )	Oxidation rate ( $\pm \text{SE}$ )	References
Cys	Romney wether 29–48 kg	0.42–2.60	$0.18 \pm 0.03$	Lee <i>et al.</i> (1995); McNabb <i>et al.</i> (1993); Sun <i>et al.</i> (1994); Wang <i>et al.</i> (1994)
Leu	Suffolk cross 26–46 kg	3.24–6.12	$0.03 \pm 0.002$	Harris <i>et al.</i> (1992); Inkster <i>et al.</i> (1989); Krishnamurti and Janssens (1988); Lobley <i>et al.</i> (1987)
	Greyface 42–45 kg	5.62–6.11	$0.04 \pm 0.001$	MacRae <i>et al.</i> (1988)
Lys	Merino cross 26 kg	1.01–1.55	$0.15 \pm 0.01$	Cronje <i>et al.</i> (1992)
Met	Merino wether 26–35 kg	0.44–1.68	$0.16 \pm 0.02$	Egan <i>et al.</i> (1984)
Phe	Suffolk cross 26–35 kg	1.13–1.99	$0.09 \pm 0.005$	Harris <i>et al.</i> (1992)
	Merino cross 23–52 kg	0.74–1.27	$0.08 \pm 0.007$	Oddy <i>et al.</i> (1997)
Thr	Greyface pregnant ewes	1.74–2.02	$0.04 \pm 0.002$	MacRae and Egan (1983)

**Table 17.4.** Estimated partition of some amino acids to wool protein in growing Merino lambs. The values show the ratio of amino acid retention in wool to the total retention (wool plus body weight gain), as estimated from N balance measurement. N balance data from Black *et al.* (1973), amino acid compositions in wool from Reis (1979) and in the body from MacRae *et al.* (1993).

N	Met	Cys	Lys	Leu	Ser	Arg
0.31	0.13	0.77	0.15	0.31	0.47	0.36

Estimating amino acid partition towards wool growth using wool growth against protein accretion (or N retention) becomes difficult in animals that are either not gaining weight or are losing weight because wool still grows but protein retention in the body is zero or negative. An alternative technique is to estimate wool growth as a proportion of whole body protein synthesis rather than protein retention. This may be possible because wool does not undergo degradation after keratinization is complete (Harris and Lobley, 1991) so synthesis of the protein is equal to deposition, whereas body protein accretion is determined by both synthesis and degradation. The technique requires the conversion of protein retention to protein synthesis. In growing sheep 0.31 of whole-body protein synthesis is retained as protein (Liu *et al.*, 1995). Therefore, the partitioning of protein synthesis to the non-wool component of the whole body would be equal to 2.22 ( $0.69 \div 0.31$ ), where 0.69 is the proportion of protein retained in the body relative to wool. This indicates the wool protein synthesis : non wool whole-body protein synthesis ratio is 0.31 : 2.22, in other words wool protein accounts for 0.12 of the total protein synthesis in the body ( $0.31 \div (0.31 + 2.22)$ ). Use of this technique still requires information on protein synthesis rates during weight loss and these data are not currently available.

### Improving Amino Acid Utilization for Wool Growth

#### Increasing dietary protein supply for wool growth

Black (1988) estimated that the ATP required by the follicles of a 40 kg sheep producing 20 g day<sup>-1</sup> of clean wool represents only about

7% of the energy required for basal metabolism. However, 20 g of protein in the wool together with the sloughed root sheath cells is equivalent to about 150% of the maintenance requirement for protein (Black, 1988). Therefore, the level of absorbed amino acids has a major influence on the substrates available for protein synthesis and wool growth rate. Numerous experiments have demonstrated the effectiveness of dietary protein supply on increasing wool growth rate and this has been well reviewed for sheep (Black, 1988; Williams, 1995; Hynd, 2000) and for goats (Galbraith, 1998, 2000).

Feed proteins vary in their amino acid compositions and are also characterized by different rates of degradation in the rumen. This leads to considerable variation in the profiles of absorbed amino acids. Generally, feed protein containing a high level of sulphur-containing amino acids that is less degradable in the rumen would result in increased wool production. For example, canola (rapeseed) meal and lupin seed both contain similar and high levels of crude protein, but canola meal is less degraded in the rumen (AFRC Technical Committee on Responses to Nutrients, 1993) and contains more Met than lupin protein (20 vs. 4–10 g kg<sup>-1</sup> protein; Hill, 1991). Merino lambs fed a diet containing canola meal grew 7–64% more wool than sheep fed a lupin seed diet (Masters *et al.*, 1998; White *et al.*, 2000), and the response depends on the level of intake and the proportion of canola meal in the diet. Similar positive responses to canola meal diets were observed in pregnant or lactating Merino ewes (increased wool growth of 50–63%; Masters *et al.*, 1996) and in adult dry ewes (12–20%; Masters and Mata, 1996). Reis and Colebrook (1972) compared casein, wheat gluten, Promine-D and zein for wool production and ranked their relative values as



100, 54, 40 and -11. However, fibre growth of cashmere goats fed a fishmeal diet was not improved compared to those fed a urea diet at similar N intakes (about 15 g CP kg<sup>-1</sup>; Galbraith, 2000). The fibre growth rate in cashmere goats was low, less than 40% of the mohair yield from Angora goats (Galbraith, 2000). The lack of response of fibre growth to dietary protein level was probably due to the nutrient demand for the maximum fibre growth already being met by the urea diet.

### Altering amino acid profile in favour of wool growth

It is generally accepted that the profile of absorbed amino acids from the gut affects the utilization efficiency and this has led to a concept of an 'ideal' amino acid pattern (Fuller, 1992).

To determine the ideal pattern of amino acids is a complex challenge (see Chapters 9 and 13). The simplest approach depends on the amino acid profiles of the products, i.e. accretion of the body protein mass (weight gain), milk output, or wool growth. In growing animals protein deposition both in the body and in wool needs to be included. Since amino acid composition of body protein does not change significantly during growth from 25 kg to 55 kg live weight (MacRae *et al.*, 1993), the composition of the whole body could be used for estimating protein accretion. However, a specific consideration has to be made for wool growth because the amino acid composition in wool is different from the tissue proteins (as shown in Table 17.1). In particular, high concentrations of Cys, Ser and Arg in wool suggest that amino acid profiles with high proportions of these amino acids could favour wool growth. Interestingly these amino acids are not essential and their availability for both anabolism and catabolism is influenced by biosynthesis *de novo*.

More realistically, the 'ideal' amino acid pattern should reflect the dynamic profile of protein turnover. The protein deposited in both the tissues and wool accounts for only a fraction of total protein synthesis. The majority of amino acids in the metabolic pool (in terms of quantity) is derived from basal protein

turnover, the profile of which is determined by the relative contributions of each tissue/organ. For example, protein synthesis in the gut tissue accounts for 0.26 of whole-body protein synthesis and skeletal muscle accounts for 0.18 (Lobley, 1993). This compares to their contributions of about 0.05 and 0.5 to total protein content of the wholebody (MacRae *et al.*, 1993). The relatively high concentrations of sulphur-containing amino acids from the gut tissue compared to the whole carcass (57 vs. 27 g kg<sup>-1</sup> protein; MacRae *et al.*, 1993) coupled with a much high turnover rate in the gut tissue (Adams *et al.*, 2000) indicate a relative increase in demand for the sulphur-containing amino acids.

A further factor that influences the 'ideal' amino acid pattern is the differences in oxidation of individual indispensable amino acids in the body. From an animal production point of the view, oxidation represents a net loss of amino acids from the body. A low oxidation rate means more amino acid would be available for protein synthesis. As seen in Table 17.3, relatively high rates of oxidation for Met, Lys and Cys would mean a higher requirement in the diet relative to the other amino acids.

### Methionine

Most feed proteins contain less than 20 g Met kg<sup>-1</sup> and 20–50 g Cys kg<sup>-1</sup> (MAFF Standing Committee on Tables of Feed Composition, 1990). The microbial protein from the rumen contains levels of Met and Cys slightly over 2% (Storm and Ørskov, 1983; Martin *et al.*, 1996). These proportions are slightly higher than 1.8% (range 1–3.2%) for Met and 1.3% (range 0.9–3.5%) for Cys in the whole body (MacRae *et al.*, 1993), but substantially lower than the 10% of Cys plus Met in the wool. Consequently, deposition of a high proportion of sulphur-containing amino acids into wool results in an imbalance of amino acids for the other tissues, so the efficiency of protein utilization is reduced.

Supplementing Merino sheep with appropriate levels of Met (about 2–5 g day<sup>-1</sup>) improves wool growth in most but not all classes of sheep (Reis *et al.*, 1973, 1990;

Mata *et al.*, 1995; Rodehutsord *et al.*, 1999; White *et al.*, 2000, 2001). It also improves fibre production in Cashmere and Angora goats (Souri *et al.*, 1998a). In Merino sheep, wool growth responded linearly to the levels of the rumen protected Met supplemented from 1 g day<sup>-1</sup> up to 5 g day<sup>-1</sup> (Mata and Masters, 1999). A regression analysis of the wool growth (g day<sup>-1</sup>) to the amount of Met supplement (g day<sup>-1</sup>) gave a wool protein : Met ratio of 0.72. In the same experiment a 5 g day<sup>-1</sup> live-weight gain was also obtained for each gram of Met supplementation, which was equivalent to about 0.8 g day<sup>-1</sup> protein accretion (Agricultural Research Council, 1984). Therefore a total retention of protein in both the body and wool was 1.5 g g<sup>-1</sup> of Met supplemented, or 2.6 g N retention g<sup>-1</sup> Met N. The amount of Met in this 1.5 g protein can be estimated to be about 0.012 g, so the ratio of retained Met in protein retention to the supplementation is only 0.011. In Angora goats the responses to supplementation of 2.5 g day<sup>-1</sup> of rumen-protected Met (containing 0.23 g N) were 0.67 g N increase in mohair plus 1.08 g N in the body (total N retention – mohair N) (Galbraith, 1998). So the ratio of the increased N retention to Met N was 7.6 : 1. Again, the estimated ratio of Met retention to Met supplementation was low at only 0.06. It is clear that the production return, in terms of protein or N retention, from Met supplementation was great, but the efficiency for Met *per se* was still low. This is partially because some Met is converted into Cys in the body, which has not been included and is discussed later in this chapter, and about 35% of the rumen-protected Met was degraded in the rumen (Muramatsu *et al.*, 1994).

The above results demonstrate that when wool growth increases in sheep or goats with Met supplementation this is coupled with increases in whole-body protein accretion and efficiency. Although supplementing with Met provides more substrate Met for protein synthesis, a more potentially important outcome is the consequent increase in the *de novo* synthesis of Cys from Met through the transsulphuration pathway. Supplementation with Met also increases the rate of cell division in wool follicles, for example by 37% with a pro-

vision of extra 2.5 g day<sup>-1</sup> Met (Hynd, 1989). Similarly, the rate of protein synthesis in the skin and the expression of some genes in follicles encoding an intermediate filament keratin protein and keratin intermediate filament associated proteins were increased by a jugular infusion of 3 g day<sup>-1</sup> of Met for a period of 7 days (Liu *et al.*, 2000). In addition, Met has a role in initiating synthesis of any protein (Glick and Pasternak, 1998), and whole-body protein synthesis was increased with a supplementation of rumen-protected methionine in Japanese goats (Muramatsu *et al.*, 1994).

However, supplementing Met to ewes in late pregnancy or early lactation does not result in a significant increase in wool growth rate (Williams *et al.*, 1978, 1988; Stewart *et al.*, 1993). In these experiments feed intakes were increased by more than 30% (Williams *et al.*, 1988) and 35% (Stewart *et al.*, 1993) to satisfy the nutrient requirements for conceptus growth, while maternal body weight was maintained unchanged. Met plus Cys was supplemented at 0.5–1.76 g day<sup>-1</sup> (Williams *et al.*, 1978, 1988) or Met only at 2.9–5.2 g day<sup>-1</sup> (Stewart *et al.*, 1993). Although wool growth rate was not improved, sulphur concentration in the wool was increased by the supplementation, indicating an increased supply of Cys to the wool follicle. The lack of a response in wool growth rate to Met and Cys supplementation is probably due to a change in the relative requirements of the essential amino acids resulting from changes in the types of proteins synthesized and retained. In late pregnancy, the gravid uterus is accumulating approximately 20 g of protein per day with a Met and Cys content similar to that in the whole body (see Table 17.1). Under the circumstances, the proportions of Met and Cys supplied from microbial protein are likely to be sufficient for the combined retention of protein in the gravid uterus and wool fibre. The suggestion that the requirement of Met and Cys, relative to other amino acids, is decreased at this time is further supported by a higher ratio of sulphur-containing amino acids to total essential amino acids in the plasma in late pregnancy and early lactation (Masters *et al.*, 1993) and an increase in the concentration of sulphur in wool grown during late pregnancy in sheep that were not

provided with amino acid supplements (Oddy *et al.*, 1985; Masters *et al.*, 1993). Despite this lack of response to sulphur amino acids, wool growth in ewes in late pregnancy does respond to an increased supply of protein supplied either via the abomasum (Williams *et al.*, 1978) or by protection from degradation in the rumen (Masters *et al.*, 1996).

### Cysteine

Although Cys is usually the first limiting amino acid for wool production, supplementing Merino sheep with Cys is only 0.8 for wool growth as efficient as supplementation with Met (Reis, 1986; Reis *et al.*, 1990). Experiments using *in vitro* culture of fibre follicles from Cashmere goats show that providing Cys without Met resulted in a significant reduction in follicle growth and viability, and Met without Cys supported growth of follicles to about 0.75 of that recorded with both Met and Cys present (Souri *et al.*, 1996). The results demonstrate that Met plays a major role in addition to the provision of Cys, probably in the initiation of protein synthesis and in cell division. The major role of Cys for wool growth is in the provision of substrate for wool protein synthesis as evidenced by the increases in expression of mRNA encoding a family of Cys-rich proteins (Fratini *et al.*, 1994) and the synthesis of Cys-rich proteins (Harris *et al.*, 1994). Cys supplementation may also result in a Met-sparing effect as indicated by enhanced activity of betaine-homocysteine methyltransferase (catalysing homocysteine back to Met), reduced activity of cystathionine synthase in the liver of rats (Finkelstein *et al.*, 1986), and reduced transsulphuration rate in cultured hair follicles (Souri *et al.*, 1998b) or in adult humans (Fukagawa *et al.*, 1996).

### Serine

Ser concentration in wool protein is as high as 83 g kg<sup>-1</sup>, double the concentration in the whole-body (Table 17.1). Wool growth of 10 g day<sup>-1</sup> needs 0.83 g day<sup>-1</sup> Ser. Ser is also a co-substrate with Met for Cys *de novo* synthesis (Cooper, 1983). Assuming that 0.75 of the

Cys used for wool is derived from transsulphuration (Souri *et al.*, 1996), 0.64 g day<sup>-1</sup> Ser would be required for the synthesis of the 1 g Cys contained in 10 g wool protein. So the total Ser for 10 g of wool growth would be about 1.5 g day<sup>-1</sup>. Ser concentrations in plasma are consistently reduced by supplementation with Met, possibly due to increased demands for protein synthesis and for transsulphuration. This has been reported in sheep (Reis *et al.*, 1990), cattle (Campbell *et al.*, 1997) and humans (Frontiera *et al.*, 1994), indicating that a supplement of Met results in the depletion of Ser. However, infusion of Ser at 10 g day<sup>-1</sup> into the jugular vein in Merino lambs (about 35 kg) for 7 days did not promote the transsulphuration rate and wool growth rate (Liu *et al.*, 2000). Probably the *de novo* synthesis is sufficient to support wool production, as indicated by the high concentration in the skin compared to some other amino acids (e.g. 835, 38 and 166 mmol kg<sup>-1</sup> wet tissue respectively for Ser, Met and Cys).

### Lysine and other amino acids

Wool protein contains a low level of Lys (Table 17.1), mainly present in the low sulphur-proteins. The bulb cells of the wool follicle are more closely related to 'normal' body cells and require Lys to support a high rate of cell division (Hynd, 1989). Provision of zein protein, which is lacking in both Lys and Tyr, markedly depresses bulb cell mitotic activity, fibre diameter and wool growth rate but not fibre length in Merino sheep (Reis, 1989). Supplementation of Lys to zein protein can reverse such a detrimental effect (Reis and Tunks, 1978). Omission of Lys from a mixture of 13 amino acids (including all indispensable amino acids) infused into the abomasum of Merino sheep depressed fibre diameter and volume but not fibre length, and resulted in weak fibres (Reis and Tunks, 1978). However, there is a lack of knowledge of the effect of Lys on wool production by sheep fed on 'normal' diets. In Angora wether goats, an intraperitoneal infusion of Lys from 1.2 g day<sup>-1</sup> up to 5.9 g day<sup>-1</sup> with 1 g day<sup>-1</sup> Met for 28 days caused a linear decrease in the

percentage of fibres that were medullated and greasy mohair production; fibre length and total N balance were unchanged (Smuts-Ayers and Sahl, 1996). In contrast, provision of 2 g day<sup>-1</sup> Lys by peritoneal infusion to Angora goats increased fibre length and reduced fibre diameter with no effect on N balance (Sahl and Fernandez, 1992). These results indicate that Lys may influence fibre growth under severe Lys deficient conditions and is most likely to exert an effect through changes in cell division in the follicle bulb.

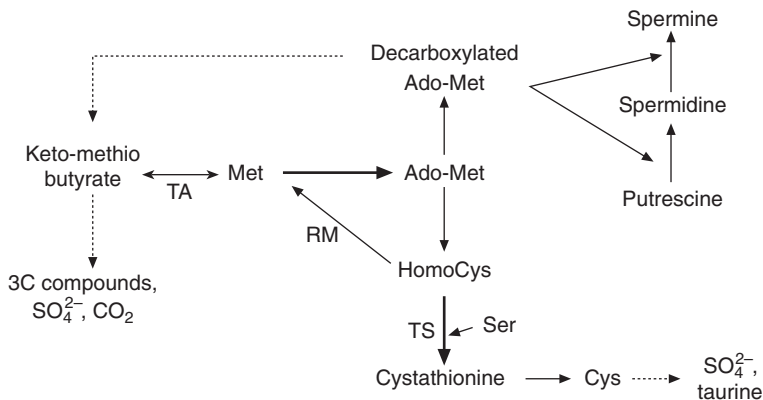
In other studies, an injection of a mixture of Lys, Arg, Val and Thr (7.1, 3.1, 5.2 and 4.1 g day<sup>-1</sup>, respectively) into the abomasum of Merino ewes in late pregnancy did not increase wool growth rate (Stewart *et al.*, 1993). Infusion of a mixture of Lys, Leu, Ile and Gly (7, 7, 6 and 1.5 g day<sup>-1</sup>) into the abomasum of mature Merinos also did not change wool growth rate or fibre diameter (Reis *et al.*, 1990). The omission of Arg, His, Phe, Thr and Val from a mixture of 13 amino acids infused into the abomasum of Merino sheep also had no appreciable effects on wool growth, whereas the omission of Leu or Ile from the mixture caused reductions in wool growth studied with two sheep (Reis and Tunks, 1978). Based on these data, some of which are generated from a small number of animals, with the exception of Met, the supply of indispensable amino acids is unlikely to limit wool production in sheep fed normal diets.

## Methionine Catabolism and Its Relation to Wool Growth

In mammals Met is catabolized mainly through the *S*-adenosylmethionine pathway, and then diverted either to the aminopropylation pathway for synthesis of polyamines (spermidine and spermine) or to the transsulphuration pathway for synthesis of homocysteine (HomoCys). HomoCys is used either for synthesis of Cys or is remethylated to re-form Met. Some Met is catabolized through the transamination pathway (Cooper, 1983). A diagram for the simplified catabolic pathways of Met is shown in Fig. 17.1. The control and regulation of the metabolic pathways have been reviewed (e.g. Stipanuk, 1986; and Finkelstein, 1990).

### Transsulphuration

Transsulphuration occurs in the liver and other visceral organs (Radcliffe and Egan, 1978), but not in skeletal muscle (Radcliffe and Egan, 1974). Transsulphuration can be measured using isotope-labelled Met and Cys with constant infusion techniques. Some measurements based on the plasma kinetics are listed in Table 17.5. These results from various sources show a similar trend that about 0.04–0.22 Cys is derived from transsulphuration, which uses less than 0.1 Met. Since these measurements refer



**Fig. 17.1.** The catabolic pathways of methionine. Abbreviations: Ado-Met, adenosylmethionine; Cys, cysteine; HomoCys, homocysteine; Met, methionine; RM, remethylation; Ser, serine; TA, transamination; TS, transsulphuration.

**Table 17.5.** Met flux and the rate of transsulphuration (as proportions of Met or Cys flux) in sheep. Met flux was recalculated from the original flux values and the corresponding liveweight of the animals.

Breeds	Met flux (mmol kg <sup>-1</sup> day <sup>-1</sup> )	Transsulphuration rate		References
		% Met	% Cys	
Suffolk cross 30 kg	0.70–1.73	0.02–0.12	0.05–0.19	Pisulewski and Buttery (1985)
Merino wether 30 kg	0.50–1.96	0.03–0.09	0.10–0.24	Egan <i>et al.</i> (1984)
Pregnant Merino ewes 37 kg	0.85–1.63	0.03–0.05	0.06–0.22	Williams <i>et al.</i> (1988)
Romney wether 29–33 kg	0.69–1.99	0.08–0.10	0.06–0.14	Lee <i>et al.</i> (1995)

to the whole-body metabolism, the actual distribution of synthesized Cys to the skin needs to be calculated using the skin : whole-body blood flow ratio. Blood flow to the whole skin of Romney sheep accounted for about 0.06 of the cardiac output (Harris *et al.*, 1989), therefore, Cys synthesis *de novo* from the systemic distribution is unlikely to make a significant contribution to wool growth.

There is, however, evidence that transsulphuration occurs within the skin (including wool follicles). Downes *et al.* (1964) gave Merino sheep an intradermal injection of [<sup>35</sup>S]Met and found 0.9 of the <sup>35</sup>S incorporated into the wool was present as Cys. With an infusion of [<sup>35</sup>S]Met, a significant appearance of <sup>35</sup>S label in the skin cystathionine (an intermediate in transsulphuration) pool and Cys pool was observed in Romney sheep (Harris *et al.*, 1997). The direct evidence is from experiments *in vitro* where inclusion of Met but not Cys in the medium enabled fibre elongation and follicle viability in follicles obtained from Merinos (Hynd and Nancarrow, 1996) or Angora goats (Souri *et al.*, 1996).

The issue is how important for wool growth is the quantity of Cys synthesized from transsulphuration in the skin or the follicles. Souri *et al.* (1996) found Met alone could produce a growth response approximately 0.8 that of Met plus Cys combined in cultured follicles. This probably represents the maximum rate of transsulphuration in the follicles since an inclusion of Cys will feedback on the activities of the enzymes involved in the pathways. Harris *et al.* (1997) measured the net uptake of Cys by the skin of Romney sheep

using arterio-venous techniques and estimated that the uptake of Cys accounted for only 0.11–0.28 of the Cys that was retained in wool, with the rest coming from local synthesis of Cys or other sources such as the tripeptide glutathione. Although the estimates are semiquantitative, the indications are that local synthesis in the skin and follicle provide a substantial source of Cys for wool growth.

### Polyamines from the aminopropylation pathway

Met is also catabolized through the aminopropylation pathway, and provides the aminopropyl group for synthesis of spermidine and spermine (see Fig. 4.3). The synthesis costs equimolar amounts of Met for spermidine or 2 mol of Met for each mole of spermine. The sulphur and methyl group may be reincorporated into Met through the 5'-methylthioadenosine salvage pathway (Stipanuk, 1986). Polyamines (putrescine, spermidine and spermine) are required for optimal growth in all cells and their physiological functions are related to DNA, RNA and protein biosynthesis (Tabor and Tabor, 1984). Putrescine and spermidine are essential for cell proliferation and growth of the cultured wool follicles, with an optimal concentration of spermidine required for the greatest rate of fibre elongation (Hynd and Nancarrow, 1996). In addition, suppression of putrescine or spermidine *de novo* synthesis *in vivo* using the inhibitors of ornithine decarboxylase or of S-adenosylmethionine decarboxylase reduces fibre length

growth rate by 10–22%, and increases fibre diameter by 1–3  $\mu\text{m}$  and sulphur content in wool by 9% (Reis and Hynd, 1989; Hynd and Nancarrow, 1996). In contrast, intradermal injections of spermidine at doses of 1.38, 2.75 or 4.58  $\mu\text{mol}$  per injection at 8 h intervals for 7 days increased fibre length growth rate but not fibre diameter in Merino wethers (Liu *et al.*, 2002). These results indicate that polyamines play a vital role in maintaining wool follicle function.

The use of Met for polyamine synthesis has not been quantified in sheep. In intact rats, 0.3 S-adenosylmethionine was catabolized through the aminopropylation pathway and the remaining 0.7 through the transsulphuration pathway. A similar partition ratio was obtained from *in vitro* experiments with human cell lines (as reviewed by Stipanuk, 1986). Expressed as a proportion of polyamines, about 0.45 spermidine plus spermine was derived from *de novo* synthesis in rats (White and Bardócz, 1999). The contribution of dietary polyamines to the body pool is low because of the low concentrations of polyamines in feeds, being about 0.0035%, 0.003% and 0.001% for putrescine, spermidine and spermine (Eliassen, 1982) and rapid degradation of polyamines in the rumen (Os *et al.*, 1995). This conclusion is supported by a low abomasal recovery of most amines, for example 0.05–0.20 in cattle (Phuntsok *et al.*, 1998). These data from various sources suggest that exogenous contributions to the large pool of polyamines in the whole body in ruminants would be limited. The *de novo* synthesis therefore, must be quantitatively important. The polyamine pool in the body appears to be much larger than that of Met, as their concentrations are substantially greater than Met, for example, 144–157  $\mu\text{mol kg}^{-1}$  wet tissue for spermidine vs. 31–38  $\mu\text{mol kg}^{-1}$  for Met (Liu *et al.*, 2002). This suggests that considerable amounts of Met could be consumed for polyamine synthesis.

### Remethylation

HomoCys can be remethylated to Met in the reaction catalysed by either Met synthase or betaine HOMO Cys methyltransferase. The for-

mer reaction uses methyl-tetrahydrofolate as a methyl donor and the latter requires betaine and its analogues (Stipanuk, 1986). About half of the HomoCys is consumed in remethylation and the rest diverted to transsulphuration in humans, intact rats, perfused rat liver and the incubated liver homogenate from rats (reviewed by Stipanuk, 1986). Remethylation conserves Met, so a change in remethylation may result in a change in Met availability for protein synthesis or for Cys synthesis. For example, remethylation was depressed by 23% when Suffolk cross wethers were infused with choline bitartrate (0.5 g day<sup>-1</sup> choline equivalent) plus 1 g day<sup>-1</sup> creatine for 8 days, whereas Met flux (based on infused [<sup>13</sup>C]Met kinetics in whole blood) was reduced by 15% and wool growth rate (fibre length and volume) tended to be reduced (Lobley *et al.*, 1996a). The amount of recycling of Met from HomoCys accounted for 0.33–0.38 of the Met flux (5.72 g day<sup>-1</sup>), compared with the estimated Met absorption of 2 g day<sup>-1</sup> (Lobley *et al.*, 1996b) which also accounted for about 0.35 of the Met flux. It seems that the provision of methyl donors reduces transmethylation of S-adenosylmethionine or diverts Met to the other catabolic pathways rather than the transsulphuration pathway. The reduced availabilities of Met and possibly Cys in the body and probably also in the skin would have a major influence on wool growth.

### Transamination

The catabolism of Met through the transamination reaction was proposed by Benevenga *et al.* (1983), and is supported by detectable levels of  $\alpha$ -keto- $\gamma$ -methylthiobutyrate, 3-methylthiopropionate and methanethiol in urine of human subjects and rats (Blom *et al.*, 1988; 1989a,b). An overdose of Met (30 g kg<sup>-1</sup> diet) to rats resulted in an increased excretion of  $\alpha$ -keto- $\gamma$ -methylthiobutyrate in the urine (Kasai *et al.*, 1991). In patients with Met adenosyltransferase deficiency, 0.2 Met was degraded via transamination. However, in normal subjects transamination did exist and was quantitatively not important in Met catabolism, even after Met loading (Blom *et al.*, 1989b). No quantitative data have been reported for sheep.

Recycling of the methylthiol group, which is derived from the aminopropylation pathway, back to Met via the transamination is also possible (Stipanuk, 1986). Aromatic amino acids are the preferred amino donors for the transamination of  $\alpha$ -keto- $\gamma$ -methylthiobutyrate to Met in trypanosomatids and mammalian liver preferentially uses glutamine for this reaction (Berger *et al.*, 1996). However, the physiological importance of the recycling of the methylthiol group to wool production remains unclear. It may compensate for some loss of Met via the transamination, but quantitatively, it seems unlikely to be important.

### Manipulating methionine metabolism for wool growth

In summary, transsulphuration appears to be the most important pathway for the provision of Cys, particularly *in situ* in the skin. Therefore, factors affecting the uptake of Met by the skin and transsulphuration in the skin or in the wool follicles will play an important role in wool production. Synthesis of spermidine and spermine competes for Met with Cys synthesis, but polyamines are essential for cell division of the bulb. The quantitative relationship between wool growth and polyamines requires definition. In particular, there may be opportunities in genetic manipulation to increase spermidine concentration in the skin to change the rate of wool growth and fibre characteristics (Janne *et al.*, 1999). Remethylation has little effect on overall Met catabolism in the skin. Little Met is lost through transamination. Therefore, the 'loss' of Met via its major catabolic pathways is actually essential for wool growth.

Although wool protein contains little Met, wool protein also accounts for less than 0.2 of the total protein synthesis in the skin (Adams *et al.*, 2000). The rest, occurring in the root sheath, bulb cells and other non-follicle tissues in the skin requires a 'normal' level of Met. Wool growth could be maximized when Met is partitioned at appropriate proportions to protein, Cys and polyamine synthesis.

### Genetic Selection for High Wool Growth

Meeting amino acid requirements through dietary manipulation is usually not cost effective because of the high prices of protein feeds and of supplements of Met or Cys. Genetic selection of sheep or goats for a high wool growth rate appears to be the most effective way to improve feed efficiency and amino acid utilization.

Williams *et al.* (1972b) compared the wool growth rate and Cys metabolism in two Merino lines selected for high or low fleece weight (F+ vs. F-) and showed that the F+ sheep grew 16% more wool with relatively lower sulphur concentration (2.99% vs. 3.48%) than the F- sheep. At the same intake, the entry rate of Cys in the F+ sheep was lower, but the recovery rate of [ $^{35}$ S]Cys in wool was higher (0.45 vs. 0.38) than in the F- sheep, indicating a relatively high efficiency of utilization of Cys for wool growth. In addition, when supplemented with Cys or Met, the increase in wool growth rate was markedly higher in the F+ sheep than the F- sheep (57% vs. 8%; Williams, 1976; Williams *et al.*, 1972a,b). In another experiment, sheep selected for high clean fleece weights grew more wool than the low fleece weight sheep (0.069 vs. 0.045 g 100 cm $^{-2}$  day $^{-1}$ ) at the same plane of nutrition, and the wool growth rates were closely related to their skin fractional protein synthesis rate (18.2 vs. 14.4% day $^{-1}$ ) and total protein synthesis in the skin (0.36 vs. 0.29 g 100 cm $^{-2}$  day $^{-1}$ ; Masters *et al.*, 2000). The difference in wool growth was due to a higher proportion of active follicles and/or a higher efficiency of follicles (wool growth rate / follicle density). Similar trends were found in fibre-producing goats, where Angora goats grew 2.25 times more fibre than Cashmere goats over a period of 112 days, and also had a substantially greater response in fibre growth to a supplementation of rumen protected Met (62% vs. 30%; Souri *et al.*, 1998a). Angora rabbits produce 1.2–1.4 kg clean wool per annum at their mature weight of 3.5–4 kg at a net efficiency of 0.43 (Liu *et al.*, 1992), double that in Merino sheep. There is no doubt that genetic differences and genetic

merit at a given level of nutrition and responses to varying nutrition are the major factors that determine utilization efficiency of amino acids for wool.

### Influences of Nutrient Partitioning Hormones

The influence of hormones on amino acid partition to the skin and wool growth appears to be indirect. This could be attributed to passive changes in the skin that result from hormone-induced alteration of amino acid metabolism in the body. Adams *et al.* (2000) reviewed the effects of hormones, including IGF-1, insulin, growth hormone, androgens,  $\beta$ -adrenergic agonist, thyroxine and cortisol on wool growth and follicle activities, and pointed out: 'there are no hormones with a homeorhoetic function to direct nutrients to the skin. However, hormones do affect wool growth through their effects on whole body protein synthesis, or by affecting protein metabolism in other organs'.

### Conclusions

The net efficiency of dietary protein for wool production is 0.2–0.25 in sheep, 0.39 in Angora goats and 0.43 in Angora rabbits.

Maximum wool growth demands a high level of dietary protein, and, the requirements for the amino acids Met and Cys are usually above exogenous supply. Supplementation with Met enhances efficiency of protein for wool growth by promoting protein metabolism in the follicles, skin and whole body. Supplementing with Cys is less effective but increases wool growth rate and sulphur content in wool. Supplying other amino acids appears to have little effects on wool production. Cys synthesized in the skin is quantitatively important to support wool growth. However, its synthesis competes for Met against the synthesis of polyamines. Polyamines are essential to maintain high proliferation rate of bulb cells and their concentrations are associated with growth rate of fibre length under experimental conditions. Remethylation and transamination play little role in Met catabolism in the skin. Wool growth could be maximized when Met is partitioned at appropriate proportions to protein, Cys and polyamine syntheses, particularly in the skin. Skin and wool follicles do not show a direct response to nutrient-partitioning hormones and respond passively to hormone-induced nutritional changes. Dietary manipulation of amino acid supply for a better utilization for wool growth is effective, but genetic selection for a high efficiency appears to be a more economical strategy.

### References

- Adams, N.R., Liu, S.M., Briegel, J.R. and Greeff, J.C. (2000) Protein metabolism in skin and muscle of sheep selected for or against staple strength. *Australian Journal of Agricultural Research* 51, 541–546.
- AFRC Technical Committee on Responses to Nutrients (1993) *Energy and Protein Requirements of Ruminants*. CAB International, Wallingford, UK.
- Agricultural Research Council (1984) *The Nutrient Requirements of Ruminant Livestock*. Commonwealth Agricultural Bureaux, Slough, UK.
- Benevenga, N.J., Radcliffe, B.C. and Egan, A.R. (1983) Tissue metabolism of methionine in sheep. *Australian Journal of Biological Sciences* 36, 475–485.
- Berger, B.J., Dai, W.W., Wang, H., Stark, R.E. and Cerami, A. (1996) Aromatic amino acid transamination and methionine recycling in trypanosomatids. *Proceedings of the National Academy of Sciences (Microbiology)* 93, 4316–4130.
- Black, J.L. (1988) Physiology of wool growth: The T.G. Hungerford Refresh Course for Veterinarians. In: *Sheep Health and Production*. University of Sydney, Sydney, Australia, pp. 481–501.
- Black, J.L., Robards, G.E. and Thomas, R. (1973) Effects of protein and energy intakes on the wool growth of Merino wethers. *Australian Journal of Agricultural Research* 24, 399–412.



- Black, J.L., Campbell, R.G., Williams, I.H., James, K.J. and Davies, G.T. (1986) Simulation of energy and amino acid utilisation in the pig. *Research and Development in Agriculture* 3, 121–145.
- Blom, H.J., Boers, G.H.J., Trijbels, J.M.F., van Roessel, J.J.M. and Tangerman, A. (1988) Differences between premenopausal women and young men in the transamination pathway of methionine catabolism, and the protection against vascular disease. *European Journal of Clinical Investigation* 18, 633–638.
- Blom, H.J., Boers, G.H.J., van den Elzen, J.P.A.M., Gahl, W.A. and Tangerman, A. (1989a) Transamination of methionine in humans. *Clinical Science* 76, 43–49.
- Blom, H.J., Boers, G.H.J., Trijbels, J.M.F., van Roessel, J.J.M. and Tangerman, A. (1989b) Cystathionine-synthase-deficient patients do not use the transamination pathway of methionine to reduce hypermethioninemia and homocysteinemia. *Metabolism* 38, 577–582.
- Campbell, C.G., Titgemeyer, E.C. and St-Jean, G. (1997) Sulphur amino acid utilization by growing steers. *Journal of Animal Science* 75, 230–238.
- Cooper, A.J.L. (1983) Biochemistry of sulphur-containing amino acids. *Annual Review of Biochemistry* 52, 187–222.
- Cronje, P.B., Nolan, J.V. and Leng, R.A. (1992) Amino acid metabolism and whole-body protein turnover in lambs fed roughage-based diets. 1. Lysine and leucine metabolism. *South African Journal of Animal Science* 22, 194–200.
- Downes, A.M., Sharry, L.F. and Till, A.R. (1964) The fate of intradermal doses of labelled amino acids in sheep. *Australian Journal of Biological Science* 17, 945–959.
- Egan, A.R., Benevenga, N.J. and Radcliff, B.C. (1984) The metabolism of S-amino acids in sheep. In: Baker, S.K., Gawthorne, J.M., Mackintosh, J.B. and Purser, D.B. (eds) *Proceedings of a Symposium held at University of Western Australia*, Perth, Australia, pp. 241–252.
- Eliassen, K.A. (1982) Formation of polyamines in the rumen of goats during growth. *Acta Veterinaria Scandinavica* 23, 275–294.
- Finkelstein, J.D. (1990) Methionine metabolism in mammals. *Journal of Nutritional Biochemistry* 5, 228–237.
- Finkelstein, J.D., Martin, J.J. and Harris, B.J. (1986) Effect of dietary cystine on methionine metabolism in rat liver. *Journal of Nutrition* 116, 985–990.
- Fratini, A., Powell, B.C., Hynd, P.I., Keough, R.A. and Rogers, G.E. (1994) Dietary cysteine regulates the levels of mRNAs encoding a family of cysteine-rich proteins of wool. *Journal of Investigation of Dermatology* 102, 178–185.
- Frontiera, M.S., Stabler, S.P., Kolhouse, J.F. and Allen, R.H. (1994) Regulation of methionine metabolism: effects of nitrous oxide and excess dietary methionine. *Journal of Nutritional Biochemistry* 5, 28–38.
- Fukagawa, N.K., Ajami, A.M. and Young, V.R. (1996) Plasma methionine and cysteine kinetics in response to an intravenous glutathione infusion in adult humans. *American Journal of Physiology* 270 (Endocrinology and Metabolism) 33, E209–E214.
- Fuller, M.F. (1992) The ideal protein system for swine. In: Erdman, R.A. (ed.) *Proceedings of the Maryland Nutrition Conference for Feed Manufacturers*, pp. 68–81.
- Galbraith, H. (1998) Nutritional and hormonal regulation of hair follicle growth and development. *Proceedings of the Nutrition Society* 57, 195–205.
- Galbraith, H. (2000) Protein and sulphur amino acid nutrition of hair fibre-producing Angora and cashmere goats. *Livestock Production Science* 64, 81–83.
- Glick, B.R. and Pasternak, J.J. (1998) *Molecular Biotechnology*, 2nd edn. ASM Press, Washington, DC, pp. 33–35.
- Harris, P.M. and Lobley, G.E. (1991) Amino acid and energy metabolism in the peripheral tissues of ruminants. In: Tsude T., Sasaki Y. and Kawashima, R. (eds) *Seventh International Symposium on Ruminant Physiology*, Academic Press, San Diego California, pp. 201–230.
- Harris, P.M., Dellow, D.W. and Sinclair, B.R. (1989) Preliminary 'in vivo' measurements of protein and energy metabolism in the skin of sheep. *Australian Journal of Agricultural Research* 40, 879–888.
- Harris, P.M., Skene, P.A., Buchan, V., Milne, E., Calder, A.G., Anderson, S.E., Connell, A. and Lobley, G.E. (1992) Effect of food intake on hind-limb and whole-body protein metabolism in young growing sheep: chronic studies based on arterio-venous techniques. *British Journal of Nutrition* 68, 389–407.
- Harris, P.M., Lee, J., Sinclair, B.R. and Treloar, B.P. (1994) The effect of whole body cysteine supplementation on cysteine utilization by the skin of a well-fed sheep. *Proceedings of the New Zealand Society of Animal Production*, pp. 139–142.

- Harris, P.M., Sinclair, B.R., Treloar, B.P. and Lee, J. (1997) Short-term changes in whole body and skin sulphur amino acid metabolism of sheep in response to supplementary cysteine. *Australian Journal of Agricultural Research* 48, 137–146.
- Hill, R. (1991) Rapeseed meal in the diets of ruminants. *Nutrition Abstracts and Reviews B: Livestock Feeds and Feeding* 61, 139–154.
- Hogan, J.P., Elliott, N.M. and Hugues, A.D. (1979) Maximum wool growth rates expected from Australian Merino genotypes. In: Black, J.L. and Reis, P.J. (eds) *Physiological and Environmental Limitations to Wool Growth*. The University of New England Publishing Unit, Armidale, Australia, pp. 43–71.
- Hynd, P.I. (1989) Factors influencing cellular events in the wool follicle. In: Rogers, G.E., Reis, P.J., Ward, K.A. and Marshall, R.C. (eds) *The Biology in Wool and Hair*. Chapman and Hall, London, pp. 169–184.
- Hynd, P.I. (2000) The nutritional biochemistry of wool and hair follicles. *Animal Science* 70, 181–195.
- Hynd, P.I. and Nancarrow, M.J. (1996) Inhibition of polyamine synthesis alters hair follicle function and fibre composition. *Journal of Investigative Dermatology* 106, 249–253.
- Inkster, J.E., Hovell, F.D.D., Kyle, D.J., Brown, D.S. and Lobley, G.E. (1989) The effect of clenbuterol on basal protein turnover and endogenous nitrogen loss of sheep. *British Journal of Nutrition* 62, 285–298.
- Janne, J., Alhonen, L., Halmekyto, M. and Peitila, M. (1999) Genetic engineering of polyamine metabolism: consequences of the activation of polyamine biosynthesis or catabolism in transgenic rodents. In: Bardocz, S. and White, A. (eds) *Polyamines in Health and Nutrition*. Kluwer Academic Publishers, Boston, Massachusetts, pp. 87–98.
- Kasai, T., Ogo, Y., Otobe, Y. and Kiriyama, S. (1991) 2-Keto-4-methylthiobutyric acid in urine of rats fed an excess methionine diet. *Agricultural and Biological Chemistry* 55, 3135–3138.
- Krishnamurti, C.R. and Janssens S.M. (1988) Determination of leucine metabolism and protein turnover in sheep, using gas-liquid chromatography-mass spectrometry. *British Journal of Nutrition* 59, 155–164.
- Lee, J., Harris, P.M., Sinclair, B.R. and Treloar, B.P. (1995) Sulphur amino acid metabolism and protein synthesis in young sheep fed ryegrass pasture and two lotus cultivars containing condensed tannin. *Australian Journal of Agricultural Research* 46, 1587–1600.
- Liu, S.M. and Masters D.G. (2000) Quantitative analysis of methionine and cysteine requirements for wool production of sheep. *Animal Science* 71, 175–185.
- Liu, S.M., Zhang, L., Chang, C., Pen, D.H., Xu, Z., Wang, Y.Z., Chen, Q., Cao, W.J. and Yuan, D.Z. (1992) Studies on the nutrient requirements of Angora rabbits. 1. Digestible energy, crude protein and methionine and lysine. *Journal of Applied Rabbit Research* 14, 260–265.
- Liu, S.M., Lobley, G.E., MacLeod, N.A., Kyle, D.J., Chen, X.B. and Ørskov, E.R. (1995) Effects of long-term protein excess or deficiency on whole-body protein turnover in sheep nourished by intragastric infusion of nutrients. *British Journal of Nutrition* 73, 829–839.
- Liu, S.M., Mata, G., Figliomeni, S., Powell, B.C., Nesci, A. and Masters, D.G. (2000) Transsulphuration, protein synthesis rate and follicle mRNA in the skin of young Merino lambs in response to infusions of methionine and serine. *British Journal of Nutrition* 83, 401–409.
- Liu, S.M., Murray, A.C., Schlink, A.C., Mata, G. and Masters, D.G. (2002) The effects of intradermal injection of spermidine on the growth rate of fibres and mitosis of wool follicles in Merino lambs. *Animal Science* 75, 33–40.
- Lobley, G.E. (1993) Protein metabolism and turnover. In: Forbes, J.M. and France, J. (eds) *Quantitative Aspects of Ruminant Digestion and Metabolism*. CAB International, Wallingford, UK, pp. 313–339.
- Lobley, G.E., Connell, A., Buchan, V., Skene, P.A. and Fletcher, J.M. (1987) Administration of testosterone to wether lambs: effects on protein and energy metabolism and growth hormone status. *Journal of Endocrinology* 115, 439–445.
- Lobley, G.E., Connell, A. and Revell, D. (1996a) The importance of transmethylation reactions to methionine metabolism in sheep: effects of supplementation with creatine and choline. *British Journal of Nutrition* 75, 47–56.
- Lobley, G.E., Connell, A., Revell, D., Bequette, B.J., Brown, D.S. and Calder, A.G. (1996b) Splanchnic transfer of amino acids in sheep blood and plasma, as monitored through use of a multiple U-<sup>13</sup>C-labelled amino acid mixture. *British Journal of Nutrition* 75, 217–235.
- MacRae, J.C. and Egan A.R. (1983) Threonine metabolism in sheep. 2. Threonine catabolism and gluconeogenesis in pregnant ewes. *British Journal of Nutrition* 49, 385–393.
- MacRae, J.C., Skene, P.A., Connell, A., Buchan, V. and Lobley, G.E. (1988) The action of the  $\beta$ -agonist clenbuterol on protein and energy metabolism in fattening wether lambs. *British Journal of Nutrition* 59, 457–465.

- MacRae, J.C., Walker, A., Brown, D. and Lobley G.E. (1993) Accretion of total protein and individual amino acids by organs and tissues of growth lambs and the ability of nitrogen balance techniques to quantitate protein retention. *Animal Production* 57, 237–245.
- MAFF (Ministry of Agriculture, Fisheries and Food) Standing Committee on Tables of Feed Composition (1990) In: Givens, D.I. (ed.) *UK Tables of Nutritive Value and Chemical Composition of Feedingstuffs*. Rowett Research Services, Aberdeen, UK.
- Martin, C., Bernard, L. and Michalet-Doreau, B. (1996) Influence of sampling time and diet on amino acid composition of protozoal and bacterial fractions from bovine ruminal contents. *Journal of Animal Science* 74, 1157–1163.
- Masters, D.G. and Mata, G. (1996) Responses to feeding canola meal or lupin seed to pregnant, lactating, and dry ewes. *Australian Journal of Agricultural Research* 47, 1291–1303.
- Masters, D.G., Stewart, C.A. and Connell, P.J. (1993) Changes in plasma amino acid patterns and wool growth during late pregnancy and early lactation in the ewe. *Australian Journal of Agricultural Research* 44, 945–957.
- Masters, D.G., Stewart, C.A., Mata, G. and Adams, N.A. (1996) Responses in wool and live weight when different sources of dietary protein are given to pregnant and lactating ewes. *Animal Science* 62, 497–506.
- Masters, D.G., Mata, G., Liu, S.M. and Peterson, A.D. (1998) The influence of liveweight, liveweight change and diet on wool growth and staple strength in young sheep. *Australian Journal of Agricultural Research* 49, 269–277.
- Masters, D.G., Liu, S.M., Purvis, I.W. and Hartofilis, M. (2000) Wool growth and protein synthesis in the skin of superfine Merinos with high and low fleece-weight. *Asian-Australian Journal of Animal Science* 13 Supplement A, 457–460.
- Mata, G. and Masters, D.G. (1999) Rumen protected methionine improves the efficiency of use of metabolisable protein for wool growth. In: Stone, G., Forbes, T.D.A., Stuth, J.W. and Byers, F.M. (eds) *Nutritional Ecology of Herbivores*. Posters and Plenary Discussions and Papers presented at Satellite Symposia and Seminar held in conjunction with the *Fifth International Symposium on the Nutrition of Herbivores*. The American Society of Animal Science, San Antonio, Texas (CD-ROM).
- Mata, G., Masters, D.G., Buscall, D., Street, K. and Schlink, A.C. (1995) Responses in wool growth, liveweight, glutathione and amino acids, in Merino wethers fed increasing amounts of methionine protected from degradation in the rumen. *Australian Journal of Agricultural Research* 46, 1189–1204.
- Mata, G., Adams, N.R., Odea, T., Masters, D.G. and Schlink, A.C. (1999) Is there a specific weakness in staple strength around the break of season? *Australian Journal of Experimental Agriculture* 39, 401–409.
- McNabb, W.C., Waghorn, G.C., Barry T.N. and Shelton, I.D. (1993) The effect of condensed tannins in *Lotus pedunculatus* on the digestion and metabolism of methionine, cystine and inorganic sulphur in sheep. *British Journal of Nutrition* 70, 647–661.
- Muramatsu, T., Hatano, T., Ueda, Y., Furuse, M. and Okumura, J. (1994) Whole-body protein turnover in goats enhanced by supplementing a diet with rumen protected methionine. *Asian-Australian Journal of Animal Sciences* 7, 279–288.
- Oddy, V.H., Gooden, J.M., Hough, G.M., Telene, E. and Anison, E.F. (1985) Partitioning of nutrients in Merino ewes. 2. Glucose utilization by skeletal muscle, the pregnant uterus and the lactating mammary gland in relation to whole body glucose utilization. *Australian Journal of Biological Science* 38, 95–108.
- Oddy, V.H., Edwards, S.R., Warren, H.M., Speck, P.A., Nicholls, P.J. and Neutze, S.A. (1997) Interrelationships between amino acid and glucose metabolism in lambs of different dietary history supplemented with rumen escape protein. *Journal of Agricultural Science* 128, 105–116.
- Os, M. van, Lassalas, B., Toillon, S., Jouany, J.P. and Van Os, M. (1995) *In vitro* degradation of amines by rumen micro-organisms. *Journal of Agricultural Sciences* 125, 299–305.
- Phuntsok, T., Froetschel, M.A., Amos, H.E., Zheng, M. and Huang, Y.W. (1998) Biogenic amines in silage, apparent post-ruminal passage, and the relationship between biogenic amines and digestive function and intake by steers. *Journal of Dairy Science* 81, 2193–2203.
- Pisulewski, P.M. and Buttery, P.J. (1985) The effect of increasing methionine supply on the methionine conversion to cyst(e)ine in sheep. *British Journal of Nutrition* 54, 121–129.
- Radcliffe, B.C. and Egan, A.R. (1974) A survey of methionine adenosyltransferase and cystathionine r-lyase activities in ruminant tissues. *Australian Journal of Biological Sciences* 27, 465–471.
- Radcliffe, B.C. and Egan, A.R. (1978) The effect of diet and of methionine loading on activity of enzymes in the transsulphuration pathway in sheep. *Australian Journal of Biological Research* 31, 105–114.

- Raguso, C.A., Pereira, P. and Young, V.R. (1999) A tracer investigation of obligatory oxidative amino acid losses in healthy, young adults. *American Journal of Clinical Nutrition* 70, 474–483.
- Reis, P.J. (1979) Effects of amino acids on the growth and properties of wool. In: Black, J.L. and Reis, P.J. (eds) *Physiological and Environmental Limitations to Wool Growth*. University of New England Publishing Unit, Armidale, Australia, pp. 223–242.
- Reis, P.J. (1986) The relative efficiency of methionine, cysteine and homocysteine for promoting wool growth. *Proceedings of Nutritional Society of Australia* 11, 166.
- Reis, P.J. (1989) The influence of absorbed nutrients on wool growth. In: Black J.L. and Reis P.J. (ed.) *The Biology of Wool and Hair*. Chapman and Hall, London, pp. 185–215.
- Reis, P.J. and Colebrook, W.R. (1972) The utilization of abomasal supplements of proteins and amino acids by sheep with special reference to wool growth. *Australian Journal of Biological Science* 25, 1057–1071.
- Reis, P.J. and Hynd, P.I. (1989) The influence of  $\alpha$ -difluoromethylornithine on the activity of wool follicles. *Asian-Australian Journal of Animal Sciences* 2, 204–205.
- Reis P.J. and Tunks, D.A. (1978) Effects of wool growth of the infusion of mixtures of amino acids into the abomasum of sheep. *Journal of Agricultural Science, Cambridge* 90, 173–183.
- Reis, P.J., Tunks, D.A. and Downes, A.M. (1973) The influence of abomasal and intravenous supplements of sulphur-containing amino acids on wool growth rate. *Australian Journal of Biological Science* 26, 249–258.
- Reis, P.J., Tunks, D.A. and Munro, S.G. (1990) Effects of the infusion of amino acids into the abomasum of sheep, with emphasis on the relative value of methionine, cysteine and homocysteine for wool growth. *Journal of Agricultural Science, Cambridge* 114, 59–68.
- Rodehutsord, M., Young, P., Phillips, N. and White, C.L. (1999) Wool growth in Merino wethers fed lupins untreated or treated with heat or formaldehyde, with and without a supplementation of rumen protected methionine. *Animal Feed Science and Technology* 82, 213–226.
- Sahlu, T. and Fernandez, J.M. (1992) Effect of intraperitoneal administration of lysine and methionine on mohair yield and quality in Angora goats. *Journal of Animal Science* 70, 3188–3193.
- Sahlu, T., Hart, S.P. and Goetsch, A.L. (1999) Effects of level of feed intake on body weight, body components, and mohair growth in Angora goats during realimentation. *Small Ruminant Research* 32, 251–259.
- Smuts-Ayers, M. and Sahlu, T. (1996) The effect of various levels of lysine influenced intraperitoneally on mohair quality and nitrogen metabolism in Angora goats. *Small Ruminant Research* 20, 113–119.
- Souri, M., Galbraith, H. and Scaife, J.R. (1996) The role of methionine and cystine in growth and viability of secondary follicles of the Cashmere goat *in vitro*. *Animal Science* 62, 669.
- Souri, M., Galbraith, H. and Scaife, J.R. (1998a) Comparisons of the effect of genotype and protected methionine supplementation on growth, digestive characteristics and fibre yield in cashmere-yielding and Angora goats. *Animal Science* 66, 217–223.
- Souri, M., Galbraith, H. and Scaife, J.R. (1998b) Conversion of methionine to cysteine by transsulphuration in isolated anagen secondary hair follicles of Angora goats. *Proceedings of the British Society of Animal Science*, 139.
- Standing Committee on Agriculture R.S. (1990) *Feeding Standards for Australian Livestock – Ruminants*. CSIRO Publications, East Melbourne, Australia, pp. 105–109.
- Stewart, C.A., Masters, D.G., Williams, I.H. and Connell, P.J. (1993) Changes in plasma amino acids patterns and wool growth in response to abomasal injections of amino acids during late pregnancy and early lactation. *Australian Journal of Agricultural Research* 44, 959–971.
- Stipanuk, M.H. (1986) Metabolism of sulphur-containing amino acids. *Annual Review on Nutrition* 6, 179–209.
- Storm, E. and Ørskov, E.R. (1983) The nutritive value of rumen micro-organisms in ruminants. 1. Large-scale isolation and chemical composition of rumen micro-organisms. *British Journal of Nutrition* 50, 463–470.
- Sun, Y.N., Lee, J., Harris, P.M., Sinclair, B.R., Shelton, I.D., Blair, H.T. and McCutcheon, S.N. (1994) Nitrogen and sulphur metabolism and plasma thyroid hormone concentrations in fleeceweight-selected and control Romney sheep at two ambient temperatures. *Australian Journal of Agricultural Research* 45, 339–354.
- Tabor, C.W. and Tabor, H. (1984) Polyamines. *Annual Review on Biochemistry* 53, 749–790.

- Wang, Y.X., Waghorn, G.C., Barry, T.N. and Shelton, I.D. (1994) The effect of condensed tannins in *Lotus pedunculatus* on plasma metabolism of methionine, cystine and inorganic sulphur by sheep. *British Journal of Nutrition* 72, 923–935.
- White, A. and Bardócz, S. (1999) Estimation of the polyamine body pool: contribution by *de novo* biosynthesis, diet and luminal bacteria. In: Bardócz, S. and White, A. (eds) *Polyamines in Health and Nutrition*. Kluwer Academic Publishers, Boston, Massachusetts, pp. 117–122.
- White, C.L., Young, P., Phillips, N. and Rodehutsord, M. (2000) The effect of dietary protein source and protected methionine (Lactet) on wool growth and microbial protein synthesis in Merino wethers. *Australian Journal of Agricultural Research* 51, 173–183.
- White, C.L., Tabe, L.M., Dove, H., Hamblin, J., Young, P., Phillips, N., Taylor, R., Gulati, S., Ashes, J. and Higgins, T.J.V. (2001) Increased efficiency of wool growth and live weight gain in Merino sheep fed transgenic lupin seed containing sunflower albumin. *Journal of the Science of Food and Agriculture* 81, 147–154.
- Williams, A.J. (1976) Metabolism of cystine by Merino sheep genetically different in wool production. 4. Rates of entry of cystine into plasma, measured with a single intravenous injection of L-[<sup>35</sup>S]cystine, and the subsequent incorporation of <sup>35</sup>S into wool fibres. *Australian Journal of Biological Science* 29, 513–524.
- Williams, A.J. (1995) Wool growth. In: Cottle, D.J. (ed.) *Australian Sheep and Wool Handbook*. Inkata Press, Melbourne, Australia, pp. 224–242.
- Williams, A.J., Leng, R.A. and Stephenson, S.K. (1972a) Metabolism of cystine by Merino sheep genetically different in wool production. 1. Comparison of the entry rates of cystine in sheep from flocks selectively bred for high and low fleece weight. *Australian Journal of Biological Science* 25, 1259–1268.
- Williams, A.J., Robards, G.E. and Saville, D.G. (1972b) Metabolism of cystine by Merino sheep genetically different in wool production. 2. The responses in wool growth to abomasal infusions of L-cystine or DL-methionine. *Australian Journal of Biological Science* 25, 1269–1276.
- Williams, A.J., Tyrrell, R.N. and Gilmour, A.R. (1978) Effects on wool production during pregnancy and lactation of twice daily abomasal supplementation with casein or methionine and cystine. *Australian Journal of Experimental Agriculture and Animal Husbandry* 18, 52–57.
- Williams, A.J., Murison, R. and Padgett, J. (1988) Metabolism of sulphur-containing amino acids by pregnant Merino ewes. *Australian Journal of Biological Sciences* 41, 247–259.
- Wilson, P.A. and Short, B.F. (1979) Variations in wool growth and follicle activity in Merino sheep. In: Black, J.L. and Reis, P.J. (eds) *Physiological and Environmental Limitations to Wool Growth*. The University of New England Publishing Unit, Armidale, Australia, pp. 293–294.
- Young, V.R. (1998) Nutritional requirements of normal adults. In: Mitch, W.E. and Klahr, S. (eds) *Handbook of Nutrition and the Kidney*. Lippincott-Raven Publishers, Hagerstown, pp. 1–24.
- Young, V.R. and Borgonha S. (2000) Nitrogen and amino acid requirements: the Massachusetts Institute of Technology amino acid requirement pattern. *Journal of Nutrition* 130, 1841S–1849S.
- Zebrowska, T., Zebrowsks, H. and Pajak, J. (1987) Efficiency of utilization of absorbed amino acids in growing sheep. In: *Proceedings of the 5th International Symposium on Protein Metabolism and Nutrition*, European Association for Animal Production, Publication No. 35, Rostock, Germany, pp. 83.

# 18 Amino Acid Utilization by Growing and Finishing Ruminants

**Evan C. Titgemeyer\***

*Department of Animal Sciences and Industry, Kansas State University, Manhattan, Kansas, USA*

---

## **Introduction**

Ruminants do not have specific requirements for dietary amino acids, but their physiological needs must be considered to optimize performance. The ruminal fermentation that intervenes between the diet and the small intestine makes study of ruminant animals' physiological requirements for amino acids difficult because the amino acids absorbed from the intestine do not match either the quantity or the profile of amino acids supplied by the diet. This is a result of both ruminal degradation of dietary proteins and ruminal synthesis of microbial protein, which is subsequently available to the animal for intestinal digestion. Moreover, synthesis of microbial protein in the rumen is an energy-dependent process that typically supplies a large portion of the amino acids reaching the intestine. Therefore, it is difficult to disjoint the physiological supply of energy and amino acids in ruminants. This linkage of energy and protein supply ensures that neither of these nutrients is grossly deficient in relation to the other. The synthesis of microbial protein in the rumen benefits the animal because the amino acid supply is rarely greatly deficient, but this works to the detriment of researchers interested in quantifying amino acid utilization by ruminants.

## **Relationship Between Energy Supply and Amino Acid Requirements**

The requirement of a ruminant animal for an amino acid must be viewed in light of the performance level expected from that animal. In general, this will be dictated by the energy supply, the supply of other nutrients and other amino acids, as well as other factors that might impact protein deposition, such as the intrinsic capacity of the animal for lean growth, application of anabolic agents, and any growth-inhibiting conditions (e.g. disease).

The Cornell Net Carbohydrate and Protein System (Cornell model; O'Connor *et al.*, 1993) provides a simple framework that can be used to consider amino acid needs of growing cattle. Amino acid requirements are estimated separately for maintenance and growth. Maintenance protein requirements are based on published estimates of requirements for scurf, endogenous urinary and endogenous faecal losses. Net maintenance needs for amino acids are then generated from protein requirements using amino acid profiles of tissues (keratin for scurf and whole body for urinary and faecal losses). The efficiencies of amino acid use for scurf and endogenous urinary losses are assumed to be 85% for all absorbed essential amino acids, except branched-chain amino acids, which are assumed to be used with an

\*E-mail address: [etitgeme@oznet.ksu.edu](mailto:etitgeme@oznet.ksu.edu)

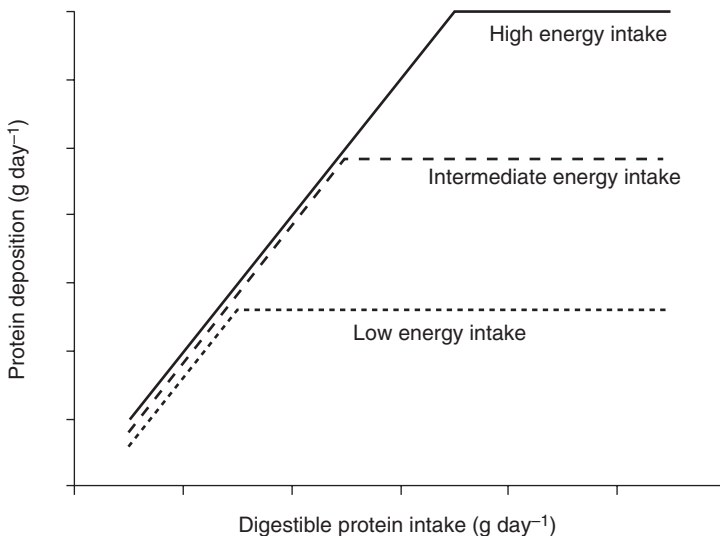
efficiency of 66% for these functions. Version 4.0 of the Cornell model computer program calculates maintenance amino acid needs somewhat differently and leads to lower estimates than calculations based on the equations of O'Connor *et al.* (1993). The conversion of maintenance protein needs into amino acid needs must be considered somewhat tenuous. This is particularly true for urinary losses where the amino acid profile of the whole body is unlikely to be reflective of those amino acids contributing to the excreted N. The maintenance faecal losses also need to be carefully evaluated because often the supply of an amino acid may be calculated on an apparent digestibility basis and, as such, will account for the endogenous losses into the gut.

In the Cornell model, protein requirements for growth are based on net protein deposition and an efficiency of utilization; protein needs are then converted into amino acid requirements using the amino acid profile of whole body tissue. The efficiencies of amino acid utilization for growth were determined using a protein efficiency equation developed by Ainslie *et al.* (1993). Efficiency of absorbed protein utilization for growth =  $0.834 - 0.00114 \times \text{equivalent shrunk}$

weight (kg). This equation, which was developed using data from INRA (1989), suggests that the efficiency of amino acid utilization for growth rarely exceeds 70% for ruminating cattle and decreases as animal weight increases. For gain, the Cornell model uses the same estimate of efficiency for all individual amino acids, and it also assumes that the efficiency of amino acid use is the same as that of protein. These assumptions are unlikely to be correct.

Within the framework of the Cornell model, amino acid needs of the animal are dependent upon the amount of protein deposited by the animal, which is defined as an energy-driven process. Thus, greater energy intakes lead to increases in amino acid requirements, which correspond directly to the predicted increases in protein deposition. At the same time, the Cornell model predicts that the efficiency of amino acid use is not affected by energy supply. This assumption is one that deserves close attention because energy intake impacts a number of factors that regulate metabolism and growth.

In monogastric animals, it is relatively clear that energy- and protein-dependent phases of growth exist (Campbell *et al.*, 1985; Fig. 18.1).

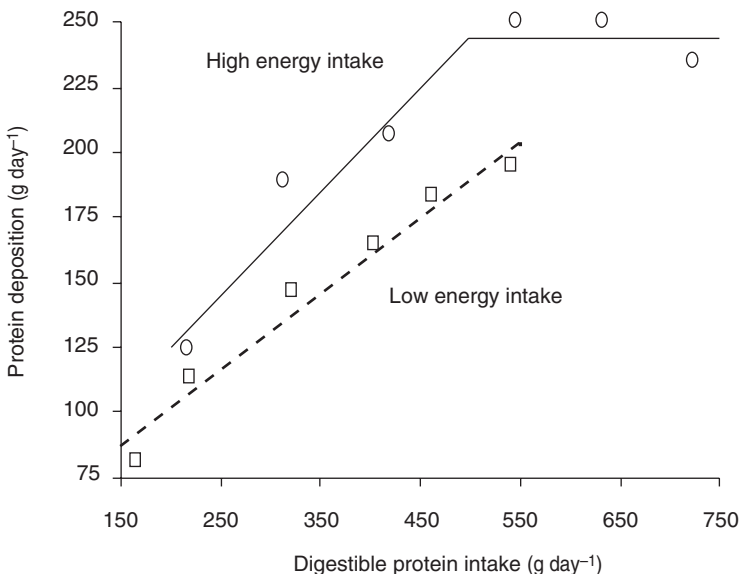


**Fig. 18.1.** A stylistic model of energy- and protein-dependent phases of growth such as observed by Campbell *et al.* (1985) for pigs. Protein deposition of animals on the inclined lines would be limited by protein intake whereas that of animals on the plateau surfaces would be limited by energy intake.

For animals in the protein-dependent phase, protein (amino acid) supply is most limiting to growth, and increases in the intake of protein lead to linear increases in protein deposition. However, when the protein supply exceeds the requirement, energy becomes limiting for growth, and the animal no longer responds to additional intakes of protein. Under conditions of adequate or excess protein intake, the supply of additional energy leads to increases in protein deposition to the point where the protein supply again becomes limiting. With this model (as in the Cornell model), the energy supply is directly related to the amino acid requirement of the animal.

Because the protein-dependent phase of growth in monogastrics demonstrates a linear response between protein intake and protein deposition across various levels of energy intake (Fig. 18.1), the efficiency of amino acid utilization is not affected by energy supply. If this is the case, the use of a single efficiency in modelling exercise is appropriate. However, it is questionable whether or not this is appropriate for ruminants.

In ruminants, the study of protein and energy interrelationships is difficult because increases in dietary energy usually increase microbial protein synthesis in the rumen and, subsequently, protein supply to the animal. One experimental model that has been used to avoid this issue is the preruminant calf in which the microbial population in the rumen has not yet developed and dietary proteins are reflective of the protein reaching the small intestine. Gerrits *et al.* (1996) used preruminant calves, altered the dietary protein and energy supplies independently, and measured protein deposition. They did not observe responses indicative of protein- and energy-dependent phases of growth. Rather, they observed increases in protein deposition when either protein or energy was supplied to the calves (Fig. 18.2). It is unknown if the preruminant calf is an adequate model of fully functional ruminant animals. Increased protein deposition in response to increased energy supply, under conditions where the calves also were capable of responding to increased protein supply, suggests that the additional energy led to increases in the efficiency of amino acid utilization.



**Fig. 18.2.** Protein deposition of preruminant calves (160–240 kg body weight) in response to changes in protein intake at two levels of energy intake (Gerrits *et al.*, 1996). Increases in either protein supply or energy supply led to increases in protein deposition, which contrasts with clearly delineated energy- and protein-dependent phases of growth depicted in Fig. 18.1.



Another experimental approach for studying protein and energy interrelationships is intragastrically maintained animals (Ørskov *et al.*, 1979; MacLeod *et al.*, 1982). In this approach, the ruminal microbial population has been removed, and nutrients are supplied by post-ruminal infusions of protein (and in some cases carbohydrates) and by ruminal infusions of volatile fatty acids (VFA), neither of which lead to microbial growth in the rumen. The disadvantages of using intragastrically maintained animals are that only low levels of production are typically achieved and some physiological differences from normally fed animals, such as an atrophied intestinal tracts, may exist.

Using intragastrically maintained yearling sheep, Lindberg and Jacobsson (1990) observed the presence of protein- and energy-dependent phases of growth. Energy was supplied as three levels of VFA infused into the rumen, and protein was altered by increasing the amount of casein infused abomasally. When protein levels were low, N retention was not affected by the amount of VFA infused, demonstrating a protein-dependent phase of lean growth. However, at the higher levels of protein, sheep had greater N balance when they were given more VFA; this demonstrated the energy-dependent phase of growth. In contrast, using intragastrically maintained lambs aged 4–6 months, Hovell *et al.* (1983) were unable to demonstrate separate protein- and energy-dependent phases of growth. Lambs had higher N balances when either energy or protein supply was increased.

In work with intragastrically maintained steers, Ørskov *et al.* (1999) observed that N retention increased linearly with protein intake and that the level and profile of VFA supplied to the rumen had little effect on protein deposition. The response to protein intake demonstrates a protein-dependent phase of growth, and this would appear to be supported by a lack of response to changes in energy supply across the protein input levels tested. However, an energy-dependent phase was not demonstrated because protein inputs never exceeded the steers' requirements.

When considering energy supplies, mobilization of body tissues (adipose) needs to be considered in addition to dietary energy. Ruminants, at least those near maintenance,

are capable of mobilizing body fat that can serve as an energy source in support of protein deposition (Hovell *et al.*, 1983). This has been termed the lipotropic effect by Asplund (1994). In essence, mobilization of body fat increases the energy available to the animal and can lead to a protein-dependent phase of growth, even when dietary energy input would be considered deficient. Work with intragastrically maintained cattle (Ørskov *et al.*, 1999) suggests that body lipid mobilization for the support of protein deposition would only be important for animals near maintenance; energy supply only impacted protein deposition when glucose (*i.e.* gluconeogenic precursors) was deficient. Fatter animals should have a greater ability to mobilize body fat than thinner ones, so the physiological status of the animal may be an important consideration relative to energy- and protein-dependent phases of growth.

Researchers also have evaluated interactions between protein use and energy supply by changing amounts of feed intake. Although energy supply can be altered conveniently in this fashion, protein supply will also change correspondingly. MacRae *et al.* (1995) fed growing lambs graded levels (maintenance to 2.5 × maintenance) of grass pellets or grass/barley pellets and measured the amount of amino acids deposited in the body in relation to metabolizable amino acid supply. The efficiencies of use (deposited/absorbed) of total essential amino acids were 50% for the grass pellet diet and 59% for the grass/barley pellets. This suggests that energy source (or other factors associated with these diets) impacted efficiency of amino acid use. The efficiencies with which individual amino acids were used for growth are valid only for those amino acids that were limiting. For amino acids that were not limiting, efficiencies would be underestimated because the supply, which would be the denominator for calculating efficiency, was greater than the required amount.

### **Effect of Nitrogen (Ammonia/Amino Acids) Supply on Amino Acid Utilization**

Ammonia contributes a large proportion of the dietary nitrogen absorbed by ruminants

under some dietary conditions, and it is detoxified primarily to urea in the liver (Reynolds, 1992). Huntington (1989) and Reynolds *et al.* (1991) reported that the removal of ammonia by the liver did not account for all of the urea nitrogen released, suggesting that non-ammonia nitrogen was also used for the synthesis of urea. These authors also reported that increases in the removal of ammonia by the liver were associated with increases in amino acid extraction. Reynolds (1992) suggested that amino acid nitrogen is needed for the synthesis of aspartate, which contributes one of the two nitrogen atoms in urea. Lobley *et al.* (1995) postulated that the requirement for aspartate to synthesize urea and detoxify absorbed ammonia may lead to penalties for the use of amino acids for protein synthesis. As a result, an increase in the amount of nitrogen absorbed (nitrogen loading) may decrease the efficiency with which amino acids are used for growth (Lobley *et al.*, 1998).

Lobley *et al.* (1995) evaluated the effect of ammonia level on the fate of absorbed amino acids in sheep. Increasing the ammonia load with  $\text{NH}_4\text{Cl}$  infusion into the mesenteric vein resulted in hepatic urea output that was greater than the ammonia extracted by the liver, as well as an increase in the oxidation of amino acids ( $^{13}\text{C}$ -leucine), suggesting that amino acids were needed to support ureagenesis. However, the  $\text{NH}_4\text{Cl}$  lowered blood pH, and the observed increases in amino acid oxidation could have been due to mild metabolic acidosis. In another study, Lobley *et al.* (1996) infused  $\text{NH}_4\text{HCO}_3$  into the mesenteric vein of sheep (no metabolic acidosis resulted) and reported no change in leucine oxidation, suggesting that large amounts of amino acid nitrogen were not used for ureagenesis. Additionally, Milano and Lobley (2001) observed reduced hepatic uptake of amino acids in support of urea production when lambs received short-term mesenteric infusions of  $\text{NH}_4\text{HCO}_3$ . However, in that study there was also a reduction in release of amino acids by portal drained viscera such that total splanchnic release of amino acids was reduced by the ammonia treatment.

It should be noted that the studies discussed above focused on the metabolism of nutrients by the liver and did not account for whole body metabolism of nutrients. Also, conclusions based on measures of nutrient flux across hepatic and gastrointestinal tissues must be carefully evaluated due to the innately large variation among animals that makes treatment differences difficult to detect. For example, Milano *et al.* (2000) observed that increases in hepatic urea output exceeded ammonia extraction by 16%, implying that ammonia required use of other nitrogen sources for its detoxification, but due to large variation were forced to conclude that this was not a significant response.

Studies *in vitro* have also yielded a mixed evaluation of the impact of ammonia supply on amino acid catabolism. Luo *et al.* (1995), working with isolated sheep hepatocytes that were incubated with varying levels of  $^{15}\text{NH}_4\text{Cl}$  and amino acids, reported that ammonia was preferentially used by the urea cycle to supply both of the nitrogen sources for the synthesis of urea, and that ammonia detoxification did not necessarily require amino acid nitrogen. However, Mutsvangwa *et al.* (1999) reported, in isolated sheep hepatocytes, that ammonia-stimulated ureagenesis increased the deamination of methionine and tended to increase the deamination of leucine and phenylalanine, suggesting that ammonia-stimulated ureagenesis may require amino acid nitrogen for the synthesis of aspartate.

The effects of amino acid load (via mesenteric vein infusion) on the metabolism of ammonia and amino acids by the liver were examined in cows by Wray-Cahen *et al.* (1997) and in sheep by Lobley *et al.* (1998). In both studies, increases in amino acid load resulted in increases in amino acid extraction and urea production by the liver. However, the proportion of non-essential amino acids (Wray-Cahen *et al.*, 1997) and total amino acids (Lobley *et al.*, 1998) removed by the liver, relative to those appearing in the portal drained blood, decreased with increasing amino acid load. These findings relate to liver metabolism, so the expected, but unmeasured, corollary in these studies would be an increase in the efficiency of amino acid use for anabolic processes.

### Efficiency of Amino Acid Utilization by Growing Ruminants

Growing animals use amino acids absorbed from the small intestine (metabolizable amino acids) primarily for protein deposition in tissues, but not all of the absorbed amino acids are transferred into product proteins. The inefficient use of absorbed amino acids for protein deposition is predominantly due to oxidative losses, although the role of amino acids in other metabolic processes also may have a metabolic cost. Examples include the synthesis of urea from arginine, carnitine from lysine, and polyamines from methionine; the synthesis of non-essential amino acids (e.g. methionine conversion to cysteine); and irreversible post-translational modifications of amino acids (e.g. methylation of histidine residues). Details of these processes are presented in Chapter 4.

Research to evaluate the efficiency with which metabolizable amino acids are used for gain in ruminants has been rather limited. Oldham and Alderman (1982) calculated that the efficiencies for absorbed protein use ranged from 27 to 75% for growth. Using lambs sustained by intragastric infusion of volatile fatty acids, Storm *et al.* (1983) reported that the efficiency with which truly digested rumen microbial protein was used for nitrogen retention was 66%. Rohr and Lebzien (1991) in a review concluded that an average efficiency value of 65% can be assumed for the use of amino acid nitrogen for growth. However, Lobley (1986, 1992) pointed out that the efficiency of absorbed amino acid utilization for gain may vary considerably (40–80%). The NRC (1985) protein model proposed a constant efficiency value of 50% for growth.

In a study with preruminant Holstein bull calves, Gerrits *et al.* (1998) evaluated the efficiency of deposition of all of the essential amino acids from milk proteins. They observed increases in protein deposition in response to increases in protein intake, but the efficiencies of amino acid use for protein deposition were relatively low. Marginal efficiencies (increases in amino acid deposition/increases in amino acid intake)

ranged from 13% for methionine to 22% for threonine in 80- to 160-kg calves and from 16% for tryptophan, isoleucine and phenylalanine to 23% for threonine in calves weighing 160–240 kg. Efficiencies of arginine use were greater (45 and 51% for calves weighing 80–160 and 160–240 kg, respectively) than for the other essential amino acids, reflecting the semi-essential nature of this amino acid. These efficiencies represent minimum values for all except the most limiting amino acid because the denominator in the efficiency calculations is overestimated for non-limiting amino acids. However, all essential amino acids were used with similarly low efficiencies, which suggests that the dietary proteins did not have a greatly imbalanced amino acid profile. Interestingly, efficiencies were not greatly affected by body weight of the calves in this experiment, which is in contrast to predictions by the Cornell Model.

Although the Cornell Model (O'Connor *et al.*, 1993) recognizes that the efficiency with which an individual absorbed amino acid is used for growth is not constant across body weight, a limitation of the model is that it uses the same efficiency factor for growth for all amino acids. Essentially, this is because there are no data available to predict different efficiencies for each of the amino acids. Certainly, there may be inherent differences in the efficiency of use of individual amino acids because of differences in oxidation rates of individual amino acids (Heger and Frydrych, 1989) and differences in the roles of specific amino acids in processes other than protein synthesis (Owens and Pettigrew, 1989). For monogastrics, differences in the efficiency of amino acid use have been observed. Fuller (1994) provides tabular values for the efficiency of use of each of the essential amino acids (excluding histidine and arginine); efficiencies range from 96% for lysine to 64% for tryptophan.

If protein- and energy-dependent growth fully described lean deposition, amino acid requirements for gain would be dependent solely on protein deposition because energy status would not alter the efficiency of amino acid use. Under those conditions, the supply of energy would determine protein deposition and thus amino acid requirements. However,

if energy and protein supplies interact to impact animal performance, assessment of amino acid requirements becomes very difficult because energy supply would alter the efficiency of amino acid use. The latter situation would be suggested by the work of Gerrits *et al.* (1996, 1998), which has addressed this issue more clearly, at least with cattle growing at reasonably high rates, than any other study.

### Assessment of Amino Acid Needs of Growing Cattle

Several factors make straightforward approaches to the study of amino acid utilization by growing ruminants unsatisfactory. For responses to a single amino acid to be measured, that amino acid must be the sole limiting factor. Thus, the amino acid of interest must be deficient, but other nutrients, including other amino acids, must be supplied in adequate or excess amounts. Due to the synthesis of microbial protein in the rumen, it is difficult to supply adequate amounts of energy to the animal without nearly meeting or exceeding the animal's amino acid needs. Also, because the amino acid profile of the ruminal microbial protein is relatively well balanced, no one amino acid is usually much more limiting than the others. Thus, a careful experimental approach is necessary to create a model with a single limiting amino acid.

Furthermore, due to ruminal degradation of proteins and amino acids, the supply of amino acids to a ruminant cannot be changed in a controlled manner simply by adding the amino acid to the diet. Amino acid supplementation must occur through feeding of rumen-protected amino acids or through postruminal (abomasal or duodenal) infusion of the amino acid. Currently, rumen-protected forms of amino acids are only commercially available for methionine and lysine.

When a single amino acid is supplemented, it is possible to determine that it is first-limiting for growth if the animal responds with an increase in protein deposition. However, animal performance will respond only be to the point where another amino acid (or other nutrient, such as energy) limits

performance. Thus, research where only a single amino acid is supplemented is usually less than fruitful in identifying the magnitude of limitation.

Richardson and Hatfield (1978) evaluated the limiting amino acids in ruminal microbial protein for growing Holstein steers. They fed a semipurified diet that was low in true protein and supplemented the cattle with single amino acids. Methionine was determined to be the most limiting amino acid, and, in the presence of supplemental methionine, lysine also was found to be limiting. Although further additions indicated that threonine was third limiting, this conclusion was less than convincing.

Similar approaches have been used by a number of researchers to identify limiting amino acids for growing cattle. Steinacker *et al.* (1970) identified methionine as the first limiting amino acid for steers fed a timothy hay-based diet. For growing steers fed maize-based diets, lysine has been identified as the first limiting amino acid (Hill *et al.*, 1980; Burris *et al.*, 1976). It is perhaps not surprising that maize-based diets were most limiting in lysine, because the maize protein should supply enough methionine to complement this deficiency in microbial protein, but the maize provides little lysine, which also is deficient in microbial protein. This is supported by the work of Hill *et al.* (1980) where steers fed the maize-based diet did not respond to methionine supplementation, even in the presence of adequate supplemental lysine.

In the preruminant calf, ruminal fermentation and the difficulties that it imparts do not exist, so amino acids can be supplied by the diet in studies to assess amino acid requirements. van Weerden and Huisman (1985) conducted the most thorough evaluation of amino acid needs of calves (55–70 kg body weight) fed liquid diets. They fed diets containing 230 g kg<sup>-1</sup> fat with 160 g kg<sup>-1</sup> protein from skim milk powder plus additional essential amino acids in amounts equivalent to what would be provided by 90 g kg<sup>-1</sup> protein from skim milk powder. The amino acid supplements supported N retentions as great as skim milk powder that supplied the same amounts of the essential amino acids. Performance of calves was

generally good with gains of 0.85–1.0 kg day<sup>-1</sup>. Each essential amino acid was singly removed and changes in N balance measured; decreases in N balance indicated that the 160 g kg<sup>-1</sup> protein diet was deficient in that amino acid. The greatest deficiencies were observed for total sulphur amino acids (methionine + cysteine) followed by lysine, isoleucine, threonine and leucine. Subsequently, they quantified the requirement for sulphur amino acids and lysine by feeding graded levels of those amino acids. Gains were optimized when 9.2 g day<sup>-1</sup> total sulphur amino acids (6.8 g day<sup>-1</sup> methionine) and 23 g day<sup>-1</sup> lysine were fed, which corresponded to 7.4 and 18.1 g kg<sup>-1</sup> of the diet, respectively. These estimates probably exceed the true values slightly because they correspond to maximal possible N balance from a quadratic model; breakpoint analysis would yield estimates 5–10% lower. Rough estimates of requirements for the other essential amino acids were also provided by the authors, although the published values for leucine are lower than would be supported by their data. The efficiency of methionine utilization for gain between intakes of 6.9 and 8.0 g day<sup>-1</sup> of total sulphur amino acids was near 30%, and that for lysine utilization between intakes of 16.4 and 19.0 g day<sup>-1</sup> was near 35%.

In a series of studies, Abe *et al.* (1997, 1998, 1999) evaluated amino acid deficiencies in young Holstein calves that were consuming solid feed. The calves were trained to suckle such that amino acid treatments could be fed as liquids and pass, via the reticular groove, directly to the abomasum. These workers did not attempt to quantify the animals' requirements for amino acids, but rather determined which amino acids were limiting. For smaller calves (75 kg body weight) fed maize–soybean meal diets (156 g kg<sup>-1</sup> crude protein), methionine, lysine and tryptophan were marginally deficient (Abe *et al.*, 1998). However, for similar calves fed maize–maize gluten meal diets, lysine was observed to be deficient (Abe *et al.*, 1997). In contrast, larger calves (>150 kg body weight) did not appear to be limited by essential amino acid supply when fed either maize–soybean meal (Abe *et al.*, 1999) or maize–maize gluten meal diets (Abe *et al.*, 1997).

Another approach for studying amino acid utilization by ruminants is the use of intragastric nutrition, where the ruminal microbial population is removed and animals are maintained through ruminal infusions of VFA and abomasal infusions of protein and, in some cases, carbohydrates (Ørskov *et al.*, 1979; MacLeod *et al.*, 1982). Because the microbial population has been removed, the issues surrounding the microbial contribution to metabolizable protein are eliminated. Similarly, the linkage between energy supply and protein supply has been removed. Because the protein (amino acid) supply is directly regulated by the abomasal infusions, it is possible to supply the animal with essentially any profile of amino acids and create a model where any essential amino acid is limiting. Another advantage of this system is that animals adapt very rapidly to postabsorptive changes in nutrient supply, so very short experimental periods can be used. Nitrogen balance typically is used as a measure of protein deposition and can provide valid estimates over the short periods. The disadvantages of this system are that animal performance is usually less than industry standards due to difficulties in infusing large amounts of nutrients while maintaining the health of the animal and its gastrointestinal tract. Also, animals maintained by intragastric nutrition may be physiologically different from normally fed animals. In particular, the intestine of intragastrically maintained animals appears somewhat atrophied, and this could impact amino acid metabolism. The economic costs associated with this technique (labour and infusates) also limit its widespread application, particularly to cattle. However, the approach has been used quite successfully to assess amino acid use in growing sheep (see below) and lactating dairy cows (Fraser *et al.*, 1991).

One huge advantage of using intragastrically maintained animals for amino acid research is that the deletion approach can be utilized. This approach is discussed in some detail by Storm and Ørskov (1984). In essence, all amino acids (as well as other nutrients) are supplied in adequate or excess amounts and then the supply of a single amino acid is reduced. This allows the

researcher to completely characterize the response to the single amino acid under conditions where the animal's response is not dictated by the supply of other limiting nutrients.

The deletion approach to evaluating amino acid utilization also has been applied to growing ruminants fed normal diets. Herein, cattle are fed a limited amount of a diet such that ruminal fermentation results in a less than optimal amount of amino acids reaching the small intestine. The cattle are then supplemented with energy (VFA infused ruminally and glucose infused abomasally) to ensure that the animal is limited by protein. Mixtures of amino acids are then supplied post-ruminally to exceed the animals' requirements for all of the amino acids except the one of interest. Graded amounts of the test amino acid are supplied, and N balance is used as an estimator of protein deposition. With this model, stark methionine deficiencies have been generated, and increases in N balance are easily measured when methionine is supplemented (Titgemeyer and Merchen, 1990; Campbell *et al.*, 1996, 1997; Froidmont *et al.*, 2000). Data can be used to calculate the efficiency of methionine utilization or to calculate the requirement for methionine at the point where animal performance is maximized. Similar models have been developed for the study of lysine and histidine (Greenwood and Titgemeyer, 2000) and of leucine and valine (Löest *et al.*, 2001), but have not yet been used in the study of those amino acids.

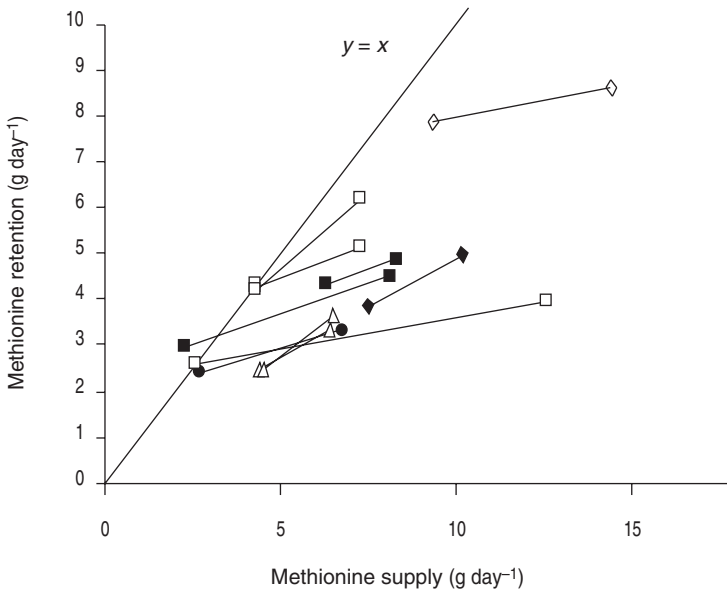
Methionine has been the most studied of the amino acids because it is first-limiting in microbial protein for growing cattle (Richardson and Hatfield, 1978) and because total sulphur amino acids also tend to be low in a number of protein sources fed to cattle (Titgemeyer *et al.*, 1989). The efficiency of protein utilization by animals is limited by the supply of the first-limiting amino acid as well as the efficiency of use of amino acids as a whole.

Using the deletion technique, the efficiency of methionine utilization in growing cattle (incremental increases in methionine deposition, based on N retention, divided by the incremental increase in methionine supply) has ranged from 14% to 66%. Figure 18.3 shows N balance in unsupplemented and methionine-supplemented steers using

the deletion approach. The left-most point of each line in Fig. 18.3 represents the unsupplemented steers and the right-most point a value for steers receiving an amount of methionine less than or equal to that capable of yielding maximal N retention. Thus, each line represents a portion of the linear response surface for cattle demonstrating a methionine-dependent phase of growth. The slopes of the lines can be used to calculate efficiency of methionine use for gain.

A number of points should be made regarding Fig. 18.3. In all cases where more than two methionine levels were tested, N balance responses to methionine were linear. Retained methionine was calculated from nitrogen retention as: Met retained = N retention  $\times$  6.25  $\times$  0.02, which accounts for the conversion of N into protein (6.25) and the methionine content of whole body protein (0.02). The line for  $y = x$  would correspond to 100% efficiency of methionine use. Points to the left of this line would indicate that the animal deposited more methionine than was absorbed, clearly an impossibility for an essential amino acid. This is probably accounted for by slight overestimation of protein deposition by N retention. Also, if the efficiency of methionine use is constant across all levels of gain, then these lines could be extrapolated to a methionine retention of zero, and the methionine intake at the point of zero methionine retention would correspond to the maintenance requirement. For most of the studies presented in Fig. 18.3, this would yield a negative maintenance requirement, which again is impossible. This may be a result of either the overestimation of protein deposition by N balance and/or a higher efficiency of methionine use at intakes of methionine below those evaluated in these experiments.

These studies on methionine utilization based on the deletion technique (Fig. 18.3) represent a set with relatively standardized methods. With the exception of two studies (Titgemeyer and Merchen, 1990; Froidmont *et al.*, 2000), these experiments were conducted with lightweight (132–205 kg) Holstein steers. Froidmont *et al.* (2000) used larger (315 kg) double-musled Belgian Blue bulls, and this accounts for the higher overall level of methionine retention. However, it is clear

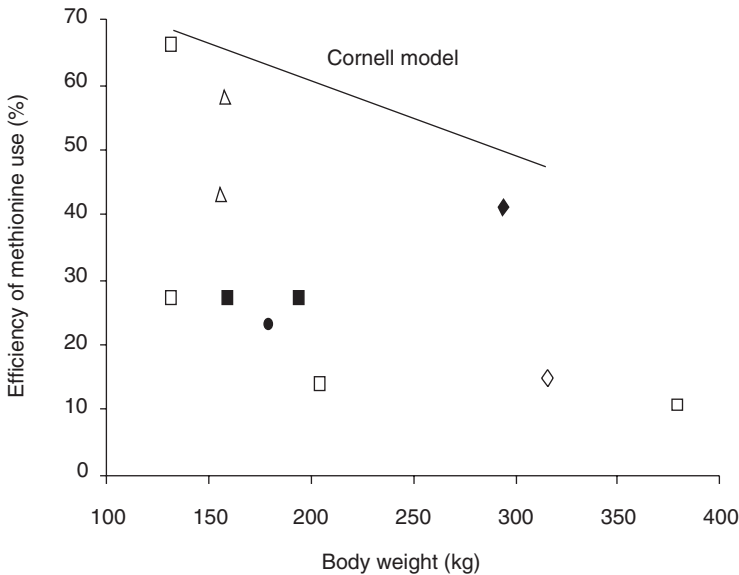


**Fig. 18.3.** Responses of growing cattle to incremental increases in methionine supply. Methionine retention was calculated as N retention  $\times$  6.25  $\times$  0.02, which accounts for the conversion of N into protein (6.25) and the methionine content of whole body protein (0.02). The  $y = x$  line corresponds to 100% efficiency in the utilization of methionine for protein deposition. The slopes of each individual line are the efficiencies of use of the supplemental methionine. References for the studies and the observed efficiencies are: ◆, Titgemeyer and Merchen (1990), 41%; ●, Campbell *et al.* (1996), 23%; ■, Campbell *et al.* (1997), 27% for both lines; △, Löest (1999), 43% and 58%; ◇, Froidmont *et al.* (2000), 15%; □, Lambert (2001), 14%, 27% and 66%.

from Fig. 18.4 that factors beyond body weight are influencing the efficiency of methionine use for gain. Although the largest cattle (Froidmont *et al.*, 2000) had relatively low efficiencies (Fig. 18.4), there was not a strong relationship between body weight and efficiency. Taken as a whole, these studies would suggest that methionine is used less efficiently for gain than predicted by the Cornell Model (68–47% for cattle weighing 132–315 kg; Ainslie *et al.*, 1993) and that maintenance requirements for methionine are lower than predicted by the Cornell Model. Whether these relationships would be true for other amino acids is unclear; there simply are not enough empirical measures available to make that determination.

Another factor to consider regarding the utilization of methionine is the transsulphuration pathway and the use of methionine as a source of cysteine (see Chapter 8). In monogastric animals, cysteine can be used to meet

about half of the total sulphur amino acid requirement, and cysteine supplied in amounts less than the cysteine requirement can spare the animal's need for methionine. Thus, the total sulphur amino acid requirement is often considered as a sum of the needs for methionine plus cysteine where the cysteine supply is less than half of this total. However, in cattle, supplemental cysteine has not been found to effectively spare methionine (Campbell *et al.*, 1997). Initial suggestions were that methionine's use in metabolic pathways other than protein synthesis (e.g. methyl donation) may be important in explaining this discrepancy, although studies with a similar model (Löest, 1999) did not observe any sparing of methionine by betaine or choline, methyl group sources. Regardless of the reason, the lack of sparing of methionine by cysteine in cattle suggests that the methionine requirement should be considered independent of the cysteine supply.



**Fig. 18.4.** Plot of observed efficiencies of utilization of supplemental methionine as related to body weight. Key to symbols is as for Fig. 18.3. The line for the Cornell model provides estimates from Ainslie *et al.* (1993).

Growth assays with cattle fed diets supplying various amounts of metabolizable protein also have been used to assess amino acid utilization. As a general rule, growth is reflective of protein deposition because lean represents a large portion of the total weight gain by the animal. Fat deposition accounts for a large portion of energy deposited, but because it is energy dense and has little water associated with it, it does not alter weight gain as dramatically as protein. Wilkerson *et al.* (1993) summarized a number of growth assays in which cattle responded to supplementation with metabolizable protein by increasing their growth rate. The individual studies used basal diets containing little true protein, and the microbial protein supply was insufficient to meet the animal's needs (i.e. cattle fed only the basal diets were deficient in metabolizable protein). Across studies, weight gain was regressed on metabolizable protein supply. Maintenance requirements of 253 kg steers for metabolizable protein were estimated as 242 g day<sup>-1</sup>, and for each kg of gain the cattle required 305 g of additional metabolizable protein. Assuming that gain for cattle in these trials contained 150 g kg<sup>-1</sup> protein, the effi-

ciency of use of metabolizable protein for gain was 49%. These authors also provided estimates of requirements for individual amino acids, which were calculated as the lowest supply of the amino acid, across diets containing different protein sources, that yielded maximum gains. However, these can be considered as only maximal estimates because the supplies of all amino acids were altered by the supplementation of intact protein sources and it is impossible to know which amino acid(s) were supplied in excess and which ones were actually limiting. Additionally, in these experiments there was a strong correlation between energy supply and metabolizable protein supply because protein supply was heavily dependent on ruminal microbial protein synthesis. Thus, the relationship between metabolizable protein supply and gain may have been influenced by energy intake.

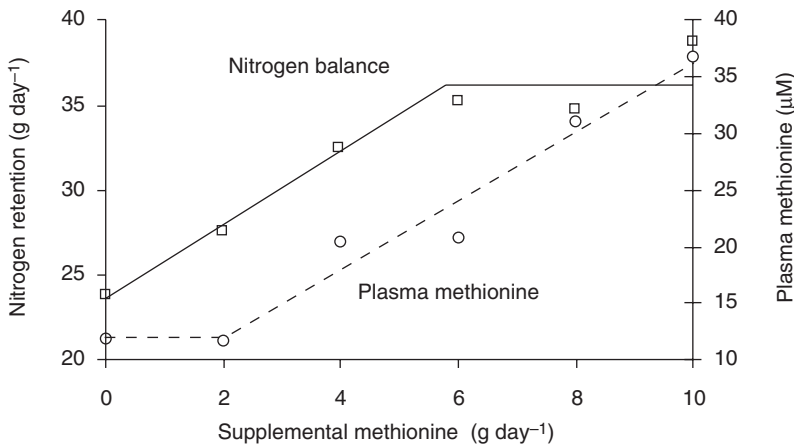
Using growth assays similar to those described above, Klemesrud *et al.* (2000a) evaluated the methionine and lysine requirements of growing steers. To evaluate methionine requirements, all steers were supplemented with meat and bone meal, which contains low amounts of methionine, to ensure that only



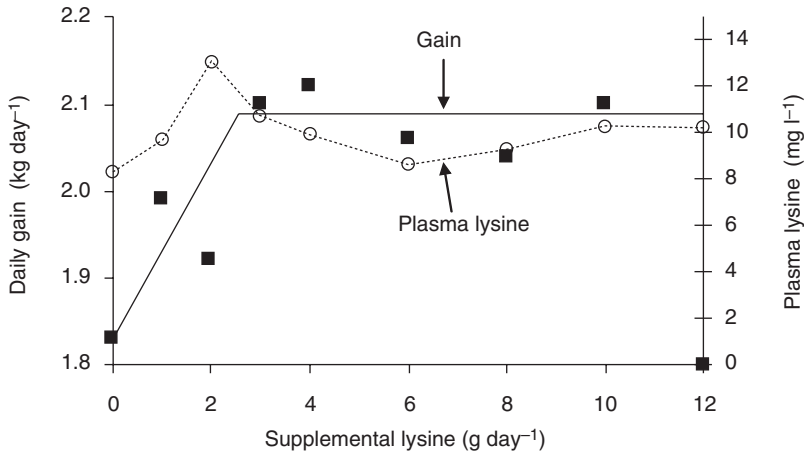
methionine limited performance. Graded levels of rumen-protected methionine were then supplemented. Growth of 251 kg steers was maximal ( $0.39 \text{ kg day}^{-1}$ ) when  $2.9 \text{ g day}^{-1}$  methionine was supplemented (total supply =  $11.6 \text{ g day}^{-1}$ ). Similarly, to evaluate lysine requirements, all steers were supplemented with maize gluten meal, which contains low amounts of lysine, to ensure that only lysine limited performance. Graded levels of rumen-protected lysine were then supplemented. Growth of 210 kg steers was maximal ( $0.56 \text{ kg day}^{-1}$ ) when  $0.9 \text{ g day}^{-1}$  lysine was supplemented (total supply =  $22.5 \text{ g day}^{-1}$ ). The impact of growth rate on amino acid needs can be demonstrated by comparing the study by Klemesrud *et al.* (2000a) to that by Klemesrud *et al.* (2000b). In the latter study, steers (237 kg) were fed maize-based diets which allowed for much greater gains. During the initial 56 days of the growth assay, daily gains increased in response to supplemental rumen-protected lysine, with the maximal gain of  $2.10 \text{ kg day}^{-1}$  occurring when supplemental lysine supply was  $2.6 \text{ g day}^{-1}$  and total lysine supply was  $40.5 \text{ g day}^{-1}$ . The much greater requirement for the more rapidly growing steers ( $40.5 \text{ vs. } 22.5 \text{ g day}^{-1}$ ) demonstrates the energetic limitation on gain in the study by Klemesrud *et al.* (2000a) such that maximal protein deposition and, subsequently, amino acid requirements were lower.

Concentrations of plasma amino acids in response to supplementation of graded levels of a supplemental amino acid also have been used to determine animal requirements. The concentration of an amino acid in blood should remain low and relatively constant when its supply is less than its requirement and then increase in concentration when the supply is above the animal's need (Bergen, 1979). Thus, the breakpoint can be used as an estimate of the animal's requirement. There are several disadvantages to this technique. It provides an estimate of the animal's requirement, but there is no clear measure of the performance level that corresponds to that requirement. More importantly, the procedure does not always yield estimates that match those based on measures of lean deposition (N balance, Campbell *et al.*, 1997, Fig. 18.5; growth rate, Klemesrud *et al.*, 2000b, Fig. 18.6).

Several additional points should be made with reference to the use of plasma amino acids for assessing animal requirements. The use of plasma amino acid profiles in response to supplementation of mixtures of amino acids is unwise, because many factors are altered simultaneously and it is never clear if the plasma responses relate to the supply of the amino acid being investigated or to changes in the supply of other amino acids (either due to changes in protein deposition or amino acid



**Fig. 18.5.** Nitrogen retention and plasma methionine as functions of supplemental methionine in calves (Campbell *et al.*, 1997). The requirement was estimated to be  $5.8 \text{ g day}^{-1}$  supplemental methionine based on nitrogen balance, but only  $2.0 \text{ g day}^{-1}$  based on plasma methionine responses.



**Fig. 18.6.** Daily gain and plasma lysine as functions of supplemental lysine in calves (Klemesrud *et al.*, 2000b). Growth data are from the first 56 days of the trial, and blood samples were collected at the midpoint of this period. The requirement was estimated to be 2.6 g day<sup>-1</sup> supplemental lysine based on gain, but plasma lysine concentrations did not demonstrate a pattern that could be used for prediction of animal requirements.

metabolism). Also, the isomeric form of the supplemental amino acid is important. Although the unnatural D-isomer of methionine can be used efficiently by growing calves for protein deposition (Campbell *et al.*, 1996), it leads to higher concentrations of plasma methionine than does the natural L-methionine (Titgemeyer and Merchen, 1990; Campbell *et al.*, 1996). Presumably, similar relationships would exist for isomers of other amino acids.

### Amino Acid Utilization by Sheep

Amino acid utilization by growing sheep is somewhat more difficult to assess than that by cattle because the impact of wool growth must be considered. Wool production represents an irreversible loss of amino acids which might otherwise be used for tissue deposition. Additionally, wool contains a high concentration of cysteine, and, as such, its production requires a large amount of sulphur amino acids, either as cysteine directly or as methionine for the production of cysteine.

In a classic experiment, Storm and Ørskov (1984) determined which amino acids were most limiting in ruminal microbial protein for growing lambs. The intragastrically maintained sheep were supplied with isolated ruminal

microbial protein and an amino acid mixture supplying an additional 25% of all of the essential amino acids in the same profile as in microbial protein. Individual amino acids were subsequently removed from the supplement. The primary advantage of this deletion approach is that responses could be measured to individual amino acids under conditions where other essential amino acids were not limiting. The most limiting amino acid in microbial protein for growing lambs was clearly methionine, and lysine, histidine and arginine were also found to be among the limiting amino acids. Using a similar approach, Storm *et al.* (1983) reported that the efficiency with which truly digested rumen microbial protein was used for nitrogen retention was 66%. Clearly, this efficiency of use of microbial N for growth would have been increased by supplementation with those amino acids found to be limiting. However, there are concerns that amino acid use is greater for intragastrically maintained lambs than normally fed sheep due to changes in the gut as a result of the intragastric nutrition. In contrast to the efficiency of 66% observed by Storm *et al.* (1983) for intragastrically maintained lambs, MacRae *et al.* (1995) observed efficiencies of use of total essential amino acids of 50–59% in lambs fed forage or a forage and barley diet.

A number of earlier studies considered which amino acids were most limiting for growing lambs. Schelling and Hatfield (1968) observed that lambs fed a purified diet containing no true protein (580 g kg<sup>-1</sup> maize-starch, 300 g kg<sup>-1</sup> cellulose, 43 g kg<sup>-1</sup> urea) were most limited by the supply of lysine. In contrast, subsequent work with lambs fed a similar diet indicated that methionine was the most limiting amino acid (Nimrick *et al.*, 1970a). The conclusion that methionine was more limiting than lysine was supported by additional studies to quantify the methionine requirement (Nimrick *et al.*, 1970b). Similarly, for lambs fed diets containing maize and hay, methionine was observed to be the most limiting amino acid (Schelling *et al.*, 1973). Several points should be noted with regard to these studies. First, the lambs had relatively low growth rates; based on N retention, lambs probably had body weight gains of less than 100 g day<sup>-1</sup>. Second, the efficiency of utilization of the supplemental methionine (increase in methionine deposition/amount of methionine supplemented) by the lambs was low, being less than 20% based on the improvements in N retention and expected methionine content of the gain. Third, in some of these studies, improvements in N retention were observed when glutamate was supplemented, which suggests that non-specific N was limiting; therefore, glutamate was supplemented to lambs in some of the studies to ensure that its deficiency did not limit performance.

More recent work with growing lambs (Matras *et al.*, 2000) determined if methionine and/or lysine was limiting when lambs were fed barley-based diets or diets based on maize and maize gluten meal. Nitrogen retention was improved about equally by supplementation with lysine or methionine, with responses being greater for lambs fed the maize-based diets. However, responses to methionine and lysine in combination were not greater than those to either of the amino acids alone. Thus, it is not clear which amino acid was most limiting or why additive or synergistic responses were not observed if they were essentially co-limiting. As in the earlier studies, growth rates of lambs were low in this study.

Numerous studies have demonstrated that

sulphur amino acids generally are most limiting for wool growth by mature sheep fed forage-based diets (Bird and Moir, 1972; Reis *et al.*, 1973; Doyle, 1981; Liu *et al.*, 2000). Wool contains much higher concentrations of cysteine (98 g kg<sup>-1</sup> amino acids) than of methionine (6 g kg<sup>-1</sup> amino acids) (MacRae *et al.*, 1993), which suggests that cysteine would be physiologically more important than methionine for improving wool growth. However, methionine is capable of supplying cysteine via transsulphuration, which in sheep can occur in various tissues including the skin (Chapter 17; Liu *et al.*, 2000).

Recently, Liu and Masters (2000) developed a model to predict the methionine and cysteine requirements of sheep. Although the model focuses on wool growth, several important aspects relevant to growth are delineated. For methionine, requirements were set as the amount deposited in wool and in body proteins plus the amount oxidized. Methionine oxidation was predicted as a function of whole-body methionine flux, which was set as a function of metabolizable protein intake. Cysteine requirements were similarly estimated except production of cysteine from methionine via transsulphuration was subtracted from the amount of absorbed cysteine required. Transsulphuration of methionine to cysteine was estimated as a function of methionine flux. This model provides an excellent initial step in predicting animal requirements and does an excellent job of delineating some of the factors that will impact amino acid utilization. The model appeared to be quite sensitive to the estimation of oxidation, which reflects either the sensitivity of the model to this estimate or the inability of the model to predict oxidation with precision. The sensitivity of the model to estimates of oxidation would be expected because absorbed methionine would either be oxidized or deposited in either wool or the body. The partitioning of protein deposition between wool and fleece-free body also appeared to be an important consideration in the prediction of allowable wool growth. With regard to amino acid availability for growth, the model points out the issue of prioritization of use. The model calculates that for sheep experiencing no change in body protein, 0.42 g day<sup>-1</sup> of wool will be produced, and that

additional gains in protein deposition will be divided with 31% occurring in the fleece and 69% in the fleece-free body. If this partitioning truly occurs, it would set definite limits on the efficiency of amino acid use for tissue growth. The impact of this partitioning on efficiency of use of different amino acids would depend on the relative concentrations of the amino acid in wool and body proteins, but clearly would be important for methionine utilization due to the high cysteine concentrations in wool.

The model of Liu and Masters (2000) also addresses issues relevant to amino acid oxidation, which is the primary feature that impacts the efficiency of amino acid use. Oxidation is a function of the amino acid flux, which in turn is dependent on dietary protein intake. Thus, high producing animals (i.e. those absorbing large amounts of amino acids) will have a large portion of the amino acids oxidized and, consequently, low efficiencies of amino acid use. Thus, efficiency of amino acid use is not a constant value. One apparent flaw in the model is that all cysteine produced from transsulphuration is assumed to contribute to whole-body cysteine flux, and, consequently, increases in transsulphuration lead to increases in cysteine oxidation. In sheep, a large portion of transsulphuration appears to occur in the skin with utilization of the resultant cysteine prior to its entry into the whole-body cysteine pool. The authors suggest that future modifications to the model will address this issue.

## Conclusions

At the present time, knowledge about amino acid utilization by ruminants is lacking. Our lack of knowledge arises primarily because

ruminal fermentation intervenes between the diet and the small intestine such that research on the topic is difficult and expensive. From one perspective, our lack of understanding has few practical consequences because the ruminal fermentation ensures that amino acid supply is rarely limiting under most current agricultural practices.

Methionine is the most limiting amino acid in microbial protein for both growing cattle and sheep and, consequently, it has been studied more than the other amino acids. Methionine appears to be used relatively inefficiently for growth by cattle and sheep. In cattle, this has been attributed to its importance as a methyl group donor, whereas in sheep its role as a precursor for cysteine synthesis may be more important. Future work is needed to validate these conclusions.

The study of amino acid utilization by ruminants may yield future rewards as production systems change. Leaner animals with greater capacity for protein deposition may have amino acid requirements that exceed the supply from typical diets. Certainly, the responsiveness of cattle fed grass silages to supplementation with sources of ruminally undegradable protein (Veira *et al.*, 1988; Nelson, 1997) would suggest that amino acid deficiencies are probable when diets contain little true protein. Identification of factors that influence amino acid utilization should improve models to predict amino acid use by ruminants.

## Acknowledgements

Contribution No. 02-225-B, Kansas Agric. Exp. Stn., Manhattan, KS 66506, USA.

## References

- Abe, M., Iriki, T. and Funaba, M. (1997) Lysine deficiency in postweaned calves fed corn and corn gluten meal diets. *Journal of Animal Science* 75, 1974-1982.
- Abe, M., Iriki, T., Funaba, M. and Onda, S. (1998) Limiting amino acids for a corn and soybean meal diet in weaned calves less than three months of age. *Journal of Animal Science* 76, 628-636.
- Abe, M., Yamazaki, K., Kasahara, K., Iriki, T., Kuriyama, R. and Funaba, M. (1999) Absence of limiting amino acids in calves fed a corn and soybean meal diet past three months of age. *Journal of Animal Science* 77, 769-779.

- Ainslie, S.J., Fox, D.G., Perry, T.C., Ketchen, D.J. and Barry, M.C. (1993) Predicting amino acid adequacy of diets fed to Holstein steers. *Journal of Animal Science* 71, 1312–1319.
- Asplund, J.M. (1994) The influence of energy on amino acid supply and utilization in the ruminant. In: Asplund, J.M. (ed.) *Principles of Protein Nutrition of Ruminants*. CRC Press, Boca Raton, Florida, pp. 179–186.
- Bergen, W.G. (1979) Free amino acids in blood of ruminants – physiological and nutritional regulation. *Journal of Animal Science* 49, 1577–1589.
- Bird, P.R. and Moir, R.J. (1972) Sulphur metabolism and excretion studies in ruminants. VIII. Methionine degradation and utilization in sheep when infused into the rumen or abomasum. *Australian Journal of Biological Science* 25, 835–848.
- Burris, W.R., Boling, J.A., Bradley, N.W. and Young, A.W. (1976) Abomasal lysine infusion in steers fed a urea supplemented diet. *Journal of Animal Science* 42, 699–705.
- Campbell, C.G., Titgemeyer, E.C. and St-Jean, G. (1996) Efficiency of D- vs. L-methionine utilization by growing steers. *Journal of Animal Science* 74, 2482–2487.
- Campbell, C.G., Titgemeyer, E.C. and St-Jean, G. (1997) Sulfur amino acid utilization by growing steers. *Journal of Animal Science* 75, 230–238.
- Campbell, R.G., Taverner, M.R. and Curic, D.M. (1985) The influence of feeding level on the protein requirement of pigs between 20 and 45 kg live weight. *Animal Production* 40, 489–496.
- Doyle, P.T. (1981) Sulfur and methionine metabolism in sheep. V. Utilization of methionine isomers. *Australian Journal of Biological Science* 34, 47–59.
- Fraser, D. L., Ørskov, E.R., Whitelaw, F.G. and Franklin, M.F. (1991) Limiting amino acids in dairy cows given casein as the sole source of protein. *Livestock Production Science* 28, 235–252.
- Froidmont, E., Beckers, Y. and Thewis, A. (2000) Determination of the methionine requirement of growing double-musled Belgian Blue bulls with a three-step method. *Journal of Animal Science* 78, 233–241.
- Fuller, M.F. (1994) Amino acid requirements for maintenance, body protein accretion and reproduction in pigs. In: D'Mello, J.P.F. (ed.) *Amino Acids in Farm Animal Nutrition*. CAB International, Wallingford, UK, pp. 155–184.
- Gerrits, W.J.J., Tolman, G.H., Schrama, J.W., Tamminga, S., Bosch, M.W. and Verstegen, M.W.A. (1996) Effect of protein and protein-free energy intake on protein and fat deposition rates in preruminant calves of 80 to 240 kg live weight. *Journal of Animal Science* 74, 2129–2139.
- Gerrits, W.J.J., Schrama, J.W. and Tamminga, S. (1998) The marginal efficiency of utilization of all ileal digestible indispensable amino acids for protein gain is lower than 30% in preruminant calves between 80 and 240 kg live weight. *Journal of Nutrition* 128, 1774–1785.
- Greenwood, R.H. and Titgemeyer, E.C. (2000) Limiting amino acids for growing Holstein steers limit-fed soybean hull-based diets. *Journal of Animal Science* 78, 1997–2004.
- Heger, J. and Frydrych, Z. (1989) Efficiency of utilization of amino acids. In: Friedman, M. (ed.) *Absorption and Utilization of Amino Acids*. CRC Press, Boca Raton, Florida, pp. 31–56.
- Hill, G.M., Boling, J.A. and Bradley, N.W. (1980) Postruminal lysine and methionine infusion in steers fed a urea-supplemented diet adequate in sulfur. *Journal of Dairy Science* 63, 1242–1247.
- Hovell, F.D.DeB., Ørskov, E.R., MacLeod, N.A. and McDonald, I. (1983) The effect of changes in the amount of energy infused as volatile fatty acids on the nitrogen retention and creatinine excretion of lambs wholly nourished by intragastric infusion. *British Journal of Nutrition* 50, 331–343.
- Huntington, G.B. (1989) Hepatic urea synthesis and site and rate of removal from blood of beef steers fed alfalfa or a high concentrate diet. *Canadian Journal of Animal Science* 69, 215–223.
- INRA. (1989) *Ruminant Nutrition*. John Libbey Eurotext, Montrouge, France.
- Klemesrud, M.J., Klopfenstein, T.J. and Lewis, A.J. (2000a) Metabolizable methionine and lysine requirements of growing cattle. *Journal of Animal Science* 78, 199–206.
- Klemesrud, M.J., Klopfenstein, T.J., Stock, R.A., Lewis, A.J. and Herold, D.W. (2000b) Effect of dietary concentration of metabolizable lysine on finishing cattle performance. *Journal of Animal Science* 78, 1060–1066.
- Lambert, B.D. (2001) Methionine metabolism in growing cattle. PhD thesis, Kansas State University, Manhattan.
- Lindberg, J.E., and Jacobsson, K.G. (1990) Nitrogen and purine metabolism at varying energy and protein supplies in sheep sustained on intragastric infusion. *British Journal of Nutrition* 64, 359–370.
- Liu, S.M. and Masters, D.G. (2000) Quantitative analysis of methionine and cysteine requirements for wool production of sheep. *Animal Science* 71, 175–185.

- Liu, S.M., Mata, G., Figliomeni, S., Powell, B.C., Nesci, A. and Masters, D.G. (2000) Transsulfuration, protein synthesis rate and follicle mRNA in the skin of young Merino lambs in response to infusions of methionine and serine. *British Journal of Nutrition* 83, 401–409.
- Lobley, G.E. (1986) The physiological bases of nutrient response; growth and fattening. *Proceedings of the Nutrition Society* 45, 203–214.
- Lobley, G.E. (1992) Control of the metabolic fate of amino acids in ruminants: a review. *Journal of Animal Science* 70, 3264–3275.
- Lobley, G.E., Connell, A., Lomax, M.A., Brown, D.S., Milne, E., Calder, A.G. and Farningham, D.A.H. (1995) Hepatic detoxification of ammonia in the ovine liver: possible consequences for amino acid catabolism. *British Journal of Nutrition* 73, 667–685.
- Lobley, G.E., Weijs, P.J.M., Connell, A., Calder, A.G., Brown, D.S. and Milne, E. (1996) The fate of absorbed and exogenous ammonia as influenced by forage or forage-concentrate diets in growing sheep. *British Journal of Nutrition* 76, 231–248.
- Lobley, G.E., Bremner, D.M., Nieto, R., Obitsu, T., Moore, A.H. and Brown, D.S. (1998) Transfers of N metabolites across the ovine liver in response to short-term infusions of an amino acid mixture into the mesenteric vein. *British Journal of Nutrition* 80, 371–379.
- Löest, C.A. (1999) Methionine and betaine for growing and finishing cattle. PhD thesis. Kansas State University, Manhattan.
- Löest, C.A., Titgemeyer, E.C., Lambert, B.D. and Trater, A.M. (2001) Branched-chain amino acids for growing cattle limit-fed soybean hull-based diets. *Journal of Animal Science* 79, 2747–2753.
- Luo, Q.J., Maltby, S.A., Lobley, G.E., Calder, A.G. and Lomax, M.A. (1995) The effect of amino acids on the metabolic fate of  $^{15}\text{NH}_4\text{Cl}$  in isolated sheep hepatocytes. *European Journal Biochemistry* 228, 912–917.
- MacLeod, N., Corrigan, W., Stirton, R.A. and Ørskov, E.R. (1982) Intragastric infusion of nutrients in cattle. *British Journal of Nutrition* 47, 547–553.
- MacRae, J.C., Walker, A., Brown, D. and Lobley, G.E. (1993) Accretion of total protein and individual amino acids by organs and tissues of growing lambs and the ability of nitrogen balance techniques to quantitate protein retention. *Animal Production* 57, 237–245.
- MacRae, J.C., Bruce, L.A. and Brown, D.S. (1995) Efficiency of utilization of absorbed amino acids in growing lambs given forage and forage:barley diets. *Animal Science* 61, 277–284.
- Matras, J., Preston, R.L. and Bartle, S.J. (2000) Influence of continuous intravenous lysine and methionine infusion on N balance in growing sheep fed diets that differ in ruminal degradable protein. *Journal of Animal and Feed Science* 9, 81–89.
- Milano, G.D. and Lobley, G.E. (2001) Liver nitrogen movements during short-term infusion of high levels of ammonia into the mesenteric vein of sheep. *British Journal of Nutrition* 86, 507–513.
- Milano, G.D., Hotston-Moore, A. and Lobley, G.E. (2000) Influence of hepatic ammonia removal on ureagenesis, amino acid utilization and energy metabolism in the ovine liver. *British Journal of Nutrition* 83, 307–315.
- Mutsvangwa, T., Buchanan-Smith, J.G. and McBride, B.W. (1999) Effects of *in vitro* addition of ammonia on the metabolism of  $^{15}\text{N}$ -labelled amino acids in isolated sheep hepatocytes. *Canadian Journal of Animal Science* 79, 321–326.
- NRC (1985) *Ruminant Nitrogen Usage*. National Academy Press, Washington, DC.
- Nelson, M.L. (1997) Escape protein supplementation of steers fed grass silage-based diets. *Journal of Animal Science* 75, 2796–2802.
- Nimrick, K., Hatfield, E.E., Kaminski, J. and Owens, F.N. (1970a) Qualitative assessment of supplemental amino acid needs for growing lambs fed urea as the sole nitrogen source. *Journal of Nutrition* 100, 1293–1300.
- Nimrick, K., Hatfield, E.E., Kaminski, J. and Owens, F.N. (1970b) Quantitative assessment of supplemental amino acid needs for growing lambs fed urea as the sole nitrogen source. *Journal of Nutrition* 100, 1301–1306.
- O'Connor, J.D., Sniffen, C.J., Fox, D.G. and Chalupa, W. (1993) A net carbohydrate and protein system for evaluating cattle diets: IV. Predicting amino acid adequacy. *Journal of Animal Science* 71, 1298–1311.
- Oldham, J.D. and Alderman, G. (1982) Recent advances in understanding protein–energy interrelationships in intermediary metabolism of ruminants. In: *Protein and Energy Supply for High Production of Milk and Meat*. Pergamon Press, Oxford, UK, pp. 33–63.
- Ørskov, E.R., Grubb, D.A., Wenham, G. and Corrigan, W. (1979) The sustenance of growing and fattening ruminants by intragastric infusion of volatile fatty acid and protein. *British Journal of Nutrition* 41, 553–559.

- Ørskov, E.R., Meehan, D.E., MacLeod, N.A. and Kyle, D.J. (1999) Effect of glucose supply on fasting nitrogen excretion and effect of level and type of volatile fatty acid infusion on response to protein infusion in cattle. *British Journal of Nutrition* 81, 389–393.
- Owens, F.N. and Pettigrew, J.E. (1989) Subdividing amino acid requirements into portions for maintenance and growth. In: Friedman, M. (ed.) *Absorption and Utilization of Amino Acids*. CRC Press, Boca Raton, Florida, pp. 15–30.
- Reis, P.J., Tunks, D.A. and Downes, A.M. (1973) The influence of abomasal and intravenous supplements of sulphur-containing amino acids on wool growth rate. *Australian Journal of Biological Science* 26, 249–258.
- Reynolds, C.K. (1992) Metabolism of nitrogenous compounds by ruminant liver. *Journal of Nutrition* 122, 850–854.
- Reynolds, C.K., Tyrrell, H.F. and Reynolds, P.J. (1991) Effects of diet forage-to-concentrate ratio and intake on energy metabolism in growing beef heifers: net nutrient metabolism by visceral tissues. *Journal of Nutrition* 121, 1004–1015.
- Richardson, C.R. and Hatfield, E.E. (1978) The limiting amino acids in growing cattle. *Journal of Animal Science* 46, 740–745.
- Rohr, K. and Lebzién, P. (1991) Present knowledge of amino acid requirements for maintenance and production. In: Eggum, B.O., Boisen, S., Borsting, C., Danfaer, A. and Hvelplund, T. (eds) *Protein Metabolism and Nutrition*. EAAP Publication No. 59, NIAS, Foulum, Denmark, pp. 127–137.
- Schelling, G.T. and Hatfield, E.E. (1968) Effect of abomasally infused nitrogen sources on nitrogen retention of growing lambs. *Journal of Nutrition* 96, 319–326.
- Schelling, G.T., Chandler, J.E. and Scott, G.C. (1973) Post-ruminal supplemental methionine infusion to sheep fed high quality diets. *Journal of Animal Science* 37, 1034–1039.
- Steinacker, G., Devlin, T.J. and Ingalls, J.R. (1970) Effect of methionine supplementation posterior to the rumen on nitrogen utilization and sulfur balance of steers on a high roughage ration. *Canadian Journal of Animal Science* 50, 319–324.
- Storm, E., and Ørskov, E.R. (1984) The nutritive value of rumen micro-organisms in ruminants. 4. The limiting amino acids of microbial protein in growing sheep determined by a new approach. *British Journal of Nutrition* 52, 613–620.
- Storm, E., Ørskov, E.R. and Smart, R. (1983) The nutritive value of rumen micro-organisms in ruminants 2. The apparent digestibility and net utilization of microbial N for growing lambs. *British Journal of Nutrition* 50, 471–478.
- Titgemeyer, E.C. and Merchen, N.R. (1990) Sulfur-containing amino acid requirement of rapidly growing steers. *Journal of Animal Science* 68, 2075–2083.
- Titgemeyer, E.C., Merchen, N.R. and Berger, L.L. (1989) Evaluation of soybean meal, corn gluten meal, blood meal and fish meal as sources of nitrogen and amino acids absorbed from the small intestine of steers. *Journal of Animal Science* 67, 262–275.
- van Weerden, E.J. and Huisman, J. (1985) Amino acid requirement of the young veal calf. *Zeitschrift für Tierphysiologie, Tierernährung und Futtermittelkunde* 53, 232–244.
- Veira, D.M., Proulx, J.G., Butler, G. and Fortin, A. (1988) Utilization of grass silage by cattle: further observations on the effect of fishmeal. *Canadian Journal of Animal Science* 68, 1225–1235.
- Wilkerson, V.A., Klopfenstein, T.J., Britton, R.A., Stock, R.A. and Miller, P.S. (1993) Metabolizable protein and amino acid requirements of growing cattle. *Journal of Animal Science* 71, 2777–2784.
- Wray-Cahen, D., Metcalf, J.A., Backwell, F.R.C., Bequette, B.J., Brown, D.S., Sutton, J.D. and Lobley, G.E. (1997) Hepatic response to increased exogenous supply of plasma amino acids by infusion into the mesenteric vein of Holstein-Friesian cows in late gestation. *British Journal of Nutrition* 78, 913–930.

# 19 Mammary Uptake and Metabolism of Amino Acids by Lactating Ruminants

**B.J. Bequette<sup>1\*</sup>, M.D. Hanigan<sup>2</sup> and H. Lapierre<sup>3</sup>**

<sup>1</sup>*Department of Animal and Avian Sciences, University of Maryland, College Park, Maryland, USA;* <sup>2</sup>*Dairy Research Group, Purina Mills Inc., St Louis, Missouri, USA;*

<sup>3</sup>*Dairy and Swine R&D Research Centre, Lennoxville, Quebec, Canada*

---

## Introduction

Maximizing milk production has been the primary goal of the dairy industry for many years. In recent years, the shift in the milk-marketing sector towards a milk component pricing structure and the health concerns of the public, have placed greater emphasis on producing milk with a high protein:fat ratio, i.e. designer milk. At the same time, increased environmental concerns over possible contamination of the soil, waterways and air with nitrogen from manure has pressured the industry to devise ways of reducing nitrogen wastes. The lactating dairy cow is not particularly efficient at converting dietary nitrogen into milk nitrogen using current management schemes (Table 19.1). Balancing the goals of environmental stewardship and maximum milk production with desirable composition has proved to be a challenge. Most in the industry feel that these goals can be accomplished through diet manipulation by assuring that there is sufficient energy, and a proper pattern and supply of amino acids (AA). Although balancing diets for individual AA has been in place for decades in poultry and pig production, the information needed for such an achievement is not yet available in rumi-

nant nutrition. The large variety of feedstuffs used, combined with the complex remodelling by the rumen microflora of nutrients ingested, has made it a challenge to adequately predict availability of nutrient flows to the duodenum of ruminants, precluding a precise definition of AA requirements.

Each AA is an individual entity that is required as such to synthesize proteins, yet requirements are still expressed as 'metabolizable' protein (MP), i.e. an aggregate of AA. Requirements take into account the nitrogen demands of the lactating animal for maintenance, including urinary endogenous, scurf and metabolic faecal losses. The term also considers nitrogen for productive processes such as for conceptus and tissue growth and lactation. In the NRC (2001) guidelines, the digestible essential AA component of MP derives from a rumen sub model. Although the utilization of MP rather than crude protein (CP) is an improvement to prediction schemes, the lack of consistent observations of responses to AA supplementation may reflect the inaccuracies in these schemes (Kohn *et al.*, 1998). One feature of present schemes that may account for some of the inaccuracy is the use of a fixed efficiency (0.65–0.85 depending on the feeding scheme) for converting

\*E-mail address: bbequett@wam.umd.edu



**Table 19.1.** Efficiency of conversion of dietary crude protein to product crude protein by commercial animal species under typical US management conditions.

Production animal	Production (yield, gain)	Protein intake (g day <sup>-1</sup> )	Protein produced (g day <sup>-1</sup> )	Conversion %
Lactating dairy cow <sup>a</sup>	35 kg day <sup>-1</sup>	4230	1085	26
Growing beef <sup>b</sup>	1.36 kg day <sup>-1</sup>	1033	270	26
Growing pig <sup>c</sup>	325 g day <sup>-1</sup>	387	127	33
Growing broiler <sup>d</sup>	47.8 g day <sup>-1</sup>	19.3	8.59	45
Egg production <sup>e</sup>	300 eggs year <sup>-1</sup>	17.5	6.03	34

<sup>a</sup>31 g kg<sup>-1</sup> milk protein, 23.5 kg dry matter intake day<sup>-1</sup>, 180 g dietary crude protein (CP) kg<sup>-1</sup>.

<sup>b</sup>300 kg body weight, liveweight gain comprised of 180 g CP kg<sup>-1</sup>, 8.2 kg dry matter intake day<sup>-1</sup>, 126.1 g dietary crude protein kg<sup>-1</sup> (NRC, 2000).

<sup>c</sup>50 kg body weight, 2.5 kg dry matter intake day<sup>-1</sup>, 155 g dietary CP kg<sup>-1</sup> (NRC, 1998).

<sup>d</sup>0–7 weeks of age, mixed sex, 92 g feed intake day<sup>-1</sup>, 210 g dietary CP kg<sup>-1</sup> (North and Bell, 1990), liveweight gain comprising 180 g CP kg<sup>-1</sup>.

<sup>e</sup>300 eggs year<sup>-1</sup>, 7.25 g crude protein egg<sup>-1</sup> (Fisher, 1994), 103 g feed intake day<sup>-1</sup>, 170 g dietary CP kg<sup>-1</sup> (North and Bell, 1990).

absorbed protein into milk protein. Postabsorptive metabolism of AA is essentially considered an inflexible 'black box'. Based on recent research, the NRC (2001) proposed a refinement to the MP model and, based upon empirically derived dose–response relationships, the amounts of lysine and methionine required in MP to optimize milk protein production are estimated. The ratio of 3:1 is regarded as the optimal ratio of lysine to methionine in MP. This adjustment is an improvement over previous schemes; however, it inherently limits the usefulness of the scheme to diets where lysine and methionine are limiting (e.g. maize-based diets). For example, the scheme would be less accurate when grass silage diets are fed and where histidine appears to be first-limiting (Vanhatalo *et al.*, 1999). Additionally, there appears to be some flexibility in mammary transport systems with respect to AA use (Hanigan *et al.*, 2001a, 2002). Ideally, models of AA requirements should represent this flexibility and more essential AA. Current models generally require the user to specify the desired level of production (INRA, 1989; AFRC, 1993; NRC, 2001). This constraint limits the models' ability to predict maximal levels of production from unlimited inputs. Increasing model complexity must be carefully considered, however, to ensure that the desired level of accuracy is achieved with the minimal amount of added complexity.

In the last 20 years, there has been considerable research aimed at developing mechanistic models of postabsorptive metabolism (Waghorn and Baldwin, 1984; Baldwin *et al.*, 1987; Danfaer, 1994; Hanigan and Baldwin, 1994; Maas *et al.*, 1997; Cherepanov *et al.*, 2000; Hanigan *et al.*, 2001b). In theory, these efforts should complement rumen-based modelling efforts such that resulting models are better able to predict the pattern and supply of AA and energy substrates required to optimize milk protein synthesis by the mammary gland. This chapter will examine the current state of knowledge of AA metabolism in lactating ruminants (dairy cows and goats), the metabolic adaptations in tissue protein and AA metabolism that affect the quality and quantity of AA reaching the mammary gland, and current attempts to model these events, particularly at the level of the mammary gland.

### The Lactational Drive

From 2 weeks precalving to 3 weeks postcalving, dry matter intake increases from 12 to 21 kg day<sup>-1</sup>. During this period, daily milk production can increase to over 50 kg in well-managed herds. The drive to synthesize milk is tremendous, placing enormous metabolic and physiological demands on the cow. For example, protein mass of the mammary gland

increases 100-fold and the tissues of the splanchnic bed (rumen, small and large intestines, liver) increase 11–28% in mass prior to and soon after parturition. This remodelling process can only be achieved through major shifts in the metabolic priorities of the parturient cow. To maintain systemic balance, metabolic activity in other tissues must be reduced (downregulated) to allow preferential partition of absorbed nutrients to the mammary glands. Bauman and Currie (1980) coined the term homeorhesis to describe coordination of these metabolic processes. From a few days prior to parturition to the first 4–6 weeks of lactation, the new metabolic demand imposes a new partition of AA from dietary and tissue protein stores. Thus, while activity of the mammary gland increases, protein synthesis in carcass, head, and feet decrease by 18–21% (Champredon *et al.*, 1990). In high-producing cows, the situation is exacerbated, as protein intake is less than the demands for milk protein output. The shortfall is made up through mobilization of tissue protein stores. On a daily basis, these stores can contribute from 90 to 430 g of AA in dairy cows (Gibb *et al.*, 1992; Komaragiri and Erdman, 1997) and from 2 to 66 g of AA in dairy goats (Barnes and Brown, 1990). This is equivalent to an extra 13 and 2 kg milk day<sup>-1</sup> (maximally, assuming 100% conversion to milk protein), respectively. Low versus high genetic merit cows differ in the proportion of endogenous reserves contributing to the pool of carbon for casein synthesis with high merit cows deriving

a greater amount (35 vs. 25%) from reserves, and for a longer period of lactation, than low genetic merit cows (Wilson *et al.*, 1988). In later lactation, however, tissue sensitivity and substrate supply are altered such that the lactating animal begins to repartition dietary AA to replete the protein stores, essentially the equivalent amount of protein mobilized in early lactation. As the extent of protein mobilization changes throughout lactation and is influenced by genetic make-up, the quality and quantity of the AA required for milk protein synthesis will also vary. Future feeding schemes will need to consider these metabolic adaptations and genetic differences when setting guidelines for the balance of AA required from MP.

## Amino Acid Availability

### Absorptive metabolism

In ruminants, the pattern of AA in the proteins arriving at the duodenum differ substantially from the dietary proteins ingested due to extensive degradation and synthesis in the rumen by bacteria and protozoa (Table 19.2). One might predict that the ability to increase milk protein yield would be a simple function of matching duodenal supply of individual AA with that required for milk synthesis. This can be achieved either by increasing the microbial protein synthesis and rumen outflow or by feeding rumen undegradable proteins that have a balanced AA composition with respect

**Table 19.2.** Profile (%) of essential amino acids in milk, rumen bacteria and protozoa, and plant and animal feed proteins. (Adapted from NRC, 2001.)

Amino acid	Milk	Rumen bacteria	Rumen protozoa	Maize gluten meal	Soybean meal	Fishmeal
Arginine	7.2	10.4	9.3	7.1	16.2	13.1
Histidine	5.5	4.2	3.6	4.7	6.1	6.4
Isoleucine	11.4	11.6	12.7	9.1	10.1	9.2
Leucine	19.5	15.9	15.8	37.2	17.2	16.2
Lysine	16.0	16.6	20.6	3.7	13.9	17.2
Methionine	5.5	5.1	4.2	5.2	3.2	6.3
Phenylalanine	10.0	10.1	10.7	14.1	11.6	9.0
Threonine	8.9	11.4	10.5	7.5	8.7	9.4
Tryptophan	3.0	2.7	2.8	1.2	2.8	2.4
Valine	13.0	12.4	9.7	10.3	10.2	10.8

to milk protein. Although simple, this concept implies two major assumptions. First, that the duodenal flow of AA is adequately predicted. The flow of AA to the duodenum is a complex mixture of microbial protein, rumen undegradable feed proteins and endogenous proteins (NRC, 2001). Recent schemes have been refined to provide duodenal flow of essential AA (CNCPS, 2000; NRC, 2001). However, the accuracy of such predictions is critically dependent on knowledge of the chemical composition of dietary ingredients, which is usually not available on a regular basis. The second assumption is that the AA profile at the site of absorption reflects the profile delivered to the mammary gland. As we will demonstrate below, this is almost never the case.

In the first instance, the AA profile of intestinal outflow is altered, even before reaching the blood circulation. During passage across the intestinal wall, AA can be incorporated into intestinal proteins (constitutive or secretions) or catabolized by the tissues. In addition, bacteria in the small intestine can degrade them. Although the gastrointestinal tract comprises only 4–8% of whole body protein mass, protein synthesis by these tissues accounts for 20–35% of whole body protein synthesis in ruminants (Lobley *et al.*, 1980; Lapierre *et al.*, 1999). In growing sheep, small intestinal use of luminal-derived essential AA for protein synthesis and catabolism ranges from 17% for valine to 39% for histidine (MacRae *et al.*, 1997a). Total use of AA by the whole gut is even greater with more than 80% of essential AA (except phenylalanine and histidine) derived from the blood circulation (MacRae *et al.*, 1997a). Does this high activity lead to catabolism of AA across the gut wall and reduce net supply of AA to other tissues? For non-essential AA, there are clear indications that catabolism occurs across the gut wall. Stoll *et al.* (1999) calculated that 70% of the CO<sub>2</sub> produced by the pig gut was derived from oxidation of AA, primarily from glutamate, glutamine and aspartate. Negative net fluxes across the mesenteric-drained viscera would also indicate substantial catabolism of glutamine in sheep (Gate *et al.*, 1999), and of aspartate and glutamate in dairy cows (Berthiaume *et al.*, 2001).

Is there any indication that the gut oxidizes essential AA? Direct measurements of AA catabolism across the ruminant gut are scarce. In ruminants, catabolism of most of the essential AA is believed to be restricted mainly to the liver and kidney, except for the branched-chain AA (isoleucine, leucine and valine) for which the catabolic enzymes are widely distributed in ruminant tissues (Goodwin *et al.*, 1987). Measurement of AA oxidation by the gut of dairy cows has been limited to leucine, and here 16–24% of absorbed leucine was oxidized (Lapierre *et al.*, 1999). Preliminary data in growing sheep indicate that gut oxidation of lysine, methionine, and phenylalanine accounted for 29%, 7% and 5%, respectively, of whole body oxidation of these AA (Lobley and Lapierre, 2001). Those estimates were based on measurement of arterial-derived AA and did not include an estimate of oxidation of AA derived from the gut lumen (i.e. during absorption). In the pig, oxidation of systemic (arterial) lysine and threonine are negligible, although there was catabolism of luminal-derived lysine that accounted for 30% of whole-body lysine oxidation (van Goudoever *et al.*, 2000).

In addition to these direct measurements, some clues to AA metabolism across the gut can be gleaned by interpretation of the ratio of AA disappearing from the small intestine (difference between ileal and duodenal flows) to that appearing from the mesenteric-drained viscera (MDV: blood draining only the small intestine) and from the portal-drained viscera (PDV: draining the whole gut). The gastrointestinal vascular drainage system in ruminants is complex, however, and this may give rise to a confused picture of AA catabolism when the disappearance across the small intestine and mesenteric or portal fluxes are measured in isolation. Only a few studies are available where these have been measured simultaneously (e.g. sheep, MacRae *et al.*, 1997b; dairy cows, Berthiaume *et al.*, 2001). In both species, recoveries in the MDV of most essential AA (EAA) disappearing from the small intestines are close to 100% or even greater (Table 19.3). Those data seemed to suggest that catabolism of AA across the intestine wall did not occur. However, substantial secretions from the pancreas and gall bladder (bile) are secreted into the small intestines beyond

**Table 19.3.** Relative net fluxes of amino acids across the mesenteric-drained viscera (MDV), the portal-drained viscera (PDV) and small intestinal disappearance (SID) in sheep and dairy cows.

Amino acid	Sheep <sup>a</sup>		Dairy cow <sup>b</sup>	
	MDV:SID	PDV:MDV	MDV:SID	PDV:MDV
Histidine	–	–	1.27	0.75
Isoleucine	1.11	0.55	1.02	0.61
Leucine	1.02	0.64	0.92	0.68
Lysine	1.03	0.56	0.76	0.72
Methionine	–	–	1.01	0.66
Phenylalanine	1.12	0.68	1.00	0.76
Threonine	0.85	0.69	1.15	0.38
Valine	0.76	0.57	1.11	0.46

<sup>a</sup>From MacRae *et al.* (1997b).

<sup>b</sup>From Berthiaume *et al.* (2001).

cannula placement and are reabsorbed before reaching the ileum. This will not affect net apparent disappearance in the small intestine, but as the AA necessary for this purpose are partly extracted from the non-MDV blood supply, these endogenous secretions will add 'extra' AA to the MDV net flux. Therefore, the high recovery of AA into the MDV relative to small intestinal disappearance does not suggest, but would not preclude, any catabolism of AA across the small intestine.

Further information can be gained from the ratio of AA flows at the PDV (a mix of MDV flow and those from the forestomachs and hind gut) compared to the MDV (only the small intestines). The net flows of AA from the PDV average only 55–75% of MDV flows (Table 19.3; Seal and Parker, 1996; MacRae *et al.*, 1997b; Berthiaume *et al.*, 2001). There are two possible explanations for this apparent loss of EAA from the MDV to the PDV. The first involves catabolism of EAA by the digestive tissues, excluding the small intestines, and the second involves a complex loop of endogenous protein secretion and reabsorption. The limited data seem to suggest that most EAA, with the exception of the branched-chained AA and perhaps lysine (Lobley and Lapierre, 2001), are not oxidized across the ruminant gut. On the other hand, endogenous secretions measured at the duodenum, originating from saliva, gastric juices and sloughed off epithelial cells (Tamminga *et al.*, 1995), represent 15–25% of duodenal

nitrogen flow (Larsen *et al.*, 2000; Ouellet *et al.*, 2002). These secretions, therefore, could account for a large fraction of the 'apparent loss' of AA (25–45%) between the PDV and MDV net fluxes.

Does this flow of endogenous protein into the gut lumen result in preferential net use (loss) of specific AA? When the relative disappearance of essential AA across the small intestines was compared with PDV appearance in dairy cows, there were proportionally greater losses of valine and threonine (Berthiaume *et al.*, 2001). Similarly, numerical decreases have been observed for threonine and valine in sheep (Remond *et al.*, 2000). In cattle fed grass pellets, threonine represented a lower proportion (relative to leucine) in both the MDV and the PDV net appearances when compared to rumen microbial protein (Seal and Parker, 1996). Intestinal secretions are dominated by mucopolysaccharides, which are rich in threonine and valine (Mukkur *et al.*, 1985). Mucins tend to be poorly reabsorbed (Tamminga *et al.*, 1995), thus further distorting the pattern of essential AA available to the animal.

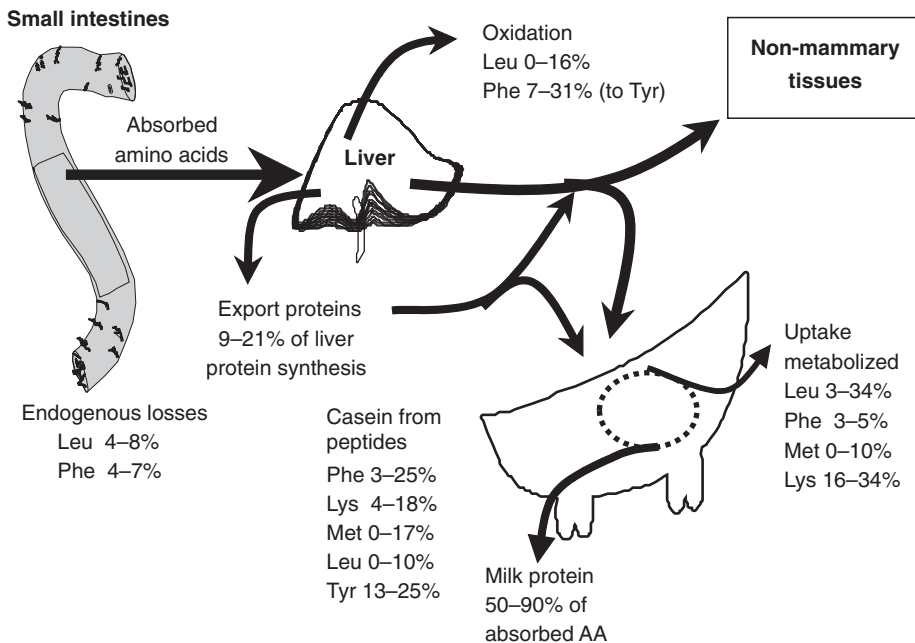
It is clear that gut metabolism has a significant impact on the availability of non-essential AA to the animal. The situation is less clear for essential AA, although catabolism of certain AA (including branched-chain AA) cannot be ignored nor the impact of endogenous secretions on the pattern of AA supplied into blood circulation.

### Hepatic metabolism

Having traversed the complexity of the gut, AA absorbed into the portal vein flow to the liver where they may be subjected to further metabolism. The liver is equally metabolically active as the gut, accounting for 25% of whole body oxygen consumption, even though the liver represents only 2% of body weight (Huntington and Reynolds, 1987). In dairy cows, up to 2000 l h<sup>-1</sup> of blood passes through the liver (Reynolds *et al.*, 1988). The liver serves a critical role in maintaining AA homeostasis and in the detoxification of large quantities of ammonia absorbed from the gut. There are three options when AA are presented to the liver (Fig. 19.1). First, AA may pass through directly and become available to peripheral tissues. Second, AA may be extracted for synthesis of proteins, constitutive of liver matrix or exported as plasma proteins. Or, third, AA may be oxidized with the nitro-

gen potentially lost as urea. These three metabolic functions must be coordinated in such a way that the supply of AA to peripheral tissues is adequate, yet AA concentrations in plasma do not rise to toxic levels. The complexity of this process, so vital for maintaining metabolic plasticity, may come at a price that might involve obligatory losses through hepatic oxidation.

There have been a limited number of studies on hepatic AA removal in dairy cows. In dairy cows, and in ruminants in general, the amounts removed, in both absolute and proportional terms, vary widely across studies. In one of the first studies in dairy cows (32 kg milk day<sup>-1</sup>), Reynolds *et al.* (1988) estimated that the liver removed 42% of total AA absorbed from the PDV (measured as  $\alpha$ -amino-N). Based on measurement of individual AA, Berthiaume (2000) estimated in cows producing 33 kg milk day<sup>-1</sup> that the liver removed 23% of the absorbed AA and in



**Fig. 19.1.** Summary of studies in lactating dairy cows and goats where the metabolic fates and partitioning of amino acids were monitored by tracer kinetics *in vivo*. Data taken from studies in lactating goats (Oddy *et al.*, 1988; Bequette *et al.*, 1994, 1996a, 1999, 2002; Backwell *et al.*, 1996; Lee *et al.*, 1996; Mabweesh *et al.*, 2000) and cows (Bequette *et al.*, 1996b; France *et al.*, 1999; Larsen *et al.*, 2000; Reynolds *et al.*, 2000, 2001). Abbreviations: AA, amino acids; Leu, leucine; Lys, lysine; Met, methionine; Phe, phenylalanine; Tyr, tyrosine.

cows producing 16.8 kg milk day<sup>-1</sup> Blouin *et al.* (2002) observed that the liver removed 34%. For essential AA, although rates of removal vary from study to study, there are some common features. For example, only a small proportion (0–30%) of absorbed branched-chain AA (leucine, valine and isoleucine) is removed across the liver in non-lactating cows whereas in lactating cows there is a net liver release of these (Table 19.4). Catabolism of the branched-chain AA occurs in two steps with, in ruminants, transamination occurring mainly in non-hepatic tissues and oxidation of the corresponding keto-acid occurring mainly in the liver (Fig. 19.1). Lobley (1992) suggested that this division of branched-chain AA (particularly leucine) catabolism might allow them to act as signals of nutrient intake and adequacy through coordination of nutrient- and hormone-mediated peripheral tissue protein turnover. In contrast to the branched-chain AA, the liver removes substantial amounts of absorbed histidine, methionine and phenylalanine, both in lactating and non-lactating dairy cows (Table 19.4). Removal of AA by the liver, however, does not equate to oxidation. Synthesis of plasma proteins may reach 155 g day<sup>-1</sup> in the dairy cow, representing 10–20% of hepatic removal of phenylalanine (Raggio *et al.*, 2002). Unfortunately, due to technical constraints, the metabolic fate of the liver export proteins and whether these serve as nutrient

vehicles to specific tissues has yet to be determined. It is very likely that they are significant sources of AA for protein synthesis. For example, uptake of plasma proteins by the mammary gland may account for the short-falls in blood free AA uptake by the gland of histidine and phenylalanine (see below).

On average, liver extraction of non-essential AA is higher than for essential AA, and this higher extraction is related to the metabolic functions of some non-essential AA. For example, glutamine and alanine are used by the liver for gluconeogenesis and they act as shuttles of NH<sub>3</sub> and amino groups between peripheral tissues and the liver (Bergman and Pell, 1985).

Although regulation of hepatic removal and oxidation of AA is still not understood, there must be coordination between the demand by peripheral tissues and hepatic removal of AA. For example, abomasal infusion of casein in steers increased the hepatic removal of AA whereas concomitant administration of somatotropin increased N retention in peripheral tissues by decreasing hepatic removal of AA (Bruckental *et al.*, 1997). A similar relationship exists when comparing the non-lactating versus the lactating dairy cow. Hepatic removal of AA is much lower in lactating cows (Berthiaume, 2000; Blouin *et al.*, 2002) whereas in non-lactating cows (Wray-Cahen *et al.*, 1997; Table 19.4) removal is much higher. The control of hepatic removal

**Table 19.4.** Proportion of net portal absorption of amino acids removed by the liver in non-lactating and lactating dairy cows.

Amino acid	Non-lactating cows <sup>a</sup>	Lactating cow <sup>b</sup>
Histidine	0.57	0.28
Isoleucine	0.41	n.r. <sup>c</sup>
Leucine	0.01	n.r. <sup>c</sup>
Lysine	0.16	0.06 <sup>d</sup>
Methionine	0.70	0.43
Phenylalanine	0.67	0.50
Threonine	0.72	0.11
Valine	0.12	n.r. <sup>c</sup>

<sup>a</sup>From Wray-Cahen *et al.* (1997), basal periods.

<sup>b</sup>From Blouin *et al.* (2002) and Berthiaume (2000).

<sup>c</sup>Net removal by the liver zero.

<sup>d</sup>Data only from Blouin *et al.* (2002).

of essential AA seems to be under tight control because the postliver supply of histidine, methionine, and phenylalanine is nearly equal to their net mammary uptake and secretion into milk protein (Lobley and Lapierre, 2001). Catabolism of these AA is believed to occur mainly in the liver (see Fig. 19.1 for phenylalanine), but the question still remains: Does the liver extract AA in excess of peripheral needs or does the mammary gland use what is left-over by the liver, i.e. is it a 'push' or a 'pull' mechanism?

Many questions still need to be answered with regards to AA metabolism across the liver, but one thing is certain, hepatic metabolism differs greatly among AA and it alters both the quantity and the profile of AA delivered to the peripheral tissues, including the mammary gland.

### Amino Acid Supply and Mammary Uptake

If one accepts the view that non-mammary use of AA is a function of mammary use, then it becomes critical to understand what regulates mammary removal and use. Net removal of AA by the udder has often been correlated with arterial concentrations of AA (e.g. Hanigan *et al.*, 1992; Guinard and Rulquin, 1994). However, this relation has not always been observed. For example, when dairy cows were fed three levels of crude protein and where milk protein yield increased by 50 g day<sup>-1</sup> (Metcalf *et al.*, 1996), mammary uptakes of only lysine and valine increased, despite the fact that concentrations of most essential AA, except for methionine, phenylalanine and threonine, were increased by infusion.

The intragastric infusion studies of Rulquin and colleagues are among the few studies that have allowed a comparison of the partition and utilization by the mammary gland of controlled known rates of AA supply. Total removal of essential AA by the mammary gland increased in response to incremental duodenal infusions of casein, although marginal removals of the essential AA declined from 0.81 of the casein infused at the lowest rate to 0.50 at the highest level of infusion (Guinard and Rulquin, 1994). The

efficiency of converting the extracted essential AA into milk protein was also reduced considerably (from 0.88 to 0.49) with nearly all AA extracted far in excess of net requirements for milk protein synthesis. These observations underscore the importance of understanding the mechanisms regulating AA metabolism by mammary secretory cells.

### Mammary amino acid transport systems

The AA transporters expressed by mammary tissue do not appear to be unique to the organ (Baumrucker, 1984, 1985). Although mammary transporters have not all been completely characterized in bovine mammary tissue, they have been characterized in other species (see Shennan, 1998) or in other cell types (see Christensen, 1990). These transporters exhibit saturation kinetics; however there is a non-saturable component that is thought to represent diffusion. Maximal velocity of the saturable element is achieved at concentrations that greatly exceed the *in vivo* range such that within the normal *in vivo* concentration range uptake kinetics are generally linear. Transport of AA under normal physiological conditions, therefore, would appear to be limited by substrate concentration and transporter capacity. That is, a change in either the number of transporters (or the activity of expressed transporters) or in the concentration of AA at the cell surface should result in a corresponding change in unidirectional removal of the AA.

Transport of AA across the cell membrane is bi-directional (Baumrucker, 1984, 1985). Efflux from mammary tissue (cells) appears to be driven by intracellular concentrations (Bequette *et al.*, 2000) although this has not been well examined *in vivo*. If influx and efflux rates are concentration dependent, then fluctuations in intracellular and extracellular concentrations modulate net transport. It has also been observed that transport activity is regulated by intracellular concentration of AA (Christensen, 1990), possibly through regulation of protein translation by uncharged tRNA (Iiboshi *et al.*, 1999). This mechanism potentially provides a link between the rate of intracellular milk protein synthesis and regulation of AA uptake.

In mammary tissues, AA are concentrated within the intracellular pool relative to the plasma compartment (Clark *et al.*, 1980). An energy source is required to establish and maintain this concentration gradient. Several transporters use Na<sup>+</sup> as an exchange molecule, taking advantage of the concentration gradient of Na<sup>+</sup> maintained by Na<sup>+</sup>/K<sup>+</sup>-ATPase activity (Baumrucker, 1985). The L-system, in turn, takes advantage of the AA concentration gradient maintained by the Na<sup>+</sup>-transporters by counterexchanging intracellular AA for extracellular AA (for review see Baumrucker, 1985). As each transporter generally has affinity for more than one AA, there is potential for antagonism among AA wherein elevated concentrations of one AA inhibit transport of other AA. However, most AA can be transported by more than one transporter (Baumrucker, 1985; Shennan, 1998), and so this potential antagonism is probably partially negated. Additionally, it would seem that the ability to regulate transporter activity and the presence of multiple transporter types would tend to mitigate not only antagonisms but also deficiencies in a single AA (Bequette *et al.*, 2000).

## Mammary metabolism of amino acids

### *Precursors for milk protein synthesis*

The arteriovenous net balance technique has been used to monitor mammary uptake of AA. The ratio of AA removal to milk protein secretion has been used to indicate limiting AA. Based on this comparison, it would appear that valine, leucine, isoleucine, arginine, lysine and threonine are not limiting since their extractions generally exceed milk protein outputs. *In vivo* data have demonstrated that leucine and lysine, which are extracted in excess, can be oxidized by the udder (Fig. 19.1; Oddy *et al.*, 1988; Bequette *et al.*, 1996a,b; Mabweesh *et al.*, 2000). Thus, a portion of the carbon arising from these AA is unavailable for synthesis of non-essential AA, which for the most part are not extracted in adequate quantities. The amino-group is largely available and appears to be adequate or nearly adequate to cover non-

essential AA synthesis (Hanigan and Baldwin, 1994; Hanigan *et al.*, 2001b). By contrast, phenylalanine, methionine, threonine and histidine have been consistently observed to be extracted in amounts less than milk protein outputs (Mephram, 1982; Guinard and Rulquin, 1994; Metcalf *et al.*, 1996; Bequette *et al.*, 1999). Early observations by Mephram and Linzell (1966) and Bickerstaffe *et al.* (1974) suggested that circulating blood free AA were the principal sources of AA for casein synthesis. More recently, however, studies *in vivo* and *in vitro* seem to support the view that the deficiency of free AA uptake is made-up from extraction of non-free AA sources (i.e. peptides or proteins: Backwell *et al.*, 1994; Bequette *et al.*, 1994, 1999).

Despite the simplicity of the net uptake to milk output measurement, there are compounding errors associated with measurement of mammary blood flow, arteriovenous concentration differences and milk protein output (for reviews see Mephram, 1982; Bequette *et al.*, 1998) that add variability to the mammary balance data. In order to reduce these errors and acquire more reliable estimates of free AA removal by the mammary gland, the arteriovenous difference methodology has been improved (Bequette *et al.*, 1999; Mabweesh *et al.*, 2000). These authors surgically ligated venous and arterial vessels that may contribute non-mammary derived AA, and blood was withdrawn as integrated samples over 1-hour periods to coincide with the integrated milk protein yield and blood flow measurements. Even when these measures were applied, net uptake of methionine and phenylalanine were less than required.

Direct quantification of peptides in the circulation has proved difficult to assess. Crude methodologies have been employed based on deproteinization of plasma, molecular-weight exclusion followed by acid hydrolysis of the resulting peptide fractions, and comparison of the plasma free and liberated AA contents. These techniques are limited in accuracy and reproducibility, and require very sensitive quantification of AA by ion-exchange or other AA analysis instrumentation (i.e. 1–3 µM arteriovenous difference). By using this technique, the arteriovenous difference across the mammary gland of AA in the plasma pep-



tide fraction (<1500 Da) was found to be positive and small for histidine, alanine, leucine, proline and phenylalanine (Backwell *et al.*, 1996). More compelling evidence derives from studies *in vitro* where replacement of free lysine or methionine with peptides containing these AA either maintained or increased milk protein synthesis by cultured mouse mammary tissue explants (Wang *et al.*, 1994, 1996; Pan *et al.*, 1996).

Stable isotope-labelling techniques have also been used to indirectly demonstrate that the mammary gland *in vivo* can use synthetic dipeptides for casein synthesis (Backwell *et al.*, 1994) and that the contribution of peptides to casein synthesis is probably significant (Bequette *et al.*, 1994, 1999; Backwell *et al.*, 1996; Mabeesh *et al.*, 2000). By infusing  $^{13}\text{C}$ -labelled glycyphenylalanine and glycy-leucine close-arterial to the mammary gland of goats, Backwell *et al.* (1994) found greater (10–20%) incorporation of phenylalanine and leucine derived from the dipeptides than from the peripherally infused free form of the AA. By employing the precursor–product labelling methodology in lactating goats (days 45–253), peptides were found to contribute 0–20% of phenylalanine, 13–25% of tyrosine, and 0–18% of methionine in casein (Fig. 19.1, Bequette *et al.*, 1994, 1999; Backwell *et al.*, 1996). Peptides were also found to contribute to the uptakes of lysine (4–16%) and variable (0–15%) amounts to leucine (Mabeesh *et al.*, 2000), which seems surprising since these AA are almost always extracted in excess. Chen *et al.* (1999) measured the mRNA abundance of the peptide transporter PepT1 in tissues from lactating cows and, although the sheep probe hybridized to mRNA in the gastrointestinal tissues, no hybridization occurred in the mammary gland. However, close inspection of the data from Backwell *et al.* (1994) suggests that the peptides may have also been hydrolysed at the cell surface to free AA prior to uptake. This mechanism appears to be compatible with amino-peptidase N expression in mammary tissue of lactating goats (Mabeesh *et al.*, 2001). Future research will need to examine peptide use by the udder in more detail to determine whether peptide use is a significant physiological phenomenon, and one that can be manipulated to increase milk protein synthesis.

### *Metabolism and roles of amino acids*

It has long-been recognized that the mammary gland is a site of extensive synthesis and degradation of AA. Tracer studies with the perfused mammary gland (Verbeke *et al.*, 1968, 1972; Roets *et al.*, 1974), tissue explants and cell culture systems (Jorgensen and Larson, 1968) have been instrumental in identifying many of the metabolic transformations of AA. These pathways are the same, or very similar, to pathways that occur in other tissues. However, these may be more prominent for the mammary gland with net uptake of non-essential AA by the udder far less than required for milk protein synthesis, compared to muscle tissue where a stoichiometric relationship mostly exists. In recent years, a wider range of radio- and stable-isotope labelled AA has become available at an affordable price, which has led to a number of metabolic studies on the lactating cow and goat mammary gland *in vivo* (see Fig. 19.1). Traditionally, AA and their metabolism have been categorized according to the balance between net arteriovenous uptake and milk casein-AA output. Excess uptake is assumed to represent catabolism, and, for this reason, those AA taken up in excess are usually not considered to be limiting for milk protein synthesis. This point has also been argued on the basis that the  $K_m$  values for activation of acyl-tRNA synthetases are 100-fold lower than those for catabolic enzymes ( $1 \times 10^{-6}$  vs.  $1 \times 10^{-4}$ ; Rogers, 1976) and, therefore, catabolism should only proceed once the acyl-tRNA have become fully charged (DePeters and Cant, 1992). This argument assumes that none of the products of AA catabolism serve as rate-limiting substrates or regulators for protein synthesis. It also assumes homogeneity of intracellular concentrations, particularly at the sites of tRNA loading and AA degradation, which may not be the case.

Leucine, valine, and isoleucine are catabolized by mammary cells along pathways found in other tissues to yield organic acids (keto and iso acids, propionate, acetate and citrate), carbon skeletons for non-essential AA synthesis, and  $\text{CO}_2$  (Chapter 4). The first reaction of the branched-chain AA catabolic

pathway involves transamination (Fig. 4.13). Substantial transamination of branched-chain AA occurs in the mammary gland of the goat where reamination of the keto acid represents 20–50% of leucine (Bequette *et al.*, 2002) and 10% of valine (Roets *et al.*, 1974) flux. In theory, the supply of these AA to the udder can be supplemented by removal of the branched-chain keto acids from blood; however, net fluxes of the keto acid of leucine represent <3% of leucine net flux (Bequette *et al.*, 1996b). The second, rate-limiting step is decarboxylation of the respective keto acid, catalysed by the branched-chain keto acid dehydrogenase (EC 1.2.4.4). This dehydrogenase is shared by all branched-chain AA and methionine (Harper *et al.*, 1984). Regulation of branched-chain keto acid dehydrogenase is dependent on phosphorylation status. When insulin levels or tissue sensitivity are high or when branched-chain AA concentrations are low (Randle *et al.*, 1984), the enzyme is inactive (phosphorylated) and catabolism is inhibited. In lactating goats, insulin depresses mammary leucine oxidation and transamination, but this appears to be overridden by arterial leucine supply (Bequette *et al.*, 2002). Net catabolism of the branched-chain AA results in a contribution of amino-groups to non-essential AA synthesis.

Oxidation of leucine by the udder is lower (0.08 vs. 0.34 of leucine uptake) in early lactation goats yielding 4.3 kg milk day<sup>-1</sup> than in late lactation goats yielding 1.5 kg milk day<sup>-1</sup> (Oddy *et al.*, 1988). In the dairy cow, both the fractional (0.047 vs. 0.136) and absolute (5 vs. 18 g leucine day<sup>-1</sup>) rates of leucine oxidation are increased by dietary protein supplementation (Bequette *et al.*, 1996b). These studies suggest an inverse relationship between milk protein output and leucine catabolism. This association was dismissed by Bequette *et al.* (1996a) when they showed that leucine oxidation could be reduced (20% vs. 3%) substantially without affecting milk protein synthesis. A more tenable relationship may be one where AA oxidation is a function of the differential between supply and demand.

Although lysine is often thought to be first- or second-limiting on most maize-based dairy rations, lysine presents an anomaly because it is almost always taken up in excess

by the udder. From 16 to 34% of lysine is oxidized by the mammary gland of lactating goats (Mabjeeshet *et al.*, 2000), and furthermore, levels of oxidation are higher in late than in early lactating animals, similar to observations for leucine (Oddy *et al.*, 1988). Lysine is ketogenic (Fig. 4.14), but it is not known whether its oxidation by the udder serves to provide ketogenic substrate.

Along with lysine, methionine is often considered to be one of the limiting AA of maize-based rations, particularly when heated soybeans make up most of the protein source. In addition to incorporation into protein, methionine is involved in multiple pathways leading to synthesis of phospholipids, carnitine, creatine (Fig. 4.8) and polyamines (Fig. 4.3). At the same time, methionine provides methyl groups for a number of transmethylation reactions involved in regulation of DNA activity and oncogene status, and it provides sulphur for cysteine synthesis. In goats, 28% of the methionine methyl group contributes to the plasma choline pool, and 10% is irreversibly lost through oxidation (Emmanuel and Kelly, 1984). One consequence of this catabolism is the synthesis of cysteine. In the goat udder, 10% of methionine-sulphur contributes to cysteine synthesis (Lee *et al.*, 1996).

Attempts to increase milk protein yield by increasing the supply of methionine by addition of rumen-protected methionine have given mixed results. One side effect of providing excess methionine is that it is one of the most toxic AA. As an alternative, 4-thiomethyl-2-hydroxybutanoic acid (HMB), the hydroxy analogue of methionine, has been considered. The HMB does not appear to be toxic and since it has no known mammalian transporter it readily diffuses into tissues. The analogue does not appear to be removed by the gut and liver tissues to the same extent as methionine, and several tissues in growing sheep are able to convert HMB into methionine via transamination (Wester *et al.*, 2000). In dairy cows, 20% of methionine in casein was derived from HMB when infused (Lobley and Lapierre, 2001).

Arginine is extracted in the greatest quantities relative to milk protein outputs (150–200% in excess). Arginine has other metabolic functions in addition to being a

precursor for protein synthesis. Recently, its role as a precursor of nitric oxide (Reaction [4.11]) has received attention because of the potential role of nitric oxide in regulating mammary tissue nutrient perfusion (Lacasse *et al.*, 1996). Mammary vascular endothelial cells and the epithelium lining alveoli and ducts exhibit nitric oxide synthase III (EC 1.14.13.39) activity. Thus, secretory cells may be capable of regulating their own local nutrient environment by altering arginine catabolism. The mammary gland possesses a partial urea cycle where an intermediary role for arginine and other intermediates (ornithine, citrulline) of the cycle may be important in mammary function. In rat mammary tissue, arginase (EC 3.5.3.1), which hydrolyses arginine to form ornithine and urea (Fig. 4.2), increases threefold in activity in lactation (Jenkinson and Grigor, 1996). The activity of this pathway may be important for the synthesis of proline. In the sheep and goat udder, citrulline, arginine and ornithine contribute ~20% to casein-proline synthesis (Verbeke *et al.*, 1968; Roets *et al.*, 1974). This pathway may serve to provide an alternative and perhaps critical supply of proline, an AA that is typically not extracted in adequate quantities for casein synthesis. The synthesis of proline from arginine may be inherently limited, however. In bovine mammary tissue, the key enzyme in this pathway, ornithine- $\delta$ -transferase (EC 2.6.1.13), has a high  $K_m$  (8.4 mM), which would require high intracellular concentrations of ornithine to maintain maximal rates of conversion through this pathway (Basch *et al.*, 1995). Alternatively, the requirement for *de novo* synthesis of proline may restrict the availability of arginine for other functions (e.g. polyamine synthesis). None the less, evidence *in vitro* (Harduf *et al.*, 1985) and *in vivo* (dairy cows; Bruckental *et al.*, 1991) seem to suggest that there may be constraints either in mammary intracellular arginine supply or in the conversion of arginine into proline. Unfortunately, since the report by Bruckental *et al.* (1991), there have been no follow-up studies to confirm their observed responses in milk production to supplemental proline.

Observations that cultured bovine mammary tissues do not require tyrosine to synthe-

size casein suggested that sufficient tyrosine could be generated from phenylalanine via the phenylalanine hydroxylase (EC 1.14.16.1) pathway (Chapter 4) (Jorgensen and Larson, 1968). Studies with perfused sheep udder estimated that 10% of casein-tyrosine could be derived via phenylalanine hydroxylation (Verbeke *et al.*, 1972). Recent tracer studies in lactating goats (Bequette *et al.*, 1999) have estimated that 5–9% of phenylalanine is converted into tyrosine. On a whole body basis, however, 10–18% of phenylalanine is converted into tyrosine, most of this probably occurring in the liver. In the whole body and the mammary gland, this conversion was increased by phenylalanine supply.

### The Limiting Amino Acid Concept and Modelling

It is not clear whether the relationship between AA supply and protein synthesis is simply a substrate effect or a reflection of regulatory events. Although acyl-tRNA are normally saturated in other tissues at prevailing intracellular AA concentrations (Shenoy and Rogers, 1978), the same does not appear to be the case for the udder (Elska *et al.*, 1971). If the tRNA-acylating enzymes are not saturated with AA under normal conditions, then provision of additional AA should result in an increase in acylated-tRNA concentrations and more efficient rates of mRNA translation. Given that all 20 AA are required to synthesize milk protein, limitations may occur simultaneously for any of a number of amino acylated-tRNA, e.g. when an AA is at less than saturating concentrations the ribosome may 'hesitate' slightly at each codon specifying the AA. Consequently, the relative deficiency and the number of moles of that particular AA required to synthesize a mole of milk protein would determine the substrate response when the deficiency is alleviated. The implications are that multiple AA may be rate limiting for milk protein synthesis at any one time. This is at odds with the traditional definition and use of the term 'nutritionally limiting AA' where only one AA can be limiting. The multiple AA concept is consistent with

the observations by Clark *et al.* (1978), wherein responses to three different AAs were observed under identical culture conditions. If milk protein synthesis is sensitive to multiple AA at the same time, then changes in arterial concentrations of each AA could be very important when predictions of milk protein production are attempted.

There are other points of regulation of protein synthesis that may need to be considered in refining existing models. The initiation step of protein synthesis is regulated by a variety of factors, including leucine, alanine, glutamine and histidine (Yokogoshi and Yoshida, 1980; Perez-Sala *et al.*, 1991) and their unacylated-tRNAs (Iiboshi *et al.*, 1999). Leucine exerts control of translation via intracellular signalling mechanisms that facilitate more efficient translation of mRNA. These pathways are common to those regulated by insulin. In some cell models and *in vivo*, the branched-chain AA, leucine specifically, enhances tissue sensitivity to insulin (see Jefferson and Kimball, 2001). This role for leucine appears to be permissive, however, because infusion of the branched-chain AA in dairy cows either alone or in combination with infusion of insulin (hyperinsulinaemic-euglycaemic clamp) does not result in a further enhancement of milk protein yield (Annen *et al.*, 1998; Mackle *et al.*, 1999). Volume regulated control of cellular protein synthesis (the cell swelling hypothesis) by glutamate may also be an important mechanism in global and milk protein synthesis as demonstrated by Millar *et al.* (1997) in rat mammary acini. Peptide chain elongation and termination, and expression and turnover of milk protein mRNA, are also potential points of regulation. These points of control have yet to be examined in mammary epithelial cells. If these systems operate in mammary tissue, then AA may also act as direct regulators of casein synthesis. Given the complexity of the system, it is not surprising that progress has been slow using empirical (feeding or infusion studies) approaches to define requirements for individual AA.

Despite the apparent complexity, milk protein synthesis has typically been represented as a simple linear function of the most limiting AA (Hanigan and Baldwin, 1994;

Maas *et al.*, 1997) or of AA supply in aggregate (Baldwin *et al.*, 1987; Danfaer, 1990) as has been adopted for monogastric growth models (D'Mello, 1994). However, the observations by Clark *et al.* (1978) suggest that such a simple representation may not be adequate for mammary tissue. Hanigan *et al.* (2002a) devised an equation that may be more representative, given the previous discussion:

$$U_{AA,Pm} = \frac{V_{AA,Pm}}{1 + \sum \left( \frac{k_{ni,Pm}}{C_{ni}} \right)^{Exp_{ni,Pm}}} \quad [19.1]$$

where  $U_{AA,Pm}$  represents the conversion of AA into milk protein,  $V_{AA,Pm}$  represents the maximal velocity of the reaction,  $C_{ni}$  represents the intracellular concentration of individual AA (1 to  $n$ ),  $k_{ni,Pm}$  represents the apparent affinity constants for the respective AA considered in the representation, and  $Exp_{ni,Pm}$  represents an exponent that can be used to adjust sensitivity to concentrations of individual AA, if needed. Adjustment of the various exponents to values other than 1 should reflect the varied molar proportions of each AA in milk protein and the relative importance of the respective AA in the regulatory process. Equation [19.1] was found to provide slightly more accurate predictions of milk protein yield when used to simulate 21 datasets from the literature, compared to an equation based on the single-limiting AA theory. However, many of the experiments used in the analysis involved treatments where all AA were manipulated simultaneously, i.e. casein infusions. Consequently, the hypothesis that individual AA independently affect milk protein synthesis was not well tested, other than for lysine and methionine. Visual appraisal of the methionine and lysine infusion work indicated that the model fitted those observations significantly better. Use of this multisubstrate representation and a representation of the transporter system that included intracellular feedback control of transporter activity (Hanigan *et al.*, 2001a,b, 2002), helped to explain data where the udder was able to minimize a 20% drop in milk protein production when arterial histidine concentrations declined ninefold (Bequette *et al.*, 2000).

The above prediction scheme is driven by an innate drive to produce milk, e.g.  $V_{AA, Pm}$ . This drive is tempered by endocrine control and the ability to maintain intracellular concentrations of AA. As such, accurate predictions of intracellular AA concentrations are important. Assuming milk protein synthesis and AA removal can be accurately represented by a combination of equations, one need only define the relationship describing AA catabolism in order to predict concentrations. This assumes that the udder is not growing and that non-free sources of AA are insignificant contributors to AA supply, which for the latter may not be true (see above). The various mammary models that have attempted to describe intracellular AA concentrations (Waghorn and Baldwin, 1984; Hanigan and Baldwin, 1994; Maas *et al.*, 1997; Hanigan *et al.*, 2001b) have made the general assumption that AA catabolism is a mass action function of AA concentration. So far, this assumption appears to be correct for leucine, phenylalanine and lysine (Bequette *et al.*, 1996a,b, 1999, 2002; Mabjeesh *et al.*, 2000). However, if the regulation of mammary AA oxidative enzymes is more complicated than simple substrate interactions (i.e. physiological changes in gene expression; DeSantiago *et al.*, 1998), then a more complex representation may be required.

### Future Considerations

The mammary gland is obviously the major controller of its own metabolic fate. Despite this drive, the synthetic capacity of the mammary gland does not appear to be met under

many dietary situations and physiological states, and in part this may be due to limitations in the supply of AA. Catabolism of AA by the gut tissues and the liver, and the partition of AA towards anabolism in muscle, appears to place the greatest limits on AA availability to the udder. Recent evidence supporting a role for peptides or proteins in inter-organ AA exchange and as transport vehicles of AA to the mammary gland provides further evidence of the many aspects of mammary metabolism we have yet to explore. Mammary intracellular metabolism is very active, with many synthetic and catabolic mechanisms to be considered, and yet we have probably only now begun to uncover these interrelated mechanisms and determine how important, necessary or rate-limiting they can be. The interactions of AA and energy-substrate metabolism in the mammary gland and in the whole body were not considered to any great extent, and this is due to the limited information currently available.

The AA transport processes and metabolism of the mammary gland are very complex. As more information accumulates, greater emphasis will be placed on mathematical modelling to collate and clarify the numerous inter-related mechanisms of metabolism and regulation (see Chapter 16). The ability to represent mammary biochemistry and physiology in mathematical terms is close to becoming a reality, but there is still the challenge of integrating these terms within the whole-animal system. Obviously, knowledge and representation of the endocrine systems and their components will be required as well as ways in which these integrate or are integrated by absorbed dietary nutrients (Bauman and Currie, 1980).

### References

- AFRC (Agricultural and Food Research Council) (1993) *Energy and Protein Requirements of Ruminants*. An Advisory Manual Prepared by the AFRC Technical Committee of Responses to Nutrients. CAB International, Wallingford, UK.
- Annen, E.L., McGuire, M.A., Hanson, T.W. and Bauman, D.E. (1998) Milk protein production in cows subjected to abomasal infusion of branched-chain amino acids (BCAA) and a hyperinsulinemic-euglycemic clamp. *Journal of Dairy Science* 81 (Suppl. 1), 354.
- Backwell, F.R.C., Bequette, B.J., Wilson, D., Calder, A.G., Metcalf, J.A., Wray-Cahen, D., MacRae, J.C., Beever, D.E. and Loble, G.E. (1994) Utilization of dipeptides by the caprine mammary gland for milk protein synthesis. *American Journal of Physiology* 267, R1-R6.

- Backwell, F.R.C., Bequette, B.J., Wilson, D., Metcalf, J.A., Franklin, M.F., Beever, D.E., Lobley, G.E. and MacRae, J.C. (1996) Evidence for the utilization of peptides for milk protein synthesis in the lactating dairy goat *in vivo*. *American Journal of Physiology* 271, R955–R960.
- Baldwin, R.L., France, J. and Gill, M. (1987) Metabolism of the lactating cow. I. Animal elements of a mechanistic model. *Journal of Dairy Research* 54, 77–105.
- Barnes, D.M. and Brown, D.L. (1990) Protein reserves in lactating dairy goats. *Small Ruminant Research* 3, 19–24.
- Basch, J.J., Wickham, E.D., Farrell, H.M., Jr and Keys, J.E. (1995) Ornithine- $\delta$ -aminotransferase in lactating bovine mammary glands. *Journal of Dairy Science* 78, 825–831.
- Bauman, D.E. and Currie, W.B. (1980) Partitioning of nutrients during pregnancy and lactation: a review of mechanisms involving homeostasis and homeorhesis. *Journal of Dairy Science* 63, 1514–1529.
- Baumrucker, C.R. (1984) Cationic amino acid transport by bovine mammary tissue. *Journal of Dairy Science* 67, 2500–2506.
- Baumrucker, C.R. (1985) Amino acid transport systems in bovine mammary tissue. *Journal of Dairy Science* 68, 2436–2451.
- Bequette, B.J., Backwell, F.R.C., Dhanoa, M.S., Walker, A., Calder, A.G., Wray-Cahen, D., Metcalf, J.A., Sutton, J.D., Beever, D.E., Lobley, G.E. and MacRae, J.C. (1994) Kinetics of blood free and milk casein-amino acid labelling in the dairy goat at two stages of lactation. *British Journal of Nutrition* 72, 211–220.
- Bequette, B.J., Backwell, F.R.C., MacRae, J.C., Lobley, G.E., Crompton, L.A., Metcalf, J.A. and Sutton, J.D. (1996a) Effect of intravenous amino acid infusion on leucine oxidation across the mammary gland of the lactating goat. *Journal of Dairy Science* 79, 2217–2224.
- Bequette, B.J., Metcalf, J.A., Wray-Cahen, D., Backwell, F.R.C., Sutton, J.D., Lomax, M.A., MacRae, J.C. and Lobley, G.E. (1996b) Leucine and protein metabolism in the lactating dairy cow mammary gland: responses to supplemental dietary crude protein intake. *Journal of Dairy Research* 63, 209–222.
- Bequette, B.J., Backwell, F.R.C. and Crompton, L.A. (1998) Current concepts of amino acid and protein metabolism by the lactating ruminant mammary gland. *Journal of Dairy Science* 81, 2540–2559.
- Bequette, B.J., Backwell, F.R.C., Kyle, C.E., Calder, A.G., Buchan, V., Crompton, L.A., France, J. and MacRae, J.C. (1999) Vascular sources of phenylalanine, tyrosine, lysine and methionine for casein synthesis in lactating goats. *Journal of Dairy Science* 82, 362–377.
- Bequette, B.J., Hanigan, M.D., Calder, A.G., Reynolds, C.K., Lobley, G.E. and MacRae, J.C. (2000) Amino acid exchange by the mammary gland of lactating goats when histidine limits milk production. *Journal of Dairy Science* 83, 765–775.
- Bequette, B.J., Kyle, C.E., Crompton, L.A., Calder, A.G. and Hanigan, M.D. (2002) Protein metabolism in lactating goats subjected to the insulin clamp. *Journal of Dairy Science* 85, 1546–1555.
- Bergman, E.N. and Pell, J.M. (1985) Integration of amino acid metabolism in the ruminant. In: Gilchrist, F.M.C. and Mackie, R.I. (eds) *Herbivore Nutrition in the Subtropics and Tropics*. The Science Press, Johannesburg, South Africa, pp. 613–628.
- Berthiaume, R. (2000) Intestinal disappearance and net nutrient metabolism by the portal-drained viscera and the liver of dairy cows. PhD thesis, University of Guelph, Guelph, Canada, p. 140.
- Berthiaume, R., Dubreuil, P., Stevenson, M., McBride, B.W. and Lapierre, H. (2001) Intestinal disappearance and mesenteric and portal appearance of amino acids in dairy cows fed ruminally protected methionine. *Journal of Dairy Science* 84, 194–203.
- Bickerstaffe, R., Annison, E.F. and Linzell, J.L. (1974) The metabolism of glucose, acetate, lipids and amino acids in lactating dairy cows. *Journal of Agricultural Science (Cambridge)* 82, 71–85.
- Blouin, J.P., Bernier, J.F., Reynolds, C.K., Lobley, G.E., Dubreuil, P. and Lapierre, H. (2002) Effect of diet quality on splanchnic fluxes of nutrients and hormones in lactating dairy cows. *Journal of Dairy Science* (in press).
- Bruckental, I., Ascarelli, I., Yosif, B. and Alumot, E. (1991) Effect of duodenal proline infusion on milk production and composition in dairy cows. *Animal Production* 53, 299–303.
- Bruckental, I., Huntington, G.B., Baer, C.K. and Erdman, R.A. (1997) The effect of abomasal infusion of casein and recombinant somatotropin hormone injection on nitrogen balance and amino acid fluxes in portal-drained viscera and net hepatic and total splanchnic blood in Holstein steers. *Journal of Animal Science* 75, 1119–1129.
- Champredon, C., Debras, E., Mirand, P.P. and Arnal, M. (1990) Methionine flux and tissue protein synthesis in lactating and dry goats. *Journal of Nutrition* 120, 1006–1015.

- Chen, H., Wong, E.A. and Webb, K.E., Jr (1999) Tissue distribution of a peptide transporter mRNA in sheep, dairy cows, pigs, and chickens. *Journal of Animal Science* 77, 1277–1283.
- Cherepanov, G.G., Danfaer, A. and Cant, J.P. (2000) Simulation analysis of substrate utilization in the mammary gland of lactating cows. *Journal of Dairy Research* 67, 171–188.
- Christensen, H.N. (1990) Role of amino acid transport and countertransport in nutrition and metabolism. *Physiological Reviews* 70, 43–77.
- Clark, R.M., Chandler, P.T. and Park, C.S. (1978) Limiting amino acids for milk protein synthesis by bovine mammary cells in culture. *Journal of Dairy Science* 61, 408–413.
- Clark, R.M., Chandler, P.T., Park, C.S. and Norman, A.W. (1980) Extracellular amino acid effects on milk protein synthesis and intracellular amino acid pools with bovine mammary cells in culture. *Journal of Dairy Science* 63, 1230–1234.
- CNCPS (The Cornell University Nutrient Management Planning System) (2000) *The Net Carbohydrate and Protein System for Evaluating Herd Nutrition and Nutrient Excretion*. CNCPS version 4.0, 3 November 2000. Model Documentation.
- Danfaer, A., (1990) A dynamic model of nutrient digestion and metabolism in lactating dairy cows. PhD thesis. National Institute of Animal Science, Foulum, Denmark.
- Danfaer, A. (1994) Nutrient metabolism and utilization in the liver. *Livestock Production Science* 39, 115–127.
- DePeters, E.J. and Cant, J.P. (1992) Nutritional factors influencing the nitrogen composition of bovine milk: a review. *Journal of Dairy Science* 75, 2043–2070.
- DeSantiago, S., Torres, N., Suryawan, A., Tovar, A.R. and Hutson, S.M. (1998) Regulation of branched-chain amino acid metabolism in the lactating rat. *Journal of Nutrition* 128, 1165–1171.
- D'Mello, J.P.F. (1994) Responses of growing poultry to amino acids. In: D'Mello, J.P.F. (ed.) *Amino Acids in Farm Animal Nutrition*. CAB International, Wallingford, UK, pp. 205–244.
- Elska, A., Matsuka, G., Matiash, U., Nasarenko, I. and Semenova, N. (1971) tRNA and aminoacyl-tRNA synthetases during differentiation and various functional states of the mammary gland. *Biochimica et Biophysica Acta* 247, 430–440.
- Emmanuel, B. and Kelly, J.J. (1984) Kinetics of methionine and choline and their incorporation into plasma lipids and milk components in lactating goats. *Journal of Dairy Science* 67, 1912–1918.
- Fisher, C. (1994) Responses of laying hens to amino acids. In: D'Mello, J.P.F. (ed.) *Amino Acids in Farm Animal Nutrition*, CAB International, Wallingford, UK, pp. 245–280.
- France, J., Hanigan, M.D., Reynolds, C.K., Dijkstra, J., Crompton, L.A., Maas, J.A., Bequette, B.J., Metcalf, J.A., Lobley, G.E., MacRae, J.C. and Beever, D.E. (1999) An isotope dilution model for partitioning leucine uptake by the liver of the lactating dairy cow. *Journal of Theoretical Biology* 198, 121–133.
- Gate, J.J., Parker, D.S. and Lobley, G.E. (1999) The metabolic fate of the amido-N group of glutamine in the tissues of the gastrointestinal tract in 24 h-fasted sheep. *British Journal of Nutrition* 81, 297–306.
- Gibb, M.J., Irvings, W.E., Dhanoa, M.S. and Sutton, J.D. (1992) Changes in body components of autumn-calving Holstein-Friesian cows over the first 29 weeks of lactation. *Animal Production* 55, 339–360.
- Goodwin, G.W., Gibboney, W., Paxton, R., Harris, R.A. and Lemons, J.A. (1987) Activities of branched-chain amino acid aminotransferase and branched-chain 2-oxo acid dehydrogenase complex in tissues of maternal and fetal sheep. *Biochemical Journal* 242, 305–308.
- Guinard, J. and Rulquin, H. (1994) Effect of graded levels of duodenal infusions of casein on mammary uptake in lactating cows. 2. Individual amino acids. *Journal of Dairy Science* 77, 3304–3315.
- Hanigan, M. D. and Baldwin, R.L. (1994) A mechanistic model of mammary gland metabolism in the lactating cow. *Agricultural Systems* 45, 369–419.
- Hanigan, M.D., Calvert, C.C., DePeters, E.J., Reis, B.L. and Baldwin, R.L. (1992) Kinetics of amino acid extraction by lactating mammary glands in control and somatotribove-treated Holstein cows. *Journal of Dairy Science* 75, 161–173.
- Hanigan, M.D., France, J., Crompton, L.A. and Bequette, B.J. (2001a) Evaluation of a representation of the limiting amino acid theory for milk protein synthesis. In: McNamara, J.P., France, J. and Beever, D.E. (eds) *Modelling Nutrient Utilization in Farm Animals*. CAB International, Wallingford, UK, pp. 127–144.
- Hanigan, M.D., Crompton, L.A., Metcalf, J.A. and France, J. (2001b) Modelling mammary metabolism in the dairy cow to predict milk constituent yield, with emphasis on amino acid metabolism and milk protein: model construction. *Journal of Theoretical Biology* 213, 223–239.

- Hanigan, M.D., Crompton, L.A., Bequette, B.J., Mills, J.A. and France, J. (2002) Modelling mammary metabolism in the dairy cow to predict milk constituent yield, with emphasis on amino acid metabolism and milk protein production: model evaluation. *Journal of Theoretical Biology* 217, 311–330.
- Harduf, Z., Cohen, N., Gertler, A. and Alumot, E. (1985) Saving nitrogen by supplying proline to cow mammary gland cultures. *Nutrition Reports International* 31, 1071–1074.
- Harper, A.E., Miller, R.H. and Black, K.P. (1984) Branched-chain amino acid metabolism. *Annual Review of Nutrition* 4, 409–454.
- Huntington, G.B. and Reynolds, C.K. (1987) Oxygen consumption and metabolite flux of bovine portal-drained viscera and liver. *Journal of Nutrition* 117, 1167–1173.
- Iboshi, Y., Papst, P.J., Kawasome, H., Hosoi, H., Abraham, R.T., Houghton, P.J. and Terada, N. (1999) Amino acid-dependent control of p70(s6k). Involvement of tRNA aminacylation in the regulation. *Journal of Biological Chemistry* 274, 1092–1099.
- INRA (Institut National de la Recherche Agronomique) (1989) *Ruminant Nutrition. Recommended Allowances and Feed Tables*, Jarridge, R. (ed.). John Libbey, Eurotext, London.
- Jefferson, L.S. and Kimball, S.R. (2001) Amino acid regulation of gene expression. *Journal of Nutrition* 131, 2460S–2466S.
- Jenkinson, C.P. and Grigor, M.R. (1996) Rat mammary arginase-isolation and characterization. *Biochemical Medicine and Metabolic Biology* 51, 156–165.
- Jorgensen, G.N. and Larson, B.L. (1968) Conversion of phenylalanine to tyrosine in the bovine mammary secretory cell. *Biochimica et Biophysica Acta* 165, 121–126.
- Kohn, R.A., Hanigan, M.D., Kalscheur, K.F., Boston, R.C. and Chalupa, W. (1998) Evaluation of models for balancing the protein requirements of dairy cattle. *Journal of Dairy Science* 81, 3402–3414.
- Komaragiri, M.V.S. and Erdman, R.A. (1997) Factors affecting body tissue mobilization in early lactation dairy cows. 1. Effect of dietary protein on mobilization of body fat and protein. *Journal of Dairy Science* 80, 929–937.
- Lacasse, P., Farr, V.C., Davis, S.R. and Prosser, C.G. (1996) Local secretion of nitric oxide and the control of mammary blood flow. *Journal of Dairy Science* 79, 1369–1374.
- Lapierre, H., Bernier, J.F., Dubreuil, P., Reynolds, C.K., Farmer, C., Ouellet, D.R. and Lobley, G.E. (1999) The effect of intake on protein metabolism across splanchnic tissues in growing beef steers. *British Journal of Nutrition* 81, 457–466.
- Larsen, M., Madsen, T.G., Weisbjerg, M.R., Hvelplund, T. and Madsen, J. (2000) Endogenous amino acid flow in the duodenum of dairy cows. *Acta Agriculturae Scandinavica Section A-Animal Science* 50, 161–173.
- Lee, J., Treloar, B.P., Sinclair, B.R., Prosser, C.P., Davis, S.R. and Harris, P.M. (1996) Utilisation of methionine by the mammary gland of the lactating goat. *Proceedings of the New Zealand Society of Animal Production* 56, 53–57.
- Lobley, G.E. (1992) Control of the metabolic fate of amino acids in ruminants: a review. *Journal of Animal Science* 70, 3264–3275.
- Lobley, G.E. and Lapierre, H. (2001) Nitrogen: from mouth to milk. *Proceedings of the 16th Annual Southwest Nutrition and Management Conference*. Arizona, USA, pp. 81–99.
- Lobley, G.E., Milne, V., Lovie J.M., Reeds, P.J. and Pennie, K. (1980) Whole body and tissue protein synthesis in cattle. *British Journal of Nutrition* 43, 49–502.
- Maas, J., France, J. and McBride, B. (1997) Model of milk protein synthesis. A mechanistic model of milk protein synthesis in the lactating bovine mammary gland. *Journal of Theoretical Biology* 187, 363–378.
- Mabjeesh, S.J., Kyle, C.E., MacRae, J.C. and Bequette, B.J. (2000) Lysine metabolism by the mammary gland of lactating goats at two stages of lactation. *Journal of Dairy Science* 83, 996–1003.
- Mabjeesh, S.J., Cohen, M., Gal-Garber, O., Shamay, A. and Uni, Z. (2001) Amino peptidase gene expression in caprine mammary gland: a possible role in peptide-bound amino acid uptake. *Journal of Animal Science* 79 (suppl. 1.), 313.
- Mackie, T.R., Dwyer, D.A. and Bauman, D.E. (1999) Effects of branched chain amino acids and sodium caseinate on milk protein concentration and yield from dairy cows. *Journal of Dairy Science* 82, 161–171.
- MacRae, J.C., Bruce, L.A., Brown, D.S. and Calder, A.G. (1997a) Amino acid use by the gastrointestinal tract of sheep given lucerne forage. *American Journal of Physiology* 36, G1200–G1207.
- MacRae, J.C., Bruce, L.A., Brown, D.S., Farningham, D.A.H. and Franklin, M. (1997b) Absorption of amino acids from the intestine and their net flux across the mesenteric- and portal-drained viscera of lambs. *Journal of Animal Science* 75, 3307–3314.



- Mepham, T.B. (1982) Amino acid utilization by lactating mammary gland. *Journal of Dairy Science* 65, 287–298.
- Mepham, T.B. and Linzell, J.L. (1966) A quantitative assessment of the contribution of individual plasma amino acids to the synthesis of milk proteins by the goat mammary gland. *Biochemical Journal* 101, 76–83.
- Metcalfe, J.A., Wray-Cahen, D., Chettle, E.E., Sutton, J.D., Beever, D.E., Crompton, L.A., MacRae, J.C., Bequette, B.J. and Backwell, F.R.C. (1996) The effect of dietary crude protein as protected soybean meal on mammary metabolism in the lactating dairy cow. *Journal of Dairy Science* 79, 603–611.
- Millar I.D., Barber, M.C., Lomax, M.A., Travers, M.T. and Shennan, D.B. (1997) Mammary protein synthesis is acutely regulated by the cellular hydration state. *Biochemical and Biophysical Research Communications* 230, 351–355.
- Mukkur, T.K., Watson, D.L., Saini, K.S. and Lascelles, A.K. (1985) Purification and characterization of goblet-cell mucin of high  $M_r$  from the small intestine of sheep. *Biochemical Journal* 229, 419–428.
- NRC (National Research Council) (1998) *Nutrient Requirements of Swine*, 10th revised edition. National Academy of Sciences, Washington, DC.
- NRC (National Research Council) (2000) *Nutrient Requirements of Beef Cattle*, 7th revised edition, National Academy of Sciences, Washington, DC.
- NRC (National Research Council) (2001) *Nutrient Requirements of Dairy Cattle*, 7th revised edition, National Academy of Sciences, Washington, DC.
- North, M.O. and Bell, D.D. (1990) *Commercial Chicken Production Manual*, 4th edn. Chapman and Hall, New York.
- Oddy, V.H., Lindsay, D.B. and Fleet, I.R. (1988) Protein synthesis and degradation in the mammary gland of lactating goats. *Journal of Dairy Research* 55, 143–154.
- Ouellet, D.R., Demers, M., Zuur, G., Lobley, G.E., Seoane, J.R., Nolan, J.V. and Lapierre, H. (2002) Effect of dietary fiber on net endogenous nitrogen secretion flows in lactating dairy cows. *Journal of Dairy Science* 85, in press.
- Pan, Y., Bender, P.K., Akers, R.M. and Webb, K.E., Jr (1996) Methionine-containing peptides can be used as methionine sources for protein accretion in cultured  $C_2C_{12}$  and MAC-T cells. *Journal of Nutrition* 126, 232–241.
- Perez-Sala, D., Calleja, T.R., Parrilla, R. and Ayuso, M.S. (1991) Effect of alanine supply on hepatic protein synthesis in animals maintained on a protein free diet. *Molecular and Cellular Biochemistry* 108, 105–112.
- Raggio, G., Lobley, G.E., Pellerin, D., Allard, G., Berthiaume, R., Dubreuil, P., Babkine, M. and Lapierre, H. (2002) Effect of protein intake on synthesis of albumin and plasma total protein in lactating dairy cows. *Journal of Dairy Science* 85 (suppl. 1), 243.
- Randle, P.J., Fatania, H.R. and Lau, K.S. (1984) Regulation of the mitochondrial branched-chain 2-oxo-acid dehydrogenase complex of animal tissues by reversible phosphorylation. *Molecular Aspects of Cellular Regulation* 3, 1–26.
- Remond, D., Bernard, L. and Poncet, C. (2000) Free and peptide amino acid net flux across the rumen and the mesenteric- and portal-drained viscera of sheep. *Journal of Animal Science* 78, 1960–1972.
- Reynolds, C.K., Huntington, G.B., Tyrrell, H.F. and Reynolds, P.J. (1988) Net portal-drained visceral and hepatic metabolism of glucose, L-lactate and nitrogenous compounds in lactating Holstein cows. *Journal of Dairy Science* 71, 1803–1812.
- Reynolds, C.K., Crompton, L.A., Bequette, B.J., France, J., Beever, D.E. and MacRae, J.C. (2000) Effects of diet protein level and abomasal amino acid infusion on phenylalanine and tyrosine metabolism in lactating dairy cows. *Journal of Dairy Science* 83 (suppl. 1), 298.
- Reynolds, C.K., Bequette, B.J., Caton, J.S., Humphries, D.J., Aikman, P.C., Lupoli, B. and Sutton, J.D. (2001) Effects of intake and lactation on absorption and metabolism of leucine and phenylalanine by splanchnic tissues of dairy cows. *Journal of Dairy Science* 84 (Suppl. 1), 362.
- Roets, E., Verbeke, R., Massart-Leñ, A.-M. and Peeters, G. (1974) Metabolism of [ $^{14}C$ ]citrulline in the perfused sheep and goat udder. *Biochemical Journal* 144, 435–446.
- Rogers, Q.R. (1976) The nutritional and metabolic effects of amino acid imbalances. In: Cole, D.J.A., Boormann, K.N., Buttery, P.J., Lewis, D., Neale, R.J. and Swan, H. (eds) *Protein Metabolism and Nutrition*, European Association of Animal Production, Publ. no. 16, Butterworths, London, pp. 279–299.
- Seal, C.J. and Parker, D.S. (1996) Effect of intraruminal propionic acid infusion on metabolism of mesenteric- and portal-drained viscera in growing steers fed a forage diet: II. Ammonia, urea amino acids, and peptides. *Journal of Animal Science* 74, 245–256.

- Shennan, D.B. (1998) Mammary gland membrane transport systems. *Journal of Mammary Gland Biology and Neoplasia* 3, 247–258.
- Shenoy, S. and Rogers, Q.R. (1978) Effect of dietary amino acids on transfer ribonucleic acid charging levels in rat liver. *Journal of Nutrition* 108, 1412–1421.
- Stoll, B., Burrin, D.G., Henry, J., Yu, H., Jahoor, F. and Reeds, P.J. (1999) Substrate oxidation by the portal drained viscera of fed piglets. *American Journal of Physiology* 277, E168–E175.
- Tamminga, S., Schulze, H., Van Bruchem, J. and Huisman, J. (1995) The nutritional significance of endogenous n-losses along the gastro-intestinal tract of farm animals. *Archives of Animal Nutrition* 48, 9–22.
- van Goudoever, J.B., Stoff, B., Henry, J.F., Burrin, D.G. and Reeds, P.J. (2000) Adaptive regulation of intestinal lysine metabolism. *Proceedings of the National Academy of Sciences USA* 97, 11620–11625.
- Vanhatalo, A., Huhtanen, P., Toivonen, V. and Varvikko, T. (1999) Response of dairy cows fed grass silage diets to abomasal infusions of histidine alone or in combinations with methionine and lysine. *Journal of Dairy Science* 82, 2674–2685.
- Verbeke, R., Peeters, G., Massart-Leën, A.-M. and Cocquyt, G. (1968) Incorporation of DL-[2-<sup>14</sup>C]ornithine and DL-[5-<sup>14</sup>C]arginine in milk constituents by the isolated lactating sheep udder. *Biochemical Journal* 106, 719–724.
- Verbeke, R., Roets, E., Massart-Leën, A.-M. and Peeters, G. (1972) Metabolism of [U-<sup>14</sup>C]-L-threonine and [U-<sup>14</sup>C]-L-phenylalanine by the isolated perfused udder. *Journal of Dairy Research* 39, 239–250.
- Waghorn, G.C. and Baldwin, R.L. (1984) Model of metabolite flux within mammary gland of the lactating cow. *Journal of Dairy Science* 67, 531–544.
- Wang, S., Webb, K.E., Jr and Akers, R.M. (1994) Utilization of peptide-bound lysine for the synthesis of secreted proteins by mammary tissue explants from lactating mice. *FASEB Journal* 8, A463.
- Wang, S., Webb, K.E., Jr and Akers, M.R. (1996) Peptide-bound methionine can be a source of methionine for the synthesis of secreted proteins by mammary tissue explants from lactating mice. *Journal of Nutrition* 126, 1662–1672.
- Wester, T.J., Vasquez-Anon, M., Parker, D.S., Dibner, J.J., Calder, A.G. and Lobley, G.E. (2000) Synthesis of methionine (met) from 2-hydroxy-4-methylthio butanoic acid (HMB) in growing lambs. *Journal of Animal Science* 78 (Suppl. 1), 269.
- Wilson, G.F., MacKenzie, D.D.S., Brookes, I.M. and Lyon, G.L. (1988) Importance of body tissues as sources of nutrients for milk synthesis in the cow, using <sup>13</sup>C as a marker. *British Journal of Nutrition* 60, 605–617.
- Wray-Cahen, D., Metcalf, J.A., Backwell, F.R.C., Bequette, B.J., Brown, D.S., Sutton, J.D. and Lobley, G.E. (1997) Hepatic response to increased exogenous supply of plasma amino acids by infusion into the mesenteric vein of Holstein-Friesian cows in late gestation. *British Journal of Nutrition* 78, 913–930.
- Yokogoshi, H. and Yoshida, A. (1980) Effects of supplementation and depletion of a single essential amino acid on hepatic polyribosome profile in rats. *Journal of Nutrition* 110, 375–382.



# 20 Effects of Amino Acids on Milk Production

**D.G. Chamberlain\* and J.-M. Yeo**

*Hannah Research Institute, Hannah Research Park, Ayr, UK*

---

## Introduction

Numerous feeding trials over many years show that feeding extra protein can increase the production of milk. Milk production responds to changes in both the amount of dietary protein and its amino acid make-up (see Rulquin and Vérité, 1993). However, these findings can be difficult to interpret because we cannot accurately predict the effects of dietary changes on the amounts of amino acids absorbed from the gut and supplied to the udder. In particular, predicting the degradability of dietary proteins and the synthesis of microbial protein in the rumen is problematic (Oldham, 1994; Beever, 1996). Moreover, disproportionate losses of certain amino acids in passage through the rumen mean that the relationship between the concentration of these amino acids in the diet and in digesta reaching the small intestine is poor (Rulquin and Vérité, 1993). It can, therefore, be difficult to separate effects of rumen-degradability from those of amino acid composition (see Chamberlain *et al.*, 1989). Because of the difficulties in interpreting results of feeding experiments, we shall focus on responses of milk production to well-defined changes in amino acid supply. These are most likely to occur when protein or

amino acids are given direct into the small intestine, or amino acids are given direct into the blood. Controlled experiments in which rumen-protected amino acids are added to the diet also merit attention. However, the increase in amino acids reaching the small intestine is not always easy to quantify because the degree of protection of the amino acids is uncertain and varies with the method of protection (Blum *et al.*, 1998).

Often when the protein level in the diet is raised, the cow eats more food and digests it more efficiently (Oldham 1984). This increases the amounts of amino acids and other nutrients available to the animal from the basal diet and, again, makes it difficult to ascribe changes in milk production solely to the extra amino acids supplied in the diet. These 'indirect' effects of changes in amino acid supply, on intake and digestibility, are an important part of the animal's metabolic response and they cannot be excluded from any true understanding of the effects of amino acids on animal production. However, the mechanisms underlying them are poorly understood and so their occurrence and magnitude are unpredictable.

Even when changes in amino acid supply are clearly defined, milk secretion can respond in various ways. Yield of milk protein can

\*E-mail address: chamberlaind@hri.sari.ac.uk

increase, with or without increases in the yield of lactose, and the secretion of milk fat can go up or down. These variations in the pattern of response are not understood but, presumably, arise from differences in nutrient status and their effects on the use of amino acids for purposes other than the synthesis of milk protein. They add a layer of complexity to the mechanisms underlying the effects of amino acids on milk production which, to date, has prevented a satisfactory level of understanding.

### Responses to Postruminal Infusions of Proteins and Mixtures of Amino Acids

In most of the reported experiments, casein or mixtures of amino acids simulating casein were used (Clark, 1975; Thomas and Chamberlain, 1984; Oldham, 1994). Overall, infusion of casein or corresponding mixtures of amino acids increased the yield of protein and lactose substantially but the apparent recovery of infused amino acids in milk protein varied widely, between 10 and 50% (Clark, 1975; Choung and Chamberlain, 1993a; Ørskov *et al.*, 1977; Whitelaw *et al.*, 1986; Bequette *et al.*, 1998). The increases in protein yield were often accompanied by increases in the concentration of protein in the milk but effects on the yield and concentration of milk fat were variable. Furthermore, clear responses of milk production were seen with basal diets varying in crude protein content from 110 to 200 g kg<sup>-1</sup> (Chamberlain and Thomas, 1982; Oldham, 1994). The

consistent positive responses to casein infusion, irrespective of the level of protein in the diet, might indicate endocrine mechanisms, involving especially growth hormone and insulin (see Oldham, 1994). However, more recent work shows that an enhanced supply of amino acids can increase milk production without affecting arterial concentrations of growth hormone, insulin or prolactin (Guinard *et al.*, 1994; Metcalf *et al.*, 1996a). It therefore seems that the responses are to nutrient supply in itself rather than to changes in hormone secretion but this is not to say that hormones may not play a secondary role in some circumstances. We should not be surprised that dairy cows respond to additional protein given postruminally when the basal diet itself is high in protein; results of feeding trials show milk protein yield responded even to a change of dietary CP content from 190 to 220 g kg<sup>-1</sup> of DM, when supplements were high in rumen-undegradable protein (UDP) (see Chamberlain *et al.*, 1989). Responses such as these fit more comfortably within the framework of nutrient responses (BBSRC, 1998) rather than the more rigid framework of nutrient requirements (AFRC, 1992). An unwelcome by-product of requirement-based systems is that they lead to a tendency to rule out positive responses to provision of nutrients in excess of 'requirement'.

Regrettably, proteins other than casein have received comparatively little attention, presumably because of the practical difficulties of infusing them. However, some comparisons of soy protein isolate (SPI) and casein have been published and Table 20.1 shows

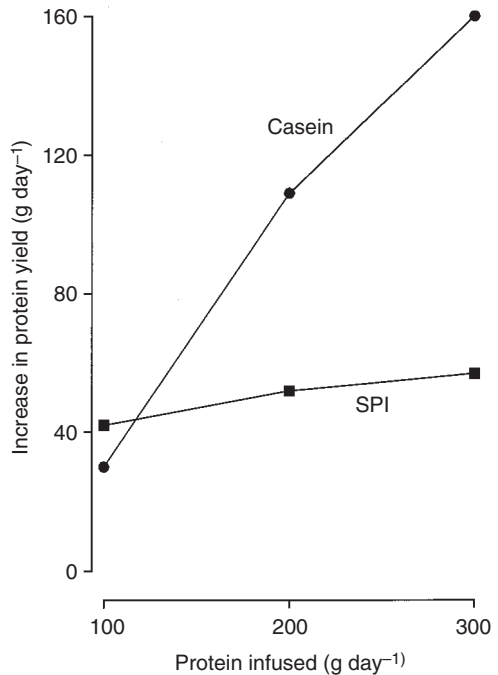
**Table 20.1.** Responses in the yields of protein, lactose and fat to postruminal infusions of soy protein isolate (SPI) expressed relative to the responses to corresponding isonitrogenous infusions of caseinate.

Reference	Caseinate infused (g day <sup>-1</sup> )	Response to SPI relative to caseinate		
		Protein	Lactose	Fat
Rulquin (1986)	550	0.44	0.85 <sup>a</sup>	0.95
Choung and Chamberlain (1992a)	230	0.52	0.51	0.84
Choung and Chamberlain (1992b)	230	0.47	0.64	1.13
Choung and Chamberlain (1992c)	200	0.64	0.67	0.34
Choung and Chamberlain (1993a)	200	0.46	0.26	0.16
Mean		0.51	0.59	0.68
(SE)		(0.04)	(0.10)	(0.19)

<sup>a</sup>Calculated from milk yield assuming 47 g lactose kg<sup>-1</sup> milk.

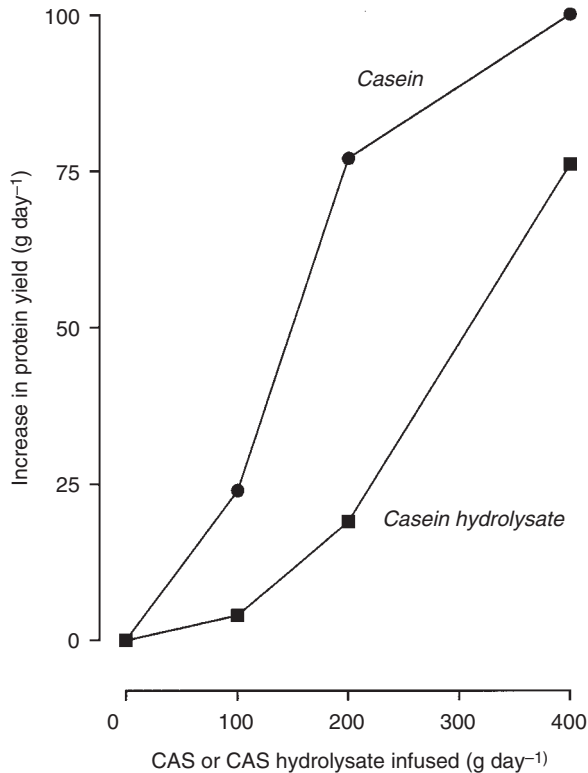
the relative responses of milk protein yield to isonitrogenous infusions of the two proteins. On average, SPI was about 50% as effective as casein in stimulating the yield of milk protein; corresponding figures for lactose and fat were more variable but, again, generally the values were below those obtained with casein. SPI and casein have very similar intestinal digestibilities (Beynen *et al.*, 1990), and so it is likely that these differences between the two proteins stem from their different amino acid compositions. Indeed, it is worth noting that the proteins differ most in their content of methionine, for which SPI contains only 45% of the level in casein (Choung and Chamberlain, 1993a). The effect of the lower quality of SPI relative to casein is illustrated in the results of an experiment in which three levels of infusion of the two proteins were compared (Fig. 20.1). Although the response to casein was virtually linear, there was no further response in the yield of milk protein beyond the first level of SPI. Taken at face value, these results indicate that the consistent positive responses in postruminal infusion experiments with casein and corresponding amino acid mixtures (see above) might overestimate responses obtainable with proteins more typical of ruminant feeds. Moreover, it is uncertain whether amino acid composition explains all of the difference in protein quality. Even when amino acids were added so as to make the two proteins equivalent in the supply of all the amino acids, the response to casein remained superior to that of SPI (Choung and Chamberlain, 1992a). The possible role of factors such as the pattern of release of peptides, some of which can be biologically active, has yet to be defined. It is known that some of the  $\beta$ -casomorphins, released during digestion of  $\beta$ -casein, can influence insulin secretion in the cow (Kim, T.-G. *et al.*, 2000) and could, therefore, affect the supply of nutrients to the udder (Vernon, 1988). These effects of bioactive peptides serve as a further warning against regarding casein as merely a high-quality feed protein.

Aside from bioactive peptides, the form (peptide-bound vs. free) in which amino acids enter the postruminal gut can influence the nature of the response of milk production. When given posturally to cows, a casein



**Fig. 20.1.** Responses in the yield of milk protein to the abomasal infusion of casein or soy-protein isolate (SPI). (Data of Choung and Chamberlain, 1993a.)

hydrolysate was less effective than whole casein in stimulating the yield of milk protein (Fig. 20.2), a finding confirmed in a second experiment that compared whole casein to a corresponding mixture of free amino acids (Choung and Chamberlain, 1995a). Further investigation (Choung and Chamberlain, 1995b) showed that, in comparisons of infusions of hydrolysates of casein containing different proportions of free amino acids and peptides, the ability of the infusate to stimulate the yield of milk protein was directly related to its content of peptide-bound amino acids. It is not known why free amino acids entering the small intestine should be less effective than protein-bound amino acids in stimulating the secretion of milk protein. Greater nitrogen retention in rats fed whole casein compared with a corresponding mixture of free amino acids was put down to a slower gastric emptying, slower rate of entry of amino acids into the blood and more efficient utilization for tissue protein synthesis (Daenzer *et al.*, 2001).



**Fig. 20.2.** Responses in the yield of milk protein to the abomasal infusion of casein or a hydrolysate of casein containing 85% free amino acids. (Data of Choung and Chamberlain, 1995a.)

However, that explanation would not fit the results in dairy cows because the amino acids and protein were given direct into the small intestine. Whether the mammary gland takes up peptides as a source of amino acids for protein synthesis remains controversial, although it looks increasingly likely that at least a small proportion of milk protein might be derived from peptides rather than from free amino acids (see Bequette and Backwell, 1997). Even so, absorption from the intestinal tract is unlikely to supply quantitatively significant amounts of peptides to blood reaching the gland, the most likely sources being liver export proteins and peptides released during tissue protein turnover (see Bequette *et al.*, 1998). However, amino acids in peptide form are absorbed faster from the gut (Rérat *et al.*, 1988). In pigs, the faster appearance of amino acids in portal blood from peptides, as against corresponding mixtures of free amino acids,

was associated with increased secretion of glucagon (Rérat *et al.*, 1988). A similar effect on plasma concentrations of glucagon was seen in the experiments in dairy cows referred to above (see Choung and Chamberlain, 1998). Although insulin levels were little affected, the increased secretion of glucagon lowered the insulin/glucagon ratio, which could stimulate nutrient use by the mammary gland at the expense of other tissues (Bassett, 1975). Again, absorption of peptide-bound amino acids is more homogeneous than that of corresponding amino acid mixtures, such that the amino acid profile in portal blood better represents that of the infusate (Hara *et al.*, 1984; Rérat *et al.*, 1988). It may be that infusion of free amino acids leads to an unbalanced profile of amino acids reaching the liver. How this might affect metabolism in the liver, and the supply of nutrients to other tissues is uncertain. Earlier claims (see Rook, 1983) that

slight amino acid imbalances increase the use of the first-limiting amino acid for protein synthesis in the liver, so reducing its availability for protein synthesis in other tissues, have since been questioned (see Davis and Austic, 1994). Indeed, it has recently been shown that amino acids from dietary casein, as opposed to corresponding free amino acids, are more readily incorporated into liver and plasma proteins (Daenzer *et al.*, 2001).

## Responses to Specific Amino Acids

### Essential amino acids (EAAs)

The search for the EAA(s) that limit milk production has continued for the last 30 years or so, with methionine and lysine receiving by far the most attention. It has long been recognized that the identity of the first-limiting amino acid would vary with the make-up of the diet (see Rook and Thomas, 1983) but this has not dampened the enthusiasm for adding methionine and lysine to a wide range of diets for dairy cows. The last 5 years have seen the publication of 33 full research papers on effects on milk production of supplements of methionine, with or without lysine. These two amino acids are always likely to be among the group of most-limiting acids, particularly with diets based largely on maize and soy (see Rulquin and Vérité, 1993) but with other diets, their position is less clear. Indeed, it is noteworthy that, of the papers referred to above, only 45% showed evidence of positive responses in the yield or concentration of milk protein. If we allow for publication bias and for the fact that, in some experiments, deficiencies of the amino acids were contrived, this figure probably overestimates the success rate for supplements of methionine and lysine. We can only assume that the large numbers of feeding trials dealing with effects of rumen-protected methionine and lysine on milk production, which continue to be reported, are driven more by commercial than by scientific interests. Attempts have been made to put the use of protected methionine and lysine on a sounder scientific basis by specifying the requirement for the two amino acids as a proportion of protein in digesta reaching the small

intestine. These proportions are then estimated for the diet in question and compared with the requirement, to judge whether responses to the protected amino acids would be expected (Rulquin *et al.*, 1993). The success of this approach must rest on the precision of the various estimates included in the calculation but it is to be welcomed as a step in the right direction.

Recent findings emphasize the need for careful targeting of amino acid supplements. In dairy cows eating diets of grass silage and low-protein cereal supplements, histidine is the first-limiting amino acid for the secretion of milk protein (Vanhatalo *et al.*, 1999; Korhonen *et al.*, 2000; Kim *et al.*, 2001a). However, the response to histidine was lost when sufficient soybean meal was included in the cereal supplement to lift the crude protein level of the diet from 160 to 180 g kg<sup>-1</sup> (Kim *et al.*, 2001a). Either histidine was no longer first-limiting or, a second amino acid was now close to being co-limiting with histidine. Calculations support the latter view by indicating that a shortage of leucine would block any response to histidine (Kim *et al.*, 2001a). These results show that a small change in diet can markedly alter the response to an amino acid supplement. Indeed, recent results show that the ranking of the limiting amino acids can be fickle. Despite attempts to keep the composition of the diet constant, in experiments using cows in mid-lactation eating a silage-barley diet, the ranking of the three most-limiting amino acids changed between experiments. The first-limiting amino acid was sometimes histidine and sometimes methionine (Kim *et al.*, 2000a). It is not known why this happened. Amino acids in the small intestine were not measured but the most likely answer would be that the composition of the mixture of amino acids absorbed from the gut had changed. It is tempting to point to the well-known variation of the yield (Chamberlain and Choung, 1995) and composition (Hvelplund, 1986) of microbial protein flowing from the rumen, both of which can markedly influence the amino acid profile of digesta in the small intestine. Although some of the variation reported in the literature is probably due to technical error, reported variation within a laboratory remains large, which suggests real



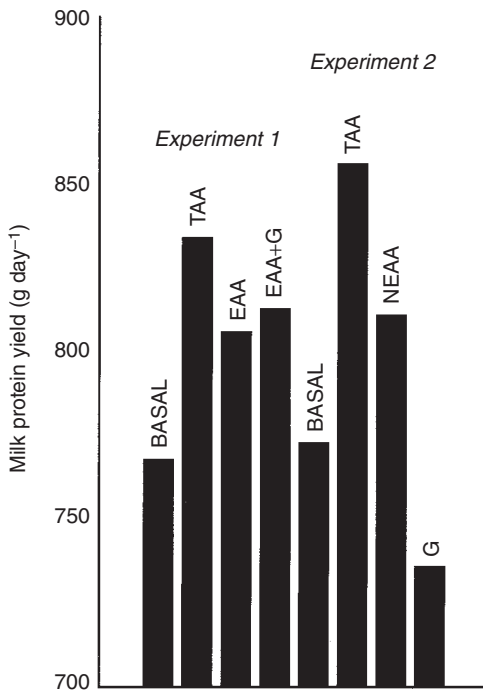
fluctuations in the microbial population and accompanying changes in amino acid composition (see Rulquin and Vêrité, 1993). It is worth noting that these uncertainties surrounding the prediction of microbial amino acid flow are likely to bedevil attempts, such as those of Rulquin *et al.* (1993, 1998), to predict responses to protected methionine and lysine from factorial calculations. Whatever the cause, the clear change in the ranking of the limiting amino acids with slight changes in diet may mean that reproducible responses to amino acid supplements will be seen only when they contain the three or four most-limiting acids. A wider range of commercially available ruminally protected amino acids would speed up progress in this area.

### Non-essential amino acids (NEAAs)

That some of the EAAs (methionine, phenylalanine, tryptophan, histidine and tyrosine) appear to be transferred stoichiometrically from blood to milk, has been taken as circumstantial evidence that these acids are likely to limit the synthesis and secretion of milk protein (Mephram, 1982; Rook and Thomas, 1983). However, we might equally well argue that limiting amino acids could be taken up in amounts well below their output in milk or, indeed, taken up in great excess relative to their output in milk. This alternative view has focused on glutamate (Rook and Thomas, 1983), glutamine (Meijer *et al.*, 1993) and proline (Bruckental *et al.*, 1991). Intravascular infusion of glutamate did not affect the yield of milk protein in goats (Mephram and Linzell, 1974) or cows (Oldham and Bines, 1983) so lending no support to the suggestion that glutamate might be limiting. Although abomasal infusion of glutamine increased the output of milk protein in one of two experiments (Meijer *et al.*, 1996), the effect was put down to stimulated gluconeogenesis because abomasal infusion of propionate had a similar result. The idea of proline as limiting comes from the low mammary uptake of proline itself coupled with the high uptake of arginine, a precursor of proline. This prompted Bruckental *et al.* (1991) to examine the effect of infusing 80 g day<sup>-1</sup> of proline into the duo-

denum in cows in early lactation and in mid-lactation. In mid-lactation cows, but not in cows in early lactation, infusion of proline led to an increased yield of milk protein. Further investigation of the proline response is long overdue; in the meantime, the basis of the effect remains unknown.

Indirect effects of NEAAs on the synthesis of milk protein, by way of their role in gluconeogenesis and subsequent sparing of EAAs for protein synthesis, have been investigated in experiments using mixtures of amino acids infused intravenously. Metcalf *et al.* (1996b) infused cows with 400 g day<sup>-1</sup> of an amino acid mixture simulating the composition of milk protein. They found that the milk response to the infusion of the total amino acid mixture could be obtained with the infusion of the EAA component alone (208 g day<sup>-1</sup>), suggesting that the NEAAs made no contribution to the milk response. Kim *et al.* (2000b) examined the question in more detail in two experiments in which dairy cows were given intravenous infusions of mixtures of amino acids simulating casein. In the first experiment, the treatments were: 182 g day<sup>-1</sup> of the total amino acid mixture (TAA); the EAA component only (101 g day<sup>-1</sup>); and EAA plus 50 g day<sup>-1</sup> of glucose, the glucose equivalent of the NEAA component. Only the TAA infusion led to a statistically significant increase in the yield of milk protein; increases with the EAA and EAA plus glucose failed to reach significance (Fig. 20.3). In the second experiment, equal amounts (182 g day<sup>-1</sup>) of TAA and NEAA were infused and compared with 100 g day<sup>-1</sup> of glucose as the equivalent of the NEAA treatment. Again, only the TAA increased the output of protein in milk; neither NEAA nor glucose affected milk protein yield (Fig. 20.3). All three experiments offer no support for the suggestion that increasing the supply of NEAAs, or their glucose equivalent, can affect the yield of milk protein. This conclusion is in keeping with results from experiments in which glucose was infused into the post-ruminal gut, and in which metabolizable energy (ME) intake was kept constant (an essential requirement if interpretation is not to be confounded) (Hurtaud *et al.*, 1998a). Although it has been claimed that cows eating a basal diet of grass silage increase the yield



**Fig. 20.3.** Effects on the yield of milk protein of intravenous infusion of mixtures of amino acids. In Experiment 1, the infusions were: 182 g day<sup>-1</sup> of total amino acids (TAA); the essential amino acid component of TAA, 101 g day<sup>-1</sup> (EAA); and EAA plus 50 g day<sup>-1</sup> of glucose, the glucose equivalent of the non-essential amino acid component of TAA. In Experiment 2, the infusions were: 182 g day<sup>-1</sup> of TAA; 182 g day<sup>-1</sup> of non-essential component of TAA (NEAA); and 100 g day<sup>-1</sup> of glucose (G), the glucose equivalent of NEAA. (Data of Kim *et al.*, 2000b.)

of milk protein in response to duodenal infusion of glucose (Hurtaud *et al.*, 2000), the effect was not evident until 500 g day<sup>-1</sup> were infused (250 g day<sup>-1</sup> were without effect). And, even then, the response was very small: an increase of <40 g day<sup>-1</sup> of milk protein in return for 500 g day<sup>-1</sup> of glucose. If the use of amino acids for milk protein synthesis were severely limited by the competing demands of gluconeogenesis, we should expect clear responses of milk protein yield to small amounts of glucose because even 50 g of glucose would release around 90 g amino acid for synthesis of milk protein (Krebs, 1964).

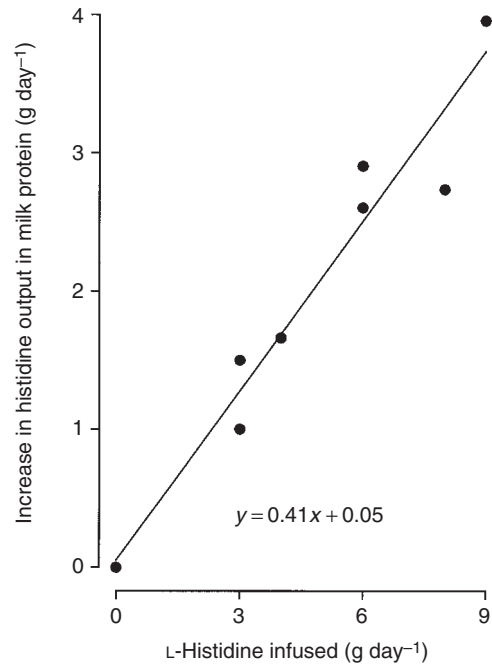
### Efficiency of Use of Amino Acids for Secretion of Milk Protein

Current protein rationing schemes use a factorial approach, whether they aim to define amino acid requirements for a given level of milk production (AFRC, 1992) or to predict the response of milk production to a change of nutrition (BBSRC, 1998). Hence they must incorporate an estimate of the efficiency with which amino acids are put into milk protein. The overall efficiency of use of amino acids for synthesis of milk protein may be pictured as consisting of two components: the partition of amino acids between the udder and other body tissues, and their efficiency of use within the udder itself. As for their use within the udder, it is of interest that rates of total protein synthesis in the gland have been estimated at 1.3–2.5 times greater than the rate of milk protein secretion (see Bequette and Backwell, 1997). However, what this means for the overall efficiency of incorporation of amino acids into milk protein within the gland is not clear. Although a high turnover of protein would be expected to increase the energy cost of secretion of milk protein, it need not have any significant effect on the incorporation of amino acids into milk protein. For present rationing schemes, the most appropriate measure of efficiency would be a coefficient of apparent transfer of amino acids into milk from small intestinal contents, or from blood. But reliable estimates are scarce and the adoption of a fixed value, based on inadequate data, is a recognized weakness of all but one of the current schemes. Even where it is recognized that the efficiency of use will vary among the EAAs (O'Connor *et al.*, 1993), the estimates available are few and probably unreliable. Of course, the efficiency will vary with nutritional circumstances, depending on which amino acid is first-limiting and on the competing demands on amino acid use for purposes other than the synthesis of milk protein (Oldham, 1994). However, a useful starting point would be to define the maximum efficiency of transfer for individual amino acids. We can get this value from the efficiency of transfer of each of the EAAs into milk when it is first-limiting. This can only be measured

reliably from a dose-response line, the efficiency being the slope of the linear response. Such measurements are scarce because it is difficult to achieve a linear response with practical diets, for which the small margin between first-, second-, and even third-limiting amino acids (Schwab *et al.*, 1976) allows only a small response to the first-limiting amino acid. In the absence of tracer techniques, dose-response relationships can be obtained only if the potential response of milk protein yield to addition of the first-limiting amino acid is sizeable.

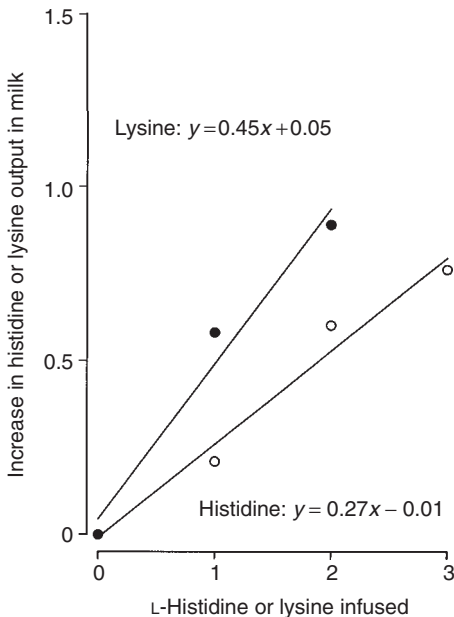
Kim *et al.* (2001b) formulated a histidine-deficient diet based on grass silage and a cereal-based supplement containing feather meal. They then measured the response of milk production to three levels of addition of L-histidine given intravenously, in a total of three experiments (Kim *et al.*, 2001b,c). The response to histidine was linear, such that the increase in the output of histidine in milk protein ( $y$ , g day<sup>-1</sup>) was related to histidine infused ( $x$ , g day<sup>-1</sup>) by  $y = 0.41x + 0.05$  ( $n = 8$ ;  $r^2 = 0.940$ ; Fig. 20.4). This indicates an efficiency of transfer of L-histidine from blood to milk of 0.41, which is well below the value of 0.68 adopted provisionally in AFRC (1992). Furthermore, results of experiments in which lysine (Schwab *et al.*, 1992) and histidine (Korhonen *et al.*, 2000) were infused abomasally in increasing amounts when they were first-limiting offer support for a low efficiency of transfer of histidine (Fig. 20.5). These results show a lower efficiency of transfer (0.27) for histidine than for lysine (0.45), which convert to 0.53 and 0.32, respectively, for the efficiency of transfer from blood to milk, assuming an absorption coefficient of 0.85 (AFRC, 1992). In keeping with these reports, results of tracer studies in lactating goats also suggest that the efficiency of use of histidine for milk protein synthesis is likely to be low. The partition of the plasma flux of histidine to the mammary gland was <0.2 compared with values of 0.3–0.4 for most of the other EAAs (Bequette *et al.*, 1997).

Oldham (1994) discussed responses to protein supplements in some detail. He drew attention to the low efficiency of use of amino acids for secretion of milk protein (around 0.2) seen in many feeding experiments. He suggested that an efficiency of around 0.2 would



**Fig. 20.4.** The transfer of intravenously infused histidine into milk protein in dairy cows eating a diet of grass silage and a cereal-based supplement containing feather meal. (Data of Kim *et al.*, 2001b,c.)

be consistent with the increment of protein having to provide glucose for lactose synthesis, by gluconeogenesis from amino acids, as well as amino acids for synthesis of milk protein. Presumably, a similar argument would apply to responses to amino acids infused into the post-ruminal gut or into the blood. The efficiency of transfer of the amino acid to milk protein would then depend on the glucose status of the cow. To what extent this might explain low efficiencies for lysine (Schwab *et al.*, 1992) and methionine (Pisulewski *et al.*, 1996) is not known. However, we can rule it out for histidine because Kim *et al.* (2001c) infused cows intravenously with L-histidine, with or without glucose, and found that the efficiency of transfer was 0.42 for both treatments. Moreover, although Korhonen *et al.* (2000) included 350 g day<sup>-1</sup> of glucose in all their histidine infusion treatments, the efficiency of transfer of histidine remained low.

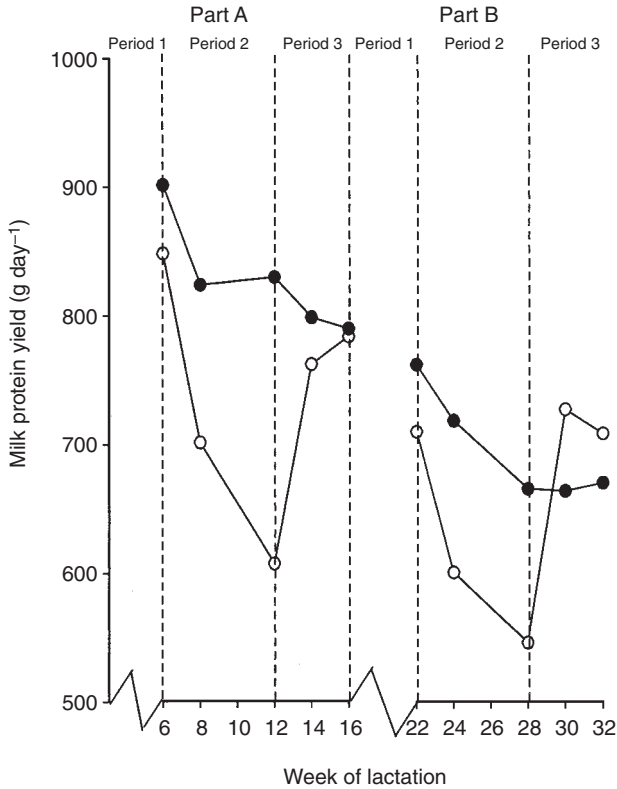


**Fig. 20.5.** The transfer of abomasally infused histidine (○) or lysine (●) into milk protein. The amino acids were infused as graded doses, represented here as arbitrary units, 1, 2, 3. (Data of Schwab *et al.*, 1992, for lysine and Korhonen *et al.*, 2000, for histidine.)

The status of the animal's body reserves of protein also needs to be taken into account. After a period of underfeeding, protein infused postruminally was partitioned between milk protein synthesis and the synthesis of tissue protein, with the overall efficiency of use for the combined processes remaining roughly constant, as judged from nitrogen balance measurements (Whitelaw *et al.*, 1986). However, when cows were in positive nitrogen balance, postruminal infusion of proteins increased secretion of milk protein but did not affect nitrogen retention (Choung and Chamberlain, 1992b). It would follow that, in experiments in which cows were given basal diets deficient in amino acids and which induced mobilization of body reserves, supplementary amino acids, given during the experimental periods, might be used to replenish body protein and, in the case of histidine, body stores of carnosine and possibly haemoglobin. At this point, it is worth remembering that the more sophisticated experimental

techniques based on infusion of amino acids postruminally, especially infusion of amino acids intravascularly, are, of necessity, short term. If the interpretation of protein-feeding experiments can be complicated by the need to consider the cow's labile reserves of protein (see Botts *et al.*, 1979), then that is especially true for short-term infusion experiments. Protein depletion-repletion experiments show labile protein reserves of around 20 kg in cows of 600 kg (Paquay *et al.*, 1972; Botts *et al.*, 1979). It is estimated that, in severe undernutrition, cows could mobilize up to 300 g of protein a day to support milk production and this might be maintained for 6 weeks or more, depending on the condition of the cow (Botts *et al.*, 1979). It is easy to see how the mobilization of body protein might mask the effects of dietary deficiencies of amino acids in the short term.

The histidine-deficient diet used by Kim *et al.* (2001b,c) was also used in a longer-term feeding experiment (J.-M. Yeo, C.H. Knight and D.G. Chamberlain, unpublished results). Cows were given a control diet containing fishmeal as the sole protein supplement before being split into two groups. The control group continued on the fishmeal diet for the whole experiment whereas for the treatment group, the fishmeal was replaced by an equivalent amount of rumen-undegradable protein (UDP) as feather meal for a period of 6 weeks, before returning to the fishmeal control diet for a further 4 weeks. This first part of the experiment was carried out between weeks 6 and 16 of lactation and the second part of the experiment repeated the procedure between lactation weeks 22 and 32 in the same cows. The results for the yield of milk protein are shown in Fig. 20.6. Although, over a 6-week period, the yield of milk protein fell by more than 25% with the change to feather meal, the fall was completely reversed by a return to the fishmeal diet for 4 weeks and this was true at both stages of lactation. Histidine is first-limiting for secretion of milk protein on the feather meal diet, closely followed by methionine with lysine as third-limiting (Kim *et al.*, 1999). The difference in histidine provided by the UDP of fishmeal and feather meal was around 11 g day<sup>-1</sup> (Chamberlain *et al.*, 1992) which amounts to around 9 g day<sup>-1</sup> of absorbable histidine



**Fig. 20.6.** The effects on the yield of milk protein of replacing fishmeal in the supplement by an equivalent amount of UDP as feather meal. The control group (●) received fishmeal throughout; the experimental group (○) received fishmeal until week 6 of lactation when they were changed to feather meal for 6 weeks before returning again to fishmeal for 4 weeks (Part A). After a break of 6 weeks during which the cows were at pasture, the experimental procedure was repeated (Part B). For both parts of the experiment, cows were given a diet of grass silage and a cereal-based supplement. (Unpublished data of J.-M. Yeo, C.H. Knight and D.G. Chamberlain.)

(AFRC, 1992), which is roughly equivalent to the highest dose of histidine given intravenously by Kim *et al.* (2001b,c). We may, therefore, compare the responses of milk protein yield to an enhanced histidine supply, given either intravenously or as a supplement of UDP. When the cows returned to the fishmeal diet, milk protein yield increased by 154 and 164 g day<sup>-1</sup> in first and second parts of the experiment, respectively. These increases in protein yield correspond to efficiencies of transfer of histidine of 0.44 and 0.47, respectively, values that agree well with the estimate (0.41) obtained in the experiments in which histidine was given intravenously. Since the yield of milk protein declined progressively for between 2

and 4 weeks after changing to the amino acid-deficient diet (Fig. 20.6), it is reasonable to infer that the cows mobilized reserves of amino acids to lessen the effect of the deficiency on milk production. This in turn means that when the animals were returned to the fishmeal control, their protein reserves were in a depleted state. It might be expected, therefore, that the extra amino acids provided by the fishmeal would be partitioned between milk secretion and tissue synthesis (Whitelaw *et al.*, 1986). No measurements of nitrogen balance were made but it is worth noting that haemoglobin concentrations increased on the return to the fishmeal diet by, on average, 14 g l<sup>-1</sup> of blood over the 4-week period. This would amount to

about  $1.3 \text{ g day}^{-1}$  of histidine going into haemoglobin, assuming a blood volume of 38.5 litres (Frandsen, 1981). Reducing the histidine available for milk protein synthesis by  $1.3 \text{ g day}^{-1}$  would increase the calculated transfer efficiency into milk to around 0.54. In histidine deficiency, haemoglobin levels are reduced after prolonged periods of deficiency and carnosine stores in muscle are reduced almost to zero (Cianciaruso *et al.*, 1981). Since the decrease in haemoglobin occurs only after depletion of carnosine is well under way (Cianciaruso *et al.*, 1981), it is reasonable to assume that a fall in haemoglobin signals that substantial depletion of carnosine stores has already occurred. Again, since methionine is close behind histidine as the second-limiting amino acid, body protein would also need to be mobilized to supply methionine to maintain milk production. It would seem likely then that the low transfer efficiency for histidine into milk was caused by its use in replenishing carnosine stores and possibly also in restoring levels of haemoglobin and body protein.

The overall implication of the experiments with histidine-deficient diets is that estimates of the efficiency of transfer of amino acids into milk will very likely depend on the status of the cow's body reserves. This information is not normally available and is difficult to deduce, especially in short-term infusion experiments. The findings further imply that assigning values for the efficiency of transfer in protein rationing schemes is likely to be more difficult than expected. In addition to stage of lactation and nutrient status, in particular the supply of glucose precursors (see Oldham, 1994), we may also need to consider the cow's nutritional history.

## Response of Milk Protein Concentration

Although increases in the yield of milk protein sometimes go hand in hand with increases in the concentration in the milk, this is by no means always the case. Protein yield and protein concentration can vary independently. Whether milk protein concentration increases depends on the response of lactose secretion, which determines milk yield. Since higher concentrations of milk protein are beneficial to milk processing, particularly cheese making, farmers are paid on the basis of protein content. However, despite its obvious importance, we know little of what regulates milk protein concentration.

It is widely recognized that increasing the intake of ME from carbohydrate, but not from fat, generally lifts the concentration of milk protein (Rook and Line, 1961; Gordon, 1979). However, the mechanism underlying these effects is unknown. Relationships with ME intake can be misleading because increases in ME intake are often achieved by increasing the starch content of the diet (see Thomas and Rook, 1983) and starch has a greater effect on milk protein content than either soluble sugars (as molasses) or digestible fibre (Castillo *et al.*, 2001). Indeed, there is good evidence that graded increases in the intake of starch, at constant ME intake, leads to a progressive increase in milk protein content (Keady *et al.*, 1998, 1999; Table 20.2). Some authors (e.g. Keady *et al.*, 1998, 1999) have been unable to resist the temptation to attribute these effects of starch intake to an increased supply of amino acids from an

**Table 20.2.** Effects of starch intake on the yield and concentration of milk protein<sup>a</sup>.

	Starch content in supplement ( $\text{g kg}^{-1}$ DM)				
	50	131	209	310	384
Milk yield ( $\text{kg day}^{-1}$ )	26.1	26.0	25.7	25.9	25.9
Protein ( $\text{kg day}^{-1}$ )	0.83	0.83	0.83	0.84	0.86
Protein ( $\text{g kg}^{-1}$ )	32.0	32.2	32.5	33.0	33.6
Starch intake ( $\text{g day}^{-1}$ )	435	1127	1777	2666	3302
ME intake ( $\text{MJ day}^{-1}$ )	215	212	211	215	211
Energy balance ( $\text{MJ day}^{-1}$ )	19	17	17	21	17

<sup>a</sup>Values are taken either direct, or calculated from, the data of Keady *et al.* (1998).

increased synthesis of microbial protein in the rumen. Moreover, this explanation has been favoured despite their own measurements showing no effects on microbial protein production (Keady *et al.*, 1998) or only very small increases (Keady *et al.*, 1999). This interpretation is even more puzzling because, although a small increase in microbial output was measured in response to an increase in starch inclusion, an even greater increment in amino acid supply from extra dietary UDP actually led to a small decrease in milk protein content (Keady *et al.*, 1999). It seems, therefore, that effects of increasing starch intake are not due simply to an increased supply of microbial amino acids. It is important to note that increases in milk protein content occur with little or no increase in the yield of milk protein because milk yield is unaffected or even reduced (Table 20.2). A more fruitful approach to uncovering mechanisms regulating milk protein content might be to focus more on the secretion of lactose.

Older studies showed protein undernutrition to have little effect on the concentration of protein in milk, unless the undernutrition was severe (providing only around 60% of requirement) when protein concentration was reduced (see Thomas and Rook, 1983). However, it is now known that deficiencies of specific amino acids can reduce milk protein concentration even though the supply of total amino acids is well in excess of requirement (Table 20.3). Moreover, it is noticeable that supplements of limiting amino acids very often increase protein concentration as well

as protein yield (Schwab *et al.*, 1976; Rulquin and Vêrité, 1993; Choung and Chamberlain, 1995c). And the increase in protein concentration may even be enhanced by a fall in milk yield associated with a fall in lactose secretion (Rulquin and Delaby, 1997). Any suggestion that these increases in protein content are linked to shortages of glucose for lactose synthesis is likely to be countered by the view that the supplementary amino acids themselves could act as glucose precursors. But we do not know whether EAAs that are limiting for milk protein synthesis are readily available for gluconeogenesis. In the experiment of Kim *et al.* (2001c), even though glucose supply clearly affected milk protein content, the provision of glucose did not affect the efficiency of transfer of histidine into milk protein, which suggests that the contribution of histidine to glucose synthesis was unaffected by the availability of glucose. Estimates of the contribution of amino acids to gluconeogenesis in lactating ruminants vary from as little as 2% to as much as 40%, with little understanding of the causes of the variability (Danfaer *et al.*, 1995). Note also that these estimates refer to the use of amino acids in general; we have no reliable quantitative data on either the use of specific EAAs in gluconeogenesis or its regulation. Attempts to show empirically that increasing tissue supplies of glucose might increase the yield of milk protein by sparing the use of EAAs in gluconeogenesis, so making them available for milk protein synthesis, provide no clear support for the idea (Hurtaud *et al.*, 1998a,b, 2000). It is noteworthy that

**Table 20.3.** The effects of the intravenous infusion of a mixture of L-histidine, L-methionine, L-tryptophan and L-lysine on the yield and concentration of milk protein in cows eating a diet of grass silage and a cereal-based supplement containing feather meal. (From Choung and Chamberlain, 1995c.)

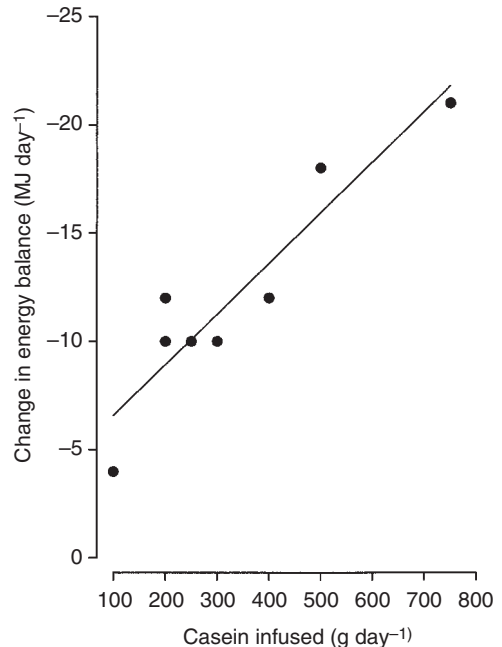
	Control	Infusion <sup>a</sup>	SED
DM intake (kg day <sup>-1</sup> )			
Silage	10.3	10.6	0.26
Supplement	3.5	3.5	—
Milk yield (kg day <sup>-1</sup> )	17.4	20.0	0.43***
Milk protein (g kg <sup>-1</sup> )	30.6	33.4	0.40***
Milk protein (g day <sup>-1</sup> )	524	661	25.4**

<sup>a</sup>The infusion contained (g day<sup>-1</sup>): histidine, 9.7; methionine, 9.1; tryptophan, 2.6; lysine, 30.6.

\*\*\* $P < 0.001$ ; \*\* $P < 0.01$ .

although additional glucose was without effect, an isocaloric addition of propionate did increase the yield of milk protein (Hurtaud *et al.*, 1998b). This effect of propionate resurrects earlier ideas (see Thomas and Rook, 1983) on a role for propionate in the mechanism whereby an increase in the starch content of the diet leads to an increase in milk protein content (see above). Further comparisons of the effects of propionate and glucose itself on the use of amino acids in gluconeogenesis are needed.

A positive relationship between energy status of the cow and milk protein content emerges from an analysis of a large number of feeding trials (Coulon and Rémond, 1991). Increases in energy intake and energy balance would be expected to be associated with increased secretion of insulin (Vernon, 1988; Lalman *et al.*, 2000). In this connexion, the reported effect of insulin on milk protein concentration in experiments using the hyperinsulinaemic-euglycaemic clamp (Griinari *et al.*, 1997) is interesting. However, the results are difficult to interpret. Apart from the unphysiological levels of insulin and glucose infused, the effects of insulin are hopelessly compounded with the effects of an increased ME intake (Griinari *et al.*, 1997) or, in the case of Mackle *et al.* (1999), with the known additive effects of ME intake and amino acid supply (Gordon, 1979). Moreover, there is other evidence that argues against a general relationship between milk protein content and insulin or energy status. Infusing casein postruminally in increasing doses progressively increases the concentration of milk protein (Ørskov *et al.*, 1977; Whitelaw *et al.*, 1986; Choung and Chamberlain, 1993a). However, in all these experiments, the increases in milk protein content went hand in hand with a decrease, rather than an increase, in energy balance, regardless of whether the energy balance was substantially positive (Choung and Chamberlain, 1993a) or markedly negative (Ørskov *et al.*, 1977; Fig. 20.7). Hence the postruminal supplements of casein redirected nutrient use towards the udder at the expense of tissue deposition when the cow was in positive energy balance and stimulated mobilization of body tissue when the cow was already in negative energy balance. Neither action is compatible with an increased



**Fig. 20.7.** The effect of infusion of casein into the abomasum on energy balance in lactating dairy cows. The range in energy balance over all experiments was +20 to -41 MJ day<sup>-1</sup>. (Data of Ørskov *et al.*, 1977; Whitelaw *et al.*, 1986; Choung and Chamberlain, 1993a.)

secretion of insulin (Vernon, 1988). The apparent relation between energy status and milk protein concentration (Coulon and Rémond, 1991) seen across a wide range of feeding experiments may again reflect the increased starch intake that usually follows an increase in concentrate allocation.

But insulin can affect milk protein concentration indirectly by regulating the availability of glucose for synthesis of lactose. When insulin was infused intravenously into dairy cows and no attempt was made to control blood glucose, the concentration of milk protein increased as the secretion of lactose, and hence milk yield, decreased (Thomas *et al.*, 1987; Table 20.4). Conversely, arterial infusion of glucose in the goat increased milk yield and reduced the concentration of milk protein (Mephram and Linzell, 1974). These two experiments confirm what would be expected from simple theory: variations in the relative availability of glucose and amino acids might lead to changes in milk protein concen-



**Table 20.4.** Effects of intravenous infusion of insulin in dairy cows on the yield and composition of milk. (From Thomas *et al.*, 1987.)

	Control	Infusion	Control
Milk yield (kg day <sup>-1</sup> )	20.7	17.3	21.0
Protein (g day <sup>-1</sup> )	669	668	680
Lactose (g day <sup>-1</sup> )	972	762	969
Protein (g kg <sup>-1</sup> )	32.3	38.6	32.4
Blood glucose (mM)	4.0	2.2	4.1

tration. Kim *et al.* (2001c) further tested this hypothesis by infusing dairy cows intravenously with the first-limiting amino acid for the secretion of milk protein, given with or without glucose. They showed that, without glucose, the infusion led to an increased yield and concentration of milk protein whereas, when glucose was included in the infusion, the same increase in the yield of milk protein was accompanied by an increase in lactose secretion and milk volume, with the result that the concentration of protein was unchanged. It is worth noting that, in the experiment of Kim *et al.* (2001c), the effects of glucose on the secretion of lactose occurred when blood glucose was within the normal physiological range (hence the supply of glucose would be judged to be adequate). Moreover, circulating levels of insulin were unaffected by infusion of glucose, showing that milk protein content varied independently of insulin.

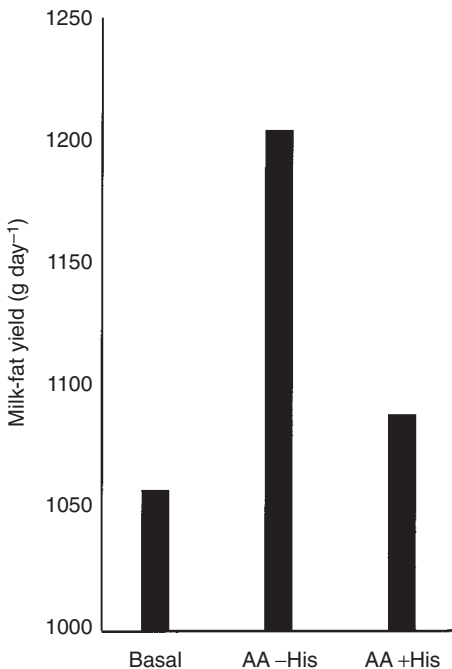
This is not to imply that glucose status is the key to understanding all the nutritional effects on milk protein content. Although simple relationships emerge in some experiments (e.g. Kim *et al.*, 2001c), results of other experiments discussed above show the mechanisms, or at least their interactions, to be more complex. Progress in unravelling the causes of the effects is hampered by the difficulty in defining nutrient status in enough detail; in the absence of this information, any suggested mechanisms must remain speculative.

### Effects of Amino Acid Supply on the Secretion of Milk Fat

Overall, increasing amino acid supply, whether by changes in protein feeding or by post-ruminal infusion of protein or amino

acids or intravenous infusion of amino acids, has variable effects on the secretion of milk fat. However, it is well known that supplements of methionine often increase the yield and concentration of milk fat and this occurs when the methionine is added to the diet, in rumen-protected form (Overton *et al.*, 1996) or as methionine hydroxy analogue (MHA) (Huber *et al.*, 1984), or infused post-ruminally (Varvikko *et al.*, 1999) or intravenously (Chamberlain and Thomas, 1982). It has been suggested that the effects of methionine on the secretion of milk fat might be linked to a stimulation of the synthesis of lipoproteins and hence increased transport of triglycerides to the udder (Pullen *et al.*, 1989).

However, the effects of amino acid supply on the secretion of milk fat are not limited to methionine. Diets deficient in histidine led to increased concentrations of milk fat (Chamberlain *et al.*, 1992). Moreover, intravascular infusion of amino acid mixtures deficient in histidine markedly increased the yield and concentration of milk fat (Kim *et al.*, 1999, 2001b; Cant *et al.*, 2001) and reintroduction of histidine returned the fat concentration to the starting level (Kim *et al.*, 1999, 2001b; Fig. 20.8). It is difficult to know whether the effects of amino acid supply are due to specific actions of particular amino acids, such as methionine and histidine, or whether they relate to amino acid balance more generally. It is known that, in the experiments of Kim *et al.* (1999, 2001b), histidine was the first-limiting amino acid for secretion of milk protein and the infusion of amino acid mixtures lacking histidine would therefore fit the classical definition of an amino acid imbalance (Harper *et al.*, 1970). In many of the experi-



**Fig. 20.8.** The effect on the secretion of milk fat of the intravenous infusion of a mixture of amino acids with or without histidine. The infusions consisted of (g day<sup>-1</sup>): methionine, 8; lysine, 28; tryptophan, 2.5 (AA-His); and histidine, 6 (AA+His). (Data of Kim *et al.*, 2001b.)

ments in which adding methionine to the diet has increased the yield or content of milk fat, it was not the first-limiting amino acid for protein secretion, as judged by the absence of any effect on the yield of milk protein (e.g. Varvikko *et al.*, 1999). In these circumstances, addition of methionine might be expected to induce an amino acid imbalance. A mechanism whereby increases in fat secretion might arise from supplying the mammary gland with an unbalanced mixture has been suggested by Cant *et al.* (1999). From the observation by Bequette *et al.* (1998) that a deficiency of histidine led to a marked increase in mammary blood flow, Cant *et al.* (1999) suggest that the increased blood flow might lead inevitably to an increased uptake of fat precursors by the gland. That an increased fat secretion would follow automatically from an increased mammary blood flow is supported by the finding

that the mammary uptake of fat precursors seems to be regulated primarily by their arterial concentrations (Nielsen and Jakobsen, 1994). Whether the increased mammary blood flow is a response specifically to deficiency of histidine is not known but it is pertinent to note that a similar tendency was observed during an experimentally imposed deficiency of leucine (see Bequette *et al.*, 2000), raising the possibility that the effect might be more general.

Other circumstances in which an enhanced supply of amino acids stimulates secretion of milk fat may also be related to effects on amino acid balance. As already mentioned (see above), abomasally infused hydrolysates of casein or corresponding mixtures of free amino acids were less effective than whole casein in stimulating the secretion of milk protein. It was suggested (see above) that the inferior response to the hydrolysates and free amino acids might relate to effects on the balance of amino acids in portal blood. It is noteworthy that the lower response of milk protein was accompanied by very marked increases of milk fat concentration and yield (Choung and Chamberlain, 1993b, 1995a), again suggesting a link between amino acid balance and the secretion of milk fat. More information is needed before reaching firm conclusions but it is tempting to speculate that changes in milk fat might be a useful indicator of the optimum balance of amino acids in infused mixtures. Extending this idea to the evaluation of practical diets might be more difficult because of the intervention of the other dietary factors known to affect milk fat. But, at the very least, we should add amino acid balance to the list of dietary factors that affect the concentration of milk fat and attention should be given to defining how the various factors interact. When added to the results of the infusion studies described here, the finding that intraperitoneal injection of a mixture of branched-chain amino acids (BCAA) and arginine offset milk-fat depression in cows given a low-fibre diet in early lactation (Hopkins *et al.*, 1994) suggests that amino acid supply might have a more pronounced influence on milk fat secretion than hitherto suspected.

## Conclusions

This chapter has dealt mostly with what are nowadays termed 'empirical' observations. One could be forgiven for thinking that the term is used in a derogatory sense by some researchers, almost as a euphemism for 'superficial and hence of little explanatory power'. To some extent, this is understandable, given the prevailing drive to uncover mechanistic explanations at the lowest, ultimately molecular, level. Moreover, as our ability to move to lower and lower levels of investigation increases, so the previous level becomes labelled as empirical as opposed to mechanistic and hence the terms are relative. Infusion studies and feeding trials of the type considered here are valuable in two respects. First, their results can identify relationships and thereby direct the search for underlying mechanisms. The effects of amino acid balance on the secretion of milk fat emerged from feeding trials and relatively simple infusion experiments; they would probably have taken much longer to appear in experiments on amino acid uptake by the mammary gland, especially if such experiments were done *in vitro*. Secondly, results from experiments of this type can act as a 'reality check' for putative mechanisms arising from observations made at more fundamental levels; in other words, they are closer to the 'real world'.

To understand the mechanisms underlying the effects of amino acids on milk production, we need a balanced, integrated approach to experimentation. It is difficult to deny that considerable effort is going into feeding trials that have limited value in this regard. The use of experimental resources in what appears to be a haphazard testing of rumen-protected sources of methionine and lysine is of concern. Although it might have commercial value, it will probably yield little of scientific worth. Progress at this level would be greatly helped by the availability of rumen-protected forms of all the EAAs since it looks as though reproducible responses, across a range of diet types, will depend on adding a group of several amino acids rather than one or two. On the other hand, post-ruminal infusion of proteins is a technique that could provide much-needed information of direct relevance to diet formulation. However, it is essential that we move away from the use of casein

because it clearly does not behave as a typical feed protein. Attention should be given to easing the practical problems of infusing feed proteins. That would allow us to assess the value of protein sources in ways that go beyond present measurements, which effectively consist of little more than estimated rumen-degradability. Such assessments would then need to be confirmed in feeding trials. Our understanding of factors that regulate the concentration of protein in milk remains poor, despite some established empirical relationships. This is an area in need of help from more fundamental studies of the partition of amino acid use, including its regulation by the availability of specific glucose precursors but it is difficult to see how this can be achieved without detailed knowledge of nutrient status. It is also important that experiments to examine possible roles of hormones, such as insulin, be carried out using physiological amounts of hormones and of any infused substrates. A response to supraphysiological amounts of a hormone does not signify a role for that hormone in the mechanisms operating in normal physiology; to assume the contrary is of little help to our understanding and might well hinder it.

Any investigation of the effects of amino acids on milk production is likely to have implications for protein-rationing schemes, all of which remain at an immature stage. Of key importance is the efficiency of amino acid use for secretion of milk protein. Although much more information is needed, we should take note of what present results show. More experiments are needed to test the suggestion that short-term experiments may yield misleading results because they take insufficient account of body stores. Long-term experiments pose their own difficulties, especially when post-ruminal or intravascular infusion or sophisticated labelling techniques are to be used. This is clearly an area needing to be approached from different levels, with metabolic investigations properly integrated with feeding experiments, such that the two levels are genuinely complementary. If the partition of amino acid use between udder and body varies in ways that can be predicted only with detailed information on the status of body tissue stores, we may need some fresh thinking about our approach to protein feeding standards for lactation.

## References

- AFRC (Agricultural and Food Research Council) (1992) Nutritive requirements of ruminant animals: Protein. Technical Committee on Responses to Nutrients, Report No. 9. *Nutrition Abstracts and Reviews, Series B* 62, 787–835.
- Bassett, J.M. (1975) Dietary and gastro-intestinal control of hormones regulating carbohydrate metabolism in ruminants. In: McDonald, I.W. and Warner, A.C.I. (eds) *Digestion and Metabolism in the Ruminant*. University of New England Publishing Unit, Armidale, pp. 383–398.
- BBSRC (Biotechnology and Biological Sciences Research Council) (1998) *Responses in the Yield of Milk Constituents to the Intake of Nutrients by Dairy Cows*. BBSRC Technical Committee on Responses to Nutrients, Report No. 11. CAB International, Wallingford, UK.
- Beever, D.E. (1996) Meeting the protein requirements of ruminant livestock. *South African Journal of Animal Science* 26, 20–26.
- Bequette, B.J. and Backwell, F.R.C. (1997) Amino acid supply and metabolism in the ruminant mammary gland. *Proceedings of the Nutrition Society* 56, 593–605.
- Bequette, B.J., Backwell, F.R.C., Calder, A.G., Metcalf, J.A., Beever, D.E., MacRae, J.C. and Lobley, G.E. (1997) Application of a U-<sup>13</sup>C-labelled tracer in lactating dairy goats for simultaneous measurements of the flux of amino acids in plasma and the partition of amino acids to the mammary gland. *Journal of Dairy Science* 80, 2842–2853.
- Bequette, B.J., Backwell, F.R.C. and Crompton, L.A. (1998) Current concepts of amino acid and protein metabolism in the mammary gland of the lactating ruminant. *Journal of Dairy Science* 81, 2540–2559.
- Bequette, B.J., Hanigan, M.D., Calder, A.G., Reynolds, C.K., Lobley, G.E. and MacRae, J.C. (2000) Amino acid exchange by the mammary gland of lactating goats when histidine limits milk production. *Journal of Dairy Science* 83, 765–775.
- Beynen, A.C., West, C.E., Spaaij, C.J.K., Huisman, J., van Leeuwen, P., Schutte, J.B. and Hackeng, W.H.L. (1990) Cholesterol metabolism, digestion rates and postprandial changes in serum of swine fed purified diets containing either casein or soybean protein. *Journal of Nutrition* 120, 422–430.
- Blum, J.W., Bruckmaier, R.M. and Jans, F. (1998) Rumen-protected methionine fed to dairy cows: bioavailability and effects on plasma amino acid pattern and insulin concentrations. *Journal of Dairy Science* 82, 1991–1998.
- Botts, R.L., Hemken, R.W. and Bull, L.S. (1979) Protein reserves in the lactating dairy cow. *Journal of Dairy Science* 62, 433–440.
- Bruckental, I., Ascarelli, I., Yosif, B. and Alumot, E. (1991) Effect of duodenal proline infusion on milk production and composition in dairy cows. *Animal Production* 53, 299–303.
- Cant, J.P., Qiao, F. and Toerien, C.A. (1999) Regulation of mammary metabolism. In: Lobley, G.E., White, A. and MacRae, J.C. (eds) *Protein Metabolism and Nutrition*. EAAP Publication No. 96, Aberdeen, Scotland, pp. 203–219.
- Cant, J.P., Trout, D.R., Qiao, F. and McBride, B.W. (2001) Milk composition responses to unilateral arterial infusion of complete and histidine-lacking amino acid mixtures to the mammary glands of cows. *Journal of Dairy Science* 84, 1192–1200.
- Castillo, A.R., Kebreab, E., Beever, D.E., Barbi, J., Sutton, J.D., Kirby, H.C. and France, J. (2001) The effect of energy supplementation on nitrogen utilization in lactating dairy cows. *Journal of Animal Science* 79, 240–246.
- Chamberlain, D.G. and Choung, J.-J. (1995) The importance of the rate of ruminal fermentation of energy sources in diets for dairy cows. In: Garnsworthy, P.C. and Cole, D.J.A. (eds) *Recent Advances in Animal Nutrition – 1995*. Nottingham University Press, Nottingham, pp. 3–27.
- Chamberlain, D.G. and Thomas, P.C. (1982) Effects of intravenous supplements of L-methionine on milk yield and composition in cows given silage-cereal diets. *Journal of Dairy Research* 49, 25–28.
- Chamberlain, D.G., Martin, P.A. and Robertson, S. (1989) Optimizing compound feed use in dairy cows with high intakes of silage. In: Haresign, W. and Cole, D.J.A. (eds) *Recent Advances in Animal Nutrition – 1989*. Butterworths, London, pp. 175–193.
- Chamberlain, D.G., Choung, J.-J. and Robertson, S. (1992) Protein nutrition of dairy cows receiving grass silage diets: effects of feeding a protein supplement of unbalanced amino acid composition. *Journal of the Science of Food and Agriculture* 69, 425–430.
- Choung, J.-J. and Chamberlain, D.G. (1992a) Protein nutrition of dairy cows receiving grass silage diets. The effects of post-ruminal supplements of proteins and amino acids. *Journal of the Science of Food and Agriculture* 60, 25–30.

- Choung, J.-J. and Chamberlain, D.G. (1992b) Effects of abomasal infusions of sodium caseinate, soya-protein isolate and a water extract of fish meal on the utilization of nitrogen by dairy cows. *Journal of the Science of Food and Agriculture* 60, 131–133.
- Choung, J.-J. and Chamberlain, D.G. (1992c) The effect of the addition of cell-wall degrading enzymes at ensiling on the response to postprandial supplementation of protein in dairy cows receiving a silage-based diet. *Journal of the Science of Food and Agriculture* 60, 525–528.
- Choung, J.-J. and Chamberlain, D.G. (1993a) The effects of abomasal infusions of casein or soya-bean-protein isolate on the milk production of dairy cows in mid-lactation. *British Journal of Nutrition* 69, 103–115.
- Choung, J.-J. and Chamberlain, D.G. (1993b) Effects on milk yield and composition of intra-abomasal infusions of sodium caseinate, an enzymic hydrolysate of casein or soya-protein isolate in dairy cows. *Journal of Dairy Research* 60, 133–138.
- Choung, J.-J. and Chamberlain, D.G. (1995a) Effects of abomasal infusions of sodium caseinate, a hydrolysate of casein or a corresponding mixture of free amino acids on milk yield and composition in dairy cows. *Journal of Dairy Research* 62, 29–37.
- Choung, J.-J. and Chamberlain, D.G. (1995b) Effects of abomasal infusions of sodium caseinate and of casein hydrolysates varying in the relative proportions of peptides and free amino acids on milk production in dairy cows. *Journal of Dairy Research* 62, 423–429.
- Choung, J.-J. and Chamberlain, D.G. (1995c) The effects of intravenous supplements of amino acids on the milk production of dairy cows consuming grass silage and a supplement containing feather meal. *Journal of the Science of Food and Agriculture* 68, 265–270.
- Choung, J.-J. and Chamberlain, D.G. (1998) Milk production responses to postprandial supply of peptide in the dairy cow. In: Grimble, G. and Blackwell, F.J.C. (eds) *Peptides in Mammalian Protein Metabolism*. Portland Press, London, pp. 79–90.
- Cianciaruso, B., Jones, M.R. and Kopple, J.D. (1981) Histidine an essential amino acid for adult dogs. *Journal of Nutrition* 111, 1074–1084.
- Clark, J.H. (1975) Lactational responses to postprandial administration of proteins and amino acids. *Journal of Dairy Science* 58, 1178–1197.
- Coulon, J.B. and Rémond, B. (1991) Variations in milk output and milk protein content in response to the level of energy supply to the dairy cow: a review. *Livestock Production Science* 29, 31–47.
- Daenzer, M., Petzke, K.J., Bequette, B.J. and Metges, C.G. (2001) Whole-body and splanchnic amino acid metabolism differ in rats fed mixed diets containing casein or its corresponding amino acid mixture. *Journal of Nutrition* 131, 1965–1972.
- Danfaer, A., Tetens, V. and Agergaard, N. (1995) Review and an experimental study on the physiological and quantitative aspects of gluconeogenesis in lactating ruminants. *Comparative Biochemistry and Physiology* 111B, 201–210.
- Davis, A.J. and Austic, R.E. (1994) Dietary amino acid balance and metabolism of the limiting amino acid. In: *Proceedings of the Cornell Nutrition Conference for Feed Manufacturers*, Cornell University, New York, pp. 70–81.
- Frandson, R.D. (1981) *Anatomy and Physiology of Farm Animals*. Lea and Febiger, Philadelphia, p. 249.
- Gordon, F.J. (1979) The effect of protein content on the response of lactating cows to level of concentrate feeding. *Animal Production* 25, 181–191.
- Griinari, J.M., McGuire, M.A., Dwyer, D.A., Bauman, D.E., Barbano, D.M. and House, W.M. (1997) The role of insulin in the regulation of milk protein synthesis in dairy cows. *Journal of Dairy Science* 80, 2361–2371.
- Guinard, J., Rulquin, H. and Vérité, R. (1994) Effects of graded levels of duodenal infusions of casein on mammary uptake of lactating cows. 1. Major nutrients. *Journal of Dairy Science* 77, 2221–2231.
- Hara, H., Funabiki, R., Iwata, M. and Yamazaki, K.I. (1984) Portal absorption of small peptides in rats in unrestrained conditions. *Journal of Nutrition* 114, 1122–1129.
- Harper, A.E., Benevenga, N.J. and Wohlheuter, R.M. (1970) Effects of ingestion of disproportionate amounts of amino acids. *Physiological Reviews* 50, 428–557.
- Hopkins, B.A., Rakes, A.H., Daniel, T.E., Zimmerman, C.A. and Croom, W.J. (1994) Effects of intraperitoneal L-leucine, L-isoleucine, L-valine and L-arginine on milk-fat depression in early lactation cows. *Journal of Dairy Science* 77, 1084–1092.
- Huber, J.T., Emery, R.S., Bergen, W.G., Liesman, J.S., Kung, K.J., Gardner, R.W. and Checketts, M. (1984) Influences of methionine hydroxy analog on milk and milk-fat production, blood serum lipids and plasma amino acids. *Journal of Dairy Science* 67, 2525–2531.

- Hurtaud, C., Rulquin, H. and Vérité, R. (1998a) Effects of graded duodenal infusions of glucose on yield and composition of milk from dairy cows. 1. Diets based on maize silage. *Journal of Dairy Science* 81, 3239–3247.
- Hurtaud, C., Rulquin, H. and Vérité, R. (1998b) Effects of level and type of energy source (volatile fatty acids or glucose) on milk yield, composition and coagulating properties in dairy cows. *Reproduction Nutrition Development* 38, 315–330.
- Hurtaud, C., Lemosquet, S. and Rulquin, H. (2000) Effect of graded duodenal infusions of glucose on yield and composition of milk from dairy cows. 2. Diets based on grass silage. *Journal of Dairy Science* 83, 2952–2965.
- Hvelplund, T. (1986) The influence of diet on nitrogen and amino acid content of mixed rumen bacteria. *Acta Agriculturae Scandinavica* 6, 325–331.
- Keady, T.W.J., Mayne, C.S. and Marsden, M. (1998) The effects of concentrate energy source on silage intake and animal performance with lactating cows offered a range of grass silages. *Animal Science* 66, 21–23.
- Keady, T.W.J., Mayne, C.S., Fitzpatrick, D.A. and Marsden, M. (1999) The effects of energy source and level of digestible undegradable protein in concentrates on silage intake and performance of lactating dairy cows offered a range of grass silages. *Animal Science* 68, 763–777.
- Kim, C.-H., Choung, J.-J. and Chamberlain, D.G. (1999) Determination of the first-limiting amino acid for milk production in dairy cows consuming a diet of grass silage and a cereal-based supplement containing feather meal. *Journal of the Science of Food and Agriculture* 79, 1703–1708.
- Kim, C.-H., Choung, J.-J. and Chamberlain, D.G. (2000a) Variability in the ranking of the three most-limiting amino acids for milk protein production in dairy cows consuming grass silage and a cereal-based supplement containing feather meal. *Journal of the Science of Food and Agriculture* 80, 1386–1392.
- Kim, C.-H., Choung, J.-J. and Chamberlain, D.G. (2000b) The effects of intravenous administration of amino acids and glucose on the milk production of dairy cows consuming diets based on grass silage. *Grass and Forage Science* 55, 173–180.
- Kim, C.-H., Choung, J.-J. and Chamberlain, D.G. (2001a) Responses of milk production to the intravenous infusion of amino acids in dairy cows given diets of grass silage and cereal-based supplements. *Journal of Animal Physiology and Animal Nutrition* 85, 293–300.
- Kim, C.-H., Choung, J.-J. and Chamberlain, D.G. (2001b) Estimates of the efficiency of transfer of histidine from blood to milk when it is the first-limiting for secretion of milk protein in the dairy cow. *Journal of the Science of Food and Agriculture* 81, 1150–1155.
- Kim, C.-H., Kim, T.-G., Choung, J.-J. and Chamberlain, D.G. (2001c) Effects of intravenous infusion of amino acids and glucose on the yield and concentration of milk protein in dairy cows. *Journal of Dairy Research* 68, 27–34.
- Kim, T.-G., Choung, J.-J., Wallace, R.J. and Chamberlain, D.G. (2000) Effects of intra-abomasal infusion of  $\beta$ -casomorphins on circulating concentrations of hyperglycaemic insulin and glucose in dairy cows. *Comparative Biochemistry and Physiology A* 127, 249–257.
- Korhonen, M., Vanhatalo, A., Varvikko, T. and Huhtanen, P. (2000) Responses to graded postnatal doses of histidine in dairy cows fed grass silage diets. *Journal of Dairy Science* 83, 2596–2608.
- Krebs, H.A. (1964) The metabolic fate of amino acids. In: Munro, H.A. and Allison, J.B. (eds) *Mammalian Protein Metabolism*, Vol. 1. Academic Press, New York, pp. 125–177.
- Lalman, D.L., Williams, J.E., Hess, B.W., Thomas, M.G. and Keisler, D.H. (2000) Effect of dietary energy on milk production and metabolic hormones in thin, primiparous beef heifers. *Journal of Animal Science* 78, 530–538.
- Mackie, T.R., Dwyer, D.A., Ingvarsen, K.L., Chouinard, P.Y., Lynch, J.M., Barbano, D.M. and Bauman, D.E. (1999) Effects of insulin and amino acids on milk protein concentration and yield from dairy cows. *Journal of Dairy Science* 82, 1512–1524.
- Meijer, G.A.L., van der Meulen, J. and van Vuuren, A.M. (1993) Glutamine is a potentially limiting amino acid for milk production in dairy cows. A hypothesis. *Metabolism* 42, 358–364.
- Meijer, G.A.L., de Visser, H., van der Meulen, J., van der Koelen, C.J. and Klop, A. (1996) Effect of glutamine or propionate infused into the abomasum on milk yield, milk composition, nitrogen retention and net flux of amino acids across the udder of high-yielding dairy cows. In: Nunes, A.F., Portugal, A.V., Costa, J.P. and Ribeiro, J.R. (eds) *Proceedings of the 7th International Symposium on Protein Metabolism and Nutrition*. European Association for Animal Production Publication No. 81, Rome, pp. 157–160.

- Mephram, T.B. (1982) Amino acid utilization by lactating mammary gland. *Journal of Dairy Science* 65, 287–298.
- Mephram, T.B. and Linzell, J.L. (1974) Effects of intramammary arterial infusion of non-essential amino acids and glucose in the lactating goat. *Journal of Dairy Research* 41, 111–121.
- Metcalfe, J.A., Wray-Cahen, D., Chettle, E.E., Sutton, J.D., Beever, D.E., Crompton, L.A., MacRae, J.C., Bequette, B.J. and Backwell, F.R.C. (1996a) The effect of dietary crude protein as protected soybean meal on mammary metabolism in the lactating dairy cow. *Journal of Dairy Science* 79, 603–611.
- Metcalfe, J.A., Crompton, L.A., Wray-Cahen, D., Lomax, M.A., Sutton, J.D., Beever, D.E., MacRae, J.C., Bequette, B.J. and Backwell, F.R.C. (1996b) Responses in milk constituents to intravascular administration of two mixtures of amino acids to dairy cows. *Journal of Dairy Science* 79, 1425–1429.
- Nielsen, M.O. and Jakobsen, K. (1994) Changes in mammary uptake of free fatty acids, triglycerides, cholesterol and phospholipid in relation to milk synthesis during lactation in goats. *Comparative Biochemistry and Physiology A* 109, 857–867.
- O'Connor, J.D., Sniffen, C.J., Fox, D.G. and Chalupa, W. (1993) A net carbohydrate and protein system for evaluating cattle diets. IV. Predicting amino acid adequacy. *Journal of Animal Science* 71, 1298–1311.
- Oldham, J.D. (1984) Protein-energy interrelationships in dairy cows. *Journal of Dairy Science* 67, 1090–1114.
- Oldham, J.D. (1994) Amino acid nutrition of the dairy cow. In: D'Mello, J.P.F. (ed.) *Amino Acids in Farm Animal Nutrition*. CAB International, Wallingford, pp. 351–375.
- Oldham, J.D. and Bines, J.A. (1983) Milk production in cows infused abomasally with casein, glucose or aspartic and glutamic acids in early lactation. *Proceedings of the Nutrition Society* 43, 65A.
- Ørskov, E.R., Grubb, D.A. and Kay, R.N.B. (1977) Effect of postruminal glucose or protein supplementation on milk yield and composition in Friesian cows in early lactation and negative energy balance. *British Journal of Nutrition* 38, 397–405.
- Overton, T.R., LaCount, D.W., Cicela, T.M. and Clark, J.H. (1996) Evaluation of a ruminally protected methionine product. *Journal of Dairy Science* 79, 631–638.
- Paquay, R., De Baere, R. and Lousse, A. (1972) The capacity of the mature cow to lose and recover nitrogen and the significance of protein reserves. *British Journal of Nutrition* 27, 27–38.
- Pisulewski, P.M., Rulquin, H., Peyraud, J.L. and Vérité, R. (1996) Lactational and systemic responses of dairy cows to postruminal infusions of increasing amounts of methionine. *Journal of Dairy Science* 79, 1781–1791.
- Pullen, D.L., Palmquist, D.L. and Emery, R.S. (1989) Effects on days of lactation and methionine hydroxy analog on incorporation of plasma fatty acids into plasma triglycerides. *Journal of Dairy Science* 72, 49–58.
- Rérat, A., Simoes Nunes, C., Mendy, F. and Roger, L. (1988) Amino acid absorption and production of pancreatic hormones in non-anaesthetized pigs after duodenal infusions of a milk enzymic hydrolysate or of free amino acids. *British Journal of Nutrition* 60, 121–136.
- Rook, J.A.F. (1983) Nutritional imbalances. In: Rook, J.A.F. and Thomas, P.C. (eds) *Nutritional Physiology of Farm Animals*. Longman, London, pp. 369–414.
- Rook, J.A.F. and Line, C. (1961) The effect of plane of nutrition of the cow on the secretion in milk of the constituents of the solids-not-fat fraction and on the concentration of certain blood plasma constituents. *British Journal of Nutrition* 15, 109–119.
- Rook, J.A.F. and Thomas, P.C. (1983) Milk secretion and its nutritional regulation. In: Rook, J.A.F. and Thomas, P.C. (eds) *Nutritional Physiology of Farm Animals*. Longman, London, pp. 314–368.
- Rulquin, H. (1986) Influence of the amino acid composition of three duodenally infused proteins on milk secretion in the dairy cow. *Reproduction Nutrition Development* 26, 347–348.
- Rulquin, H. and Delaby, L. (1997) Effects of the energy balance of dairy cows on lactational responses to rumen-protected methionine. *Journal of Dairy Science* 80, 2513–2522.
- Rulquin, H. and Vérité, R. (1993) Amino acid nutrition of dairy cows: productive effects and animal requirements. In: Garnsworthy, P.C. and Cole, D.J.A. (eds) *Recent Advances in Animal Nutrition – 1993*, Nottingham University Press, Nottingham, pp. 55–77.
- Rulquin, H., Pisulewski, P.M., Vérité, R. and Guinard, J. (1993) Milk production and composition as a function of postruminal lysine and methionine supply: a nutrient-response approach. *Livestock Production Science* 37, 69–90.
- Rulquin, H., Guinard, J. and Vérité, R. (1998) Variation of amino acid content in the small intestine of cattle: development of a prediction model. *Livestock Production Science* 53, 1–13.

- 
- Schwab, C.G., Satter, L.D. and Clay, A.B. (1976) Response of lactating dairy cows to abomasal infusion of amino acids. *Journal of Dairy Science* 59, 1254–1269.
- Schwab, C.G., Bozak, C.K., Whitehouse, N.L. and Olsen, V.M. (1992) Amino acid limitation and flow to the duodenum at four stages of lactation. 2. Extent of lysine limitation. *Journal of Dairy Science* 75, 3503–3518.
- Thomas, P.C. and Chamberlain, D.G. (1984) Manipulation of milk composition to meet market needs. In: Haresign, W. and Cole, D.J.A. (eds) *Recent Advances in Animal Nutrition – 1984*. Butterworths, London, pp. 219–244.
- Thomas, P.C. and Rook, J.A.F. (1983) Milk production. In: Rook, J.A.F. and Thomas, P.C. (eds) *Nutritional Physiology of Farm Animals*. Longman, London, pp. 558–622.
- Thomas, P.C., Chamberlain, D.G., Martin, P.A. and Robertson, S. (1987) Dietary energy intake and milk yield and composition in dairy cows. In: Moe, P.W., Tyrell, H.F. and Reynolds, P.W. (eds) *Proceedings of the 10th International Symposium on Energy Metabolism*, EAAP, Airlie, pp. 17–20.
- Vanhatalo, A., Huhtanen, P., Toivonen, V. and Varvikko, T. (1999) Responses of dairy cows fed grass silage diets to abomasal infusions of histidine alone or in combinations with lysine and methionine. *Journal of Dairy Science* 82, 2674–2685.
- Varvikko, T., Vanhatalo, A., Jalava, T. and Huhtanen, P. (1999) Lactation and metabolic responses to graded abomasal doses of methionine and lysine in cows fed grass silage diets. *Journal of Dairy Science* 82, 2659–2673.
- Vernon, R.G. (1988) The partition of nutrients during the lactation cycle. In: Garnsworthy, P.C. (ed.) *Nutrition and Lactation in the Dairy Cow*. Butterworths, London, pp. 32–52.
- Whitelaw, F.G., Milne, J.S., Ørskov, E.R. and Smith, J.S. (1986) The nitrogen and energy metabolism of lactating cows given abomasal infusions of casein. *British Journal of Nutrition* 55, 537–556.





# 21 Predicting Dietary Amino Acid Adequacy for Ruminants

D.G. Fox\* and L.O. Tedeschi

Department of Animal Science, Cornell University, Ithaca, New York, USA

---

## Introduction

We use ruminants around the world to convert forages, feed grains and food by-products into human food under production conditions that vary in soil, climate, feed composition and genotype of cattle. It is well accepted that animals perform to the level allowed by the first limiting nutrient. Thus, accurate prediction of dietary adequacy for nutrients, including amino acids, depends on the interaction of these variables in each unique production situation. Because of the complexities of accounting for these interactions, computer models are needed to accurately evaluate diet adequacy for amino acids on each farm. In case studies and field experiences, we have found that the efficiency of ruminant production can be improved by using models to account for performance variation by accurately predicting requirements and feed utilization in individual production settings (Fox *et al.*, 2000a).

The dietary supply of amino acids and animal requirements for them are dependent on a number of variables (i.e. fermentable energy allowable microbial amino acid production, undegraded feed protein escaping ruminal fermentation, energy allowable animal production). Therefore, accurate prediction of diet adequacy for amino acids in each produc-

tion situation depends on the ability of a model used to predict requirements and supply of ruminally degraded carbohydrates, protein, microbial growth, total digestible nutrients (TDN), metabolizable energy (ME), net energy (NE), heat increment (HI), metabolizable protein (MP), net protein (NP) and essential amino acids (EAA). Formulating rations for varying amino acid requirements thus requires an accounting system for the variables known to influence requirements and dietary supply of energy and absorbed amino acids.

There are few published models available for evaluating dietary amino acid adequacy that have been designed for field application internationally. Rulquin *et al.* (1998) and NRC (2001) developed empirical models to predict the content of amino acids in the duodenal protein for lactating dairy cows, with determination of diet amino adequacy being based on percentages of methionine and lysine in the absorbed protein. The Cornell Net Carbohydrate and Protein System (CNCPS) contains a factorial system that predicts essential amino acid requirements based on tissue and milk composition, mechanistically predicts flow of amino acids to the small intestine, from diet intake, and evaluates diet amino acid adequacy based on the difference between metabolizable requirements for each EAA compared to the

\*E-mail address: dgf4@cornell.edu

supply of metabolizable requirements for all classes of cattle and sheep. This model has been published and evaluated by Russell *et al.* (1992), Sniffen *et al.* (1992), Fox *et al.* (1992, 1995, 1999, 2000b), O'Connor *et al.* (1993), Ainslie *et al.* (1993), Tylutki *et al.* (1994), Pitt *et al.* (1996), Fox and Tylutki (1998), NRC (2000), Tedeschi *et al.* (2000c), Cannas (2000) and Ruiz *et al.* (2002). Because of its use internationally for all classes of cattle and sheep, this chapter will describe the prediction of dietary amino acid adequacy for ruminants within the structure of the CNCPS, and its application in predicting requirements of ruminants in diverse production situations. For a complete listing of the equations in the CNCPS model and the software for using it, the reader is referred to Fox *et al.* (2000b). The CD containing the model and the publications used in model development and evaluation are available from the authors (dgt4@cornell.edu or lot1@cornell.edu).

### **Prediction of Diet Amino Acid Balances Within the Structure of the CNCPS**

The definition of a model by Gill *et al.* (1989) describes the CNCPS; an integrated set of equations and transfer coefficients that represent the various physiological functions in cattle and sheep. Included are predictions of tissue requirements (maintenance, growth, pregnancy, lactation and tissue reserves), and supply of nutrients to meet requirements (feed carbohydrate and protein fractions, their characteristic digestion and passage rates, microbial growth, intestinal digestion and metabolism of absorbed nutrients). The purpose of a model is to describe mathematically the response of each compartment or several connected compartments to a variable or combination of variables. A model is considered to be mechanistic when it simulates behaviour of a function through processes operating at a lower level (Gill *et al.*, 1989). Most biological responses are integrated, non-linear and dynamic (Sauvant, 1991). A model that is totally mechanistic will accurately simulate whole-animal metabolism under all conditions with little risk of use but such a model is

beyond the capability of existing science (Gill *et al.*, 1989). Furthermore, ration formulation models are limited by the quality and availability of information about all of the model compartments, and by the amount of data and work needed to test and validate the functions of such a model. The knowledge of metabolism of nutrients is not as advanced as the prediction of ruminal fermentation, because of the almost infinite metabolic routes connecting various tissue and metabolic compartments, the multiple nutrient interactions, and the sophisticated metabolic regulations that determine the partitioning of absorbed nutrients (homeorhesis and homeostasis) (Sauvant, 1991). Therefore, the CNCPS model uses a combination of mechanistic and empirical approaches, assumes steady-state conditions, and uses statistical representations of data that describe the aggregated response of whole compartments (Fox *et al.*, 2000b).

A key challenge in modelling ruminant nutrition is in determining the most appropriate level of aggregation of knowledge (whole animal, physiological function, cellular, subcellular, etc.). The most critical step is to describe the objective of the model, and then to determine the appropriate mix of empirical and mechanistic representations of physiological functions needed to meet the objective. These decisions are made based on the availability of development and validation data, whether the needed inputs are typically available, and a risk-benefit analysis of the increased sensitivity (Fox *et al.*, 1995, 2000b). Because the CNCPS model is used on farms, it must be able to accurately predict animal requirements and supply of nutrients from inputs that are routinely available on most farms, it must provide output that will help producers improve their feeding programmes, and the risk of use must be small. To continue to be a tool to apply current scientific knowledge, it must have a structure that can be readily updated and refined as new knowledge becomes available.

The CNCPS model contains a biologically based structure to evaluate diets for all classes of cattle (i.e. beef, dairy and dual purpose) and sheep based on consideration of the existing animals, feeds, management, and environmental conditions. The approach taken and level of aggregation of variables are

based on our experience in working with farmers and consultants to diagnose animal performance problems, and to develop more accurate feeding programmes. Over 20 years, separate submodels that can be classified by physiological function have been developed and refined: (i) feed intake and composition, (ii) rumen fermentation, (iii) intestinal digestion, (iv) metabolism, (v) maintenance, (vi) growth, (vii) pregnancy, (viii) lactation, (ix) reserves, and (x) nutrient excretion. New information has been periodically incorporated into these submodels. The user must have some nutritional knowledge to use the CNCPS because of the risks associated with not knowing how to choose inputs and interpret results. However, with training and experience, the CNCPS can be used to evaluate the interactions between animal type, production level, environment, feed composition and management to predict amino acid balances.

The following sections summarize how requirements and supply of amino acids are computed in the CNCPS model.

### Maintenance requirement for amino acids

The maintenance energy requirement is predicted from metabolic body size and rate

with adjustments reflecting breed type, physiological state, previous nutritional treatment, activity, environment (temperature, wind velocity, and animal surface area and insulation) and heat gain or loss required to maintain normal body temperature. The proportion of the energy and protein intake needed for productive functions cannot be accurately determined until the proportion needed for maintenance is determined. The combined animal and diet heat production must thus be determined to assess energy balance in a particular environment, requiring the prediction of both ME and NE. The amino acid requirements for maintenance are then computed from the prediction of sloughed protein and net tissue turnover losses, as predicted from metabolic faecal nitrogen, urinary nitrogen loss, and scurf protein, as shown in Equation [21.1].

$$MPAA_i = (AATISS_i \times 0.01 \times (MP_m \times 0.65)) / EAAM_i \quad [21.1]$$

Where  $MPAA_i$  is metabolizable requirement for the  $i^{\text{th}}$  absorbed amino acid ( $\text{g day}^{-1}$ );  $AATISS_i$  is amino acid composition of tissue (%) (Table 21.1);  $MP_m$  is metabolizable protein required for maintenance ( $\text{g day}^{-1}$ ); and  $EAAM_i$  is efficiency of use of the  $i^{\text{th}}$  amino acid for maintenance ( $\text{g g}^{-1}$ ) (Table 21.2).

**Table 21.1.** Amino acid composition of tissue and milk protein<sup>a</sup>.

Amino acid	Tissue <sup>b</sup> (AATISS)	Milk <sup>c</sup> (AALACT)	Ratios for milk production			
			CNCPS <sup>d</sup>	Schwab <sup>e</sup>	Rulquin <sup>f</sup>	NRC <sup>f</sup>
Methionine	1.97	2.71	5.3	5.5	2.5	2.4
Lysine	6.37	7.62	16.9	16.0	7.3	7.2
Histidine	2.47	2.74	6.2	5.5	–	–
Phenylalanine	3.53	4.75	9.4	10.0	–	–
Tryptophan	0.49	1.51	2.5	3.0	–	–
Threonine	3.90	3.72	9.4	8.9	–	–
Leucine	6.70	9.18	18.1	19.5	–	–
Isoleucine	2.84	5.79	11.5	11.4	–	–
Valine	4.03	5.89	12.5	13.0	–	–
Arginine	3.30	3.40	8.2	7.2	–	–

<sup>a</sup>Amino acid composition as g of amino acid 100 g<sup>-1</sup> of protein.

<sup>b</sup>Average of three studies summarized by whole empty body values of Ainslie *et al.* (1993).

<sup>c</sup>Waghorn and Baldwin (1984).

<sup>d</sup>Per cent of essential amino acids.

<sup>e</sup>Per cent of essential amino acids in the duodenum (Schwab, 1996).

<sup>f</sup>Per cent of metabolizable protein (Rulquin and Vérité, 1993; NRC, 2001).

**Table 21.2.** Utilization of individual absorbed amino acids for physiological functions<sup>a,b</sup>.

Amino acid	Maintenance (EAAM)	Pregnancy (EAAP)	Lactation (EAAL)
Methionine	0.85	0.35	1.00
Lysine	0.85	0.53	0.82
Histidine	0.85	0.32	0.96
Phenylalanine	0.85	0.48	0.98
Tryptophan	0.85	0.85	0.85
Threonine	0.85	0.57	0.78
Leucine	0.66	0.42	0.72
Isoleucine	0.66	0.32	0.66
Valine	0.66	0.32	0.62
Arginine	0.85	0.38	0.35

<sup>a</sup>Requirement for growth varies with stage of growth as determined by Ainslie *et al.* (1993). If EQSBW < 478 kg then EAAG = 0.834 – (0.00114 × EQSBW), where EAAG is the efficiency of amino acid for growth factor and EQSBW is equivalent shrunk body weight as described by Fox *et al.* (1992). Other values have been updated from O’Conner *et al.* (1993) by T. R. Overton (personal communication). Values are expressed as g g<sup>-1</sup>.

<sup>b</sup>These efficiencies are assumed to be valid at the point where supply matches requirements. Amino acids absorbed in excess of requirements will be used less efficiently, and those absorbed at levels below requirements will be used with a higher efficiency (Ruiz *et al.*, 2002).

### Predicting amino acid requirements for tissue deposition

Expected mature weight, actual body weight, and rate of growth are used to predict energy and protein content of growth, as described by Fox *et al.* (2000b) for cattle and by Cannas (2000) for sheep. Requirements for cattle growth are calculated using body weight, shrunk weight gain, body composition and relative body size. Accurate prediction of daily gain that can be expected for the metabolizable energy and protein consumed depends on accurate prediction of energy required for maintenance and composition of gain, which is related to the proportion of mature weight at a particular weight (Fox *et al.*, 1992; Tylutki *et al.*, 1994). A size-scaling system is used to adjust shrunk body weight (SBW) to a weight equivalent to a standard reference animal at the same stage of growth (Tylutki *et al.*, 1994; NRC, 2000). This equivalent shrunk body weight (EQSBW) is calculated as:

$$\text{EQSBW} = \text{SBW} \times (\text{SRW}/\text{MSBW}) \quad [21.2]$$

where SRW is mature weight of the standard reference animal, and MSBW is expected mature shrunk body weight if replacement heifers and is expected finished weight at the target body fat if growing and finishing steers, heifers or bulls. For herd replacement heifers, SRW is 478 kg. For growing and finishing steers, heifers or bulls, SRW is 400, 435, 462 or 478 kg if the target is to market at 22, 25, 27 or 28% body fat, respectively.

The body fat endpoints (22, 25, 27 or 28% body fat) are associated with devoid, traces, slight, and small degrees of marbling, respectively. This system requires accurate estimation of mature weight if breeding herd replacements or target finished weight if growing and finishing for beef. Representative weights of mature cull cows sold in average body condition score can be used as a starting point for estimating mature

weight for breeding herd replacements. Most cattle feeders are experienced with finished weights expected with feedlot finishing on a high grain diet with backgrounded calves or yearlings that have received an oestrogenic implant. Guidelines for other conditions are: (i) reduce finished weight 25–45 kg for non-use of an oestrogenic implant; (ii) increase finished weight for an aggressive implant programme, which usually involves use of an implant containing trenbolone acetate (TBA) plus oestrogen; (iii) increase finished weight 25–45 kg for extended periods at slow rates of gain; and (iv) decrease finished weight 25–45 kg for continuous use of a high-energy diet from weaning.

Equivalent empty body weight (EQEBW) is  $0.891 \times \text{EQSBW}$  and empty body gain (EBG) is  $0.956 \times \text{SBG}$  (shrunk body gain). These variables are used to predict required net energy for gain ( $\text{NE}_g$ ) to formulate least cost diets to support a target daily gain;  $\text{NE}_g$  ( $\text{Mcal day}^{-1}$ ) =  $0.0635 \times \text{EQEBW}^{0.75} \times \text{EBG}^{1.097}$ . Across all cattle types, these equations accounted for 94% of the variation in energy and 91% of the protein retained measured in body composition studies, with only a 2% bias. Similar results were obtained with Holstein heifers only (Fox *et al.*, 1999).

In evaluating if the current ration meets or exceeds the target daily gain, daily net energy available for gain (NEFG) from the diet after maintenance requirements are met is used along with the body weight adjusted to the weight of the standard reference animal to predict daily gain the diet will allow with the following equation:  $\text{SWG}$  ( $\text{kg day}^{-1}$ ) =  $13.91 \times \text{NEFG}^{0.9116} \times \text{EQSBW}^{-0.6837}$ . Net protein required for gain ( $\text{NP}_g$ ,  $\text{g day}^{-1}$ ) =  $\text{SWG} \times (268 - (29.4 \times (\text{NE}_g / \text{SWG})))$ .

Amino acid requirements for growth are then computed as follows:

$$\text{RPAA}_i = (\text{AATISS}_i \times 0.01 \times \text{NP}_g) / \text{EAAG}_i \quad [21.3]$$

where  $\text{RPAA}_i$  is growth requirement for the  $i^{\text{th}}$  absorbed amino acid ( $\text{g day}^{-1}$ );  $\text{AATISS}_i$  is the  $i^{\text{th}}$  amino acid composition of tissue (%) (Table 21.1);  $\text{NP}_g$  is net protein required for gain ( $\text{g day}^{-1}$ ); and  $\text{EAAG}_i$  is efficiency of use of the  $i^{\text{th}}$  amino acid for growth ( $\text{g g}^{-1}$ ) (Table 21.2).

### Prediction of pregnancy requirements for amino acids

Pregnancy requirements are predicted from uterine and conceptus demand based on expected birth weights and day of gestation [Equation 21.4]. These become critical in the accuracy of ration formulation during the last 90 days of pregnancy because that is the period of highest conceptus weight accumulation and demand.

$$\text{YPAA}_i = (\text{AATISS}_i \times 0.01 \times (\text{MP}_p \text{ MP}_{\text{Efficiency}})) / \text{EAAP}_i \quad [21.4]$$

where  $\text{YPAA}_i$  is metabolizable requirement for gestation for the  $i^{\text{th}}$  absorbed amino acid ( $\text{g day}^{-1}$ );  $\text{AATISS}_i$  is amino acid composition of tissue (%) (Table 21.1);  $\text{MP}_p$  is metabolizable protein required for pregnancy ( $\text{g day}^{-1}$ );  $\text{MP}_{\text{Efficiency}}$  is the efficiency of metabolizable to net protein, if dairy cows then  $\text{MP}_{\text{Efficiency}}$  is 0.33 otherwise it is 0.50; and  $\text{EAAP}_i$  is efficiency of use of the  $i^{\text{th}}$  amino acid for gestation ( $\text{g g}^{-1}$ ) (Table 21.2).

### Prediction of lactation requirements for amino acids

Lactation requirements are computed for varying day of lactation, levels and composition of milk. Using actual (dairy cows or sheep) or predicted (beef cows or meat sheep) milk production, metabolizable energy required for lactation is computed, assuming a 64.4% efficiency (NRC, 1989). Metabolizable protein requirements are computed from milk yield, milk protein content, and an efficiency of 65% (NRC, 1985) [Equation 21.5]:

$$\text{LPAA}_i = (\text{AALACT}_i \times 0.01 \times (\text{LP} \times 0.65)) / \text{EAAL}_i \quad [21.5]$$

where  $\text{LPAA}_i$  is metabolizable requirement for lactation for the  $i^{\text{th}}$  absorbed amino acid ( $\text{g day}^{-1}$ );  $\text{AALACT}_i$  is the  $i^{\text{th}}$  amino acid content of milk true protein (%) (Table 21.1);  $\text{LP}$  is metabolizable protein required for lactation ( $\text{g day}^{-1}$ ); and  $\text{EAAL}_i$  is efficiency of use of the  $i^{\text{th}}$  amino acid for milk protein formation ( $\text{g g}^{-1}$ ) (Table 21.2).

The CNCPS model then computes amino acid balance as the difference between

total requirements for each essential amino acid and the essential amino acids supplied by the diet, including those from microbial protein resulting from fermentation of dietary carbohydrates and those contained in ruminally undegraded feed protein. More empirical models express dietary amino acid requirements as the ratio of methionine to lysine (Rulquin and Vérité, 1993; Schwab, 1996; NRC, 2001). Table 21.1 summarizes these ratios. The optimization of these two amino acids 2 weeks prepartum and 4 weeks postpartum resulted in a response in milk production of 4–5 kg (Sniffen *et al.*, 2001). However, these authors concluded that the use of these ratios alone could result in failures if the ration did not meet the MP requirement or if the balances of other essential amino acids computed with the factorial method was negative. Sniffen *et al.* (2001) concluded that for lactating dairy cows, the factorial system should be used to meet MP and essential amino acid requirements, followed by balancing for the optimum ratios and profile of amino acids.

#### **Prediction of supply of amino acids to meet requirements**

The amino acids supplied in the CNCPS model depend on accurate determination of dry matter intake (DMI), ingredient content of carbohydrate and protein fractions and their content of essential amino acids in the ruminally undegraded protein, microbial growth on the fibre and non-fibre carbohydrates consumed and the amino acid content of rumen microbes and their intestinal digestibilities, and the unique rates of digestion and passage of the individual feed carbohydrate and protein fractions that are being fed. First limiting in the CNCPS is accurate determination of DMI, and whenever it is possible the actual DMI should be used instead of the predicted one for the group of animals being evaluated. Then, the predicted DMI may be used as a benchmark for diagnostic purposes, or when actual DMI is not available, including grazing ruminants.

The interactions of DMI, digestion and passage have several implications. First, the

growth rate of each microbial pool that digests respective available carbohydrate fractions, and thus the absorbable microbial amino acids produced, will depend on the special characteristics and intake of the feeds being fed, which in turn determines the demand for the nitrogen source required by each pool (Russell *et al.*, 1992; Sniffen *et al.*, 1992; Tedeschi *et al.*, 2000c). Secondly, the percentage of cell wall carbohydrate and protein that escapes digestion will change, depending on level of intake, particle size, specific gravity, rumination and degree of lignification (Sniffen *et al.*, 1992). Thirdly, the site of digestion and, depending on the rate of whole tract passage, the extent of digestion will be altered (Sniffen *et al.*, 1992; Fox *et al.*, 1992). Variable rates of digestion and passage have similar implications for protein fractions in feeds (Sniffen *et al.*, 1992). Those readily available will be degraded in the rumen, whereas those more slowly degraded will be partially degraded in the rumen and partially degraded postruminally, the proportion depending on rates of digestion and passage of the protein fractions in the feeds (Sniffen *et al.*, 1992).

Predicting the energy content of the ration is accomplished by estimating apparent TDN of each feed and for the total ration as described by Russell *et al.* (1992), Sniffen *et al.* (1992) and NRC (2000), and utilizing equations and conversion factors to estimate ME,  $NE_m$ ,  $NE_g$  and  $NE_l$  values, as described by Fox *et al.* (1992), NRC (2000) and Fox *et al.* (2000b). To calculate apparent TDN, apparent digestibilities for carbohydrates, proteins and fats are estimated. These apparent digestibilities are determined by simulating the degradation, passage and digestion of feedstuffs in the rumen and small intestine. Also, microbial yields and faecal composition are estimated. Feed composition values needed include: neutral detergent fibre (NDF), lignin, crude protein (CP), fat, ash and neutral detergent insoluble protein (NDIP) as a percentage of the diet DM, and starch and sugar expressed as a percentage of non-fibre carbohydrates.

Rumen microorganisms are categorized into those that ferment fibre carbohydrates

(FC) and non-fibre carbohydrate (NFC), as described by Russell *et al.* (1992) and the NRC (2000). Generally, FC microorganisms ferment cellulose and hemicellulose and grow more slowly, and utilize ammonia as their primary nitrogen source for microbial protein synthesis. In contrast, the NFC microorganisms ferment starch, pectin and sugars, grow more rapidly and can utilize ammonia and amino acids as nitrogen sources. The FC and NFC microorganisms have different maintenance requirements (the CNCPS uses 0.05 and 0.15 g of carbohydrate per g of microorganism per hour, respectively). Although the CNCPS does not compute specific amino acid requirements for microbial growth, the efficiency of growth of NFC digesting bacteria is optimized at 14% peptides as a percentage of NFC (Russell *et al.*, 1992). Thus the degradable protein requirement is for supporting optimal utilization of NFC and FC to meet respective microbial growth requirements, and microbial growth is reduced when they are deficient (Tedeschi *et al.*, 2000c). The rate of microbial growth of each category is directly proportional to the rate of carbohydrate digestion, so long as a suitable nitrogen source is available. The extent of digestion in the rumen depends on digestion of FC and NFC feed fractions and how rapidly the feed passes out of the rumen. The extent of digestion thus depends on factors such as level of intake, particle size, rate of hydration, lignification, and characteristics of each carbohydrate and protein fraction.

The ME, MP and amino acids derived in each situation will primarily depend on the unique rates of digestion and passage of the individual feed carbohydrate and protein fractions that are being fed. Digestion rates are feed specific, and depend primarily on type of starch and protein, degree of lignification, and degree of processing. Extent of ruminal digestion is a function of competition between digestion and passage, and varies with feed type (forage vs. grain) and particle size. There are four nitrogen fraction requirements that must be met in evaluating a diet with the CNCPS; two microbial categories (ammonia for the FC and peptides and ammonia for the NFC microbial pools), and two animal pools (MP and essential amino acids). In evaluating

a diet, one must be able to determine how well all four requirements are being met.

One of the critical factors affecting microbial growth is rumen pH. The CNCPS describes physical characteristics of feeds as related to their effectiveness in stimulating chewing, rumination and increased rumen motility based on their total cell wall content and particle size within classes of feeds (peNDF). The peNDF value in the CNCPS is defined as the percentage of the NDF retained on a 1.18 mm screen as described by Mertens (1997). Factors other than particle size that influence the peNDF value are degree of lignification of the NDF, degree of hydration, and bulk density. Pitt *et al.* (1996) described the relationship between CNCPS peNDF values, rumen pH and FC digestion. Total microbial yield and FC growth rate rapidly decline below a pH of 6.2, which relates to a diet peNDF content of 20%. The CNCPS reduces microbial yield 2.5 percentage units for each percentage drop in diet peNDF below 20%. Thus the diet peNDF must be accurately predicted to accurately predict microbial amino acid production and cell wall digestion.

Feed composition in the CNCPS is described by carbohydrate and protein fractions and their digestion rates, which are used to compute the amount of FC and NFC available for each of the two microbial pools (Sniffen *et al.*, 1992). Digestion and passage rates have been developed for common feeds, based on data in the literature, as described by Sniffen *et al.* (1992). All of the carbohydrate and protein fractions needed to predict the amounts of degradable carbohydrate and protein fractions available to support rumen fermentation can be determined in feed testing laboratories, using the Van Soest *et al.* (1991) system of feed analysis and proximate analysis. Included are NDF, CP, soluble protein, neutral and acid detergent insoluble protein, fat and ash. The CNCPS feed library contains over 150 feeds that are described by these analyses, as described by Sniffen *et al.* (1992). Included are digestion rates for sugars (CHO A), starch and pectin (CHO B1), available NDF (CHO B2) and fast (ProtB1), intermediate (ProtB2) and slow (ProtB3) protein. Total carbohydrates are computed as  $100 - (\text{protein} + \text{fat} + \text{ash})$ , using tabular or analytical values. Then carbo-



hydrates are partitioned into FC and NFC by subtracting NDF from total carbohydrates, with the available fibre being  $\text{NDF} - \text{NDF}_{\text{Protein}} - (\text{lignin} \times 2.4)$ . Data from the literature are used to establish the distribution of sugars and starch in the NFC fraction.

The growth of two microbial pools (FC and NFC) is then predicted, based on the integration of rates of digestion and passage, which in turn determines the nitrogen requirements of each pool, microbial protein produced and MP available from this source, carbohydrates escaping digestion and digested postruminally and ME derived from the diet. Passage rates are a function of level of intake, percentage forage and peNDF value. Simultaneously, the degraded and undegraded protein pools are predicted, which are used to determine nitrogen balance for each of the microbial pools, feed protein escaping undegraded and digested postruminally, and MP and amino acids derived from undegraded feed protein. The protein fractions are expressed as a percentage of the CP. The 'A' protein fraction is NPN (non-protein nitrogen) and the 'B1' fraction is true protein that is nearly all degraded in the rumen; these pools are measured as soluble protein. The 'C' protein fraction is measured as acid detergent-insoluble protein (ADIP) and is assumed to be unavailable. The 'B3' or slowly degraded protein fraction can be determined by subtracting the value determined for ADIP from the value determined for NDIP. The 'B2' fraction, which is partly degraded in the rumen, depending on digestion and passage rates, can then be estimated as the difference between CP and the sum of soluble + B3 + C. Amino acids in feedstuffs are described by their concentration in the undegraded protein, as described by O'Connor *et al.* (1993). Intestinal digestibility of the amino acids is assumed to be 100% in the B1 and B2 and 80% in the B3 protein escaping ruminal degradation.

Microbial composition of essential amino acids is used to calculate the supply of amino acids from bacteria, as shown in Equations [21.6] and [21.7].

$$\text{REBAA}_i = (\text{AABCW}_i \times 0.01 \times \text{REBCW}_j) + (\text{AABNCW}_i \times 0.01 \times \text{REBTP}_j) \quad [21.6]$$

$$\text{DIGBAA}_i = \sum_{j=1}^n \left( \text{AABNCW}_i \times 0.01 \times \text{REBTP}_j \right) \quad [21.7]$$

where  $\text{REBAA}_i$  is the amount of the  $i^{\text{th}}$  bacterial amino acid appearing at the duodenum ( $\text{g day}^{-1}$ );  $\text{REBCW}_j$  is the bacterial cell wall protein appearing at the duodenum as a result of fermentation of the  $j^{\text{th}}$  feedstuff ( $\text{g day}^{-1}$ );  $\text{AABCW}_i$  is the  $i^{\text{th}}$  amino acid content of rumen bacteria cell wall protein ( $\text{g } 100\text{g}^{-1}$ ) (Table 21.3);  $\text{AABNCW}_i$  is the  $i^{\text{th}}$  amino acid content of rumen bacteria non-cell wall protein ( $\text{g } 100\text{g}^{-1}$ ) (Table 21.3);  $\text{REBTP}_j$  is the bacterial non-cell wall protein appearing at the duodenum as a result of fermentation of the  $j^{\text{th}}$  feedstuff ( $\text{g day}^{-1}$ ); and  $\text{DIGBAA}_i$  is the amount of the  $i^{\text{th}}$  absorbed bacterial amino acid ( $\text{g day}^{-1}$ ).

Essential amino acid composition of the undegradable protein of each feedstuff is used to calculate supply of amino acids from the feeds:

$$\text{REFAA}_i = \sum_{j=1}^n \left( \text{AAINSP}_{ij} \times 0.01 \times (\text{REPB1}_j + \text{REPB2}_j + \text{REPB3}_j + \text{REPC}_j) \right) \quad [21.8]$$

where  $\text{AAINSP}_{ij}$  is the  $i^{\text{th}}$  amino acid content of the insoluble protein for the  $j^{\text{th}}$  feedstuff ( $\text{g } 100\text{g}^{-1}$ );  $\text{REFAA}_i$  is the amount of  $i^{\text{th}}$  dietary amino acid appearing at the duodenum ( $\text{g day}^{-1}$ );  $\text{REPB1}_j$  is the rumen escaped B1 protein from the  $j^{\text{th}}$  feedstuff ( $\text{g day}^{-1}$ );  $\text{REPB2}_j$  is the rumen escaped B2 protein from the  $j^{\text{th}}$  feedstuff ( $\text{g day}^{-1}$ );  $\text{REPB3}_j$  is the rumen escaped B3 protein from the  $j^{\text{th}}$  feedstuff ( $\text{g day}^{-1}$ ); and  $\text{REPC}_j$  is the rumen escaped C protein from the  $j^{\text{th}}$  feedstuff ( $\text{g day}^{-1}$ ).

Total metabolizable amino acid supply from microbial and feed protein is computed as shown in Equations [21.9]–[21.11].

$$\text{REAA}_i = \text{REBAA}_i + \text{REFAA}_i \quad [21.9]$$

$$\text{DIGFAA}_i = \sum_{j=1}^n \left( \text{AAINSP}_{ij} \times 0.01 \times (\text{REPB1}_j + \text{REPB2}_j + 0.8 \times \text{REPB3}_j) \right) \quad [21.10]$$

$$\text{AAAS}_i = \text{DIGBAA}_i + \text{DIGFAA}_i \quad [21.11]$$

where  $\text{REAA}_i$  is the total amount of the  $i^{\text{th}}$  amino acid appearing at the duodenum ( $\text{g day}^{-1}$ );  $\text{DIGFAA}_i$  is the amount of the  $i^{\text{th}}$  absorbed amino acid from dietary protein escaping rumen degradation ( $\text{g day}^{-1}$ );  $\text{AAAS}_i$  is the total amount of the  $i^{\text{th}}$  absorbed amino acid supplied by dietary and bacterial sources ( $\text{g day}^{-1}$ ).

**Table 21.3.** Amino acid composition of rumen microbial cell wall and non-cell wall protein<sup>a</sup>.

Amino acids	Cell wall	Non-cell wall	Ruminal bacteria <sup>b</sup>	
			Mean	SD
Methionine	2.40	2.68	2.60	0.7
Lysine	5.60	8.20	7.90	0.9
Histidine	1.74	2.69	2.00	0.4
Phenylalanine	4.20	5.16	5.10	0.3
Tryptophan	1.63 <sup>c</sup>	1.63	—	—
Threonine	3.30	5.59	5.80	0.5
Leucine	5.90	7.51	8.10	0.8
Isoleucine	4.00	5.88	5.70	0.4
Valine	4.70	6.16	6.20	0.6
Arginine	3.82	6.96	5.10	0.7

<sup>a</sup>Amino acid composition as % of protein.

<sup>b</sup>Average composition and SD (standard deviation) of 441 bacterial samples from animals fed 61 dietary treatments in 35 experiments (Clark *et al.*, 1992). Included for comparison to the cell wall and non-cell wall values used in this model.

<sup>c</sup>Data were not available, therefore, content of cell wall protein was assumed to be same as non-cell wall protein (O'Connor *et al.*, 1993).

### Prediction of intestinal digestion and excretion

Experimentally measured digestibility coefficients are used to predict intestinal digestibilities and faecal losses based on summaries of data in the literature (Sniffen *et al.*, 1992; Knowlton *et al.*, 1998). The total NDF escaping the rumen is assumed to have an intestinal digestibility of only 20% because the small intestine lacks the enzymes to digest cellulose and hemicellulose. Intestinal digestibilities for protein fractions and amino acids that escape the rumen are 100% for protein fractions A, B1 and B2; 80% for protein fraction B3; and 0% for protein fraction C. Intestinal starch digestibility depends on type of grain, degree of processing, and level of intake above maintenance (Sniffen *et al.*, 1992; Knowlton *et al.*, 1998). Ranges are provided for the user to adjust intestinal starch digestion for specific situations, based on observation of the faeces, and in adjusting inputs to account for differences between actual and predicted performance. For most conditions, the ranges suggested are based on studies with growing beef steers and lactating dairy cows consuming feed at two to three times maintenance level of intake

(Sniffen *et al.*, 1992): whole maize, 30–50%; cracked maize, 50–70%; dry rolled maize, 70–80%; maize meal, 80–90%; whole high moisture maize, 80–90%; high moisture ground maize, 85–95%; steam flaked maize, 92–97%; dry rolled sorghum, 60–70%; dry ground sorghum, 70–80%; and steam flaked sorghum, 90–95%. Based on recent studies and a review of the literature (Knowlton *et al.*, 1998), modifications of the above for high-producing dairy cows (above 45 kg milk) fed maize are: whole maize, 30–40%; cracked maize, 40–60%; maize meal, 70–90%; and rolled high moisture maize, 75–85%. Although little escapes digestion in the rumen, starch from processed small grains (wheat, barley, oats) has a high intestinal digestibility (over 90%).

A more mechanistic approach is needed that incorporates the integration of digestion and passage to predict intestinal digestion. However, the accuracy of prediction of intestinal pool sizes digested depends on the accuracy of prediction of ruminal flows, and therefore has second priority to prediction of ruminal fermentation, particularly since, with most feeds, over 75% of total tract digestion occurs in the rumen.

### Prediction of metabolism of absorbed amino acids

We currently use empirically derived equations and transfer coefficients for metabolism of amino acids in this application level model (Table 21.2) because of the limitations in predicting end-products of ruminal fermentation, absorbed carbohydrate and amino acids, and the large number of metabolic routes connecting the numerous tissue and metabolic compartments, the multiple nutrient interactions, and the sophisticated metabolic regulations which drive the partitioning of absorbed nutrients in various productive states. The equations used to predict ME from DE reflect the variation in methane produced across a wide range in diets. The equations used for lactating dairy cows to predict NE for lactation from ME reflects the energetic efficiency associated with the typical mix of metabolites in the ME, based on respiration chamber data (Moe, 1981), and validated on independent data (Roseler, 1994). The equations used for growing cattle to predict NE for maintenance and NE for growth reflect the wide variation in metabolites used in growing cattle and dry cows, and validated with little bias across a wide range of ME contents (NRC, 2000). To predict the impact of diet on composition of tissue and milk, our metabolism submodel needs to be able to predict absorbed carbohydrates, volatile fatty acids, lipids and amino acids available for various physiological functions and their metabolism with changes in productive states. Pitt *et al.* (1996) described the prediction of ruminal fermentation end-products within the CNCPS structure as a first step; we are in the process of incorporating this dynamic approach into the CNCPS model.

### Sensitivity of the CNCPS to various inputs

Priorities for research and routine feed analysis procedures that need to be implemented depend on cost to benefit ratios and the procedures available to measure sensitive variables. There is little value in developing more complex models for amino acid balancing

until the first limiting factors can be accurately predicted. This was demonstrated when measured duodenal flows from 80 diets were not predicted as accurately with the dynamic, low level aggregation rumen model of Baldwin *et al.* (1987a,b,c) as with the CNCPS (Sauvant, 1991).

Fox *et al.* (1995) conducted a sensitivity analysis to assess the relative importance of refining prediction of factors influencing ruminal fermentation (feed carbohydrate and protein fractions and their digestion rates, and microbial amino acid composition) and those influencing animal requirements (maintenance protein requirement, tissue amino acid composition, and metabolic transfer coefficients) in improving accuracy of predicting diet amino acid adequacy. Using variations in published values, a sensitivity analysis with the CNCPS was conducted to evaluate the change from the validation of Ainslie *et al.* (1993) in variation accounted for ( $r^2$ ) and bias (slope when the regression of predicted on observed average daily gain (ADG) was forced through the origin) in predicting ME, MP and essential amino acids (EAA) allowable ADG.

### Sensitivity to feed factors

A lower feed NDF increased the bias with all three (ME, MP and EAA allowable ADG) because of an increase in NFC and therefore a greater ruminally degradable carbohydrate pool and increased microbial yield. The inverse was true with an increase in NDF. A lower CP decreased the MP allowable ADG, but did not decrease the EAA allowable gain because of little change in the first limiting EAA. The model was much more sensitive to a lower protein solubility, which increased the proportion of intake protein escaping ruminal degradation. Decreasing the ruminal starch and NDF rates of digestion decreased both the MP and EAA allowable ADG, because of a decreased microbial yield. A change in the values used for microbial amino acid composition had a dramatic effect on EAA allowable ADG. The values used in the CNCPS for absorbed microbial EAA are based on bacterial true protein (O'Connor *et al.*, 1993), which are different from those reported by Clark *et al.* (1992)

for whole bacteria. It is clear that those factors influencing the prediction of microbial yield were the most critical in predicting EAA supply. A portion of the variation in reported values for bacterial composition can be attributed to differences in techniques used to isolate and measure their composition (Clark *et al.*, 1992). Other data indicate that there are actual differences in bacterial composition, and large errors can result by assuming a constant composition (Clark *et al.*, 1992). Thus a high research priority is to increase our ability to accurately predict both the extent and composition of microbial growth on a particular diet.

The prediction of microbial yield and cell wall digestion is very sensitive to diet peNDF. However, at present the determination of this value is an inexact science at best. More research is needed to provide ways of quantifying in each situation peNDF values for feeds or develop an alternative way of relating feed chemical and physical characteristics to the prediction of rumen pH.

#### *Sensitivity to animal factors*

The Rohr and Lebzien (1991) metabolic faecal nitrogen requirements gave similar results but the CSIRO value increased the bias due to a lower requirement. More work is needed to clearly define this requirement. Decreasing the body size decreased ME allowable ADG because of an increase in the predicted energy content of gain. Decreasing the body condition score increased the ME allowable ADG due to a decrease in the model predicted maintenance energy requirement and an increased efficiency of use of ME for growth. The EAA allowable ADG was reduced when the Rohr and Lebzien (1991) or Evans and Patterson (1985) tissue EAA composition values were used, because of their higher values. The use of the NRC (1985), INRA (1989) or Rohr and Lebzien (1991) fixed transfer coefficients for efficiency of use of absorbed protein all decreased the  $r^2$  and increased the bias in predicting MP and EAA allowable ADG compared to the CNCPS model regression equation. These results indicate that the most sensitive animal factors are the EAA content of tissue and efficiency of

use of absorbed protein, and that efficiency of use of absorbed protein changes with stage of growth. Lobley (1992) indicated that protein metabolism in ruminants is very dynamic, and a kinetic approach is needed to accurately predict amino acid requirements. Small changes in either the rate of synthesis or degradation can cause great alterations in the rate of gain and the relative maintenance requirement changes with level of production. Lobley (1992) indicated that a 500 kg steer with a net daily protein accretion of 150 g actually degrades and re-synthesizes at least another 2550 g. Thus balancing for daily net accretion accounts for only about 5.5% of the total daily protein synthesis. He concluded that the precision of kinetic methods is critical; a 2% change in synthesis rate would alter net protein accretion 20–40% and many of the procedures are not accurate within 4–5%. The CNCPS growth requirement validation of Tylutki *et al.* (1994) indicated the CNCPS more aggregated approach based on measured whole-body composition accounted for more of the variation with less bias in predicting energy and protein retained across a wide range in cattle types than did a lower level kinetic model. When combined with a system that has limitations in predicting absorbed amino acids from microbial and feed sources, errors could be greatly magnified with an inadequate mechanistic metabolism model. In all cases, the ME allowable ADG exceeded the MP or EAA allowable ADG, suggesting that the efficiency of use of absorbed energy was influenced by EAA sufficiency.

#### **Adjusting animal and dietary factors to predict actual performance**

The previous discussion indicates accurate prediction of energy and amino acid supply depended on prediction of NDF, starch, CP and protein solubility pool sizes and their digestion and passage rates, and microbial amino acid composition. Prediction of absorbed energy and amino acid requirements depended on accurate prediction of protein retained, amino acid tissue composition, and efficiency of use of absorbed energy and protein. We believe that with adequate feed com-

position values and knowledge of how to use input values, mechanistic models such as the CNCPS that have an appropriate structure for accounting for these variables can be used as a beginning point to predict ME, NE, and amino acid requirements and supply. First, the animal, environmental and feed compositional factors must be described as accurately and completely as possible. However, because many of the factors (body size, environmental conditions, feed digestion rates, particle size, etc.) depend on field observation, the input factors must be adjusted in a logical way until the model predicts the performance that is being observed before alternatives can accurately be evaluated. This approach allows requirements to be computed for the specific animal, environmental, DMI and feed compositional conditions.

The following sequence of steps in using the CNCPS have been developed to determine the first limiting nutrient (energy, absorbed protein, amino acids) for specific conditions, based on our use of the CNCPS in designing experiments and in conducting field case studies (Roseler, 1991; Fox *et al.*, 1992, 1995, 2000a; Stone *et al.*, 1992). This hierarchy is necessary, because of the 'ripple effect' of all of the interactions in the model. When one factor is altered, several others are likely to be affected. The hierarchy inherent in the CNCPS assumes energy is first limiting, and amino acid requirements are supplied to meet the energy requirement for maintenance, pregnancy, or daily gain or milk production from the energy intake over that needed for maintenance and pregnancy.

- 1. Dry matter intake comparison.** Accurately determine DMI, and compare it to that expected. The actual dry matter intake must be accurately determined, taking into account feed wastage, moisture content of feeds and scale accuracy. The accuracy of any model prediction is highly dependent on the DMI used. Intake of each feed must be as uniform as possible over the day, because as far as we know all field application models assume a total mixed ration with steady state conditions.
- 2. Energy allowable evaluation.** Compare energy allowable to observed milk production

or daily gain. The daily gain or milk production being obtained should agree with those predicted from the diet considering animal type, environmental conditions, feed intake and diet feedstuff carbohydrate composition. If not, the user should evaluate the following.

- a.** Predicted change in body condition score, based on diet energy excess or deficiency. In the case of lactating and dry cows, the predicted energy balance compared to observed days over which animal condition will change one score are excellent indicators of the diet energy balance being achieved. However, predicted and observed body condition scores should agree.
  - b.** Mistakes or incorrect judgements about inputs such as body size, milk production and its composition, environmental conditions or feed additives are often made.
  - c.** Feed factors that may be influencing energy derived from the diet as the result of feed compositional changes, and possible effects on digestion and passage rates. The ME derived from forages are most sensitive to NDF amount and percentage of the NDF that is lignin, available NDF digestion rate, and peNDF value. After making sure the feed composition values are appropriate, the digestion rate is considered. Adjustments are made, using the ranges and descriptions in Table 6 of Sniffen *et al.* (1992). If the rumen pH is below 6.2, the digestion rate of the cell wall is reduced, based on pH predicted from peNDF. We next check the assignment of peNDF; it is used in computing passage rate. If too low, passage rate may be too high, reducing predicted ME value. The major factors influencing energy derived from feeds high in NFC are ruminal and intestinal starch digestion rate. This is mainly a concern when feeding maize and/or maize silage. We adjust this value based on appearance of maize in the manure, using the values in Table 7 of Sniffen *et al.* (1992) as a guide.
- 3. Effective fibre adjustments.** Make adjustments to insure effective fibre requirements are being met. In high-producing cows or high energy fed feedlot cattle, it is difficult to balance fibre requirements because of the increase in energy density needed to meet energy requirements for maximum production.

Based on Pitt *et al.* (1996), we make adjustments to insure that diet peNDF is a minimum of 20% in lactating cows, or growing cattle where forage utilization is important. As much as 25% peNDF may be required to maintain an adequate pH, depending on feeding management. In beef cattle fed high concentrate diets, a minimum of 8% is required to keep cattle on feed under typical feedlot conditions; under these low pH conditions (pH < 6) microbial yield will be reduced at least a third by the CNCPS model and very little energy will be derived from the fibre in forages fed. The peNDF is that required to keep rumen pH averaging above 5.6–5.7, the threshold below which cattle stop eating (R. Britton, University of Nebraska, personal communication).

**4. Rumen nitrogen balance.** Feeds such as soybean meal that are high in degradable true protein are added until ruminal peptide needs are met if amino acids are expected to be deficient; they are required for optimal fermentation of non-structural carbohydrates. Then adjust remaining ruminal nitrogen requirements with feeds high in NPN or soluble protein until ammonia needs are met. In addition to maximizing microbial amino acids supplied, the total tract digestion of both fibre (Sniffen *et al.*, 1992) and starch (Sniffen *et al.*, 1992; Theurer *et al.*, 1996) are dependent on the extent of ruminal fermentation.

**5. Metabolizable protein balance.** This component represents an aggregate of non-essential amino acids and essential amino acids. The MP requirement is determined by the animal type and the energy allowable gain or milk production. The adequacy of the diet to meet these requirements will depend on microbial protein produced from structural and non-structural carbohydrate fermentation and feed protein escaping fermentation. If MP balance appears to be unreasonable, we check first the starch digestion rates, using the ranges and descriptions in Sniffen *et al.* (1992). Altering the amount of degradable starch will also alter the peptide and total rumen N balance, because of altered microbial growth. Often the most economical way to increase MP supply is to increase microbial protein production by adding highly degradable sources of starch, such as processed grains. Further adjustments are made with

feeds high in slowly degraded or rumen escape (bypass) protein (low Protein B2 digestion rates).

**6. Compare essential amino acids supplied to meet requirements.** This is the last step to be adjusted because the amino acid balance is affected by changes made in all of the above. Essential amino acid balances can be estimated within the structure of the CNCPS because the effects of the interactions of intake, digestion and passage rates on microbial yield, available undegraded feed protein and estimates of their amino acid composition can be predicted along with microbial, body tissue and milk amino acid composition. However, the development of more accurate feed composition and digestion rates and more mechanistic approaches to predict utilization of absorbed amino acids will result in improved predictability of diet amino acid adequacy for cattle. Sources of first-limiting essential amino acids are adjusted where practical to improve the amino acid profile. In preliminary studies, energetic efficiency appeared to improve as essential amino acid profiles approached that of requirements (Fox *et al.*, 1995).

### Applications of the CNCPS model

One of the current concerns about academic research is that often it is not used by those who might benefit most from it. In part, this is because our usual products, journal articles, are not usually read by practitioners. When research data are incorporated into the CNCPS model, the information reaches the end-user, producers and nutrition consultants, quickly and in a form that is immediately useful. When the CNCPS model predictions do not agree with field observations, we usually get immediate and direct feedback. Thus, the product and the process of model development create a beneficial linkage between scientists and those in the field. The CNCPS is being used as a teaching tool for students and consultants to design and interpret experiments, to apply experimental results, to develop tables of nutrient requirements for any cattle type and production level, and to evaluate and improve feeding programmes.

Many feed consultants have been trained to use the CNCPS, and they now use the model to improve feeding programmes on farms.

The CNCPS model is used for all classes of beef and dairy cattle. Data from an actual dairy herd in central New York where the CNCPS has been used for 10 years and from evaluations in a feedlot near Calgary, Alberta, will be used as an example because they demonstrate the principles and procedures described previously.

### *The dairy case study*

This case study has been described in detail by Stone *et al.* (1992) and Klausner *et al.* (1998). When the CNCPS model was first used in this herd in June 1992, the average annual per cow milk production was about 11,000 kg of milk. The changes made by using the CNCPS were estimated to save \$42,600 in the first year. The herd average is now over 13,000 kg of milk, and manure analysis indicate that nitrogen excretion has been reduced by about a third (Klausner *et al.*, 1998). In a study in progress to evaluate plasma urea nitrogen levels relative to conception rates in 20 New York herds, PUN levels are about 20% lower in this herd than in nearly all of the other herds.

Initial data from the high-producing mature cows will be used to demonstrate how the model was used to predict animal requirements and feed utilization initially to formulate more efficient and cost-effective rations, and to adjust for various conditions encountered on the farm during the past 10 years. The base evaluations are summarized in Table 21.4. The base ration and evaluation is the diet that was being fed to this group before applying the CNCPS model. Predicted and measured DMI were within good agreement, and the CNCPS model predicted that the cows were in positive energy balance. The MP balance was within a reasonable range, considering our recommendation of 5% safety factor, and the requirement for the first limiting amino acid (methionine) was just being met. The effective NDF requirement was being met, giving a predicted rumen pH of 6.25, which would allow maximum microbial growth for the

energy and protein ruminally available. Thus when inputs for the cows, environment and feeds were accurately described, the CNCPS model predicted the observed response (43.4 kg of milk). However, the excess of ammonia (bacterial balance) and MP in the diet resulted in predicted plasma urea nitrogen of 16.4 mg%.

The CNCPS balanced ration is for a period after the ration adjustments had stabilized and milk production had increased steadily to 46.5 kg. The diet protein had been decreased by two percentage units, with an improved overall balance of all four nitrogen pools (rumen ammonia and peptides, MP, and essential amino acids). Primary ration changes were to increase microbial yield with more fermentable carbohydrates and to replace some of the soybean meal with less-degradable soybean meal (treated SBM). With the new ration, less energy was being used to excrete excess N (urea cost). Actual milk production now exceeded predicted ME allowable milk. Based on our data, we assume this to be due to improved EAA balance.

A number of changes in the environment and feed composition occurred over subsequent years that show how they affect performance and these balances. When intake dropped 2 kg during hot weather, ME allowable milk production declined 7.5 kg. When input temperature was changed to actual, the decline in intake was accurately predicted. One of the results of instituting the CNCPS was setting up a DMI monitoring programme, and plotting predicted vs. actual. This provided a tool for diagnosing problems, avoiding the usual trial and error approach to solving the decline in milk production. In a crop year when forage NDF declined, ME balance was increased 12.6 MJ and energy allowable milk 2.7 kg and increased MP and methionine balance because of increased microbial growth. When diet peNDF declined, the MP from bacteria declined 186 g day<sup>-1</sup> because peNDF requirement was not met and rumen pH dropped to 6.04 and methionine became deficient. When soluble CP declined, MP from feed increased by 93 g day<sup>-1</sup>. When the maize silage had a high percentage of small, hard, whole kernels and a lot of maize kernels were observed in the manure, ruminal starch digestion rate was lowered to 5% h<sup>-1</sup> and intestinal starch

**Table 21.4.** Results of the use of the CNCPS model in a field application<sup>a</sup>.

Diet ingredients	Base	Reformulated
Maize silage (kg DM day <sup>-1</sup> )	5.76	5.22
Lucerne silage (kg DM day <sup>-1</sup> )	2.40	4.54
HMEM (kg DM day <sup>-1</sup> )	4.94	5.76
Treated SBM (kg DM day <sup>-1</sup> )		1.13
SBM (kg DM day <sup>-1</sup> )	4.72	1.13
WCS (kg DM day <sup>-1</sup> )	2.54	2.68
Protein mix (kg DM day <sup>-1</sup> )	0.45	0.95
Maize grain (kg DM day <sup>-1</sup> )	2.09	2.40
Tallow (kg DM day <sup>-1</sup> )	0.23	
Minerals (kg DM day <sup>-1</sup> )	0.32	0.86
Total DMI (kg)	23.4	24.7
Predicted DMI (kg)	23.4	24.8
Diet CP (% DM)	20.2	18.3
Plasma urea N (mg%)	16.4	13.0
Actual milk (kg day <sup>-1</sup> )	43.4	46.5
ME allowable milk (kg day <sup>-1</sup> )	43.4	45.2
ME balance (MJ)	4.2	-6.3
MP balance (g)	95	95
MP from bacteria (g)	1256	1355
MP from feed (g)	1551	1614
Bacteria N balance (g N)	209	136
Peptide balance (g N)	122	45
Urea cost (MJ)	9.53	5.33
Days to BCS change	380	272
peNDF supplied (kg)	4.85	4.90
peNDF required (kg)	4.67	4.94
Predicted ruminal pH	6.25	6.44
Limiting AA	Met	Met
Limiting AA (% required)	94	96

<sup>a</sup>Diets and animal parameters specified as described by Klausner *et al.* (1998).

BCS, body condition score; HMEM, high moisture ear maize; SBM, soybean meal; WCS, whole cotton seed.

digestibility was lowered to 50% to adjust for this condition. The lower ruminal starch digestibility reduced microbial CP (MCP) yield 448 g day<sup>-1</sup>, resulting in a deficiency of MP and methionine. The effect of the combination of escaping more starch and a lowered intestinal digestibility resulted in 8.4 MJ less ME day<sup>-1</sup>, and lowered energy allowable milk 1.8 kg.

#### *The feedlot case study*

The data from a 4000 head study with steers fed approximately 80% rolled barley and 20% coarse chopped barley silage based diets in a 20,000 head feedlot near Calgary, Alberta, were evaluated with the CNCPS model. These

data were provided by Dr P.T. Guichon, Feedlot Health Management Services, Okotoks, Alberta. The cattle were fed in open dirt lots with mounds surrounded by wind-breaks. The objective was to use the procedures described earlier to accurately predict observed performance, then to use the CNCPS to evaluate the effect of different animal, feed and environmental factors on nutrient requirements, feed utilization and performance in this feedlot. The average initial body weight was 380 kg, the final body weight was 584 kg, DMI was 11.05 kg day<sup>-1</sup>, ADG was 1.58 kg day<sup>-1</sup>, and feed conversion was 7.00 kg DMI kg<sup>-1</sup> ADG. The cattle were fed in the autumn so environmental stress was minimal.



The results of this evaluation are shown in Tables 21.5, 21.6 and 21.7. Table 21.5 shows that the CNCPS model predicted the same ADG and feed conversion compared to the observed performance. Subsequently, a 10% decrease in DMI below actual, which was 4% more than predicted, will reduce ADG by 15% and feed conversion by 3.6%.

**Table 21.5.** Effect of animal and environmental factors on performance.

Scenario	ADG (kg day <sup>-1</sup> )	Feed conversion
Observed performance	1.58	7.00
CNCPS model predicted		
No adjustments <sup>a</sup>	1.58	7.00
Effect of DMI change <sup>b</sup>	1.35	7.25
Effect of mature size change <sup>c</sup>	1.75	6.23
Effect of body CS		
Very thin	1.76	6.19
Very fleshy	1.39	7.84
Effect of environment		
Winter, same DMI	1.45	7.52
Winter, increased DMI	1.54	7.40
Winter, wind at 24 km h <sup>-1</sup>	1.42	7.67
Matted hair	1.27	8.57
Thin hide	1.16	9.41
Short hair	0.85	12.80
Thin flesh	-0.45	-

<sup>a</sup>Mature weight of 582 kg at 28% empty body fat.

<sup>b</sup>Decrease of 10% than observed.

<sup>c</sup>Current weight of 482 kg and mature weight of 682 kg at 28% empty body fat.

**Table 21.6.** Effect of effectiveness of the feed fibre in controlling rumen pH.

	ADG (kg day <sup>-1</sup> )	Rumen pH	Silage <sup>a</sup> NE <sub>g</sub>	Grain <sup>a</sup> NE <sub>g</sub>	MCP <sup>b</sup> (g day <sup>-1</sup> )
Current predicted	1.58	5.9	4.22	5.36	820
Silage processed fine	1.51	5.8	3.60	5.23	710
Silage and grain both processed fine	1.13	5.7	1.09	0.96	578

<sup>a</sup>MJ kg<sup>-1</sup> DM.

<sup>b</sup>MCP is microbial crude protein produced (g day<sup>-1</sup>).

**Table 21.7.** Effect of body weight on protein requirements<sup>a</sup>.

	ME allowed ADG (kg day <sup>-1</sup> )	Rumen balance (%)	MP allowed ADG (kg day <sup>-1</sup> )	AA allowed ADG (kg day <sup>-1</sup> )
at 482 kg	1.58	-2.5	2.37	2.37
at 364 kg	1.58	-2.5	1.96	1.96
at 273 kg	1.57	-2.5	1.57	1.57
at 273 kg <sup>b</sup>	1.75	-2.5	1.57	1.57
at 182 kg	1.45	-2.5	1.10	1.12

<sup>a</sup>The base ration is 125 g kg<sup>-1</sup> crude protein, which is 77% degraded.

<sup>b</sup>The large size evaluation reaches finished weight at 100 kg heavier (682 kg).

An increase in the finished weight by 100 kg would result in a predicted gain 11% faster at the same weight. However, since they must be fed to a heavier weight to be finished, their overall feed efficiency would be similar (data not shown). Thin cattle would be expected to make compensatory growth whereas fleshy cattle would be expected to gain more slowly, due to differences in maintenance requirements and feed intake. The effects of winter feeding conditions on performance at an average winter temperature of  $-32^{\circ}\text{C}$  indicated that ADG decreases in the winter at the same DMI, due to an increase in metabolic rate. This can largely be offset by the higher predicted DMI expected in the winter conditions, although feed requirements are higher because of increased maintenance requirement. If the cattle were exposed to wind of  $24 \text{ km h}^{-1}$  instead of the current  $8 \text{ km h}^{-1}$ , ADG will be reduced slightly. However, if the insulation is reduced by matted hair, thin hide, short hair or thin flesh, performance will be dramatically reduced.

Table 21.6 shows the effect of fine processing the silage or grain, or both. The rumen pH is predicted to drop, reducing cell wall digestion and therefore net energy derived from the fibre. Also microbial protein production will decline at lower pH.

Table 21.7 shows the weight at which the dietary undegraded and microbial protein will not meet the energy allowable ADG requirement for protein or essential amino acids. The ruminal requirement for degradable protein is essentially met ( $-2.5\%$ ), and does not change with cattle weight because the requirement for degradable protein is proportional to the fermentable carbohydrates in the diet. The breakpoint for the cattle size in this study is 273 kg, below which supplemental amino acids will be needed. However, the absorbed protein and first-limiting amino acid requirements of cattle with a 100 kg larger finished weight would not be met because their energy allowable ADG is higher. The last line shows that the cattle being evaluated would have a protein allowable ADG  $0.35 \text{ kg day}^{-1}$  below the energy allowable ADG.

## Research Needed to Improve Predictions of Amino Acid Balances

### Modelling intestinal amino acid availability

The CNCPS model uses the amino acid profile (% of protein) of the protein insoluble in borate-phosphate buffer to compute the postrumen amino acid available (O'Connor *et al.*, 1993) and multiplies them by the amount of feed protein escaping the rumen to compute the intestinal amino acid availability (DIGFAA). It has been reported that the amino acid profile of the feed protein escaping the rumen remains the same as that of the original feed protein after correction for microbial contamination (Ganev *et al.*, 1979; Varvikko *et al.*, 1983; Boila and Ingalls, 1995; Maiga *et al.*, 1996). Tedeschi *et al.* (2001) have shown that the amino acid profile of the insoluble protein, determined with borate-phosphate buffer (Krishnamoorthy *et al.*, 1982), did not differ from that of the original forage protein. The model of Rulquin *et al.* (1998) considers that the amino acid profile is identical between escaping protein and intake feed protein. This approach relies on some assumptions (Tedeschi *et al.*, 2001) that may not be true, such as similar degradation rates of amino acids (Von Keyserlingk *et al.*, 1996). Other factors that may affect the amount of amino acids escaping the rumen are: (i) position of the amino acid in the feed cellular structure, (ii) uptake competition of the amino acids by the ruminal bacteria, and (iii) individual amino acid concentration in the rumen. Therefore, another mathematical approach, as shown below, to accurately compute intestinal amino acid availability could use different degradation rates for amino acids or group of amino acids (i.e. hydrophilic vs. hydrophobic) for each feed. This could minimize the under- or overestimation of duodenal amino acid concentration, which may result in a variation of up to  $1 \text{ g}$  of protein  $\text{kg}^{-1}$  of milk (Rulquin *et al.*, 1998).

$$\text{AAS} = \sum_{j=1}^n \left[ \left( \frac{kd_{AA_i}}{kd_{AA_i} + kp_j} \right) \times \text{FeedAA}_j + \text{DIGBAA}_j \right] + \text{Endogenous}_{AA_i} \quad [21.12]$$

In Equation [21.2] AAS is total amino acid supply in the small intestine (g);  $kd_{AA,j}$  is the degradation rate of an amino acid or a group of amino acids of the  $j^{\text{th}}$  feed ( $\% \text{ h}^{-1}$ );  $kp_j$  is the passage rate of the  $j^{\text{th}}$  feed ( $\% \text{ h}^{-1}$ ); FeedAA $_j$  is the amount of amino acid from the  $j^{\text{th}}$  feed (g); and Endogenous $_{AA}$  is the amount of endogenous contribution of each amino acid (g).

### Modelling limiting amino acids

In practice, it has been shown that post-ruminal supplementation of Met and Lys increases milk yield and protein synthesis (Rulquin *et al.*, 1995; Schwab, 1996); therefore diets are formulated to meet animal requirements of Met and Lys. However, some earlier studies demonstrated that infusion of extra His tended to increase the amount of milk protein (Schwab *et al.*, 1976) and in grass silage-based diets, His may be the first-limiting amino acid when urea is the only protein supplement and Leu may become the first-limiting amino acid in diets with low content of maize grain (Sloan, 1997). Therefore, it is necessary to incorporate other amino acids that may be first-limiting when modelling for diet adequacy.

### Modelling amino acid efficiency

The absorption of amino acids is dictated by several factors that affect the transport system such as operational characteristics, kinetics behaviours, mode of energization and substrate recognition (Guidotti and Gazzola, 1992). Because the transport mechanism is specific to amino acids or group of amino acids (Stevens, 1992), one amino acid that is in excess may compete with the absorption of another amino acid that uses the same transport system. Therefore, a model to compute the likelihood of an amino acid being absorbed given the concentration of amino acids and transport system specificity could be used to generate dynamic absorption coefficients that are sensitive to amino acid imbalances.

### Modelling branched-chain amino acid requirement

Branched-chain volatile fatty acids (BCVFA: isobutyric, isovaleric and 2-methylbutyric) are derived from dietary sources or recycling of bacterial protein by ruminal oxidative deamination and decarboxylation of branched-chain amino acids (BCAA: valine, leucine and isoleucine), respectively (Bryant and Doestch, 1955; Allison and Bryant, 1963; Miura *et al.*, 1980). The BCVFA are essential nutrients and increase growth of rumen cellulolytic as well as some non-cellulolytic bacteria (Allison *et al.*, 1962; Bryant and Robinson, 1962; Dehority *et al.*, 1967). Previous studies have shown that BCVFA can improve feed intake (Hungate and Dyer, 1956; Hemsley and Moir, 1963), cellulose digestion (Van Gylswyk, 1970; Gorosito *et al.*, 1985), microbial growth (Van Gylswyk, 1970; Russell and Sniffen, 1984), and weight gain (Lassiter *et al.*, 1958a; Felix *et al.*, 1980a) of growing animals fed high-fibre diets. For lactating dairy cows, enhancement of N retention (Lassiter *et al.*, 1958b; Cline *et al.*, 1966; Miron *et al.*, 1968; Oltjen *et al.*, 1971; Umunna *et al.*, 1975; Felix *et al.*, 1980a), milk production (Felix *et al.*, 1980b; Papas *et al.*, 1984; Peirce-Sandner *et al.*, 1985), and milk persistency (Felix *et al.*, 1980a,b) has also been observed. If most of the feed protein consumed is ruminally degraded, and the ruminally degraded protein is mostly true protein, the CNCPS ruminal nitrogen balance is a reasonable indicator of the potential for a BCVFA deficiency. However, when diets are high in non-protein nitrogen (e.g. urea) and much of the dietary true protein escapes the rumen, there can be enough ammonia to meet microbial growth requirements, but BCVFA can be limiting (Tedeschi *et al.*, 2000b). Therefore, a model to account for BCVFA/BCAA requirement is important to ensure adequate ruminal bacteria functionality. A BCVFA/BCAA model has been presented elsewhere (Tedeschi, 2001).

## Conclusions

This chapter indicates that it is possible to evaluate ruminant diets for amino acid adequacy and to use this information to make dietary changes that will improve performance. The production of meat and milk from ruminants is becoming more efficient in the use of nutrients by using models to predict accurately requirements and feed utilization in each unique production setting. These models must allow inputs from each situation to be adjusted in a logical way until the cattle and feeds are accurately described. Then when

predicted and observed performance (daily gain, milk amount and composition, and body condition score changes) agree, improved feeding programmes can be accurately formulated for that unique situation where nutritional safety factor and nutrient excretion are minimized. The challenge will be to develop systems that are aggregated at a level that can accurately reflect our understanding of the underlying biology, yet be usable on farm considering information available, ability to monitor and quantify key input variables and animal responses, and knowledge and time available of the consultant using the models.

## References

- Ainslie, S.J., Fox, D.G., Perry, T.C., Ketchen, D.J. and Barry, M.C. (1993) Predicting amino acid adequacy of diets fed to Holstein steers. *Journal of Animal Science* 71, 1312–1319.
- Allison, M.J. and Bryant, M.P. (1963) Biosynthesis of branched-chain fatty acids by rumen bacteria. *Archives of Biochemistry and Biophysics* 101, 269.
- Allison, M.J., Bryant, M.P. and Doestch, R.N. (1962) Studies on the metabolic function of branched-chain volatile fatty acids, growth factors for ruminococci. I. Incorporation of isovalerate into leucine. *Journal of Bacteriology* 83, 523.
- Baldwin, R.L., France, J., Beaver, D.E., Gill, M. and Thornley, J.H.M. (1987a) Metabolism of the lactating cow. III. Properties of mechanistic models suitable for evaluation of energetic relationships and factors involved in the partition of nutrients. *Journal of Dairy Research* 54, 133–145.
- Baldwin, R.L., France, J. and Gill, M. (1987b) Metabolism of the lactating cow. I. Animal elements of a mechanistic model. *Journal of Dairy Research* 54, 77–105.
- Baldwin, R.L., Thornley, J.H.M. and Beaver, D.E. (1987c) Metabolism of the lactating cow. II. Digestive elements of a mechanistic model. *Journal of Dairy Research* 54, 107–131.
- Boila, R.J. and Ingalls, J.R. (1995) Prediction of rumen undegradable amino acids that are digested post-ruminally. *Canadian Journal of Animal Science* 75, 583–592.
- Bryant, M.P. and Doestch, R.N. (1955) Factors necessary for the growth of *Bacteroides succinogenes* in the volatile acid fraction of the rumen fluid. *Journal of Dairy Science* 38, 340.
- Bryant, M.P. and Robinson, I.M. (1962) Some nutritional characteristics of predominant culturable ruminal bacteria. *Journal of Bacteriology* 84, 605.
- Cannas, A. (2000) Sheep and cattle nutrient requirement systems, ruminal turnover, and adaptation of the Cornell Net Carbohydrate and Protein System to sheep. PhD Dissertation, Cornell University, Ithaca.
- Clark, J.H., Klusmeyer, T.H. and Cameron, M.R. (1992) Microbial protein synthesis and flow of nitrogen fractions to the duodenum of dairy cows. *Journal of Dairy Science* 75, 2304–2323.
- Cline, T.R., Garrigus, U.S. and Hatfield, E.E. (1966) Addition of branched- and straight-chain volatile fatty acids to purified diets and effects on utilization of certain dietary components. *Journal of Animal Science* 25, 734.
- Dehority, B.A., Scott, H.W. and Kowaluk, P. (1967) Volatile fatty acid requirements of cellulolytic rumen bacteria. *Journal of Bacteriology* 94, 537.
- Evans, E.H. and Patterson, R.J. (1985) Use of dynamic modelling seen as good way to formulate crude protein, amino acid requirements for cattle diets. *Feedstuffs* 57, 24–27.
- Felix, A., Cook, R.M. and Huber, J.T. (1980a) Effect of feeding isoacids with urea on growth and nutrient utilization by lactating cows. *Journal of Dairy Science* 63, 1943.

- Felix, A., Cook, R.M. and Huber, J.T. (1980b) Isoacids and urea as a protein supplement for lactating cows fed maize silage. *Journal of Dairy Science* 63, 1103.
- Fox, D.G. and Tylutki, T.P. (1998) Accounting for the effects of environment on the nutrient requirements of dairy cattle. *Journal of Dairy Science* 81, 3085–3095.
- Fox, D.G., Sniffen, C.J., O'Connor, J.D., Russell, J.B. and Van Soest, P. (1992) A net carbohydrate and protein system for evaluating cattle diets: III. Cattle requirements and diet adequacy. *Journal of Animal Science* 70, 3578–3596.
- Fox, D.G., Barry, M.C., Pitt, R.E., Roseler, D.K. and Stone, W.C. (1995) Application of the Cornell net carbohydrate and protein model for cattle consuming forage. *Journal of Animal Science* 73, 267–277.
- Fox, D.G., Van Amburgh, M.E. and Tylutki, T.P. (1999) Predicting requirements for growth, maturity, and body reserves in dairy cattle. *Journal of Dairy Science* 82, 1968–1977.
- Fox, D.G., Tylutki, T.P., Czymmek, K.J., Rasmussen, C.N. and Durbal, V.M. (2000a) Development and application of the Cornell University Nutrient Management Planning System. In: Proceedings of the Cornell Nutrition Conference for Feed Manufacturers New York State College of Agriculture and Life Sciences, Cornell University, Rochester, New York, pp. 167–179.
- Fox, D.G., Tylutki, T.P., Van Amburgh, M.E., Chase, L.E., Pell, A.N., Overton, T.R., Tedeschi, L.O., Rasmussen, C.N. and Durbal, V.M. (2000b) *The Net Carbohydrate and Protein System for evaluating herd nutrition and nutrient excretion: Model documentation*, Mimeo No. 213. Animal Science Dept., Cornell University, Ithaca, New York.
- Ganev, G., Ørskov, E.R. and Smart, R.M. (1979) The effect of roughage or concentrate feeding and rumen retention time on total degradation of protein in the rumen. *Journal of Agricultural Science* 93, 651–656.
- Gill, M., Beaver, D.E. and France, J. (1989) Biochemical bases needed for the mathematical representation of whole animal metabolism. *Nutrition Abstracts Review* 2, 181–200.
- Gorosito, A.R., Russell, J.B. and Van Soest, P.J. (1985) Effect of carbon-4 and carbon-5 volatile fatty acids on digestion of plant cell wall *in vitro*. *Journal of Dairy Science* 68, 840–847.
- Guidotti, G.G. and Gazzola, G.C. (1992) Amino acid transporters: systematic approach and principles of control. In: Kilberg, M.S. and Haussinger, D. (eds) *Mammalian Amino Acid Transport*. Plenum Press, New York, pp. 3–29.
- Hemsley, J.A. and Moir, R.J. (1963) The influence of higher volatile fatty acids on the intake of urea-supplemented low quality cereal hay by sheep. *Australian Journal of Agricultural Research* 14, 509.
- Hungate, R.E. and Dyer, I.A. (1956) Effects of valeric and isovaleric acids on straw utilization by steers. *Journal of Animal Science* 15, 485.
- INRA (1989) *Ruminant Nutrition. Recommended Allowances and Feed Tables*. Institut National de la Recherche Agronomique, John Libbey Eurotext, Montrouge, France, 389 pp.
- Klausner, S.D., Fox, D.G., Rasmussen, C.N., Pitt, R.E., Tylutki, T.P., Wright, P.E., Chase, L.E. and Stone, W.C. (1998) Improving dairy farm sustainability I: an approach to animal and crop nutrient management planning. *Journal of Productive Agriculture* 11, 225–233.
- Knowlton, K.F., Glenn, B.P. and Erdman, R.A. (1998) Performance, ruminal fermentation, and site of starch digestion in early lactation cows fed maize grain harvested and processed differently. *Journal of Dairy Science* 81, 1972–1984.
- Krishnamoorthy, U., Muscato, T.V., Sniffen, C.J. and Van Soest, P.J. (1982) Nitrogen fractions in selected feedstuffs. *Journal of Dairy Science* 65, 217–225.
- Lassiter, C.A., Emery, R.S. and Duncan, C.W. (1958a) Effect of lucerne ash and valeric acids on growth of dairy heifers. *Journal of Dairy Science* 41, 552.
- Lassiter, C.A., Emery, R.S. and Duncan, C.W. (1958b) The effect of valeric acid and a combination of valeric and isovaleric acids on the performance of milking cows. *Journal of Animal Science* 17, 358.
- Lobley, G.E. (1992) Control of the metabolism fate of amino acids in ruminants: A review. *Journal of Animal Science* 70, 3264–3275.
- Maiga, H.A., Schingoethe, D.J. and Ellison, H.-J. (1996) Ruminal degradation, amino acid composition, and intestinal digestibility of the residual components of five protein supplements. *Journal of Dairy Science* 79, 1647–1653.
- Mertens, D.R. (1997) Creating a system for meeting the fiber requirements of dairy cows. *Journal of Dairy Science* 80, 1463–1481.
- Miron, A.E., Otterby, D.E. and Pursel, V.G. (1968) Responses of calves fed diets supplemented with different sources of nitrogen and with volatile fatty acids. *Journal of Dairy Science* 51, 1392.

- Miura, H.M., Horiguchi, M. and Matsumoto, T. (1980) Nutritional interdependence among rumen bacteria, *Bacteroides amylophilus*, *Megasphaera eisdnii*, and *Ruminococcus albus*. *Applied and Environmental Microbiology* 40, 294.
- Moe, P.W. (1981) Energy metabolism of dairy cattle. *Journal of Dairy Science* 64, 1120–1139.
- NRC (1985) *Ruminant Nitrogen Usage*. National Academy Press, Washington, DC, 138 pp.
- NRC (1989) *Nutrient Requirements of Dairy Cattle*, 6th edn. National Academy Press, Washington, DC, 157 pp.
- NRC (2000) *Nutrient Requirements of Beef Cattle*, updated 7th edn. National Academy Press, Washington, DC, 242 pp.
- NRC (2001) *Nutrient Requirements of Dairy Cattle*, 7th edn. National Academy Press, Washington, DC, 381 pp.
- O'Connor, J.D., Sniffen, C.J., Fox, D.G. and Chalupa, W. (1993) A net carbohydrate and protein system for evaluating cattle diets: IV. Predicting amino acid adequacy. *Journal of Animal Science* 71, 1298–1311.
- Oltjen, R.R., Slyter, R.L. and Williams, E.E. Jr (1971) Influence of branched-chain volatile fatty acids and phenylacetate on ruminal microorganisms and nitrogen utilization by steers fed urea or isolated soy protein. *Journal of Nutrition* 102, 479.
- Papas, A.M., Ames, S.R., Cook, R.M., Sniffen, C.J., Polan, C.E. and Chase, L. (1984) Production responses of dairy cows fed diets supplemented with ammonium salts of iso C-4 and C-5 acids. *Journal of Dairy Science* 67, 276–293.
- Peirce-Sandner, S.B., Papas, A.M., Rogers, J.A., Sweeney, T.F., Cummins, K.A., Conrad, H.R. and Muller, L.D. (1985) Supplementation of dairy cow diets with ammonium salts of volatile fatty acids. *Journal of Dairy Science* 68, 2895–2907.
- Pitt, R.E., Van Kessel, J.S., Fox, D.G., Pell, A.N., Barry, M.C. and Van Soest, P.J. (1996) Prediction of ruminal volatile fatty acids and pH within the net carbohydrate and protein system. *Journal of Animal Science* 74, 226–244.
- Rohr, K. and Lebzien, P. (1991) Present knowledge of amino acid requirements for maintenance and production. In: Eggum, B.O., Boisen, S., Børsting, C., Danfær, A. and Hvelplund, T. (eds) *Proceedings of the International Symposium on Protein Metabolism and Nutrition*, 6th EAAP Publication, Herning, Denmark, pp. 127–137.
- Roseler, D.K. (1991) The use of nutrition models in the commercial feed industry. In: *Proceedings of the Cornell Nutrition Conference for Feed Manufacturers*. New York State College of Agriculture and Life Sciences, Cornell University, Rochester, New York, pp. 66–72.
- Roseler, D.K. (1994) Development and evaluation of feed intake and energy balance prediction models for lactating dairy cattle. PhD thesis, Cornell University, Ithaca.
- Ruiz, R., Tedeschi, L.O., Marini, J.C., Fox, D.G., Pell, A.N., Jarvis, G. and Russell, J.B. (2002) The effect of a ruminal nitrogen (N) deficiency in dairy cows: evaluation of the Cornell Net Carbohydrate and Protein System ruminal N deficiency adjustment. *Journal of Dairy Science* 85, 2986–2999.
- Rulquin, H. and Vérité, R. (1993) Amino acid nutrition of dairy cows: productive effects and animal requirements. In: Garnsworthy, P.C. and Cole, D.J.A. (eds) *Recent Advances in Animal Nutrition*. Nottingham University Press, Nottingham, pp. 55–77.
- Rulquin, H., Vérité, R., Guinard, J. and Pisulewski, P.M. (1995) Dairy cows' requirements for amino acids. In: Ivan, M. (ed.) *Animal Science Research and Development: Moving Toward a New Century*. Ministry and Services Canada, Ottawa, Canada, pp. 143–160.
- Rulquin, H., Guinard, J. and Vérité, R. (1998) Variation of amino acid content in the small intestine digesta of cattle: development of a prediction model. *Livestock Production Science* 53, 1–13.
- Russell, J.B. and Sniffen, C.J. (1984) Effect of carbon-4 and carbon-5 volatile fatty acids on growth of mixed rumen bacteria *in vitro*. *Journal of Dairy Science* 67, 987–994.
- Russell, J.B., O'Connor, J.D., Fox, D.G., Van Soest, P.J. and Sniffen, C.J. (1992) A net carbohydrate and protein system for evaluating cattle diets: I. Ruminal fermentation. *Journal of Animal Science* 70, 3551–3561.
- Sauvant, D. (1991) The use of modelling to predict animal responses to diet. In: *Proceedings of Ralston Purina International Scientific Advisory Board*. Paris, France, 34 pp.
- Schwab, C.G. (1996) Amino acid nutrition of the dairy cow: current status. In: *Proceedings of the Cornell Nutrition Conference for Feed Manufacturers* New York State College of Agriculture and Life Sciences, Cornell University, Rochester, pp. 184–198.
- Schwab, C.G., Satter, L.D. and Clay, A.B. (1976) Response of lactating dairy cows to abomasal infusion of amino acids. *Journal of Dairy Science* 59, 1254–1269.

- Sloan, B.K. (1997) Developments in amino acid nutrition of dairy cows. In: Garnsworthy, P.C. and Wiseman, J. (eds) *Recent Advances in Animal Nutrition*. Nottingham University Press, Nottingham, pp. 167–198.
- Sniffen, C.J., O'Connor, J.D., Van Soest, P.J., Fox, D.G. and Russell, J.B. (1992) A net carbohydrate and protein system for evaluating cattle diets: II. Carbohydrate and protein availability. *Journal of Animal Science* 70, 3562–3577.
- Sniffen, C.J., Chalupa, W.H., Ueda, T., Suzuki, H., Shinzato, I., Fujieda, T., Julien, W., Rode, L., Robinson, P.H., Harrison, J., Freeden, A. and Nocek, J.E. (2001) Amino acid nutrition of the lactating cow. In: *Proceedings of the Cornell Nutrition Conference for Feed Manufacturers*. New York State College of Agriculture and Life Sciences, Cornell University, Rochester, New York, pp. 188–197.
- Stevens, B.R. (1992) Amino acid transport in intestine. In: Kilberg, M.S. and Haussinger, D. (eds) *Mammalian Amino Acid Transport*. Plenum Press, New York, pp. 149–163.
- Stone, W.C., Chase, L.E. and Fox, D.G. (1992) Field application of the Cornell Net Carbohydrate and Protein System model in a progressive dairy herd. In: *Proceedings of the Cornell Nutrition Conference for Feed Manufacturers*. New York State College of Agriculture and Life Sciences, Cornell University, Rochester, New York, pp. 168–179.
- Tedeschi, L.O. (2001) Development and Evaluation of Models for the Cornell Net Carbohydrate and Protein System: 1. Feed Libraries, 2. Ruminant Nitrogen and Branched-Chain Volatile Fatty Acid Deficiencies, 3. Diet Optimization, 4. Energy Requirement for Maintenance and Growth. PhD Dissertation, Cornell University, Ithaca, New York.
- Tedeschi, L.O., Fox, D.G., Chase, L.E. and Wang, S.J. (2000a) Whole-herd optimization with the Cornell net carbohydrate and protein system. I. Predicting feed biological values for diet optimization with linear programming. *Journal of Dairy Science* 83, 2139–2148.
- Tedeschi, L.O., Fox, D.G. and Russell, J.B. (2000b) Accounting for ruminal deficiencies of nitrogen and branched-chain amino acids in the structure of the Cornell net carbohydrate and protein system. In: *Proceedings of the Cornell Nutrition Conference for Feed Manufacturers*. New York State College of Agriculture and Life Sciences, Cornell University, Rochester, New York, pp. 224–238.
- Tedeschi, L.O., Fox, D.G. and Russell, J.B. (2000c) Accounting for the effects of a ruminal nitrogen deficiency within the structure of the Cornell net carbohydrate and protein system. *Journal of Animal Science* 78, 1648–1658.
- Tedeschi, L.O., Pell, A.N., Fox, D.G. and Llamas, C.R. (2001) The amino acid profiles of the whole plant and of four residues from temperate and tropical forages. *Journal of Animal Science* 79, 525–532.
- Theurer, C.B., Huber, J.T. and Delgado-Elorduy, A. (1996) Steam-flaking improves starch utilization and milk production parameters. In: *Proceedings of the Cornell Nutrition Conference for Feed Manufacturers*. New York State College of Agriculture and Life Sciences, Cornell University, Rochester, New York, pp. 121–130.
- Tylutki, T.P., Fox, D.G. and Anrique, R.G. (1994) Predicting net energy and protein requirements for growth of implanted and nonimplanted heifers and steers and nonimplanted bulls varying in body size. *Journal of Animal Science* 72, 1806–1813.
- Umunna, N.N., Klopfenstein, T. and Woods, W. (1975) Influence of branched-chain volatile fatty acids on nitrogen utilization by lambs fed urea containing high roughage rations. *Journal of Animal Science* 40, 523.
- Van Gylswyk, N.O. (1970) The effect of supplementing a low-protein hay on the cellulolytic bacteria in the rumen of sheep and on the digestibility of cellulose and hemicellulose. *Journal of Agricultural Science Cambridge* 74, 169.
- Van Soest, P.J., Robertson, J.B. and Lewis, B.A. (1991) Methods for dietary fiber, neutral detergent fiber, and nonstarch polysaccharides in relation to animal nutrition. *Journal of Dairy Science* 74, 3583–3597.
- Varvikko, T., Lindberg, J.E., Setälä, J. and Syrjälä-Qvist, L. (1983) The effect of formaldehyde treatment of soya-bean meal and rapeseed meal on the amino acid profiles and acid-pepsin solubility of rumen undegraded protein. *Journal of Agricultural Science* 101, 603–612.
- Von Keyserlingk, M.A.G., Swift, M.L., Puchala, R. and Shelford, J.A. (1996) Degradability characteristics of dry matter and crude protein of forages in ruminants. *Animal Feed Science and Technology* 57, 291–311.
- Waghorn, G.C. and Baldwin, R.L. (1984) Model of metabolite flux within mammary gland of the lactating cow. *Journal of Dairy Science* 67, 531–544.

# 22 Canine and Feline Amino Acid Requirements for Different Physiological Functions

**W.H. Hendriks\***

*Institute of Food, Nutrition and Human Health, Massey University, Palmerston North, New Zealand*

---

## **Introduction**

Amino acids have been an important component in the diet of animals throughout evolution. The carnivorous behaviour of animals such as the cat, ferret and to a lesser extent the dog is the likely reason for the specialized metabolism of these species we see today. It is well recognized that the cat's metabolism has adapted to the ingestion of animal tissues which is, unlike food from plants, devoid of carbohydrates and contains an excess of protein relative to energy (Morris, 2001). Adaptations relating to the protein component of the diet can be found in the cat's metabolism of arginine, taurine, non-essential amino acids and tryptophan. In addition, cats synthesize several unique amino acids (felinine, isovalthine and isobutene) and excrete these, some in large quantities, in their urine. These and other well-known metabolic specializations contribute to the classification of the domestic cats as true carnivores. The dog, although showing some metabolic specializations like the cat, can be classified as an omnivorous carnivore. With regards to adaptations in protein metabolism, a remnant of a semicarnivorous evolution is the susceptibility

of the dog to hyperammonaemia from an arginine deficiency. The dog seems to be more susceptible than omnivores (rats and pigs) but reported toxicity signs are not as severe as those seen in the domestic cat (Morris, 2001). Unlike the situation for cats, taurine is a non-essential dietary nutrient for dogs and niacin deficiency does not occur when sufficient tryptophan is present in the diet. In addition, the protein requirement, of growing and adult dogs do not appear to be higher than those of omnivorous animals. A number of other metabolic adaptations (e.g. metabolism of arachidonic acid, vitamins A and D) by cats and dogs are further evidence of their respective classification.

Research into the protein metabolism of domestic cats and dogs has focused on estimating protein requirements, elucidating metabolic adaptations involving amino acids, and determining the essentiality and minimum dietary requirement for individual amino acids. Currently the National Research Council (NRC, 1985, 1986) presents minimum dietary amino acid requirement estimates for growing cats and dogs, and adult dogs. In addition, amino acids have been shown to play an important role in the

\*E-mail address: W.Hendriks@massey.ac.nz



palatability of foods for cats and dogs (Boudreau and White, 1978) and recently Yu *et al.* (2001) showed that high levels of dietary tyrosine are required for the expression of the black coat colour in kittens.

There is a growing need for amino acid requirement estimates for cats and dogs to be based on criteria such as optimal health, longevity, optimum expression of coat colour instead of criteria such as maximum growth, zero nitrogen balance or minimum amino acid oxidation. There is, furthermore, a growing realization that there are differences in nutrient requirements between breeds of cats and dogs (Blaza *et al.*, 1982; Rainbird and Kienzle, 1990) and differences in metabolism between breeds (Stevenson and Markwell, 2001). The currently available minimum amino acid requirement estimates for cats and dogs, as presented by the National Research Council (NRC, 1985, 1986), are of limited value in describing the requirements for optimal health of individual animals of a particular breed during a particular life stage. They are furthermore of limited value as requirement estimates have been shown to depend on the function studied (Quam *et al.*, 1987; Yu *et al.*, 2001). Also, these estimates do not provide insight into the relative contributions of the various biological processes that give rise to the overall amino acid requirements of the animal. The aim of the present chapter is to summarize quantitative information on amino acid losses from the bodies of adult cats and dogs which can be used for the development of a factorial model to estimate maintenance amino acid requirements.

### Maintenance Amino Acid Requirements

Maintenance amino acid requirements originate from the continual loss of amino acids from the body and the modification of amino acids into other compounds required by the body. The processes, which collectively give rise to the maintenance requirements, are part of an integrated metabolism of compounds *in vivo*. To maintain the body and remove excess nutrients absorbed, an animal's metabolism changes continuously in

response to stimuli such as feeding level, disease or exercise. When an animal does not absorb sufficient nutrients, it cannot maintain the physiological processes required for optimal health and vitality although its metabolism is adapting. In the case of amino acids, the rate of amino acid oxidation will decrease and a reduction in urinary urea output is observed when the inclusion of protein in the diet is reduced. Lowering the dietary protein level below the point where the animal has reached its lowest amino acid oxidation rate will result in loss of labile body protein stores. Depending on the extent of the dietary 'shortage', body protein breakdown will exceed body protein synthesis, as the first-limiting dietary amino acid will be used for vital physiological functions within the body. As body protein synthesis is impaired due to the shortage of one amino acid, the non-limiting amino acids from dietary and endogenous origin (through body protein breakdown) will be oxidized (Millward, 1998). Maintaining this state for a short period will not be detrimental and on adequate dietary intake the animal will quickly regain its lost labile body protein stores. Prolonged dietary shortage of one or more essential amino acids or amino acid nitrogen will lead to more severe reductions in muscle mass and eventually death.

An animal's amino acid requirements cannot be seen as separate from the diet as its metabolism will adapt and change depending on dietary intake level and composition to cope with the supply of amino acids. As such its requirement for amino acids will vary. Reeds (1988) argued that because of metabolic adaptations, basal protein loss is an inappropriate measure of maintenance protein requirements. By definition, minimum amino acid requirement estimates represent only those values where the maximum level of adaptation has occurred under the defined set of stimuli used during the experiment.

Maintenance amino acid requirements arise from a number of physiological functions within the body which use amino acids. Maintenance amino acid requirements in adult cats and dogs include the need to replace amino acids lost from the gastrointestinal tract, integument and epidermis, those lost

through the urinary tract, amino acids irreversibly modified, and those used to synthesize physiologically important non-protein compounds such as hormones, neurotransmitters and other metabolically important products (Fuller, 1994). In addition, irreducible oxidation of body amino acids associated with the turnover of body protein is an important component making up the maintenance amino acid requirements of cats and dogs. The following will provide quantitative information on the losses of amino acids through a number of the above-mentioned routes in adult cats and dogs.

### Amino Acid Losses from the Gastrointestinal Tract of Cats and Dogs

During the digestion of food, large quantities of protein-containing endogenous material are actively and passively secreted into the lumen of the digestive tract. Among these are digestive enzymes, mucus, bile acids, desquamated cells, serum albumin, urea and amines (Fauconneau and Michel, 1970; Snook, 1973). Much of the endogenous material excreted into the gastrointestinal tract is digested and re-absorbed, although some remains unabsorbed and is lost from the body via excretion in the faeces. These losses are not constant but depend on the diet consumed by the animal. A well-researched example of this is the dietary taurine requirement in growing cats. Hickman *et al.* (1992) showed that heat-processing of a canned cat food will result in a greater loss of taurine from the small intestine than the same food but unprocessed. The difference is caused by the re-absorption of taurine in bile acids by the enterohepatic circulation being dependent on dietary components in particular the protein component. Higher levels of undigestible protein increases cholecystokinin secretion and as a result increase degradation of bile acids by microorganisms in the terminal ileum (Morris *et al.*, 1994) thereby causing differences in the amount of endogenous taurine lost.

Quantitative estimates of endogenous protein lost through the digestive tract can

be made by feeding the animal a protein-free diet and determining the nitrogen content in the faeces. By definition any nitrogen in the faeces has originated from the animal. Using this approach, Kendall *et al.* (1982) reported endogenous faecal nitrogen excretions in adult dogs of  $63 \text{ mg kg}^{-0.75} \text{ day}^{-1}$  whereas Meyer *et al.* (1987) reported a value of  $54 \text{ mg N kg}^{-0.75} \text{ day}^{-1}$ . More recently, Sritharan (1998) reported a slightly higher value of  $73 \text{ mg N kg}^{-0.75} \text{ day}^{-1}$  in adult dogs fed a protein-free diet. Kendall *et al.* (1982) showed that there was no effect of breed on endogenous faecal nitrogen excretions in adult dogs. There are few estimates of endogenous faecal nitrogen excretion in adult cats. Greaves and Scott (1960) estimated the gut endogenous faecal nitrogen loss of adult cats by feeding diets containing different levels of protein (12.7–46.2%) and extrapolating faecal nitrogen loss to zero dietary protein intake. Using this regression method, a value of  $6.3 \text{ g N kg}^{-1} \text{ diet dry matter consumed}$  was obtained for the endogenous faecal nitrogen loss of adult cats. Hendriks *et al.* (1996) fed adult cats a protein-free diet and recorded a slightly lower value of  $4.1 \text{ mg kg}^{-1} \text{ dry matter intake}$ .

Hendriks *et al.* (1996) and Sritharan (1998) determined the endogenous faecal amino acid losses by feeding adult cats and dogs a protein-free diet, respectively (Table 22.1). Both species have a similar pattern of amino acid loss from the gastrointestinal tract with the most abundant amino acids being aspartate, glutamate, threonine, serine, leucine, alanine and lysine. Endogenous methionine losses were low in both species. These estimates can be criticized however, as the flora of the large intestine catabolizes dietary and endogenous amino acids and synthesizes new amino acids. In addition, these endogenous faecal amino acid loss estimates can be further criticized due to the unphysiological nature of the protein-free approach. Based on work in other species (e.g. pigs, rats and humans) it is now well established that the protein-free technique leads to an underestimation of gut endogenous amino acid losses and that the inclusion of protein/peptides in the diet significantly increases these losses.

**Table 22.1.** Endogenous faecal amino acid excretions in adult cats and dogs fed a protein-free diet.

Amino acid	Endogenous faecal excretion ( $\mu\text{g g}^{-1}$ dry matter intake)	
	Cat <sup>a</sup>	Dog <sup>b</sup>
Taurine	75	–
Cysteine	734	–
Aspartate	1858	1538
Threonine	1084	1258
Serine	1204	1086
Glutamate	2333	1859
Proline	–	679
Glycine	1059	846
Alanine	1181	961
Valine	1209	854
Methionine	365	260
Isoleucine	807	661
Leucine	1555	961
Tyrosine	944	604
Phenylalanine	927	660
Histidine	808	382
Lysine	1132	972
Arginine	900	643

<sup>a</sup>From Hendriks *et al.* (1996).

<sup>b</sup>From Sritharan (1998).

Estimates of endogenous losses made at the end of the small intestine are generally regarded as more accurate although the contribution of the large intestine is not included in these estimates and must be added to derive estimates of endogenous gut losses from the digestive tract. Table 22.2 presents the ileal endogenous amino acid losses in adult cats and dogs determined using the protein-free and peptide alimentation method. Furthermore, the endogenous amino acid losses at the terminal ileum are higher for all species including cats and dogs when the diet contains peptides/protein compared to a protein-free or free amino acid diet. This latter finding demonstrates the inadequacy of both canine and feline amino acid requirement estimates for growth and maintenance that have been determined using purified free amino acid diets. When diets are used containing protein, these requirement estimates are no longer accurate as gut endogenous amino acid losses will be increased due to the inclusion of protein in the diet. The pattern of amino acid losses whether under protein-free or peptide

alimentation, is similar in adult cats and dogs compared to those of other animals (e.g. rats and pigs) with the most predominant amino acids in the endogenous protein being aspartate, threonine, serine and glutamate. However, the actual losses are much higher in the cat and dog compared to other species.

The main sources of endogenous amino acids at the terminal ileum are mucus and desquamated cells (Snook, 1973) and it can be expected that mucus and sloughed epithelial cells also constitute the main source of the endogenous excretions by the large intestine. An estimate of the amount of endogenous amino acids excreted by the large intestine can, therefore, be obtained by subtracting the ileal nitrogen excretion of cats fed a protein-free diet from the faecal nitrogen excretion of cats fed a protein-free diet. This approach can be expected to give a relatively accurate estimate of endogenous amino acid excretions by the large intestine when the difference in the amount of nitrogen-containing material entering and leaving the large intestine through the intestinal wall, is small in proportion to the

**Table 22.2.** Endogenous amino acid excretions at the terminal ileum of adult cats and dogs fed a protein-free (PF) diet or an enzymatically hydrolysed casein (EHC) diet.

Amino acid	Endogenous ileal excretion ( $\mu\text{g g}^{-1}$ dry matter intake)			
	Cat <sup>a</sup>		Dog <sup>b</sup>	
	PF	EHC	PF	EHC
Taurine	2091	299	—	—
Cysteine	452	853	—	—
Aspartate	1283	2725	960	2428
Threonine	1235	2127	1168	2015
Serine	1013	2734	925	3386
Glutamate	1427	4240	1089	5993
Proline	820	1913	643	1814
Glycine	665	1298	600	1001
Alanine	666	1380	515	951
Valine	696	1687	536	1448
Methionine	164	411	119	323
Isoleucine	398	1205	362	1192
Leucine	884	1823	650	1180
Tyrosine	599	1046	444	648
Phenylalanine	632	1015	465	624
Histidine	397	897	268	700
Lysine	570	1101	441	866
Arginine	540	948	370	728

<sup>a</sup>From Hendriks *et al.* (1996).

<sup>b</sup>From Sritharan (1998).

total amount of nitrogen excreted by the large intestine. Another approach is to estimate endogenous excretions in the large intestine based on the excretion estimates made in the upper digestive tract. This may be a reasonable approach as mucus and sloughed cells can be expected to constitute the main sources of the endogenous excretions in the small and large intestine. Transit times of digesta need to be taken into account in a theoretical estimation along with the surface area of the small and large intestines. It can be calculated from data published by Wood (1944) and Marshall and Johnson (1993) that the surface area of the large intestine in the adult cat is approximately 3.1% that of the surface area of the small intestine. Assuming transit times of food/digesta in the small and large intestine of adult cats are approximately 2.5 h (Humphreys and Scott, 1962), and 40 h (Fucci *et al.*, 1995), respectively, it can be calculated that the large intestine would excrete approximately 50% of the amount of endogenous material excreted by the small intestine.

The latter value is similar to the estimate of 70% which is obtained by subtracting the ileal nitrogen excretion ( $2.4 \text{ mg g}^{-1}$  dry matter) from the faecal nitrogen excretion ( $4.1 \text{ mg g}^{-1}$  dry matter intake) of adult cats fed a protein-free diet (Hendriks *et al.*, 1996). Using the latter approach, it can be calculated from data by Sritharan (1998) that the large intestine of adult dogs excretes approximately 30% of the amount of endogenous nitrogen containing material excreted by the small intestine. These data show that the large intestine in adult cats and dogs contributes significantly to the overall excretion of gut endogenous material.

### Amino Acid Losses from the Urinary Tract of Cats and Dogs

The amounts of endogenous protein and amino acids lost through the urinary tract are considered to be small in comparison with the losses of endogenous nitrogen material from other routes (Linder, 1991). Reabsorption of

free plasma amino acids by the kidney is a relatively efficient process and only small amounts of free amino acids can be found in the urine. The exceptions are those amino acids being excreted as a waste product (e.g. 3-methylhistidine) or amino acids excreted which have a biological role outside the body (e.g. felinine). In addition to these losses, small amounts of endogenous protein can be found in the urine originating from sloughed cells, mucus, enzymes, plasma proteins, etc.

Quantitative data on the losses of protein and amino acids through the urinary tract in adult cats and dogs are limited. In healthy adult dogs, 24 h urinary protein excretions of 4.8, 8.2 and 13.9 mg kg<sup>-1</sup> body weight have been reported (DiBartola *et al.*, 1980; Biewenga *et al.*, 1982; White *et al.*, 1984). Similar values have been reported by Monroe *et al.* (1989) who found that entire male cats excreted on average 8.7 mg protein kg<sup>-1</sup> body weight day<sup>-1</sup> whereas entire female cats excrete significantly more (16.6 mg kg<sup>-1</sup> day<sup>-1</sup>). Lower values of 4.9 mg kg<sup>-1</sup> day<sup>-1</sup> were found by Adams *et al.* (1992) in adult cats White Russo *et al.* (1986) reported a value of 17.4 mg kg<sup>-1</sup> day<sup>-1</sup> and found no significant differences between male and female

cats. Hendriks *et al.* (1997a) determined the endogenous content of several urinary nitrogen fractions in adult cats fed a protein-free diet and by regression to zero dietary nitrogen intake, and found undetermined nitrogen (total N-urea N-creatinine N-ammonia N) fractions of 57.6 and 38.0 mg kg<sup>-1</sup> day<sup>-1</sup>, respectively. The undetermined nitrogen fraction would have contained free amino acids, mucus, sloughed cells, enzymes, creatine, metabolites of purine metabolism (uric acid, allantoin, xanthine, hypoxanthine), etc.

### Amino Acid Composition of Hair and Quantitative Hair Loss in Adult Cats and Dogs

Amino acids are constantly lost from the body in the form of hair. As cat and dog hair is mainly composed of amino acids (Table 22.3), the contribution of hair loss to the overall amino acid requirements may be significant. Hair proteins contain high levels of cysteine and the amount of cysteine required for hair growth may constitute a significant proportion of the total sulphur amino acid requirements of adult cats and dogs, especially for those

**Table 22.3.** Amino acid composition of cat, dog, horse, sheep and human hair protein. (From Hendriks *et al.*, 1998b.)

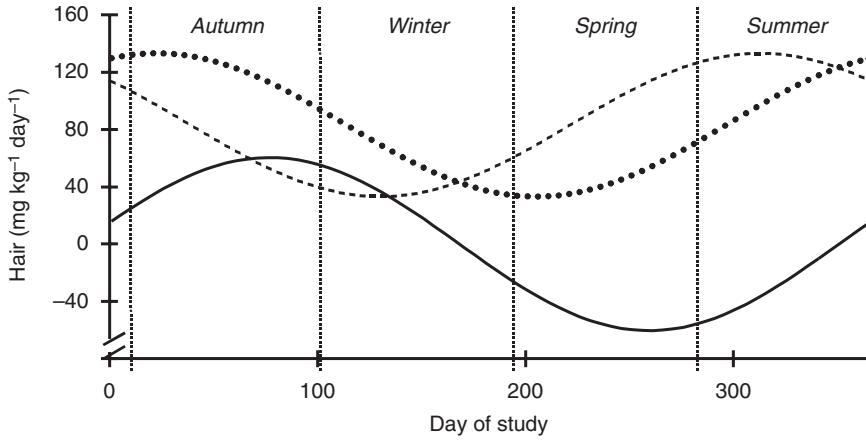
Amino acid	Content (mol 100 mol <sup>-1</sup> of residue)				
	Cat	Dog	Horse	Sheep	Human
Cysteine	15.8	16.7	14.4	13.1	17.8
Methionine	0.9	0.9	0.2	0.5	0.6
Aspartate	5.6	5.3	6.0	5.9	4.9
Threonine	6.4	6.2	5.5	6.5	6.8
Serine	10.6	10.5	9.6	10.8	11.7
Glutamate	11.4	11.1	11.3	11.1	11.4
Glycine	9.5	7.8	6.4	8.6	6.4
Alanine	5.1	5.1	5.5	5.2	4.6
Valine	4.9	4.9	5.9	5.7	5.8
Isoleucine	2.5	2.5	3.6	3.0	2.6
Leucine	6.7	6.1	7.5	7.2	5.8
Tyrosine	3.0	2.7	1.9	3.8	2.0
Phenylalanine	2.3	1.7	2.5	2.5	1.6
Histidine	1.2	0.9	1.1	0.8	0.9
Lysine	2.9	3.9	2.9	2.7	2.7
Arginine	6.1	6.3	7.9	6.2	5.8
Proline	4.9	7.3	7.8	6.6	8.4

breeds with a relatively dense and long hair coat (e.g. Persian, Longhaired Scottish Fold, Pekinese and Collie). The effect of hair colour will most likely not effect requirements as the amino acid composition of different coloured (black, white, grey and ginger) hair from cats has been found to be not significantly different (Hendriks *et al.*, 1998b). However, coat colour and in particular the colour black was recently shown to be dependent on the level of aromatic amino acid intake in kittens (Yu *et al.*, 2001).

The replacement of hair in cats and dogs is a cyclic phenomenon resulting from the cyclic events which occur in individual hair follicles. Three stages are identified including an active growth phase (anagen), transition phase (catagen) and a resting phase (telogen). Variation in the length of the anagen phase or rate of hair production will affect the amount of hair produced whereas the length of the telogen phase will determine the timing of the next moult. Hair density is affected by the timing of the shedding of the old hair when the new hair has grown (Johnson, 1972). Baker (1974) and Ryder (1976) determined the inactivity of hair follicles of cats throughout the year and showed that hair growth follows a sinusoidal pattern throughout the year with one moult occurring around spring. This hair replacement pattern differs from that of dogs where two moulting seasons are observed (Rougeot, 1981; Mundt and Stafforst, 1987). Quantitative estimates of amino acid losses from hair are difficult to determine as it involves estimation of the amount of hair produced at various phases of the hair growth cycle. As there are over 150 breeds of dogs, representing a large range of body weights (1 kg for a Chihuahua to over 70 kg for a Newfoundland) and over 100 breeds of cats, it may be difficult to provide one overall estimate to describe hair growth for all cats and dogs. Stafforst (1982) provided information on the monthly hair growth of five dogs of varying breeds throughout the year. Average monthly hair growth rates varied from 14.3 to 94.5 mg cm<sup>-2</sup> body surface area depending on the month of the year. Interestingly the total amount of hair grown per year was remarkably similar for the dogs and showed similar seasonal growth rates despite the fact

that two of the dogs were short-haired and three dogs were long-haired breeds. This may indicate that the anagen phase is similar between breeds but the telogen phase differs. Estimates of yearly hair growth in the dogs ranged from 5.5 to 6.7 g cm<sup>-2</sup> body surface area (Stafforst, 1982). Hendriks *et al.* (1997b, 1998a) provided mathematical functions describing hair growth and hair loss, respectively, in adult domestic short-haired cats throughout the year. Total yearly hair growth and hair loss were found to be similar (32.7 vs. 28.1 g kg<sup>-1</sup> body weight) but out of phase by approximately 75 days. The quantitative hair replacement pattern described by Hendriks *et al.* (1998a) in cats showed that the density of the coat closely follows the temperature pattern throughout the year (Fig. 22.1). The densest and sparsest coats were obtained at day 168 and 351 of the study which coincided with the average minimum and maximum daily temperatures, recorded at day 167 and 350, respectively.

Estimates of the amount of amino acids required for hair growth at any point in time throughout the year can be calculated by multiplying the concentration of each amino acid in hair by the total body hair growth rate at a specific point in time or during a specified period. Table 22.4 presents the monthly levels of hair protein required for the synthesis of hair in adult cats and dogs per unit surface area. The estimates for dogs are approximately 10–15 times higher compared to the estimates in cats. In comparing these estimates it has to be taken into account that the estimates for cats are based on growth rates over the entire body whereas those for dogs relate to the growth rate of hair on the side of the thorax. The latter site may not be representative of the hair growth rate over the entire body. Equations to calculate the surface area from body weight measurements of adult cats are provided by Greaves (1957) and Bartorelli and Gerola (1963). Price and Frazier (1998) present many of the published results for adult dogs. Further research is required to determine whether there is a difference in the anagen phase between long-haired and short-haired canine and feline breeds or, as the data suggest in dogs, the difference lies in the length of the telogen phase of the follicle cycle.



**Fig. 22.1.** Sine-functions<sup>a</sup> describing daily hair growth<sup>b</sup> (...) and hair loss<sup>b</sup> (- - -) rate and the daily change in body hair<sup>c</sup> (—) throughout the year in adult domestic short-haired cats (longitude 174°38' E, latitude 40°22' S). <sup>a</sup> $f(x) = a + b \times \sin(0.0172 \times (x - d))$  where  $a$  = horizontal shift,  $b$  = half amplitude and  $d$  = phase shift of the sine. <sup>b</sup>Average value of 83.2 and 50.0 for parameter  $a$  and  $b$ , respectively taken from Hendriks *et al.* (1997b, 1998a). Values for parameter  $d$  for hair growth and loss from Hendriks *et al.* (1997b) and Hendriks *et al.* (1998a), respectively. <sup>c</sup> $y = 58.6 \times \sin(0.0172 \times x) + 14.9 \times \cos(0.0172 \times x)$ .

**Table 22.4.** Monthly hair protein required for hair growth in adult cats and dogs.

Hemisphere		Hair protein (mg cm <sup>-2</sup> surface area)	
Southern	Northern	Cats <sup>a</sup>	Dogs <sup>b</sup>
January	July	4.08	57.8
February	August	4.33	86.9
March	September	4.98	64.9
April	October	4.54	45.4
May	November	3.97	31.7
June	December	2.90	30.4
July	January	2.02	38.0
August	February	1.33	67.4
September	March	1.07	27.0
October	April	1.41	13.2
November	May	2.07	24.4
December	June	3.12	34.0

<sup>a</sup>From Hendriks *et al.* (1997b) measured over the entire body.

<sup>b</sup>From Stafforst (1982) measured at a 10 cm<sup>2</sup> area at the side of the thorax.

### Amino Acids Required for the Synthesis of Other Compounds

Amino acids are lost from the body of the cat and dog through the synthesis of non-amino nitrogen containing compounds (e.g. histamine, serotonin, etc.) and amino acid nitrogen contain-

ing compounds (e.g. 3-methylhistidine, carnitine, purines, creatine, feline, etc.) (see Chapters 1 and 4). Although the losses of amino acids from the body through these routes are often considered to be small (Reeds, 1988; Moughan, 1995) in some cases the amount of amino acids lost via these compounds can be significant.

### **N**-Methylhistidine (3-methylhistidine)

3-Methylhistidine is a normal constituent of chains of actin and myosin and is formed by post-translational donation of a methionine methyl group to actin and myosin histidine. After degradation of these proteins, the liberated methylated histidine (3-methylhistidine) is not reused but quantitatively excreted in the urine of animals. As such, 3-methylhistidine has been used as a method to continuously monitor the breakdown of myofibrillar proteins in muscle (Young and Munro, 1978; Ward and Buttery, 1980; McCarthy *et al.*, 1983). The amount of 3-methylhistidine excreted by an animal is dependent on the myofibrillar protein catabolic rate. Few quantitative data are available on 3-methylhistidine excretion and factors affecting myofibrillar protein catabolism in adult cats and dogs. Marks *et al.* (1996) showed that 3-methylhistidine can be used to measure skeletal muscle protein losses or gains based on the quantitative recovery of intravenously administered 3-[<sup>14</sup>C]methylhistidine. The latter authors reported an average 3-methylhistidine excretion by two adult cats of 5.8 mg 24 h<sup>-1</sup>. In growing dogs, Hill *et al.* (2001) found that radioactivity of 3-[<sup>14</sup>C]methylhistidine was lost in CO<sub>2</sub> and/or re-circulated in the body, as reported for sheep and pigs. The latter indicates that 3-methylhistidine cannot be used as a method to measure canine skeletal muscle (myofibrillar) protein breakdown. Rathmacher and Nissen (1998) however described 3-methylhistidine metabolism in dogs with a simple three-compartment model with one urinary exit. The latter authors measured a *de novo* synthesis of 3-methylhistidine in adult dogs of 12.1 μmol kg<sup>-1</sup> day<sup>-1</sup>. A lower value of 5.0 μmol kg<sup>-1</sup> day<sup>-1</sup> was reported by Hoppe *et al.* (1993) in adult beagles. Further studies are required to determine the effects of nutrition, hormones, and gender on 3-methylhistidine production and the suitability of 3-methylhistidine as a quantitative index of *in vivo* muscle catabolism in dogs.

### **Felinine**

Felinine (2-amino-7-hydroxy-5,5-dimethyl-4-thiaheptanoic acid) is a sulphur-containing amino acid present in the urine of certain members of the Felidae family including the domestic cat. Discovered by Datta and Harris (1951), 24 h felinine excretion levels of entire male cats have been reported to be 25 mg kg<sup>-1</sup> body weight whereas castrated male, entire female and spayed female cats excrete 8.5, 7.5 and 4.1 mg kg<sup>-1</sup> body weight (Hendriks *et al.*, 1995). Precursors of felinine synthesis were recently shown to include cysteine and methionine with cysteine being a more immediate precursor for felinine synthesis than methionine (Hendriks *et al.*, 2001). It has been hypothesized since the discovery of felinine that this amino acid is present in the blood of cats at extremely low levels or synthesized in the kidney and directly excreted in the urine. Recently however, Rutherford *et al.* (2001) identified a felinine containing tripeptide (γ-glutamylfelinylglycine) in the blood of domestic cats, opening the possibility that felinine synthesis occurs in other tissues (most likely the liver) within the body and is transported to the kidney in a tripeptide form. Synthesis of γ-glutamylfelinylglycine has been hypothesized to occur in the liver through a condensation reaction of an allylic carbonium ion and the amino acid cysteine in glutathione (Hendriks *et al.*, 2001). γ-Glutamylfelinylglycine once transported to the kidney can yield free felinine which can be excreted in the urine through the action of the common glutathione degradation enzymes, γ-glutamyltransferase and aminopeptidase M. The latter 'liberation' of felinine, however, remains to be proven. To allow normal levels of felinine synthesis in domestic cats, the sulphur containing amino acid cysteine or methionine is required with the amounts required being dependent on the gender of the animal.

### **Creatine**

Creatine is involved in the energy delivery process in tissues and in the phosphorylated form (phosphocreatine) is directly involved in



maintaining low adenosine diphosphate concentrations at locations where energy is utilized. Creatine is synthesized from the amino acids arginine and glycine in the kidney and the liver (see Fig. 4.8). Creatine degrades *in vivo* to creatinine which is not used by the animal and is rapidly excreted in the urine. The irreversible conversion of creatine into creatinine occurs spontaneously and at a relatively constant rate. As such, creatinine is often used to validate quantitative urine collection in animals and humans although the suitability of creatinine for the validation of quantitative urine collection in humans has been questioned (Knuiman *et al.*, 1986). Quantitative data on endogenous creatine and creatinine excretion in the urine of adult cats and dogs are scarce as many studies used creatinine-containing diets. Sagawa *et al.* (1995) showed that creatinine is absorbed by the intestine and excreted in the urine of adult cats. In adult dogs, Hoppe *et al.* (1993) reported a daily endogenous creatinine excretions of 33.9 mg kg<sup>-1</sup> body weight. In adult cats, Worden *et al.* (1960) reported 24 h urinary creatine and creatinine values of 10.0 and 52.5 mg kg<sup>-1</sup> body weight, respectively. The accuracy of these values, however, should be questioned as problems with the analysis of creatine and creatinine were reported and the cats were fed diets which most likely would have contained creatine and creatinine. Hendriks *et al.* (1997a) reported 24 h endogenous creatinine excretion levels in adult cats fed a protein-free diet of 30.9 mg kg<sup>-1</sup>, and a slightly higher but not significantly different value was found using the regression to zero protein intake approach (31.7 mg kg<sup>-1</sup>). Hendriks *et al.* (1999) reported a similar value of 30.5 mg kg<sup>-1</sup> day<sup>-1</sup> in adult cats fasted for 2 days.

### Irreducible Oxidation of Body Amino Acids Associated with Body Protein Turnover

Measurements of the loss of body amino acids originating from amino acid catabolism *in vivo* have been made by measuring endogenous urinary nitrogen excretion in animals fed a protein-free diet (Calloway and Margen, 1971; Yokogoshi *et al.*, 1977; Kendall *et al.*, 1982; Meyer *et al.*, 1989). Estimates of endogenous urinary nitrogen (EUN) excretion in adult dogs using a protein-free diet have been determined in a number of studies (Table 22.5). The estimates shown in Table 22.5 are remarkably consistent between studies and show that EUN excretion in adult dogs fed a protein-free diet is approximately 208 mg kg<sup>-0.75</sup> day<sup>-1</sup>. Kendall *et al.* (1982) also measured endogenous urinary urea nitrogen (EUUN) excretion in adult dogs fed a protein-free diet. These authors reported an EUN and EUUN excretion of 210 and 108 mg kg<sup>-0.75</sup> day<sup>-1</sup>, respectively. Meyer *et al.* (1989) found similar values of 186 and 113 mg kg<sup>-0.75</sup> day<sup>-1</sup>. Using the regression to zero protein intake approach, the latter authors found higher EUN excretions in adult dogs of 250 mg kg<sup>-0.75</sup> day<sup>-1</sup>. Few estimates of EUN and EUUN exist in adult cats, because cats do not as readily accept a protein-free diet as dogs. Hendriks *et al.* (1997a) determined the endogenous urinary excretion of various nitrogen metabolites in adult domestic cats using a protein-free diet and the regression to zero protein intake technique. EUN, EUUN and endogenous urinary ammonia nitrogen of 360, 243 and 27.6 mg kg<sup>-0.75</sup> day<sup>-1</sup>, respec-

**Table 22.5.** Literature estimates of endogenous urinary nitrogen (EUN) excretion in adult dogs fed a protein-free diet.

Source	Daily EUN			<i>n</i>	Body weight (kg)
	(mg kg <sup>-1</sup> )	(mg kg <sup>-0.75</sup> )	(mg kg <sup>-0.67</sup> )		
Allison <i>et al.</i> (1949)	–	–	260	12	8.3–15.1
Dawson <i>et al.</i> (1961)	110	220	227	20	16.5
Bressani <i>et al.</i> (1965)	114	214	216	4	10.6–16.7
Kendall <i>et al.</i> (1982)	117	210	256	20	2.8–51.0
Meyer <i>et al.</i> (1989)	109	186	–	4	8.8
Average	113	208	240	–	–

tively, were found using the protein-free approach whereas lower values, except for ammonia, were found using the regression approach (316, 232 and 33.7 mg kg<sup>-0.75</sup> day<sup>-1</sup>, respectively for EUN, EUUN and endogenous urinary ammonia nitrogen). The higher values obtained using the protein-free approach were likely the result of the preferential catabolism of endogenous amino acids to supply energy, as the intake of the cats on the protein-free diet was 53% of energy requirements. Biourge *et al.* (1994) reported an EUN excretion in food deprived adult cats of 297 mg kg<sup>-0.67</sup> day<sup>-1</sup>. Estimates of EUN excretion in the case of adult cats are much higher than estimates in other animals whereas the estimates for dogs are slightly higher compared to omnivorous animals (Table 22.6). The main reason for the higher excretion of EUN in cats is due to the high excretion of EUUN. This is not unexpected, as the cat is an obligatory carnivore which has been shown to have a limited ability to conserve nitrogen because of non-adaptive hepatic enzymes involved in the catabolism of non-essential amino acids (Rogers *et al.*, 1977). These enzymes are set to handle a high protein diet and the cat, therefore, loses a large amount of amino acid nitrogen even when fed a low protein or protein-free diet (Rogers and Morris, 1980). The enzymes involved in the degradation of essential amino acids are controlled as growing cats have been shown to have similar requirements for essential amino acids.

Endogenous urinary nitrogen excretions are often used in the factorial calculation of protein requirements of animals (Calloway and Margen, 1971; Kendall *et al.*, 1982; Meyer *et al.*, 1989). However, do estimates of EUUN in cats and dogs, determined by feeding the animal a protein-free diet or determined by the regression to zero protein intake approach, represent those losses associated with the irreducible oxidation of body amino acids due to body protein turnover? Feeding a protein-free diet to an animal results in the labile body protein stores meeting the metabolic demand for amino acids. Amino acids supplied through the breakdown of body protein stores will be used to synthesize those compounds most essential to maintain the animal's vital functions, e.g. synthesis of neurotransmitters, hormones, digestive enzymes, etc. In addition amino acids will be oxidized through existing metabolic pathways as a result of the inevitable consequence of the operation of mechanisms controlling the degradation of amino acids in the body (Heger and Frydrych, 1989). As a result, the first-limiting amino acid will determine the rate of whole body protein synthesis and the rate of catabolism of the 'excess' amino acids (Reeds, 1988; Millward, 1998). This catabolism of excess amino acids will determine the rate of EUN excretion. The latter explains the observation that the provision of the first-limiting amino acid to an animal receiving a protein-free diet will significantly reduce the

**Table 22.6.** Endogenous urinary nitrogen (EUN) and endogenous urinary urea nitrogen (EUUN) excretion in various animal species fed a protein-free diet.

Species	EUN (mg kg <sup>-0.75</sup> day <sup>-1</sup> )	EUUN (mg kg <sup>-0.75</sup> day <sup>-1</sup> )
Cats <sup>a</sup>	360	243
Dogs <sup>b</sup>	198	111
Humans <sup>c</sup>	62	—
Rats <sup>d</sup>	128	60
Pigs <sup>e</sup>	163	70

<sup>a</sup>From Hendriks *et al.* (1997a).

<sup>b</sup>From Kendall *et al.* (1982) and Meyer *et al.* (1989).

<sup>c</sup>From Calloway and Margen (1971).

<sup>d</sup>From Yokogoshi *et al.* (1977).

<sup>e</sup>From Moughan *et al.* (1987).

catabolism of endogenous amino acids (Yoshida and Moritoki, 1974; Maramatsu *et al.*, 1986).

Isotopic dilution techniques using labelled essential amino acids have been used to obtain *in vivo* estimates of the rate of whole body protein turnover in adult dogs. Recently Humbert *et al.* (2001) determined the rates of protein breakdown, oxidation and synthesis from leucine appearance into plasma, oxidation and non-oxidative disposal, respectively, in adult dogs fasted for 24 h using L-[1-<sup>13</sup>C]leucine. These authors reported a leucine oxidation rate in dogs fed a normal protein diet (63 g crude protein per Mcal ME) of 50.6  $\mu\text{mol kg}^{-1} \text{h}^{-1}$ . Schwenk *et al.* (1987) using [<sup>13</sup>C]-leucine found a leucine oxidation rate in adult dogs fasted overnight of 36.0  $\mu\text{mol kg}^{-1} \text{h}^{-1}$ . A slightly higher value of 66.4  $\mu\text{mol kg}^{-1} \text{h}^{-1}$  was reported by Yu *et al.* (1990) using [1-<sup>13</sup>C,<sup>15</sup>N]leucine in adult dogs fasted overnight. To convert these estimates of body leucine oxidation into body protein oxidation and individual body amino acid oxidation estimates, the

amino acid pattern of whole body protein can be used. With this approach it is assumed that the rate of oxidation of body amino acids occurs in the pattern which amino acids are present in whole body protein. The latter may not be entirely correct as some proteins with an amino acid pattern different from that of whole body protein may have a faster turnover rate compared to other body proteins. Liver proteins have a half-life ranging from minutes to hours whereas the half-life of some collagen proteins, with its unique amino acid pattern, can be 50–300 days (Waterlow *et al.*, 1978). Only if the amino acid pattern of oxidized body amino acids differs significantly from the amino acid pattern of whole body protein will this approach generate inaccurate estimates. However, as a first approximation this approach will yield estimates of irreducible oxidation of body amino acids associated with the protein turnover from leucine oxidation rates. Table 22.7 presents the amino acid pattern and content of whole body protein in adult dogs and cats. It can be calculated from the

**Table 22.7.** Amino acid composition of body protein of adult cats and dogs.

	Cats <sup>a</sup>	Dogs <sup>b</sup>
	( $\mu\text{mol g}^{-1}$ crude protein (N $\times$ 6.25))	
Lysine	473	431
Arginine	385	356
Histidine	194	134
Isoleucine	254	290
Leucine	535	503
Methionine	151	137
Phenylalanine	220	212
Threonine	335	353
Valine	368	393
Cysteine	95	n.d. <sup>c</sup>
Taurine	18	n.d.
Tyrosine	154	n.d.
Alanine	742	n.d.
Aspartate	615	781
Glutamate	902	863
Glycine	1303	1305
Hydroxylysine	21	n.d.
Proline	569	n.d.
Serine	396	n.d.

<sup>a</sup>From Hendriks *et al.* (1997c).

<sup>b</sup>From Dunn *et al.* (1949).

<sup>c</sup>n.d., not determined.

value presented in Table 22.7 that 1 g of whole body protein in adult dogs contains approximately 583  $\mu\text{mol}$  of protein-bound leucine. Using this value and the average leucine oxidation rates of the above-mentioned studies ( $51.0 \mu\text{mol kg}^{-1} \text{ day}^{-1}$ ), body protein oxidation in adult fasted dogs is approximately  $2.10 \text{ g kg}^{-1} \text{ day}^{-1}$ . Humbert *et al.* (2001) using slightly different assumptions reported a value of  $0.63 \text{ g N kg}^{-0.75} \text{ day}^{-1}$  or (assuming body protein contains 16% nitrogen)  $3.93 \text{ g kg}^{-0.75} \text{ day}^{-1}$  (or  $2.06 \text{ g kg}^{-1} \text{ day}^{-1}$ ). To the author's knowledge, there are no estimates of leucine oxidation rates in adult cats available in the literature.

### Conclusions

This contribution presents quantitative information on amino acids required for key physiological processes in the body of adult cats and dogs which collectively give rise to the maintenance requirements in these species. Much of the information required to construct a factorial model to generate specific maintenance amino acid requirements for these two species is available in the literature. Gut endogenous amino acid losses in adult cats and dogs are well characterized although the influence of dietary factors on these losses needs further investigation. Amino acids lost through the continual shedding of hair have been characterized in both species although further quantitative information is required especially in adult dogs. In addition,

it remains to be established whether there is a difference in the anagen phase between long-haired and short-haired canine and feline breeds or, as the data suggest in dogs, the difference lies in the length of the telogen phase of the follicle cycle. There is a general lack of information on the endogenous amino acids lost via the urinary tract of cats and dogs. Although these may comprise only a small fraction of the total endogenous amino acid losses of the animal, endogenous urinary amino acids losses will increase with increased dietary intake of protein. Amino acids required for the synthesis of a number of compounds in the body (e.g. creatine, felinine, 3-methylhistidine) have been quantified in both species although quantitative data on amino acids required for the synthesis of other compounds would further strengthen the model. Data on the irreducible oxidation of body amino acids associated with body protein turnover in adult dogs are available whereas there are no data available in adult cats. Although endogenous urinary nitrogen excretions in both species are well researched, these losses cannot be used in a factorial model to determine maintenance amino acid requirements of the two species. Constructing a factorial model to determine amino acid requirements of adult cats and dogs will provide, beside a flexible and additive approach, a descriptive tool which provides insight into the relative importance of the various physiological processes that give rise to the overall amino acid requirements.

### References

- Adams, L.G., Polzin, D.J., Osborne, C.A. and O'Brien, T.D. (1992) Correlation of urine protein/creatinine ratio and twenty-four-hour urinary protein excretion in normal cats and cats with surgically induced chronic renal failure. *Journal of Veterinary Internal Medicine* 6, 36–40.
- Allison, J.B., Anderson, J.A. and White, J.I. (1949) Evaluation of the nutritional value of proteins, with normal and protein-deficient dogs. *Cereal Chemistry* 7, 24–33.
- Baker K.P. (1974) Hair growth and replacement in the cat. *British Veterinary Journal* 130, 327–335.
- Bartorelli, C. and Gerola, A. (1963) Tidal volume, oxygen uptake, cardiac output, and body surface in the cat. *American Journal of Physiology* 205, 588–590.
- Biewenga, W.J., Gruys, E. and Hendriks, H.J. (1982) Urinary protein loss in the dog: nephrological study of 29 dogs without signs of renal disease. *Research in Veterinary Science* 33, 366–374.
- Biouрге V., Groff, J.M., Fisher, C., Bee, D., Morris, J.G. and Rogers, Q.R. (1994) Nitrogen balance, plasma free amino acid concentrations and urinary orotic acid excretion during long-term fasting in cats. *Journal of Nutrition* 124, 1094–1103.
- Blaza, S.E. Burger, I.H., Holme, D.W. and Kendall, P.T (1982) Sulfur-containing amino acid requirements of growing dogs. *Journal of Nutrition* 112, 2033–2042.

- Boudreau, J.C. and White, T.D. (1978) Flavor chemistry of carnivore taste systems. In: Bullard, R.W. (ed.) *Flavour Chemistry of Animal Foods*. American Chemical Society, Washington, DC, pp. 102–128.
- Bressani, R., Braham, J.E., Elias, L.G. and Balconi, R. (1965) Urinary nitrogen and sulphur excretion in dogs under different dietary treatments. *Journal of Nutrition* 87, 77–84.
- Calloway, D.H. and Margen, S. (1971) Variation in endogenous nitrogen excretion and dietary nitrogen utilization as determinants of human protein requirements. *Journal of Nutrition* 101, 205–216.
- Datta, S.P. and Harris, H. (1951) A convenient apparatus for paper chromatography. Results of a survey of the urinary amino acid patterns of some animals. *Journal of Physiology* 114, 39P–41P.
- Dawson, D. and Allen, J.G. (1961) Biological study of fifty-six-day protein-free diet in dogs. *American Journal of Clinical Nutrition* 9, 320–323.
- DiBartolo, S.P., Chew, D.J. and Jacobs, G. (1980) Quantitative urinalysis including 24-hour protein excretion in the dog. *Journal of the American Animal Hospital Association* 16, 537–546.
- Dunn, M.S., Camien, M.N., Malin, R.B., Murphy, E.A. and Reiner, P.J. (1949) Percentages of twelve amino acids in blood, carcass, heart, kidney, liver, muscle, and skin of eight animals. *University of California Publication in Physiology* 8, 293–325.
- Fauconneau, G. and Michel, M. (1970) The role of the gastrointestinal tract in the regulation of protein metabolism. In: Munro, H.N. (ed.) *Mammalian Protein Metabolism*, vol. IV. Academic Press, New York, pp. 481–522.
- Fucci, V., Pechman, R.D., Hedlund, C.S. and Venugopalan, C.S. (1995) Large bowel transit times using radiopaque markers in normal cats. *Journal of the American Animal Hospital Association* 31, 473–477.
- Fuller, M.F. (1994) Amino acid requirements for maintenance, body protein accretion and reproduction in pigs. In: D'Mello, J.P.F. (ed.) *Amino Acids in Farm Animal Nutrition*. CAB International, Wallingford, UK, pp. 155–184.
- Greaves, J. P. (1957) Surface area of the cat. *Journal of Physiology* 138, 43P.
- Greaves, J.P. and Scott, P.P. (1960) Nutrition of the cat 3. Protein requirements for nitrogen equilibrium in adult cats maintained on a mixed diet. *British Journal of Nutrition* 14, 361–369.
- Heger, J. and Frydrych, Z. (1989) Efficiency of utilization of amino acids. In: Friedman, M. (ed.) *Absorption and Utilization of Amino Acids*. CRC Press, Boca Raton, Florida, pp. 31–56.
- Hendriks, W.H., Tarttelin, M.F. and Moughan, P.J. (1995) Twenty-four hour feline excretion patterns in entire and castrated cats. *Physiology and Behavior* 58, 467–469.
- Hendriks, W.H., Moughan, P.J. and Tarttelin, M.F. (1996) Gut endogenous nitrogen and amino acid excretions in adult domestic cats fed a protein-free or an enzymatically hydrolyzed casein-based diet. *Journal of Nutrition* 126, 955–962.
- Hendriks, W.H., Moughan, P.J. and Tarttelin, M.F. (1997a) Urinary excretion of endogenous nitrogen metabolites in adult domestic cats using a protein-free diet and the regression technique. *Journal of Nutrition* 127, 623–629.
- Hendriks, W.H., Tarttelin, M.F. and Moughan, P.J. (1997b) Seasonal hair growth in the adult domestic cat (*Felis catus*). *Comparative Biochemistry and Physiology* 116A, 29–35.
- Hendriks, W.H., Moughan, P.J. and Tarttelin, M.F. (1997c) Body composition of the adult domestic cat. *Journal of Animal Physiology and Animal Nutrition* 77, 16–23.
- Hendriks, W.H., Tarttelin, M.F. and Moughan, P.J. (1998a) Seasonal hair loss in the adult domestic cat (*Felis catus*). *Journal of Animal Physiology and Animal Nutrition* 79, 92–101.
- Hendriks, W.H., Moughan, P.J. and Tarttelin, M.F. (1998b) The amino acid composition of cat (*Felis catus*) hair. *Animal Science* 67, 165–170.
- Hendriks, W.H., Wamberg, S. and Tarttelin, M.F. (1999) A metabolism cage for quantitative urine collection and accurate measurements of water balance in adult cats (*Felis catus*). *Journal of Animal Physiology and Animal Nutrition* 82, 94–105.
- Hendriks, W.H., Rutherford, S.M. and Rutherford, K.J. (2001) Relative importance of <sup>35</sup>S-methionine, <sup>35</sup>S-cysteine and <sup>35</sup>S-sulphate in the synthesis of feline. *Comparative Biochemistry and Physiology* 129, 211–216.
- Hickman, M.A., Rogers, Q.R. and Morris, J.G. (1992) Taurine balance is different in cats fed purified and commercial diets. *Journal of Nutrition* 122, 553–559.
- Hill, A.S., Marks, S.L. and Rogers, Q.R. (2001) Quantitation of urinary 3-methylhistidine excretion in growing dogs as an index of *in vivo* skeletal muscle catabolism. *Journal of Nutritional Biochemistry* 12, 346–350.
- Hoppe, A., Denneberg, T., Jeppsson, J.-O. and Kågedal, B. (1993) Urinary excretion of amino acids in normal and cystinuric dogs. *British Journal of Nutrition* 149, 253–268.

- Humbert, B., Bleis, P., Martin, L., Dumon, H., Darmaun, D. and Nguyen, P. (2001) Effects of dietary protein restriction and amino acid deficiency on protein metabolism in dogs. *Journal of Animal Physiology and Animal Nutrition* 85, 255–262.
- Humphreys, E.R. and Scott, P.P. (1962) Observations on the use of markers in determining food transit times in the cat. *Proceedings of the Physiological Society* 162, 28P–29P.
- Johnson, E. (1972) Moulting cycles. *Mammal Reviews* 1, 198–208.
- Kendall, P.T., Blaza, S.E. and Holme, D.W. (1982) Assessment of endogenous nitrogen output in adult dogs of contrasting size using a protein-free diet. *Journal of Nutrition* 112, 1281–1286.
- Knuiman, J.T., Hautvast, J.G., van der Heijden, L., Geboers, J., Joossens, J.V., Tornquist, H., Isaksson, B., Pietinen, P., Tuomilehto, J., Flynn, A., Shortt, C., Boing, H., Yomtov, B., Angelico, F. and Ricci, G. (1986) A multi-centre study on within-person variability in the urinary excretion of sodium, potassium, calcium, magnesium and creatinine in 8 European centres. *Human Nutrition and Clinical Nutrition* 40C, 343–348.
- Linder, M.C. (1991) *Nutritional Biochemistry and Metabolism with Clinical Applications*. Elsevier, Amsterdam, pp. 89–109.
- Maramatsu, T., Kato, M., Tasaki, I. and Okamura, J. (1986) Enhanced whole-body protein synthesis by methionine and arginine supplementation in protein-starved chicks. *British Journal of Nutrition* 55, 635–641.
- Marks, S.L., Rogers, Q.R. and Morris, J.G. (1996) Quantitative excretion of 3-methylhistidine in urine of cats as a measure of *in vivo* skeletal muscle protein metabolism. *Journal of Nutritional Biochemistry* 7, 60–63.
- Marshall, I.E. and Johnson, J.V. (1993) Digestion and absorption. In: Burger, I. (ed.) *The Waltham Book of Companion Animal Nutrition*. Pergamon Press, Oxford, pp. 25–44.
- McCarthy, F.D., Bergen, W.G. and Hawkins, D.R. (1983) Muscle protein turnover in cattle of differing genetic backgrounds as measured by urinary N<sup>15</sup>-methylhistidine excretion. *Journal of Nutrition* 113, 2455–2463.
- Meyer, H., Schünemann, C., Elbers, H. and Junker, S. (1987) Precaecal and post ileal protein digestion and intestinal urea conversion in dogs. In: Edney, A.T.B. (ed.) *Nutrition, Malnutrition and Dietetics in the Dog and Cat*. Proceedings of an International Symposium held in Hanover, Waltham Centre for Pet Nutrition, England, pp. 27–30.
- Meyer, H., Wiese-Twele, M., Grübler, B. and Schünemann, C. (1989) Investigations on endogenous ileal, faecal and renal N-excretion. [in German] *Advances in Animal Physiology and Animal Nutrition* 19, 86–93.
- Millward, D.J. (1998) Metabolic demands for amino acids and the human dietary requirement: Millward and Rivers (1988) revisited. *Journal of Nutrition* 128, 2563S–2576S.
- Monroe, W.E., Davenport, D.J. and Saunders, G.K. (1989) Twenty-four hour urinary protein loss in healthy cats and the urinary protein-creatinine ratio as an estimate. *American Journal of Veterinary Research* 50, 1906–1909.
- Morris, J.G. (2001) Unique nutrient requirements of cats appear to be diet-induced evolutionary adaptations. *Recent Advances in Animal Nutrition in Australia* 13, 187–194.
- Morris, J.G., Rogers, Q.R., Kim, S.W. and Backus, R.C. (1994) Dietary taurine requirement of cats is determined by microbial degradation of taurine in the gut. In: Huxtable, R.J. and Michalk, D. (eds) *Taurine in Health and Disease*. *Advances in Experimental Medicine and Biology* 359, 59–70.
- Moughan, P.J. (1995) Modelling protein metabolism in the pig – critical evaluation of a simple reference model. In: Moughan, P.J., Verstegen, M.W.A. and Visser-Reyeneveld, M.I. (eds) *Modelling Growth in the Pig*. EAAP Publication No. 78, Wageningen Press, Wageningen, The Netherlands, pp. 103–112.
- Moughan, P.J., Smith, W.C. and Kies, A.K. (1987) Endogenous urinary metabolite excretion in the growing pig. *New Zealand Journal of Agricultural Research* 30, 183–187.
- Mundt, H.-C. and Stafforst, C. (1987) Production and composition of dog hair. In: Edney, A.T.B. (ed.) *Nutrition, Malnutrition and Dietetics in the Dog and Cat*. Proceedings of an International Symposium held in Hanover, British Veterinary Association and Waltham Centre for Pet Nutrition, England, pp. 62–65.
- NRC (1985) *Nutrient Requirements of Dogs*, revised edn. National Academy Press, Washington, DC.
- NRC (1986) *Nutrient Requirements of Cats*, revised edn. National Academy Press, Washington, DC.
- Price, G.S. and Frazier, D.L. (1998) Use of body surface area (BSA)-based dosages to calculate chemotherapeutic drug dose in dogs: 1. Potential problems with current BSA formulae. *Journal of Veterinary Internal Medicine* 12, 267–271.

- Quam, D.D., Morris, J.G. and Rogers, Q.R. (1987) Histidine requirement of kittens for growth, haematopoiesis and prevention of cataracts. *British Journal of Nutrition* 58, 521–532.
- Rainbird, A. and Kienzle, E. (1990) Studies on the energy requirement of dogs depending on breed and age. *Kleintierpraxis* 35, 149–158.
- Rathmacher, J.A. and Nissen, S.L. (1998) Development and application of a compartmental model of 3-methylhistidine metabolism in humans and domestic animals. *Advances in Experimental Medicine and Biology* 445, 303–324.
- Reeds, P.J. (1988) Nitrogen metabolism and protein requirements. In: Blaxter, K. and MacDonald, I. (eds) *Comparative Nutrition*. John Libbey, London, pp. 55–72.
- Rogers, Q.R. and Morris, J.G. (1980) Why does the cat require a high protein diet? In: Anderson, R.S. (ed.) *Nutrition of the Dog and Cat*. Pergamon Press, Oxford, pp. 45–66.
- Rogers, Q.R., Morris, J.G. and Freedland, R.A. (1977) Lack of hepatic enzymatic adaptation to low and high levels of dietary protein in the adult cat. *Enzyme* 22, 348–356.
- Rougeot, J. (1981) The factors affecting coat quality in dogs [in French]. *L'Animal de Compagnie* 16, 105–119.
- Russo, E.A., Lees, G.E. and Hightower, D. (1986) Evaluation of renal function in cats, using quantitative urinalysis. *American Journal of Veterinary Research* 47, 1308–1312.
- Rutherford, K.J., Rutherford, S.M., Moughan, P.J. and Hendriks, W.H. (2001) Isolation and characterisation of a feline containing peptide from the blood of the domestic cat (*Felis catus*). *Journal Biological Chemistry* 277, 114–119.
- Ryder, M.L. (1976) Seasonal changes in the coat of the cat. *Research in Veterinary Science* 21, 280–283.
- Sagawa, M., Kaneko, T., Akagawa, S. and Ono, K. (1995) Plasma creatinine levels and food creatinine contents in cats. [in Japanese] *Journal of the Japanese Veterinary Medical Association* 18, 871–874.
- Schwenk, W.F., Rubanyi, E. and Haymond, M.W. (1987) Effect of a protein synthetic inhibitor on *in vivo* estimates of protein synthesis in dogs. *American Journal of Physiology* 252, E595–E598.
- Snook, J.T. (1973) Protein digestion, nutritional and metabolic considerations. *World Review of Nutrition and Dietetics* 18, 121–176.
- Sritharan, K. (1998) The rat as a model animal for digestion in the dog. MSc thesis, Massey University, Palmerston North, New Zealand.
- Stafforst, C. (1982) Investigations into the weight, growth and composition of the coat of the dog. Diss. Vet. Med., Institut für Tierernährung der Tierärztlichen Hochschule, Hannover, Germany.
- Stevenson, A.E. and Markwell P.J. (2001) Comparison of urine composition of healthy Labrador retrievers and miniature schnauzers. *American Journal of Veterinary Research* 62, 1782–1786.
- Ward, L.C. and Buttery, P.J. (1980) Dietary protein intake and 3-methylhistidine excretion in the rat. *British Journal of Nutrition* 44, 381–390.
- Waterlow, J.C., Garlick, P.J. and Millward, D.J. (1978) *Protein Turnover in Mammalian Tissues and in the Whole Body*. North-Holland Publishing Company, Amsterdam, pp. 804.
- White, J.V., Olivier, N.B., Reimann, K. and Johnson, C. (1984) Use of protein-to-creatinine ratio in a single urine specimen for quantitative estimation of canine proteinuria. *Journal of the American Veterinary Medical Association* 185, 882–885.
- Wood, H.O. (1944) The surface area of the intestinal mucosa in the rat and in the cat. *Journal of Anatomy* 78, 103–105.
- Worden, A.N., Waterhouse, C.E. and Sellwood, E.H.B. (1960) Studies on the composition of normal urine cats. *Journal of Small Animal Practice* 1, 11–23.
- Yokogoshi, H., Hayase, K. and Yoshida, A. (1977) Effect of supplementation of methionine and threonine to a protein-free diet on urinary excretion of nitrogen and tissue free amino acids in rats. *Journal of Nutrition* 107, 783–791.
- Yoshida, A. and Moritoli, K. (1974) Nitrogen sparing action of methionine and threonine in rats receiving a protein-free diet. *Nutrition Reports International* 9, 159–168.
- Young, V.R. and Munro, H.N. (1978) N<sup>m</sup>-Methylhistidine (3-methylhistidine) and muscle protein turnover: an overview. *Federation Proceedings* 37, 2291–2300.
- Yu, S., Rogers, Q.R. and Morris, J.G. (2001) Effect of low levels of dietary tyrosine on the hair colour of cats. *Journal of Small Animal Practice* 42, 176–180.
- Yu, Y-M., Wagner, D.A., Tredget, E.E., Walaszewski, J.A., Burke, J.F. and Young, V.R. (1990) Quantitative role of splanchnic region in leucine metabolism: L-[1-<sup>13</sup>C, <sup>15</sup>N]leucine and substrate balance studies. *American Journal of Physiology* 259, E36–E51.

# 23 Amino Acid Requirements of Finfish and Crustaceans

R.P. Wilson\*

*Department of Biochemistry and Molecular Biology, Mississippi State University,  
Mississippi State, USA*

---

## Introduction

Certain aspects of amino acid nutrition and metabolism in fish appear to differ from those observed in other vertebrates. Fish are normally fed diets containing 2–4 times as much protein as other vertebrates. This is due to the fact that the optimal dietary protein level required for maximum growth of various cultured fish ranges from about 300 to 550 g crude protein kg<sup>-1</sup> diet (Tacon and Cowey, 1985; Bowen, 1987; Wilson, 1989). This observation has led certain investigators, including myself, to suggest that the efficiency of protein utilization is lower in fish than other animals.

Tacon and Cowey (1985) first noted that the dietary protein requirements of fish are not that dissimilar from those of other vertebrates when expressed relative to feed intake (g protein kg<sup>-1</sup> body weight day<sup>-1</sup>) and live weight gain (g protein kg<sup>-1</sup> live weight gain). Bowen (1987) has compared several parameters relating protein intake to growth of fish and other vertebrates and found very little difference in protein utilization among the species compared (Table 23.1). The data used in making this comparison included

median values for 18 studies for fish and eight studies of other vertebrates, i.e. calf, chicken, lamb, pig and white rat. The only parameters that differed significantly were the level of protein in the diet required for maximum growth and feed efficiency. When the protein requirement data were recalculated to correct for differences in relative protein intake and growth rates, as suggested by Tacon and Cowey (1985), the resulting data were very similar for fish and other vertebrates, thus indicating that the efficiency of protein utilization is very similar among the species compared.

The first definitive studies on amino acid nutrition of fish were conducted in the late 1950s and early 1960s with chinook salmon, *Oncorhynchus tshawytscha*. The initial amino acid test diets were formulated to simulate the amino acid content of chicken egg protein, chinook salmon egg protein and chinook yolk-sac fry protein (Halver, 1957). The diet with an amino acid profile based on chicken egg protein gave the best growth rate and feed efficiency. This diet was then used to determine the qualitative amino acid requirements of chinook salmon (Halver *et al.*, 1957).

\*E-mail address: rpw1@ra.msstate.edu



**Table 23.1.** Comparison of various parameters relating protein intake to growth of fish and other vertebrates. (Data from Bowen, 1987.)

Parameter	Fishes	Other vertebrates
Specific growth rate	2.765	2.445
Protein in diet (g kg <sup>-1</sup> )	403	200
Protein intake at maximum growth (mg protein ingested g <sup>-1</sup> body wt day <sup>-1</sup> )	16.5	12.0
Protein retention efficiency (100 × g protein retained g <sup>-1</sup> protein ingested)	31.0	29.0
Protein growth efficiency (g growth g <sup>-1</sup> protein ingested)	1.945	1.965
Feed conversion efficiency (g growth g <sup>-1</sup> diet ingested)	0.78	0.26

### Qualitative Amino Acid Requirements

Halver *et al.* (1957) determined the essentiality of the 18 common protein amino acids by comparing the relative growth rates of chinook salmon fed the basal and specific amino acid-deficient diet over a 10-week period. For each of the ten indispensable amino acids, groups of the deficient fish were split at 6 weeks, with one subgroup being continued on the deficient diet and the other subgroup fed the basal diet. In each of the subgroups shifted to the basal diet, the fish showed an immediate and substantial growth response to the complete diet. The results indicated that the following ten amino acids were indispensable for chinook salmon: arginine, histidine, isoleucine, leucine, lysine, methionine, phenylalanine, threonine, tryptophan and valine. All other species that have been studied to date have been shown to require the same ten amino acids.

### Determination of Amino Acid Requirements

#### Amino acid test diets

Most investigators have used the method developed by Halver and co-workers (Mertz, 1972) to determine the quantitative amino acid requirements of fish. This procedure

involves feeding graded levels of one amino acid at a time in a test diet containing either all crystalline amino acids or a mixture of casein, gelatin and amino acids formulated so that the amino acid profile is identical to whole chicken egg protein except for the amino acid being tested. This procedure has been used successfully with several species; however, the amino acid test diets must be neutralized with sodium hydroxide for utilization by common carp, *Cyprinus carpio* (Nose *et al.*, 1974) and channel catfish, *Ictalurus punctatus* (Wilson *et al.*, 1977).

Other investigators have used semipurified and practical diets supplemented with crystalline amino acids to estimate the amino acid requirements of certain fish. The semipurified diets have usually included an imbalanced protein as the major source of the dietary amino acids, e.g. zein (Kaushik, 1979) or maize gluten (Halver *et al.*, 1958; Ketola, 1983), which are deficient in certain amino acids. Practical type diets utilize normal feed ingredients to furnish the bulk of the amino acids. These may be formulated with a fixed amount of intact protein and the remaining protein equivalent is made up of crystalline amino acids (Luquet and Sabaut, 1974; Jackson and Capper, 1982; Walton *et al.*, 1984a). The various problems inherent in using these types of diets to assess the amino acid requirements of fish have been discussed elsewhere (Wilson, 1985).

### Growth studies

Most of the amino acid requirement values have been estimated based on the conventional growth response curve or Almquist plot. Replicate groups of fish are fed diets containing graded levels of the test amino acid until measurable differences appear in the weight gain of the test fish. A linear increase in weight gain is normally observed with increasing amino acid intake up to a break-point corresponding to the requirement of the specific amino acid, at which weight gain levels off or plateaus.

Various methods have been used to estimate or calculate the break-point corresponding to the requirement value based on the weight gain data. The requirement values for chinook salmon (reviewed by Mertz, 1972), common carp and Japanese eel, *Anguilla japonica* (Nose, 1979) were estimated using an Almquist plot without the aid of any statistical analysis, whereas others have used regression analysis to generate the Almquist plot (Harding *et al.*, 1977; Akiyama *et al.*, 1985a). Wilson *et al.* (1980) used the continuous broken-line model developed by Robbins *et al.* (1979) to estimate the requirement values. Santiago and Lovell (1988) used both the broken-line model and quadratic regression analysis to estimate the requirement values for Nile tilapia (*Oreochromis niloticus*) based on weight gain data. Quadratic regression analysis resulted in the lowest error term for estimating the requirement values, whereas the broken-line model yielded the lowest error term for only three requirement values. Most of the requirement values that have been reported within the last 10 years have been estimated based on the broken-line model.

The various problems involved in the accurate determination of the amino acid requirements of fish based on growth studies have been reviewed by Cowey and Luquet (1983) and Cowey and Tacon (1983). These problems include: (i) a lack of precision in the interpretation of the growth-response curves, i.e. determining the break-point of the curve has often been subjective; (ii) the growth rates commonly observed with

amino acid test diets have generally been lower than those observed with intact protein diets; and (iii) the possibility exists that some of the crystalline amino acids in the test diets may be leached during the feeding studies.

### Serum or tissue amino acid studies

Some investigators have found a high correlation of either serum or blood and muscle free amino acid levels to dietary amino acid intake in fish. The hypothesis is that serum or tissue concentrations of the amino acid should remain low until the requirement for the amino acid is met and then increase to high levels when excessive amounts of the amino acid are fed. This technique has proven useful in confirming the amino acid requirements in only a few cases. For example, of the ten indispensable amino acid requirement studies in the channel catfish, only the serum lysine (Wilson *et al.*, 1977), threonine (Wilson *et al.*, 1978), histidine (Wilson *et al.*, 1980) and methionine (Harding *et al.*, 1977) data were useful in confirming the requirement values estimated based on weight gain data. Serum methionine data of European sea bass, *Dicentrarchus labrax* (Thebault *et al.*, 1985) and serum lysine of hybrid striped bass (*Morone chrysops* × *M. saxatilis*) (Griffin *et al.*, 1992) have been used to confirm the requirement values for these species. Blood and muscle arginine concentrations were found to increase gradually in rainbow trout, *Oncorhynchus mykiss*, fed increasing levels of arginine and were not useful for assessing the arginine requirement of this species (Kaushik, 1979). Walton *et al.* (1984b) were unable to use blood tryptophan levels to confirm the tryptophan requirement of rainbow trout. Of the ten amino acids required by Nile tilapia, Santiago and Lovell (1988) were only able to use muscle free lysine, threonine and isoleucine concentrations to confirm the requirement values of these amino acids based on growth studies.

### Amino acid oxidation studies

This technique is based on the general hypothesis that when an amino acid is limiting or deficient in the diet, the major portion will be utilized for protein synthesis, and little will be oxidized to carbon dioxide, whereas when an amino acid is supplied in excess, and is thus not a limiting factor for protein synthesis, more of the amino acid will be oxidized. The intake level which produces a marked increase in amino acid oxidation should then be a direct indicator of the requirement value for that specific amino acid.

This technique has been evaluated in rainbow trout with only limited success. Walton *et al.* (1984a) were successful in using this technique to confirm the lysine requirement of rainbow trout based on weight gain data. Following the growth study, three fish from each dietary treatment were injected intraperitoneally with a tracer dose of [U- $^{14}\text{C}$ ]lysine and the respired carbon dioxide was collected over a 20-h period. The level of  $^{14}\text{CO}_2$  produced was used as a direct measurement of the rate of oxidation of lysine in the fish. The level of oxidation observed was very low in those fish fed low dietary levels of lysine, somewhat higher for the intermediate dietary levels, and much higher for the higher levels of dietary lysine. The break-point of the dose-response curve indicated a dietary requirement of 20 g lysine  $\text{kg}^{-1}$  diet, which was in close agreement with a value of 19 g lysine  $\text{kg}^{-1}$  diet obtained from growth data. In a similar study involving tryptophan, Walton *et al.* (1984b) found that the requirement value based on oxidation data was lower, 2.0 vs. 2.5 g  $\text{kg}^{-1}$  diet, than the value based on weight gain data. These workers concluded that the oxidation technique is not suitable for use in the absence of growth data because of its lack of precision in determining requirement values from graphical plots.

Kim *et al.* (1992c) were unsuccessful in using phenylalanine oxidation rates to evaluate the phenylalanine requirement of rainbow trout. In this study, the fish were fed diets containing various levels of phenylalanine plus

L-[1- $^{14}\text{C}$ ]phenylalanine for 10–20 days. The expired  $^{14}\text{CO}_2$  increased gradually with increasing levels of phenylalanine in the diet without any apparent break-point. These workers concluded that this technique is probably not appropriate for determining amino acid requirements in fish.

### Quantitative Amino Acid Requirements of Finfish

The complete quantitative amino acid requirements have been established for only nine of the estimated 300 different fish species being cultured worldwide, namely the catla (*Catla catla*, an Indian major carp), channel catfish, chinook salmon, chum salmon (*Oncorhynchus keta*), coho salmon (*Oncorhynchus kisutch*), common carp, Japanese eel, milkfish (*Chanos chanos*) and Nile tilapia. A limited number of requirement values have also been reported for the African catfish (*Clarias gariepinus*), Arctic charr (*Salvelinus alpinus*), Asian sea bass (*Lates calcarifer*), Atlantic salmon (*Salmo salar*), blue tilapia (*Oreochromis aureus*), *Clarias* hybrid (*Clarias macrocephalus*  $\times$  *C. gariepinus*), European sea bass, gilthead sea bream (*Chrysophrys aurata*), hybrid striped bass, Japanese flounder (*Paralichthys olivaceus*), lake trout (*Salvelinus namaycush*), Mozambique tilapia (*Oreochromis mossambicus*), rainbow trout, red drum (*Sciaenops ocellatus*), red sea bream (*Pagrus major*), rohu (*Labeo rohita*, an Indian major carp), sliver perch (*Bidyanus bidyanus*), wels (*Silurus glanis*), yellow perch (*Perca flavescens*), and yellowtail (*Seriola quinqueradiata*).

### Arginine

The arginine requirement values for fish are summarized in Table 23.2. Salmon have the highest requirement of about 60 g  $\text{kg}^{-1}$  of dietary protein, whereas the other species require about 40–50 g  $\text{kg}^{-1}$  of dietary protein. The requirement value of about 40 g  $\text{kg}^{-1}$  of dietary protein for rainbow trout appears to be the most reasonable; however, values ranging from 33 to 59 g  $\text{kg}^{-1}$  have been reported.

**Table 23.2.** Arginine requirements ( $\text{g kg}^{-1}$  of protein) for various fish species.

Fish	Requirement	Type of diet	Reference
African catfish	45	Purified	Fagbenro <i>et al.</i> (1999)
Atlantic salmon	41	Semipurified	Lall <i>et al.</i> (1994)
	50–51	Semipurified	Berge <i>et al.</i> (1997)
Catla	48	Purified	Ravi and Devaraj (1991)
Channel catfish	43	Purified	Robinson <i>et al.</i> (1981)
Chinook salmon	60	Purified	Klein and Halver (1970)
Chum salmon	65	Purified	Akiyama and Arai (1993)
Coho salmon	58	Purified	Klein and Halver (1970)
	32	Purified	Arai and Ogata (1993)
	49–55	Semipurified	Luzzana <i>et al.</i> (1998)
Common carp	43	Purified	Nose (1979)
Gilthead bream	50	Semipurified	Luquet and Sabaut (1974)
Hybrid striped bass	44	Purified	Griffin <i>et al.</i> (1994a)
Japanese eel	45	Purified	Arai (in Nose, 1979)
Japanese flounder	41	Purified	Alam <i>et al.</i> (2002)
Milkfish	53	Purified	Borlongan (1991)
Mozambique tilapia	40	Practical	Jackson and Capper (1982)
Nile tilapia	42	Purified	Santiago and Lovell (1988)
Rainbow trout	33	Semipurified	Kaushik (1979)
	35	Semipurified	Rodehutsord <i>et al.</i> (1995)
	35–42	Purified	Chiu <i>et al.</i> (1988)
	38	Semipurified	Forster (1993)
	36–40	Semipurified	Walton <i>et al.</i> (1986)
	40	Purified	Kim <i>et al.</i> (1992b)
	41	Semipurified	Pack <i>et al.</i> (1995)
	47	Purified	Cho <i>et al.</i> (1992)
	54–59	Semipurified	Ketola (1983)
Rohu	29	Purified	Khan and Jafri (1993)
Silver perch	68	Purified	Ngamsnae <i>et al.</i> (1999)
Wels	34	Purified	Toth (1986)
Yellow perch	43	Purified	Twibell and Brown (1997)

Some confusion exists with respect to the effect of salinity on the arginine requirement of rainbow trout. Kaushik (1979) found that the requirement for arginine decreased as salinity increased. However, Zeitoun *et al.* (1973) found that the protein requirement of rainbow trout was higher at 20 ‰ than at 10 ‰.

A dietary lysine–arginine antagonism has been well documented in certain animals (see Chapters 7 and 14). Based on growth studies, this antagonism has not been demonstrated in channel catfish (Robinson *et al.*, 1981), blue tilapia (Liou, 1989), rainbow trout (Kim *et al.*, 1992b), hybrid striped bass (Griffin *et al.*, 1994a) or yellow perch (Twibell and Brown, 1997). Kaushik and Fauconneau (1984) have presented biochemical evidence which indicates some metabolic antagonism may exist

between lysine and arginine in rainbow trout. These workers found that increasing dietary lysine intake affected plasma arginine and urea levels and ammonia excretion. These changes were found to be due to a decrease in the relative rate of arginine degradation as the level of dietary lysine increased. Similar findings have also been reported for Atlantic salmon (Berge *et al.*, 1997, 1998).

### Histidine

The histidine requirements of fish are presented in Table 23.3. Excellent agreement has been found among the species studied with a range of 15–25  $\text{g kg}^{-1}$  of dietary protein for the requirement values. Wilson *et al.* (1980)

**Table 23.3.** Histidine requirements (g kg<sup>-1</sup> of protein) for various fish species.

Fish	Requirement	Type of diet	Reference
Catla	25	Purified	Ravi and Devaraj (1991)
Channel catfish	15	Purified	Wilson <i>et al.</i> (1980)
Chinook salmon	18	Purified	Klein and Halver (1970)
Chum salmon	16	Purified	Akiyama <i>et al.</i> (1985a)
	16	Purified	Akiyama and Arai (1993)
Coho salmon	18	purified	Klein and Halver (1970)
	9	Purified	Arai and Ogata (1993)
Common carp	21	Purified	Nose (1979)
Japanese eel	21	Purified	Arai (in Nose, 1979)
Milkfish	20	Purified	Borlongan and Coloso (1993)
Nile tilapia	17	Purified	Santiago and Lovell (1988)

were able to confirm the requirement value by the serum free histidine pattern in channel catfish. There was a significant increase in serum free histidine concentration up to the dietary requirement determined based on growth data and then the serum histidine remained constant at a higher dietary intake.

Muscle carnosine concentration has been shown to be altered by dietary histidine in chicks (Robbins *et al.*, 1977) and chinook salmon (Lukton, 1958). In both cases, the muscle carnosine was depleted when a histidine-deficient diet was fed. In the chick, as the dietary histidine was increased above the requirement, the muscle carnosine level returned to that of the control. Counter to the above, carnosine could not be detected in muscle tissue of the channel catfish regardless of the dietary level of histidine (Wilson *et al.*, 1980).

### Isoleucine

The isoleucine requirements of fish are presented in Table 23.4. The requirement appears to be about 22–30 g kg<sup>-1</sup> of dietary protein for those species studied except for the Japanese eel and milkfish, which have a much higher requirement value.

Wilson *et al.* (1980) determined the effects of dietary isoleucine on serum-free isoleucine, leucine, and valine in channel catfish. Even though the serum isoleucine increased somewhat with increasing isoleucine intake, these data did not confirm the requirement as determined from growth data. The serum-free leucine and valine concentrations appeared to parallel the serum-free isoleucine concentrations. A relatively high mortality rate was observed in the fish fed the isoleucine-deficient diet.

**Table 23.4.** Isoleucine requirements (g kg<sup>-1</sup> of protein) of various fish species.

Fish	Requirement	Type of diet	Reference
Catla	24	Purified	Ravi and Devaraj (1991)
Channel catfish	26	Purified	Wilson <i>et al.</i> (1980)
Chinook salmon	22	Purified	Chance <i>et al.</i> (1964)
Chum salmon	24	Purified	Akiyama and Arai (1993)
Coho salmon	12	Purified	Arai and Ogata (1993)
Common carp	25	Purified	Nose (1979)
Japanese eel	40	Purified	Arai (in Nose, 1979)
Lake trout	20–26 <sup>a</sup>	Practical	Hughes <i>et al.</i> (1983)
Milkfish	40	Purified	Borlongan and Coloso (1993)
Nile tilapia	31	Purified	Santiago and Lovell (1988)

<sup>a</sup>These values were recalculated based on the calculated nitrogen content of the test diets.

### Leucine

The leucine requirement values are presented in Table 23.5. The requirement values agree quite well, ranging from 33 to 39 g kg<sup>-1</sup> of dietary protein, except for the higher values of a little more than 50 g kg<sup>-1</sup> of dietary protein reported for the Japanese eel and milkfish.

Wilson *et al.* (1980) reported that the serum-free leucine level in channel catfish remained constant regardless of dietary leucine intake. There was, however, a marked effect of dietary leucine on the serum-free isoleucine and valine levels. There was about a sixfold increase in serum-free isoleucine and valine concentrations at the 7 g kg<sup>-1</sup> dietary leucine level, compared to the 6 g kg<sup>-1</sup> leucine level. These elevated levels of

isoleucine and valine did not return to the baseline levels until a dietary level of 12 g kg<sup>-1</sup> or above was fed. This observation was interpreted to indicate that leucine may facilitate the tissue uptake of branched-chain amino acids and/or their intracellular metabolism.

### Valine

The valine requirement values of fish are presented in Table 23.6. There is reasonable agreement between the values reported for the species studied, indicating that the requirement ranges from about 30 to 40 g kg<sup>-1</sup> of dietary protein. Studies showed that serum valine levels in the channel catfish responded to valine intake in a manner similar to that described for isoleucine (Wilson *et al.*, 1980).

**Table 23.5.** Leucine requirements (g kg<sup>-1</sup> of protein) of various fish species.

Fish	Requirement	Type of diet	Reference
Catla	37	Purified	Ravi and Devaraj (1991)
Channel catfish	35	Purified	Wilson <i>et al.</i> (1980)
Chinook salmon	39	Purified	Chance <i>et al.</i> (1964)
Chum salmon	38	Purified	Akiyama and Arai (1993)
<i>Clarias</i> hybrid	35	Purified	Unprasert (1994)
Coho salmon	34	Purified	Arai and Ogata (1993)
Common carp	33	Purified	Nose (1979)
Japanese eel	53	Purified	Arai (in Nose, 1979)
Lake trout	35–46 <sup>a</sup>	Practical	Hughes <i>et al.</i> (1983)
Milkfish	51	Purified	Borlongan and Coloso (1993)
Nile tilapia	28–36	Purified	Santiago and Lovell (1988)

<sup>a</sup>These values were recalculated based on the calculated nitrogen content of the test diets.

**Table 23.6.** Valine requirements (g kg<sup>-1</sup> of protein) of various fish species.

Fish	Requirement	Type of diet	Reference
Catla	36	Purified	Ravi and Devaraj (1991)
Channel catfish	30	Purified	Wilson <i>et al.</i> (1980)
Chinook salmon	32	Purified	Chance <i>et al.</i> (1964)
Chum salmon	30	Purified	Akiyama and Arai (1993)
Coho salmon	22	Purified	Arai and Ogata (1993)
Common carp	36	Purified	Nose (1979)
Japanese eel	40	Purified	Arai (in Nose, 1979)
Lake trout	26–33 <sup>a</sup>	Practical	Hughes <i>et al.</i> (1983)
Milkfish	36	Purified	Borlongan and Coloso (1993)
Nile tilapia	28	Purified	Santiago and Lovell (1988)

<sup>a</sup>These values were recalculated based on the calculated nitrogen content of the test diets.

### Isoleucine–leucine–valine interactions

There appear to be some differences in the apparent isoleucine–leucine–valine interactions in different fishes. Chance *et al.* (1964) found that the isoleucine requirement in chinook salmon was increased slightly with increasing levels of dietary leucine. This effect was not observed in either the common carp (Nose, 1979) or channel catfish (Robinson *et al.*, 1984). Nose (1979) did, however, observe reduced growth rates in carp fed high dietary isoleucine levels during his leucine requirement study. This reduced growth rate was not observed when the leucine requirement study was repeated at lower isoleucine levels. Robinson *et al.* (1984) concluded that a nutri-

tional interrelationship does exist among the branched-chain amino acids in the channel catfish but the interaction does not appear to be as severe as has been observed in certain other animals (see Chapters 7 and 14).

### Lysine

The lysine requirement values for fish are summarized in Table 23.7. In general, lysine appears to be the first-limiting amino acid in feedstuffs commonly used in formulating feeds for warmwater fish (Robinson *et al.*, 1980b) and perhaps other fish as well. Therefore, more requirement values have been reported for this amino acid. The requirement appears

**Table 23.7.** Lysine requirements (g kg<sup>-1</sup> of protein) of various fish species.

Fish	Requirement	Type of diet	Reference
African catfish	57	Purified	Fagbenro <i>et al.</i> (1998b)
Atlantic salmon	40	Semipurified	Anderson <i>et al.</i> (1993)
	32–36	Semipurified	Berge <i>et al.</i> (1998)
Blue tilapia	43	Purified	Liou (1989)
Catla	62	Purified	Ravi and Devaraj (1991)
Channel catfish	51	Purified	Wilson <i>et al.</i> (1977)
	50	Purified	Robinson <i>et al.</i> (1980b)
Chinook salmon	50	Semipurified	Halver <i>et al.</i> (1958)
Chum salmon	48	Purified	Akiyama <i>et al.</i> (1985a)
	50	Purified	Akiyama and Arai (1993)
<i>Clarias</i> hybrid	48	Purified	Unprasert (1994)
Coho salmon	38	Purified	Arai and Ogata (1993)
Common carp	57	Purified	Nose (1979)
European sea bass	48	Semipurified	Tibaldi and Lanari (1991)
Gilthead sea bream	50	Semipurified	Luquet and Sabaut (1974)
Hybrid striped bass	4.0	Purified	Griffin <i>et al.</i> (1992)
	4.0	Semipurified	Keembiyehetty and Gatlin (1992)
Japanese eel	53	Purified	Arai (in Nose, 1979)
Japanese flounder	46	Semipurified	Forster and Ogata (1998)
Milkfish	40	Semipurified	Borlongan and Benitez (1990)
Mozambique tilapia	41	Practical	Jackson and Capper (1982)
Nile tilapia	51	Purified	Santiago and Lovell (1988)
Rainbow trout	37	Purified	Kim <i>et al.</i> (1992b)
	42	Purified	Walton <i>et al.</i> (1984a)
	42	Semipurified	Pfeffer <i>et al.</i> (1992)
	61	Semipurified	Ketola (1983)
Red drum	44	Semipurified	Craig and Gatlin (1992)
	57	Semipurified	Brown <i>et al.</i> (1988)
Red sea bream	44	Semipurified	Forster and Ogata (1998)
Rohu	59	Purified	Khan and Jafri (1993)
	57	Purified	Murthy and Varghese (1997)
Yellowtail	41	Practical	Ruchimat <i>et al.</i> (1997b)

to range from 40 to 50 g kg<sup>-1</sup> of dietary protein for most fishes. The values of 57 for common carp and 57–59 and 62 g kg<sup>-1</sup> for rohu and catla, respectively, both Indian major carps, may indicate that carp have a higher lysine requirement than other fishes. The value of 61 g kg<sup>-1</sup> of dietary protein for rainbow trout appears to be out of line since two other investigators have reported much lower values.

Serum-free lysine levels were useful in confirming the lysine requirement in channel catfish originally determined at 240 g crude protein kg<sup>-1</sup> diet (Wilson *et al.*, 1977); however, serum-free lysine levels provided little indication of the lysine requirement when re-evaluated at a 300 g crude protein kg<sup>-1</sup> diet (Robinson *et al.*, 1980b). Walton *et al.* (1984a) observed good agreement between the lysine requirement values determined by either growth studies or amino acid oxidation studies in rainbow trout.

### Methionine

Methionine and cystine are classified as sulphur-containing amino acids. Adequate amounts of both methionine and cystine are needed for proper protein synthesis and other physiological functions of the fish. Cystine is considered dispensable because it can be synthesized by the fish from the indispensable amino acid methionine. When methionine is fed without cystine, a portion of the methionine is used for protein synthesis, and a portion is converted into the cystine monomer for incorporation into protein. If cystine is included in the diet, it reduces the amount of dietary methionine needed. Thus, to determine the total sulphur amino acid requirement (methionine plus cystine), the dietary requirement for methionine is determined either in the absence of cystine or with test diets containing very low levels of cystine.

The methionine or total sulphur amino acid requirement values are presented in Table 23.8. It appears that most fish have a requirement value of about 20–30 g kg<sup>-1</sup> of dietary protein, whereas catla, chinook salmon and gilthead sea bream appear to require higher levels of methionine.

Rainbow trout appear to be unique in that methionine deficiency results in bilateral cataracts (Poston *et al.*, 1977). These workers observed cataracts in rainbow trout fed diets containing isolated soybean protein. The cataracts were prevented by supplementing the diet with methionine. Cataracts have also been observed in methionine-deficient rainbow trout by Walton *et al.* (1982), Rumsey *et al.* (1983) and Cowey *et al.* (1992). This deficiency sign has also been reported in Arctic charr and actually used as the basis for establishing the methionine requirement for this species (Simmons *et al.*, 1999). Cataracts were also observed in hybrid striped bass fed a diet containing their total sulphur amino acid requirement in a methionine to cystine ratio of 40:60. These fish developed bilateral cataracts within 3 weeks and experienced mass mortality after 4 weeks (Keembiyehetty and Gatlin, 1993).

As indicated above, dietary cystine can reduce the amount of dietary methionine required for maximum growth. The cystine replacement value for methionine on a sulphur basis has been determined to be about 60% for channel catfish (Harding *et al.*, 1977), 44% for blue tilapia (Liou, 1989), 42% for rainbow trout (Kim *et al.*, 1992a) and 40% for red drum (Moon and Gatlin, 1991) and hybrid striped bass (Griffin *et al.*, 1994b).

Robinson *et al.* (1978) evaluated the utilization of several sulphur compounds for their potential replacement value for methionine in channel catfish. Growth and feed efficiency data indicated that DL-methionine was utilized as effectively as L-methionine. Methionine hydroxy analogue was only about 26% as effective as L-methionine in promoting growth. No significant growth response was observed when taurine or inorganic sulphate was added to the basal diet. Page *et al.* (1978) were also unable to detect the utilization of taurine and inorganic sulphate as sulphur sources in rainbow trout. D-Methionine has been shown to replace L-methionine on an equal basis in rainbow trout (Kim *et al.*, 1992a). L-Methionine, DL-methionine and N-acetyl-DL-methionine were equally utilized by hybrid striped bass, whereas glutathione and



**Table 23.8.** Methionine or total sulphur amino acid requirements (g kg<sup>-1</sup> of protein) of various fish species.

Fish	Requirement	Type of diet	Reference
African catfish	32	Purified	Fagbenro <i>et al.</i> (1998a)
Atlantic salmon	24	Purified	Rollin <i>et al.</i> (1994)
Arctic charr	27	Practical	Simmons <i>et al.</i> (1999)
Asian sea bass	29	Semipurified	Coloso <i>et al.</i> (1999)
Blue tilapia	28	Purified	Liou (1989)
Catla	36	Purified	Ravi and Devaraj (1991)
Channel catfish	23	Purified	Harding <i>et al.</i> (1977)
Chinook salmon	40	Purified	Halver <i>et al.</i> (1959)
Chum salmon	30	Purified	Akiyama and Arai (1993)
<i>Clarias</i> hybrid	24	Purified	Unprasert (1994)
Coho salmon	27	Purified	Arai and Ogata (1993)
Common carp	31	Purified	Nose (1979)
	21	Practical	Schwarz <i>et al.</i> (1998)
European sea bass	20	Practical	Thebault <i>et al.</i> (1985)
Gilthead sea bream	40	Semipurified	Luquet and Sabaut (1974)
Hybrid striped bass	29	Semipurified	Keembiyehetty and Gatlin (1993)
	21	Purified	Griffin <i>et al.</i> (1994b)
Japanese eel	32	Purified	Arai (in Nose, 1979)
Japanese flounder	30	Purified	Alam <i>et al.</i> (2000)
Milkfish	25	Semipurified	Borlongan and Coloso (1993)
Mozambique tilapia	32	Practical	Jackson and Capper (1982)
Nile tilapia	32	Purified	Santiago and Lovell (1988)
Rainbow trout	22	Purified	Walton <i>et al.</i> (1982)
	23	Purified	Kim <i>et al.</i> (1992a)
	19–24	Semipurified	Cowey <i>et al.</i> (1992)
	30	Purified	Rumsey <i>et al.</i> (1983)
Red drum	30	Semipurified	Moon and Gatlin (1991)
Rohu	26	Purified	Khan and Jafri (1993)
Yellowtail	26	Practical	Ruchimat <i>et al.</i> (1997a)

DL-methionine hydroxy analogue were only 75% as effective as L-methionine, and taurine was totally ineffective (Keembiyehetty and Gatlin, 1995).

### Phenylalanine

A relationship similar to that presented for methionine and cystine exists for phenylalanine and tyrosine, two important aromatic amino acids. Tyrosine is considered dispensable because it can be synthesized by the fish from the indispensable amino acid phenylalanine. If tyrosine is included in the diet, it reduces the amount of phenylalanine needed in the diet. Thus, fish have a total aromatic amino acid requirement.

The phenylalanine or total aromatic amino acid requirement values for fish are presented in Table 23.9. Most requirement values fall within the range of 50–60 g kg<sup>-1</sup> of dietary protein except for the lower value for rainbow trout and the higher value for common carp.

Since the fish has a metabolic need for both phenylalanine and tyrosine, and only a certain portion of the phenylalanine can be converted into tyrosine and still meet the animal's need for phenylalanine, it is important to determine how much of the total aromatic amino acid requirement can be provided by dietary tyrosine. Growth studies indicate that tyrosine can replace or spare about 60% of the phenylalanine requirement in common carp (Nose, 1979), 50% in channel catfish (Robinson *et al.*, 1980a), 48% in rainbow

**Table 23.9.** Phenylalanine or total aromatic amino acid requirements (g kg<sup>-1</sup> of protein) for various fish species.

Fish	Requirement	Type of diet	Reference
Catla	62	Purified	Ravi and Devaraj (1991)
Channel catfish	50	Purified	Robinson <i>et al.</i> (1980a)
Chinook salmon	51	Purified	Chance <i>et al.</i> (1964)
Chum salmon	63	Purified	Akiyama and Arai (1993)
Coho salmon	45	Purified	Arai and Ogata (1993)
Common carp	65	Purified	Nose (1979)
Japanese eel	58	Purified	Arai (in Nose, 1979)
Milkfish	52	Purified	Borlongan (1992)
Nile tilapia	55	Purified	Santiago and Lovell (1988)
Rainbow trout	43	Purified	Kim (1993)
Silver perch	57	Purified	Ngamsnae <i>et al.</i> (1999)

trout (Kim, 1993) and 46% for milkfish (Borlongan and Coloso, 1993).

### Threonine

The threonine requirement values for fish are summarized in Table 23.10. The reported values range from 20 to 50 g kg<sup>-1</sup> of dietary protein. It is difficult to offer any explanation for the lack of agreement in these requirement values. Additional research is needed to determine if this wide range of values represents true differences in the threonine requirements or just a difference in the techniques used to determine the requirement values.

DeLong *et al.* (1962) found the threonine requirement of chinook salmon to be the same when determined at rearing temperatures of 8 and 15°C. These findings were not expected since these workers had previously reported the protein requirement of chinook salmon to increase from 40 g kg<sup>-1</sup> diet at 8°C to 55 g kg<sup>-1</sup> diet at 15°C (DeLong *et al.*, 1958).

### Tryptophan

The tryptophan requirement values for fish are presented in Table 23.11. The requirement appears to be about 5–10 g kg<sup>-1</sup> of dietary protein for the various species studied.

**Table 23.10.** Threonine requirements (g kg<sup>-1</sup> of protein) for various fish species.

Fish	Requirement	Type of diet	Reference
Catla	50	Purified	Ravi and Devaraj (1991)
Channel catfish	20	Purified	Wilson <i>et al.</i> (1978)
Chinook salmon	22	Purified	DeLong <i>et al.</i> (1962)
Chum salmon	30	Purified	Akiyama <i>et al.</i> (1985a)
Coho salmon	20	Purified	Arai and Ogata (1993)
Common carp	39	Purified	Nose (1979)
European sea bass	26–30	Semipurified	Tibaldi and Tulli (1999)
Hybrid striped bass	26	Semipurified	Keembiyehetty and Gatlin (1997)
Japanese eel	40	Purified	Arai (in Nose, 1979)
Milkfish	45	Purified	Borlongan (1991)
Nile tilapia	38	Purified	Santiago and Lovell (1988)
Rainbow trout	32–37	Semipurified	Rodehutsord <i>et al.</i> (1995)
Red drum	23	Semipurified	Boren and Gatlin (1995)
Rohu	43		Murthy and Varghese (1996)
Striped bass	25	Practical	Small and Soares (1999)

**Table 23.11.** Tryptophan requirements (g kg<sup>-1</sup> of protein) for various fish species.

Fish	Requirement	Type of diet	Reference
African catfish	11	Purified	Fagbenro and Nwanna (1999)
Catla	10	Purified	Ravi and Devaraj (1991)
Channel catfish	5	Purified	Wilson <i>et al.</i> (1978)
Chinook salmon	5	Purified	Halver (1965)
Chum salmon	7	Purified	Akiyama <i>et al.</i> (1985b)
Coho salmon	5	Purified	Halver (1965)
	5	Purified	Arai and Ogata (1993)
Common carp	8	Purified	Nose (1979)
Gilthead sea bream	6	Semipurified	Luquet and Sabaut (1974)
Japanese eel	11	Purified	Arai (in Nose, 1979)
Milkfish	6	Semipurified	Coloso <i>et al.</i> (1992)
Nile tilapia	10	Purified	Santiago and Lovell (1988)
Rainbow trout	5	Semipurified	Walton <i>et al.</i> (1984b)
	6	Purified	Kim <i>et al.</i> (1987)
	14	Purified	Poston and Rumsey (1983)
Rohu	6	Purified	Khan and Jafri (1993)
Sockeye salmon	5	Purified	Halver (1965)

The high value of 14 g kg<sup>-1</sup> of dietary protein for rainbow trout may have been overestimated because no dietary levels between 2.5 and 5.0 g kg<sup>-1</sup> of diet were fed (Poston and Rumsey, 1983).

Tryptophan deficiency results in several deficiency signs in salmonids that have not been observed in other fish species. Halver and Shanks (1960) observed scoliosis and lordosis in sockeye salmon but not in chinook salmon fed tryptophan-deficient diets. Scoliosis and lordosis have also been observed in tryptophan-deficient rainbow trout (Shanks *et al.*, 1962; Kloppel and Post, 1975; Poston and Rumsey, 1983; Walton *et al.*, 1984b) and chum salmon (Akiyama *et al.*, 1985b). These deformities were found to be reversible in rainbow trout when the fish were fed adequate dietary tryptophan (Shanks *et al.*, 1962; Kloppel and Post, 1975) and appear to be related to a depletion of 5-hydroxytryptophan in the body or brain (Akiyama *et al.*, 1986). Other tryptophan deficiency signs in rainbow trout include renal calcinosis (Kloppel and Post, 1975), caudal fin erosion, cataracts and short gill opercula (Poston and Rumsey, 1983), and increased liver and kidney levels of calcium, magnesium, sodium and potassium (Walton *et al.*, 1984b).

### Quantitative Amino Acid Requirements of Penaeid Shrimp

Successful studies have recently been completed on determining the amino acid requirements of penaeid shrimp (Table 23.12). Previous attempts to quantify the requirements had resulted in only limited success (Deshimaru and Kuroki, 1974; Akiyama, 1986). This was due primarily to the lack of a water stable diet that would resist leaching while being slowly consumed by the shrimp. Chen *et al.* (1992) were able to determine the arginine requirement by using a microencapsulated diet. Fox *et al.* (1995) covalently bound increasing levels of supplemental lysine to wheat gluten in order to determine the lysine requirement in *Penaeus vannamei*. Millamena *et al.* (1996a,b, 1997, 1998, 1999) were able to utilize amino acid test diets containing casein, gelatin and crystalline amino acids. The crystalline amino acid mixture was initially coated with gelatinized carboxymethyl cellulose and then  $\kappa$ -carrageenan was gelatinized to form a homogeneous gel and added to the completed diet mixture. Feeding of these diets resulted in the typical dose-response curve for each of the indispensable amino acids; however, in most cases, feeding levels above the estimated requirement level resulted in a marked reduction in growth.

**Table 23.12.** Amino acid requirements (g kg<sup>-1</sup> of protein) of penaeid shrimp based on growth studies.

Amino acid	Requirement	Species	Reference
Arginine	53	<i>Penaeus monodon</i>	Millamena <i>et al.</i> (1998)
	55	<i>Penaeus monodon</i>	Chen <i>et al.</i> (1992)
Histidine	22	<i>Penaeus monodon</i>	Millamena <i>et al.</i> (1999)
Isoleucine	27	<i>Penaeus monodon</i>	Millamena <i>et al.</i> (1999)
Leucine	43	<i>Penaeus monodon</i>	Millamena <i>et al.</i> (1999)
Lysine	52	<i>Penaeus monodon</i>	Millamena <i>et al.</i> (1998)
	31	<i>Penaeus vannamei</i>	Akiyama (1986)
	45–52	<i>Penaeus vannamei</i>	Fox <i>et al.</i> (1995)
Methionine	35	<i>Penaeus monodon</i>	Millamena <i>et al.</i> (1996a)
Phenylalanine plus tyrosine	77	<i>Penaeus monodon</i>	Millamena <i>et al.</i> (1999)
Threonine	35	<i>Penaeus monodon</i>	Millamena <i>et al.</i> (1997)
Tryptophan	5	<i>Penaeus monodon</i>	Millamena <i>et al.</i> (1999)
Valine	34	<i>Penaeus monodon</i>	Millamena <i>et al.</i> (1996b)

### Other Methods of Estimating Amino Acid Needs

Various investigators have observed improved growth and feed efficiency when experimental diets for salmonids were supplemented with indispensable amino acids to simulate levels found in isolated fish protein or the respective eggs and whole body tissue of the species being studied (Rumsey and Ketola, 1975; Arai, 1981; Ketola, 1982; Ogata *et al.*, 1983). The indispensable amino acid requirements of certain fish have also been shown to correlate well with the indispensable amino acid pattern of the whole-body tissue of that fish (Cowey and Tacon, 1983; Wilson and Poe, 1985). Therefore, it seems reasonable to suggest that these types of information may be useful in designing test diets for fish when their amino acid requirements have not been established.

The amino acid composition of whole-body tissue of certain fishes is presented in Table 23.13. The amino acid compositions of these five species of fish are surprisingly similar. Similar conclusions have been found by others (Mambrini and Kaushik, 1995), who used factorial correspondence analysis to compare the indispensable amino acid composition data in the literature. They also found that whereas proteins of different tissues may have different indispensable amino acid patterns, the indispensable amino acid profile of a given tissue seemed to be conserved among species and was unaffected by such factors as temperature,

feeding rate or fish size. Kaushik (1998) has also reported the whole body amino acid composition of two size classes each of European sea bass, gilthead sea bream and turbot (*Psetta maxima*) and found no significant difference in the amino acid composition regardless of size or species. Kim and Lall (2000) have also reported the amino acid composition of the Atlantic halibut (*Hippoglossus hippoglossus*), yellowtail flounder (*Pleuronectes ferruginea*) and Japanese flounder and found the composition to be very similar to that of rainbow trout and Atlantic salmon.

The amino acid composition of eggs of various fishes has been summarized by Ketola (1982). In general, the amino acid composition appears to vary more than the whole body composition data presented in Table 23.13. Ketola (1982) also points out that although the amino acid content of the fish eggs appears to differ from the reported dietary requirements of the fish, the composition of the eggs has provided useful data in formulating test diets for Atlantic salmon and rainbow trout.

On the basis of observations in other animals, Cowey and Tacon (1983) suggested that the indispensable amino acid requirements of a fish should be related, or even governed, by the pattern of amino acids present in muscle tissue. They showed a high correlation between the requirement pattern found by feeding experiments for the ten indispensable amino acids as determined for carp by Nose (1979) using amino acid test diets and the

**Table 23.13.** Amino acid composition (g 100 g<sup>-1</sup> amino acids) of whole body tissue of certain fishes.

Amino acid	Rainbow trout <sup>a</sup>	Atlantic salmon <sup>a</sup>	Coho salmon <sup>b</sup>	Cherry salmon <sup>c</sup>	Channel catfish <sup>d</sup>
Ala	6.57	6.52	6.08	6.35	6.31
Arg	6.41	6.61	5.99	6.23	6.67
Asp	9.94	9.92	9.96	9.93	9.74
Cys	0.80	0.95	1.23	1.34	0.86
Glu	14.22	14.31	15.25	15.39	14.39
Gly	7.76	7.41	7.31	7.62	8.14
His	2.96	3.02	2.99	2.39	2.17
Ile	4.34	4.41	3.70	3.96	4.29
Leu	7.59	7.72	7.49	7.54	7.40
Lys	8.49	9.28	8.64	8.81	8.51
Met	2.88	1.83	3.53	3.14	2.92
Phe	4.38	4.36	4.14	4.63	4.14
Pro	4.89	4.64	4.76	4.33	6.02
Ser	4.66	4.61	4.67	4.48	4.89
Thr	4.76	4.95	5.11	4.63	4.41
Trp	0.93	0.93	1.40	0.83	0.78
Tyr	3.38	3.50	3.44	3.58	3.28
Val	5.09	5.09	4.32	4.85	5.15

<sup>a</sup>From Wilson and Cowey (1985).

<sup>b</sup>From Arai (1981).

<sup>c</sup>From Ogata *et al.* (1983).

<sup>d</sup>From Wilson and Poe (1985).

pattern of the same amino acids in the whole body tissue of growing carp.

Wilson and Poe (1985) have tested this hypothesis in channel catfish. These workers obtained a regression coefficient of 0.96 when the indispensable amino acid requirement pattern for the channel catfish was regressed against the whole body indispensable amino acid pattern found in a 30 g channel catfish. A lower regression coefficient of 0.68 was found when the requirement pattern was regressed against the channel catfish egg amino acid pattern. Nose and Murai (1990) also compared regression coefficients of the indispensable amino acid patterns for requirement values and whole body and egg amino acid composition data for common carp and coho salmon. The agreement was much better for these species than indicated above for channel catfish. Thus, these workers concluded that the amino acid patterns of either whole body or eggs could be used in formulating fish feeds until reliable requirement data are available for that species.

### Protein Accretion

Ogino (1980) estimated the indispensable amino acid requirements of common carp and rainbow trout based on amounts of each amino acid retained in the carcass of the animal fed a high quality protein diet. This method has been used to estimate the amino acid requirements of the mossambique tilapia (Jauncey *et al.*, 1983), Siberian sturgeon (*Acipenser baeri*) (Kaushik *et al.*, 1991), white sturgeon (*Acipenser transmontanus*) (Ng and Hung, 1995) and striped bass (*Morone saxatilis*) (Small and Soares, 1998). Even though it is generally accepted that this technique does provide an ideal pattern of indispensable amino acids for protein accretion, it is questionable whether the net amino acid retention values can actually be used to establish amino acid requirements for maximum growth. In general, requirement values estimated by this method are usually lower than those determined by growth studies. This may be due

to the fact that normally only about 30–40% of the dietary nitrogen is retained by growing fish.

### A/E ratios and the ideal protein concept

Arai (1981) used A/E ratios ((essential amino acid content/total essential amino acid content including cystine and tyrosine)  $\times$  1000) of whole body coho salmon fry to formulate test diets for this fish. Fish fed casein diets supplemented with amino acids to simulate the A/E ratios of whole body tissue showed much improved growth and feed efficiency. Ogata *et al.* (1983) used A/E ratios based on amino acid composition data from cherry salmon (*Oncorhynchus masou*) to design test diets for cherry salmon and amago salmon (*Oncorhynchus rhodurus*) fry. A casein diet supplemented with amino acids to simulate the A/E ratios of cherry salmon resulted in better growth in both species than diets containing casein alone, casein plus amino acids to simulate the A/E ratio of eyed cherry salmon eggs, or white fishmeal.

A/E ratios have been used as a means of estimating the requirements of all indispensable amino acids when only one is known by relating the A/E ratio of each indispensable amino acid to that of the A/E ratio of the known amino acid times the requirement value for the unknown amino acid (Moon and Gatlin, 1991). This technique has also been

used by Forster and Ogata (1998) to estimate the amino acid requirements of Japanese flounder and red sea bream. This method has also been used successfully in silver perch (Ngamsnae *et al.*, 1999).

The relationships between whole body amino acid patterns and amino acid requirement patterns discussed above are very similar to the ideal protein concept that has been advocated for use in expressing the amino acid requirements of pigs (Agricultural Research Council, 1981). The ideal protein concept is based on the idea that there should be a direct correlation between the whole body amino acid pattern of the animal and the dietary amino acid requirements of the animal. In addition, since lysine is normally the first-limiting amino acid in most feedstuffs, the requirements for the other indispensable amino acids are expressed relative to the lysine requirement. Thus, if one knows the dietary lysine requirement and the whole body amino acid composition of an animal, then one should be able to estimate the dietary requirement for the remaining indispensable amino acids relative to the lysine requirement. A comparison of the amino acid requirement values as determined by conventional means in our laboratory and as estimated based on the ideal protein concept for channel catfish is presented in Table 23.14. These data show excellent agreement. This procedure is essentially the same as the one discussed above for the use of A/E ratios.

**Table 23.14.** A comparison of amino acid requirement values (g kg<sup>-1</sup> of protein) as determined by conventional means and as estimated based on the ideal protein concept for channel catfish.

Amino acid	Amino acid ratio	Determined requirement	Estimated requirement
Lysine	100	51	–
Arginine	78	43	40
Histidine	25	15	13
Isoleucine	50	26	26
Leucine	87	44	44
Met + Cys	44	23	22
Phe + Tyr	87	50	44
Threonine	52	20	27
Tryptophan	9	5	5
Valine	61	30	31

The ideal protein concept has been used as a means of estimating the amino acid requirements of a *Clarias* hybrid from Thailand (Unprasert, 1994). Requirement values were determined for lysine, methionine, threonine, tryptophan and leucine by growth studies. Requirement values for the remaining indispensable amino acids were then estimated relative to each of the amino acids determined by growth studies. Some variation was observed in these results which were

attributed to difficulty in obtaining competent amino acid analysis of the whole body sample of the test fish.

To use this procedure, all that is needed to formulate diets based on the amino acid needs of a certain fish species is to determine the whole body amino acid composition and the lysine requirement of that species. This new procedure should be much less time consuming and less costly than determining amino acid requirements of the fish by conventional means.

## References

- Agricultural Research Council (1981) Protein and amino acid requirements. In: *The Nutrient Requirements of Pigs*. Commonwealth Agricultural Bureaux, Farnham Royal, Slough, pp. 67–124.
- Akiyama, D.M. (1986) The development of a purified diet and nutritional requirement of lysine in penaeid shrimp. PhD dissertation, Texas A&M University, College Station, Texas.
- Akiyama, T. and Arai, S. (1993) Amino acid requirements of chum salmon fry and supplementation of amino acid to diet. In: Collie, M.R. and McVey, J.P. (eds) *Proceedings of the Twentieth U.S.–Japan Symposium on Aquaculture Nutrition*, Newport, Oregon, October 1991, pp. 35–48.
- Akiyama, T., Arai, S. and Murai, T. (1985a) Threonine, histidine and lysine requirements of chum salmon fry. *Bulletin of the Japanese Society of Scientific Fisheries* 51, 635–639.
- Akiyama, T., Arai, S., Murai, T. and Nose, T. (1985b) Tryptophan requirement of chum salmon fry. *Bulletin of the Japanese Society of Scientific Fisheries* 51, 1005–1008.
- Akiyama, T., Murai, T. and Mori, K. (1986) Role of tryptophan metabolites in inhibition of spinal deformity of chum salmon fry caused by tryptophan deficiency. *Bulletin of the Japanese Society of Scientific Fisheries* 52, 1255–1259.
- Alam, M.S., Teshima, S.I., Ishikawa, M. and Koshio, S. (2000) Methionine requirement of juvenile Japanese flounder *Paralichthys olivaceus*. *Journal of the World Aquaculture Society* 31, 618–626.
- Alam, M.S., Teshima, S.I., Koshio, S. and Ishikawa, M. (2002) Arginine requirement of juvenile Japanese flounder *Paralichthys olivaceus* estimated by growth and biochemical parameters. *Aquaculture* 205, 127–140.
- Anderson, J.S., Lall, S.P., Anderson, D.M. and McNiven, M.A. (1993) Quantitative dietary lysine requirement of Atlantic salmon (*Salmo salar*) fingerlings. *Canadian Journal of Fisheries and Aquatic Sciences* 50, 316–322.
- Arai, S. (1981) A purified test diet for coho salmon, *Oncorhynchus kisutch*, fry. *Bulletin of the Japanese Society of Scientific Fisheries* 47, 547–550.
- Arai, S. and Ogata, H. (1993) Quantitative amino acid requirements of fingerling coho salmon (*Oncorhynchus kisutch*). In: Collie, M.R. and McVey, J.P. (eds) *Proceedings of the Twentieth U.S.–Japan Symposium on Aquaculture Nutrition*, Newport, Oregon, October 1991, pp. 19–28.
- Berge, G.E., Lied, E. and Sveier, H. (1997) Nutrition of Atlantic salmon (*Salmo salar*): the requirement and metabolism of arginine. *Comparative Biochemistry and Physiology* 117A, 501–509.
- Berge, G.E., Sveier, H. and Lied, E. (1998) Nutrition of Atlantic salmon (*Salmo salar*): the requirement and metabolic effect of lysine. *Comparative Biochemistry and Physiology* 120A, 477–485.
- Boren, R.S. and Gatlin, D.M. III (1995) Dietary threonine requirement of juvenile red drum *Sciaenops ocellatus*. *Journal of the World Aquaculture Society* 26, 279–283.
- Borlongan, I.G. (1991) Arginine and threonine requirements of milkfish (*Chanos chanos* Forsskal) juveniles. *Aquaculture* 93, 313–322.
- Borlongan, I.G. (1992) Dietary requirement of milkfish (*Chanos chanos* Forsskal) juveniles for total aromatic amino acids. *Aquaculture* 102, 309–317.
- Borlongan, I.G. and Benitez, L.V. (1990) Quantitative lysine requirement of milkfish (*Chanos chanos*) juveniles. *Aquaculture* 87, 341–347.

- Borlongan, I.G. and Coloso, R.M. (1993) Requirements of juvenile milkfish (*Chanos chanos* Forsskal) for essential amino acids. *Journal of Nutrition* 123, 125–132.
- Bowen, S.H. (1987) Dietary protein requirements of fishes – a reassessment. *Canadian Journal of Fisheries and Aquatic Sciences* 44, 1995–2001.
- Brown, P.B., Davis, D.A. and Robinson, E.H. (1988) An estimate of the dietary lysine requirement of juvenile red drum *Sciaenops ocellatus*. *Journal of the World Aquaculture Society* 19, 109–112.
- Chance, R.E., Mertz, E.T. and Halver, J.E. (1964) Nutrition of salmonoid fishes. XII. Isoleucine, leucine, valine and phenylalanine requirements of chinook salmon and interrelations between isoleucine and leucine for growth. *Journal of Nutrition* 83, 177–185.
- Chen, H.Y., Len, Y.T. and Roelants, I. (1992) Quantification of arginine requirements of juvenile marine shrimp *Penaeus monodon* using microencapsulated arginine. *Marine Biology* 114, 229–233.
- Chiu, Y.N., Austic, R.E. and Rumsey, G.L. (1988) Effect of feeding level and dietary electrolytes on the arginine requirement of rainbow trout (*Salmo gairdneri*). *Aquaculture* 69, 79–91.
- Cho, C.Y., Kaushik, S. and Woodward, B. (1992) Dietary arginine requirement of young rainbow trout (*Salmo gairdneri* R.). *Comparative Biochemistry and Physiology* 102A, 211–216.
- Coloso, R.M., Tiro, L.B. and Benitez, L.V. (1992) Requirement for tryptophan by milkfish (*Chanos chanos* Forsskal) juveniles. *Fish Physiology and Biochemistry* 10, 35–41.
- Coloso, R.M., Murillo-Gurra, D.P., Borlongan, I.G. and Catacutan, M.R. (1999) Sulphur amino acid requirement of juvenile Asian sea bass *Lates calcarifer*. *Journal of Applied Ichthyology* 15, 54–58.
- Cowey, C.B. and Luquet, P. (1983) Physiological basis of protein requirements of fishes. Critical analysis of allowances. In: Prion, R., Arnal, M. and Bonin, D. (eds) *Protein Metabolism and Nutrition* 1. INRA, Paris, pp. 364–384.
- Cowey, C.B. and Tacon, A.G.J. (1983) Fish nutrition – relevance to invertebrates. In: Pruder, G.D., Langdon, C.J. and Conklin, D.E. (eds) *Proceedings of the Second International Conference on Aquaculture Nutrition: Biochemical and Physiological Approaches to Shellfish Nutrition*. Louisiana State University, Division of Continuing Education, Baton Rouge, pp. 13–30.
- Cowey, C.B., Cho, C.Y., Sivak, J.G., Weerheim, J.A. and Stuart, D.D. (1992) Methionine intake in rainbow trout (*Oncorhynchus mykiss*), relationship to cataract formation and the metabolism of methionine. *Journal of Nutrition* 122, 1154–1163.
- Craig, S.R. and Gatlin, D.M. III (1992) Dietary lysine requirement of juvenile red drum *Sciaenops ocellatus*. *Journal of the World Aquaculture Society* 23, 133–137.
- DeLong, D.C., Halver, J.E. and Mertz, E.T. (1958) Nutrition of salmonoid fishes. VI. Protein requirements of chinook salmon at two water temperatures. *Journal of Nutrition* 65, 589–599.
- DeLong, D.C., Halver, J.E. and Mertz, E.T. (1962) Nutrition of salmonoid fishes. X. Quantitative threonine requirements of chinook salmon at two water temperatures. *Journal of Nutrition* 76, 174–178.
- Deshimaru, O. and Kuroki, K. (1974) Studies on a purified diet for prawn. I. Basal composition of diet. *Bulletin of the Japanese Society of Scientific Fisheries* 40, 413–419.
- Fagbenro, O.A. and Nwanna, L.C. (1999) Dietary tryptophan requirement of the African catfish, *Clarias gariepinus*. *Journal of Applied Aquaculture* 9, 65–72.
- Fagbenro, O.A., Balogun, A.M. and Fasakin, E.A. (1998a) Dietary methionine requirement of the African catfish, *Clarias gariepinus*. *Journal of Applied Aquaculture* 8, 47–54.
- Fagbenro, O.A., Balogun, A.M., Fasakin, E.A. and Bello-Olusoji, O.A. (1998b) Dietary lysine requirement of the African catfish, *Clarias gariepinus*. *Journal of Applied Aquaculture* 8, 71–77.
- Fagbenro, O.A., Nwanna, L.C. and Adebago, O.T. (1999) Dietary arginine requirement of the African catfish, *Clarias gariepinus*. *Journal of Applied Aquaculture* 9, 59–64.
- Forster, I.P. (1993) Arginine requirement of juvenile rainbow trout (*Oncorhynchus mykiss*). PhD dissertation, University of Washington, Seattle, Washington.
- Forster, I. and Ogata, H.Y. (1998) Lysine requirement of juvenile Japanese flounder *Paralichthys olivaceus* and juvenile red sea bream *Pagrus major*. *Aquaculture* 161, 131–142.
- Fox, J.M., Lawrence, A.L. and Li-Chan, E. (1995) Dietary requirement for lysine by juvenile *Penaeus vannamei* using intact and free amino acid sources. *Aquaculture* 131, 279–290.
- Griffin, M.E., Brown, P.B. and Brant, A.L. (1992) The dietary lysine requirement of juvenile hybrid striped bass. *Journal of Nutrition* 122, 1332–1337.
- Griffin, M.E., Wilson, K.A. and Brown, P.B. (1994a) Dietary arginine requirement of juvenile hybrid striped bass. *Journal of Nutrition* 124, 888–893.



- Griffin, M.E., White, M.R. and Brown, P.B. (1994b) Total sulphur amino acid requirement and cysteine replacement value for juvenile striped bass (*Morone saxatilis* × *M. chrysops*). *Comparative Biochemistry and Physiology* 108A, 423–429.
- Halver, J.E. (1957) Nutrition of salmonoid fishes. IV. An amino acid test diet for chinook salmon. *Journal of Nutrition* 62, 245–254.
- Halver, J.E. (1965) Tryptophan requirement of chinook, sockeye and silver salmon. *Federation Proceedings* 24, 229 (abstr).
- Halver, J.E. and Shanks, W.E. (1960) Nutrition of salmonoid fishes. VIII. Indispensable amino acids for sockeye salmon. *Journal of Nutrition* 72, 340–346.
- Halver, J.E., DeLong, D.C. and Mertz, E.T. (1957) Nutrition of salmonoid fishes. V. Classification of essential amino acids for chinook salmon. *Journal of Nutrition* 63, 95–105.
- Halver, J.E., DeLong, D.C. and Mertz, E.T. (1958) Threonine and lysine requirements of chinook salmon. *Federation Proceedings* 171, 1873 (abstr).
- Halver, J.E., DeLong, D.C. and Mertz, E.T. (1959) Methionine and cystine requirements of chinook salmon. *Federation Proceedings* 18, 2076 (abstr).
- Harding, D.E., Allen, O.W. Jr and Wilson, R.P. (1977) Sulfur amino acid requirement of channel catfish: L-methionine and L-cystine. *Journal of Nutrition* 107, 2031–2035.
- Hughes, S.G., Rumsey, G.L. and Nesheim, M.C. (1983) Dietary requirements for essential branched-chain amino acids by lake trout. *Transactions of the American Fisheries Society* 112, 812–817.
- Jackson, A.J. and Capper, B.S. (1982) Investigations into the requirements of the tilapia *Sarotherodon mossambicus* for dietary methionine, lysine and arginine in semi-synthetic diets. *Aquaculture* 29, 289–297.
- Jauncey, K., Tacon, A.G.J. and Jackson, A.J. (1983) The quantitative essential amino acid requirements of *Oreochromis (Sarotherodon) mossambicus*. In: Fishelson, L. and Yaron, Z. (eds) *Proceedings, First International Symposium on Tilapia in Aquaculture*. University of Tel Aviv, Nazareth, Israel, pp. 328–337.
- Kaushik, S. (1979) Application of a biochemical method for the estimation of amino acid needs in fish: quantitative arginine requirements of rainbow trout in different salinities. In: Halver, J.E. and Tiews, K. (eds) *Finfish Nutrition and Fishfeed Technology*, Vol. 1. Heenemann, Berlin, pp. 197–207.
- Kaushik, S.J. (1998) Whole body amino acid composition of European seabass (*Dicentrarchus labrax*), gilt-head seabream (*Sparus aurata*) and turbot (*Psetta maxima*) with an estimation of their IAA requirement profiles. *Aquatic Living Resources* 11, 355–358.
- Kaushik, S.J. and Fauconneau, B. (1984) Effects of lysine administration on plasma arginine and on some nitrogenous catabolites in rainbow trout. *Comparative Biochemistry and Physiology* 79A, 459–462.
- Kaushik, S.J., Breque, J. and Blanc, D. (1991) Requirements for protein and essential amino acids and their utilization by Siberian sturgeon (*Acipenser baeri*). In: Williot, P. (ed.) *Proceedings of the First International Symposium on the Sturgeon*, CEMAGREF, Bordeaux, France, pp. 25–37.
- Keembiyehetty, C.N. and Gatlin, D.M. III (1992) Dietary lysine requirement of juvenile hybrid striped bass (*Morone chrysops* × *M. saxatilis*). *Aquaculture* 104, 271–277.
- Keembiyehetty, C.N. and Gatlin, D.M. III (1993) Total sulphur amino acid requirement of juvenile hybrid striped bass (*Morone chrysops* × *M. saxatilis*). *Aquaculture* 110, 331–339.
- Keembiyehetty, C.N. and Gatlin, D.M. III (1995) Evaluation of different sulphur compounds in the diet of juvenile sunshine bass (*Morone chrysops* × *M. saxatilis*). *Comparative Biochemistry and Physiology* 112A, 155–159.
- Keembiyehetty, C.N. and Gatlin, D.M. III (1997) Dietary threonine requirement of juvenile hybrid striped bass (*Morone chrysops* × *M. saxatilis*). *Aquaculture Nutrition* 3, 217–221.
- Ketola, H.G. (1982) Amino acid nutrition of fishes: requirements and supplementation of diets. *Comparative Biochemistry and Physiology* 73B, 17–24.
- Ketola, H.G. (1983) Requirement for dietary lysine and arginine by fry of rainbow trout. *Journal of Animal Science* 56, 101–107.
- Khan, M.A. and Jafri, A.K. (1993) Quantitative dietary requirements for some indispensable amino acids in the Indian major carp, *Labeo rohita* (Hamilton) fingerlings. *Journal of Aquaculture in the Tropics* 8, 67–80.
- Kim, J-D. and Lall, S.P. (2000) Amino acid composition of whole body tissue of Atlantic halibut (*Hippoglossus hippoglossus*), yellowtail flounder (*Pleuronectes ferruginea*) and Japanese flounder (*Paralichthys olivaceus*). *Aquaculture* 187, 367–373.
- Kim, K.I. (1993) Requirement for phenylalanine and replacement value of tyrosine for phenylalanine in rainbow trout (*Oncorhynchus mykiss*). *Aquaculture* 113, 243–250.

- Kim, K.I., Kayes, T.B. and Amundson, C.H. (1987) Effects of dietary tryptophan levels on growth, feed/gain, carcass composition and liver glutamate dehydrogenase activity in rainbow trout (*Oncorhynchus mykiss*). *Comparative Biochemistry and Physiology* 88B, 737–741.
- Kim, K.I., Kayes, T.B. and Amundson, C.H. (1992a) Requirements for sulphur amino acids and utilization of D-methionine by rainbow trout (*Oncorhynchus mykiss*). *Aquaculture* 101, 95–103.
- Kim, K.I., Kayes, T.B. and Amundson, C.H. (1992b) Requirements for lysine and arginine by rainbow trout (*Oncorhynchus mykiss*). *Aquaculture* 106, 333–344.
- Kim, K.I., Grimshaw, T.W., Kayes, T.B. and Amundson, C.H. (1992c) Effect of fasting or feeding diets containing different levels of protein or amino acids on the activities of the liver amino acid-degrading enzymes and amino acid oxidation in rainbow trout (*Oncorhynchus mykiss*). *Aquaculture* 107, 89–105.
- Klein, R.G. and Halver, J.E. (1970) Nutrition of salmonoid fishes: arginine and histidine requirements of chinook and coho salmon. *Journal of Nutrition* 100, 1105–1109.
- Kloppel, T.M. and Post, F. (1975) Histological alterations in tryptophan-deficient rainbow trout. *Journal of Nutrition* 105, 861–866.
- Lall, S.P., Kaushik, S.J., LeBail, P.Y., Keith, R., Anderson, J.S. and Plisetskaya, E. (1994) Quantitative arginine requirement of Atlantic salmon (*Salmo salar*) reared in seawater. *Aquaculture* 124, 13–25.
- Liou, C.H. (1989) Lysine and sulphur amino acid requirements of juvenile blue tilapia (*Oreochromis aureus*) (tilapia). PhD dissertation, Texas A&M University, College Station, Texas.
- Lukton, A. (1958) Effect of diet on imidazole compounds and creatine in chinook salmon. *Nature* 182, 1014–1020.
- Luquet, P. and Sabaut, J.J. (1974) Nutrition azotée et croissance chez la daurade et la truite. *Actes de Colloques, Colloques sur L'Aquaculture*, Brest no. 1, 243–253.
- Luzzana, U., Hardy, R.W. and Halver, J.E. (1998) Dietary arginine requirement of fingerling coho salmon (*Oncorhynchus kisutch*). *Aquaculture* 163, 137–150.
- Mambrini, M. and Kaushik, S.J. (1995) Indispensable amino acid requirements of fish: correspondence between quantitative data and amino acid profiles of tissue proteins. *Journal of Applied Ichthyology* 11, 240–247.
- Mertz, E.T. (1972) The protein and amino acid needs. In: Halver, J.E. (ed.) *Fish Nutrition*. Academic Press, New York, pp. 105–143.
- Millamena, O.M., Bautista, M.N. and Kanazawa, A. (1996a) Methionine requirement of juvenile tiger shrimp *Penaeus monodon* Fabricius. *Aquaculture* 143, 403–410.
- Millamena, O.M., Bautista, M.N. and Kanazawa, A. (1996b) Valine requirement of postlarval tiger shrimp *Penaeus monodon* Fabricius. *Aquaculture Nutrition* 2, 129–132.
- Millamena, O.M., Bautista, M.N., Reyes, O.S. and Kanazawa, A. (1997) Threonine requirement of juvenile marine shrimp *Penaeus monodon*. *Aquaculture* 151, 9–14.
- Millamena, O.M., Bautista, M.N., Reyes, O.S. and Kanazawa, A. (1998) Requirements of juvenile tiger shrimp *Penaeus monodon* Fabricius for lysine and arginine. *Aquaculture* 164, 95–104.
- Millamena, O.M., Teruel, M.B., Kanazawa, A. and Teshima, S. (1999) Quantitative dietary requirements of postlarval tiger shrimp, *Penaeus monodon* for histidine, isoleucine, leucine, phenylalanine and tryptophan. *Aquaculture* 179, 169–179.
- Moon, H.Y. and Gatlin, D.M. III (1991) Total sulphur amino acid requirements of juvenile red drum, *Sciaenops ocellatus*. *Aquaculture* 95, 97–106.
- Murthy, H.S. and Varghese, T.J. (1996) Quantitative dietary requirement of threonine for the growth of the Indian major carp, *Labeo rohita* (Hamilton). *Journal of Aquaculture in the Tropics* 11, 1–7.
- Murthy, H.S. and Varghese, T.J. (1997) Dietary requirements of juveniles of the Indian major carp, *Labeo rohita*, for the essential amino acid lysine. *Israeli Journal of Aquaculture-Bamidgeh* 49, 19–24.
- Ng, W.K. and Hung, S.S.O. (1995) Estimating the ideal dietary indispensable amino acid pattern for growth of white sturgeon, *Acipenser transmontanus* (Richardson). *Aquaculture Nutrition* 1, 85–94.
- Ngamsnae, P., De Silva, S.S. and Gunasekera, R.M. (1999) Arginine and phenylalanine requirement of juvenile silver perch *Bidyanus bidyanus* and validation of the use of body amino acid composition for estimating individual amino acid requirements. *Aquaculture Nutrition* 5, 173–180.
- Nose, T. (1979) Summary report on the requirements of essential amino acids for carp. In: Halver, J.E. and Tiews, K. (eds) *Finfish Nutrition and Fishfeed Technology*, Vol. 1. Heenemann, Berlin, pp. 145–156.
- Nose, T. and Murai, T. (1990) Amino acid requirements in fishes. In: Yoshida, A., Naito, H., Niiyama, Y. and Suzuki, T. (eds) *Nutrition: Proteins and Amino Acids*. Japan Science Society Press, Tokyo/Springer-Verlag, Berlin, pp. 85–95.

- Nose, T., Arai, S., Lee, D.L. and Hashimoto, Y. (1974) A note on amino acids essential for growth of young carp. *Bulletin of the Japanese Society of Scientific Fisheries* 40, 903–908.
- Ogata, H., Arai, S. and Nose, T. (1983) Growth responses of cherry salmon *Oncorhynchus masou* and amago salmon *O. rhodurus* fry fed purified casein diets supplemented with amino acids. *Bulletin of the Japanese Society of Scientific Fisheries* 49, 1381–1385.
- Ogino, C. (1980) Requirements of carp and rainbow trout for essential amino acids. *Bulletin of the Japanese Society of Scientific Fisheries* 46, 171–174.
- Pack, M., Rodehutsord, M., Jacobs, S. and Pfeffer, E. (1995) Amino acid requirements of rainbow trout (*Oncorhynchus mykiss*): II. Protein deposition as function of dietary methionine, threonine and arginine. *Journal of Applied Ichthyology* 11, 390–393.
- Page, J.W., Rumsey, G.L., Riis, R.C. and Scott, M.L. (1978) Dietary sulphur requirements of fish: nutritional and pathological criteria. *Federation Proceedings* 37, 1189 (abstr).
- Pfeffer, E., Al-Sabty, H. and Haverkamp, R. (1992) Studies on lysine requirements of rainbow trout (*Oncorhynchus mykiss*) fed wheat gluten as only source of dietary protein. *Journal of Animal Physiology and Animal Nutrition* 67, 74–82.
- Poston, H.A. and Rumsey, G.L. (1983) Factors affecting dietary requirement and deficiency signs of L-tryptophan in rainbow trout. *Journal of Nutrition* 113, 2568–2577.
- Poston, H.A., Riis, R.C., Rumsey, G.L. and Ketola, H.G. (1977) The effect of supplemental dietary amino acids, minerals and vitamins on salmonids fed cataractogenic diets. *The Cornell Veterinarian* 67, 472–509.
- Ravi, J. and Devaraj, K.V. (1991) Quantitative essential amino acid requirements for growth of catla, *Catla catla*. *Aquaculture* 96, 281–291.
- Robbins, K.R., Baker, D.H. and Norton, H.W. (1977) Histidine status in the chick as measured by growth rate, plasma free histidine and breast muscle carnosine. *Journal of Nutrition* 107, 2055–2061.
- Robbins, K.R., Norton, H.W. and Baker, D.H. (1979) Estimation of nutrient requirements from growth data. *Journal of Nutrition* 109, 1710–1714.
- Robinson, E.H., Allen, O.W. Jr, Poe, W.E. and Wilson, R.P. (1978) Utilization of dietary sulphur compounds by fingerling channel catfish: L-methionine, DL-methionine, methionine hydroxy analogue, taurine and inorganic sulfate. *Journal of Nutrition* 108, 1932–1936.
- Robinson, E.H., Wilson, R.P. and Poe, W.E. (1980a) Total aromatic amino acid requirement, phenylalanine requirement and tyrosine replacement value for fingerling channel catfish. *Journal of Nutrition* 110, 1805–1812.
- Robinson, E.H., Wilson, R.P. and Poe, W.E. (1980b) Re-evaluation of the lysine requirement and lysine utilization by fingerling channel catfish. *Journal of Nutrition* 110, 2313–2316.
- Robinson, E.H., Wilson, R.P. and Poe, W.E. (1981) Arginine requirement and apparent absence of a lysine–arginine antagonism in fingerling channel catfish. *Journal of Nutrition* 111, 46–52.
- Robinson, E.H., Poe, W.E. and Wilson, R.P. (1984) Effects of feeding diets containing an imbalance of branched-chain amino acids on fingerling channel catfish. *Aquaculture* 37, 51–62.
- Rodehutsord, M., Jacobs, S., Pack, M. and Pfeffer, E. (1995) Response of rainbow trout (*Oncorhynchus mykiss*) growing from 50 to 170 g to supplements of either L-arginine or L-threonine in a semipurified diet. *Journal of Nutrition* 125, 970–975.
- Rollin, X., Hidalgo, Y., Valdez, M., Teller, E. and Vanbelle, M. (1994) Quantitative methionine requirement of Atlantic salmon (*Salmo salar* L.) juveniles. *Aquaculture* 124, 61 (abstr).
- Ruchimat, T., Masumoto, T., Hosokawa, H. and Shimeno, S. (1997a) Quantitative methionine requirement of yellowtail (*Seriola quinqueradiata*). *Aquaculture* 150, 113–122.
- Ruchimat, T., Masumoto, T., Hosokawa, H., Itoh, Y. and Shimeno, S. (1997b) Quantitative lysine requirement of yellowtail (*Seriola quinqueradiata*). *Aquaculture* 158, 331–339.
- Rumsey, G.L. and Ketola, H.G. (1975) Amino acid supplementation of casein diets of Atlantic salmon (*Salmo salar*) fry and of soybean meal for rainbow trout *Salmo gairdneri* fingerlings. *Journal of the Fisheries Research Board of Canada* 32, 422–426.
- Rumsey, G.L., Page, J.G. and Scott, M.L. (1983) Methionine and cystine requirements of rainbow trout. *The Progressive Fish-Culturist* 45, 139–143.
- Santiago, C.B. and Lovell, R.T. (1988) Amino acid requirements for growth of Nile tilapia. *Journal of Nutrition* 118, 1540–1546.
- Schwarz, F.J., Kirchgessner, M. and Deuringer, U. (1998) Studies on the methionine requirement of carp (*Cyprinus carpio* L.). *Aquaculture* 161, 121–129.

- Shanks, W.E., Gahimer, G.D. and Halver, J.E. (1962) The indispensable amino acids for rainbow trout. *The Progressive Fish-Culturist* 24, 68–73.
- Simmons, L., Mocci, R.D., Bureau, D.P., Sivak, J.G. and Herbert, K. (1999) Dietary methionine requirement of juvenile Arctic charr *Salvelinus alpinus* (L.). *Aquaculture Nutrition* 5, 93–100.
- Small, B.C. and Soares, J.H. Jr (1998) Estimating the quantitative essential amino acid requirements of striped bass *Morone saxatilis*, using fillet A/E ratios. *Aquaculture Nutrition* 4, 225–232.
- Small, B.C. and Soares, J.H. Jr (1999) Quantitative dietary threonine requirement of juvenile striped bass *Morone saxatilis*. *Journal of the World Aquaculture Society* 30, 319–323.
- Tacon, A.G.J. and Cowey, C.B. (1985) Protein and amino acid requirements. In: Tytler, P. and Calow, P. (eds) *Fish Energetics: New Perspectives*. The Johns Hopkins University Press, Baltimore, Maryland, pp. 155–183.
- Thebault, H., Alliot, E. and Pastoureaud, A. (1985) Quantitative methionine requirement of juvenile sea-bass (*Dicentrarchus labrax*). *Aquaculture* 50, 75–87.
- Tibaldi, E. and Lanari, D. (1991) Optimal dietary lysine levels for growth and protein utilization of fingerling sea bass (*Dicentrarchus labrax* L.) fed semi-purified diets. *Aquaculture* 95, 297–304.
- Tibaldi, E. and Tulli, F. (1999) Dietary threonine requirement of juvenile European sea bass (*Dicentrarchus labrax*). *Aquaculture* 175, 155–166.
- Toth, E.O. (1986) Arginine requirement of wels, *Silurus glanis*. *Aquaculture Hungary* 5, 59–63.
- Twibell, R.G. and Brown, P.B. (1997) Dietary arginine requirement of juvenile yellow perch. *Journal of Nutrition* 127, 1838–1841.
- Unprasert, N.G. (1994) An evaluation of the use of 'ideal' protein concept to estimate essential amino acid requirements of the *Clarias* hybrid (*Clarias macrocephalus* × *Clarias gariepinus*). PhD dissertation, Mississippi State University, Miss. State, Mississippi.
- Walton, M.J., Cowey, C.B. and Adron, J.W. (1982) Methionine metabolism in rainbow trout fed diets of differing methionine and cystine content. *Journal of Nutrition* 112, 1525–1535.
- Walton, M.J., Cowey, C.B. and Adron, J.W. (1984a) The effect of dietary lysine levels on growth and metabolism of rainbow trout (*Salmo gairdneri*). *British Journal of Nutrition* 52, 115–122.
- Walton, M.J., Coloso, R.M., Cowey, C.B., Adron, J.W. and Knox, D. (1984b) The effects of dietary tryptophan levels on growth and metabolism of rainbow trout (*Salmo gairdneri*). *British Journal of Nutrition* 51, 279–287.
- Walton, M.J., Cowey, C.B., Coloso, R.M. and Adron, J.W. (1986) Dietary requirements of rainbow trout for tryptophan, lysine and arginine determined by growth and biochemical measurements. *Fish Physiology and Biochemistry* 2, 161–169.
- Wilson, R.P. (1985) Amino acid and protein requirements of fish. In: Cowey, C.B., Mackie, A.M. and Bell, J.G. (eds) *Nutrition and Feeding in Fish*. Academic Press, London, pp. 1–16.
- Wilson, R.P. (1989) Amino acids and proteins. In: Halver, J.E. (ed.) *Fish Nutrition*, 2nd edn. Academic Press, San Diego, pp. 111–151.
- Wilson, R.P. and Cowey, C.B. (1985) Amino acid composition of whole body tissue of rainbow trout and Atlantic salmon. *Aquaculture* 48, 373–376.
- Wilson, R.P. and Poe, W.E. (1985) Relationship of whole body and egg essential amino acid patterns to amino acid requirement patterns in channel catfish, *Ictalurus punctatus*. *Comparative Biochemistry and Physiology* 80B, 385–388.
- Wilson, R.P., Harding, D.E. and Garling, D.L. Jr (1977) Effect of dietary pH on amino acid utilization and the lysine requirement of fingerling channel catfish. *Journal of Nutrition* 107, 166–170.
- Wilson, R.P., Allen, W.W. Jr, Robinson, E.H. and Poe, W.E. (1978) Tryptophan and threonine requirements of fingerling channel catfish. *Journal of Nutrition* 108, 1595–1599.
- Wilson, R.P., Poe, W.E. and Robinson, E.H. (1980) Leucine, isoleucine, valine and histidine requirements of fingerling channel catfish. *Journal of Nutrition* 110, 627–633.
- Zeitoun, I.H., Tack, P.I., Halver, J.E. and Ullrey, D.E. (1973) Influence of salinity on protein requirements of rainbow trout (*Salmo gairdneri*) fingerlings. *Journal of the Fisheries Research Board of Canada* 30, 1867–1873.



# 24 Crystalline Amino Acids and Nitrogen Emission

Martin W.A. Verstegen<sup>1\*</sup> and Age W. Jongbloed<sup>2</sup>

<sup>1</sup>Department of Animal Sciences, Animal Nutrition Group, Wageningen University and Research Centre, Wageningen, The Netherlands; <sup>2</sup>ID-TNO Animal Nutrition, Lelystad, The Netherlands

---

## Introduction

At least quantitatively a great deal is known about the digestion of food, the uptake of amino acids over time, their subsequent metabolism and the rate of accumulation of protein in body tissues (Moughan, 1999). However, it is difficult to measure the variation in the processes involved in protein digestion and protein metabolism. These processes are difficult to measure, e.g. protein synthesis and protein breakdown (Baldwin *et al.*, 1994). Knowledge of variation would give possibilities to influence these processes and thus give the possibility to influence them. Some approaches have given enormous possibilities to reduce the losses in various processes. One of these approaches is to distinguish between processes of maintenance and those associated with the accretion of new body tissue (Moughan, 1999). So feed protein will be involved both in the processes of maintenance and growth. At zero nitrogen growth there are still processes associated with protein metabolism. Animals use dietary protein as sources of individual amino acids (AAs). The essential AAs especially need to be supplied by the diet, the

non-essential AAs can be provided by the diet but the animals are also able to synthesize them. Ruminants can satisfy their additional AA requirements by digestion of microbial proteins which are synthesized in the rumen and subsequently pass into the small intestine.

In all species the efficiency of utilization of absorbed AAs for protein synthesis is mainly determined by the availability of the most limiting amino acid at the site of protein anabolism. Any excess of AAs over what is needed is degraded and the surplus N is excreted as urea or ammonia depending on the species. In animal production the larger portion of ingested N is excreted as waste in faeces and urine; this surplus is then dispersed into the environmental water, soil and air.

Figure 24.1 represents the nitrogen flow for growing finishing pigs in partially slatted floors, and with surface application of slurry. The N intake is assumed to be 55 g pig<sup>-1</sup> day<sup>-1</sup> (Aarnink, 1997). The branches represent partitioning. Losses of N between species are not equal and the proportion of N that is not retained in the body increases from poultry to pigs to cattle (see Table 24.1).

\*E-mail address: Martin.Verstegen@WUR.NL

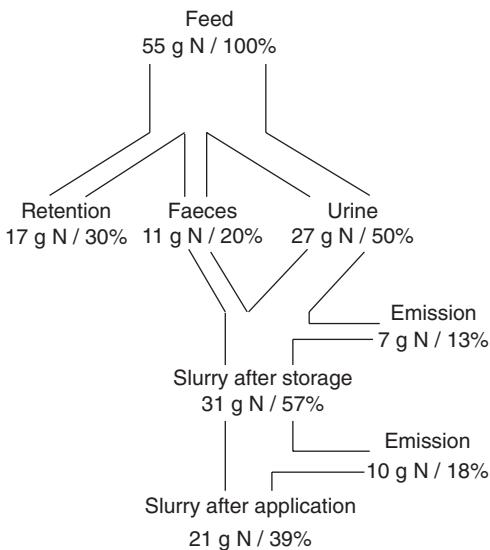


Fig. 24.1. Nitrogen flow for growing-finishing pigs.

**Table 24.1.** Ratio of retained nitrogen in animals to N content in diet. (From Booms-Prins *et al.*, 1996.)

	Nitrogen
Cattle	0.15
Pigs	0.29
Poultry	0.31

There is abundant evidence that the figures of efficiency can increase considerably from those mentioned in Table 24.1 provided that: (i) a correct level of essential AAs, (ii) a proper level of total AAs, and (iii) a proper amino acid /energy ratio are given. If the balanced AAs level is the limiting factor, e.g. at low protein and high energy level, about 15–20% of absorbed protein is catabolized (Kyriazakis and Emmans, 1992).

In a normal diet, such as maize–soybean about 25% of protein consists of unbalanced amino acids. These will appear in excreta. It has been estimated further that about 50% of N in excreta of, for example pigs, can be attributed to non-optimal amino acid balance (De Lange *et al.*, 1999). A simple means of correcting this is to replace some of the protein by adding crystalline AAs (e.g. L-lysine, L-threonine, DL-methionine and L-tryptophan) to the diets of animals.

The differences between N taken in and maintenance N excreted are the source of N-emission into the environment. At low (limited) levels of protein intake the relation between utilization of ideally balanced protein and protein ratio is constant, this means that maintenance probably does not vary much. In addition to the amount of N which is excreted any change in the ratio of N in urine to N in faecal matter can influence the rate at which  $\text{NH}_3$  is emitted into the air (Canh *et al.*, 1997).

The following sections will discuss a few aspects of the use of crystalline amino acids in the feed to influence N-excretion and N-emission. Two approaches are followed to make use of AAs in addition to feed protein: (i) considering the animals; (ii) considering the feed and adjusting feeding strategy to the animal.

## Animals

Animals retain protein in their body N in relation to their potential growth and feed availability (Black *et al.*, 1995). There is considerable variation in growth characteristics of animals particularly the retention of protein deposition in relation to energy deposition. This varies with genotype but also with physiological age, body weight and with the diet. Black *et al.* (1986) concluded that the relationship between potential protein deposition and body weight varies considerably between strain and sex of pigs. For example, it is known that young female pigs will deposit less energy and more protein than castrates and they consume less feed on an *ad libitum* basis (Cromwell, 1994). By keeping the sexes separately, diets can be more precisely formulated for specific sexes, and thus overfortification in the diets and excessive excretion of nutrients can be avoided. Furthermore, increased fat deposition and decreased rate of lean deposition occurs at an earlier growth stage in barrows than in gilts. Therefore, dietary protein and amino acid levels can be more precisely changed at different growth stages for the two sexes. Under such precise feeding conditions, the total quantity of nitrogen and other minerals fed and excreted can be reduced (Jongbloed, 2001).

In poultry too, different strategies with regard to energy/protein are applied to different strains of chickens for efficiency reasons and for health reasons. For example, Scheele *et al.* (1999) suggested that in broiler lines which are sensitive to ascites it may be preferable to limit AA over a short period during early growth to facilitate maintenance energy supply rather than amino acid for gain. In that way less ascites occurred.

### Feed and Feeding Strategy

Until recently, nutrition has been solely focused on the amounts of nutrients, which can be derived from ingested feed. So nearly all new feeding tables present the amounts of nutrients in feedstuffs. They also increasingly provide estimates of nutrients apparently absorbed from a diet or even availability. Availability in this context is defined as the degree to which an ingested nutrient in a particular source is absorbed in a form that can be utilized in metabolism by the animal (De Lange and Fuller, 2000).

The excreta are not considered in the feeding tables. Nowadays in many countries or areas, farmers have to focus on ways to avoid adding nitrogen to the environment, and in addition to avoid emission of  $\text{NH}_3$ . So the excreted surplus of N can become a burden to the environment. Most research has focused on the amounts of nitrogen (N), which are excreted in addition to other minerals.

### N surpluses

It is generally accepted that the ways to reduce N excretion in animals by ways of nutrition include :

- The amount of nitrogen that is consumed by the animal;
- The digestibility of N that is consumed. This also includes the endogenous losses in the gastrointestinal (GI) tract;
- The amino acid pattern of absorbed or available N.

Together these determine the efficiency by which dietary N is converted into animal products.

### *Reduction in amount of N consumed*

The most obvious way is to reduce surplus of N-intake; this entails removal of the safety margin. It means that there can only be minor errors in feed preparation and in estimation of actual N content in the batch from which the feed is chosen. It also means that reliable and accurate data on AA composition or preferably AA availability should be known. The knowledge of and the use of data on ileal digestible or rather available amino acid in the diet is a possibility to increase the accuracy of diet composition. De Lange and Fuller (2000) argued that by using standardized true digestible amino acid of each feedstuff one can add these to obtain the total amount in the diet. A portion of the nitrogen excreted by the pig is a direct result of feeding excessive levels of nitrogen, the greater the excess, the greater the portion of N excreted. Results of surveys of the nutrient composition of diets indicate that diets commonly include excess amounts of certain AAs. If these are essential AAs these excesses are called a 'safety factor', which are included in the diet to allow for the variability of nutrient composition of feed ingredients, or to compensate for uncertainty about the availability and requirements of the nutrients. The typical range of university recommendations was 110–120% of the National Research Council (1998) recommendations, whereas the typical range of industry recommendations was 120–130% of these recommendations (Kornegay and Verstegen, 2001). The excess for the sows was a little lower than for finishing pigs. Other surveys have reported similar findings and that some safety is also included for poultry.

### *Use of highly digestible feedstuffs in diets*

This is an effective means of reducing excretion of nitrogen and other nutrients. As cited by Van Heugten and Van Kempen (1999) and FEFANA (1992) it is estimated that nutrient excretion in waste could be reduced by about 5% (Kerr, 1996).

### *Enhancing biological value of dietary protein*

This is a common practice in feed formulation. It is done by accounting for differences in available AA contents in different feedstuffs



and also by adding crystalline AAs (Table 24.2). This means lowering the dietary protein level and supplementing with certain crystalline amino acids. This is a well-established method of formulating diets to achieve a more ideal amino acid pattern. In addition a diet with a well-balanced AA pattern is also very effective in reducing nitrogen excretion. This can also be obtained by using a protein source with superior amino acid balance. If diets are formulated in this way one obtains a dietary protein closer to ideal protein. These diets will generally have a lower protein content and they form a basis to reduce the excretion of nitrogen and other nutrients. Both procedures (highly digestible protein and an AA acid pattern close to ideal) reduces excesses of not needed amino acids. These will otherwise be degraded and excreted as urea nitrogen.

### Considering amino acid supplementation

Lysine supplementation of cereal grain–plant protein based diets has been widely used in pigs and in poultry. It has generally led to about a two percentage point decrease in dietary crude protein, which results in a 17–22% reduction in nitrogen excretion (Gatel and Grosjean, 1992; Henry and Dourmad, 1992; Van der Honing *et al.*, 1993; Cromwell, 1994; Gatel, 1994). A further reduction in nitrogen excretion was obtained when the crude protein level was reduced four percentage points and the diets

were supplemented with three or four of the following amino acids: lysine, threonine, tryptophan or methionine (Kephart and Sherritt, 1990; Bridges *et al.*, 1995; Kerr and Easter, 1995; Carter *et al.*, 1996).

Nonn and Jeroch (2000) reduced the protein content of a cereal based diet by about 4% and they added eight amino acids, lysine, methionine, threonine, tryptophan, leucine, isoleucine, histidine and valine and found 38.5% reduction in N excretion at a similar rate of gain in control and amino acid-supplemented animals. Reductions in total nitrogen excretion ranged from 28% to 40%, and most of the decrease was in urinary nitrogen excretion (Table 24.3). This was similar to results of studies obtained by Bridges (1995) (see Table 24.2).

### Use of Crystalline Amino Acids and High Quality Protein

Lowering the dietary protein level and supplementing with certain crystalline amino acids is a well-established method of formulating diets to achieve a more ideal amino acid pattern, and it is very effective in reducing nitrogen excretion. Also, using highly 'digestible' feed-stuffs, a high quality protein source with superior amino acid balance, and formulating diets to achieve an ideal protein basis reduces the excretion of nitrogen and other nutrients. Both procedures reduce excesses of unneeded amino acids, which otherwise are degraded and excreted as urea nitrogen.

**Table 24.2.** Effect of reducing dietary crude protein and supplementing with amino acids on nitrogen excretion. (Average of experiments reported by Bridges *et al.*, 1995.)

	Diets		
	140 g CP kg <sup>-1</sup>	120 g CP kg <sup>-1</sup> + 1.59 Lys kg <sup>-1</sup>	100 g CP kg <sup>-1</sup> + 3.0 g Lys kg <sup>-1</sup> + 0.8 g Thr kg <sup>-1</sup> + 0.39 Trp kg <sup>-1</sup>
N intake (g day <sup>-1</sup> )	46.9	40.2	35.2
N digested (g day <sup>-1</sup> )	42.3	36.0	30.3
N excreted in faeces (g day <sup>-1</sup> )	4.5	4.3	4.9
N excreted in urine (g day <sup>-1</sup> )	17.7	13.7	10.9
Total N excreted (g day <sup>-1</sup> )	22.2	18.0	15.8
N retained (g day <sup>-1</sup> )	24.6	22.3	19.5
Reduction in N excretion %	—	18.9	28.8

**Table 24.3.** Impact of added amino acids on N excretion in pigs. (From Nonn and Jeroch, 2000.)

Weight range	N excretion (g N day <sup>-1</sup> )			
	Controls		Added amino acids	
	Females	Castrates	Females	Castrates
25–60 kg	40.1	33.7	25.0	19.9
60–85 kg	44.5	59.2	29.5	37.3
85–110 kg	36.2	43.9	22.6	28.2
25–110 kg	39.8	43.3	25.4	26.6

Based on a review of several papers, Kerr and Easter (1995) suggested that for each percentage unit reduction in dietary crude protein combined with amino acid supplementation, total nitrogen losses (faecal and urinary) in pigs could be reduced by approximately 8%. Although the application of such crystalline amino acids in practical situations is generally straightforward, it is recognized that there will be limits to their use compared with intact protein. For example, nitrogen retained is often less when amino acids are supplemented and the crude protein level is reduced to a large extent. This is especially so when three or more amino acids replace four percentage units of crude protein.

Conversely, the use of low-quality protein sources markedly increases nitrogen excretion. Also, the inclusion of high levels of crude fibre in the diet reduces the efficiency of nitrogen utilization (Kornegay and Verstegen, 2001).

In most of the above-mentioned studies there were only small changes in faecal nitrogen losses because the added amino acids are very highly digestible. Several nutritional means are available to improve the nitrogen balance considerably. The use of added amino acids often crystalline AA, at present lysine, methionine, threonine and tryptophan, can reduce N excretion with manure in, for example, pigs by about 35%.

In poultry there is also an abundance of literature on reduction of protein levels with simultaneous addition of amino acids. Studies by Summers *et al.* (1992), Fancher and Jensen (1989) and Holsheimer and Janssen (1991) reported impaired weight gain and in broilers with low protein and extra amino acids. Other studies of (Moran *et al.*, 1992;

Aletor *et al.*, 2000) found nearly similar performance with added amino acids and less protein. If changes occurred these pointed mostly to more abdominal fat in the body. In addition, Aletor *et al.* (2000) found increased efficiency when protein in broiler diets was reduced to 153 g kg<sup>-1</sup> with extra AAs. About 41% less N was excreted. By reducing the ratio of non-essential to essential AA content Ten Doeschate (1995) found a further reduction. If diets reduce amounts of endogenous AA this will give another possibility to reduce N surpluses. Gahl *et al.* (1995) demonstrated the diminishing returns in response to increasing nutrient input, but the responses in terms of reduction were not linear.

Feeding strategy also includes reducing feed waste and phase feeding. Estimated from various studies Van Heugten and Van Kempen (1999) quoted values of 2–12% in the United States, 1.5–20% in Great Britain, and 3–5% in Denmark.

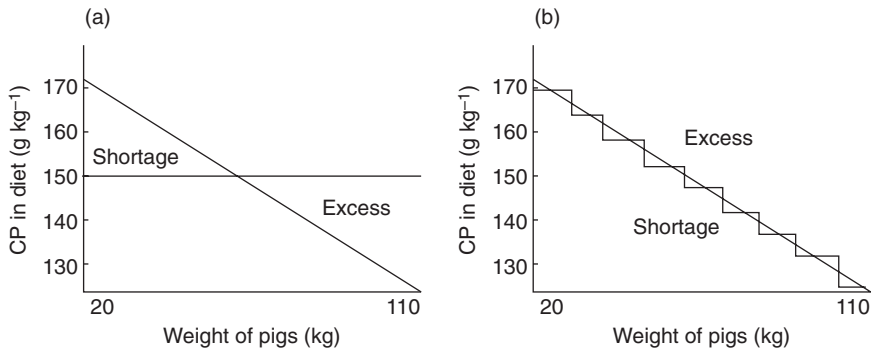
Phase feeding can be applied to adjust the available AA content to the specific weight of the animal. The requirement of animals for most available amino acids expressed as part of the total diet decreases as animals grow heavier if the diet is not changed. Thus changes in diet formulation if properly adjusted can meet the nutrient needs of pigs more efficiently. Adjustments in diets with increase in weight can result in reduced intake of AAs and thus, reduced excretion of nitrogen. Phase feeding, as some have described it, is a way to meet more precisely the nutrient needs of growing and finishing pigs. This concept applied to dietary crude protein is illustrated in Table 24.4 and Fig. 24.2.

**Table 24.4.** Effect of feeding strategy during the growing-finishing period (25–105 kg) on N output. (Adapted from Henry and Dourmad, 1993.)

	Single-feed 170 g CP kg <sup>-1</sup>	Two-feeds <sup>a</sup> 170–150 g CP kg <sup>-1</sup>	Three-feeds <sup>b</sup> 170–150–130 g CP kg <sup>-1</sup>
N output (g day <sup>-1</sup> )	31.9	29.0	26.7
Percentage of two-feed strategy	110	100	92

<sup>a</sup>Crude protein changed at 55 kg body weight.

<sup>b</sup>Crude protein changed at 50 and 75 kg body weight.



**Fig. 24.2.** Example of a one-phase (a) and a nine-phase (b) feeding programme for the growing and finishing phase. (Kornegay and Harper, 1997, cf. Kornegay and Verstegen, 2001.)

Protein requirements may change (perhaps weekly) as pigs grow. Therefore, the formulation of the diet can also change as the nutrient requirements change. The nutrient needs of the animal can be met more precisely and in this way the total quantity of nitrogen excreted can be reduced.

These changes, however, have a danger that the animals will have to adapt their digestive processes to these diets often with, as a result, reduced availability of nitrogen. The study by Henry and Dourmad (1993) showed that nitrogen excretion could be reduced approximately 15% when feeding a 140 g CP kg<sup>-1</sup> diet was initiated at 60 kg body weight, rather than continuous feeding of a 160 g CP kg<sup>-1</sup> grower diet to final weight. Another French study (Chauvel and Granier, 1996) reported a 9% reduction in nitrogen excretion when a two-phase was changed into a multiphase system. The proportions of 189 and 149 g CP kg<sup>-1</sup> diet (4.1 and 2.6 g digestible lysine MJ<sup>-1</sup> net energy, respectively) were changed weekly

from 24 to 107 kg in the multiphase system versus a two-phase system in which a 181 g CP kg<sup>-1</sup> (0.85 g lysine MJ<sup>-1</sup> net energy) diet was fed until 66 kg and a 161 g CP kg<sup>-1</sup> (7.4 g lysine MJ<sup>-1</sup> net energy) diet was fed from 66 kg to 107 kg. According to Henry and Dourmad (1993) this change should be made gradually by changing the ratio in which a 'high' protein grower diet is mixed with a 'low' protein finishing diet. In a recent Dutch study a 14.7% reduction in urinary nitrogen excretion was reported when a multiphase feeding programme was compared with a two-phase feeding programme (Van der Peet-Schwering *et al.*, 1996). They also found that ammonia emission was reduced 16.8%. Their multiphase feeding programme was achieved by mixing, on a weekly basis, a high protein diet with a low protein diet in decreasing proportions as pigs grew. Under such precise feeding conditions, the total quantity of nitrogen fed can be reduced as well as excreted N.

## Quality of Manure

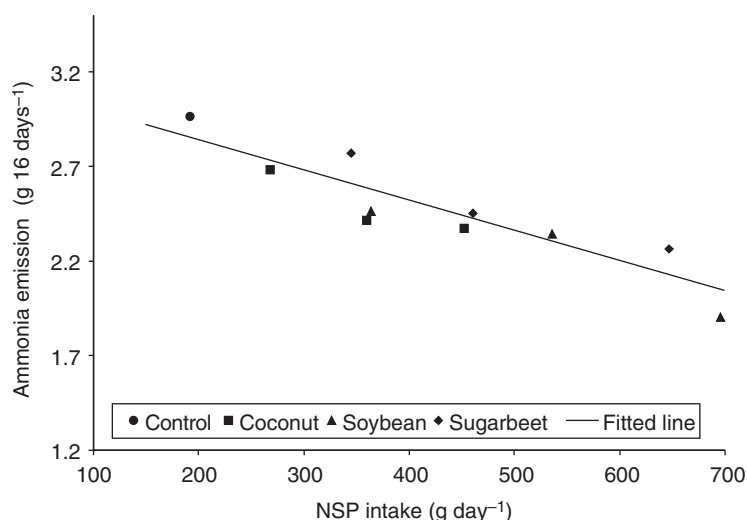
Manure is a mixture of excreta (urine and faecal matter). It is composed of undigested dietary components, endogenous components and products from indigenous microorganisms and the biomass of those microorganisms. Some odorous volatile components (OVC), short-chain volatile fatty acids (VFA), and other volatile carbon–nitrogen and sulphur-containing compounds from microbial fermentation in the GI tract can be emitted immediately. Others are emitted at various times after excretion. Around 200 or more odour-causing compounds have been identified. The sensitivity of the individual compounds by olfactometry threshold detection varies widely (Aarnink, 1997; Sutton *et al.*, 1999). Tables of threshold values are given in these papers. Similarly, Aarnink (1997) showed in model calculations that a 9% reduction of N in ammonium in slurry could be reached with each 1% reduction in dietary crude protein content, and this was confirmed by Sutton *et al.* (1999). They reduced crude protein from 13 to 10% or from 18 to 10% and added synthetic amino acids. The reduction in ammonia emission with each 1% reduction in CP is less than indicated above, if housing systems are such that high emission floors are used. The quality of manure

will become important for the future. Some developments already show this. It is well known that by allowing proper microbial fermentation in the large intestine, more microbial biomass will be present in the excreta (Canh *et al.* 1998; Fig. 24.3). This results in apparently lower amounts of digestible N. However, ileal digestible N may be the same. The other consequence is that there is less N in the urine. This only occurs if fermentation continues in the large intestine of pigs (Houdijk, 1998).

As a consequence the C/N ratio in the manure is much higher. This is considered beneficial for soil life. Moreover loss of ammonia from the excreta is less.

Until now most emphasis has been on reducing total N in manure. It can be expected that by combining both a reduced excretion and a shift from urinary excretion to faecal excretion, reducing N in feed will result in an increase in fermentation. Jongbloed and Henkens (1996) reported that nitrogen excretion was reduced by 12% from growing pigs. The data were collected in The Netherlands from 1973 to 1995.

The successful implementation of most of the strategies that follow for reducing nutrient excretion is dependent on: (i) the accuracy of the estimates of the available nutrient requirements of the class of pig in question, (ii) the accuracy of the compositional information,



**Fig. 24.3.** Ammonia emission from slurry by pigs with different intakes of non-starch polysaccharides (NSP). (Canh *et al.*, 1998.)

and (iii) the bioavailability of nutrients in the feed ingredients to be used.

### Conclusions

Reductions in dietary protein level and supplementation with certain crystalline amino acids is a well-established method of formu-

lating diets to achieve a more ideal amino acid pattern and to reduce nitrogen excretion. Up to 35% reduction in nitrogen excretion may be achieved by supplementing pig diets with lysine, methionine, threonine, and tryptophan. In broiler nutrition, 41% less N was excreted on feeding diets with 153 g CP kg<sup>-1</sup> supplemented with amino acids.

### References

- Aarnink, A.J.A. (1997). Ammonia emission from houses for growing pigs as affected by pen design, indoor climate and behaviour. PhD thesis Agricultural University, Wageningen.
- Aletor, V.A., Hamid, I.L., Niess, E. and Pfeffer, E. (2000) Low-protein amino acid-supplemented diets in broiler chickens: effects on performance, carcass characteristics, whole body composition and efficiency of nutrient utilization. *Journal of the Science of Food and Agriculture* 80, 547–554.
- Baldwin, R.L., Calvert, G.C., Hanigan, M.D. and Beckett, J. (1994) Modelling amino acid metabolism in ruminants. In: D'Mello, J.P.F. (ed.) *Amino Acids in Farm Animal Nutrition*. CAB International, Wallingford, UK, pp. 281–306.
- Black, J.L., Campbell, R.G., Williams, I.H., James, K.J. and Davis, G.T. (1986) Simulation of energy and amino acid utilisation in the pig. *Research and Development in Agriculture* 3, 121–145.
- Black, J.L., Davies, G.T., Bray, H.J., Giles, L.R. and Chapple, R.P. (1995) Modelling the effects of genotype environment and health on nutrient utilization. In: Fanfaer, A. and Lescoat, O. (eds) *Proceedings of the IV International Workshop on Modeling Nutrient Utilization in Farm Animals*. National Institute of Animal Science, Denmark, pp. 85–105.
- Booms-Prins, E.R., Van der Meer, H.G., Sanders, J., Tamminga, S. and Van Vugt, F. (1996) [Drastic improvement of nutrient utilisation in Animal Production]. In *NRLO report 94/3, The Hague, The Netherlands*, p.1.
- Bridges, T.C., Turner, L.W., Cromwell, G.L. and Pierce, J.L. (1995) Modeling the effects of diet formulation on nitrogen and phosphorus excretion in swine waste. *Applied Engineering Agriculture* 11, 731.
- Canh, T.T., Verstegen, M.W.A., Aarnink, A.J.A. and Schrama, J.W. (1998) Influence of dietary factors on nitrogen partitioning and composition of urine and feces of fattening pigs. *Journal of Animal Science* 75, 700.
- Canh, T.T., Sutton, A.L., Aarnink, A.J.A., Verstegen, M.W.A., Schrama, J.W. and Bakker, G.C.M. (1998) Dietary carbohydrates alter the fecal composition and pH and the ammonia emission from slurry of growing pigs. *Journal of Animal Science* 76, 1887–1895.
- Carter, S.D., Cromwell, G.L., Lindemann, M.D., Turner, L.W. and Bridges, T.C. (1996) Reducing N and P excretion by dietary manipulation in growing and finishing pigs. *Journal of Animal Science* 74 (Suppl. 1):59 (Abstr.).
- Chauvel, J. and Granier, R. (1996) Effet de l'alimentation multiphase sur la croissance et les rejets azotes du porc charcutier. *Journal de Recherches Porcines en France* 28, 249.
- Cromwell, G.L. (1994) Feeding strategies urged as techniques to decrease pollution from hog manure. *Feedstuffs* 25 July, p 9, 27.
- De Lange, C.F.M. and Fuller, M.F. (2000) Advances in feed evaluation for pigs. In: Moughan, P.J., Verstegen, M.W.A. and Visser-Reyneveld (eds) *Feed Evaluation, Principles and Practice*. Wageningen Press, The Netherlands, pp. 221–241.
- De Lange, C.F.M., Nyachotti, M. and Birkett, S. (1999) Manipulation of diets to minimize the contribution to environmental pollution. In: *Advances in Pork Production*. 10th Banff Pork Seminar, pp. 173–186.
- Fancher, B.I. and Jensen, L.S. (1989) Dietary protein level and essential amino acid content: influence upon female broiler performance during the grower period. *Poultry Science* 68, 897–908.

- FEFANA (Federation Europeenne des Fabricants d' Adjuvants pour la Nutrition Animale) (1992) Improvements in the Environments: Possibilities for the Reduction of Nitrogen and Phosphorus Pollution Caused by Animal Production. Belgium.
- Gahl, M.J., Crenshaw, T.D. and Benevenga, N.J. (1995) Diminishing returns in weight, nitrogen, and lysine gain of pigs fed six levels of lysine from three supplemental sources. *Journal of Animal Science* 73, 3177.
- Gatel, F. (1994) Low protein, amino acid supplemented diets for pigs. *Feed Mix* 2, 32.
- Gatel, F. and Grosjean, F. (1992) Effect of protein content of the diet on nitrogen excretion by pigs. *Livestock Production Science*, 31, 109.
- Henry, Y. and Dourmad, J.Y. (1993) Feeding strategies for minimizing nitrogen outputs in pigs. In: *Nitrogen Flow in Pig Production and Environmental Consequences*. Proceedings First International Symposium on Nitrogen Flow in Pig Production and Environmental Consequences. EAAP Publication No. 69, p. 137.
- Holsheimer P.J. and Janssen, W.M.M.A. (1991) Limiting amino acids in low protein maize-soybean meal diets fed to broiler chicks from 3 to 7 weeks of age. *British Poultry Science* 32, 151-158.
- Houdijk, J.G.M. (1998) Effects of non-digestible oligosaccharides in young pig diets. PhD thesis Wageningen, The Netherlands.
- Jongbloed, A.W. (2001) Lecture at postgraduate course on pig nutrition. New Developments and practice in Dutch. December.
- Jongbloed, A.W. and Henkens, C.H. (1996) Environmental concerns of using animal manure – The Dutch case. In: Kornegay, E.T. (ed.) *Nutrient Management of Food Animals to Enhance and Protect the Environment*. CRC, Boca Raton, Florida, p. 315.
- Kephart, K.B. and Sherrit, S.P. (1990) Performance and nutrient balance in growing swine fed low-protein diets supplemented with amino acids and potassium. *Journal of Animal Science* 68, 1999.
- Kerr B.J. (1996) *Maximising the Utilization of Dietary Amino Acids in Nonruminants*. 13th Biokyoowa Amino Acids Council Meeting, St Louis, pp. 1-26.
- Kerr, B.J. and Easter, R.A. (1995) Effect of feeding reduced protein, amino acid-supplemented diets on nitrogen and energy balance in grower pigs. *Journal of Animal Science* 73, 3000.
- Kerr, B.J. and Kidd, M.T. (1999) Amino acid supplementation of low protein broiler diets 2. Formulation of an ideal amino acid basis. *Journal of Applied Poultry Science* 8, 310-320.
- Kornegay, E.T. and Harper, A.F. (1997) Environmental Nutrition, nutrition management strategies to reduce nutrient excretion of swine. *Prof. Animal Science* 13, 99-111.
- Kornegay, E.T. and Verstegen, M.W.A. (2001) Swine nutrition and pollution and odor control. In: Lewis A.J. and Southern, L.L. (eds) *Swine Nutrition*. CRC Press, Boca Raton, Florida, pp. 609-630.
- Kyriazakis, I. and Emmans, G.C. (1992) Effects of varying protein and energy intakes on the growth and body composition of pigs 2. Effect of varying both energy and protein intake. *British Journal of Nutrition* 68, 615-625
- Moran, E.T. Jr, Bushony, R.D. and Bilghi, S.F. (1992) Reducing dietary crude protein for broilers chicks with satisfying amino acid requirements by least cost formulation: live performance litter composition and yield of fast food carcass cuts at six weeks. *Poultry Science* 71, 1687-1694
- Moughan P.J. (1999) Protein metabolism in the growing pig. In: Kyriazakis, E. (ed.) *A Quantitative Biology of the Pig*. CAB International, Wallingford, UK, pp. 299-332.
- Nonn, H. and Jeroch, H. (2000) Zur reduzierten Fütterung von Mastschweine bei Einsatz freier Amino Sauren. *Archiv fur Tierzucht* 43, 179-191.
- NRC (National Research Council) (1998) *Nutrient Requirements of Swine*, 10th edn. National Academy Press, Washington, DC.
- Scheele, C.W., Verstegen, M.W.A., Kwakkel, R.P., Dekker, R.A. and Kwakernaak, C. (1999) Towards a new net energy system for poultry in The Netherlands. *Proceedings of the 12th European Symposium on Poultry Nutrition*, Veldhoven, The Netherlands Branch of WPSA, pp. 399-407.
- Summers, J.D., Spratt, D. and Atkinson, J.L. (1992) Broiler weight gain and carcass composition when fed diets varying in amino acid balance, dietary energy and protein level. *Poultry Science* 71, 263-273.
- Sutton, A.L., Kephart, K.B., Verstegen, M.W.A., Canh, T.T. and Hobbs, P.J. (1999) Potential for reduction of odorous compounds in swine manure through diet modification. *Journal of Animal Science* 77, 430.
- Ten Doeschate, R.H.M. (1995) Towards a new feeding strategy for protein in broilers. PhD thesis, Wageningen University, The Netherlands, pp. 1-237.

- Van der Honing, Y., Jongbloed, A.W. and Lenis, N.P. (1993) Nutrition management to reduce environmental pollution by pigs. *VII World Conference on Animal Production*, Edmonton, Alberta (Abstr.).
- Van der Peet-Schwering, C.M.C., Verdoes, N., Voermans, N.P. and Beelen, G.M. (1996) Effect of feeding and housing on the ammonia emission of growing and finishing pig facilities. *Research Institute of Pig Husbandry, Report P. 5.3*, p. 27.
- Van Heugten, E. and Van Kempen, T. (1999) Methods may exist to reduce nutrient excretion. *Feedstuffs*, 1 April, 6.

# 25 Economic Assessment of Amino Acid Responses in Growing Poultry

**Michael Pack\*, Dirk Hoehler and Andreas Lemme**  
*Degussa AG, Applied Technology Feed Additives, Hanau, Germany*

---

## **Introduction: Conflicting Economic Objectives**

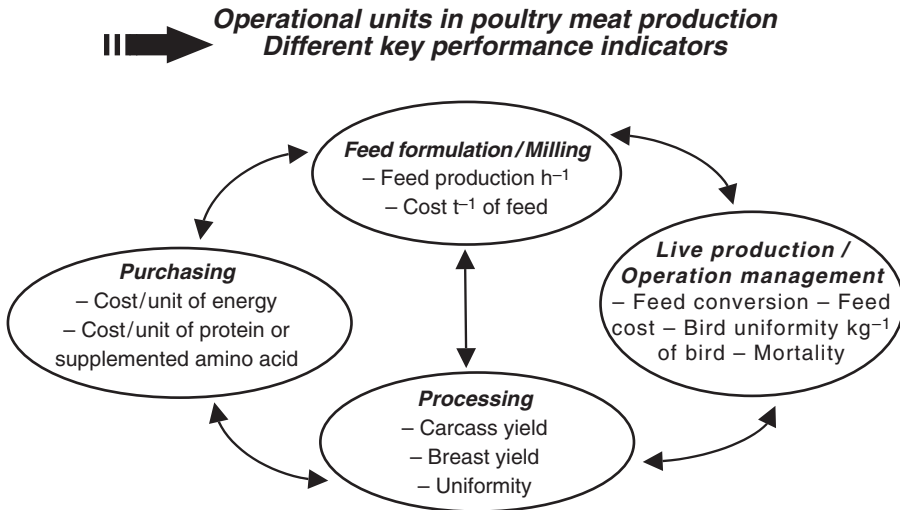
The foremost business objective of modern poultry enterprises is profitability. Typically, profitability is defined by criteria such as net income or return on capital employed. The difficulty is that these criteria are complex and involve a large number of variables. Therefore, they are not suitable for everyday management decisions in a business, which typically consists of different segments: feed mill, hatchery, live production and processing. This conflict often leads company management to focus on performance indicators such as feed cost per ton, feed to gain ratio, liveability, uniformity, carcass yield, etc. These criteria can be directly and numerically measured and attributed to the different segments of the operation thereby facilitating the decision-making process (Fig. 25.1). Additionally, industry-benchmarking systems implemented in each segment for factors such as 'lowest feed cost' or 'highest liveability', combined with a salary bonus help to transfer single business decisions into action. Many of these benchmarks, however, may de-link the enterprise into discrete and isolated business units. The question is, whether this disintegrative way of management really

leads to the best overall profit for the operation. For example, lowest feed cost per ton does not necessarily lead to the best live production performance or carcass quality. To overcome this problem, company management has to define the appropriate criteria on which to focus, and, secondly, to balance them in such a way that the overall objective of maximizing the financial bottom-line will be met.

Indicators for overall profitability of livestock production are only meaningful if they comprise the whole production chain, combining key input (feed and supplement cost) and output variables (marketed product). Moreover, they should be easy to calculate, based on current price and animal performance data. The indicators 'feed cost per kg live weight gain' or 'feed cost per kg breast meat' meet these prerequisites while focusing on different production goals. In this review, the most important essential amino acids lysine (Lys), methionine + cystine (Met+Cys) and threonine (Thr) will be used as variable factors. First, these amino acids represent a major cost factor in the feed formulation. Secondly, they are usually first-limiting in commercial poultry diets, and therefore their concentration in the feed has a significant effect on a number of efficiency measures in

\*E-mail address: michael.pack@degussa.com





**Fig. 25.1.** Integrated poultry production: operational units and their key performance indicators.

the various segments of an integrated poultry operation (feed cost, live performance, carcass quality). Hence, they serve as good examples for demonstrating the effect of statistical data evaluation and different decision-making strategies on overall profitability.

Case scenarios will be drafted for the two different production goals 'minimum feed cost per kg live weight gain' and 'minimum feed cost per kg breast meat' based on an extensive database of dose-response experiments and variable prices for feed and supplemented amino acids. This will allow determination of the most profitable dietary amino acid concentration under a given set of conditions.

The above-mentioned statistical and financial approach will be discussed in detail based on broiler data. Subsequently, this approach will also be applied to Peking ducks and turkeys based on recent, but more limited, scientific dose-response studies.

### Statistical Models to Interpret Responses in Growing Animals

In order to evaluate biological trial results for their economic relevance, their statistical interpretation needs to be discussed first. Studies designed to quantify the requirement for any essential nutrient including amino

acids have to be set up carefully because 'the requirement' is not a single, accurately defined point and never describes totally what the animal needs (from a nutritional point of view). Moreover, it needs to be defined what criterion will be used and at which level we expect the animal to perform. Usually, this definition is related to criteria of economic significance, e.g. weight gain, gain/feed ratio or protein accretion. For example, Gahl *et al.* (1991) found in rats that the quantity of essential amino acids required for weight gain were on average 71% of those required for protein accretion. In dose-response studies with Met+Cys broiler chickens required a concentration for weight gain that was only 83% (Jeroch and Pack, 1995) and 92% (Huyghebaert and Pack, 1996) of that required for optimal gain/feed ratio. Hence, it may be more appropriate when discussing response curves to 'derive recommendations' rather than to quantify 'the requirement'. This is important for the general understanding of the present approach.

In requirement studies, fitting response curves to the experimental data has been suggested as the preferred way of evaluation. In order to do so, the number of dietary levels has to be sufficient and there has to be a sufficiently wide range in dietary supply; from highly deficient to a level definitely not

promoting further increment (Baker, 1986). Any kind of a paired-comparison test of response data often leads to misinterpretation of the results because of the lack of sensitivity of the statistical model, which typically is not good enough to pick up small differences (Baker, 1986; Berndtson, 1991; Pack, 1997). However, with regard to the model chosen, fitting response curves has been handled quite differently and several non-linear models as well as the linear Broken Line approach have been suggested.

The paper by Robbins *et al.* (1979) has prompted the widespread use of the Broken Line approach. This model of a linear increase up to a presumed performance plateau represented by a horizontal line has been widely used to describe the response to variation in amino acid supply, although even Robbins *et al.* (1979) stated that 'the Broken Line, with its discontinuous first derivative, cannot be more than a rough approximation'. The popularity of the Broken Line approach may be the consequence of the fact that one single point can be objectively defined as 'the requirement'. This simplifies the interpretation of response curves; however, it assumes that the response of an animal to supplementation of a limiting nutrient is linear until the requirement is met and that no further response can be expected above this point. The model of choice fitted to response data should satisfy both mathematical and biological considerations (Mercer, 1992). The assumption of constant utilization of a limiting nutrient up to the level of requirement does not appear realistic from the biological context although sections of a response curve, indeed, can be nearly linear (Robbins *et al.*, 1979). It therefore needs a basic decision, which model is most appropriate to describe the response from a biological background and it has been repeatedly suggested that this approach should be non-linear.

This was confirmed by Rodehutsord and Pack (1999), who undertook an extensive review of different non-linear dose-response functions on the basis of 37 amino acid experiments conducted in either growing broilers or rainbow trout. It was very clear from their comparison of three non-linear

response models versus the Broken Line model, that each of the non-linear curves was a better fit than the Broken Line. Among the non-linear models, the saturation kinetics and the four-parameter logistic functions gave the best fit, if the range in dietary amino acid concentration was very wide, i.e. from very deficient to adequate. For cases with a more narrow set of data closer to adequate supply, the exponential function gave a similar fit and has the advantage of a somewhat simpler equation, which facilitates handling and evaluation of data sets. Also, it has frequently been shown to give a good and realistic prediction of amino acid responses in monogastric animals. Therefore, exponential response curves as described by Rodehutsord and Pack (1999) or Gahl *et al.* (1994) will be used in the present survey to evaluate responses.

## Responses in Broilers

The basis of this calculation are data from dose-response experiments which show how broilers respond in growth rate, feed conversion and breast meat yield to increasing levels of dietary methionine, lysine or threonine. Drawing conclusions on economically optimum amino acid levels in feed requires a solid base of performance data from dose-response experiments carried out over a sensitive and practically relevant range of amino acid concentrations in the diet. The database of the present review meets these criteria and consists of nine dose-response studies with Met+Cys, six experiments with Lys, three studies on Thr for the grower and another two studies for the late finisher phase. Within each amino acid, all experiments were conducted within a similar range of dietary levels. Four to six graded levels of synthetic DL-methionine, L-lysine or L-threonine were added to a deficient basal diet. Data comprised mostly the grower, in some cases the finisher or late finisher period of male or mixed-sex broiler chickens of commercial strains or crosses within the overall range of 15–42 or 42–56 days of age. Table 25.1 gives details of the experimental designs.

**Table 25.1.** Design of amino acid dose–response experiments in broilers.

Reference	Sex <sup>a</sup>	Strain <sup>b</sup>	Trial period (days of age)	Diet composition <sup>c</sup>	Energy content (MJ ME kg <sup>-1</sup> )	Crude protein content (g kg <sup>-1</sup> )
<b>Methionine + cystine</b>						
Huyghebaert <i>et al.</i> (1994)	M	Ross	15–35	Sr, Soy	12.6	205
Huyghebaert <i>et al.</i> (1994)	M	Ross	15–35	Sr, Soy	12.6	242
Schutte and Pack (1995a)	50% M, 50% F	Ross	14–38	C, Soy	13.4	227
Schutte and Pack (1995b)	M	Cobb	15–33	W, C, Soy	13.2	218
Huyghebaert and Pack (1996)	M	Ross	14–35	Sr, C, P, Soy	12.4	233
Schutte and de Jong (1996)	M	Ross	10–35	Sr, C, P, Soy	13.6	217
Esteve-Garcia and Llaurodo (1997)	M	Ross	7–35	C, Soy	13.2 Grower, 13.6 Finisher	209 Grower, 202 Finisher
Mack <i>et al.</i> (1999)	M	Ross	20–40	C, Soy	13.2	190
Pack <i>et al.</i> (1999)	50% M, 50% F	Ross	21–42	C, Soy	13.0	209
<b>Lysine</b>						
Mack <i>et al.</i> (1999)	M	Ross	20–40	C, Soy	13.2	190
Mack <i>et al.</i> (1999)	M	ISA	20–40	C, Soy	13.2	190
Rostagno and Pack (1995)	M	Ross,	15–40	C, Sr, Soy	13.4	196
	M	Hu x Pe	15–40	C, Sr, Soy	13.4	196
Hoehler <i>et al.</i> (1999)	M	Ross	22–42	C, Sr, Soy	13.4	195
Hoehler <i>et al.</i> (1999)	M	Ross	22–42	C, Sr, Soy	13.4	195
<b>Threonine</b>						
Mack <i>et al.</i> (1999)	M	Ross	20–40	C, Soy	13.2	172
	M	ISA	20–40	C, Soy	13.2	172
Kidd and Kerr (1997)	M	Ross	30–42	C, Peanut	13.4	191
Kidd <i>et al.</i> (1999)	M	Ross x Hu	42–56	C, Peanut	13.4	171
Dozier and Moran (2000)	M	Ross	42–56	C, Peanut, CGM	13.4	177

<sup>a</sup>M, male; F, female.

<sup>b</sup>Hu, Hubbard; Pe, Peterson.

<sup>c</sup>W, wheat; Sr, sorghum; C, maize (maize); Soy, soybean meal; P, peas; CGM, maize gluten meal.

Ideally, if the general level of performance were similar across several experiments due to uniform dietary, environmental and genetic conditions, dose–response data could be combined directly for regression analysis. More realistically, the general level of performance was different between individual trials due to different dietary, environmental and genetic conditions across the experiments. However, the relative response in performance between the lowest and highest

level of Lys, Met+Cys or Thr was similar. This offered the opportunity to pool all dose–response data after transforming them to a relative scale. This step of data transformation may also be necessary for commercial operations when performance data originate from different production sites or when in-house trials were conducted under variable experimental conditions.

Pooled data were then subjected to exponential regression analysis. The best perfor-

mance as described by the maximum of the regression curve was set at 100%. The performance at each other tested amino acid level was expressed as a percentage of this maximum value. Each of the data points represents four to eight replicate pens of about 20–50 birds. Subsequently, the pooled data were subjected to exponential regression analysis. This gave one dose–response curve for each performance criterion describing the effect of graded dietary amino acid levels on relative performance.

Relative performance data were then transformed back to absolute values by setting the desired optimum performance at 100%. For economic calculations, maximum performance was set at 2000 g live weight gain, 1.8 kg feed kg<sup>-1</sup> of live weight gain and 160 g breast meat yield kg<sup>-1</sup> live weight except for the finisher studies in threonine, where performance settings were 1260 g gain (42–56 days) and 2.4 kg feed kg<sup>-1</sup> gain. Performance at all other points on the regression curve was calculated from the relative values at the specific amino acid content in the feed.

The feed cost per unit marketed product will decrease to the point where the relative increase in cost from adding one unit synthetic Met, Lys or Thr to the feed equals the relative improvement in animal performance, i.e. feed conversion and breast meat yield. In order to determine this point, performance data have to be combined with actual cost of both feed and supplemented Met, Lys or Thr. In case of cost of extra dietary amino acids in the diet, the assumption is made that these extra units enter the diet as a pure amino acid supplement. This would, of course, not be correct for the full range of dietary amino acid contents, but can be justified for about 10% of the level of tested amino acids in a commercial situation.

For the present examples, cost of basal feed without amino acid supplementation was set at US\$140 per metric tonne; DL-methionine, L-lysine-HCl and L-threonine were set at US\$2.50, 2.00 and 3.30 kg<sup>-1</sup>, respectively.

The cost per kilogramme of feed and the economically relevant performance indicators 'feed cost per kg live weight gain' and 'feed cost per kg breast meat' were calculated for the dietary amino acid levels covered in the

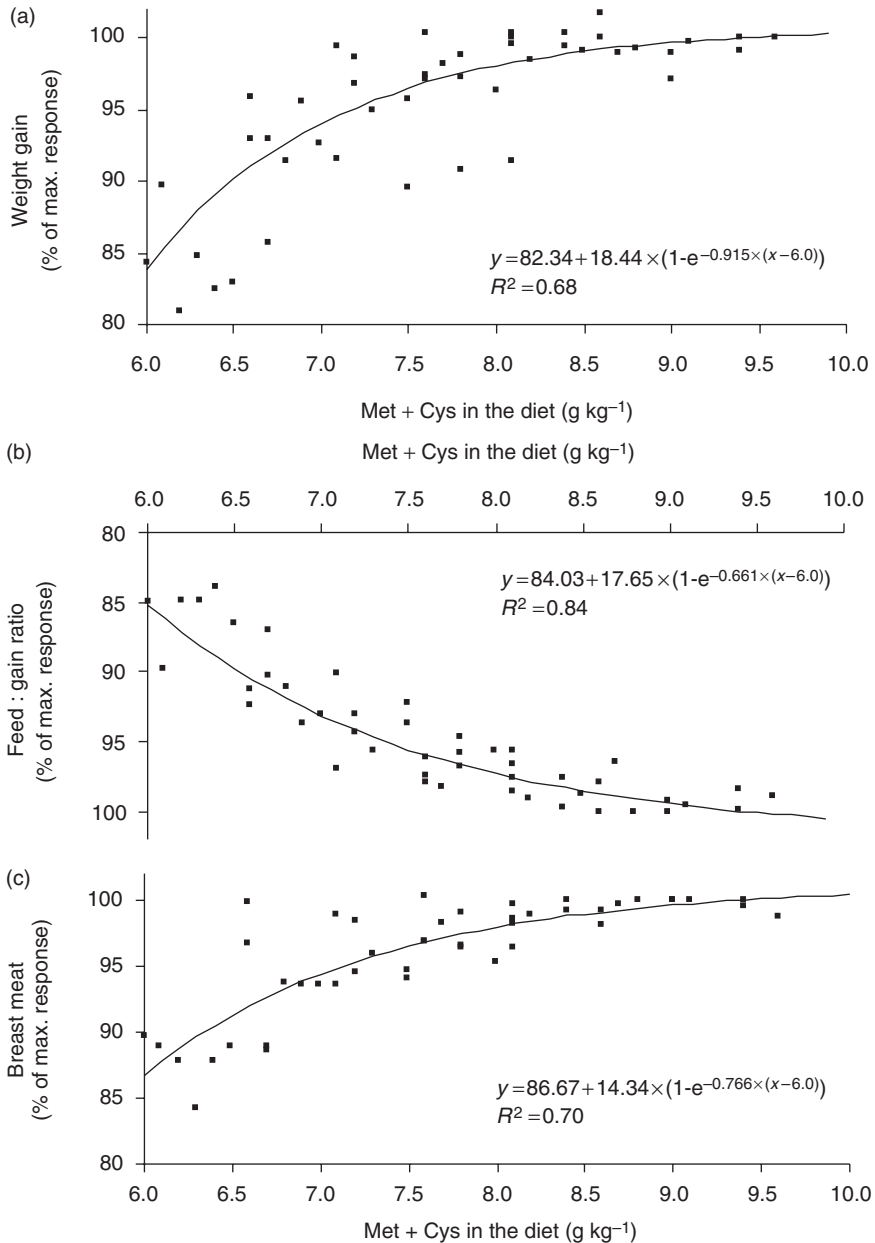
experiments based on regression curves for performance and the aforementioned price assumptions. The following equations were used:

- Cost kg<sup>-1</sup> feed = basal feed cost + ((cost/unit supplemented test amino acid – cost/unit basal feed) × supplemented amino acid units)
- Feed cost kg<sup>-1</sup> live weight gain = (kg feed kg<sup>-1</sup> live weight gain) × cost kg<sup>-1</sup> feed
- Feed cost kg<sup>-1</sup> breast meat = (Feed cost kg<sup>-1</sup> live weight gain) / (kg breast meat kg<sup>-1</sup> live weight gain).

### Methionine+cystine in broilers

Data from the present studies, which were transformed to a relative scale, show a fairly consistent response in bird performance to increasing dietary levels of the respective amino acid. Exponential regression analysis describes the pooled dose–response relations well (Fig. 25.2). Given the very diverse nature of the experiments, the consistency of the responses especially in feed conversion and breast meat yield is striking. Over the dietary range of Met+Cys from about 6.5 to 9.5 g kg<sup>-1</sup> the relative responses in all three parameters were in the range of 15–20%. The steepness of the response curve, however, was higher for weight gain, which means that the asymptotic maximum was approached at a lower dietary Met+Cys content.

Under the given set of performance and price conditions, feed cost kg<sup>-1</sup> live weight gain reached a minimum at a dietary concentration of 9.0 g kg<sup>-1</sup> Met+Cys (Fig. 25.3). The shape of the economic response curve is determined, first, by the decreasing feed to gain ratio which approached its asymptotic minimum (i.e. maximum in the relative curve of Fig. 25.2) with rising dietary amino acid concentration, and secondly, by the linearly increasing feed cost with higher dietary Met+Cys content due to the cost of the supplemental amino acid. The response in feed cost per kg breast meat to rising amino acid levels was not only affected by the feed to gain ratio, but also by the increasing yield of breast meat as percentage of live weight. This

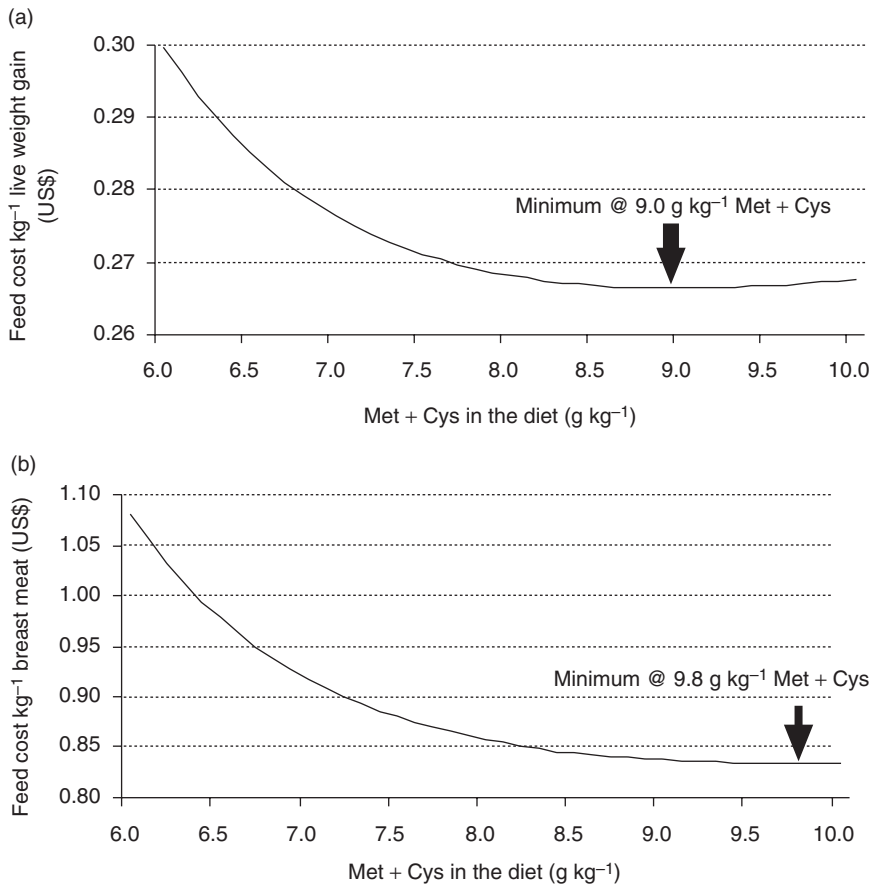


**Fig. 25.2.** Relative responses to graded dietary Met+Cys levels (nine broiler experiments, approx. 15–40 days of age). (a) Weight gain; (b) feed to gain ratio; (c) breast meat yield (% of live weight).

extra benefit included in the economic calculation shifted the optimum dietary Met+Cys concentration to 9.8 g kg<sup>-1</sup>; i.e. 0.8 g kg<sup>-1</sup> higher than with only feed cost per kg live weight gain responses considered.

### Lysine in broilers

Lysine responses, although with less single data points, give a similar picture in that the responses in all three parameters are clearly



**Fig. 25.3.** Effect of dietary Met+Cys content on economics. (a) Feed cost kg<sup>-1</sup> live weight gain; (b) feed cost kg<sup>-1</sup> breast meat yield.

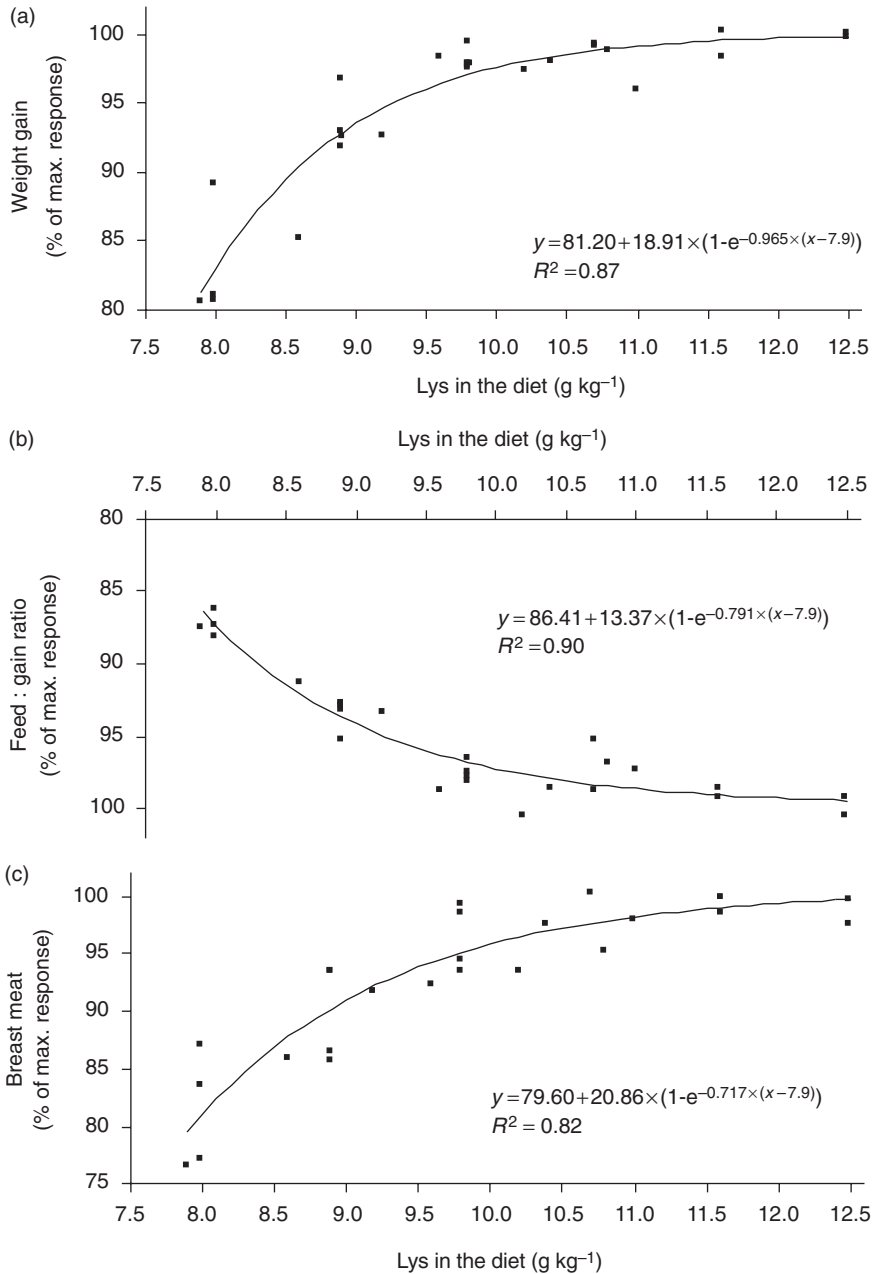
non-linear and the curves for feed conversion and breast meat are flatter than the growth response (Fig. 25.4).

Interestingly, the economic optima for the two situations are even more apart than in Met+Cys (Fig. 25.5). Feed cost per kg live weight gain is minimized at 10.3 g kg<sup>-1</sup> lysine, whereas the minimum cost kg<sup>-1</sup> breast meat occurs at 11.6 g kg<sup>-1</sup>, which is a difference of more than 10%, thus quite substantial from an industrial point of view. This demonstrates the relevance of a proper definition of the overall production goal.

The economic calculations above are only valid for the present input prices. For demonstration, Fig. 25.6 shows the corresponding economic responses for a set of three different

cost levels per ton of feed. Compared to the level of US\$140 per ton which was used so far, a lower or a higher level of US\$120 or 160 per ton have a certain effect. With a higher feed cost, higher dietary lysine levels are more economical, because less of the expensive feed is consumed per unit of gain or breast meat yield. However, the differences are fairly moderate, being in the range of +0.1 g kg<sup>-1</sup> dietary lysine per US\$10 increase in feed cost per ton.

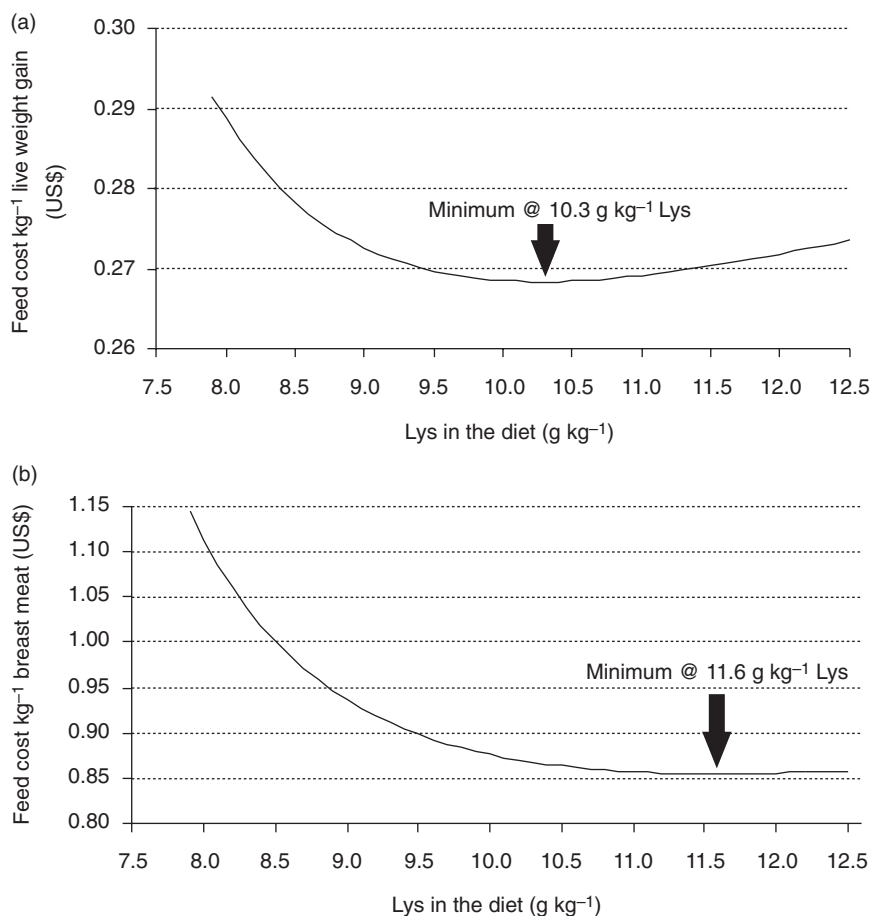
Likewise, the economic optimum levels are only slightly altered by price changes of supplemented amino acids. For example, a significantly varying price for L-lysine-HCl of US\$2.0, 2.5, or 3.0 kg<sup>-1</sup> results in economic optimum levels for the production goal breast meat of 11.9, 11.6 and 11.4 g kg<sup>-1</sup> of Lys in



**Fig. 25.4.** Relative response to graded dietary lysine levels (six broiler experiments, approx. 20–40 days of age). (a) Weight gain; (b) feed to gain ratio; (c) breast meat yield (% of live weight).

the diet, respectively. This means that the resulting change in the dietary optimum is far less than the change of nutrient cost as an input variable. Similarly, a greatly varying price

for DL-Met of US\$2.5, 3.0 or 3.5 kg<sup>-1</sup> results in economic optimum levels for cost of breast meat of 9.7, 9.5 and 9.3 g kg<sup>-1</sup> of Met+Cys in the diet, respectively (data not shown).



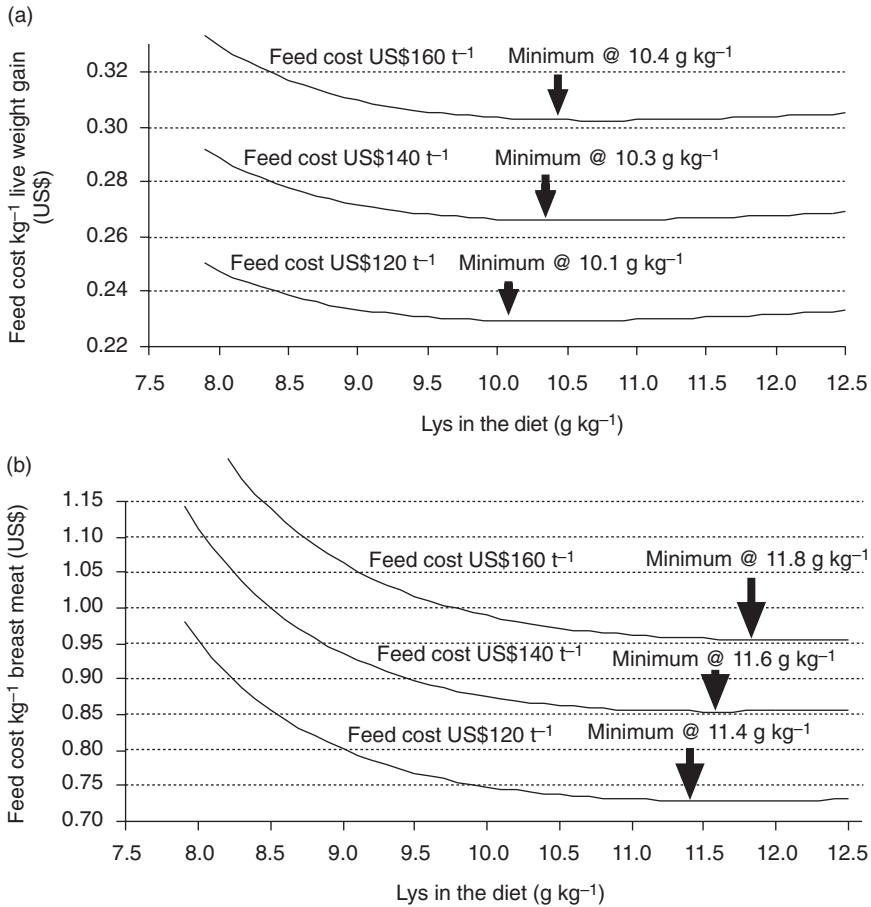
**Fig. 25.5.** Effect of dietary lysine content on economics. (a) Feed cost kg<sup>-1</sup> live weight gain; (b) feed cost kg<sup>-1</sup> breast meat yield.

### Threonine in broilers

For the essential amino acid threonine, there are not as much data available for response modelling. On the other hand, the commercial interest has increased considerably due to the availability of larger quantities of industrial L-threonine. Therefore, Fig. 25.7 displays another set of three experiments combined on a relative scale. Again, responses are non-linear and exponential functions fit the data well. Economic evaluations of these responses show a minimum feed cost per kg live weight gain at about 6.6 g kg<sup>-1</sup> Thr with small variation due to absolute feed cost level (Fig. 25.8). With breast meat being set as the production goal, there is a shift to a higher optimum of about 7.0 g kg<sup>-1</sup> dietary Thr.

For comparison, Fig. 25.9 reports a combination of two late finisher experiments from 42 to 56 days of age. With good agreements across trials, the fairly large biological responses are evaluated financially (Fig. 25.10), which is displayed for feed cost kg<sup>-1</sup> breast meat only. The effect of feed cost on the most profitable dietary Thr content is again rather small, with optima around 6.9 g kg<sup>-1</sup>. Surprisingly, the dietary optimum is virtually identical with the optimum derived from the grower data (see Fig. 25.8). This, although concluded from different trials, would indicate the increasing importance of Thr for heavier birds, which is also underlined by the strong response in breast meat yield. Figure 25.10b looks into the effect of changing prices of L-Thr, covering a large range from





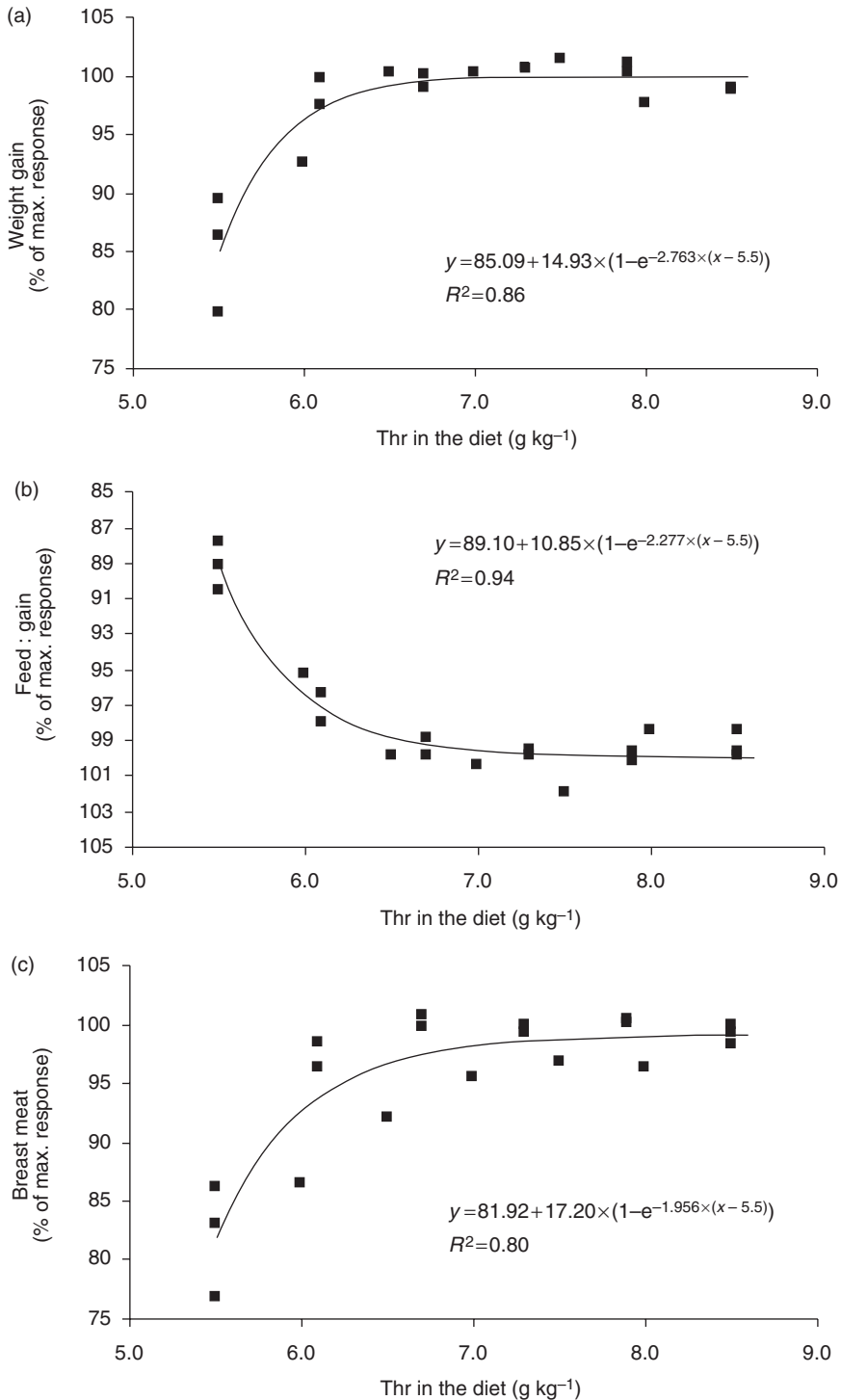
**Fig. 25.6.** Effects of varying feed costs on economic optimum dietary lysine content. (a) Cost kg<sup>-1</sup> live weight gain; (b) cost kg<sup>-1</sup> breast meat yield.

US\$2.80 to US\$3.80 kg<sup>-1</sup>. The most profitable dietary Thr level, however, is almost unchanged (7.0 g kg<sup>-1</sup> down to 6.8 g kg<sup>-1</sup> total Thr) over such a broad range of input prices, indicating the favourable economics of even small incremental changes in bird performance.

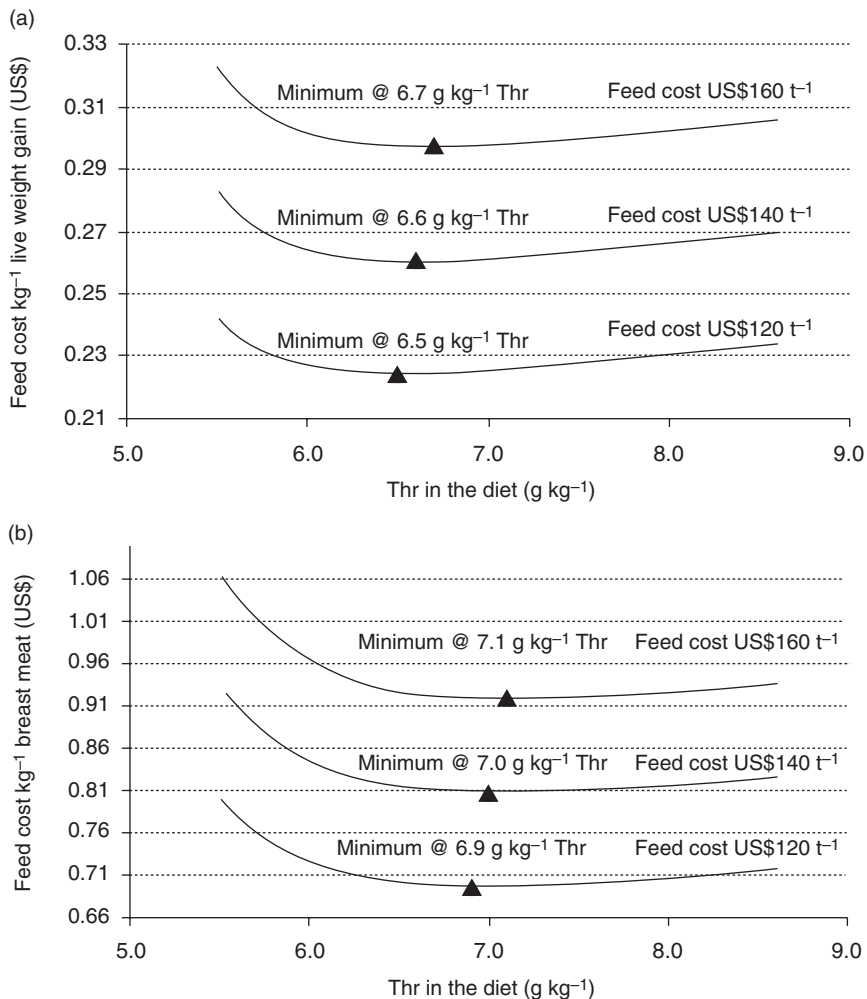
#### Implications for company management and broiler feed formulation

Feed represents over 60% of the overall production costs in the broiler industry. However, one has to keep in mind that lowering feed cost per ton does not automatically mean higher profitability. Figures 25.11 and 25.12

give examples of how different Met+Cys and Lys levels each affect costs per kg of feed, costs per kg of bird and costs per kg of breast meat produced. For comparison, the present NRC (1994) recommendations for growing broilers state 7.2 g kg<sup>-1</sup> Met+Cys and 10.0 g kg<sup>-1</sup> Lys. Despite the fact that feed costs increase due to higher supplementation of amino acids when exceeding the NRC levels considerably, feed costs per kg bird, and even more feed costs per kg breast meat, decrease significantly, hence increasing the overall profit of the broiler operation. These examples indicate that focusing solely on low feed cost can substantially reduce the overall profit of a poultry integration.



**Fig. 25.7.** Relative responses to graded dietary Thr levels (three broiler grower experiments, approx. 20–40 days of age). (a) Weight gain; (b) feed to gain ratio; (c) breast meat yield (% of live weight).



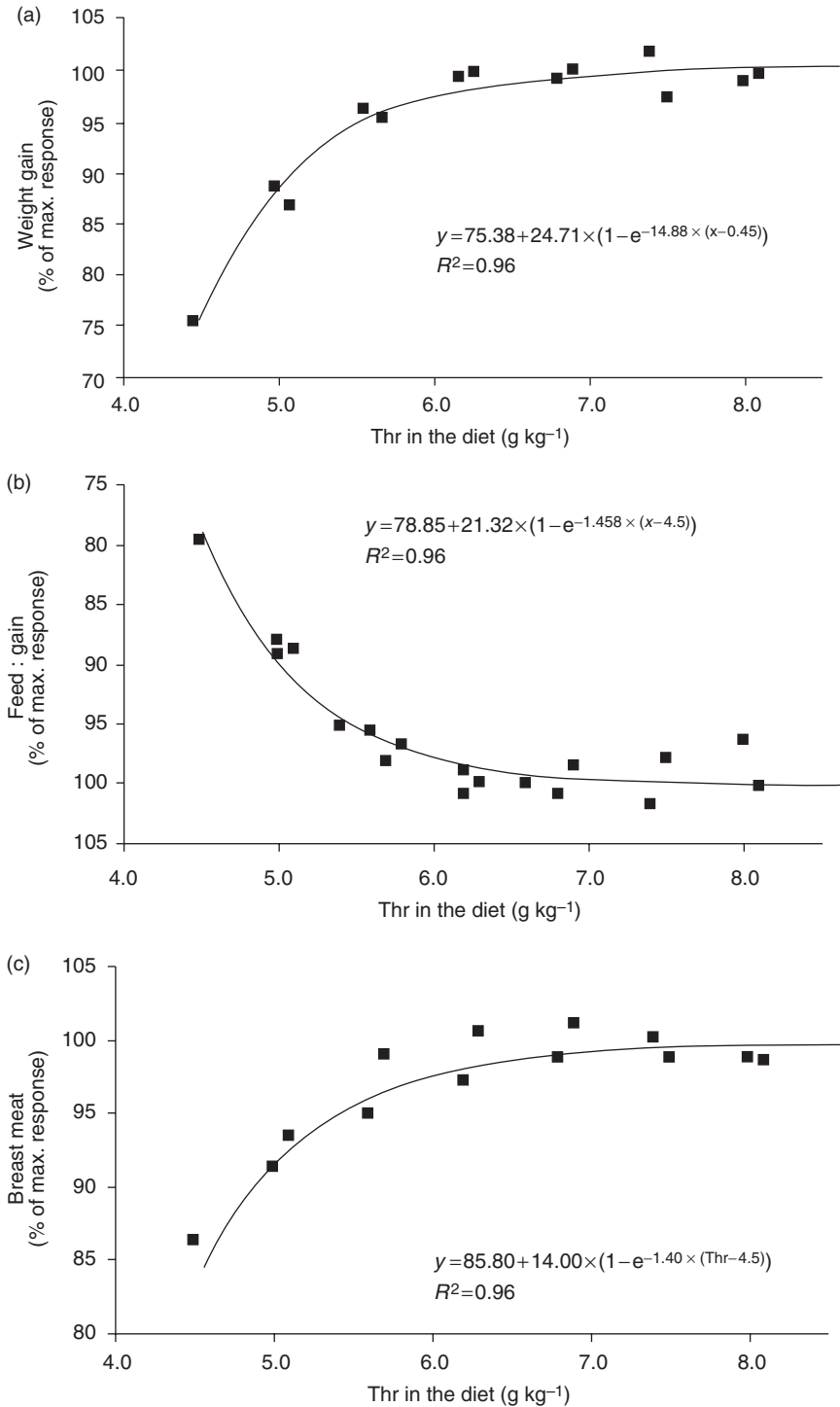
**Fig. 25.8.** Effect of dietary Thr content in growing broilers 20–40 days of age at different feed cost. (a) Feed cost kg<sup>-1</sup> live weight gain; (b) feed cost kg<sup>-1</sup> breast meat yield.

### Responses in Peking Ducks

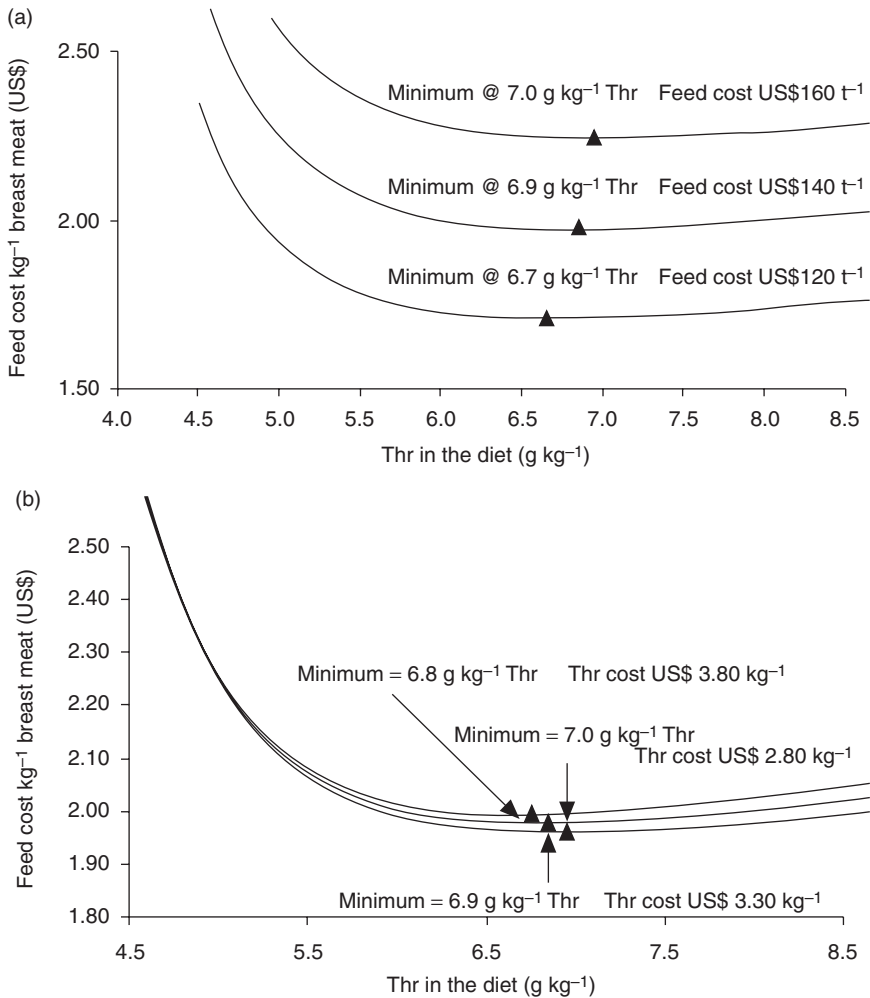
Over the last decade, the market for poultry meat has grown considerably, particularly for duck meat. Weight gain and feed conversion potential of the Peking duck has improved substantially. In 1998, ducks produced in Germany achieved a body weight of 3650 g and a feed conversion ratio of 2.10 kg kg<sup>-1</sup> within only 7 weeks (Bons, 2000). Breast meat yield as a percentage of carcass increased from 9.0% to 16.6%. This enormous genetic progress, especially in meat or protein deposition, should be reflected in feed

formulation, particularly in adjusted amino acid supply. Published information on this topic is scarce, therefore a set of experiments conducted at the University of Halle, Germany (Bons, 2000), is reported here in order to put them into perspective with the concept developed for the broiler data.

The biological data obtained from this project were recalculated, including important economic parameters such as cost of feed and amino acids to predict how amino acid supply might affect overall profitability. In each experiment, a total of 240 male 21-day-old ducklings were distributed to six dietary treatments includ-



**Fig. 25.9.** Relative responses to graded dietary Thr levels (two broiler late finisher experiments, approx. 42–56 days of age). (a) Weight gain; (b) feed to gain ratio; (c) breast meat yield (% of live weight).

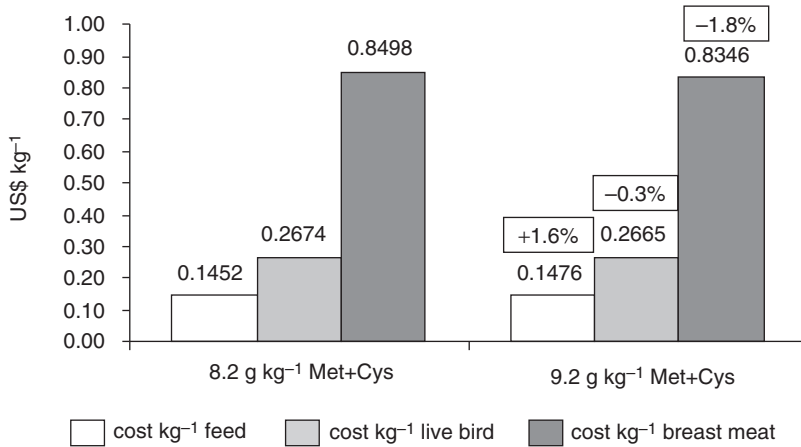


**Fig. 25.10.** Effect of increasing Thr levels on feed cost kg<sup>-1</sup> breast meat in late finishing broilers 42–56 days of age at changing prices for feed or L-Thr. (a) Feed cost kg<sup>-1</sup> breast meat, feed cost set at US\$120/140/160 ton<sup>-1</sup>. (b) Feed cost per kg<sup>-1</sup> breast meat, cost of supplemental L-Thr set at US\$2.80/3.30/3.80 kg<sup>-1</sup>.

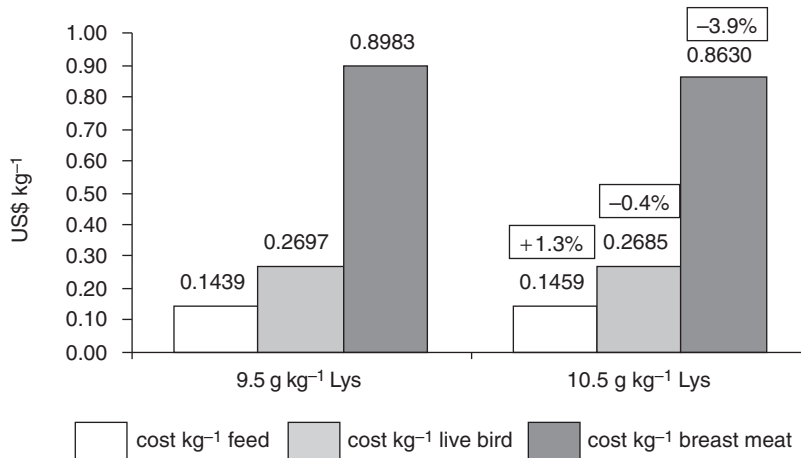
ing one basal diet and five diets with graded inclusion levels of the respective amino acid. The diets were generally maize–wheat–soybean meal-based. Crude protein and energy content of the grower diets were about 205g kg<sup>-1</sup> and 12.6 MJ ME kg<sup>-1</sup>, respectively.

As shown in Figs 25.13–25.18, birds consistently responded to increasing dietary amino acid content, confirming the deficiency of the basal diets for the respective amino acid. Following the ‘law of diminishing returns’, performance improved non-linearly with increas-

ing supplementation level. The magnitude of the responses was different between the trials, indicating a varying degree of deficiency of the basal diets. The strongest increase in weight gain due to supplementation was found in the Lys trials, whereas growth rate in the Met trial showed only a slight effect. However, whereas the basal diet was only slightly deficient in ducks aged 21–42 days with respect to weight gain, the asymptote for feed conversion ratio was not even achieved at the highest Met+Cys level (Fig. 25.13).



**Fig. 25.11.** Effect of different dietary Met+Cys levels on overall profitability in an integrated broiler operation.



**Fig. 25.12.** Effect of different dietary lysine levels on overall profitability in an integrated broiler operation.

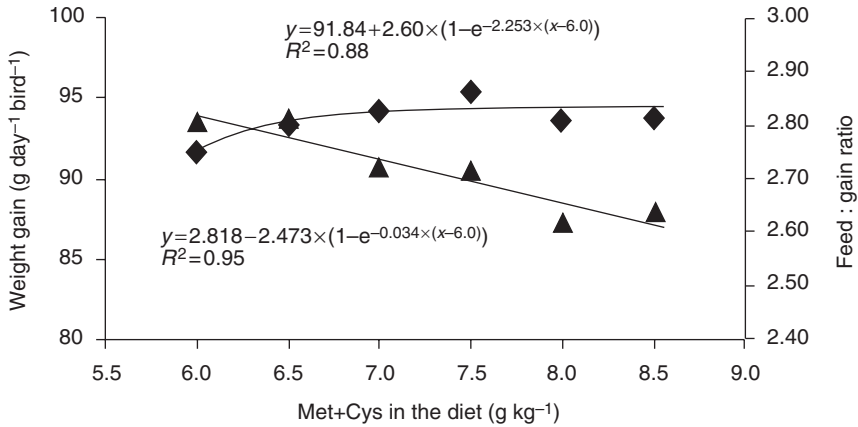
The results of the carcass evaluation performed with birds in the Met+Cys experiment are presented in Fig. 25.14. There was a relevant response to dietary Met+Cys, however, with some variation resulting in the weakest  $R^2$  of 0.56 within this data set.

Responses to Lys were very consistent with the exponential response functions (Figs 25.15 and 25.16). It is important to note that, as opposed to the responses in broilers, the feed conversion response in ducks was steeper than the growth response. In other words, further increases in growth at intermediate Lys levels (7.0–9.0 g kg<sup>-1</sup>) were triggered by extra feed intake without changing the feed : gain

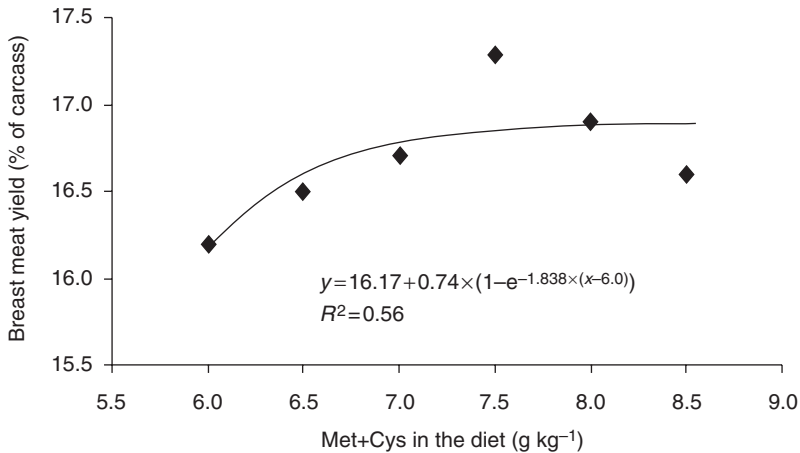
ratio. Breast meat responses appear closely correlated to growth rate as judged from the shapes of the corresponding curves.

Thr in the diet had only a small effect on growth rate, but a substantial effect on feed conversion (Fig. 25.17) and breast meat yield (Fig. 25.18).

The economics were determined by a calculation similar to the analysis of the broiler data. To calculate feed cost per kg weight gain or per kg breast meat, feed conversion ratio was multiplied with the feed cost assuming a grower feed price of US\$170.00 t<sup>-1</sup>. Prices of supplemental Lys-HCl, Met and Thr were kept at 2.50, 2.00 and US\$3.30 kg<sup>-1</sup>, respectively.



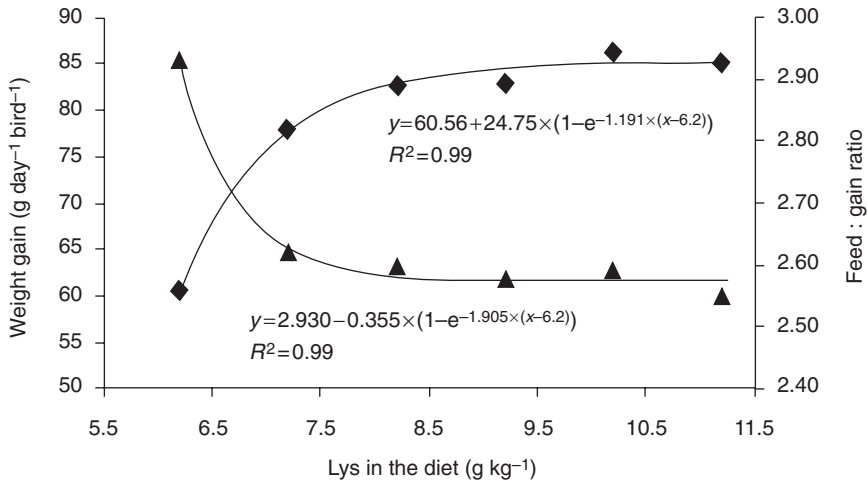
**Fig. 25.13.** The effect of graded levels of dietary Met+Cys on weight gain (◆) and feed conversion ratio (▲) in Peking ducks 21–49 days of age. (Bons, 2000.)



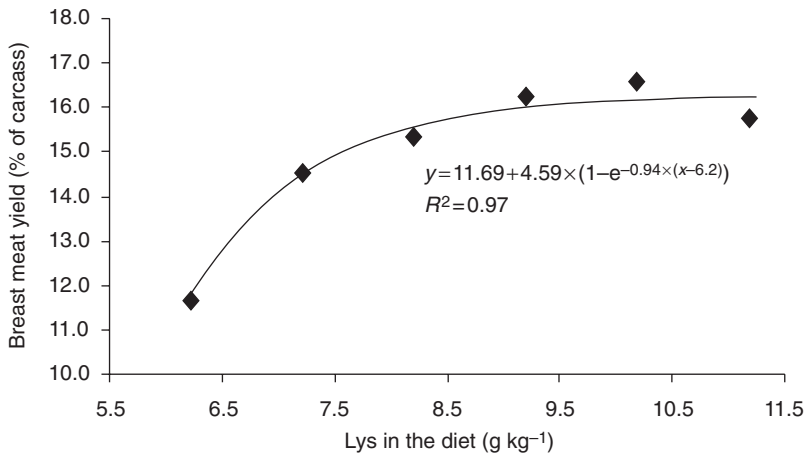
**Fig. 25.14.** The effect of graded levels of dietary Met+Cys on breast meat yield (% of carcass) in Peking ducks 21–49 days of age. (Bons, 2000.)

The results shown in Fig. 25.19 give an impression of how different the economic optima can be depending on the limiting amino acid and the parameters included in the calculation. For Met+Cys, the continuous improvement in feed conversion even beyond the dietary levels in the test diets prevents the determination of a definite optimum, disregarding whether cost per kg gain or cost per kg breast meat is used. A dietary content of Met+Cys higher than 8.5 g kg<sup>-1</sup> is considerably higher than the NRC (1994) recommended level of 5.5 g kg<sup>-1</sup> for 2–7 weeks of age.

The economics of Lys vary significantly with the response parameters (Fig. 25.19b). Given the steep response in feed conversion, the minimum feed cost per kg live weight gain would occur at only 7.8 g kg<sup>-1</sup>, while the extra responses in breast meat yield will minimize feed cost kg<sup>-1</sup> breast meat at 9.5 g kg<sup>-1</sup> dietary Lys. This is a very substantial difference when specifying dietary target values, and both values are much higher than the NRC (1994) figure of 6.5 g kg<sup>-1</sup>. Even more, the extra growth rate at dietary levels beyond those that minimize feed cost per kg



**Fig. 25.15.** The effect of graded levels of dietary Lys on weight gain (◆) and feed conversion ratio (▲) in Peking ducks 21–49 days of age. (Bons, 2000.)



**Fig. 25.16.** The effect of graded levels of dietary Lys on breast meat yield (% of carcass) in Peking ducks 21–49 days of age. (Bons, 2000.)

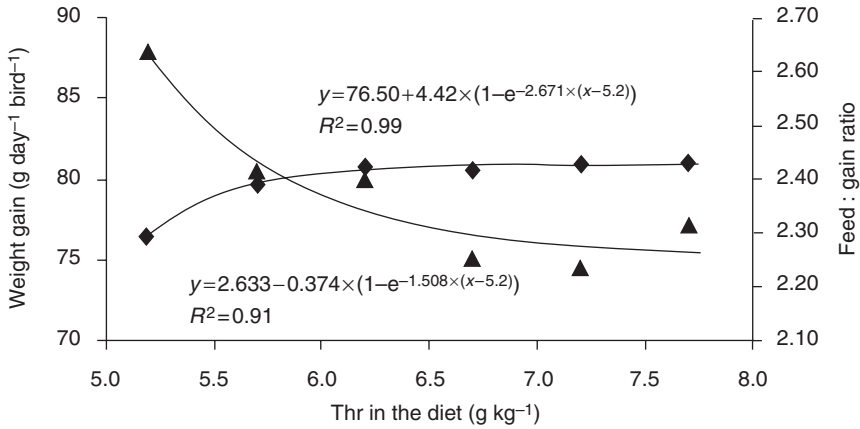
live weight gain would be expected to give additional profit due to higher weight at a given age at kill.

Finally, Thr economics are less conflicting to interpret. Curves reported in Fig. 25.19c show again that the optimum dietary content to minimize feed cost per kg breast meat (7.2 g kg<sup>-1</sup> Thr) is higher than to minimize feed cost per kg live weight gain (6.8 g

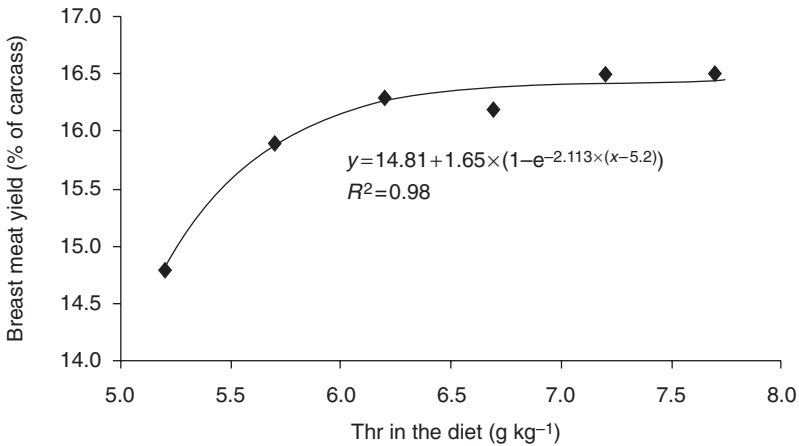
kg<sup>-1</sup>), but the difference is less than with Lys. For Thr, NRC (1994) does not state a recommendation.

Overall, the response data in Peking ducks show many similarities to the far more extensive data available for broilers. It appears that the exponential functions give an acceptable fit and allow further processing of predicted results towards economics.





**Fig. 25.17.** The effect of graded levels of dietary Thr on weight gain (◆) and feed conversion ratio (▲) in Peking ducks 21–49 days of age. (Bons, 2000.)

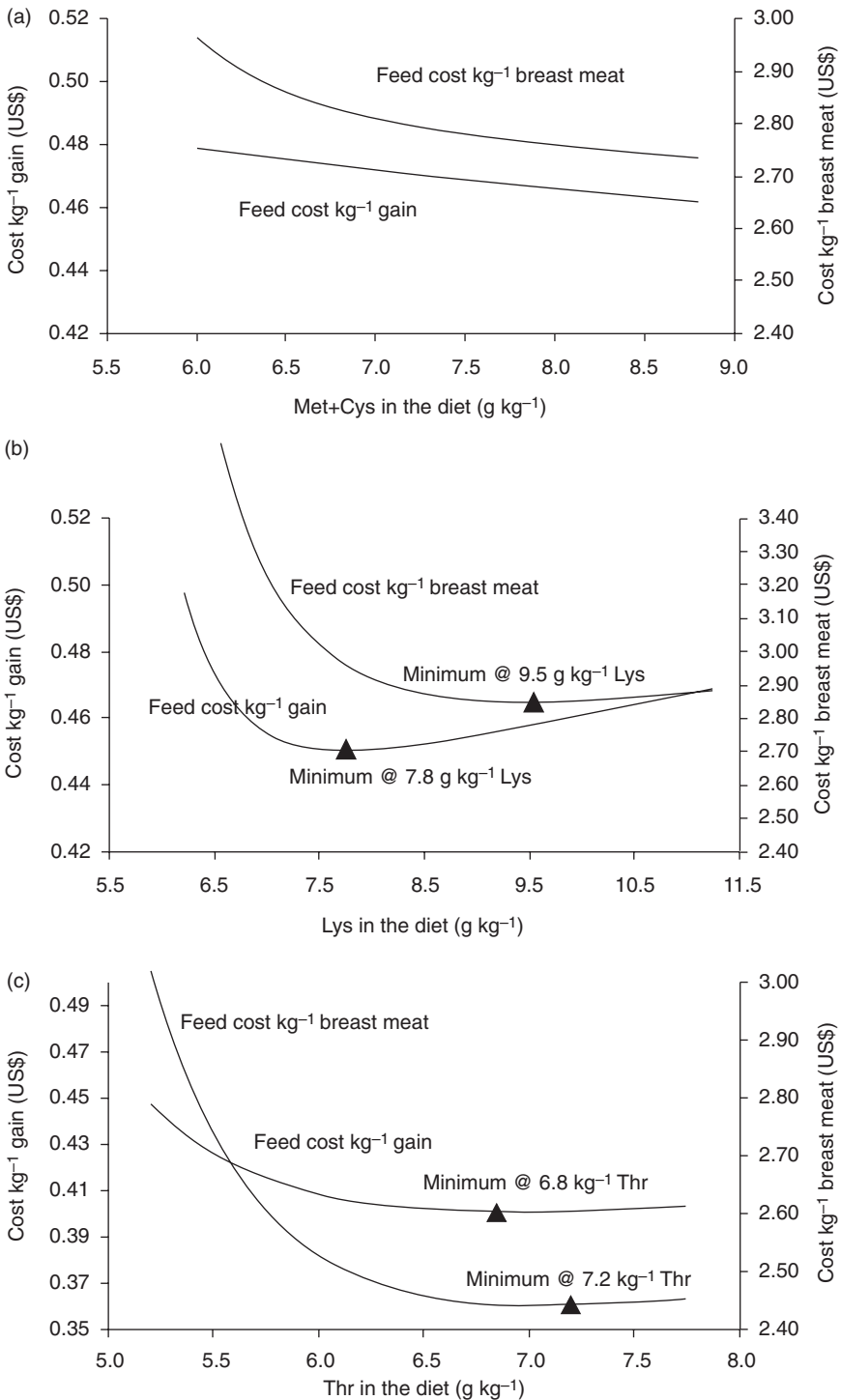


**Fig. 25.18.** The effect of graded levels of dietary Thr on breast meat yield (% of carcass) in Peking ducks 21–49 days of age. (Bons, 2000.)

### Responses in Turkeys

Weight gain and feed conversion potential of turkeys has also developed enormously during the last 20 years and as a result, questions about changes in the turkey's demand for dietary amino acids arose. With a focus on the response to dietary Lys level, a series of trials has been conducted at the University of Halle, Germany, with male BUT Big 6 turkeys over various age periods. The studies reported by Lemme *et al.* (2002a) deal with the periods of 5–8 and 13–16 weeks of age, whereas

Lehmann *et al.* (1996) worked on the periods of 9–12 and 17–20 weeks of age. In each trial period, six levels of dietary Lys were tested. Weight gain and feed conversion rate improved in every treatment, and the responses to Lys could be fitted very well by exponential regression functions as previously shown for broilers. For space reasons, only the results for grower and finisher diets are reported. Unfortunately, there is a lack of acceptable data on amino acids other than Lys; therefore only this amino acid will be covered in this review.

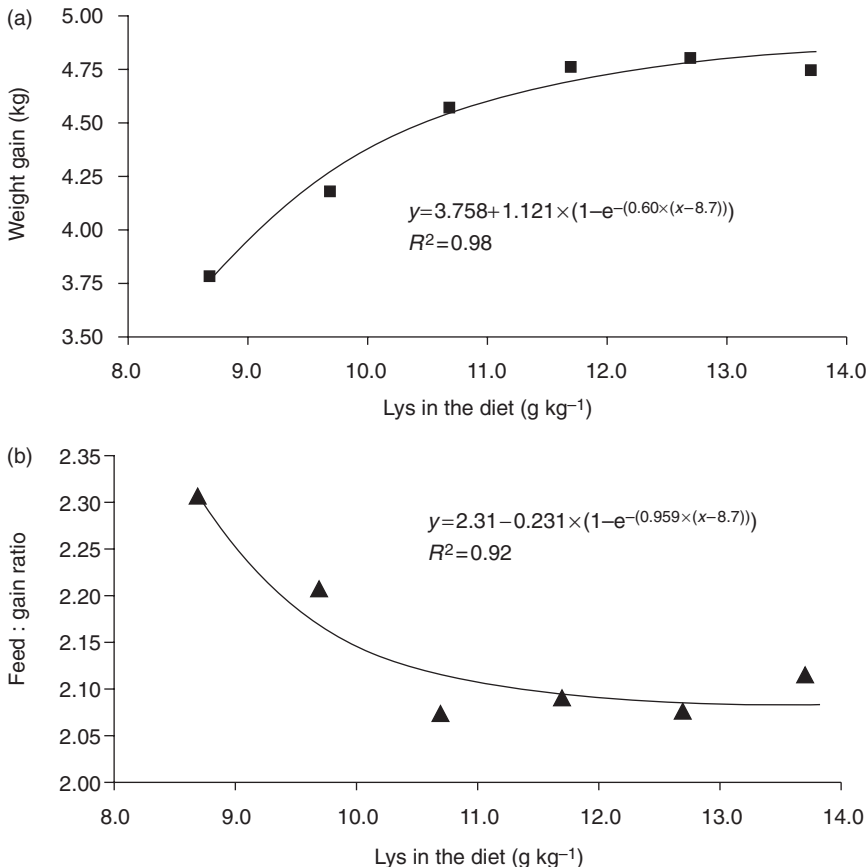


**Fig. 25.19.** The impact of graded levels of dietary amino acids on feed cost per kg weight gain and feed cost per kg breast meat in Peking ducks 21–49 days of age. (a) Met+Cys; (b) Lys; (c) Thr.

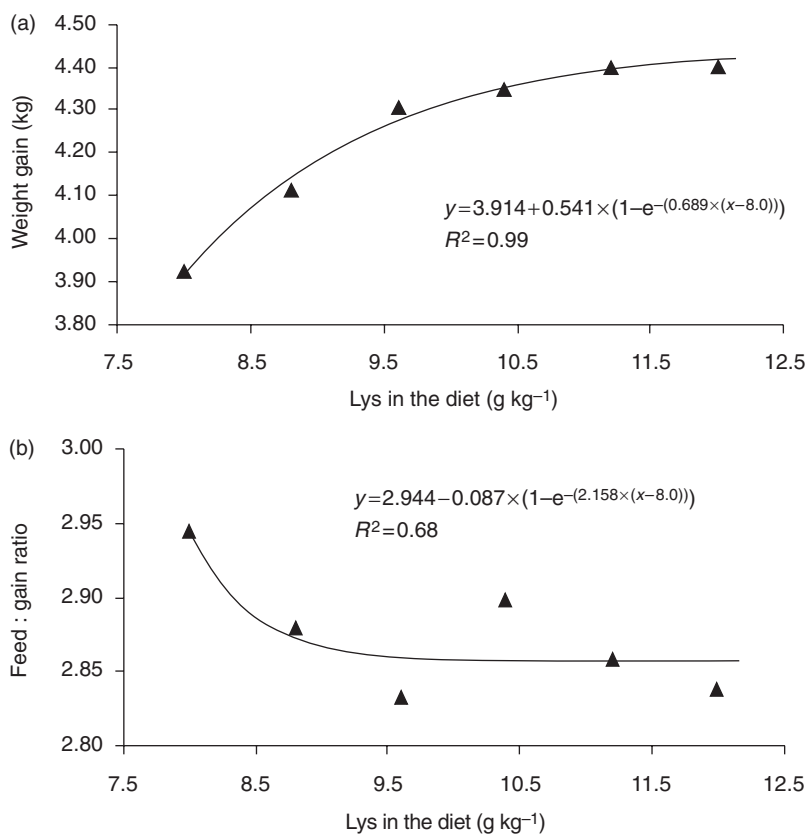
The grower results are summarized in Fig. 25.20, and finisher data for the 13–16 and 17–20 week periods are given in Figs 25.21 and 25.22. All three experimental data sets agree in the strong and very consistent response in growth rate, that always gave a better fit of the experimental functions ( $R^2 \geq 0.98$ ) than the more variable feed conversion data. Variability in the latter parameter indicates less sensitivity in this criterion, which may be due to two factors: first, feed losses may be harder to avoid in larger poults, or, secondly, responses were flat beyond an intermediate Lys level. This would mean in return that extra growth responses at higher Lys levels were a function of higher feed intake at largely unchanged feed conversion.

For the economic assessment, the different response pattern of growth versus feed conversion and the lack of good carcass composition data require some reconsideration of the economic parameters optimized for use with broilers. The calculation of feed cost per kg live weight gain would not be expected to give a meaningful result as such. In case there are further growth responses at higher dietary amino acid levels, these are also likely to trigger corresponding increases in breast meat proportion (see limited data reported by Lehmann *et al.*, 1996, 1997).

Another parameter was introduced by Petri *et al.* (2001): the calculation of a 'gross margin', i.e. the margin over feed cost, calculated as the difference between income



**Fig. 25.20.** Responses of growing turkeys to dietary Lys (male turkeys, 9–12 weeks of age, Lehmann *et al.*, 1996). (a) Weight gain; (b) feed to gain ratio.



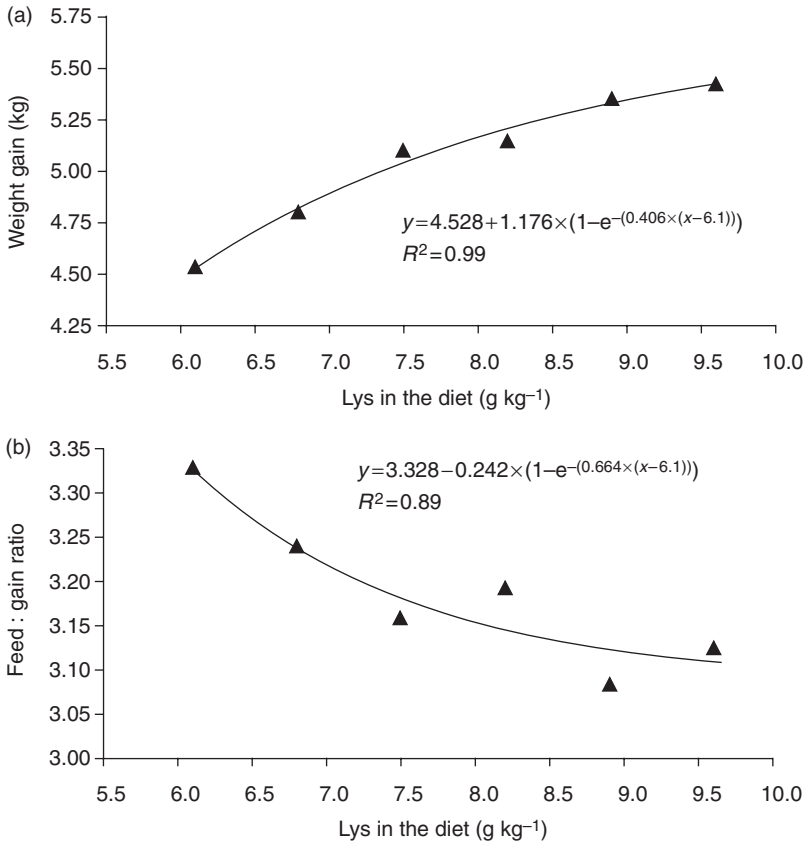
**Fig. 25.21.** Responses of growing turkeys to dietary Lys (male turkeys, 13–16 weeks of age, Lemme *et al.*, 2000a). (a) Weight gain; (b) feed to gain ratio.

from live body weight minus the cost of the feed consumed. Using feed cost figures of approximately US\$215/190/198 ton<sup>-1</sup>, a reduced price of US\$1.73 kg<sup>-1</sup> of L-lysine-HCl, and a return of US\$1.05 kg<sup>-1</sup> of live turkey (Petri *et al.*, 2001, reflecting a contemporary Western European scenario), one can conduct this exercise with the results reported in Fig. 25.23.

It has to be noticed that the feed cost kg<sup>-1</sup> gain remained rather unaffected by dietary Lys level over all periods calculated. The mathematical minimum shown in the figures is only slightly different from the values obtained with higher or lower lysine levels. This confirms that feed cost per kg gain alone may not be a meaningful tool to determine the optimum Lys content of a turkey

feed. The calculations for gross margin indicate a stronger economic sensitivity and points to substantially higher values for the recommended lysine level in all periods evaluated. In fact, in two cases the predicted maximum gross margin is close to the highest dietary concentration tested, and in the finisher period (17–20 weeks of age) even beyond that level, i.e. 10.4 g kg<sup>-1</sup> Lys being predicted versus 9.6 g kg<sup>-1</sup> having been the highest level fed in the trial. This conclusion has to be handled with some care and requires more data.

Compared to NRC (1994) recommendations for growing turkeys, all figures derived from gross margin calculations are significantly higher, probably reflecting the continuous genetic progress in this species.



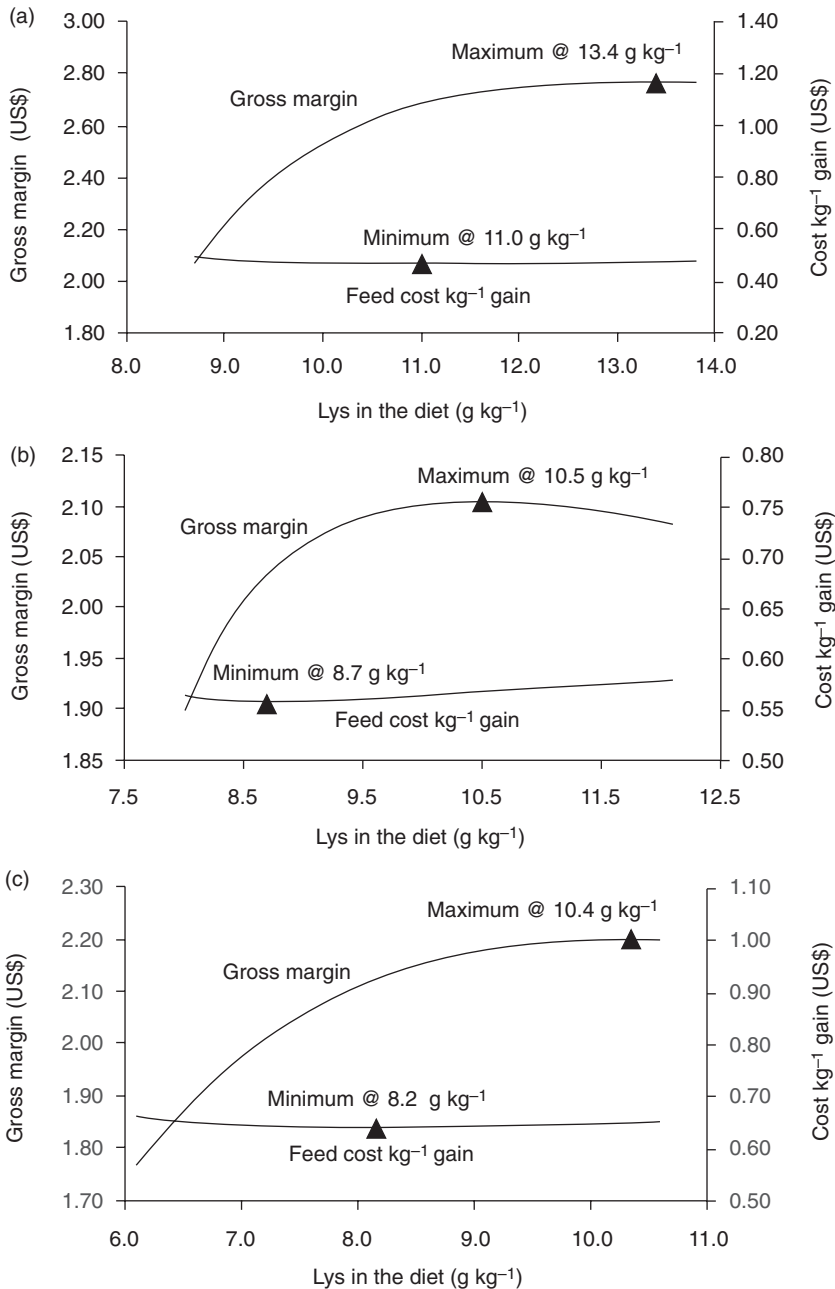
**Fig. 25.22.** Responses of finishing turkeys to dietary Lys (male turkeys, 17–20 weeks of age, Lehmann *et al.*, 1996). (a) Weight gain; (b) feed to gain ratio.

## Conclusions

The present review focuses on the link between empirical response data obtained in university or even field studies and a conscious decision-making process with best economics as the ultimate objective. This largely empirical approach has the advantage of being truly based on biological results in the target species, and suffers at the same time from the disadvantage of being fully applicable only to the genetics, feed and environment present at the time. However, over the multitude of studies reported here even across different poultry species, the excellent usefulness of a non-linear (in this case exponential) response model to analyse the results has been demonstrated. It is a good and robust means to fit flock

results (being a mean of many birds), thus being a physiological reflection of the law of diminishing returns.

With biologically meaningful response functions for the key production parameters in hand, it is then only a small step to set up calculations that factor in the major inputs and outputs. For simplicity, only growth rate, feed conversion and, as far as available, breast meat yield as the key indicators have been included. This neglects other traits potentially sensitive to nutrient supply such as immune status and health, feathering or uniformity of the flock. Nevertheless, the calculations and underlying conceptual thoughts may well be used for commercial purposes in poultry production. To overcome the limitations that single experiments and calculations with a single



**Fig. 25.23.** Effect of dietary Lys on economics in growing/finishing turkeys. (Petri *et al.*, 2001.) (a) 9–12 weeks of age; (b) 13–16 weeks of age; (c) 17–20 weeks of age.

set of prices will always have, it is important to develop models that help to simulate and predict responses and their economics under variable conditions. Although being very suc-

cessful in pig nutrition, it appears that there is still some way to go in growing poultry before models arrive at the level of widespread industry use. It seems desirable to design non-

linearity into equations and avoid over-complication in economic calculations and practical handling of such tools.

Overall, the critical importance of dietary essential amino acids for production economics in poultry is obvious. Given the small margins available to producers in this agricultural business, much attention has to be placed on an economically optimized feed formulation. This, of course, does not stop with setting dietary specifications depending on production goal, but must include proper assessment of ingredient variability and amino acid digestibility in natural feedstuffs to name only two important elements in the overall equation. Continuous research updates addressing developments in genetics and management will be needed to ensure best economics in a very competitive sector.

### Summary

This chapter highlights the economic significance of statistical assessment of amino acid dose-response data with regard to different production goals. Based on empirical results obtained in a total of 25 dose-response studies done in growing broilers, ducks and turkeys, the most important essential amino acids methionine, lysine and threonine are discussed with a view to deriving most profitable dietary specifications for a poultry integration.

Non-linear response functions such as the exponential model give a good fit to the responses in growth rate, feed to gain ratio and breast meat proportion as affected by variable amino acid contents of the diet. In all studies reported, substantially enhanced performance resulted from increases in the first-limiting amino acid. With common prices of feedstuffs and supplemental amino acids, feed cost per kg live weight or per kg breast meat can be established as relevant economic indicators for most profitable dietary amino acid specifications. If carcass quality as determined by breast meat yield is important, which is usually the case for integrated producers operating their own processing facilities, then it will virtually always be profitable to exploit the performance potential of the bird to a greater extent.

In general, the process of deciding on raw material quality and nutrient specifications in feed should start with defining the properties of the desired product. This chapter demonstrates large differences in economically optimum dietary amino acid levels depending on the product to be marketed. These optimum levels are rather robust concerning differences in feed cost or cost of supplemented amino acids. This approach may well be extended to other nutrients and is meant to serve as a general tool to decide about diet specifications in a meaningful way.

### References

- Baker, D.H. (1986) Problems and pitfalls in animal experiments designed to establish dietary requirements for essential nutrients. *Journal of Nutrition* 116, 2339–2349.
- Berndtson, W.E. (1991) A simple, rapid and reliable method for selecting or assessing the number of replicates for animal experiments. *Journal of Animal Science* 69, 67–76.
- Bons, A. (2000) Untersuchungen zur Aminosäurenversorgung von Pekingmastenten. PhD thesis, Martin-Luther-University Halle-Wittenberg, ISBN 3-8265-7697-7, Shaker Verlag Aachen, Germany.
- Dozier III, W.A. and Moran, E.T. Jr (2000) Threonine requirement for broiler males from 42–56 days of age. *Journal of Applied Poultry Research* 9, 214–222.
- Esteve-Garcia, E. and Llaurodo, L. (1997) Performance, breast meat yield and abdominal fat deposition of male broiler chickens fed diets supplemented with DL-methionine or DL-methionine hydroxy analogue free acid. *British Poultry Science* 38, 397–404.
- Gahl, M.J., Finke, M.D., Crenshaw, T.D. and Benevenga, N.J. (1991) Use of a four-parameter logistic function to evaluate the response of growing rats to ten levels of each indispensable amino acid. *Journal of Nutrition* 121, 1720–1729.

- Gahl, M.J., Crenshaw, T.D. and Benevenga, N.J. (1994) Diminishing returns in weight, nitrogen, and lysine gain of pigs fed six levels of lysine from three supplemental sources. *Journal of Animal Science* 72, 3177–3187.
- Hoehler, D., Mack, S., Neme, R. and Rostagno, H.S. (1999) Performance and carcass quality of broiler chickens fed diets supplemented either with Biolys<sup>®</sup>60 or L-Lysine-HCl. *12th WPSA Symposium on Poultry Nutrition*, Veldhoven, The Netherlands, pp. 360–361.
- Huyghebaert, G. and Pack, M. (1996) Effects of dietary protein content, addition of nonessential amino acids and dietary methionine to cysteine balance on responses to dietary sulphur-containing amino acids in broilers. *British Poultry Science* 37, 623–639.
- Huyghebaert, G., Pack, M. and de Groote, G. (1994) Influence of protein concentration on the response of broilers to supplemental DL-methionine. *Archiv für Geflügelk* 58, 23–29.
- Jeroch, H. and Pack, M. (1995) Effects of dietary sulphur amino acids and crude protein on the performance of finishing broilers. *Archives of Animal Nutrition* 48, 109–118.
- Kidd, M.T. and Kerr, B.J. (1997) Threonine responses in commercial broilers at 30 to 40 days. *Journal of Applied Poultry Research* 6, 362–367.
- Kidd, M.T., Lerner, S.P., Allard, J.P., Rao, S.K. and Halley, J.T. (1999) Threonine needs of finishing broilers: Growth, carcass, and economic responses. *Journal of Applied Poultry Research* 8, 160–169.
- Lehmann, D., Pack, M. and Jeroch, H. (1996) Responses of growing and finishing turkey toms to dietary lysine. *Poultry Science* 75, 711–718.
- Lehmann, D., Pack, M. and Jeroch, H. (1997) Effects of dietary threonine in starting, growing and finishing turkey toms. *Poultry Science* 76, 696–702.
- Lemme, A., Strobel, E., Hoehler, D., Matzke, W., Pack, M. and Jeroch, H. (2002a) Impact of graded levels of dietary lysine on performance in turkey toms 5 to 8 and 13 to 16 weeks of age. *Archiv für Geflügelk* 66, 102–107.
- Lemme, A., Hoehler, D., Brennan, J.J. and Mannion, P.F. (2002b) Relative effectiveness of methionine hydroxy analog compared to DL-methionine in broiler chickens. *Poultry Science* 81, 838–845.
- Mack, S., Bercovici, D., de Groote, G., Leclercq, B., Lippens, M., Pack, M., Schutte, J.B. and van Cauwenberghe, S. (1999) Ideal amino acid profile and dietary lysine specification for broiler chickens of 20 to 40 days of age. *British Poultry Science* 40, 257–265.
- Mercer, L.P. (1992) The determination of nutritional requirements: mathematical modeling of nutrient-response curves. *Journal of Nutrition* 122, 706–708.
- NRC (1994) *Nutrient Requirement of Poultry*. 9th revised edition. National Research Council, Washington, DC.
- Pack, M. (1997) Factors impacting amino acid levels recommended for growing poultry. *11th WPSA Symposium on Poultry Nutrition*, Faaborg, Denmark, August 24–28.
- Pack, M., Höhler, D. and Brennan, J.J. (1999) Efficacy of liquid MHA-FA as compared to DL-methionine on performance and carcass quality of broiler chickens. *12th WPSA Symposium on Poultry Nutrition*, Veldhoven, The Netherlands, pp. 342–345.
- Petri, A., Lemme, A. and Pack, M. (2001) Interpretation of lysine dose-response data for profit oriented formulation of commercial turkey diets. *13th European Symposium on Poultry Nutrition*, Blankenberge, Belgium, pp. 256–257.
- Robbins, K.R., Norton, H.W. and Baker, D.H. (1979) Estimation of nutrient requirements from growth data. *Journal of Nutrition* 109, 1710–1714.
- Rodehutsord, M. and Pack, M. (1999) Estimates of essential amino acid requirements from dose-response studies with rainbow trout and broiler chicken: effect of mathematical model. *Archives of Animal Nutrition* 52, 223–244.
- Rostagno, H.S. and Pack, M. (1995) Growth and breast meat responses of different broiler strains to dietary lysine. *10th WPSA Symposium on Poultry Nutrition*, Antalya, Turkey, pp. 260–262.
- Schutte, J.B. and de Jong, J. (1996) Biological efficacy of DL-methionine hydroxy analog-free acid compared to DL-methionine in broiler chicks as determined by performance and breast meat yield. *Agribiological Research* 49, 74–81.
- Schutte, J.B. and Pack, M. (1995a) Sulfur amino acid requirement of broiler chicks from 14 to 38 days of age. 1. Performance and carcass yield. *Poultry Science* 74, 480–487.
- Schutte, J.B. and Pack, M. (1995b) Effects of dietary sulphur-containing amino acids on performance and breast meat deposition of broiler chicks during the growing and finishing phases. *British Poultry Science* 36, 747–762.





# 26 Conclusions

**J.P.F. D'Mello\***

*Formerly of The Scottish Agricultural College, Edinburgh, UK*

---

## **General Considerations**

Much has transpired in the animal feed industry since the publication of the first edition of this book. In the European Union, meat and bone meal can no longer be used as animal feed and the controversy over the use of fish-meal for ruminant feeding continues unabated. In addition, the restrictions imposed by the ban on feed antibiotics have yet to be addressed in terms of viable commercial options. All of these issues have helped to raise further the profile of amino acids as feed supplements.

Meanwhile, research on amino acids in farm animal nutrition has shifted from empirical supplementation studies for determining requirements to fundamentals such as signalling and molecular action. The dose-response feeding studies have served their purpose, particularly in establishing requirements (Chapters 14, 18 and 20) and ideal amino acid patterns (Chapters 9 and 13). Modelling has also now become an established tool (Chapters 11, 16 and 21). This revised edition thus provides a timely opportunity to explore novel and wider applications of amino acids in animal nutrition. Some of the major developments are co-ordinated in this chapter.

## **Metabolism**

As described in Chapters 1, 4, 5, 7 and 19, significant developments in amino acid metabolism have occurred since publication of the first edition of this book. It is heartening to observe that recent results will underpin future advances in animal nutrition. Numerous studies have been conducted to explore the biochemical basis of practical problems.

### **Branched-chain amino acids**

The branched-chain amino acids continue to attract much attention as regards oxidation, molecular roles and dynamics.

#### *Oxidation*

The catabolism of branched-chain amino acids (BCAA) is initiated by a reversible aminotransferase reaction (Chapter 4) leading to the formation of branched-chain keto acids (BCKA). These intermediates may then undergo irreversible oxidative decarboxylation to yield acyl-CoA compounds, with further catabolism occurring via reactions analogous to those in oxidation of fatty acids. Harper *et al.* (1984) suggested that enhanced BCKA

\*E-mail address: f.dmello@ed.sac.ac.uk

oxidation might account for the depletion of plasma isoleucine and valine concentrations in antagonisms induced by feeding excess leucine. Such a mechanism would also account for the increased requirements for valine and isoleucine in poultry fed excess leucine (Chapter 14).

Oxidation of BCKA may be influenced by dietary carnitine. Owen *et al.* (2001) conducted a trial to elucidate the biochemical basis of reduced lipid and enhanced protein accretion in pigs fed L-carnitine. They proposed that dietary carnitine might decrease BCKA activity and thus conserve tissue pools of BCAA. Their results, summarized in Table 26.1, supported the hypothesis in that carnitine reduces BCKA dehydrogenase activity. They also observed enhanced rates of palmitate oxidation, more rapid flux through pyruvate carboxylase and higher rates of incorporation of amino acids into proteins in isolated hepatocytes following dietary supplementation with carnitine. Owen *et al.* (2001) interpreted the results to signify that carnitine availability enabled greater use of fat for energy, and diverted carbon along synthetic pathways, at the same time channelling BCAA away from oxidation and towards protein synthesis. The role of carnitine in the amelioration of BCAA antagonisms in poultry (Chapters 7 and 14) is now worthy of investigation and might help to substantiate and increase the scope of the conclusions of Owen *et al.* (2001).

### Molecular action

Reference has already been made to the work of Anthony *et al.* (2000a,b) suggesting that leucine may act as a signalling molecule in the stimulation of muscle protein synthesis by enhancing availability of specific eukaryotic initiation factors (Chapter 1). Their studies demonstrated that leucine is possibly unique among the BCAA in its ability to stimulate muscle protein synthesis.

The role of leucine as a nutritional signal has been reviewed in a recent symposium (Table 26.2). Hutson and Harris (2001) explained the rationale for the selection of leucine as the theme for this symposium. The justification is based on recent findings of a new non-protein role for amino acids. There is evidence that amino acids may act in signal transduction pathways activating in particular cells some of the same signalling cascades as the anabolic hormone insulin. Leucine is unique in that it can exert the same effects as complete amino acid mixtures. Anthony *et al.* (2001) reported that leucine stimulated protein synthesis in skeletal muscle by enhancing both the activity and synthesis of proteins involved in mRNA translation. This stimulation is thought to be mediated partly via the mammalian target of a rapamycin (mTOR) signalling pathway where both insulin and leucine act in concert to maximize protein synthesis. Dardevet *et al.* (2002) have shown that leucine supplementation stimulates mus-

**Table 26.1.** Effect of dietary L-carnitine on performance, carcass characteristics and branched-chain keto acid (BCKA) dehydrogenase activity in pigs<sup>a</sup>.

	Added L-carnitine (mg kg <sup>-1</sup> )		
	0	50	125
Weight gain (g day <sup>-1</sup> )	890	910	880
Feed intake (g day <sup>-1</sup> )	2840	2930	2800
Backfat thickness (cm)	3.05	2.97	2.92
Lean (%)	50.0	50.9	52.1
BCKA dehydrogenase flux in liver mitochondria (nmol mg protein <sup>-1</sup> h <sup>-1</sup> )	82.2	60.4	54.1
BCKA dehydrogenase flux in muscle mitochondria (nmol mg protein <sup>-1</sup> h <sup>-1</sup> )	108.8	110.1	86.5

<sup>a</sup>Compiled from Owen *et al.* (2001).

**Table 26.2.** Leucine as a nutritional signal: aspects reviewed in a recent symposium.

Topic	Reference
Regulation of branched-chain $\alpha$ -keto acid dehydrogenase kinase expression in rat liver	Harris <i>et al.</i> (2001)
Function of leucine in excitatory neurotransmitter metabolism in the central nervous system	Hutson <i>et al.</i> (2001)
Molecular mechanisms in the brain involved in the anorexia of branched-chain amino acid deficiency	Gietzen and Magrum (2001)
Signalling pathways involved in translational control of protein synthesis in skeletal muscle by leucine	Anthony <i>et al.</i> (2001)
Role of leucine in the regulation of mTOR <sup>a</sup> by amino acids: revelations from structure–activity studies	Lynch (2001)

<sup>a</sup>Mammalian target of rapamycin.

cle protein synthesis in old rats. They attributed this effect to enhanced efficiency of protein translation. The overall implications of these findings for high-performance farm animals have yet to be explored.

#### *Leucine flux*

The dynamics of leucine metabolism are inextricably involved with that of isoleucine and valine impacting on dietary requirements for the three amino acids (Chapter 14). In these interactions leucine consistently emerges as a dominant antagonist, with particular effects on valine metabolism and utilization (Chapter 14). Nevertheless, under certain conditions, reciprocity may be demonstrated in these interactions. It is thus always advisable to examine BCAA dynamics as a whole rather than on an individual amino acid basis. Despite strengthening evidence of complex interactions among

the BCAA, studies continue to be conducted on the component amino acids in isolation. For example, the differences in placental transport characteristics between normal and retarded pig fetuses have been reported for leucine (Table 26.3). It would be instructive to examine whether these characteristics also apply to isoleucine and valine. These results, nevertheless, support the notion that, in comparison with normal-sized siblings, retarded fetuses have lower circulating concentrations of many essential amino acids emanating from reduced placental transport of amino acids. There is mounting evidence of a direct relationship between placental amino acid transport and fetal growth. The results in Table 26.3 may reflect a general pattern for all amino acids. On the other hand, there may be leucine-specific effects. The role of leucine as a signalling molecule in the regulation of gene expression is gaining momentum. Indeed, the

**Table 26.3.** Leucine transport characteristics of placentae supplying normal and retarded pig fetuses at three stages of gestation<sup>a</sup>.

Type of placenta	Stage of gestation		
	45 days	65 days	100 days
To normal fetus	Na <sup>+</sup> independent	Na <sup>+</sup> independent	Na <sup>+</sup> independent and Na <sup>+</sup> dependent at approximately equal capacity
To retarded fetus	Na <sup>+</sup> independent at reduced capacity relative to normal	Na <sup>+</sup> independent at equivalent rates to normal	Na <sup>+</sup> independent only

<sup>a</sup>Based on review by Ashworth *et al.* (2001).

putative existence of a leucine-recognition molecule has been proposed (Jefferson and Kimball, 2001). Furthermore, recent studies show that other amino acids may exert specific effects during fetal development (see below).

## Arginine

Arginine continues to be the focus of much research following the elucidation of specific pathways leading to the synthesis of physiologically important compounds (Table 26.4). Arginine is an indispensable amino acid for poultry and is readily and specifically antagonized by excess lysine in the diet (Chapters 7 and 14). As indicated in Chapter 1, the primary direction of arginine metabolism in mammals occurs via the urea cycle, enabling the disposal of excess N from amino acids. However, the production of polyamines and nitric oxide (NO) from arginine is also recognized to be of critical importance (Chapter 4).

### Urea cycle

Buttery and D'Mello (1994) advanced the view that rapidly growing mammals respond to dietary arginine because the vast majority of arginine synthesized via the urea cycle is catabolized by an active hepatic arginase within this pathway (Fig. 4.2). Consequently, insufficient quantities of arginine are exported for the rapid growth of extra hepatic tissues, particu-

larly muscle. Since that proposition, many more data have become available on arginase itself and on urea cycle regulation as a whole.

It is now established that arginase exists in two distinct isoforms encoded by different genes. The two forms are denoted as arginase I and arginase II and differ from each other in a variety of aspects including functional characteristics, localization and regulation of expression. Arginase I is a cytosolic enzyme expressed particularly in the liver; on the other hand, arginase II is a mitochondrial enzyme, widely distributed, and the principal isoform in the small intestine of young pigs.

Ureagenesis, as might be expected, is quantitatively greater in the liver than in the small intestine of mammals. However, Bush *et al.* (2002) suggested that the regulation of urea cycle enzymes might be different in hepatic and intestinal tissues. This concept emerged from their work on somatotropin-treatment of pigs (Table 26.5). These results also provided a biochemical explanation for N conservation and reduced ureagenesis in somatotropin-treated pigs.

### Polyamines

Polyamines are considered to be essential for:

- normal growth and development;
- regulation of RNA synthesis;
- tissues actively synthesizing proteins;
- maintaining the stability of membrane structures.

**Table 26.4.** Diverse roles of arginine.

Pathway		Effects
Direct	Protein synthesis	Growth, reproduction and lactation; arginine essential for poultry, cats and fish
	Hormone production <sup>a</sup>	Somatotropin release from hypophysis Prolactin from hypophysis Insulin from pancreas Release of insulin-like-growth-factor Glucagon release
Via ornithine	Polyamine synthesis	Synthesis of growth factors
Via citrulline	Nitric oxide	See text
Via ornithine cycle	Urea production <sup>b</sup>	Major route of N excretion in mammals

<sup>a</sup>Based on review by Suchner *et al.* (2002).

<sup>b</sup>See Chapter 4.

**Table 26.5.** Effect of somatotropin treatment of pigs on activities of urea cycle<sup>a</sup> enzymes in the liver and jejunum<sup>b</sup>.

Enzyme	% Change <sup>c</sup>	
	Liver	Jejunum
Carbamoylphosphate synthase	-45	5
Ornithine carbamoyltransferase	-6	9
Argininosuccinate synthase	-38	0
Argininosuccinate lyase	-23	3
Arginase	-27	1

<sup>a</sup>Pathway illustrated in Fig. 4.2.

<sup>b</sup>Compiled from Bush *et al.* (2002).

<sup>c</sup>Relative to activities for control pigs.

Polyamine production (Fig. 4.3) appears to be an underlying phenomenon in all tissues actively engaged in protein synthesis. Thus the excess uptake of arginine by the mammary gland may be a reflection of the need for polyamine synthesis by tissues actively synthesizing proteins in this organ. Polyamine synthesis is an important focal point for the action of antinutritional factors.

#### Nitric oxide

A unique feature of arginine relates to the production of NO (Chapter 4). New results indicate that compartmentalization of NO synthase isoforms allows NO signals to exert independent and perhaps even opposite effects on organs and physiological processes (Barouch *et al.*, 2002). It is now established that NO plays a key role in:

- cardiac function;
- vasorelaxation;
- neurotransmission;
- immunocompetence;
- male reproductive performance and behaviour;
- gut motility.

In addition, NO may play a key role in the responses of animals to particular antinutritional factors (D'Mello, 1995). However, it is not known whether NO production is affected by the lysine-arginine antagonism in poultry (Chapters 7 and 14).

#### Mammary tissue catabolism

The role of the two forms of arginase (I and II; see above) in the degradation of arginine by (porcine) mammary tissue has now been confirmed by O'Quinn *et al.* (2002). The major products of arginine catabolism were proline, ornithine and urea. The authors suggest that the synthesis of proline from arginine facilitates the conservation of arginine carbons in mammary tissue. Their results also provided a biochemical explanation for the enrichment of proline in milk, relative to its uptake from the circulation, by the mammary gland. The relatively high uptake to output ratio for arginine can be explained in terms of its utilization for proline and polyamine biosynthesis within the mammary gland. Both forms of nitric oxide synthase (constitutive and inducible) exist in mammary tissue, confined exclusively to the cytosol.

#### Glutamine

Since the first edition of this book considerable advances have been made on the metabolism of glutamine, justifying an entire symposium on the subject, with the proceedings appearing in 2001. A supplement on immunonutrition published in 2002 also addressed the role of glutamine. The compilation in Table 26.6 gives an insight into the diverse functions and biochemical linkages of glutamine. Although the bias is distinctly

**Table 26.6.** Glutamine metabolism: a summary of titles selected from the proceedings of two recent symposia.

Title	Authors
Mechanisms governing the expression of the enzymes of glutamine metabolism – glutaminase and glutamine synthetase	Labow <i>et al.</i> (2001)
Molecular advances in mammalian glutamine transport	Bode (2001)
Interaction between glutamine availability and metabolism of glycogen, tricarboxylic acid cycle intermediates and glutathione	Rennie <i>et al.</i> (2001)
Role of mitochondrial glutaminase in rat renal glutamine metabolism	Curthoys (2001)
Glutamate– $\gamma$ -aminobutyric acid–glutamine cycling in rodent and human cortex: the central role of glutamine	Behar and Rothman (2001)
Glutamine and the bowel	Reeds and Burrin (2001)
Glutamine and cell signalling in liver	Haussinger <i>et al.</i> (2001)
Why is L-glutamine metabolism important to cells of the immune system in health, postinjury, surgery or infection?	Newsholme (2001)
Glutamine in animal science and production	Lobley <i>et al.</i> (2001)
Glutamine and cancer	Medina (2001)
Assessment of safety of glutamine and other amino acids	Garlick (2001)
Glutamine alimentation in catabolic state	Boelens <i>et al.</i> (2001)
Glutamine in the fetus and low birth weight neonate	Neu (2001)
Glutamine: essential for immune nutrition in the critically ill	Andrews and Griffiths (2002)
Glutamine supplementation in bone marrow transplantation	Ziegler (2002)
Glutamine depletion impairs cellular stress response in human leucocytes	Oehler <i>et al.</i> (2002)

towards clinical applications, there are implications for animal nutrition, health and welfare (Chapter 5; see also Lobley *et al.*, 2001).

It is widely acknowledged that glutamine is an important substrate, serving as a major respiratory fuel, glucogenic source and N carrier. Thus, in the synthesis of uric acid in poultry, glutamine is a key vehicle for the disposal and excretion of waste N. In addition, the glutamate–glutamine cycling in the central nervous system and the inter-organ glucose–alanine–glutamine cycle are well-known features of amino acid metabolism. The role of glutamine in immune function is reviewed in a separate section below.

Wilmore and Rombeau (2001) suggest that several of the non-essential amino acids may become conditionally essential because endogenous synthesis cannot satisfy immediate requirements under conditions of stress. It is conceivable that factors such as disorders of pregnancy and lactation and bacterial and parasitic diseases may induce needs for amino acids such as glutamine, homocysteine and, in mammalian systems, arginine.

### Homocysteine

Homocysteine is a key intermediate in sulphur amino acid (SAA) metabolism, yielding cysteine (Chapter 8) and taurine. It is established that taurine is an essential amino acid for felines (Chapter 1). The importance of homocysteine in human health is now well recognized in that plasma levels are higher than normal in patients with coronary, cerebrovascular or peripheral arterial occlusive disease. In addition, evidence is accumulating of a relationship between homocysteine and a number of B-complex vitamins (Table 26.7). In particular, vitamin B<sub>12</sub> is required for methionine synthase which methylates homocysteine to form methionine. In the conversion of homocysteine into cystathionine another B-complex vitamin, pyridoxal phosphate, serves as a vital co-factor. The association of homocysteine with folate and riboflavin has also been described (Table 26.7). In pigs, prolonged vitamin B<sub>12</sub> deficiency is associated with hyperhomocysteinaemia, and in cattle a similar effect has been reported in long-term moderate deficiency of Co (see Chapter 1). In addition,

**Table 26.7.** Homocysteine metabolism: selected research titles illustrating relationships with vitamins and nitric oxide.

Title	Reference
Homocysteine, vitamins and arterial occlusive disease: an overview	Rosenberg (1996)
Plasma homocyst(e)ine: a risk factor for arterial occlusive diseases	Malinow (1996)
Relationship among homocyst(e)ine, vitamin B <sub>12</sub> and cardiac disease in the elderly	Herzlich <i>et al.</i> (1996)
Relationship between plasma homocysteine, vitamin status and extracranial carotid-artery stenosis	Selhub <i>et al.</i> (1996)
The use of homocysteine and other metabolites in the specific diagnosis of vitamin B <sub>12</sub> deficiency	Stabler <i>et al.</i> (1996)
Vitamins as homocysteine-lowering agents	Brattstrom (1996)
Homocysteine, EDRF <sup>a</sup> and endothelial function (physiological reaction between homocysteine and NO to form the stable adduct S-nitroso-homocysteine)	Upchurch <i>et al.</i> (1996)
Plasma homocysteine levels in Taiwanese vegetarians (associated with folate and vitamin B <sub>12</sub> status)	Hung <i>et al.</i> (2002)
Relationship between riboflavin and plasma homocysteine is influenced by folate status	Jacques <i>et al.</i> (2002)

<sup>a</sup>Endothelium-derived relaxing factor.

Upchurch *et al.* (1996) identified a pathway for the physiological reaction between homocysteine and NO to form the stable adduct S-nitrosomethionine.

### Betaine (trimethyl glycine)

Betaine or trimethyl glycine is one of the methyl donors enabling the conversion of homocysteine into methionine. Since the previous edition of this book, much interest has been expressed in the potential of betaine as a feed supplement (Chapter 8). The publications by Fernandez-Figares *et al.* (2002) and Lawrence *et al.* (2002) give an up-to-date account of the basis for this interest. Betaine addition is associated with reduced lipid accretion in pigs and altered nutrient partitioning, although the responses may be affected by feeding regimes and may be more pronounced in barrows rather than in gilts. The dietary conditions that predispose to more consistent responses need to be elucidated before commercial supplementation can be advocated. There is also an implication that betaine may exert its effects via mechanisms that do not necessarily involve methionine-sparing pathways (Chapter 8).

### Methionine and cystine

The methionine-sparing effects of cystine are well documented (Chapter 8). The methionine-cystine conversion is of practical importance since many feeds contain more cystine than methionine. Consequently, diets may be relatively high in total SAA but low in methionine. In assessing the extent to which cystine may spare dietary methionine requirements, it is important to ascertain whether values being considered are on a weight or molar basis. In addition, it is necessary to recognize that cystine efficacy is considerably greater for maintenance than for new tissue growth. The higher cystine requirements for maintenance have been attributed, in part, to the high cystine content of hair and other keratin components. Methionine:cystine ratios suggested for pigs are 49:51 for protein accretion and 23:77 for maintenance (Chapter 8). For practical formulations, current recommendations are that not more than 50% of the SAA requirement of animals should be provided by cystine. Even in fish, the cystine replacement value for methionine varies between 40 and 60% on a sulphur basis (Chapter 23).

The SAA requirement for wool growth is high and generally above that supplied by exogenous sources (Chapter 17). Methionine



supplementation enhances efficiency of protein utilization by promoting protein metabolism in the follicles and skin. Cysteine synthesized in the skin is quantitatively important in supporting wool growth; however, its supply is restricted by the methionine needs for polyamine synthesis. Methionine appears to be used relatively inefficiently for growth by cattle and sheep. In cattle (Chapter 18), this effect has been attributed to the role of methionine in providing methyl groups, whereas in sheep its utilization for cysteine synthesis may be more important (Chapter 17).

### Immune Functions

As indicated in Chapter 1, cysteine and BCAA have been tentatively assigned with immunological functions. However, more recent evidence from clinical studies suggests that other amino acids may function as immune modulators (Table 26.8). There may be health implications for farm and companion animals.

Reference has already been made to the role of NO in immunocompetence. Suchner *et al.* (2002) have reviewed the clinical evidence suggesting that NO may help in the regulation of inflammation and in enhancing the depressed immune response of patients suffering from injury, surgical trauma, malnutrition or sepsis. Exogenous source of arginine also imparts beneficial responses in terms of increased monocyte and lymphocyte proliferation and T-helper cell formation. Activation of macrophage cytotoxicity and increased cytokine production were also observed. However, the authors cautioned against the routine clinical use of exogenous arginine.

The case for glutamine as an immune modulator (Tables 26.6 and 26.8) would appear to be particularly strong, when clinical evidence is considered (Andrews and Griffiths, 2002). All the diverse cells of the immune system appear to be dependent on glutamine for proper functioning. Glutamine not fully utilized for energy may become available for the functioning of:

- monocytes and macrophages;
- lymphocytes;
- neutrophils.

Phagocytosis in macrophages appears to be glutamine-dependent and this amino acid also significantly enhances phytohaemagglutinin-stimulated lymphocyte proliferation, production of intracellular reactive oxygen species and glutathione (see Andrews and Griffiths, 2002). There also appears to be some potential for glutamine supplementation in bone marrow transplantation (Ziegler, 2002).

### Amino Acids in Reproduction and Lactation

#### Reproduction

Certain amino acids have been accorded with specific roles in placental and fetal metabolism. Of these, glutamine and glutamate have emerged as particularly important, firstly with the observation that there is a net flux of glutamate from the fetus into the placenta of sheep. Secondly, it was reported that of all the amino acids transported to the fetus from maternal and placental sources, glutamine export was highest. Subsequent studies supported the existence of a glutamate–glutamine shuttle in exchanges between the fetal

**Table 26.8.** Amino acids as immune modulators.

Amino acid	Role	Reference
Cysteine	Immunoregulatory signal between macrophages and lymphocytes	Miller <i>et al.</i> (2000)
Branched-chain amino acids	Specific role in immune responses in chickens; mechanisms remain obscure	Konashi <i>et al.</i> (2000)
Arginine	Via formation of nitric oxide.	Suchner <i>et al.</i> (2002)
Glutamine	Monocyte, macrophage and lymphocyte function	Andrews and Griffiths (2002)

liver and the placenta. It appears that maternal supplies of glutamine arriving at the placenta are further enhanced by placental glutamine synthesis prior to uptake by the fetal liver. Neu (2001) reported that in the prematurely born human infant, the maternal provision of glutamine is suddenly interrupted making the infant more reliant on endogenous synthesis which might not meet its needs in a stressful environment. Under these conditions, infants might benefit from exogenous sources of glutamine. Although Ashworth *et al.* (2001) focused on placental transport of leucine, it would be highly instructive to examine the characteristics of the glutamate–glutamine shuttle in normal and retarded pig fetuses. Other research indicated a link between elevated maternal homocysteine levels and embryonic defects (Mills *et al.*, 1996; Rosenquist and Finnell, 2001). In addition, maternal status and supply of arginine may be important in determining NO and polyamine production in the placenta during early gestation (Wu *et al.*, 1998). Thus, much has still to be elucidated on the relationships between maternal provision of specific amino acids and fetal development in farm and companion animals.

### Lactation

The lactating mammary gland is a major site of uptake and metabolism of amino acids and other nutrients. As pointed out in Chapter 19, the active mammary gland is a major controller of its own metabolic fate. However, metabolism in gut and hepatic tissue and the partition of amino acids in favour of muscle anabolism mean that the supply of certain amino acids to the udder may be restricted. Consequently, amino acids delivered to the udder are unlikely to reflect the pattern absorbed from the gut. For example, up to 24% of absorbed leucine may be oxidized by the gut of dairy cows, whereas the liver removes substantial quantities of absorbed histidine, methionine and phenylalanine. Evidence is now emerging for the role of peptides in interorgan exchange and delivery of amino acids to the mammary gland (Chapter 19).

Lactational responses in infusion and feeding trials have been reviewed in Chapter 20. Concern has been expressed in regard to trials with rumen-protected methionine and lysine which have not significantly enhanced scientific understanding. However, post-ruminal infusion of proteins is a technique that offers greater potential for generating data of direct relevance to ration formulation.

### Balance and Imbalance

The development of the ‘ideal protein’ concept more than 20 years ago has continued to stimulate interest in optimum dietary amino acid balance for all the major classes of animals (Chapters 9, 13 and 23). The reasoning is quite straightforward. If the requirement for one amino acid, e.g. lysine, is known with confidence, it should be possible to estimate the requirements for other amino acids from information on the ideal ratios of these amino acids to lysine. Ideal ratios would remain unaffected by factors such as genotype, or energy and protein content of diets.

Inevitably, however, imbalances will occur in practical diets and, under certain circumstances, at the tissue level as well (Chapter 7). Imbalances are undesirable because they markedly reduce food intake in *ad libitum*-fed animals. Furthermore, there are indications that imbalances induced by high-protein diets formulated from intact ingredients may reduce the efficiency of utilization of the first-limiting amino acid, at least in poultry (Chapter 14). In Chapter 20, it is suggested that infusion of free amino acids in ruminants may lead to an unbalanced profile reaching the liver, but it is not clear what the consequences might be for hepatic metabolism or nutrient supply to other tissues such as the mammary gland. The need to develop models incorporating dynamic absorption coefficients that are sensitive to amino acid imbalances has also been suggested as a means of improving prediction of amino acid adequacy for ruminants (Chapter 21). In Chapter 12 it is suggested that the ideal dietary amino acid pattern is not fixed but instead dependent on physiological status in breeding and lactating sows.

## Bioavailability

Bioavailability of amino acids has been defined as the fraction of total dietary amino acids that can be utilized for protein synthesis by the various tissues of an animal. Digestibility is the most important determinant of amino acid bioavailability. In Chapter 10, the use of true ileal digestibility of amino acids in diet formulations is recommended to facilitate calculation of a more accurate cost/benefit value of ingredients and to improve prediction of growth performance. True ileal digestibility values would be particularly useful for a wide range of feed ingredients that have not been subjected to high temperatures during processing. However, there is a need to express animal requirements in terms of true ileal digestibility values.

## Changing Focus

There is no doubt that empirical methods have attracted considerable criticism due to their perceived inflexibility, and recent efforts have become focused on modelling (Chapters 11 and 16) as the way forward. It is unfortunate that two camps have emerged on issues relating to amino acid nutrition of animals, as future developments are most likely to be dependent on a combination of empirical and modelling approaches. Thus, it is difficult to see how maintenance requirements might be established from first principles. For example, it is yet not possible to collate aspects such as immune and signalling functions into models for the determination of maintenance requirements and we will, therefore, continue to rely on empirical estimates of these requirements for the foreseeable future. Advances relating to NO, glutamine and signalling roles have all arisen from empirical investigations and not from model-driven pursuit. Clearly, there is much scope for interdependent progress on issues in amino acid metabolism and nutrition and the extent of polarization in current approaches to problem-solving cannot be justified, even in respect of the development of economic models (Chapter 25).

Hitherto, amino acids such as methionine and lysine were viewed purely as performance enhancers to supplement the deficiencies of

cereals. However, an additional criterion in the future is likely to be efficacy for reduction of N pollution from animal wastes (Chapter 24). Any real progress on this issue will clearly depend on future regional and global environmental policies. As legislation becomes more stringent, there are prospects for the regular use of an additional range of amino acid supplements, including threonine and tryptophan.

## Enduring Concepts and Methodologies

Although this chapter is designed to look forward, one must nevertheless acknowledge earlier advances that have survived the test of time. One of these is the 'Reading model' originally developed by Fisher *et al.* (1973) and described in some detail in the first edition of this book (Fisher, 1994). Although the original version was developed to provide a formal description and prediction of responses of laying hens to amino acid intake, the model has now found wider applications in the nutrition not only of poultry but also of other species of farm animals. There is no doubt that the Reading model will remain an important landmark for the foreseeable future.

As pointed out in Chapter 2, ion-exchange chromatography (IEC) with postcolumn ninhydrin detection remains the method of choice for the analysis of animal feeds, despite the significant advances made with HPLC. Factors contributing to the durability of IEC are high precision and resistance to matrix effects.

## Unifying Concepts

Consistent with the foregoing comments on the roles of glutamine, glutamate and homocysteine, there are many demonstrations of the dietary importance of the non-essential amino acids as an entity. In Chapter 6, the diverse data relating to optimum essential to non-essential amino acid ratios has been considered for several species. It was found that optimum ratios of essential N to total amino acid N were similar both within and between species. Data obtained with rats, chicks, pigs and kittens were used in this evaluation.

Although widely criticized for their lack of flexibility, empirical studies have, nevertheless, yielded valuable information. Thus in poultry, growth responses to individual amino acids have been shown to conform to simple uniform patterns irrespective of species, age and dietary energy concentrations, providing differences in food intake are taken into account (Chapter 14). Empirical dose–response data have been used to develop an economic assessment of dietary amino acid specifications. Results from 25 dose–response studies with growing broilers, ducks and turkeys have been presented for methionine, lysine and threonine. Non-linear functions such as an exponential model provided a good fit to the responses for growth, feed:gain ratio and breast meat yield (Chapter 25).

The concept of imbalance, first developed with laboratory animals, is now the focus of considerable and widespread attention in non-ruminant nutrition. The implications for ruminants have yet to be explored in ways that will enhance nutrient efficiency. This is surely a challenge for the future.

### Taste Receptors

In earlier attempts to explain amino acid imbalance and toxicity (Chapter 7), the effect on taste receptors has consistently been rejected as one of the mechanisms. This dismissal persisted even by authors demonstrating food intake reductions within 3–6 h of feeding an imbalanced diet to both laboratory animals and chicks. However, Forbes (2000) maintains that animals do display specific appetites for lysine, methionine and other nutrients. It is possible that selection might involve taste receptors. In this respect, the findings of Nelson *et al.* (2002) concerning an amino acid taste receptor might be relevant. They demonstrated the existence of specific receptors able to function as L-amino acid sensors with the capacity to respond to most of the 20 standard amino acids but not to their D-isomers or to other compounds. There is a need to re-evaluate current concepts of taste sensation in animals to underpin work on feed intake enhancers. Amino acids play an important role in the palatability of foods for cats and dogs (Chapter 22).

### Industrial Production of Amino Acids

The significant advances made in our knowledge of amino acid nutrition of animals are undoubtedly due to the supply of amino acids at affordable prices. In the case of feed-grade lysine and methionine the economics are largely in favour of their routine use in animal feeds. Kusomoto (2001) provides an outline of the processes used in the industrial manufacture of amino acids. Four methods are used:

- Extraction from hydrolysates of plant or animal proteins;
- Chemical synthesis;
- Fermentation;
- Enzymatic.

Fermentation technology is now so advanced that many amino acids destined for commercial feed applications are currently being produced by this method (Table 26.9).

### Safety

The safety of feed-grade amino acids is rarely questioned as it is assumed that commercial application of methionine and lysine over recent decades has been accomplished without undue problems. However, in the current regulatory setting it is important that safety standards are unequivocally established along prescribed protocols. In the EU, amino acids are regulated by Directive 82/471/EEC concerning ‘Certain Products in Animal Nutrition’ and amendments to this Directive. As the related Directive 83/228/EEC on ‘Fixing Guidelines for the Assessment of Certain Products’ only covers bioproteins, and not amino acids and analogues, usually Commission Directive 2001/79/EC amending Council Directive 87/153/EEC on ‘Fixing Guidelines for the Assessment of Additives in Animal Nutrition’ will be applied. Future developments will take this into account and re-arrange feed additive legislation. For registration of an additive, there is a detailed and long listing of tests, that have to be performed, e.g. identity, composition, physico-chemical and technological properties, methods of determination, stability, physiolog-

**Table 26.9.** Industrial production of amino acids.

Amino acid	Raw material	Process	Commercial product
Methionine	Propylene, methyl mercaptan, methane, ammonia	Chemical synthesis	DL-Methionine; DL-methionine, sodium salt
Hydroxy analogue of methionine	Acrolein, methyl mercaptan, hydrogen cyanide	Chemical synthesis	DL-2-Hydroxy-4-methyl mercaptobutyric acid, liquid
Lysine	Molasses, sugar, starch products and their hydrolysates, N-source	Fermentation	L-Lysine monohydrochloride; L-lysine concentrate (liquid); L-lysine monohydrochloride (liquid); L-lysine sulphate
Threonine	Molasses, sugar, starch products and their hydrolysates, N-source	Fermentation	L-threonine
Tryptophan	Molasses, sugar, starch products and their hydrolysates, N-source	Fermentation	L-Tryptophan

ical and toxicological studies, safety for target species, workers, users and consumers, residue studies and effect on the environment. In the USA, under Section 201(s) of the Federal Food, Drug, and Cosmetic Act, substances added to food, including substances intended for use in animal food (such as amino acids), are 'food additives' regulated by the Food and Drug Administration (FDA). The general safety provisions of the Act requires the FDA to determine whether each food additive proposed for use in food-producing animals is safe for intended animals and whether the edible products derived from treated animals are safe. The manufacturer is required to furnish to the FDA with the scientific data necessary for demonstrating that the residues of the sponsored compound in the edible products of treated animals are safe. In addition to safety concerns, the FDA may require data on the stability of the additive and the origin of the strain, toxicity and residues, if the additive is derived via fermentation technologies.

Regarding amino acids destined for human use, more stringent protocols and legislative measures are enforced. However, in the case of glutamine, Garlick (2001) reported that only four studies have been conducted to specifically assess its safety for intravenous and enteral administration in humans.

## Summary

It will be clear that this book has raised more questions than it has answered. This is indicative of a vibrant field of research and development. Focus has shifted from whole-animal dose-response experimentation to determine requirements to a re-examination of the functional roles of particular amino acids, both essential and non-essential. A number of recommendations appear in individual chapters; salient features are presented below.

## Amino acid analysis

- The development of robust near-infrared spectroscopy (NIRS) calibrations for amino acid analysis should continue (Chapter 2). The speed of analysis would facilitate continuous adjustment of dietary formulae to accommodate batch-to-batch variations in amino acid composition. The use of digestible rather than total amino acid values in dietary formulations would also be enhanced through greater use of NIRS in the future.
- International standardization in amino acid analysis has now become a reality and should continue in the years ahead particularly between EU member states and North America.

- Difficulties and protracted procedures associated with the analysis of sulphur amino acids make it imperative that detailed methodologies are reported in research papers in order to facilitate interpretation of response data (Chapter 8).
- The roles of amino acids as immune modulators and signalling molecules (Chapters 1, 3 and 4) are topics that are likely to be given considerable attention in the future. Increased focus on the functions of glutamine is likely to produce dividends, whereas relationships between homocysteine and B-complex vitamins in pregnant and lactating animals as well as in companion animals have yet to be explored. It is important that animal nutritionists and veterinarians are ready to monitor and exploit any advances emerging in these areas.

### **Amino acid absorption**

- Since the first edition, significant advances have been made in our understanding of the fate of dietary protein in the gut. There is now overwhelming evidence that the intestinal absorption of peptides in different species of farm animals is quantitatively important (Chapter 3). Nevertheless, outstanding questions remain. The significance of peptide-bound uptake relative to free amino acid absorption by gut epithelia needs to be quantified. Dietary manipulation of the two forms of absorption has yet to be addressed as well as the relative nutritional advantages of peptide-bound amino acids.
- There is also a need to explain why, in growing poultry at least, high-protein diets depress utilization of the limiting amino acid (Chapter 14).

### **Metabolism**

- Emerging issues in this area include the profound modulatory effects of amino acids on the proteins associated with the regulation of mRNA translation (Chapters 1 and 5). However, it is still not known which specific amino acids are involved in this function. The particular role of leucine in this context deserves further attention.
- Leucine kinetics should be studied not in isolation but in conjunction with its structural analogues, namely isoleucine and valine. In the first edition, considerable emphasis was placed on the nutritional and biochemical interactions between the three branched-chain amino acids. However, studies on cellular transport are still conducted on individual amino acids in this group without due recognition to the complex interactions described in Chapters 7 and 14.

### **Utilization**

- Optimum utilization requires the presence of both essential and non-essential amino acids in defined proportions (Chapter 6). Most of the relevant studies have been conducted with growing animals. However, there is a need to identify the optimum ratios for particular physiological functions such as maintenance and reproduction. Indirect evidence suggests that the optimum ratio might be higher for maintenance. The assumption is that mutual interconversions may not be sufficient to satisfy the needs of non-essential amino acids. The roles of glutamate, glutamine and homocysteine may be relevant in this respect.
- The use of true ileal digestibility values in diet formulation should be encouraged as it will allow better prediction of animal performance and assessment of cost/benefit value (Chapter 10). However, corrections for endogenous losses need to be standardized to enable universal application.
- It is important to establish whether the high-protein effect on utilization of the first-limiting amino acid is a genuine manifestation of imbalance or an artefact (Chapters 7 and 14).
- Although dietary manipulation of amino acid supply for improved efficiency of wool growth is possible, genetic selection may be a more cost-effective means for achieving the same result (Chapter 17).
- Progress on growth (Chapter 18) and lactational responses to amino acids in ruminants would be greatly advanced by the

availability in future of rumen-protected forms of all essential amino acids. It is likely that reproducible responses will depend on the addition of several of these amino acids (Chapter 20).

- Postprandial infusion of proteins will continue to provide valuable information on amino acid utilization, but it is essential that casein is not used for this purpose as it does not behave like a typical feed protein (Chapter 20).
- The superior quality of proteins from animal sources compared with oilseed by-products continues to defy elucidation. Evidence previously recorded with poultry (Chapter 14) has now been extended to ruminants (Chapter 20).
- In certain types of fish, methionine deficiency uniquely results in the development of bilateral cataracts. The same effect may occur if methionine:cystine ratios are inadequate (Chapter 23). The relatively large discrepancies in threonine requirements noted in the previous edition have still not been resolved.

### Modelling

Modelling has now become an established tool, with potential applications in amino acid nutrition of animals (Chapters 11 and 16). Models based on biochemical pathways should enable a more dynamic approach to the estimation of amino acid requirements.

- Models should continue to be developed and used to identify gaps in current knowledge relating to the diverse features of amino acid utilization by animals.
- As ever, the development of good models will depend on the generation of fundamental data in the areas outlined in this chapter. Models will need to address not only the nutritional roles of amino acids but also their functions as immune and regulatory modulators – no easy task.
- As regards ruminant nutrition, recent models have accommodated many of the quantitative features of ruminal fermentation, but as yet accurate prediction of productivity has been an elusive entity. The diversity

of the microbial ecosystem in the metabolism of amino acids and factors affecting the catabolic flux are just two areas in need of attention (Chapter 15).

- Amino acid transport processes and metabolism in the mammary gland are highly complex, with many aspects still awaiting elucidation. As new data are generated, greater emphasis will be placed on mathematical modelling to integrate features of metabolism and regulation in this organ for the prediction of milk production in lactating animals (Chapter 19).
- The predictive efficacy of existing models such as the Cornell Net Carbohydrate and Protein System will be enhanced as further research is conducted on modelling of intestinal absorption and identification of limiting amino acids; information is also required on requirements for the branched-chain amino acids (Chapter 21).
- Quantitative information concerning the amino acid requirements for key physiological processes in adult cats and dogs should become available in the future. Such developments will enable the construction of flexible factorial models for these species along lines similar to those for farm animals (Chapter 22). The unique role of taurine and production of feline needs to be addressed in assessing requirements for cats.

### Outlook

The outlook for amino acids as supplements is arguably better now than at any time in the past. In poultry nutrition, for example, supplements of limiting essential amino acids are utilized more efficiently for growth than equivalent quantities supplied as intact proteins. This feature may be more universally applicable to other species. The ban on mammalian proteins in animal feed further reinforces the favourable prospects for amino acids, including not only lysine and methionine but threonine and tryptophan as well. However, the question of supplementation of ruminant diets with the amino acids that limit microbial growth and ruminal fermentation remains to be resolved. The safety of amino

acids as feed supplements has been accepted for at least three decades. Amino acids may also serve in the amelioration of N pollution from animal wastes. All of these aspects will sustain interest in amino acids as nutrients and supplements for many years to come.

## References

- Andrews, F.J. and Griffiths, R.D. (2002) Glutamine: essential for immune nutrition in the critically ill. *British Journal of Nutrition* 87, S3–S8.
- Anthony, J.C., Anthony, T.G., Kimball, S.R., Vary, T.C. and Jefferson, L.S. (2000a) Orally administered leucine stimulates protein synthesis in skeletal muscle of postabsorptive rats in association with increased eIF4F formation. *Journal of Nutrition* 130, 139–145.
- Anthony, J.C., Yoshizawa, F., Anthony, T.G., Vary, T.C., Jefferson, L.S. and Kimball, S.R. (2000b) Leucine stimulates translation initiation in skeletal muscle of postabsorptive rats via a rapamycin-sensitive pathway. *Journal of Nutrition* 130, 2413–2419.
- Anthony, J.C., Anthony, T.G., Kimball, S.R. and Jefferson, L.S. (2001) Signalling pathways involved in translational control of protein synthesis in skeletal muscle by leucine. *Journal of Nutrition* 131, 856S–860S.
- Ashworth, C.J., Finch, A.M., Page, K.R., Nwagwu, M.O. and McArdle, H.J. (2001) Causes and consequences of fetal growth retardation in pigs. *Reproduction Supplement* 58, 233–246.
- Barouch, L.A., Harrison, R.W., Skaf, M.W., Rosas, G.O., Cappola, T.P., Kobeissi, Z.A., Hobai, I.F., Lemmon, C.A., Burnett, A.L., O'Rourke, B., Rodriguez, E.R., Huang, P.L., Lima, J.A.C., Berkowitz, D.E. and Hare, J.M. (2002) Nitric oxide regulates the heart by spatial confinement of nitric oxide synthase isoforms. *Nature* 416, 337–340.
- Behar, K.L. and Rothman D.L. (2001) *In vivo* nuclear magnetic resonance studies of glutamate- $\gamma$ -aminobutyric acid-glutamine cycling in rodent and human cortex: the central role of glutamine. *Journal of Nutrition* 131, 2498S–2504S.
- Bode B.P. (2001) Recent molecular advances in mammalian glutamine transport. *Journal of Nutrition* 131, 2475S–2485S.
- Boelens, P.G., Nijveldt, R.J., Houdijk, A.P.J., Meijer, S. and van Leeuwen, P.A.M. (2001) Glutamine alimentation in catabolic state. *Journal of Nutrition* 131, 2569S–2577S.
- Brattstrom, L. (1996) Vitamins as homocysteine-lowering agents. *Journal of Nutrition* 126, 1276S–1280S.
- Bush, J.A., Wu, G., Suryawan, A., Nguyen, H.V. and Davis, T.A. (2002) Somatotropin-induced amino acid conservation in pigs involves differential regulation of liver and gut urea cycle enzyme activity. *Journal of Nutrition* 132, 59–67.
- Buttery, P.J. and D'Mello, J.P.F. (1994) Amino acid metabolism in farm animals: an overview. In: D'Mello, J.P.F. (ed.) *Amino Acids in Farm Animal Nutrition*. CAB International, Wallingford, pp. 1–10.
- Curthoys, N.P. (2001) Role of mitochondrial glutaminase in rat renal glutamine metabolism. *Journal of Nutrition* 131, 2491S–2495S.
- Dardevet, D., Sornet, C., Bayle, G., Prugnaud, J., Pouyet, C. and Grizard, J. (2002) Postprandial stimulation of muscle protein synthesis in old rats can be restored by a leucine-supplemented meal. *Journal of Nutrition* 132, 95–100.
- D'Mello, J.P.F. (1995) Anti-nutritional substances in legume seeds. In: D'Mello, J.P.F. and Devendra, (eds) *Tropical Legumes in Animal Nutrition*. CAB International, Wallingford, UK, pp. 135–172.
- Fernandez-Figares, I., Wray-Cahen, D., Steele, N.C., Campbell, R.G., Hall, D.D., Virtanen, E. and Caperna, T.J. (2002) Effect of dietary betaine on nutrient utilization and partitioning in the young growing feed-restricted pig. *Journal of Animal Science* 80, 421–428.
- Fisher, C. (1994) Responses of laying hens to amino acids. In: D'Mello, J.P.F. (ed.) *Amino Acids in Farm Animal Nutrition*. CAB International, Wallingford, UK, pp. 245–280.
- Fisher, C., Morris, T.R. and Jennings, R.C. (1973) A model for the description and prediction of the response of laying hens to amino acid intake. *British Poultry Science* 14, 469–484.
- Forbes, M.J. (2000) Physiological and metabolic aspects of feed intake control. In: D'Mello, J.P.F. (ed.) *Farm Animal Metabolism and Nutrition*. CAB International, Wallingford, pp. 319–333.
- Garlick, P.J. (2001) Assessment of the safety of glutamine and other amino acids. *Journal of Nutrition* 131, 2556S–2561S.



- Gietzen, D.W. and Magrum, L.J. (2001) Molecular mechanisms in the brain involved in the anorexia of branched-chain amino acid deficiency. *Journal of Nutrition* 131, 851S–855S.
- Harper, A.E., Miller, R.H. and Block, K.P. (1984) Branched-chain amino acid metabolism. *Annual Review of Nutrition* 4, 409–454.
- Harris, R.A., Kobayashi, R., Murakami, T. and Shimomura, Y. (2001) Regulation of branched-chain  $\alpha$ -keto acid dehydrogenase kinase expression in rat liver. *Journal of Nutrition* 131, 841S–845S.
- Haussinger, D., Graf, D. and Weiergraber, O.H. (2001) Glutamine and cell signalling in liver. *Journal of Nutrition* 131, 2509S–2514S.
- Herzlich, B.C., Lichstein, E., Schulhoff, N., Weinstock, M., Pagala, M., Ravindran, K., Namba, T., Nieto, F.J., Stabler, S.P., Allen, R.H. and Malinow, M.R. (1996) Relationship among homocyst(e)ine, vitamin B-12 and cardiac disease in the elderly: association between vitamin B-12 deficiency and decreased left ventricular ejection fraction. *Journal of Nutrition* 126, 1249S–1253S.
- Hung, C.J., Huang, P.C., Lu, S.C., Li, Y.H., Huang, L.B., Lin, B.F., Chang, S.J. and Chou, H.F. (2002) Plasma homocysteine levels in Taiwanese vegetarians are higher than those of omnivores. *Journal of Nutrition* 132, 152–158.
- Hutson, S.M. and Harris, R.A. (2001) Introduction. *Journal of Nutrition* 131, 839S–840S.
- Hutson, S.M., Lieth, E. and LaNoue, K.F. (2001) Function of leucine in excitatory neurotransmitter metabolism in the central nervous system. *Journal of Nutrition* 131, 846S–850S.
- Jacques, P.F., Kalmbach, R., Bagley, P.J., Russo, G.T., Rogers, G., Wilson, P.W.F., Rosenberg, I.H. and Selhub, J. (2002) The relationship between riboflavin and plasma total homocysteine in the Framingham offspring cohort is influenced by folate status and the C677T transition in the methylenetetrahydrofolate reductase gene. *Journal of Nutrition* 132, 283–288.
- Jefferson, L.S. and Kimball, S.R. (2001) Amino acid regulation of gene expression. *Journal of Nutrition* 131, 2460S–2466S.
- Konashi, S., Takahashi, K. and Akiba, Y. (2000) Effects of dietary essential amino acid deficiencies on immunological variables in broiler chickens. *British Journal of Nutrition* 83, 449–456.
- Kusumoto I. (2001) Industrial production of L-glutamine. *Journal of Nutrition* 131, 2552S–2555S.
- Labow, B.I., Souba, W.W. and Abcouwer, S.F. (2001) Mechanisms governing the expression of the enzymes of glutamine metabolism – glutaminase and glutamine synthetase. *Journal of Nutrition* 131, 2467S–2474S.
- Lawrence, B.V., Schinckel, A.P., Adeola, O. and Cera, K. (2002) Impact of betaine on pig finishing performance and carcass composition. *Journal of Animal Science* 80, 475–482.
- Lobley, G.E., Hoskin, S.O. and McNeil, C.J. (2001) Glutamine in animal science and production. *Journal of Nutrition* 131, 2525S–2531S.
- Lynch, C.J. (2001) Role of leucine in the regulation of mTOR by amino acids: revelations from structure-activity studies. *Journal of Nutrition* 131, 861S–865S.
- Malinow, M.R. (1996) Plasma homocyst(e)ine: a risk factor for arterial occlusive diseases. *Journal of Nutrition* 126, 1238S–1243S.
- Medina, M.A. (2001) Glutamine and cancer. *Journal of Nutrition* 131, 2539S–2542S.
- Miller, F.M., Blair, H.T., Birtles, M.J., Reynolds, G.W., Gill, H.S. and Revell, D.K. (2000) Cysteine may play a role in the immune response to internal parasites in sheep. *Australian Journal of Agricultural Research* 51, 793–799.
- Mills, J.L., Scott, J.M., Kirke, P.N., McPartlin, J.M., Conley, M.R., Weir, D.G., Molloy, A.M. and Lee, Y.J. (1996) Homocysteine and neural tube defects. *Journal of Nutrition* 126, 756S–760S.
- Nelson, G., Chandrashekar, J., Hoon, M.A., Feng, L., Zhao, G., Ryba, N.J.P. and Zuker, C.S. (2002) An amino-acid taste receptor. *Nature* 416, 199–202.
- Neu, J. (2001) Glutamine in the fetus and critically ill low birth weight neonate: metabolism and mechanism of action. *Journal of Nutrition* 131, 2585S–2589S.
- Newsholme P. (2001) Why is L-glutamine metabolism important to cells of the immune system in health, postinjury, surgery or infection? *Journal of Nutrition* 131, 2515S–2522S.
- Oehler, R., Pusch, E., Dungal, P., Zellner, M., Eliassen, M.M., Brabec, M. and Roth, E. (2002). Glutamine depletion impairs cellular stress response in human leucocytes. *British Journal of Nutrition* 87, S17–S21.
- O'Quinn, P.R., Knabe, D.A. and Wu, G. (2002) Arginine catabolism in lactating porcine mammary tissue. *Journal of Animal Science* 80, 467–474.
- Owen, K.Q., Ji, H., Maxwell, C.V., Nelssen, J.L., Goodband, R.D., Tokach, M.D., Tremblay, G.C. and Koo, S.I. (2001) Dietary L-carnitine suppresses mitochondrial branched-chain keto acid dehydroge-

- nase activity and enhances protein accretion and carcass characteristics of swine. *Journal of Animal Science* 79, 3104–3112.
- Reeds, P.J. and Burrin, D.G. (2001) Glutamine and the bowel. *Journal of Nutrition* 131, 2505S–2508S.
- Rennie, M.J., Bowtell, J.L., Bruce, M. and Khogali, S.E.O. (2001) Interaction between glutamine availability and metabolism of glycogen, tricarboxylic acid cycle intermediates and glutathione. *Journal of Nutrition* 131, 2488S–2490S.
- Rosenberg, I.H. (1996) Homocysteine, vitamins and arterial occlusive disease: an overview. *Journal of Nutrition* 126, 1235S–1237S.
- Rosenquist, T.H. and Finnell, R.H. (2001) Genes, folate and homocysteine in embryonic development. *Proceedings of the Nutrition Society* 60, 53–61.
- Selhub, J., Jacques, P.F., Bostom, A.G., D'Agostino, R.B., Wilson, P.W.F., Belanger, A.J., O'Leary, D.H., Wolf, P.A., Rush, D., Schaefer, E.J. and Rosenberg, I.H. (1996) Relationship between plasma homocysteine, vitamin status, and extracranial carotid-artery stenosis in the Framingham study population. *Journal of Nutrition* 126, 1258S–1265S.
- Stabler, S.P., Lindenbaum, J. and Allen, R.H. (1996) The use of homocysteine and other metabolites in the specific diagnosis of vitamin B-12 deficiency. *Journal of Nutrition* 126, 1266S–1272S.
- Suchner, U., Heyland D.K. and Peter, K. (2002) Immune-modulatory actions of arginine in the critically ill. *British Journal of Nutrition* 87, S121–S132.
- Upchurch, G.R., Welch, G.N. and Loscalzo, J. (1996) Homocysteine, EDRF and endothelial function. *Journal of Nutrition* 126, 1290S–1294S.
- Wilmore, D.W. and Rombeau, J.L. (2001) Introduction to the symposium proceedings. *Journal of Nutrition* 131, 2447S–2448S.
- Wu, G., Pond, W.G., Flynn, S.P., Ott, T.L. and Bazer, F.W. (1998) Maternal dietary protein deficiency decreases nitric oxide synthase and ornithine decarboxylase activities in placenta and endometrium of pigs during early gestation. *Journal of Nutrition* 128, 2395–2402.
- Ziegler, T.R. (2002) Glutamine supplementation in bone marrow transplantation. *British Journal of Nutrition* 87, S9–S15.



# Index

---

- Absorption
- amino acids 41–62, 191
    - emerging concepts 61–62
    - flux 46–48
    - free 55–61
    - mediated 55–61
    - in modelling 191
  - D-isomers 61–62
  - end products of protein digestion 44–46
  - free amino acids 55–61
    - expression of transporters 60–61
    - transporters 55–60
  - mediated 55–61
    - free amino acids 55–61
  - peptides 41–62
  - transport activities 48–55
    - H<sup>+</sup>-dependent 49–51
    - PepT1 51–55
    - peptide-bound amino acids 48–55
  - visceral flux 45–48
    - amino acids 46–48
    - peptides 45–46
- Accretion, amino acids 7–8
- Age, and amino acid requirements 246–247, 248–250
- γ-Aminobutyrate (GABA) 75, 82
- Ammonia 73, 74, 266–271, 273, 274, 281, 332–333
- Analogues
- of arginine 3–4, 77, 78, 135–137, 256, 257
    - canavanine 3–4, 77, 78, 135–137, 256, 257
  - of aromatic amino acids 3, 77, 79, 134–135, 137
    - mimosine 3, 77, 79, 134–135, 137
  - of methionine 146, 357
  - structural 3–4
  - of sulphur amino acids 3–4, 135, 137–138
    - S-methylcysteine sulphoxide (SMCO) 3–4, 135, 137–138
    - utilization 4, 5
- Analysis, amino acids 15–31
- chromatographic separation 22–27
  - collaborative trials 17, 18
  - detection 22–27
  - free 20–22
  - precision and accuracy 20–21, 29
  - sample preparation 16–20
  - taurine 20, 22
  - tryptophan 17, 19–20
- Antagonisms
- branched-chain amino acids (BCAA) 130–132, 257, 258
    - and brain metabolism 132
    - complexity 131
    - mechanisms 131–132
    - in poultry nutrition 130–132, 257, 258
    - specificity 130–131
    - valine sensitivity 131
  - lysine–arginine 132–133, 255–257
    - in chickens 132–133, 255–257
    - in mammals 133
    - mechanisms 133
    - and plasma amino acids 132–133
    - reciprocity 133
    - specificity 132–133
  - non-protein amino acids 3–4, 133–138
    - arginine analogues 135–137
    - canavanine 135–137, 256, 257
    - mechanisms 136–138
    - mimosine 134–135, 137
    - S-methylcysteine sulphoxide (SMCO) 3–4, 135, 137–138
    - neurotoxic amino acids 136

- Arginine**  
analogue 3–4, 77, 78, 135–137  
antagonism by lysine 132–133, 255–257  
  in chickens 132–133, 255–257  
  in mammals 133  
  mechanisms 133  
  and plasma amino acids 132–133  
  reciprocity 133  
  specificity 132–133  
digestible 232  
and essential to non-essential amino acid ratios 105  
and fetal growth 206  
finfish requirements 430–431  
intakes 247, 251, 255–256  
in lactation 357–358  
metabolism 9–10, 75–76, 81, 488–489  
  in mammary tissue 489  
in nitric oxide (NO) synthesis 76, 358, 489  
in polyamine synthesis 76–77, 488, 489  
ratio estimates for chickens 232–233  
roles 488–489  
in urea cycle 75–76, 488–489  
utilization 255–256  
Asparagine, requirements 117
- Basolateral membrane vesicles (BLMV)** 50  
**Betaine (trimethyl glycine)** 151–152, 338, 491  
**Bioavailability**  
  amino acids 494  
  D-cysteine 145  
  and ileal digestibility 148  
  D-methionine 145  
  methionine analogues 146, 147  
**Biological value (BV)** 162–164, 451–452  
**Biosynthesis**  
  adrenaline 82  
  amino acids 71–75, 76, 88–89, 145, 151, 274, 276–277, 319  
    cysteine 145, 319  
    key reactions 71–75  
    methionine 89, 145, 151  
  in mammalian metabolism of canavanine 77, 78  
  in rumen 274, 276–277  
  in urea cycle 75–76  
  creatine 81  
  haem 81  
  5-hydroxytryptamine 82  
  nicotinamide 83  
  nitric oxide (NO) 76  
  noradrenaline 82  
  polyamines 76–77  
  pyrimidines 77, 78, 80  
  urea 75–76  
  uric acid 77, 80
- Branched-chain amino acids (BCAA)**  
  antagonisms 130–132, 257–258, 434  
    and brain metabolism 132  
    complexity 131  
    in fish nutrition 434  
    mechanisms 131–132  
    and plasma amino acid concentrations 130–131  
  in poultry nutrition 130–132, 257, 258  
  specificity 130–131  
  isoleucine 130–132, 231, 257–259, 432  
    antagonism with leucine 130–132  
    and carcass composition 257–259  
    digestible 231  
    finfish requirements 432  
    ratio estimates for chickens 231  
    requirements 257, 432  
  leucine 83, 130–132, 257, 433, 434, 486–487, 488  
    antagonism of isoleucine and valine 130–132, 257, 434  
    degradation 83  
    fetal metabolism 487, 488  
    finfish requirements 433  
    flux 487, 488  
    molecular action 8, 486–487  
    transport 487  
  metabolism 83, 485–488  
  molecular action 9, 486–487  
  oxidation 485–486  
  transamination 74  
  valine 7, 8, 130–132, 231–232, 257–258, 433  
    antagonism by leucine 130–132, 257–258  
    digestible 231–232  
    finfish requirements 433  
    ratio estimates for chickens 231–232  
    utilization 257–258  
    whole-body accretion 7, 8
- Brush border membrane vesicles (BBMV)** 49–50, 53
- Canavanine** 3–4, 77, 78, 135–137, 256, 257  
**Canola/rapeseed meal, amino acid digestibility values** 173, 177, 179, 180  
**Carcass composition, amino acid effects** 7, 257–259  
**Casein** 368, 369–371, 379  
  postruminal infusion 368–371  
**Cats, amino acid requirements** 411–423  
  creatine 419–420  
  feline 419  
  gastrointestinal losses 413–415  
  hair losses 416–418  
  maintenance 412–413

- 3-methylhistidine 419  
protein turnover 420–423  
urinary losses 415–416
- Cattle
- dairy cows 350–360, 367–382
    - amino acid uptake and metabolism 350–360
    - effects of amino acids on milk production 367–382
    - milk production 350–360, 367–382
  - flux of amino acids 47
  - growth 335–341
    - amino acid requirements 335–341
  - lactation requirements 392, 393–394, 402–403
    - application of CNCPS model 402–403
  - PepT1 mRNA expression 51–52
  - peptide transport 49
  - steers 403–405
    - application of CNCPS model 403–405
  - utilization of amino acids 335–341
- Cereal grains/byproducts
- amino acid digestibility values 173, 177, 179, 180, 226
  - maize gluten meal 226–227
- Chickens *see* Poultry
- Choline 151–152, 338
- Chromatography
- comparison of methods 24–27
  - high performance (HPLC) 19, 23, 24–27, 28
  - ion-exchange (IEC) 22–23, 25
- Citric acid cycle 85
- Classification
- adverse effects of amino acids 125–139
    - antagonisms 130–138
    - imbalances 125–130
    - toxicity 138
  - enzymes 73
  - essential amino acids 2–3, 158–159
  - non-essential amino acids 158
  - nutritional 1–4, 88–89, 104–105
    - amino acids 1–4, 88–89, 104–105
- Cornell Net Carbohydrate and Protein System (CNCPS), in prediction of amino acid adequacy for ruminants 329–332, 334, 389–406
- adjusting animal and dietary factors 399–401
  - animal factors 399
  - applications 401–405
  - diet balances 390–406
  - energy supply effects 329–332
  - feed factors 398–399
  - intestinal digestion 397
  - lactation requirements 392, 393–394
  - maintenance requirements 391–392
  - metabolism 398
  - pregnancy requirements 392, 393
  - research needed 405–406
  - supply issues 394–397
  - tissue deposition 392–393
- Cows *see* Cattle
- Creatine 81, 419–420
- Cyst(e)ine *see* Sulphur amino acids
- Deficiency, amino acids 4–8, 336
- accretion 7–8
  - in calves 336
  - feeding methods 6, 7
  - and maintenance requirements 4, 7–8
  - morphological changes 5–6
- Deletion studies 5–7, 227, 336–337
- Diet-dilution technique
- and amino acid imbalance 127, 238, 252–254
  - amino acid responses 238–242
  - and carcass composition 258
- Diets, formulation 178–182
- use of ileal digestible lysine 180–182
- Digestibility, amino acids 169–183, 225–234
- for chickens 225–234
  - faecal 170–172
  - ileal 170–183
  - sources of variation 172–174
  - transformation of apparent into true values 174–178
- Digestion
- gastric 42–43
  - mucosal 44
  - prediction 397
  - protein 42–44
    - carboxypeptidases 43–44
    - chymotrypsin 43–44
    - elastase 43
    - pepsins 43
    - peptidases 44
    - trypsin 43–44
  - in small intestine 43–44
- Dogs
- amino acid requirements 411–423
  - creatinine 419–420
  - gastrointestinal losses 413–415
  - hair losses 416–418
  - maintenance 412–413
  - 3-methylhistidine 419
  - protein turnover 420–423
  - urinary losses 415–416
  - gluconeogenesis 3

- Economic assessment, amino acid responses  
 459–482  
 broiler chickens 461–473  
 lysine 464–467, 468, 473–475, 476, 477, 478–481  
 methionine + cystine 463–465, 472, 473, 474, 477  
 Peking ducks 470, 472, 473, 474–477  
 statistical models 460–461  
 threonine 467, 468, 469–470, 471, 472, 475–476, 477  
 turkeys 476, 478–481
- Empirical methods  
 and amino acid requirements 187–188  
 amino acid responses 238–242  
 comparison of techniques 239–242  
 diet-dilution technique 238–242, 258  
 graded supplementation technique 238–242, 258  
 limitations 238–239  
 ideal amino acid ratios 223–234
- Energy, and amino acid utilization 250, 252–253, 329–332
- Enzymes, in amino acid metabolism 73–78, 80–85  
 aminotransferases (transaminases) 73–74, 83  
 ammonia assimilation 73, 74, 273–274  
 carbamoyl phosphate synthetase 74  
 decarboxylases 75, 77  
 digestive 43–44  
 glutamate dehydrogenase 73  
 glutamine synthase 74  
 oxidases 74–75  
 phenylalanine hydroxylase 75  
 in urea cycle 75–76
- Essential amino acids, in nutritional classification 2–3, 158–159
- Factorial methods, amino acid responses 242–243
- Feather meal 375–376, 378
- Feeds, amino acids 15–31, 163, 173, 177, 179, 180, 181  
 applications 30–31  
 available/reactive lysine 27–28  
 chromatographic separation and detection 22–27  
 digestibility values 173, 177, 179, 180, 181  
 near-infrared spectroscopy (NIRS) 29–30  
 precision and accuracy 20–21, 29  
 protein quality 163  
 sample preparation 16–20
- Fermentation  
 production of amino acids 495–496  
 rumen 395–397  
 and CNCPS model 395–397
- Fetus  
 amino acid metabolism 492–493  
 glutamine 492–493  
 amino acid uptake 209  
 protein content 208  
 requirement for amino acids 205–206, 207, 209
- Finfish  
 amino acid composition 439–440  
 amino acid requirements 427–442  
 arginine 430–431  
 determination 428–430  
 histidine 431–432  
 interactions 434  
 isoleucine 432  
 leucine 433  
 lysine 434–435  
 methionine 435–436  
 phenylalanine 436–437  
 qualitative aspects 428  
 quantitative studies 430–438  
 threonine 437  
 tryptophan 437–438  
 valine 433
- Fish meal 173, 375, 376
- Flux  
 amino acids 46–48, 350–351, 487, 488  
 leucine 487, 488  
 visceral 45–48  
 amino acids 46–48  
 peptides 45–46
- Food intake-mediated factors, and amino acid responses 243–255  
 age 246–247, 248, 249, 250  
 coccidiostats 254–255  
 environmental temperature 243–245  
 imbalance 252–254  
 immunological stress 244–246  
 metabolizable energy (ME) concentration 250, 252–253  
 sex 245, 247, 248  
 species 247–251  
 vitamins 254
- Gestation  
 ruminants 392, 393  
 amino acid requirements 392, 393  
 sows 205–209  
 amino acid needs 205–209  
 fetal growth 205–206  
 ideal amino acid pattern 206–209
- Gluconeogenesis 3, 83, 84, 85, 378–379
- Glutamate  
 non-essential N source 109–110  
 role 73–74, 75, 80, 81  
 supplementation 117
- Glutamine  
 in health and disease 93

- as immune modulator 490, 492
- as metabolic regulator 94
- metabolism 74, 80, 489–490, 492–493
- in purine and pyrimidine synthesis 80
- synthesis 74
- Glycine
  - requirements 117
  - role 81
- Goats
  - fibre growth 312, 313, 316, 317, 318, 322
  - lactating 352, 356, 357
    - amino acid uptake and metabolism 352, 356, 357
- Graded supplementation technique
  - amino acid responses 238–242
  - and carcass composition 258
- Growth
  - fetal 205–206, 207–209
  - fibre 312, 313, 316, 317, 318, 322
  - optimum amino acid ratios 106–112
    - chickens 108–109, 110
    - kittens 111
    - pigs 107–108, 110
    - rats 106–107, 110
  - pigs 190, 192–193
    - amino acid requirements 192–193
    - amino acid utilization 190
  - poultry 237–260
    - amino acid utilization 237–260
  - ruminants 329–343
    - amino acid utilization 329–343
  - wool 310–323
    - amino acid utilization 310–323
- Haemolytic anaemia 4
- Hair, amino acid content 161, 416–418
- Health and disease states
  - glutamine 93
  - role of amino acids 93–94
- Histidine
  - finfish requirements 431–432
  - growing cattle 337
  - in histamine production 75
  - infusion in dairy cows 374–375, 380, 381
- Homocysteine *see* Sulphur amino acids
- Hormones, and nutrient partitioning 323
- Hydrolysis
  - acid 16–18
  - alkaline 17–20
  - of peptides 42
- Ideal patterns, amino acids 157–166, 206–209, 213–215, 223–234
- Ideal protein concept 213–215, 441–442, 493
- Imbalances, amino acids 125–130, 252–254, 493
  - biochemical mechanisms 128–129
  - and brain metabolism 128–129
  - in cattle nutrition 128
  - definition 125–126
  - in diet-dilution technique 127, 238–239
  - and dietary preferences 128
  - and food intake 128–129
  - and growth 126–127
  - and lysine utilization 252–254
  - and neurotransmitters 129
  - and nutrient utilization 129–130
  - overview 493
  - practical implications 126–128
  - and tissue amino acids 128–129
  - at tissue level in pigs 127, 130
- Immune modulators
  - amino acids 10, 492
  - glutamine 490, 492
- Insulin 379, 380
- Ion-exchange chromatography (IEC) 22–23, 25, 494
- Isoleucine *see* Branched-chain amino acids (BCAA)
- Isomers, amino acids 4, 5
- $\alpha$ -Keto acids 74
- Ketogenesis 3, 83–85
- Kittens, optimum amino acid ratios 111
- Lactation
  - in ruminants 347–360, 367–382, 392, 393–394, 402–403
    - application of CNCPS model 402–403
    - effects of amino acids on milk production 367–382
    - prediction of amino acid requirements 392, 393–394
    - uptake and metabolism of amino acids 347–360
  - in sows 160–162, 209–216
    - amino acid needs 209–215
    - body condition 212–213
    - ideal protein 213–215
    - mammary gland requirements 210–211
    - milk composition 160–162
    - milk production 211–212
    - postweaning requirements 215–216
    - return to oestrus 213
- Legume seeds, amino acid digestibility values 173, 175, 179, 180
- Leucine *see* Branched-chain amino acids (BCAAs)
- Liver, and amino acid deficiency 6, 7
- Lysine
  - antagonism of arginine 132–133, 255–257
  - in chickens 132–133, 255–257
  - in mammals 133



Lysine *continued*

- antagonism of arginine *continued*
  - mechanisms 133
  - and plasma amino acids 132–133
  - reciprocity 133
  - specificity 132–133
- available/reactive 27–28
- and carcass composition 257–258, 260
- in dairy rations 357
- degradation 83, 84
- digestible 227–229
- ileal digestibility 172, 173, 174, 177, 179, 180–182
  - pigs 172, 173, 174, 177, 179, 180–182
- infusion in lactation 374–375, 378, 381
- intake 239–242, 243–248, 254
  - chickens 239–242, 243–248, 254
  - rats 240
- interaction with dietary crude protein (CP) 241–242, 252–254
- ratio estimates for chickens 227–229
- requirements 339–341, 434–435
  - cattle 339–341
  - finfish 434–435
- responses of poultry 227–229, 239–242, 243–248, 254, 464–467, 468, 473–475, 476, 477, 478–481
  - economic assessment 464–467, 468, 473–475, 476, 477, 478–481
  - growth 227–229, 239–242, 243–248, 254
- utilization 194–196, 252–254
  - pigs 194–196
  - poultry 252–254
- whole-body accretion 7, 8
- in wool production 318–319

## Maintenance

- amino acid requirements 7–8, 190, 191–192, 242, 391–392, 412–413
  - cats and dogs 412–413
  - pigs 190, 191–192
  - poultry 242
  - ruminants 391–392
- optimum essential to non-essential amino acid ratios 115–117
- species comparison 116

## Metabolism

- of amino acids 71–85, 87–98, 145, 151, 187–199, 291–305, 319–322, 347–360, 398, 420–423, 430, 485–492, 497
  - absorptive 93, 349–351
  - arginine 75–76, 81, 488–489
  - aspartate 80

- availability 349–354
- biosynthesis 71–75, 76, 88–89, 145, 151
- branched-chain amino acids (BCAA) 83, 356–357
- canavanine 77, 78
- channelling 301–303
- cysteine 84
- enzymes 73–85
- future considerations 97–98, 497
- in gluconeogenesis 83, 84, 85
- glutamate 73–74, 75
- glutamine 74, 80, 489–490, 492–493
- glycine 81
- hepatic 352–354
- in intact animals 304–305
- intestinal synthesis 91–92
- in ketogenesis 83–85
- key reactions 71–75
- in lactating ruminants 347–360
- lactational drive 348–349
- leucine 83, 497
- links to energy metabolism 85, 91
- lysine 84
  - by mammary gland 354–358
- methionine 78, 319–322
- in milk protein synthesis 355–356
- mimosine 77, 79
- modelling 291–305, 358–360
- ornithine 76–77
- overview 71–85, 87–98, 485–492
- oxidation 420–423, 430
- pathways 71–85, 92, 145, 151, 319
- peripheral 92
- pigs 187–199
- prediction in ruminants 398
- recommendations 497
- recycling 303
- ruminants 291–305
- transport systems 354–355
- transsulphuration 319–320
- tryptophan 82, 83
- tyrosine 82

## in rumen 265–283

- amino acids 265–283
- ammonia 266–271, 273–274, 281
- microbial protein synthesis 273–278
- peptides 267–268, 271
- protein 265–267, 271
- requirements of microbes 279–282
- toxicity 278
- transport of products 272
- urea 269, 271

Metabolizable energy (ME), and amino acid responses 250, 252–253

Methionine *see* Sulphur amino acids

- Methodology, for essential to non-essential amino acid ratios 105–106  
approaches 105–106  
criteria 106
- 3-Methylhistidine 10–11, 419
- Microbes 265–283
- Milk  
amino acid composition 160–162, 212, 349, 391  
sow 160–162, 212  
constituents 368–370, 373–378, 379, 380–381  
fat 368, 380–381  
lactose 368, 379, 380  
protein 368–370, 373–378  
production 367–382, 391, 392, 393–394, 402–403  
application of CNCPS model 402–403  
effects of amino acids 367–382  
effects of essential amino acids 371–372  
effects of non-essential amino acids 372–373  
effects of specific amino acids 371–375, 378  
efficiency of use of amino acids for protein secretion 373–377  
fat content responses 380–382  
protein content responses 377–380  
requirements for amino acids 392, 393–394  
responses to infusions of protein and amino acids 368–375  
protein synthesis 355–356
- Mimosine 3, 77, 79, 134–135, 137
- Models  
pigs 187–199  
amino acid metabolism and requirements 187–199  
ruminants 291–305, 329–332, 334, 358–360, 389–406  
amino acid metabolism 291–305, 358–360  
analytical 297–303  
Cornell (CNCPS) 293–294, 329–332, 334, 389–406  
digestive elements 292–294  
National Research Council (NRC) 292–293  
protected amino acids 294–296  
University of California (UC) Davis 296–297  
statistical 460–461
- Molecular action of amino acids 8–9, 486–487
- Muscle, and amino acid deficiency 6, 7
- Near-infrared spectroscopy (NIRS), in amino acid analysis 29–30
- Neurolathrogens 3, 4
- Neurotransmitters  
action 82  
and amino acid imbalance 129  
in branched-chain amino acid (BCAA) antagonisms 132  
synthesis 8, 9, 82
- Nitric oxide  
role 358  
synthesis 9–10, 76
- Nitrogen emission, and amino acids 449–456  
animal factors 450–451  
enhancing biological value (BV) of dietary protein 451–452  
feed and feeding strategy 451–452, 453–454  
nitrogen consumption 451  
nitrogen flow 450  
nitrogen surpluses 451–452  
quality of manure 455–456  
supplements 452–454
- Nitrogen retention/utilization/balance  
effects of essential to total amino acid N ratios 112–115  
endogenous protein 114  
pigs 112–114  
effects on transfer of amino acids into milk 375–377  
optimum amino acid ratios 106–112  
chickens 109, 110  
pigs 108, 110  
rats 110
- Non-protein amino acids  
canavanine 3–4, 77, 78, 256, 257  
S-methylcysteine sulphoxide (SMCO) 3–4, 135, 137–138  
mimosine 3, 77, 79, 134–135, 137
- Non-specific nitrogen, sources 110–112
- Nutrient utilization, and amino acid imbalance 129–130
- Ovulation 204
- Partition, amino acids 190, 313–315, 352–354  
in growing pigs 190  
in lactation 352–354  
in wool production 313–315
- Pathways, amino acid metabolism 71–85, 92, 145, 151, 319
- Penaeid shrimp 438–439
- Peptides  
absorption 41–62  
in amino acid transport 48–55

- Peptides *continued*  
 digestion 44  
 flux 45–46  
 metabolism 267–268, 271  
 transport by rumen microbes 272  
 uptake 42
- Pigs  
 amino acid imbalance 127, 130  
 digestible amino acids 169–183  
   in diet formulation 169–183  
   faecal 170–172  
   ileal 170–183  
   practical use 178–182  
   sources of variation 172–174  
   transformation of apparent to true values 174–178  
 effects of essential to total amino acid N ratios 112–115  
 feeding strategy 454  
 ideal amino acid profiles 157–166, 206–209, 213–215  
   and biological value (BV) 162–164  
   definition 159–160  
   essential and non-essential amino acids 158–159  
   establishment 160–162  
   experimental conditions 164–166  
   expression 158–160  
   protein sources 163  
   sows 206–209, 213–215  
   utilization of free amino acids 164  
 flux of amino acids 47–48  
 maintenance amino acid requirements 190, 191–192  
 methionine and cystine 143–152  
   analogues 146, 147  
   bioavailability 145–146, 148  
   conversion pathways 144, 145  
   excess 151  
   ileal digestibility 148  
   metabolic conversions 144  
   methyl donors 151–152  
   nutritional essentiality 144–145  
   replacement efficacy 148–150  
   requirements 146–148  
   and sulphur amino acid (SAA) requirements 146–148  
 optimum amino acid ratios 107–108, 110  
 PepT1 mRNA expression 51–52  
 peptide transport 49, 54  
 requirements 187–199  
   amino acids 187–199  
 sows 160–162, 203–216  
   amino acid utilization 203–216  
   gestating 205–209  
   gilts 203–205  
   lactating 209–216  
   milk composition 160–162  
   in postweaning period 215–216
- Polyamines  
 and methionine utilization 319–321  
 synthesis 9, 76–77
- Poultry  
 chickens 7–8, 108–109, 110, 126–127, 130–133, 135–137, 223–234, 237–260, 461–473  
   accretion of amino acids 7–8  
   amino acid imbalance 126–127  
   branched-chain amino acid (BCAA) antagonisms 130–132, 257, 258  
   canavanine antagonism 135–137, 256, 257  
   carcass composition 257–260  
   economic assessment of amino acid responses 461–473  
   ideal amino acid patterns 223–234  
   lysine–arginine antagonism 132–133, 255–257  
   lysine intake 239–242, 243–248, 254  
   methionine + cystine intake 246–247, 249, 250, 251–253, 255  
   optimum amino acid ratios 108–109, 110, 223–234  
 Peking ducks 470, 472, 473, 474–477  
   economic assessment of amino acid responses 470, 472, 473, 474–477  
 turkeys 248–250, 251, 257–258, 476, 478–481  
   arginine intake 251  
   economic assessment of amino acid responses 476, 478–481  
   methionine + cystine intake 250, 251  
   valine intake 257–258
- Pregnancy *see* Gestation
- Profiles/patterns, ideal amino acids 157–166, 206–209, 213–215, 223–234  
 chickens 223–234  
 gestating sows 206–209  
 lactating sows 213–215  
 pigs 157–166, 206–209, 213–215  
 ratios 206–209, 213–215, 223–234
- Proline, requirements 117
- Protein  
 deposition 196, 198, 199, 440  
 dietary 241–242  
   and amino acid responses 241–242  
 digestion 42–44  
 efficiency 95–97, 310  
 endogenous 114  
 energy relationships 329–332  
 ideal 103, 441–442

- metabolism 6, 7
- metabolizable protein (MP) 292, 293, 339, 391, 393, 395, 398, 399, 401, 404
- microbial crude protein (MCP) 292, 293
- and N excretion 95–96
- rumen degraded protein (RDP) 292, 294
- rumen undegraded protein (RUP) 292, 293
- synthesis 273–277, 297–301
- turnover 96, 297–303, 420–423
- undegradable dietary protein (UDP) 292, 293, 295, 368
- utilization 193–194
- Puberty 204
- Pyrimidines 77–78, 80
  
- Ratios
  - essential to non-essential amino acids 103–118
    - classification 104–105
    - definition issues 104–106
    - effects on protein and amino acid utilization 112–115
    - expression of relationships 104
    - importance of non-essential amino acids 117–118
    - for maintenance 115–117
    - methodology 105–106
    - optimum values 106–112
  - ideal amino acids 157–166, 206–209, 213–215, 223–234
    - application 233–234
    - arginine assay 232–233
    - bioassays 225–233
    - chickens 223–234
    - fish 441–442
    - isoleucine assay 231
    - lysine assay 227–229
    - pigs 157–166
    - sows 206–209, 213–215
    - threonine assay 230–231
    - tryptophan assay 229–230
    - valine assay 231–232
- Rats
  - lysine intake 240
  - methionine + cystine intake 251
  - optimum amino acid ratios 106–107, 110
  - peptide transport 53
- Reading model 494
- Recommendations
  - absorption issues 497
  - amino acid analysis 496, 497
  - metabolism 497
  - modelling 498
  - utilization 497–498
- Regulators, amino acids 94–95
  - glutamine 94
  - in hormone synthesis and secretion 95
  - leucine 95
- Requirements
  - for amino acids 90–91, 146–150, 187–199, 279–282, 335–343, 391–394, 411–423, 427–442
    - cats and dogs 411–423
    - cattle 335–341, 391–394
    - comparative 90–91
    - empirical approach 187–188
    - finfish 427–438
    - metabolic differences 90
    - models 188–199
    - penaeid shrimp 438–439
    - pigs 187–199
    - preruminant calf 335–336
    - rumen microbes 279–282
    - ruminants 336–343, 391–394
    - sheep 341–343
  - for sulphur amino acids (SAA) 146–150
    - efficacy of cystine 148–150
    - pigs 146–148
    - role of methionine 150
- Rumen
  - fermentation 395–397
    - and CNCPS model 395–397
    - microbial metabolism 265–283
- Ruminants *see* Cattle; Goats; Sheep
  
- Safety, amino acids 495–496
- Sample preparation, amino acid analysis 16–20
  - acid hydrolysis and oxidation 16–17, 18
  - collaborative trials 17, 18
  - tryptophan 17, 19–20
- Serine, in wool production 318
- Sheep
  - amino acid utilization 309–323, 341–343
    - for growth 341–343
    - and wool production 309–323, 342
  - flux of amino acids 47, 350–351
  - PepT1 mRNA expression 51–52
  - peptide transport 49
- Sows *see* Pigs
- Soybean
  - flakes 171
    - amino acid digestibility values 171
  - meal 173, 179, 180
    - amino acid digestibility values 173, 179, 180
  - protein isolate (SPI) 175, 368–369
    - amino acid digestibility values 175
    - and milk production 368–369
- Species, amino acid requirements 247–251
- Sulphur amino acids
  - analogues 3–4, 134–135, 137–138
  - cyst(e)ine
    - biosynthesis 144, 145

- Sulphur amino acids *continued*  
  cyst(e)ine *continued*  
    in cattle nutrition 338  
    catabolism 83, 84  
    D-isomer bioavailability 145  
    excess 151  
    in pig nutrition 143–152  
    and sulphur amino acid (SAA)  
      requirements 146–150  
    in wool production 310–322  
  economic assessment of responses 463–465,  
    472, 473, 474, 477  
    broiler chickens 463–465  
    Peking ducks 472, 473, 474, 477  
  homocysteine 10, 78, 79, 151–152,  
    490–491  
    conversion to methionine 151–152  
    metabolism 490–491  
    role 10, 78, 79  
  methionine 78, 79, 80, 143–152, 173, 179,  
    310–322, 337–341, 357, 435–436,  
    491–492  
    analogues 146, 147  
    bioavailability of D-isomer 145  
    as cysteine source 319–320, 338  
    to cystine conversion 143–152,  
    491–492  
    excess 151  
  finfish requirements 435–436  
  ileal digestibility values 173, 179  
  in lactation 357  
    and other methyl donors 151–152  
    in pig nutrition 143–152, 173, 179  
    role 78, 79, 80  
    utilization by cattle 337–341  
    in wool production 310, 311, 312,  
    313, 314, 315, 316–318,  
    319–322  
  methionine + cystine intake 246–247,  
    249–250, 251–253, 255  
    poultry 246–247, 249–250, 251–253,  
    255  
  S-methylcysteine sulphoxide (SMCO) 3–4,  
    135, 137–138  
  whole-body accretion 7, 8  
S-methylcysteine sulphoxide (SMCO) *see* Sulphur  
  amino acids  
Synthesis, chemical 495–496
- Taste receptors 495
- Threonine  
  digestible 230  
  finfish requirements 437  
  ileal digestibility 173, 177, 179, 180  
  pigs 173, 177, 179, 180
- ratio estimates for chickens 230–231  
responses of poultry 230–231, 467, 468,  
  469–470, 471, 472, 475–476, 477  
  broiler requirement 230–231  
  economic assessment 467, 468,  
    469–470, 471, 472, 475–476,  
    477
- Total digestible nutrients (TDN) 292, 293
- Toxicity  
  amino acids 138  
  mimosine 134–135  
  selenoamino acids 135
- Transamination  
  in amino acid biosynthesis 73–74, 89  
  of methionine 319, 321–322
- Transport  
  emerging concepts 61–62  
  free amino acids 55–61  
  peptide-bound amino acids 48–55  
  proteins 48–61  
  by rumen microbes 272
- Tryptophan  
  analysis 17, 19–20  
  finfish requirements 437–438  
  metabolism 82, 83  
  ratio estimates for chickens 229–230
- Tyrosine, metabolism 82
- Urea 75–76, 269, 271, 298
- Uric acid 77, 80
- Utilization  
  of amino acids 112–115, 164, 188–191,  
    193–198, 203–216, 243–258,  
    309–323, 329–343, 497–498  
  cattle 335–341  
  and energy supply 250, 252–253,  
    329–332  
  and essential to non-essential N ratios  
    112–115  
  free 164  
  gestating sows 205–209  
  gilts 203–205  
  in growing ruminants 329–343  
  lactating sows 209–216  
  and nitrogen supply 332–333  
  pigs 188–191, 193–198, 203–216  
  in postweaning period 215–216  
  poultry 243–258  
  recommendations 497–498  
  reproduction 203–216  
  sheep 309–323, 341–343  
  sows 203–216  
  in wool production 309–323  
  in branched-chain amino acid (BCAA) antago-  
    nisms 257–258  
  in lysine–arginine antagonism 255–257

---

Valine *see* branched-chain amino acids (BCAA)

Wheat, amino acid digestibility values 173, 179,  
180

Wool

production 309–323, 342  
amino acid utilization 309–323  
efficiency of protein utilization 310

Wool *continued*

production *continued*  
improving amino acid utilization  
315–319  
and individual amino acids 310–313,  
314, 315, 316–322  
methionine pathways 319–322  
partition of amino acids 313–315, 342  
protein composition 309–311