

**EVIDENCE-BASED**

# **Pediatric Oncology**

SECOND EDITION

Edited by

**Ross Pinkerton, A.G. Shankar**

and **Katherine Matthay**

**BMJ**  
Books



**Blackwell**  
Publishing

# Evidence-based Pediatric Oncology

Second Edition

Edited by

Ross Pinkerton

Childrens Cancer Unit, Mater Childrens Hospital, Raymond Terrace, Brisbane, Australia

AG Shankar

Department of Paediatric and Adolescent Oncology, University College of  
London NHS Trust, London, UK

Katherine Matthay

Department of Pediatric Oncology, University of California at San Francisco,  
San Francisco, CA, USA

 **Blackwell**  
Publishing

**BMJ | Books**

© 2007 by Blackwell Publishing

BMJ Books is an imprint of the BMJ Publishing Group Limited, used under licence

Blackwell Publishing, Inc., 350 Main Street, Malden, MA 02148-5020, USA

Blackwell Publishing Ltd, 9600 Garsington Road, Oxford OX4 2DQ, UK

Blackwell Publishing Asia Pty Ltd, 550 Swanston Street, Carlton, Victoria 3053, Australia

The right of the Author to be identified as the Author of this Work has been asserted in accordance with the Copyright, Designs and Patents Act 1988.

All rights reserved. No part of this publication may be reproduced, stored in a retrieval system, or transmitted, in any form or by any means, electronic, mechanical, photocopying, recording or otherwise, except as permitted by the UK Copyright, Designs and Patents Act 1988, without the prior permission of the publisher.

First edition published 2002

Second edition published 2007

1 2007

*Library of Congress Cataloging-in-Publication Data*

Evidence-based pediatric oncology / edited by Ross Pinkerton, A.G. Shankar, Katherine Matthay. — 2nd ed.

p. ; cm.

Rev. ed. of: Evidence-based paediatric oncology / edited by Ross Pinkerton, Thierry Philip, Beatrice Fervers. 2002.

Includes bibliographical references and index.

ISBN-13: 978-1-4051-4268-7 (hardback : alk. paper)

ISBN-10: 1-4051-4268-5 (hardback : alk. paper)

1. Tumors in children. 2. Evidence-based pediatrics. I. Pinkerton, C. R. (C. Ross), 1950- II. Shankar, A. G. (Ananth Gouri), 1962- III. Matthay, Katherine. IV. Evidence-based paediatric oncology.

[DNLN: 1. Neoplasms. 2. Child. 3. Evidence-Based Medicine. QZ 275 E93 2007]

RC281.C4E95 2007

618.92'994—dc22

2006027487

ISBN: 978-1-4051-42687

A catalogue record for this title is available from the British Library

Set in 9.5/12 pt Minion by Charon Tec Ltd (A Macmillan Company), Chennai, India

[www.charontec.com](http://www.charontec.com)

Printed and bound in Singapore by COS Printers Pte Ltd

Commissioning Editor: Mary Banks

Editorial Assistant: Victoria Pittman

Development Editors: Nick Morgan and Lauren Brindley

Development Assistant: Laura Murphy

Production Controllers: Debbie Wyer and Rachel Edwards

For further information on Blackwell Publishing, visit our website:

<http://www.blackwellpublishing.com>

The publisher's policy is to use permanent paper from mills that operate a sustainable forestry policy, and which has been manufactured from pulp processed using acid-free and elementary chlorine-free practices. Furthermore, the publisher ensures that the text paper and cover board used have met acceptable environmental accreditation standards.

Blackwell Publishing makes no representation, express or implied, that the drug dosages in this book are correct. Readers must therefore always check that any product mentioned in this publication is used in accordance with the prescribing information prepared by the manufacturers. The author and the publishers do not accept responsibility or legal liability for any errors in the text or for the misuse or misapplication of material in this book.

# Contents

Contributors, v

Acknowledgments, vi

Introduction, vii

*Ross Pinkerton*

## **Part 1: Solid Tumors, 1**

*Ross Pinkerton*

1 Rhabdomyosarcoma, 3

*Commentary by Michael Stevens and Meriel Jenney*

2 Osteosarcoma, 26

*Commentary by Alan Craft*

3 Ewing's sarcoma, 49

*Commentary by Alan Craft*

4 Wilms' tumor, 66

*Commentary by Daniel Green*

5 Neuroblastoma, 93

*Commentary by Katherine Matthay*

6 Hepatoblastoma and malignant germ-cell tumors, 115

*Commentary by Ross Pinkerton*

7 Medulloblastoma, 125

*Commentary by Joann Ater*

8 Glioma, 150

*Commentary by Joann Ater*

9 Non-Hodgkin's lymphoma, 162

*Commentary by Tim Eden and Ross Pinkerton*

10 Hodgkin's disease, 199

*Commentary by Tim Eden and Ross Pinkerton*

## **Part 2: Leukemia, 221**

*AG Shankar*

Acute myeloid leukemia, 223

*Commentaries by Judith Chessells and Vaskar Saha*

11 Induction regimens in acute myeloid leukemia, 227

12 Role of autologous BMT in children with acute myeloid leukemia in first remission, 240

13 Role of maintenance treatment in childhood acute myeloid leukemia, 250

Childhood lymphoblastic leukemia, 267

*Commentaries by Vaskar Saha and Judith Chessells*

14 Steroids and asparaginases during remission induction therapy in childhood lymphoblastic leukemia, 279

15 CNS prophylaxis in childhood lymphoblastic leukemia, 327

16 Continuing therapy in childhood lymphoblastic leukemia – duration of continuing therapy, 400

## **Part 3: Supportive Care in Pediatric Oncology, 453**

*Katherine Matthay and AG Shankar*

17 Use of hemopoietic colony stimulating factors (G-CSF, G-MCSF and erythropoietin), 459

18 Cardioprotection in pediatric oncology, 538

Index, 553



*This page intentionally left blank*

# Contributors

## **Joann Ater**

MD Anderson Cancer Center, University of Texas, 1515  
Holcombe Boulevard, Houston, TX, USA

## **Judith Chessells**

Department of Haematology, Institute of Child Health,  
London, UK

## **Alan Craft**

School of Child Medical Sciences, University of Newcastle  
upon Tyne, Royal Victoria Infirmary, Queen Victoria Road,  
Newcastle upon Tyne, UK

## **Tim Eden**

Academic Unit of Paediatric Oncology, Christie Hospital  
NHS Trust, Wilmslow Road, Withington, Manchester, UK

## **Daniel Green**

Department of Pediatrics, Roswell Park Cancer Institute,  
Elm and Carlton Street, Buffalo, NY, USA

## **Meriel Jenney**

Department of Paediatric Oncology, Children's Hospital for  
Wales, Heath Park, Cardiff, South Glamorgan, UK

## **Katherine Matthay**

Department of Pediatric Oncology, University of California  
at San Francisco, San Francisco, CA, USA

## **Ross Pinkerton**

Director of Cancer Services, Childrens Cancer Unit,  
Mater Childrens Hospital, Raymond Terrace, Brisbane,  
QLD, Australia

## **Vaskar Saha**

Academic Head of Paediatric Haematology and Oncology,  
3rd Floor Medical Oncology, John Vane Science Building,  
Charterhouse Square, West Smithfield, London, UK

## **AG Shankar**

Department of Paediatric and Adolescent Oncology,  
University College of London NHS Trust, London, UK

## **Michael Stevens**

Institute of Child Life and Health, University of Bristol,  
Bristol, UK

# Acknowledgments

We would sincerely like to thank the following societies for generously allowing the reproduction of a large number of figures originally published in their journals.

## **American Society of Clinical Oncology**

[www.asco.org](http://www.asco.org)  
1900 Duke Street, Suite 200  
Alexandria, VA 22314

The American Society of Clinical Oncology (ASCO) is a non-profit organization, founded in 1964, with overarching goals of improving cancer care and prevention and ensuring that all patients with cancer receive care of the highest quality.

For permission to reproduce images from the *Journal of Clinical Oncology*.

[www.jco.org](http://www.jco.org)

## **American Society of Hematology**

[www.hematology.org](http://www.hematology.org)  
1900 M Street, NW, Suite 200  
Washington, DC 20036

The mission of the American Society of Hematology (ASH) is to further the understanding, diagnosis, treatment and prevention of disorders affecting the blood, bone marrow, and the immunologic, hemostatic and vascular systems, by promoting research, clinical care, education, training and advocacy in hematology.

For permission to reproduce images from *Blood*.

[www.bloodjournal.org](http://www.bloodjournal.org)

## **Massachusetts Medical Society**

[www.massmed.org](http://www.massmed.org)  
860 Winter Street, Waltham Woods Corporate Center  
Waltham, MA 02451-1411

The physician members of the Massachusetts Medical Society share a common goal – to make a difference in the lives of our patients and in the practice of medicine.

For permission to reproduce images from the *New England Journal of Medicine*.

[www.nejm.org](http://www.nejm.org)

# Introduction

*Ross Pinkerton*

The introduction of effective chemotherapy in the early 1960s led to a dramatic improvement in the outcome of childhood leukemia and solid tumors. Cure rates have been further improved by the judicious use of surgery and radiotherapy and the application of appropriate staging systems based on sophisticated imaging techniques.

In recent years, the rate of improvement has tended to reach a plateau and it has become increasingly important to design trials that ask explicit questions, are powered to be reliable and will provide answers in a reasonable time. Excellent examples where this has been the case include the series of trials in Wilms' tumor run by the National Wilms' Tumour Study Group (NWTS) and International Society of Paediatric Oncology (SIOP) Groups and the IRS trials in soft tissue sarcoma. Much has also been learned in acute leukemias and lymphoma from the American Children's Cancer Group (CCG), the French Society of Pediatric Oncology (SFOP), Pediatric Oncology Group (POG) and UK Medical Research Council (MRC) trials.

Trial design is a complex procedure starting with an individual idea and ultimately brought through a multi-disciplinary group to a formal study protocol. This is a time-consuming process often involving contentious issues and compromise on the part of participants who may have their own ideas about priorities. Moreover, because of concerns over late sequelae, long-term follow-up is required in many studies. It is easier often to design simpler, limited center studies which are under-powered and fail to address clear questions.

Consequently, the pediatric oncology literature is littered with small single arm "studies" and reports of what is essentially "best standard practice", which, whilst of interest, often fail to take things forward.

Similarly, there is a temptation in patients with poor prognoses to apply investigational regimens in the hope that if there is an improvement this will become evident when compared with historical controls. Such an approach has in many ways delayed progress.

Reluctance to run large randomized trials has resulted in the overuse of inappropriate strategies and the slow application of effective ones. Differences in outcome not only between continents, but even within Europe – highlighted by the Eurocare project – emphasize the need for standardized, evidence-based treatments.<sup>1</sup>

The aim of this book is to summarize the information that is available for randomized trials in childhood cancer. These data should not only provide a rational evidence base for current practice, but also indicate where there are gaps in our knowledge and new studies are a priority.

The inspiration for this book was the standards, options and recommendations (SOR) project of the National Federation of French Cancer Centres. This ambitious project set out to review clinical trials – both randomized and non-randomized – in adult and childhood cancer and provide evidence-based guidelines for clinical practice.<sup>2-5</sup> In the absence of randomized trials the presentation of "best available evidence" helps to guide practice (Tables 1 and 2).

Guidelines are ideally based on systematic reviews that follow the Cochrane methodology. These are very labour intensive, requiring exhaustive searches for both published and unpublished data. The recent initiative from the University of Amsterdam group has lead the way in initiating Cochrane Reviews in childhood cancer. To date most have related to supportive care and toxicity.<sup>6-8</sup> The small number of

**Table 1** Definition of level of evidence (SOR).

Level A	There exists a meta-analysis of high standard or several randomized therapeutic trials of high standard which give consistent results
Level B	There exist studies, therapeutic trials, quasi-experimental trials or comparisons of populations, of which the results are consistent when considered together
Level C	There exist studies, therapeutic trials, quasi-experimental trials or comparisons of populations, of which the results are not consistent when considered together
Level D	Either the scientific data does not exist or there is only a series of cases
Expert agreement	The data does not exist for the method concerned but the experts are unanimous in their judgment

**Table 2** Levels of evidence (Scottish Intercollegiate Guideline Network).

Level	Type of evidence
1++	Evidence from high-quality meta-analyses, systematic reviews of RCTs or RCTs with a very low risk of bias
1+	Evidence from well-conducted meta-analyses, systematic reviews of RCTs or RCTs with a low risk of bias
1–	Evidence from meta-analyses, systematic reviews of RCTs or RCTs with a high risk of bias
2++	Evidence from high-quality systematic reviews of case-control or cohort studies or high-quality case-control or cohort studies with a very low risk of confounding, bias or chance and a high probability that the relationship is causal
2+	Evidence from well-conducted case-control or cohort studies with a low risk of confounding, bias or chance and a moderate probability that the relationship is causal
2–	Evidence from case-control or cohort studies with a high risk of confounding, bias or chance and a significant risk that the relationship is not causal
3	Evidence from non-analytic studies, e.g. case reports, case series
4	Evidence from expert opinion

randomized trials for individual tumors restricts this type of analysis.

Similarly, because of the small number of randomized trials in most childhood solid tumors, formal meta-analysis is often not possible. Only in acute lymphoblastic leukemia are there sufficient studies asking comparable questions for this approach to be followed.<sup>9,10</sup> There are, however, solid tumors, such as Wilms' tumor and rhabdomyosarcoma where meta-analysis should be attempted. Meta-analyses in childhood cancer have often focused on studies on potential etiologies.<sup>11,12</sup> There may be a place for pooling data from single arm studies to learn more about prognostic factors.<sup>13–15</sup>

Much current practice is based on protocols that appear to produce the most favorable results in single arm studies. Many are associated with significant early and late morbidity which subsequent randomized

evaluation proves to have been unjustified. It is, therefore, of importance that all novel strategies are adequately evaluated before they become accepted as standard practice.

It is hoped that the data in this book will provide ready access to background information for those involved in trial design and also be of value to those early in their oncology careers who should be aware of what studies have been done but find that current textbooks provide only minimal details of these trials. From short summary tables it is impossible to assess the quality of the study or the strength of the conclusions.

We have been fortunate to have persuaded many well-known figures in children's cancer to add short commentaries to each section. These are aimed to focus on the major conclusions from the studies presented and also on future research priorities.

## References

- 1 Coebergh JW, Capocaccia R, Gatta G, Magnani C, Stiller CA. Childhood cancer survival in Europe, 1978–1992: the EUROCARE study. *Eur J Cancer* 2001;**37**:671–672.
- 2 Clinical practice guidelines for cancer care from the National Federation of French Cancer Centres. *Br J Cancer* 2001; **84**(Suppl. 2).
- 3 Sommelet D, Pinkerton R, Brunat-Mentigny M, Farsi F, Martel I, Philip T, *et al.* [Standards, options and recommendations (SOR) for clinical care of rhabdomyosarcoma (RMS) and other soft tissue sarcoma in children. Federation of the French Cancer Centers. French Society of Pediatric Oncology]. *Bull Cancer* 1998;**85**:1015–1042.
- 4 Pinkerton CR, Blanc Vincent MP, Bergeron C, Fervers B, Philip T. Induction chemotherapy in metastatic neuroblastoma – does dose influence response? A critical review of published data standards, options and recommendations (SOR) project of the National Federation of French Cancer Centres (FNCLCC). *Eur J Cancer* 2000;**36**:1808–1815.
- 5 Pinkerton CR, Bataillard A, Guillo S, Oberlin O, Fervers B, Philip T. Treatment strategies for metastatic Ewing's sarcoma. *Eur J Cancer*. 2001;**37**:1338–1344.
- 6 van de Wetering MD, van Woensel JB, Kremer LC, Caron HN. Prophylactic antibiotics for preventing early Gram-positive central venous catheter infections in oncology patients, a Cochrane systematic review. *Cancer Treat Rev* 2005; **31**:186–196.
- 7 van Dalen EC, Caron HN, Dickinson HO, Kremer LC. Cardioprotective interventions for cancer patients receiving anthracyclines. *Cochrane Database Syst Rev* 2005;**1**:CD003917.
- 8 Sasse EC, Sasse AD, Brandalise S, Clark OA, Richards S. Colony stimulating factors for prevention of myelosuppressive therapy induced febrile neutropenia in children with acute lymphoblastic leukaemia. *Cochrane Database Syst Rev* 2005;**3**:CD004139.
- 9 Clarke M, Gaynon P, Hann I, Harrison G, Masera G, Peto R, *et al.* CNS-directed therapy for childhood acute lymphoblastic leukemia: Childhood ALL Collaborative Group overview of 43 randomized trials. *J Clin Oncol* 2003;**21**:1798–1809.
- 10 Duration and intensity of maintenance chemotherapy in acute lymphoblastic leukaemia: overview of 42 trials involving 12 000 randomised children. Childhood ALL Collaborative Group. *Lancet* 1996;**347**:1783–1788.
- 11 Raimondi S, Pedotti P, Taioli E. Meta-analysis of cancer incidence in children born after assisted reproductive technologies. *Br J Cancer* 2005;**93**:1053–1056.
- 12 Martin RM, Gunnell D, Owen CG, Smith GD. Breast-feeding and childhood cancer: a systematic review with metaanalysis. *Int J Cancer* 2005;**117**:1020–1031.
- 13 Opocher E, Kremer LC, Da Dalt L, van de Wetering MD, Viscardi E, Caron HN, *et al.* Prognostic factors for progression of childhood optic pathway glioma: a systematic review. *Eur J Cancer* 2006;**42**:1807–1816.
- 14 Riley RD, Burchill SA, Abrams KR, Heney D, Sutton AJ, Jones DR, *et al.* A systematic review of molecular and biological markers in tumours of the Ewing's sarcoma family. *Eur J Cancer* 2003;**39**:19–30.
- 15 Riley RD, Heney D, Jones DR, Sutton AJ, Lambert PC, Abrams KR, *et al.* A systematic review of molecular and biological tumor markers in neuroblastoma. *Clin Cancer Res* 2004 ;**10**:4–12.

*This page intentionally left blank*

**PART 1**

# Solid Tumors

*Ross Pinkerton*



*This page intentionally left blank*

## CHAPTER 1

# Rhabdomyosarcoma

*Commentary by Michael Stevens and Meriel Jenney*

### Background

Soft tissue sarcoma (STS) accounts for about 8% of all childhood malignancies. As a diagnostic category this represents a rather heterogeneous group of tumor types, some of which are more frequently found in adult life and many of which are very rare in childhood. Rhabdomyosarcoma (RMS) is the single most common diagnosis (accounting for approximately 60% of all STS), and in view of its rarity in adults it is characteristically viewed as a pediatric malignancy. It is consequently the tumor which is best defined, and although there are important differences in behavior between RMS and some of the non-RMS STS (e.g. in their metastatic potential, chemosensitivity, etc.), most of the experience of treatment for non-RMS STS in childhood is derived either from experience of managing the same diagnoses in adult practice or is based on the principles derived from the management of RMS.

### Potential difficulties in reviewing clinical trials in RMS

Attempts to compare the results of clinical trials involving RMS in childhood are confused by the lack of use of standard terminology for staging and treatment stratification. Although there is now good communication between the major international collaborative groups, and a convergence toward standard criteria for staging and pathological classification, the experience of reviewing the literature can be confusing. Furthermore, as there have been important differences in the philosophy of treatment, careful consideration is required of the optimal measure by which outcome is defined.

Most of the important differences relate to the method and timing of local treatment, and, more specifically,

to the place of radiotherapy (RT) in guaranteeing local control for patients who appear to achieve complete remission (CR) with chemotherapy, with or without significant surgery. This represents an important philosophical difference between the International Society of Paediatric Oncology (SIOP MMT) studies and those of the Intergroup Rhabdomyosarcoma Study Group (IRSG) and, to some extent, those of the German (CWS) and Italian (ICG) Cooperative Groups. Local relapse rates are generally higher in the SIOP studies than those experienced elsewhere although the SIOP experience has also made it clear that a significant number of patients who relapse may be cured with alternative treatment. In the context of such differences, *overall* survival rather than *disease-free* or *progression-free* survival becomes the most important criterion for measuring outcome and, ultimately, there should be some measure of the “cost” of survival which takes into account the total burden of therapy experienced by an individual patient and the predicted late sequelae that may result.

### Treatment: the general approach

Experience in all studies has confirmed that a surgical-pathological classification which groups patients according to the extent of residual tumor after the initial surgical procedure predicts outcome. The great majority of patients (approximately 75%) will have macroscopic residual disease (IRS Clinical Group III) at the primary site at the start of chemotherapy (this is equivalent to pT3b in the SIOP post-surgical staging system). The variability with which RMS presents at different anatomical sites has a particularly strong influence on strategies for treatment. The additional prognostic influence of tumor size, histological subtype (embryonal versus alveolar) and patient age adds to the complexities

of treatment stratification. More recently, tumor site and size have also been recognized as independent factors that provide further refinement to the assignment of risk-based chemotherapy. All current clinical trials utilize some combination of the best-known prognostic factors to stratify treatment intensity for patients with good or poor predicted outcomes and the impetus for this approach comes as much to avoid over-treatment of patients with a good prospect for cure, as to improve cure rates for patients with less favorable disease.

The importance of multi-agent chemotherapy, as part of coordinated multi-modality treatment, has been clearly demonstrated for RMS. Cure rates have improved from approximately 25% in the early 1970s when combination chemotherapy was first implemented, and now overall 5-year survival rates of more than 70% are generally achieved. Nevertheless, it is interesting to see how relatively little the results of randomized-controlled trials have actually contributed to decision-making in the selection of chemotherapy and to the development of the design of the sequential studies which have shown this improvement in survival over those years.

## Lessons from studies of RMS

IRSG was formed in 1972 as a collaboration between the two former pediatric oncology groups in North America (Children's Cancer Group and Pediatric Oncology Group) with the intention of investigating the biology and treatment of RMS (and undifferentiated sarcoma) in the first two decades of life. This group, whose work and publications have been pre-eminent in the field, now forms the Soft Tissue Sarcoma Committee of the Children's Oncology Group (COG). Results of treatment have improved significantly over time. The percentage of patients alive at 5 years has increased from 55% on the IRS-I protocol (Study 1) to over 70% on the IRS-III and IRS-IV protocols (Studies 3 and 6).

Combinations of vincristine, actinomycin D and cyclophosphamide (VAC) have been the mainstay of chemotherapy in all IRS studies. Actinomycin D was originally given in a fractionated schedule but subsequent experience, including a randomized study from Italy (Study 5), showed no advantage in terms of outcome and has suggested that fractionation may increase toxicity; single dose scheduling is now standard across all studies. There have never been any results that challenge

the use of these drugs as first-line therapy and the results of all randomized studies which compare other drugs with, or against, VA or VAC have failed to show significant advantage.

Alternative agents of particular interest include doxorubicin (Adriamycin), which has been evaluated in a number of IRSG studies. A total of 1431 patients with Group III and IV disease were randomized to receive or not receive doxorubicin in addition to VAC during studies in IRS-I to IRS-III. The results did not indicate any significant advantage for those who received doxorubicin. Furthermore, also in IRS-III, patients with Group II (microscopic residual) tumors were randomized between VA alone and VA with doxorubicin without any significant difference in survival. Despite these results, many pediatric oncologists continue to ponder the value of anthracyclines in the treatment of RMS. Both the SIOP MMT and the German-Italian cooperative studies have continued to treat some patients with chemotherapy combinations that include anthracycline drugs. Recent European studies (MMT 95 and CWS-ICG 96) both included randomizations between their ifosfamide-based standard chemotherapy options and an intensified six-drug combination which also included epirubicin (with carboplatin and etoposide). However in both these studies (for which definitive results are not yet available) and in the previous IRS studies, the dose intensity of the anthracyclines used was low which may have underpowered the evaluation. A recent SIOP "window" study in chemotherapy naïve patients with metastatic RMS has provided good new phase II data for the efficacy of doxorubicin with response rates greater than 65%. This justifies further evaluation of the role of doxorubicin in the treatment of RMS and this is now under investigation in a randomized study being undertaken by the European paediatric Soft tissue Sarcoma Group (EpSSG).

One of the most significant differences between IRSG and the European studies has been in the choice of alkylating agent which provides the backbone of first-line chemotherapy. Ifosfamide was introduced into clinical practice earlier in Europe than in the United States and phase II data are available which supports its efficacy in RMS. IRS-IV (Studies 6 and 11) attempted to answer the question of comparative efficacy by randomizing VAC (using an intensified cyclophosphamide dose of 2.2 g/m<sup>2</sup>) against VAI which incorporated ifosfamide at a dose of 9 g/m<sup>2</sup>. A third arm in this

randomization included ifosfamide in combination with etoposide (VIE). No difference was identified between the higher-dose VAC and the ifosfamide-containing schedules, and VAC remains the combination of choice for future IRSG (now COG) studies. The rationale for this is explained by the lesser cost and easier (shorter) duration of administration required for cyclophosphamide, and concern about the nephrotoxicity of ifosfamide. Nevertheless, the EpSSG has chosen to retain ifosfamide as their standard combination as the experience of significant renal toxicity at cumulative ifosfamide doses less than  $60 \text{ g/m}^2$  is now very small and there are preliminary data suggesting that the gonadal toxicity of ifosfamide may be significantly less than that of cyclophosphamide.

Experience of the value of other drugs in IRSG studies has been relatively slim. IRS-III included the addition of cisplatin and etoposide in a three-way randomization between VAC, VAC with doxorubicin and cisplatin, and VAC with doxorubicin, cisplatin and etoposide. No advantage was seen in selected Group III and all Group IV patients and there were concerns about additive toxicity. IRS-IV (and an earlier IRS-IV pilot) explored the value of melphalan in patients with metastatic RMS or undifferentiated sarcoma. Patients were randomized to receive three courses of vincristine and melphalan (VM) or four of ifosfamide and etoposide (IE) (Study 9). There was no significant difference in initial CR and PR (complete and partial remission, respectively) rates. However patients receiving VM had a lower 3-year event-free and overall survival. Patients receiving this combination had greater hematological toxicity and therefore a lower tolerance of subsequent therapy. Other agents that have shown activity in RMS include irinotecan (CPT11) which in combination with vincristine in a recent COG window study had excellent PR and CR rates. The current COG IRS-V study has now included this combination in their latest randomized study. Vinorelbine is well tolerated and has been evaluated in combination with daily oral cyclophosphamide in previously heavily treated patients with relapsed RMS with encouraging results. This combination is now under investigation in the current EpSSG study in which patients who achieve CR with conventional chemotherapy and local treatment are randomized to stop therapy or to continue to receive a further 6 months “maintenance” therapy with this combination.

RT has been a standard component of therapy for the majority of patients in the IRSG studies from the outset. Randomized studies within IRS-I to IRS-III have established that RT is unnecessary for Group I (completely resected) patients with embryonal histology. Analyses from the same studies suggest that RT does offer an improved failure-free survival in patients with completely resected alveolar RMS or with undifferentiated sarcoma. Studies from the European groups have attempted to relate the use of RT to response to initial chemotherapy, the most radical approach being used by the SIOP group who has tried to withhold RT in patients with Group III (pT3b) disease if CR is achieved with initial chemotherapy  $\pm$  conservative second surgery. This approach has produced evidence that it is possible to avoid local therapy in some children who would otherwise receive RT but there is a need to try to define such favorable patients at the outset so as to reduce the risk of relapse requiring second treatment within the whole group. Doses of RT have, somewhat pragmatically, been tailored to age, with reduced doses in younger children, although there is no defined threshold below which late effects can be avoided and yet tumor control is still achieved. The place for hyperfractionated RT was explored in IRS-IV when randomized against conventional fractionation (Study 10). Although there was a higher incidence of severe skin reaction and nausea and vomiting in patients receiving hyperfractionated RT, it was generally well tolerated. However there was no advantage in failure-free survival, and conventional RT continues to be used as standard therapy.

Although considerable progress has been made in improving overall survival, progress has been incremental and intuitive, based on careful treatment planning, the coordination of chemotherapy with surgery and RT, and better prognostic treatment stratification. Relatively little has been learned about improving treatment from randomized studies but previous conclusions about the role of doxorubicin are being revisited. The challenge for the future requires the development of a greater ability to selectively reduce treatment for some groups of patients with a high chance of cure and to identify better forms of therapy for those with a very poor prognosis. Patients with metastatic disease, for example, continue to have a very poor survival rate. Successful randomized studies in this group of patients will probably require transatlantic collaboration in order to achieve the power

necessary to draw any conclusion; the idea has been mooted and needs to be pursued. It is also gratifying that the new EpSSG studies will harness resources of wide European collaborations with the potential that this may produce a study base of similar size to that currently enjoyed by IRSG/COG.

## **Lessons from studies of non-RMS STS**

Although this chapter refers to two studies that include patients with non-RMS STS (Studies 7 and 8), Study 7 is the only published study which was specifically designed to answer a randomized question about the value of chemotherapy in this difficult and heterogeneous group of patients. Unfortunately, the power of this study was limited and further work needs to be undertaken to better understand optimal therapy. Perhaps the most important immediate question is to ascertain whether the treatment of children with non-RMS STS, particularly with the diagnoses more frequently seen in adults,

should be assessed any differently than for adults with the same condition. If not, combined studies, particularly of new agents, could be productive. An important recent development in Europe has been the development of a new EpSSG study specifically for children with non-RMS STS. This will facilitate the systematic collection of data from the consistent treatment of children with these rare tumors. Separate approaches are offered for synovial sarcoma, for “adult”-type non-RMS STS and for unique pediatric histiotypes. None of these studies yet include a randomized element and the numbers of patients in some of these rare diagnostic groups, even when collected at European level, still make this a logistical and statistical challenge.

## **Conclusion**

Despite progress made, many children with STS continue to have an outcome that is unsatisfactory in terms of overall cure. Wider international collaboration is the key to providing a patient base that will allow timely and valid randomized studies.

# Studies

## Study 1

Maurer HM, Beltangady M, Gehan EA, Crist W, Hammond D, Hays DM, Heyn R, Lawrence W, Newton W, Ortega J. The Intergroup Rhabdomyosarcoma Study-I. A final report. *Cancer* 1988;**61**: 209–20.

This study was carried out between 1972 and 1978 by the US Intergroup Rhabdomyosarcoma Study Group.

### Objectives

The aims of the study were:

- To evaluate the role of local radiotherapy in IRS Group I patients who received vincristine, actinomycin D (dactinomycin) and cyclophosphamide (VAC) chemotherapy.
- To determine whether the addition of cyclophosphamide to vincristine and actinomycin (VA) was of benefit in Group II patients who received local irradiation.
- To document the complete remission rate achieved by pulsed VAC with local irradiation in patients with Group III and IV disease.
- To evaluate the role of adding doxorubicin (Adriamycin) to VAC in Group III and IV patients.

### Details of the study

Patients eligible were under 21 years with rhabdomyosarcoma or undifferentiated sarcoma.

The treatment regimens were as shown in Figure 1.1. Local irradiation was given at the start of treatment in Group I/II patients and after 6 weeks of chemotherapy for all other patients. Radiation dose was 50–60 Gy, reduced to 40 Gy for those under 3 years of age. Patients with lung metastases received 18-Gy bilateral lung irradiation.

The randomization method is not described in detail. The study was designed to detect a doubling of the median disease-free survival (DFS) time for both Group I and II patients, with 90% power at the 5% level, requiring 87 patients in each arm in both of these studies.

For Groups III and IV it was predicted that there would need to be 100 patients in each arm to detect a 20% improvement in response rate, with 90% power at the 5% level. A response rate of 50% was assumed for the control group.

Outcome measures were disease-free, overall survival (DFS, OS, respectively), and local and distant response.

### Outcome

A total of 799 patients were registered, of whom 686 were eligible for inclusion. After review of all pathology, radiology and treatment flow sheets 575 were deemed evaluable, but all 686 eligible patients are included in the outcome analysis on an intention-to-treat basis.

### Group I

Regimen A: 43 patients, 5-year DFS 81%, OS 93%.

Regimen B: 43 patients, 5-year DFS 79%, OS 81%.

No significant difference between the two arms. No difference was noted in the site of relapse in the two groups with regard to local or distant metastases.

### Group II

Regimen C: 87 patients, 5-year DFS 72%, OS 72%.

Regimen D: 98 patients, 5-year DFS 66%, OS 72%.

No significant difference between the two arms.

### Group III

Regimen E: 146 patients, complete response rate 67%, median time to achieve complete remission (CR) 12 weeks, event-free survival (EFS) at 5 years 49%, OS 69%.

Regimen F: 134 patients, complete response rate 72%, median time to CR 13 weeks, DFS 50%, OS 68%.

No significant difference between the two arms.

### Group IV

Regimen E: 61 patients, complete response rate 51%, median time to CR 15 weeks, EFS 19%, OS 14%.

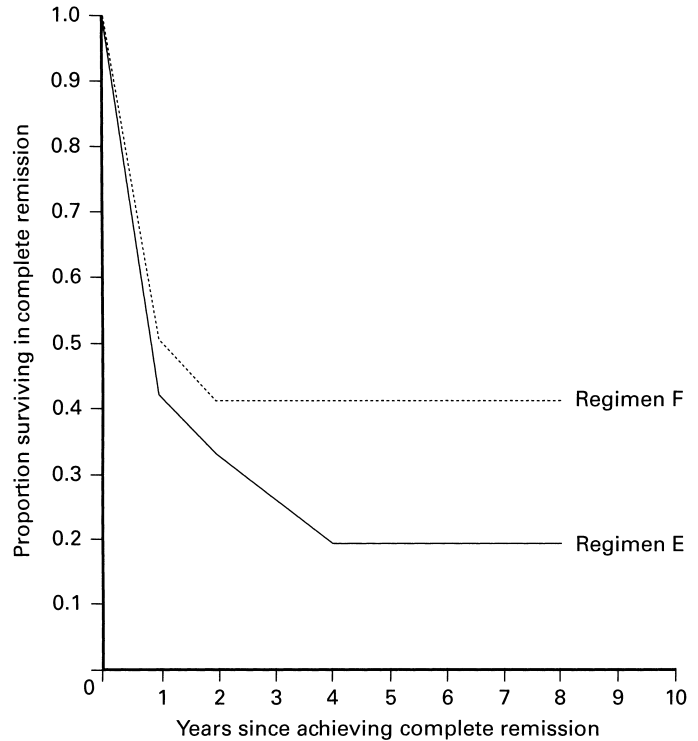
Regimen F: 68 patients, complete response rate 50%, median time to CR 10 weeks, EFS 41%, OS 26%.

No significant difference between the two arms.

Figure 1.2 shows EFS for Group IV patients.



**Figure 1.2** Event-free survival for Group IV patients. Duration of complete remission curves among complete responders in Group IV by randomized treatments: “pulse” VAC + radiation (regimen E) and “pulse” VAC + Adriamycin (doxorubicin) + radiation (regimen F). Copyright © 1988 American Cancer Society. Reprinted and adapted from Maurer *et al.* (full reference on p. 7) with permission from Wiley-Liss, Inc., a subsidiary of John Wiley & Sons, Inc.



## Study 2

Maurer HM, Gehan EA, Beltangady M, Crist W, Dickman PS, Donaldson SS, Fryer C, Hammond D, Hays DM, Herrmann J. The Intergroup Rhabdomyosarcoma Study-II. *Cancer* 1993;71:1904–22.

This study was carried out between 1978 and 1984 by the US Intergroup Rhabdomyosarcoma Study Group, with participation of the United Kingdom Children’s Cancer Study Group (UKCCSG).

### Objectives

The aims of the study were:

- To determine the value of cyclophosphamide in favorable site/pathology IRS Group I patients.
- To evaluate the role of pulsed VAC (vincristine, actinomycin D and cyclophosphamide), compared to VA in favorable Group II patients.
- To evaluate the role of doxorubicin (Adriamycin) in Group III and IV patients, excluding special pelvic sites.

In addition, in the non-randomized component of the trial, to evaluate the value of local meningeal irradiation in parameningeal tumors, the potential reduction in cystectomy rates using primary chemotherapy and the value of pulsed VAC in extremity alveolar tumors using comparisons with IRS-I data.

### Details of the study

Patients below the age of 21 years with rhabdomyosarcoma, soft tissue Ewing’s sarcoma and undifferentiated sarcoma were eligible.

All IRS Group I and II patients were included, except those with extremity alveolar tumors.

The dose of local irradiation in Group II patients was 40–45 Gy. For Group III patients under 6 years of age with tumors less than 5 cm, the dose was 40–45 Gy; over 5 cm, 45–50 Gy; for those over 6 years of age with tumors less than 5 cm, 45–50 Gy and over 5 cm, 50–55 Gy.

Group IV patients with lung disease received 18-Gy bilateral lung irradiation and those with other soft tissue deposits received 50–55 Gy.

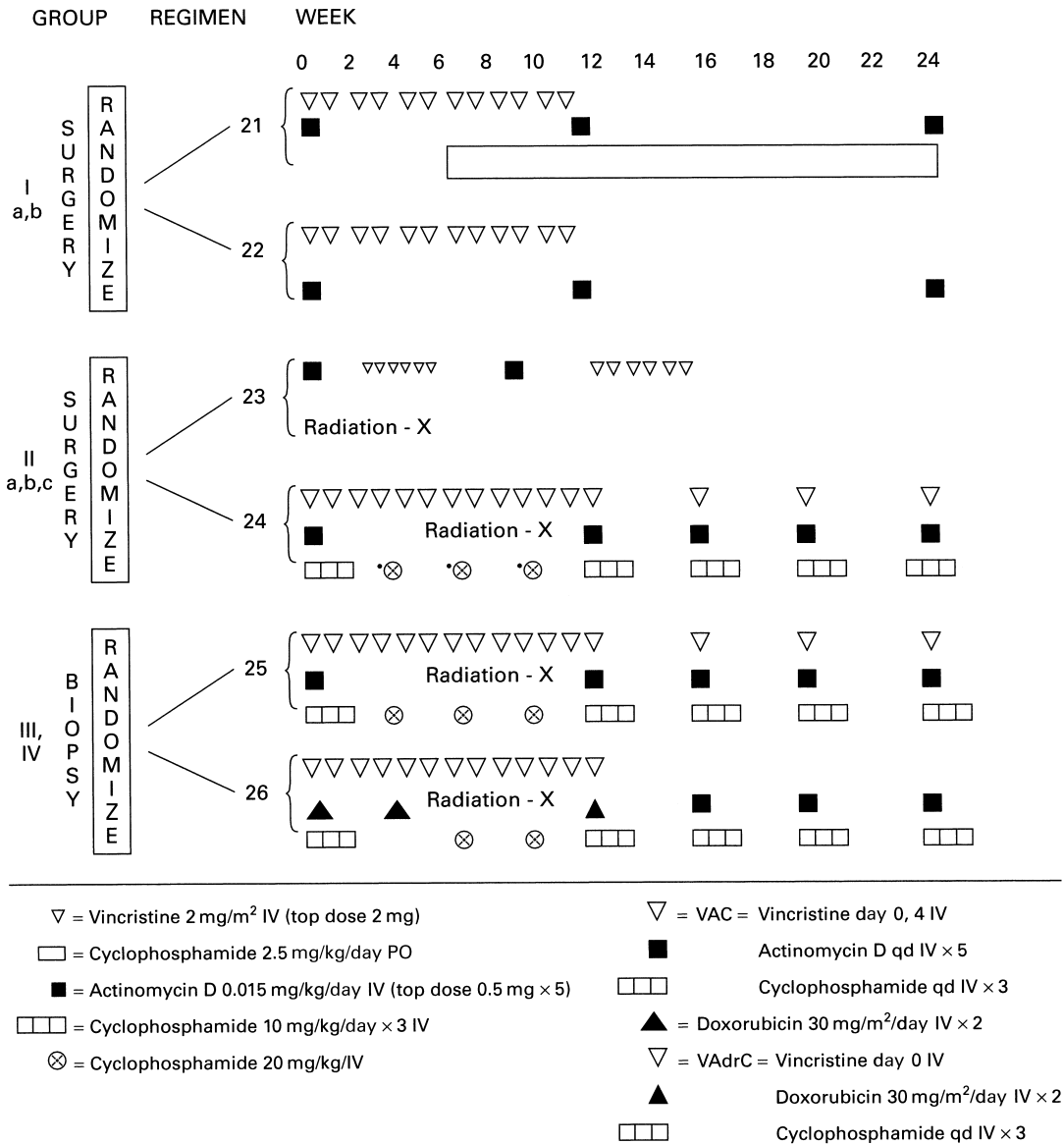


For details of the treatment regimens see Figure 1.3. Primary outcome measures were disease-free survival (DFS) and survival with documentation of response rates.

The method of randomization was not described.

For Group I and II patients there was a 1:2 stratification standard:study regimen. It was estimated that

for the Group I patients 25 and 50 patients, respectively, were required. For Group II, 38 and 75, respectively, and for Groups III and IV, a total of 186 patients. The difference between the curves was analyzed using log-rank tests and generalized Wilcoxon tests. The p-values obtained from statistical tests were used as a measure of the strength of the evidence against the null



**Figure 1.3** Intergroup Rhabdomyosarcoma Study II treatment regimen. Copyright © 1993 American Cancer Society. Adapted and reprinted from Maurer *et al.* (full reference on p. 9) with permission from Wiley-Liss, Inc., a subsidiary of John Wiley & Sons, Inc.

hypothesis being tested,  $p < 0.05$  indicating a statistically significant result with moderate evidence against the null hypothesis, and  $p < 0.01$  indicating a highly significant result with strong evidence against the null hypothesis.

### Outcome

A total of 1115 patients were registered, of whom 116 were excluded, 100 due to unconfirmed eligible pathology on review. The allocation to treatment group by local center was confirmed on review in 92% of cases. Of the 999 patients, 776 were regarded as evaluable. Reasons to be non-evaluable included wrong treatment assignments, protocol violation or inadequate data collection. All 999 patients were included in the analysis on an intention-to-treat basis.

### Group I

Regimen 21: 37 patients, 5-year DFS 80%, OS 85%.  
Regimen 22: 64 patients, 5-year DFS 70%, OS 84%.

There appeared to be more local recurrences in the arm not receiving cyclophosphamide (14% versus 5%), but this was not statistically significant.

### Group II

Regimen 23: 45 patients, DFS 69%, OS 88%.  
Regimen 24: 85 patients, DFS 74%, OS 79%.

No significant difference between the treatment arms.

### Group III

Regimen 25: 211 patients, complete remission (CR) rate 74%, continued clinical remission (CCR) at 5 years 75%, OS in CR patients 66%.

Regimen 26: 197 patients, CR rate 78%, CCR at 5 years 70%, OS 65%.

No significant difference between the treatment arms, but significantly better than in IRS-I.

### Group IV

Regimen 25: 83 patients, CR rate 52%, median time to CR 13 weeks, CCR of CR patients at 5 years 38%.

Regimen 26: 88 patients, CR rate 53%, median time to CR 15 weeks, CCR at 5 years 38%.

Overall progression-free survival of all patients at 5 years 21% for Regimen 25 and 25% for Regimen 26.

No significant difference.

### Toxicity

There were 21 fatalities associated with treatment, overall 1–4% by regimen. There were five severe cardiac toxicities. The precise details by regimen were not specified.

### Conclusions

- Vincristine and actinomycin given for 1 year is equivalent to 2 years of VAC in Group I patients not given local irradiation.
- Cyclophosphamide does not add benefit to VA in Group II patients who receive local irradiation.
- The addition of doxorubicin to a VAC-based combination does not significantly improve either complete response rate or ultimate outcome in patients with Group III or IV disease.

### Comments

Womer has noted some reservations about the comparability of the regimens (Womer RB. The Intergroup Rhabdomyoma studies come of age. *Cancer* 1993;71:1719–21). For Group II patients, Regimen 23 had three times the vincristine and half the actinomycin dose, compared to Regimen 24 which contained cyclophosphamide. Moreover, it is possible that the addition of doxorubicin could have had an impact on the different pathological subgroups within Groups III and IV, but insufficient patient numbers were recruited to determine whether there was a difference between embryonal or alveolar rhabdomyosarcoma.

### Study 3

Crist W, Gehan EA, Ragab AH, Dickman PS, Donaldson SS, Fryer C, Hammond D, Hays DM, Herrmann J, Heyn R. The Third Intergroup Rhabdomyosarcoma Study. *J Clin Oncol* 1995;13:610–30.

This study was carried out between 1984 and 1991 by the US Intergroup Rhabdomyosarcoma Study Group.

#### Objectives

The aims of the study were:

- To determine the role of doxorubicin (Adriamycin) in addition to VAC (vincristine, actinomycin D and cyclophosphamide) chemotherapy in Group II patients.
- To determine the role of the addition of either cisplatin/doxorubicin or cisplatin/doxorubicin and etoposide in Group III and IV patients.
- To make non-randomized comparisons with IRS-II for all other patient groups.

#### Details of the study

Eligible patients were under the age of 21 years with rhabdomyosarcoma, undifferentiated sarcoma, extrasosseous sarcoma and extrasosseous Ewing’s sarcoma. Treatment had to be started within 42 days of tumor biopsy and 21 days of definitive primary surgery.

Outcome measures were progression-free survival (PFS) and overall survival (OS), in addition to local and metastatic response.

It was estimated that for Group II patients, to demonstrate a 15% increase in end point from 80% to 95% with 73% power at the 5% level would require 92 patients. It was planned to include comparable non-randomized patients from IRS-II who received the identical standard comparator regimen.

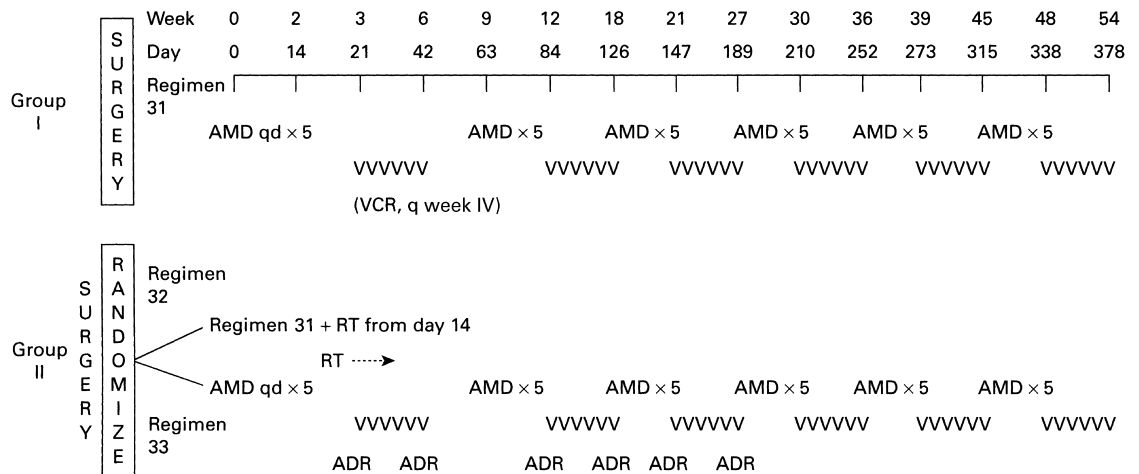
For Group III patients, in order to detect an increase from 70% to 80%, with 76% power at the 5% level, would require a total of 472 patients. Again, it was planned to include comparable patients from the IRS-II who required the identical standard regimen.

The precise methods of randomization were not detailed.

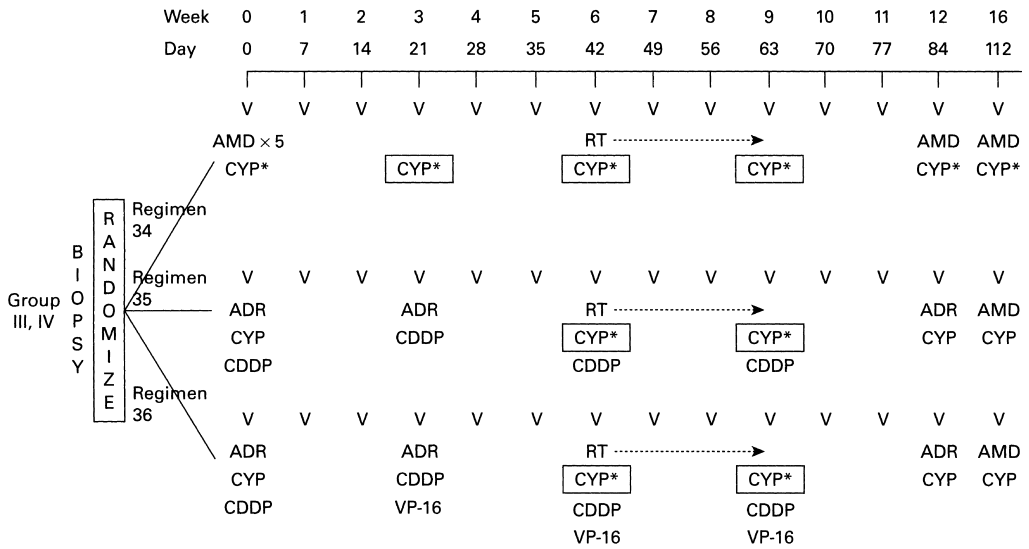
Details of the chemotherapy and radiotherapy regimens are given in Figure 1.4.

Group II favorable histology patients received either VA with radiotherapy or VA/doxorubicin with radiotherapy for a total of 1 year. Patients with testicular, orbit or head and neck non-parameningeal primaries were excluded from the randomized study.

Group III patients, with the exception of special pelvic sites and parameningeal tumors, either received the standard regimen of pulsed VAC with radiotherapy or a regimen including doxorubicin and cisplatin or doxorubicin/cisplatin/etoposide. All three regimens incorporated second-line chemotherapy for patients who achieved partial response. For the standard VAC

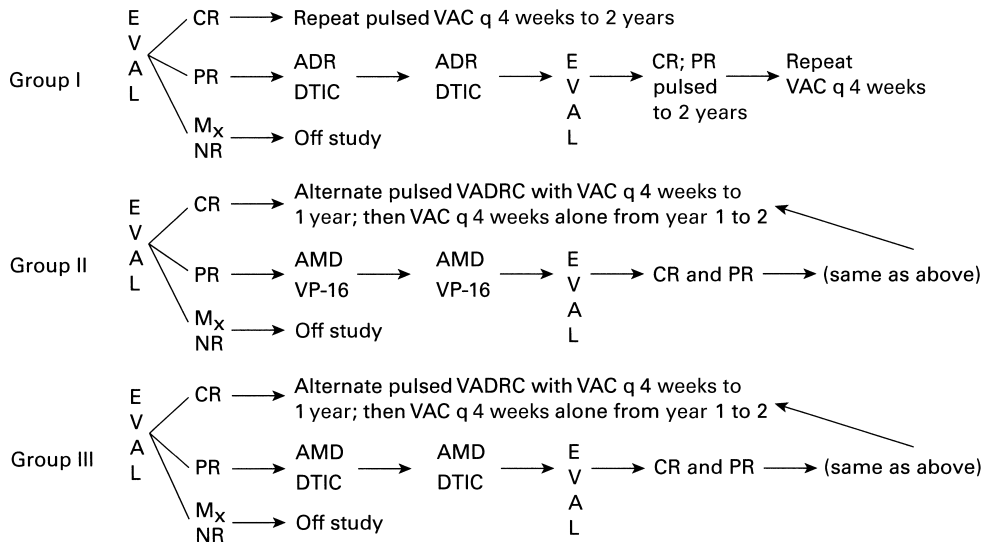


**Figure 1.4a** Intergroup Rhabdomyosarcoma Study III treatment regimen for Groups I and II (ADR: doxorubicin; AMD: actinomycin D; RT: radiotherapy and VCR: vincristine). © American Society of Clinical Oncology (full reference above).



\*Favorable histology  
 \*\*Excluding Group III favorable histology, orbit and non-parameningeal head tumors

**Figure 1.4b** Intergroup Rhabdomyosarcoma Study III treatment regimen for Groups I and II (CDDP: cisplatin; CYP: cyclophosphamide; VP-16: etoposide and other abbreviations as in Figure 1.4a). © American Society of Clinical Oncology (full reference on p. 12).



**Figure 1.4c** Intergroup Rhabdomyosarcoma Study III treatment regimen (NR: no remission; PR: partial remission and other abbreviations as in Figure 1.4a). © American Society of Clinical Oncology (full reference on p. 12).

regimen this comprised doxorubicin and DTIC; for the doxorubicin/cisplatin regimen, actinomycin D/etoposide; and for the four-drug regimen, actinomycin D and DTIC.

**Outcome**

A total of 1194 patients were enrolled, of whom 132 were excluded, 79 due to incorrect pathology. Of the 1062 eligible patients, 235 were regarded as

non-assessable for a variety of reasons on central review of grouping, radiotherapy, chemotherapy and surgical details. All patients eligible and randomized were included in the subsequent analyses on an intention-to-treat basis. Overall, there was pathological agreement with the Central Review Panel in 79% of alveolar cases and 77% of embryonal cases.

### Group II

Regimen 32: 23 patients, 5-year PFS 56%, OS 54%.  
Regimen 33: 51 patients, 5-year PFS 77% and OS 89%.  
With the addition of the identical IRS-II Regimen 23 patients, PFS in the control arm was 63% and OS 73%.

No statistical difference between the two treatment arms.

### Group III

Regimen 34: 58 patients, at week 20 complete remission (CR) rate 39%, with an eventual CR rate of 79%, 5-year PFS 70% and OS 70%.

Regimen 35: 113 patients, week 20 CR rate 45%, final CR 78%, PFS 62%, OS 63%.

Regimen 36: 118 patients, week 20 CR rate 48%, final CR 84%, PFS 56%, OS 64%.

No statistical significant difference in the initial response, final CR rate or ultimate outcome.

### Group IV

Regimen 34: 29 patients, week 20 CR rate 42%, final CR rate 50%, PFS 27%, OS 27%.

Regimen 35: 65 patients, week 20 CR rate 30%, final CR rate 57%, PFS 27%, OS 31%.

Regimen 36: 56 patients, week 20 CR rate 38%, final CR rate 62%, PFS 30%, OS 29%.

Comparing with IRS-II, the Group III patients did significantly better,  $p < 0.01$ , with 61% versus 52% PFS. This was concluded to be due to the value of second-line chemotherapy achieving complete response.

### Toxicity

Overall 5% fatalities. Morbidity of individual regimens was not detailed. Overall, there were 9% cardiac toxicities, of which 5% were severe. There were five cases of secondary acute myeloid leukemia – four on Regimen 36.

### Conclusion

It was concluded that although the overall results were superior to IRS-II, no particular subgroups benefited directly from the intensification of chemotherapy within the randomized comparison.

## Study 4

Flamant F, Rodary C, Voute PA, Otten J. Primary chemotherapy in the treatment of rhabdomyosarcoma in children. Trial of the International Society of Pediatric Oncology (SIOP) preliminary results. *Radiother Oncol* 1985;3:227–36.

The study was run from 1975 to 1983 by the European collaboration group SIOP.

### Objectives

The aim of the study was:

- To determine whether the use of chemotherapy with radiotherapy prior to surgery could minimize treatment sequelae without jeopardizing survival rate.

### Details of the study

Eligible patients included those aged 1–15 years with embryonal or alveolar rhabdomyosarcoma, deemed initially unresectable, with either incomplete removal or biopsy only. Patients had to have had equal or greater than 25% reduction in tumor volume after one course of VAC (vincristine, actinomycin D and cyclophosphamide) chemotherapy. Patients were also excluded if there was a major intolerance to this initial course of chemotherapy.

The method of randomization is not specified. Randomization was performed on day 28, with pairing according to the localization. Ear, nose and throat primaries were also paired according to age and bone involvement of the base of the skull.

Patients received regimen A or B (see Figure 1.5). Regimen A was continuation of VAC, followed by vincristine doxorubicin (VAD) chemotherapy, alternating for an 18-month period. If a complete clinical response was achieved, no other treatment was given.

If a partial response was achieved, chemotherapy was given to maximum effect, followed by surgery and/or radiotherapy. If there was no response after two VAC/VAD, surgery and/or radiotherapy was given. With regimen B systematic radiotherapy was given to the initial tumor volume, even if the tumor had regressed after pre-trial chemotherapy. A dose of 45 Gy was used accompanied by daily actinomycin on each of the first seven radiotherapy sessions and vincristine every 2 weeks during radiotherapy. Following radiotherapy, VAC/VAD was given for 18 months, as in regimen A. In the case of bladder and prostate tumors, anterior exenteration was done followed by radiotherapy if the surgery was not microscopically complete.

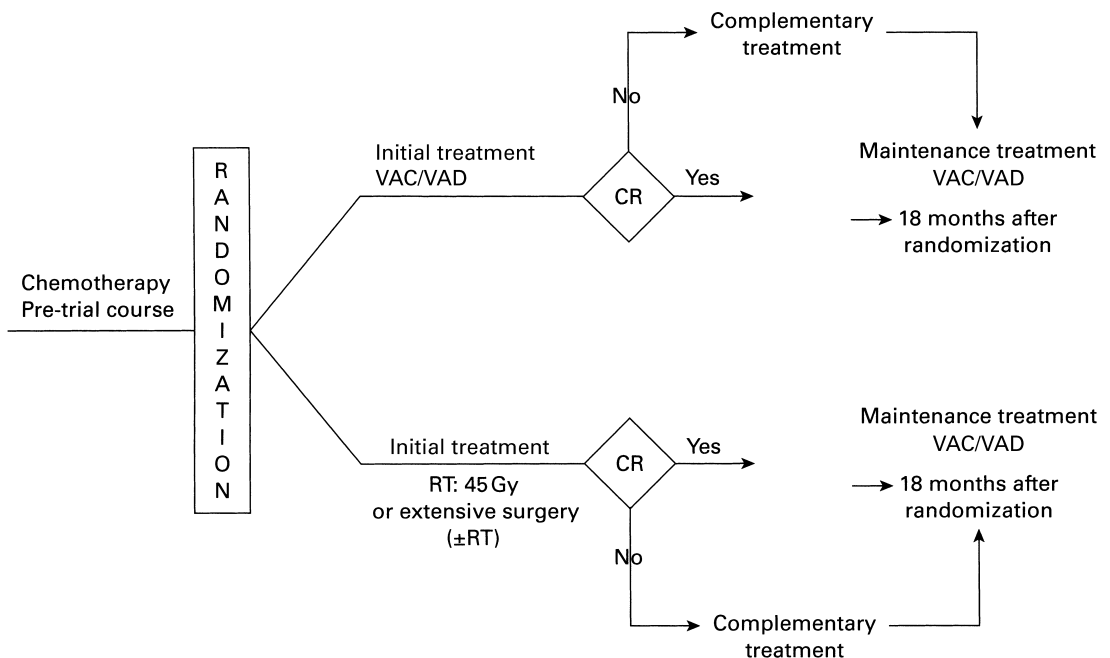
Outcome at 3 years was analyzed in paired cases. Using a closed pragmatic design the probability of preferring one treatment when in reality the other was better in 65% of the untied pairs was 5%. Under these conditions the number of pairs required was estimated to be 37, i.e. 74 patients. If the accrual rate was 25 patients per year, 3 years would have been needed, and the results of the last pair treated would have been available 6 years after the study started.

In the analysis the best result of the pair was chosen. If both patients died, neither treatment was preferable and this pair resulted in a tie. When only one of the pair was dead, the treatment given to the living patient was counted as preferable, even if the patient was living with a relapse. If both were living, the treatment which had given the best results, taking into consideration the existing and expected therapeutic sequelae, was preferred. When the results were equal, the less heavy treatment was chosen.

## Outcome

Eighty-one patients were entered. Fifteen failed to show a sufficient response to course 1 and three were excluded due to protocol violation or pathological error. Local complete response was achieved in 21 of 32 in arm A and 21 of 31 in arm B.

The final assessment at 3 years was estimated for 22 pairs of patients. No difference was seen between the arms; the overall survival rate was 40% at 3 years. Of 56 patients with more than 2 years follow-up, 41% in arm A were in complete clinical remission compared with 48% of arm B. It was noted that in all children



**Figure 1.5** Design of the trial. Reprinted from Flamant *et al.* (full reference on p. 14) with permission from Elsevier.

with bladder primaries cystectomy was eventually performed in both treatment arms.

### Conclusion

It was concluded that primary chemotherapy could avoid many late sequelae with no adverse effect on outcome, although overall disease-free survival was

poor in both the arms. The numbers were too small to conclude unequivocally whether disease-free survival differed between the two arms. This study was stopped prematurely due to poor results in those with parameningeal localization, and the refusal by doctors and the families to allow patients with bladder and prostate primaries to undergo anterior pelvicotomy.

## Study 5

Carli M, Pastore G, Perilongo G, Grotto P, De Bernardi B, Ceci A, Di Tullio M, Madon E, Pianca C, Paolucci G. Tumor response and toxicity after single high-dose versus standard five-day divided-dose dactinomycin in childhood rhabdomyosarcoma. *J Clin Oncol* 1988; 6:654–8.

The study was run from 1979 to 1985 by the Italian Multicentre Collaborative Group.

### Objectives

The study was aimed:

- To compare two methods of administration of actinomycin, as part of VAC.

### Details of the study

Eligible patients with a rhabdomyosarcoma included those under 15 years of age with one of the following: a tumor greater than 5 cm in size, primary of bladder, prostate, vagina, uterus and orbit, and included those with distant metastases.

Randomization was carried out centrally using a closed envelope method. It was balanced for primary site, clinical group and center size. A projected accrual rate of 15–20 patients per year was planned to achieve around 50 patients in each arm to show a 30% difference in response or toxicity,  $\alpha$  0.05,  $\beta$  0.2.

Actinomycin, as part of vincristine, actinomycin D and cyclophosphamide (VAC), was given at 0.45 mg/m<sup>2</sup>

daily for 5 days, the combination repeated every 28 days for three courses. This schedule was compared with 1.7 mg/m<sup>2</sup> on day 8 only and the regimen was repeated every 21 days for four courses.

The major outcome measure was response to treatment prior to course 4, 3 weeks after the second course.

### Outcome

Thirty-six patients received split dose VAC and 42 single dose VAC. Eight patients were excluded, due to early death in four, two refused after randomization and two had prior chemotherapy.

Complete or partial remission was 67% on the split dose VAC and 70% for the single dose VAC. Overall survival at 3 and 5 years with split dose was 48% and 38% and single dose 43% and 43%, respectively.

### Toxicity

The split dose VAC was more myelosuppressive, although not statistically significant. There was significantly more stomatitis with split dose VAC ( $p < 0.01$ ). There were two severe episodes of sepsis, both in the split dose arms.

### Conclusion

It was concluded that the fractionated regimen was somewhat more toxic and no more effective in achieving an initial response than the simpler single dose regimen. In particular, there was no evidence of any increase in liver toxicity associated with the single dose regimen.

## Study 6

Baker KS, Anderson JR, Link MP, Grier HE, Qualman SJ, Maurer HM, Breneman JC, Wiener ES, Crist WM. Benefit of intensified therapy for patients with local or regional embryonal rhabdomyosarcoma: results from the Intergroup Rhabdomyosarcoma Study-IV. *J Clin Oncol* 2000;18:2427–34.

The study was carried out by the US Intergroup Rhabdomyosarcoma Study between 1991 and 1997 (IRS-IV).

### Objectives

The study was designed:

- To compare three induction and continuation chemotherapies based on the VAC regimen, with the substitution of ifosfamide for cyclophosphamide or the replacement of actinomycin and cyclophosphamide with ifosfamide and etoposide.

### Details of the study

Eligible patients were under 21 years of age with either rhabdomyosarcoma or undifferentiated sarcoma. Chemotherapy was to start within 42 days of initial surgery.

No details of randomization method are given, nor the predicted number of patients required to address the issue of differences in efficacy of the respective chemotherapies.

The regimens are shown in Figure 1.6. The cyclophosphamide dose of 2.2 g/m<sup>2</sup> is higher than in previous IRS regimens and this was compared with 9 g of ifosfamide infused over 5 days and the same dose combined with etoposide 500 mg/m<sup>2</sup> over 5 days.

Excluded from the study were patients felt to be at risk of renal problems, namely those with raised creatinine, single kidneys or pre-existing hydronephrosis. Also excluded were the good risk Group I patients with testis, orbit or eyelid primaries who received only vincristine and actinomycin D.

The primary outcome measure was failure-free survival.

Regimen	INDUCTION Treatment weeks 0–16																CONTINUATION Treatment weeks 20–46														
	0	1	2	3	4	5	6	7	8	9	10	11	12	13	14	15	16	20	21	22	23	24	25	26	27	28					
VAC	V	V	V	V	V	V	V	V	V	E	V	V	V	V	–	–	–	V	E	V	V	V	V	V	V	–	–	–			
	A			A				A		V	C			C			A	V	A			A									
	C			C				C		A	Radiation therapy						C	A	C		C										
VAI	V	V	V	V	V	V	V	V	V	L	V	V	V	V	–	–	–	V	L	V	V	V	V	V	V	–	–	–			
	A			A				A		U	I			I			A	U	A			A									
	I			I				I		A	Radiation therapy						I	A	I		I										
VIE	V	V	V	V	V	V	V	V	V	I	V	V	V	V	–	–	–	V	I	V	V	V	V	V	V	–	–	–			
	I			I				I		O	I			I			I	O	I			I									
	E			E				E		N	Radiation therapy						E	N	E		E										

V, vincristine 1.5 mg/m<sup>2</sup> (2 mg maximum)

A, actinomycin D 0.015 mg/kg/day (0.5 mg maximum daily dose), days 0–4

C, cyclophosphamide 2.2 mg/m<sup>2</sup>, day 0

I, ifosfamide 1.8 mg/m<sup>2</sup>/day, days 0–4

E, etoposide 100 mg/m<sup>2</sup>/day, days 0–4

**Figure 1.6** Treatment plans for IRS-IV patients at intermediate risk of failure. © American Society of Clinical Oncology (full reference above).



## Outcome

A total of 894 patients were registered with loco-regional disease. For the chemotherapy comparisons no details of patient numbers or disease group are provided in this report, just the outcome. The 3-year failure-free survivals for VAC, VAI and VAE were 74%, 74% and 76%, respectively, with overall survivals of 81%, 83% and 87%, respectively; i.e. no significant difference between the three arms.

No details of toxicity between the three treatments are provided.

## Conclusion

Overall, the results in IRS-IV were no different from IRS-III, except for the subgroup of patients with intermediate risk embryonal histology, where there was a significant improvement in event-free and overall survival. This was claimed to be due to the increase in the dose of alkylating agent in IRS-IV, compared to IRS-III.

It was concluded that none of the novel regimens had any advantage over the VAC protocol containing a higher dose of cyclophosphamide.

## Study 7

Pratt CB, Pappo AS, Gieser P, Jenkins JJ, Salzberg A, Neff J, Rao B, Green D, Thomas P, Marcus R, Parham D, Maurer H. Role of adjuvant chemotherapy in the treatment of surgically resected pediatric nonrhabdomyosarcomatous soft tissue sarcomas: a Pediatric Oncology Group Study. *J Clin Oncol* 1999;17:1219–26.

This study was carried out by the Pediatric Oncology Group (POG 8653) between 1986 and 1992.

### Objectives

The study was designed:

- To evaluate whether administration of chemotherapy following surgical resection of nonrhabdomyosarcomatous soft tissue sarcomas improved local or systemic control.

### Details of the study

Patients were under 21 years of age, previously untreated and pathologies that were excluded comprised rhabdomyosarcoma, extraosseous Ewing's sarcoma, fibromatosis, undifferentiated sarcoma, angiofibroma, dermatofibrosarcoma protuberans and mesothelioma.

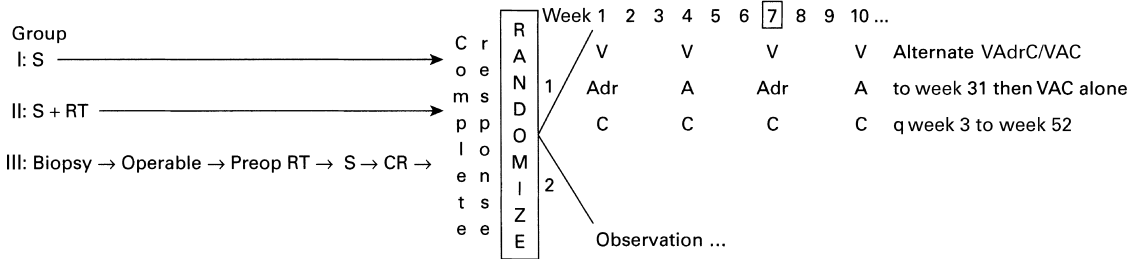
The randomization method is not given, but it was balanced for clinical group status. The initial design specified a sample size of 112 patients would be required to detect a 20% improvement in 2-year event-free survival (EFS) (70% versus 50%) with an 80% power. A 5%, one-sided significance level was assumed. Overall survival and EFS were the primary outcome measures. All pathology was centrally reviewed.

The treatment schema is given in Figure 1.7. Children with Group I disease received no postoperative irradiation and were randomly assigned to be observed or receive adjuvant chemotherapy with vincristine 1.5 mg/m<sup>2</sup>, doxorubicin (Adriamycin) 60 mg/m<sup>2</sup> and cyclophosphamide 750 mg/m<sup>2</sup> (VAdrC), alternating every 3 weeks with vincristine 1.5 mg/m<sup>2</sup>, cyclophosphamide 750 mg/m<sup>2</sup> and actinomycin D 1.25 mg/m<sup>2</sup> (VAC) for a total of 31 weeks. Children with clinical Group II disease, i.e. microscopic residual tumor, received age-adjusted postoperative radiotherapy to the tumor bed at a dose between 35 and 45 Gy. After completion of irradiation, patients were randomly assigned to receive or not receive chemotherapy. Patients with clinical Group III disease underwent second-look surgery 6–12 weeks after completing radiation therapy. If complete tumor regression was documented, these patients were also randomly assigned to receive or not receive adjuvant chemotherapy.

### Outcome

Ninety-nine patients were enrolled, 18 were excluded due to ineligible pathology; 30 of the 81 remaining were randomized. Reasons for the high non-randomization rate are not given, but 19 were electively treated with chemotherapy and 32 with observation alone. Overall, most patients in Group I had extremity primaries – synovial sarcoma was the commonest pathology (36%) followed by malignant fibrous histiocytoma (12%), malignant peripheral nerve sheath tumor (10%) and fibrosarcoma (10%); 47% had grade 3 tumors.

For the randomized cases, the 5-year EFS was 87% for those observed, versus 41% for those receiving



**Figure 1.7** Treatment schedule for POG 8653 (A: actinomycin; Adr: Adriamycin; C: cyclophosphamide; Preop: preoperative; S: surgery; RT: radiotherapy and V: vincristine). © American Society of Clinical Oncology (full reference on p. 18).

chemotherapy ( $p = 0.01$ ) and overall survival was 93% and 69%, respectively ( $p = 0.016$ ). These differences were due to an imbalance in histological grade, with 73% of grade 3 in the chemotherapy arm, compared to 40% in the observation arm. Histological grade 3 included the following diagnoses: pleomorphic or round-cell liposarcoma, mesenchymal chondrosarcoma, extraskeletal osteogenic sarcoma, malignant triton tumor, alveolar soft part sarcoma and a group

of tumors with a high level of necrosis and mitotic activity.

### Conclusion

It was concluded that this study failed to show any significant benefit from chemotherapy but the low randomization rate and ultimately small numbers limit the conclusions that can be drawn.

## Study 8

Pratt CB, Maurer HM, Gieser P, Salzberg A, Rao BN, Parham D, Thomas PRM, Marcus RB, Cantor A, Pick T, Green D, Neff J, Jenkins JJ. Treatment of unresectable or metastatic pediatric soft tissue sarcomas with surgery, irradiation and chemotherapy: a Pediatric Oncology Group Study. *Med Ped Oncol* 1998;**30**:201–9.

The study was carried out by the Pediatric Oncology Group (POG 8654) between 1986 and 1994.

### Objectives

The objective of the study was:

- To compare two chemotherapy regimens in children with either gross residual disease at presentation following surgery or distant metastases, either at presentation or as recurrent disease after initial treatment with surgery alone.

### Details of the study

Details of patient eligibility are not given with regard to age, pathology, etc.

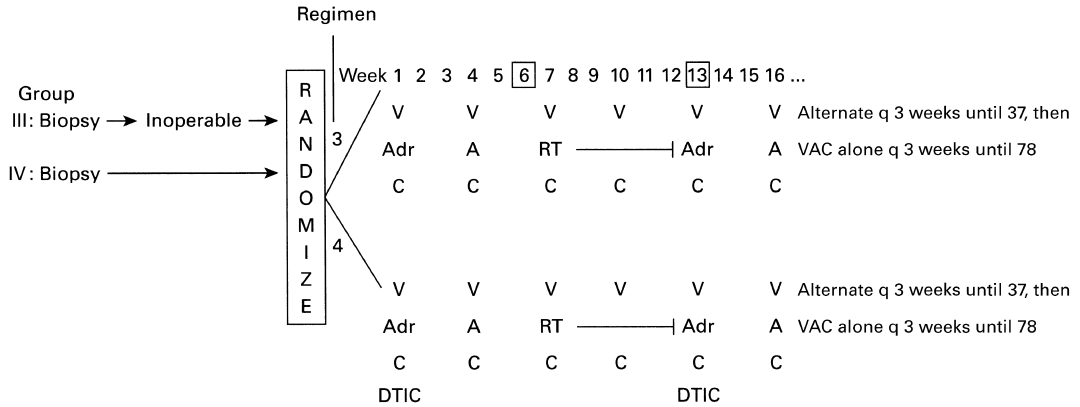
The randomization technique is not reported. It was assumed that there would be a 25% response rate for standard chemotherapy with vincristine, doxorubicin, cyclophosphamide and actinomycin D, and 94 patients would be required to document an increase to 40% with the addition of DTIC, with 80% power using Type I error.

The study outline is shown in Figure 1.8. All patients received VACA – vincristine  $1.5 \text{ mg/m}^2$ , actinomycin D  $1 \text{ mg/m}^2$ , cyclophosphamide  $750 \text{ mg/m}^2$ , doxorubicin (Adriamycin)  $60 \text{ mg/m}^2$  – and were randomized to receive, or not receive, additional DTIC of  $500 \text{ mg/m}^2$ . All received local radiotherapy at week 6, with an age-adjusted dose with maximal tumor dose of 55–65 Gy. Sites of metastases were also irradiated.

Delayed surgery was performed on Group III patients 6–12 weeks after radiotherapy.

Infants under 12 months received half-dose chemotherapy and the 3-weekly schedule was delayed 1 week if the absolute neutrophil count (ANC) was less than  $0.5/\mu\text{l}$  and platelets was less than  $50/\mu\text{l}$  at any time. If the ANC was less than  $0.25 \times 10^9/\text{l}$  and platelets was less than  $10 \times 10^9/\text{l}$ , doses were decreased by 25%.

Primary outcome measures were response at 6 weeks and relapse-free survival.



**Figure 1.8** Treatment schema for POG 8654 (abbreviations as in Figure 1.7). Reprinted from Pratt *et al.* (full reference on p. 19) with permission from Wiley-Liss, Inc., a subsidiary of John Wiley & Sons, Inc.

## Outcome

Seventy-five patients were accrued prior to premature closure of the study. This was due to slow accrual, accompanied by investigator bias related to randomization. Among the 75 patients, 14 were ineligible due to problems with pathology on review. These included rhabdomyosarcoma, lymphoma, fibromatosis, osteosarcoma and thymoma. Of the 61 eligible patients there were 13 malignant peripheral nerve sheath tumors, 8 synovial sarcomas, 5 alveolar soft part sarcomas, 5 malignant fibrous histiocytomas and 6 non-specified sarcomas. Twenty-five patients received VACA and 25 patients received VACA with DTIC. Eleven received VACA electively, in part due to a lack of DTIC availability for a 12-month period during the study.

Overall response rate for VACA was 56% (35–76%) and with the addition of DTIC, 44% (24–65%). For

Group III patients there were 14 complete responses and 5 partial responses out of 36 overall. For Group IV patients, 3 complete responses and 6 partial responses in 25 patients. For the randomized VACA patients, there were 4 complete responses and 6 partial responses out of 25. For the DTIC arm, 7 complete responses and 4 partial responses out of 25. Event-free survival for VACA was 36% at 2 years, with DTIC it was 26%. The difference was not significant.

## Conclusion

In conclusion, there appeared to be a high initial response rate but poor overall event-free survival and there appeared to be no benefit from the addition of DTIC.

## Study 9

Breitfeld PP, Lyden E, Raney RB, Teot LA, Wharam M, Lobe T, Crist WM, Maurer HM, Donaldson SS, Ruymann FB. Ifosfamide and etoposide are superior to vincristine and melphalan for pediatric metastatic rhabdomyosarcoma when administered with irradiation and combination chemotherapy: a report from the Intergroup Rhabdomyosarcoma Study Group. *J Pediatr Hematol Oncol* 2001;23(4):225–33.

Study carried out by the American Intergroup Rhabdomyosarcoma Study Group between 1991 and 1995.

## Objectives

The aim of the study was:

- To compare response rates of two novel drug pairs, vincristine and melphalan or ifosfamide and etoposide in untreated metastatic rhabdomyosarcoma.
- To determine whether incorporation of these combinations in patients who had shown a response in proven survival.

## Details of the study

Eligible patient included all rhabdomyosarcoma or undifferentiated sarcoma under the age of 21 years.

All pathology and stage allocation were centrally reviewed.

No details of randomization method or site are given.

No details of the anticipated difference between the drug pairs with regard to response or subsequent influence on outcome are given. Plan numbers required are not defined.

### Study design

The randomized comparison shown in Figure 1.9 and essentially compared four courses of ifosfamide and etoposide (IE) with three of vincristine and melphalan (VM). This was then followed by a standard vincristine, actinomycin D and cyclophosphamide (VAC) regimen with local radiation therapy and treatment continued up to 39 weeks with VAC to which in the case of responding patients either VM or IE was added. The support GCSF was given with both initial chemotherapy arms.

Primary tumor excision was recommended if possible and second surgery after local radiation was also recommended. Radiation dose was 50.4 Gy to gross unresected disease, 41.4 Gy to microscopic post-surgical residue. Radiation field was the pre-treatment volume with 2-cm margin including adjacent lymph nodes. With lung metastases a dose of 14.4 Gy was given. Patients with parameningeal primaries were radiated on day 1 to the primary sites.

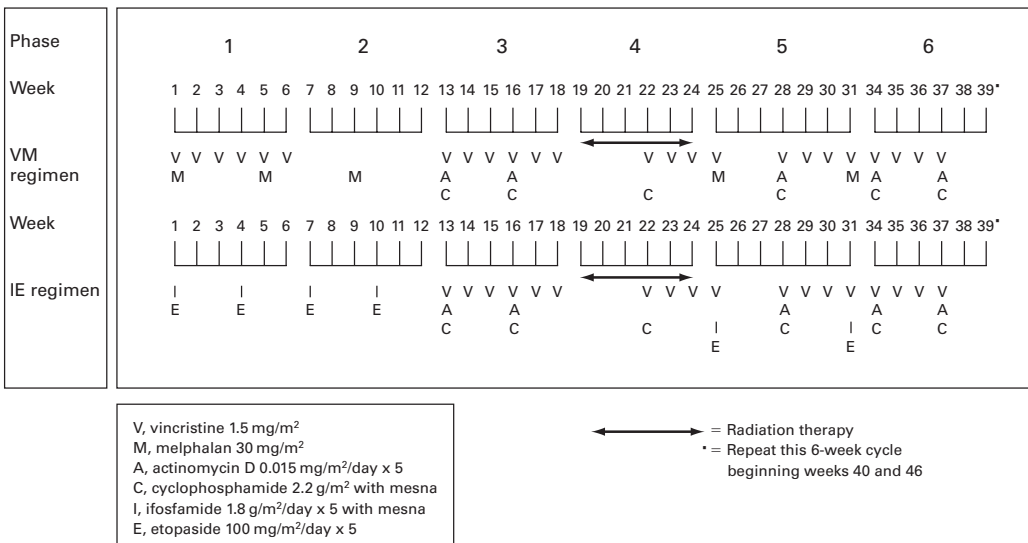
### Outcome

One hundred and fifty-one patients with metastatic disease were recruited, 81 randomized to VM and 70 to IE. In the melphalan group 12 were excluded in the IE 11 excluded. Exclusions were due to non-pathology review, wrong pathological diagnosis or miss staging. Analysis was based on 69 VM and 59 IE. Groups were well balanced with regard to risk factors for VM and IE, respectively, T2 tumors 86% and 91%, bone marrow involvement 67% and 62%, bone involvement 58% and 45%, alveolar pathology 43% and 49%, age over 10 years 37% and 41%.

### Toxicity

Hematological toxicity was more marked with melphalan with a significant excess of anemia in weeks 19–24, neutropenia in weeks 12–18 and thrombocytopenia in weeks 12–24. There was no significant difference in documented infection rates. There were three cases of hepatic veno-occlusive disease in the VM arm and one with IE. The incidence rate of electrolyte abnormalities was significantly higher with the ifosfamide-based regimen.

There were two secondary leukemias with VM and one with IE. There were four toxic deaths, one due to sepsis, one due to pneumonitis, one veno-occlusive disease and one bronchiolitis obliterans.



**Figure 1.9** Chemotherapy and radiation therapy outline for patients randomized to either IE- or VM-containing regimens. Second-look surgery at the primary site was recommended for consideration at 6 months after completion of RT. Reproduced with permission of Lippincott, Williams & Wilkins (full reference on p. 20).

The initial drug couplets had a significant impact on the tolerance of subsequent VAC chemotherapy. This was significantly worse with the melphalan including regimen. Administration of chemotherapy between weeks 13 and 18 took 63 days versus 54 days,  $p < 0.04$ . A greater than 10% reduction in chemotherapy was required in the 48% versus 25% between weeks 25 and 33 and 74% versus 45% between weeks 34 and 38.

Complete response rates did not differ at week 12, 13% versus 12%, partial response 61% versus 67% and progressive disease 13% versus 12%. There was a significantly worse 3-year event-free survival with VM 19% versus 33% and overall survival 27% versus 55%,  $p = 0.04$  and 0.01, respectively.

With regard to the outcome of patients who progressed during the window phase of the study two of

seven who failed VM survived and two of six of IE survived. Outcome following relapse was worse after VM,  $p = 0.03$ .

### Conclusion

The chemotherapy couplets were of comparable initial activity, however there was an adverse impact due to the influence of melphalan on hematopoietic stem cell function; this resulted in later (poor) intolerance to VA chemotherapy and consequent dose reduction. Possibly as a result of this the event-free and overall survival with VM was worse. The outcome after IE appears to be better than with VAC, however numbers are small and this would need to be tested prospectively.

## Study 10

Donaldson S, Meza J, Breneman J, Crist W, Laurie F, Qualman S, Wharam M. Results from the IRS-IV randomized trial of hyperfractionated radiotherapy in children with rhabdomyosarcoma – a report from the IRSG. *Int J Radiation Oncology Biol Phys* 2001;51: 718–28.

Study carried out between 1991 and 1997 by the American Intergroup Rhabdomyosarcoma Study Group (IRS-IV).

### Objectives

The aim of the study was:

- To compare the effectiveness and toxicity of hyperfractionation versus conventionally delivered radiation therapy in children with IRS Group III Rhabdomyosarcoma.

### Details of the study

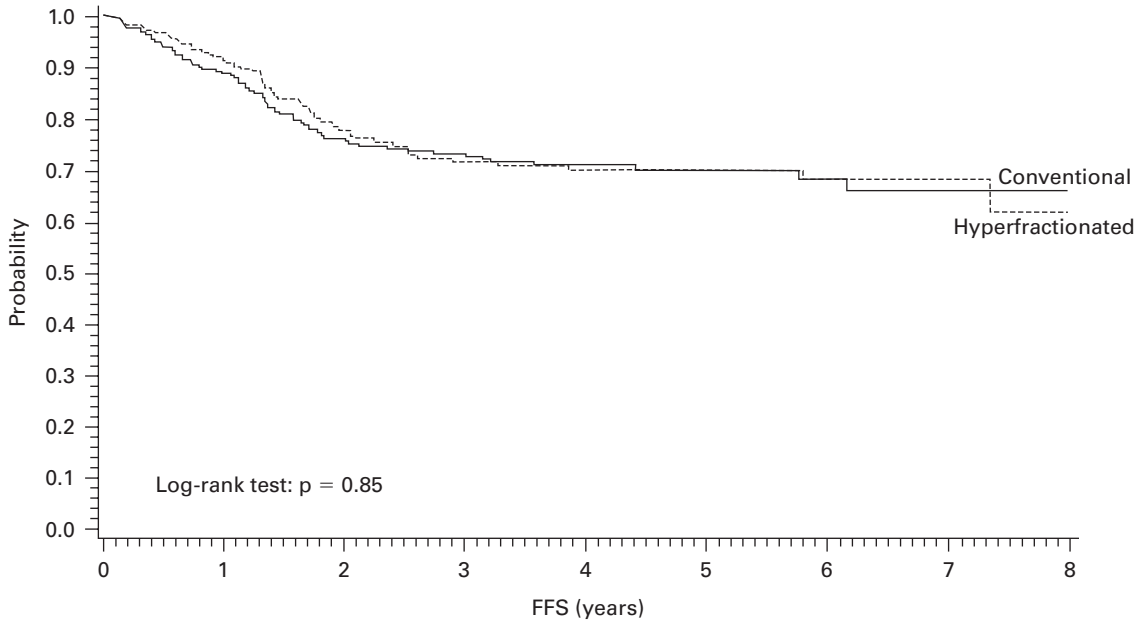
Eligibility included patients under the age of 22 years with a diagnosis of rhabdomyosarcoma or undifferentiated sarcoma. Extraosseous Ewing's sarcoma (EOS) were excluded as were sarcomas of brain, spinal cord or liver. All pathology were centrally reviewed as was documentation regarding group and stage. Group III tumor was defined as localized tumor with gross residual disease following incomplete resection or biopsy.

Residual disease could be either primary tumor or nodal disease. Distant metastases were excluded. From early 1995 patients with renal problems who had initially been excluded from the study were included. Patients with localized vulval or vaginal tumors were not randomized but were given conventional radiotherapy electively.

Patients had to commence chemotherapy with 42 days of biopsy or 21 days of initial surgery. The randomization method and site were not stated.

Primary end point was event-free survival; 438 patients were to be randomized providing an 80% power, two-sided test, 5% significance to detect 77% versus 65% increase in failure-free survival. Secondary end point was the local relapse rate where the same numbers would have a 79% power to detect a reduction of 8% in local relapse rate from 16% to 8%.

Radiation field was planned on gross tumor volume prior to surgery and prior to chemotherapy with a 2-cm margin. Radiotherapy was commenced at week 9 except in emergencies or high-risk parameningeal primaries (those with direct extension) intracranially or bone erosion or nerve palsy. Conventional fractionated radiation therapy consists of dose of 50.4 Gy and 28 fractions compared with hyperfractionation dose of 59.4 Gy in 1.1 Gy doses twice a day with a 6-hour interval between doses. If there were treatment delays during radiation the doses were topped up after completion up to a total dose of 54 Gy for conventional therapy and up to 63.8 Gy



**Figure 1.10** Failure-free survival for patients randomized to conventional fractionated or hyperfractionated radiation therapy. Reproduced from Donaldson *et al.* (full reference on p. 22) with permission from Elsevier.

for hyperfractionation. All radiation therapy planning and delivery details were centrally reviewed with regard to the fraction dose delivered, dose to primary site and dose to nodes.

Chemotherapy details are given in Study 11.

### Outcome

Five hundred and fifty-nine patients entered IRS-IV, 12% were ineligible due to histology, surgery or other violations. Of the 490, 251 were randomized to conventional fraction radiation therapy and 239 to hyperfractionation.

There was a good balance with regard to risk factors for conventional versus hyperfractionated; T2 primary tumor, 66% versus 66%, alveolar 22% versus 20%, stage III 60% versus 60% and parameningeal 40% versus 46%.

Compliance with planned radiation therapy for hyperfractionation 76% and conventional 83%.

Fifty-four patients received no radiation therapy due to early progressive disease, 10 early deaths, 2 young age, 9 parental decision. Including 34 randomized to

hyperfractionation who received conventional fractionation, event-free survival was identical in both arms. Event-free survival 70% and overall survival 75%. There were no differences in any subset or any chemotherapy regimen. When analyzed by actual rather than planned treatment the results were also identical (Figure 1.10).

Overall, local failure rate was 13%, regional 3%, distant 13% with no difference between the two arms.

Hyperfractionation was associated with a significantly higher instance of severe skin reaction 16% versus 7% ( $p = 0.03$ ) and also a higher instance of nausea and vomiting 13% versus 5% ( $p = 0.02$ ). Also the instance of mucositis during initial chemotherapy was higher in the hyperfractionated arm 66% versus 46% ( $p = 0$ ).

### Conclusion

Hyperfractionation was well tolerated but showed no advantage with regard to local control or overall outcome.



All the others were randomized to receive 50.4 conventional versus 59.4 hyperfractionation (see Study 10).

The chemotherapy question compared vincristine, actinomycin D and cyclophosphamide (VAC) versus vincristine, actinomycin D and ifosfamide (VAI) versus vincristine, ifosfamide and etoposide (VIE) (Figure 1.11).

A total of 989 patients were enrolled, 106 were excluded, 56 on pathology review, 10 institutional pathology review and 13 due to metastases. Overall sites were extremity 13%, parameningeal 25%, genitourinary 31%, head and neck 7%, orbit 9%, 51% were over 5 cm in diameter and 15% lymph node positive. At pathology review the concordance for alveolar versus embryonal.

Clinical grouping showed good concordance: 96% Group I, 89% Group III and 98% Group III.

Parental directive 134 testicular or vulval primaries, 56 renal dysfunctions; 235 randomized VAC, 236 to VAE and 222 to VAI. With regard to the three arms there was a good balance of risk factors for VAC, VAE, VAI, respectively: age over 10 years 27%, 28% and 31%, alveolar 27%, 24% and 24%, greater than 5-cm tumor 50%, 64% and 51% and extremity tumor 16%, 16% and 17%.

There was no difference in significant toxicity between the chemotherapy arms.

There were ten second cancers and five leukemias. There were eight toxic deaths, six due to sepsis, three of those within initial renal dysfunction.

## Outcome

Overall event-free survival in Group I was 89%, with a survival of 100%. In the randomized trial at 3.9 years median follow-up the 3-year failure-free survival for VAC, VAI and VIE, respectively, were 75%, 77% and 77% and survival 84%, 84% and 88%. No difference in any pathological or clinical subgroup. With regard to radiotherapy no significant difference was observed between conventional and hyperfractionation (see study).

Compared the outcome with IRS-III there was a significantly better outcome for patients with embryonal stage II or stage II or III Groups I and II with failure-free survival of 93% versus 76% ( $p < 0.001$ ).

## Conclusion

Ifosfamide was not superior to cyclophosphamide at the doses and schedule studied VAC chemotherapy remains the goal standard. Outcome in Groups I and II stages I and II was better than historical control due to increased intensity therapy. In Group I para-testicular tumors failure-free survival was 81% versus 95% in IRS-III; i.e. a worse outcome due to the absence of surgical staging, perhaps missing nodal involvement. As a consequence node sampling is now recommended for those over 10 years of age.



## CHAPTER 2

# Osteosarcoma

*Commentary by Alan Craft*

The history of the introduction of the chemotherapy in the management of osteosarcoma is one which should be studied by all new recruits to oncology and indeed those running clinical trials. It is a classic story of the need for good randomized controlled trials (RCTs) before the introduction of a new treatment and of many of the pitfalls in trying to establish a meaningful RCT.

Unfortunately, the reports of the RCTs as detailed here do not give any real idea of the chronology and the excitement of the story. The studies included here are the definitive papers, which usually appeared several years after the results had been presented at major meetings and were available in abstract form.

Prior to the chemotherapy era, osteosarcoma could be cured by amputation alone in about 20% of patients. The remaining 80% of patients died, almost exclusively from lung metastases over the next 18 months or so. There were many papers in the literature confirming the 20% figure. Chemotherapy was introduced in the late 1960s and methotrexate seemed to be the drug which had the most activity. Following descriptive reports of significant improvements in survival the Mayo Clinic undertook a RCT of high dose methotrexate (HDMTX) against no chemotherapy in osteosarcoma (Study 2). Although it was a very small study, both progression-free survival and overall survival were the same in both groups. Very surprisingly, the 50% survival without chemotherapy was more than twice that which would have been expected from historical controls.

The initial conclusion was that the natural history of osteosarcoma must have changed and that surgery, at least in the hands of the Mayo Clinic, was as good as chemotherapy. There was much speculation as to the reasons for this unusual result but the seeds of doubt had been sown regarding the efficacy of chemotherapy and for several years there was much skepticism and reluctance, particularly by orthopedic surgeons, to refer

their newly diagnosed patients to an oncologist. After all, one of the world's leading orthopedic centers, the Mayo Clinic, had shown that good surgery was all that was required.

The other main possibility for this bizarre result was that somehow the Mayo Clinic patients were not the same as the general population of osteosarcoma, that some type of selection had taken place. Two of the possibilities considered were that the Mayo was one of the first places in the world to have CT scanning and that by using a more sophisticated imaging system they were able to select out only those who really did not have obvious pulmonary metastases, thereby improving the overall prognosis.

Another possibility was that the Mayo is a tertiary, if not quaternary, referral center and in order to get there a considerable number of steps have to be gone through, all of which takes time. A patient who did not have pulmonary metastases by the time he or she got to the Mayo maybe had a tumor which had a better natural history.

None of these possible biasing factors would have mattered in the RCT as they would have been likely to be acting in both arms. The real explanation emerged some years later when the histological type of osteosarcoma was revealed. By then it was recognized that almost a quarter of the patients had grade 2 or 3 osteosarcoma. High grade osteosarcoma is usually classified as grade 4. It appears that the surgery only arm, by chance, included more randomized patients with an inherently good prognosis because of lower grade histology.

In the meantime, Rosen, working at the Memorial Sloan-Kettering Hospital in New York, had devised a new regimen of treatment which was based on the *in vivo* response of the osteosarcoma to chemotherapy. All patients received initial chemotherapy, mainly HDMTX, the tumor was then surgically resected and subsequent treatment was based on the histological

response. Good responses received more methotrexate and poor responses switched to a cisplatin/doxorubicin regimen.

The early results of this “T10” protocol suggested a 90% survival and these were reported in *Cancer* in 1982. This dramatic paper is probably one of the most cited in pediatric oncology. According to Science Citation Index, between 1982 and 1995 it had been cited 378 times and not surprisingly T10 had become the gold standard of treatment.

So, in the late 1970s, investigators faced the dilemma of many people thinking that chemotherapy was of no value, the Mayo “camp”, whilst others became disciples of Rosen. Fortunately two other groups had the courage to undertake RCTs which included a no chemotherapy arm. The Multi-Institutional Study (MIOS), run under the auspices of POG by Michael Link (Study 4) convinced the skeptics that chemotherapy was of value. The no chemotherapy arm had a relapse-free survival of 17%, identical to the historical series in the literature. The natural history of osteosarcoma had not changed! Interestingly, the overall survival on long-term follow-up was not different in the two arms, suggesting that to delay chemotherapy until the appearance of metastases was not detrimental.

The other study with a no chemotherapy control arm was that reported by Eilber from UCLA (Study 5). Perhaps they had learnt the lesson from the Mayo study because they excluded all patients with low grade pathology. Disease-free survival (DFS) in the no chemotherapy arm was again as expected from history –20%. The T10 regimen had a DFS of 55% at 2 years, but considerably less than that reported by Rosen.

By the early 1980s, therefore, it seemed that chemotherapy was of value and most orthopedic surgeons began to send their patients to an oncologist. However, there was considerable skepticism about the Rosen results from New York. In Europe this was probably of greater intensity than in the US. The EORTC had undertaken an RCT between 1978 and 1983 (Study 6) in which there was no significant difference between the various treatment groups, but overall the results were disappointing at around 40–50%. They had used methotrexate but in a much lower dose than Rosen. The European Osteosarcoma Intergroup (EOI) was formed with the explicit aim of devising a simpler regimen than the T10 and then comparing it in an RCT with T10. The other major European groups, the

German COSS group and the Italian Institute Rizzoli group, did not take part in the EOI, and although the French initially were going to be included, they were so convinced of the success of the T10 protocol that they wanted to replicate it.

The first EOI study (Study 7) started out as a randomized phase II study but accrual was so successful that the 60 patients needed were rapidly exceeded. The two-drug cisplatin/doxorubicin regimen was superior to that also containing methotrexate but the only real conclusion that could be drawn was that increased dose intensity of cisplatin/doxorubicin was important. It could not answer any questions about methotrexate. This led on to the second EOI study (Study 10), which was the formal comparison of the best treatment from the first study against the T10 regime. This study showed no significant difference between the two treatments. It has been criticized on the grounds that many patients in the T10 arm stopped treatment early but it probably does reflect what happens in the real world in a multi-institutional setting. For economic and patient convenience reasons cisplatin/doxorubicin is now more widely used, although many groups still follow a methotrexate based T10 type of regimen.

The COSS group (Study 1) showed no benefit for the addition of interferon, which had been suggested by Strander in the early 1970s as being a worthwhile adjuvant. They also showed no benefit for the addition of other drugs to their standard methotrexate, doxorubicin regimen.

The Italian group (Study 8) showed that high dose was better than moderate dose methotrexate perhaps providing an explanation for the overall poor results obtained with the EORTC (Study 6), which used only moderate doses.

The mode of delivery of chemotherapy – intrarterial (IA) versus intravenous (IV) – has also received study. From a theoretical point of view it seems possible that direct delivery of the effective drug into the tumor could be of value. However it does add an additional technical complexity to the treatment. The COSS group showed no difference for IA versus IV (Study 9). More recently the Bologna group (Study 13) have reported their RCT of IA versus IV chemotherapy which did not show any advantage for the IA route compared to “aggressive” conventional chemotherapy. Most of the other reported RCTs in osteosarcoma have looked at varying combinations of the same drugs in different

intensities. Study 12 is a delayed report of a Memorial Sloan Kettering T12 study which added preoperative doxorubicin and cisplatin to the standard T10 regime. No additional benefit was seen either in proportion of patients with good histological response or with outcome. Overall it seems that dose intensity is important. The only new and possibly effective drugs to appear in the past 15 years have been ifosfamide and etoposide. These have been tested in an RCT by the CCG in the US (Study 15). There was a double randomization to  $\pm$ ifosfamide and  $\pm$ MTTPE. (The latter is a form of immunotherapy.) Theoretically no interaction was predicted between MTTPE and ifosfamide. Unfortunately, the results suggest that there was.

The logical next step for the EOI was to undertake a dose intensity study and that is currently almost complete. The standard two drug cisplatin/doxorubicin given every 3 weeks is being compared with the same drugs given every 2 weeks with the addition of GCSEF.

What then are the main questions which remain to be answered in osteosarcoma? Survival has improved little over the past 20 years and new drugs or new modalities of treatment are needed. Of the existing drugs, the place of methotrexate is not proven. It is undoubtedly an active agent but whether it is an essential part of other combinations is not clear. An RCT with  $\pm$ HDMTX as the only randomization would be of interest but unfortunately, because HDMTX interferes with the dose intensity of other drugs, it has not been possible to design such a clean study.

There has been much discussion about the timing of surgery. Most protocols recommend neoadjuvant chemotherapy before definitive surgery. The recently reported study from POG (Study 14) shows no difference in outcome between immediate or delayed surgery. However, it is likely that delayed surgery will be

preferable as it renders more patients amenable to conservative, limb preservation, surgery rather than amputation.

As with many concerns occurring in children and young people, it is likely that further progress will not be made with existing therapies. Targetted radiotherapy with samarium and other bone seeking isotopes may be one possibility, perhaps as an additional therapy.

Non-specific immunotherapy with MTTPE appears in the recently closed CCG study to be of some benefit, so perhaps some more specific ideas in this area would be worth considering.

The biology of osteosarcoma is beginning to be unraveled but there does not appear to be any specific gene rearrangement associated with the majority of tumors. However, potential drug targets have been identified and drugs designed to interact with these. Herceptin which interacts with cErbB2 was designed to be used for breast cancer patients but may well be effective in osteosarcoma.

Whichever new therapies look promising, they will have to be tested in RCTs. Osteosarcoma is rare and in order to complete an RCT in a timely fashion it will be necessary to have multinational studies.

Finally, we have learnt a number of very important lessons from the reported RCTs in osteosarcoma which are applicable more widely. The lessons to be learnt from these studies are:

- The natural history of a condition does not change.
- In an RCT make sure that both arms contain the same type of patients.
- If the RCT is entirely conducted in a specialist hospital, the randomized comparison may be valid but the overall result may not be applicable to the general population.
- Beware of double randomizations where the two might interact.

## Study 1

Winkler K, Beron G, Katz R, Salzer-Kuntschik M, Beck J, Beck W, Brandeis W, Ebell W, Erttmann R, Gobel U, Havers W, Henze G, Hinderfeld L, Hocker P, Jobke A, Jurgens H, Kabisch H, Preusser P, Prindull G, Ramach W, Ritter J, Sekera J, Treuner J, Wust G, Landbeck G. Neoadjuvant chemotherapy for osteogenic sarcoma: results of co-operative German–Austrian study. *J Clin Oncol* 1984;2:617–24.

This study (COSS-80) was designed and run by the German COSS group between 1979 and 1982.

### Objectives

The study addressed two questions:

- Whether the addition of either cisplatin or bleomycin/cyclophosphamide/actinomycin D (BCD) improves the efficacy of a doxorubicin/high dose methotrexate (HDMTX) based regimen.
- Whether interferon is of benefit when given to patients following initial chemotherapy.

### Details of the study/outcome

A sequential series of patients with non-metastatic high grade classic central osteosarcoma were recruited. Technetium bone scan and chest X-ray were used to exclude distant metastases. CT scan was used in 39% of cases.

Patients were randomized at a central base in Hamburg, using prepared random lists, with stratification

for age, sex, site and local extent (relative to normal bone).

Treatment outline and drug doses are given in Figure 2.1. To address the secondary question interferon was given for a 22-week period starting in week 16.

Disease-free survival (DFS) was the main outcome measure.

A total of 214 patients were registered, 56 were excluded due to incorrect diagnosis, prior chemotherapy or alternative pathologies. Of 158 entered, a further 42 were excluded due to delayed chemotherapy or a wide variety of protocol violations. One hundred and sixteen patients were available for analysis.

There was no significant difference in DFS with the addition of either cisplatin (73%) or BCD (77%) or between patients given interferon (77%) or no interferon (73%).

Overall, 55% proceeded to conservative surgery, with no difference between the chemotherapy groups. As expected, there was an increase in renal toxicity in the cisplatin based arm. There were five treatment related deaths, two due to methotrexate and three due to infection.

### Conclusion

It is concluded that the two regimens were of comparable efficacy and improved overall survival compared to the previous COSS-77 trial was noted. The improvement was particularly marked in the under-12s and it was postulated this was due to the higher methotrexate given to younger patients.

## Study 2

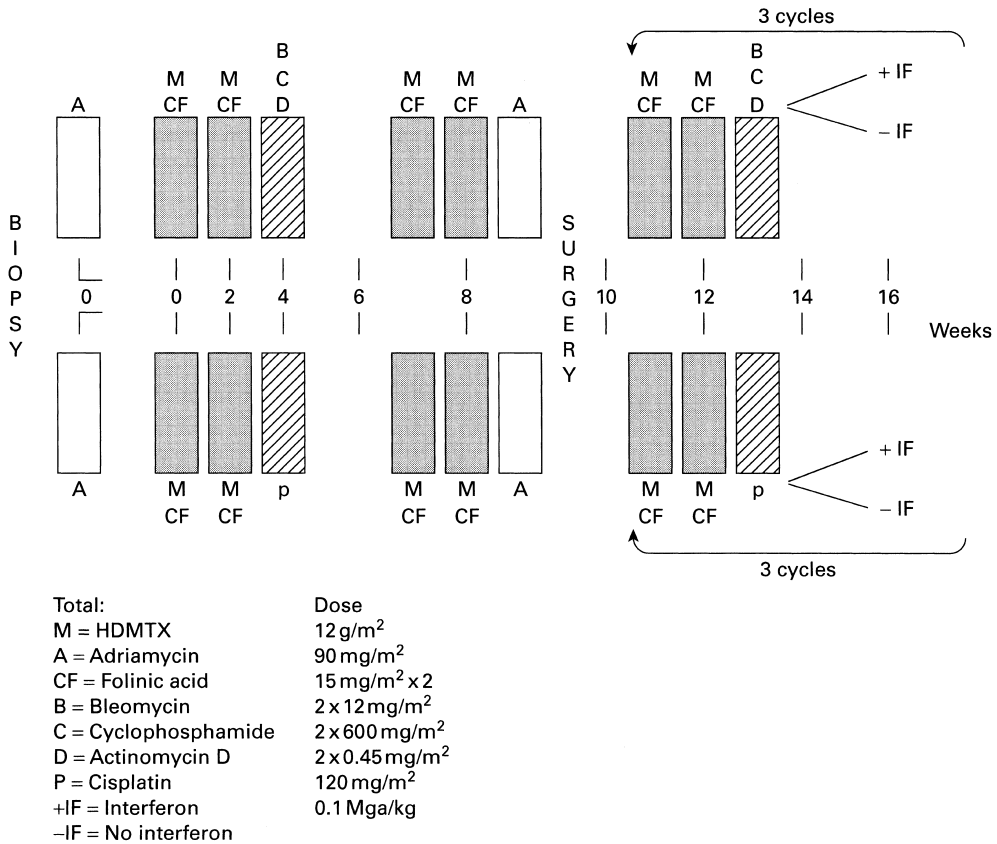
Edmonson JH, Green SJ, Ivins JC, Gilchrist GS, Creagan ET, Pritchard DJ, Smithson WA, Dahlin DC, Taylor WF. A controlled pilot study of high-dose methotrexate as postsurgical adjuvant treatment for primary osteosarcoma. *J Clin Oncol* 1984;2:152–6.

The study was designed and run by the Mayo Clinic between 1976 and 1980.

### Objectives

The aim of the study was to evaluate:

- The role of adjuvant postoperative chemotherapy using regimen based on high dose methotrexate and vincristine (MTX/VCR).



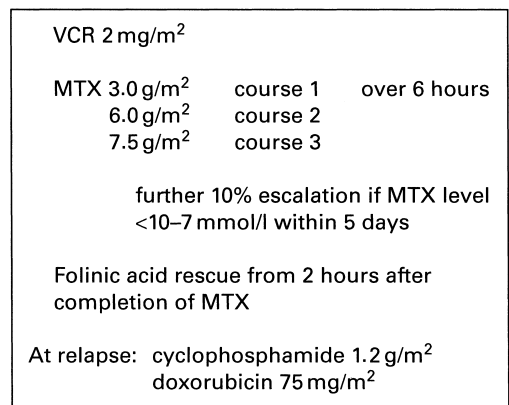
**Figure 2.1** Outline of chemotherapy regimen of the COSS-80 study. © American Society of Clinical Oncology (full reference on p. 29).

**Details of the study/outcome**

Ninety-five eligible patients were considered who were free of distant metastases using technetium scan and CT scan. Eighty-seven were approached, and of these 41 consented to be randomized. Thirty-eight patients had osteosarcoma, three had other pathologies. The median age was 17. Twenty received chemotherapy and 21 follow up alone. Randomization was done at the Mayo Clinic using a sequential treatment assignment, with balance of prognostic factors by “dynamic allocation”. Only the 38 osteosarcoma were subsequently analyzed.

Postsurgical follow up comprised six weekly visits during year 1 and every 3 months during year 2 and the same follow up was applied after chemotherapy treatment. Chemotherapy details and doses are given in Figure 2.2.

Major outcome measures were progression-free survival (PFS) and overall survival (OS).



**Figure 2.2** Chemotherapy regimen. © American Society of Clinical Oncology (full reference on p. 29).

Analysis showed a PFS of 40% in both groups and 5 year OS of 50%.

### Toxicity

The toxicity was inevitably higher in the chemotherapy arm, with predictable myelosuppression, dermatitis and diarrhea. No treatment related deaths were reported.

### Conclusion

It was concluded that there was no benefit to adjuvant chemotherapy. It was, however, noted that the estimated

survival of 52% 5 years after surgery exceeded all reasonable survival expectation based on historical reports. This inexplicably high cure rate surgery alone may have accounted for the lack of any demonstrable benefit from chemotherapy.

## Study 3

Jaffe N, Robertson R, Ayala A, Wallace S, Chuang V, Anzai T, Cangir A, Wang Y-M, Chen T. Comparison of intra-arterial cis-diamminedi-chloroplatinum II with high-dose methotrexate and citrovorum factor rescue in the treatment of primary osteosarcoma. *J Clin Oncol* 1985;3:1101–4.

The study was designed and carried out at the MD Anderson Hospital between 1980 and 1984.

### Objectives

The aim of the trial was:

- To compare the efficacy of intra-arterial cisplatin with high dose intra-arterial or intravenous methotrexate.

### Details of the study

Thirty patients with non-metastatic osteosarcoma (staging methods not detailed) were allocated to receive either intra-arterial cisplatin or high dose methotrexate (MTX), given by intra-arterial route in nine patients and by intravenous route in six. The decision to change from intra-arterial to intravenous was unclear. This was said to be for logistical reasons and also that during the course of the investigations “pharmacological studies” showed no significant differences in terms of response if the drug was administered by the intra-arterial or

intravenous route. Postsurgical chemotherapy depended on response and included MTX and doxorubicin (Adriamycin). Patients were aged 2–16, median 12 years.

The method of randomization used is not described. Details of drugs and doses are given in Figure 2.3.

The main outcome measures were clinical response after one course of chemotherapy and pathological response defined at time of surgery at 2–3 months. Complete response (CR) was defined as more than 90% of non-viable tumor, partial response (PR) 60–90%.

### Outcome

Following high dose MTX there were 4/15 responses, 3 CR, 1 PR; with cisplatin there were 9/15 responses, 7 CR and 2 PR,  $p = 0.06$ . There was said to be more rapid pain relief with the cisplatin regimen.

### Toxicity

There was one toxic death associated with high dose MTX.

### Conclusion

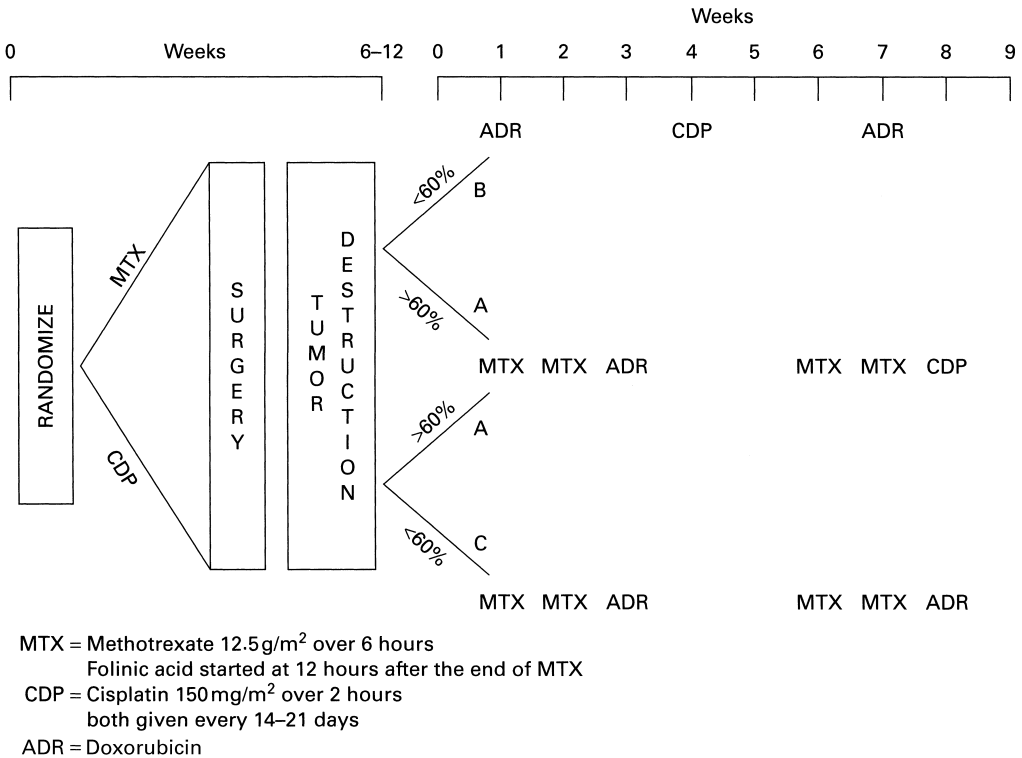
It was concluded that cisplatin was superior. Response was, however, assessed at a variable stage after between two and seven courses of chemotherapy. The distribution of assessment timing between the two arms was not detailed. The number of patients was also very small to show significant difference between the two regimens.

## Study 4

Link MP, Goorin AM, Miser AW, Green AA, Pratt CB, Belasco JB, Pritchard J, Malpas JS, Baker AR, Kirkpatrick JA, Ayala AG, Shuster JJ, Abelson HT,

Simone JV, Vietti TJ. The effect of adjuvant chemotherapy on relapse-free survival in patients with osteosarcoma of the extremity. *N Engl J Med* 1986;314:1600–6.

The study was designed and run by the multi-institutional Osteosarcoma Study Group under the



**Figure 2.3** Treatment schema. Adapted with permission from Link *et al.* (full reference on p. 31). © 1986 Massachusetts Medical Society.

auspices of the Pediatric Oncology Group and took place between 1982 and 1984.

**Objectives**

The aim of the trial was:

- To address the issue whether multiagent chemotherapy would improve the outcome when given as adjuvant therapy after amputation.

**Details of the study**

Non-metastatic patients (staged using CT scan and bone scan) under the age of 30 years with high grade osteosarcoma which was completely excised were eligible. Chemotherapy was started less than 4 weeks from the time of surgery.

Randomization was through the POG statistical office, but the precise methodology is not detailed.

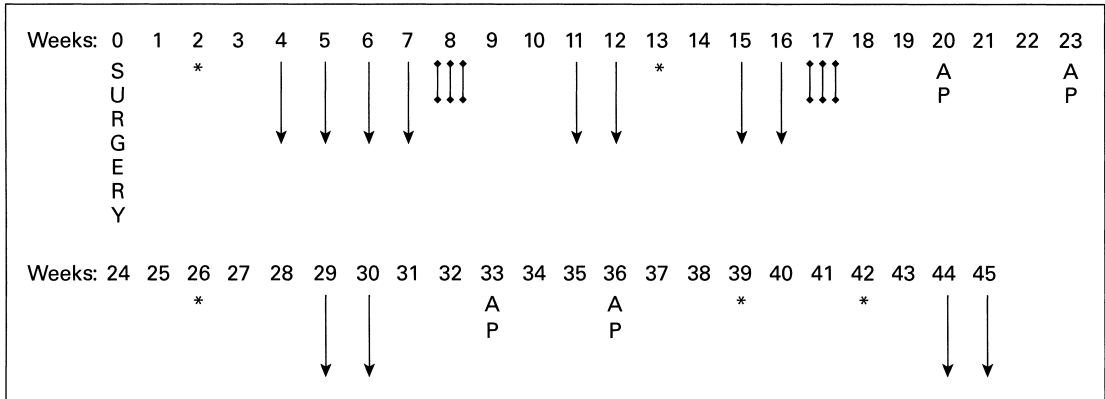
Chemotherapy comprised cyclophosphamide, methotrexate, doxorubicin (Adriamycin) and cisplatin

given over a 4–5 week period. Methotrexate dose was modified in each patient in order to achieve a target of  $1 \times 10^3 \mu\text{mol}$  concentration. Dose details are given in Figure 2.4.

The primary outcome measure was relapse-free survival (RFS) and it was predicted that 196 patients would need to be registered to show a 20% increase in 2-year RFS, i.e. 60% versus 40%, 80% power.

Out of 156 patients registered, 113 were eligible. Ineligibility included low grade lesions, metastases, axial primary, incomplete resection, prolonged interval from diagnosis, prior history of cancer and inappropriate staging. Only 36 patients accepted randomization: 18 were randomized to chemotherapy and 18 to observation alone.

Follow up of patients in both adjuvant chemotherapy and control groups included monthly chest X-rays and CT scanning every 4 months. Bone scan was performed 6 monthly and X-ray of the primary site every 4 months for 2 years after surgery. During the third



Adjuvant chemotherapy was begun 2 weeks after definitive surgery of the primary tumor

\* = Cyclophosphamide 600 mg/m<sup>2</sup>  
 Bleomycin 15 mg/m<sup>2</sup>  
 Actinomycin 0.6 mg/m<sup>2</sup> } × 21 days

↓ = Methotrexate 12 g/m<sup>2</sup>  
 escalated to achieve serum level of 10<sup>3</sup> μmol

† = Doxorubicin 30 mg/m<sup>2</sup> × 3 doses

AP = Doxorubicin 50 mg/m<sup>2</sup>  
 Cisplatin 100 mg/m<sup>2</sup>

**Figure 2.4** Chemotherapy regimen of the multi-institutional osteosarcoma study. Adapted with permission from Link *et al.* (full reference on p. 31). © 1986 Massachusetts Medical Society.

year after diagnosis chest X-rays were obtained every 2–3 months.

## Outcome

Analysis revealed a 2-year RFS of 17% for those not receiving chemotherapy, compared with 66% in those receiving chemotherapy,  $p < 0.001$ . Overall survival was in the region of 70% and did not differ between the two arms.

Predictably, chemotherapy was associated with complications and significant sepsis occurred in one-third of patients. There were two chemotherapy related deaths.

Distribution of patients between the two arms was relatively well balanced, a slightly higher percentage in

the observation arm being over 12 years of age (12 versus 10), and having a distal femur primary (9 versus 5). More patients on the chemotherapy arm had a proximal tibial primary (6 versus 2). The same number had resection, as opposed to amputation, at presentation.

## Conclusion

It was concluded that adjuvant chemotherapy produced a highly significant improvement in RFS but the encouraging initial salvage rate following relapse reduced any effect on overall survival.

## Study 5

Eilber F, Giuliano A, Eckardt J, Patterson K, Moseley S, Goodnight J. Adjuvant chemotherapy for osteosarcoma. A randomised prospective trial. *J Clin Oncol* 1987;5:21–6.

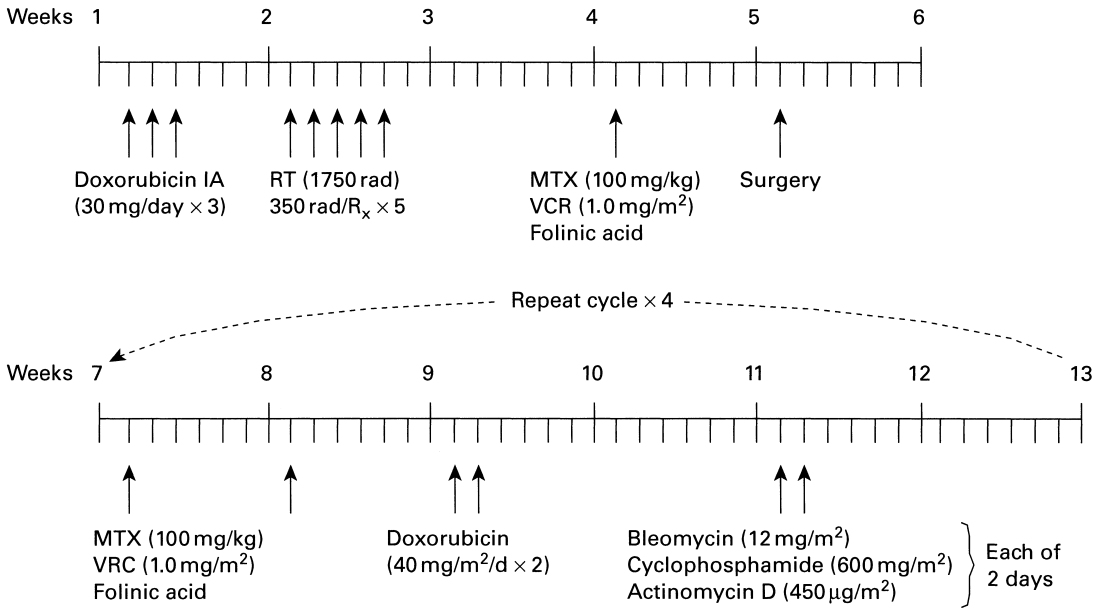
This study was planned and carried out by UCLA, between 1981 and 1984.

## Objectives

The study aims:

- To evaluate the role of the Rosen T10 regimen as adjuvant chemotherapy following preoperative intra-arterial doxorubicin and local irradiation followed by definitive surgery.





**Figure 2.5** Treatment schedule. © American Society of Clinical Oncology (full reference on p. 33).

### Details of the study/outcome

All patients with high grade osteogenic sarcoma and non-metastatic disease on CT and technetium bone scan staging were eligible. Of the 112 bone tumors considered, 78 were osteogenic sarcoma. Nineteen patients were excluded due to metastases or low grade pathology. Of the 59 remaining, 32 received adjuvant chemotherapy and 27 observation alone.

Randomization was done using a file of sequential cards generated from a set of random numbers. They were balanced by treatment in blocks of 10. Randomization was done centrally at UCLA.

Intra-arterial doxorubicin was given for 3 days followed by 1750 cGy local radiation (RT) on 5 days to the whole bone. This was followed in 44 patients by limb sparing surgery with prosthesis and in 15 by amputation.

Chemotherapy comprised high dose methotrexate (MTX), vincristine (VCR), doxorubicin and bleomycin,

cyclophosphamide and actinomycin D (BCD), and the details are given in Figure 2.5.

The primary outcome measures were disease free and overall survival.

Twenty-eight of 32 patients allocated chemotherapy received the full regimen. Overall, 55% were disease free at 2 years of those allocated to chemotherapy, compared with 20% who did not receive chemotherapy,  $p < 0.01$ . Eighty percent receiving chemotherapy were alive, compared with 48%,  $p < 0.001$ . Median time to relapse was 11 months in the chemotherapy arm, compared to 5 months in the observation alone group.

### Conclusion

It was concluded that there was a significant benefit in the addition of T10 Rosen chemotherapy following surgery.

## Study 6

Burgers JMV, Van Glabbeke M, Busson A, Cohen P, Mazabraud AR, Abbattucci JS, Kalifa C, Tubiana M, Lemerle JS, Voute PA, van Oosterom A, Pons A,

Wagener T, Van Der Werf-Messing B, Somers R, Duez AN. Osteosarcoma of the limbs. Report of the EORTC-SIOP 03 trial 20781 investigating the value of adjuvant treatment with chemotherapy and/or prophylactic lung irradiation. *Cancer* 1988;61:1024–31.

**Table 2.1** Schedule of adjuvant chemotherapy.

Weeks	Induction				Consolidation				
	1	3	5	7	9	11	13	15	17
CYP									
ADR									
VCR/MTX/CF									

Cycles of consolidation chemotherapy to be given for a total of 4 times, up to week 41.

MTX: methotrexate (600 mg/m<sup>2</sup>/6 hour infusion); CF: citrovorum factor (15 mg 6 weekly × 12); VCR: vincristine (1.5 mg/m<sup>2</sup> IV max 2 mg); ADR: Adriamycin (doxorubicin) 70 mg/m<sup>2</sup> IV; CYP: cyclophosphamide (1200 mg/m<sup>2</sup> IV).

This study was designed and executed by the EORTC between 1978 and 1983.

### Objectives

The study aims:

- To compare three different approaches to the treatment of undetectable lung metastases at presentation: lung radiotherapy, chemotherapy alone or a combination of chemotherapy and radiotherapy.

### Details of the study/outcome

Two hundred and forty patients below the age of 30 years were registered, of whom 205 were evaluable. Exclusions were due to low grade histology, lung metastases and inadequate data. Staging comprised technetium bone scan and lung tomography. CT scan was not routinely used.

The initial surgical approach was amputation in 168 patients and local radiotherapy alone in 37.

The details of randomization method are not given. Groups were, however, well balanced by age and site.

Sixty-five patients were allocated to chemotherapy alone and received vincristine and methotrexate, alternating with doxorubicin (Adriamycin), followed by

cyclophosphamide, alternating with doxorubicin or methotrexate. Details of chemotherapy are given in Table 2.1. Seventy-three patients were allocated to receive 20 Gy bilateral lung irradiation and 67 patients received 9 weeks of initial chemotherapy, followed by 20 Gy lung irradiation.

The outcome measures considered were disease free and overall survival, metastases-free survival, time to recurrence and toxicity.

Disease-free survival at 5 years was 40% for chemotherapy alone, 44% for lung irradiation alone and 45% for combination therapy. There were 3 deaths, all in the chemotherapy alone arm. Lung function was impaired in 14% of those receiving irradiation.

### Conclusion

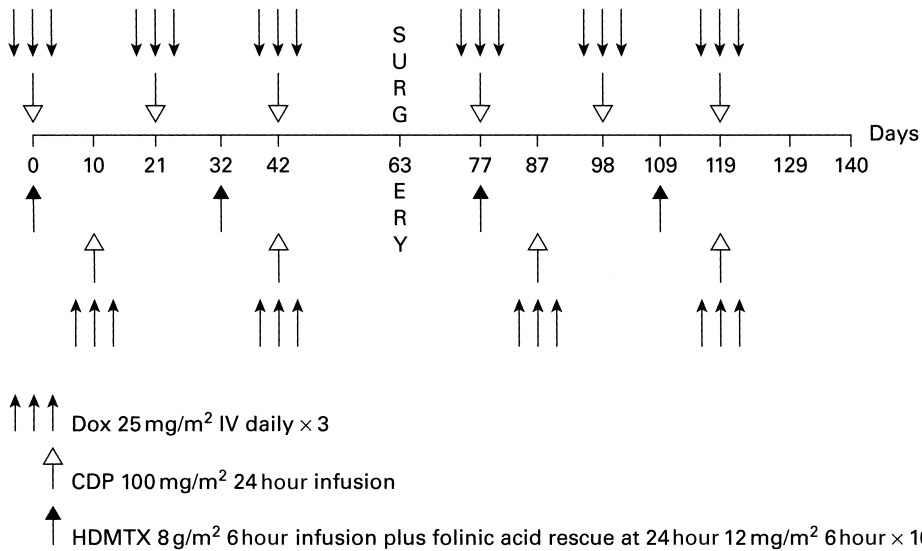
The conclusion was that there was no significant difference between these approaches but a control arm with no adjuvant therapy was not included in the study design.

Reservations about the study mentioned by the investigators were the poor compliance with regard to guidelines for the administration of lung irradiation. There was also an imbalance in the nature of initial surgery prior to the study protocol.

## Study 7

Bramwell VHC, Burgers M, Sneath R, Souhami R, van Oosterom AT, Voute PA, Rouesse J, Spooner D, Craft AW,

Somers R, Pringle J, Malcolm AJ, van der Eijken J, Thomas D, Uscinska B, Machin D, van Glabbeke M. A comparison of two short intensive adjuvant chemotherapy regimens in operable osteosarcoma of limbs in



**Figure 2.6** Chemotherapy regimens. © American Society of Clinical Oncology (full reference on p. 35).

children and young adults: the first study of the European Osteosarcoma Intergroup. *J Clin Oncol* 1992; **10**:1579–91.

The study was designed and carried out by the Medical Research Council (MRC), United Kingdom Children's Cancer Study Group (UKCCSG) and European Organisation for Research into Treatment of Cancer (EORTC) between 1983 and 1986.

It was initially started as a randomized phase II study, but because of good recruitment was extended to a formal phase III comparative study.

### Objectives

The aim of the study was:

- To compare two chemotherapies: doxorubicin/cisplatin in one arm and high dose methotrexate combined with reduced dose intensity doxorubicin and cisplatin in the other arm.

### Details of the study

Patients under 40 years of age with non-metastatic extremity high grade tumors were eligible. Staging including CT scan and technetium bone scan. The chemotherapy could be given either pre- or postsurgery but had to commence less than 35 days following diagnostic biopsy.

The randomization was carried out at the EORTC/MRC centers by telephone call. Patients were randomized in such a way that a balance between the number of patients who received each treatment was maintained throughout the trial within each collaborating center. To maintain approximately equal number of patients for each treatment, with respect to creatinine clearance, age less than 15 years, type of surgery, preoperative or postoperative chemotherapy, a minimization procedure was used.

Regimen A comprised doxorubicin (DOX) and cisplatin (CDP) given 3 weekly for six courses and regimen B, high dose methotrexate (HDMTX) 10 days prior to doxorubicin/cisplatin, which was given approximately 4 weekly. Details are given in Figure 2.6. The trial was designed to detect an increase in survival of 20% from 50–70% with 80% power.

The primary outcome measures were metastatic- and disease-free survival, overall survival and comparative toxicities.

### Outcome

Three hundred and seven patients were registered, of whom 25 were excluded due to inadequate data. These came from one cooperative group and two additional centers. From the text it is unclear whether 307 patients were registered and randomized or whether these 25 were excluded from randomization. A further 54 were

excluded because of the presence of metastatic disease, an axial primary and locally recurrent disease. A further 35 were ineligible for analysis due to excessive delay between biopsy and chemotherapy or other protocol deviations. The study finally included 198 patients, 99 patients in each arm (114 excluded from 307 should leave only 193). The two groups appeared well balanced, although there were more humeral primaries in regimen B (19 versus 7).

Full details of the delivered intended dose and timing in both arms is given. A higher percentage of patients in arm B received intended dose, on time, and completed full therapy. There was one toxic death in arm A. There was a higher incidence of hepatic complications in arm B, associated with HDMTX, and more neurological and audiometric toxicity in arm A, associated with a higher cisplatin dose and dose intensity. Pathological response was documented in only 66 of 179 possible patients. A good response, i.e. over 90% necrosis, was noted in 41% of arm A and 22% of arm B. This was not statistically significant largely due to the small number evaluable.

Local recurrence rate was similar in both arms and there was no difference between the ultimate surgery, i.e. amputation, or prosthesis. Overall, there were fewer metastatic recurrences in those having conservative surgery.

At 5 years, 39% of group A and 53% of group B were free of metastases. The disease-free survival was 57% for group A, 41% for group B,  $p = 0.05$ . Overall survival was 64% and 50%, respectively, which was not statistically significant.

### Conclusion

The conclusion was that the lower dose intensity cisplatin/doxorubicin arm was probably inferior, despite the addition of HDMTX. It appeared that the addition of methotrexate, whilst reducing platinum related toxicity, did not compensate for a reduction in efficacy due to reduced dose and dose intensity.

## Study 8

Bacci G, Picci P, Ruggieri P, Mercuri M, Avella M, Capanna R, Brach Del Prever A, Mancini A, Gherlinzoni F, Padovani G, Leonessa C, Biagini R, Ferraro A, Ferruzzi A, Cazzola A, Manfrini M, Campanacci M. Primary chemotherapy and delayed surgery (neoadjuvant chemotherapy) for osteosarcoma of the extremities. *Cancer* 1990;65:2539–53.

This study was carried out at the Istituto Rizzoli between 1983 and 1986.

### Objectives

The study aims:

- To compare two doses of methotrexate in combination with cisplatin, given preoperatively.

### Details of the study

The study involved patients less than 50 years old with high grade osteosarcoma at extremity sites. They were non-metastatic on CT and technetium staging and had received no prior chemotherapy.

The randomization method is not described, but patients were stratified by site.

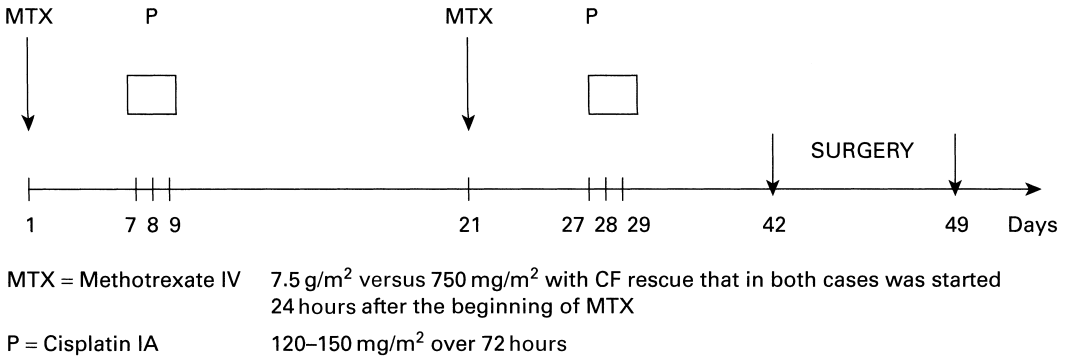
The two regimens comprised high dose (HD) methotrexate 7.5 g/m<sup>2</sup> and moderate dose (MD) methotrexate 750 mg/m<sup>2</sup> followed by intra-arterial cisplatin (full details are given in Figure 2.7a).

The primary outcome measure was histological response, defined as good – more than 90% necrosis; fair – 60–89% necrosis and poor – <60% necrosis. There was central pathological review in all cases.

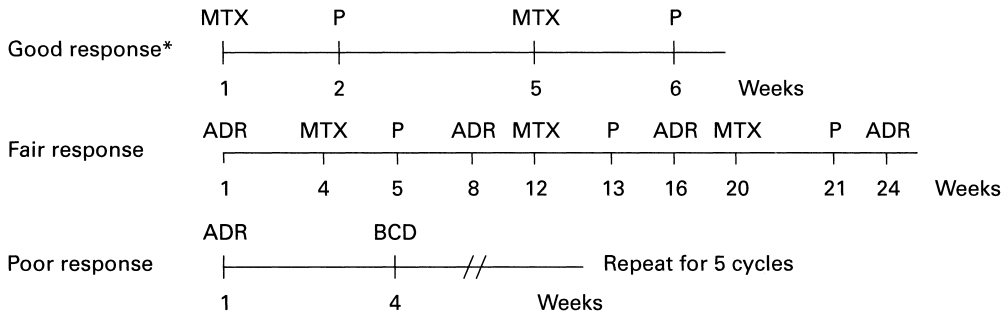
### Outcome

Two hundred and forty-two patients were diagnosed in the study period, of whom 178 were eligible. The reasons for exclusions were detailed and included the presence of metastases, low grade tumors and para- or periosteal sarcoma. Thirty-two patients refused randomization. A further 11 were not evaluated due to refusal to receive the allocated chemotherapy. A total of 127 were therefore included in the final analysis. Sixty-seven were randomized to HDMTX and sixty to MDMTX.

Good histological response was seen in 41 of 66 evaluable patients receiving HDMTX (62%), compared



**Figure 2.7a** Chemotherapy protocol. Copyright © 1990 American Cancer Society. Adapted and reprinted from Bacci G *et al.* (full reference on p. 37) by permission of Wiley-Liss, Inc., a subsidiary of John Wiley & Sons, Inc.



**Figure 2.7b** Subsequent chemotherapy protocol according to response to initial treatment. Copyright © American Cancer Society (as Figure 2.7a).

to 25/60 receiving MDMTX (42%) ( $p < 0.04$ ). There were 3 patients with clinically progressive disease. The clinical and radiological features were not always consistent with pathology and these were not formally compared. Despite the difference in response, there was no difference in ultimate local control rates. The subsequent chemotherapy depended on initial treatment. Those with a good response were initially continued on methotrexate and cisplatin alone, but initially poor outcome led to a change in strategy, with the addition of doxorubicin (Adriamycin) in all cases. In patients with a fair response doxorubicin was added and those with a poor response switched to a doxorubicin/BCD combination (see Figure 2.7b).

The overall 5-year disease-free survival for the HDMTX arm was 58%, and 42% for the MDMTX arm ( $p = 0.07$ ). Overall, the response predicted outcome with 65% versus 40% versus 10% overall survival for good, fair and poor responders, respectively ( $p = 0.01$ ). No significant difference in toxicity was noted between the two arms.

### Conclusion

It was concluded that HD methotrexate was significantly better than MD methotrexate in achieving a good histological response but within the current study did not lead to a significant improvement in outcome.

## Study 9

Winkler K, Bielack S, Delling G, Salzer-Kuntschik M, Kotz R, Greenshaw C, Jurgens H, Ritter J, Kusnierz-Glaz C, Erttmann R, Gadicke G, Graf N, Ladenstein R, Leyvraz S, Mertens R, Weinel P. Effect of intraarterial versus intravenous cisplatin in addition to systemic doxorubicin, high dose methotrexate, and ifosfamide on histologic tumour response in osteosarcoma (study COSS-86). *Cancer*, 1990;66:1703–10.

This study was designed and executed by the COSS group between 1986 and 1988.

### Objectives

The aim of the study was:

- To compare intra-arterial with intravenous cisplatin given preoperatively following initial standard chemotherapy, using doxorubicin and high dose methotrexate.

### Details of the study

Eligible patients were those defined as high risk on the basis of extent of tumor greater than one-third of total bone, more than 20% chondroid, less than 20% reduction in early/late phase bone scan following initial

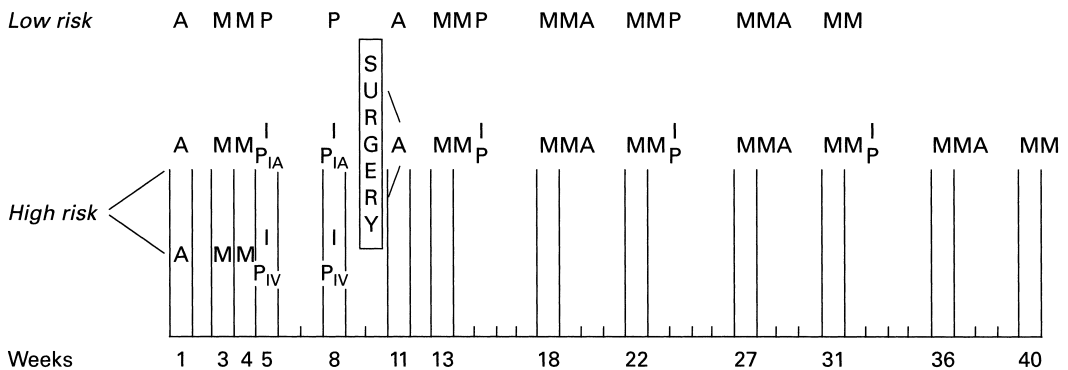
chemotherapy, including both metastatic and non-metastatic patients.

It was estimated that 100 patients should be included to detect a 25% increase of good response from 50% to 75%, with an 80% power.

Randomization was planned to be done centrally, with stratification for age, sex, site, size, chondroid and bone scan response. For reasons not entirely clear in the text, strict randomization was not always feasible, due to some institutions' refusal to give intra-arterial cisplatin. Most patient were therefore "allocated" centrally, striving to balance all risk factors. Moreover, a number of patients were non-evaluable due to protocol violations (not further specified).

The treatment comprised initial doxorubicin (Adriamycin), followed by methotrexate and then a third course with ifosfamide and cisplatin, the latter given either intra-arterial (IA) or intravenously (IV). Surgery then followed (for full details see Figure 2.8). The dose of cisplatin initially was 150 mg/m<sup>2</sup> but this was reduced to 120 mg/m<sup>2</sup> because of a high incidence of toxicity, and the infusion time was also increased to 5 hours.

The primary outcome measure was pathological response. A favorable response was defined as >90% tumor destruction.



A = Adriamycin 45 mg/m<sup>2</sup>/d × 2

M = High dose methotrexate 12 g/m<sup>2</sup>

I = Ifosfamide 3 g/m<sup>2</sup>/d × 2

P = Cisplatin IV infusion: 120 mg/m<sup>2</sup>

P<sub>IA</sub> = Cisplatin IA infusion: 150 (120) mg/m<sup>2</sup>

P<sub>IV</sub> = Cisplatin IV infusion: 150 (120)\* mg/m<sup>2</sup>

**Figure 2.8** Outline of chemotherapy (\*see text on p. 39). Copyright © 1990 American Cancer Society. Adapted and reprinted from Winkler K *et al.* (see full reference on p. 39) by permission of Wiley-Liss, Inc., a subsidiary of John Wiley & Sons, Inc.

## Outcome

Of 241 patients enrolled in the study 27 were low risk. Of the high risk patients, 94 were excluded, 38 had early surgery, 15 late surgery and 9 no surgery. There were protocol violations in 11 and 21 had missing data.

Of the 109 “randomized” patients who were evaluable there was an overall balance of risk factors, except the patients who received (IV) cisplatin were somewhat older and there were more with proximal tibial lesions. The IA route led to a 68% good response rate and the

IV route to a 69% good response rate. There were no major differences in toxicity and these are detailed in the study text.

## Conclusion

It was concluded that the IA route does not add to the efficacy of cisplatin when given in combination with other active agents.

## Study 10

Souhami RL, Craft AW, Van der Eijken JW, Nooij M, Spooner D, Bramwell VHC, Wierzbicki R, Malcolm AJ, Kirkpatrick A, Uscinska BM, Van Glabbeke M, Machin D. Randomized trial of two regimens of chemotherapy in operable osteosarcoma: a study of the European Osteosarcoma Intergroup. *Lancet* 1997; **350**: 911–17.

This study was designed and run by a collaborative group, combining the EORTC, MRC and UKCCSG plus other centers. It ran between 1986 and 1991.

### Objectives

The study aims:

- To address the issue as to whether a short intensive chemotherapy regimen with doxorubicin and cisplatin would produce survival of patients with operable non-metastatic osteosarcoma, similar to that obtained with a complex and longer duration regimen, based on the Rosen T10 protocol.

### Details of the study

The study was a prospective, randomized trial. Eligible patients were under the age of 40 years, had high grade osteosarcoma and had received no prior chemotherapy. They had non-metastatic disease detected on CT scan and technetium bone scan. The time from biopsy to randomization had to be less than 35 days.

Randomization was done by telephone or fax via the EORTC or other centralized data center offices. The minimization procedure was used and patients were stratified for site, age and planned surgery. The study was designed to exclude a difference of 15% in 5-year survival, a significance of 5% in a two-sided test, with

80% power. It was predicted to recruit 400 patients overall. Interim analysis was planned every 6 months but there were no formal stopping rules.

Outcome measures were response rates, survival and progression-free survival.

Patients were randomized to receive either an 18 week regimen, including doxorubicin/cisplatin (arm A), or a 44 week multidrug regimen (arm B), based on Rosen T10 (see Figure 2.9). Surgery was at 9 weeks and 7 weeks, respectively.

### Outcome

The estimated source population was 600 patients and 407 were randomized. No formal record was kept of patients refusing randomization. Of the 407, 15 were ineligible due to other pathology, secondary deposits or non-limb primaries. Three hundred and ninety-one were therefore included on the trial and were well balanced for prognostic subgroups. The minimum follow up was 4.5 years, median 5.6 years. Overall compliance was good. With regard to surgical timing, 84% of the two-drug arm were on time and 72% of the multidrug arm. Median time to surgery was 75 days in the two-drug arm and 57 days in the multidrug arm. There was a high degree of dose reduction in both arms, with about two-thirds of the planned dose intensity given in both treatment arms. This was due both to toxicity and early relapse, the latter particularly in the multiagent, longer duration arm B.

### Toxicity

Toxicity was more severe in the two-drug arm, including grade 4 leucopenia (75% versus 19%), thrombocytopenia (46% versus 3%) and severe infection (21% versus 3%) when comparing the two-drug versus six courses of the multidrug regimen. No statistical comparison is presented.

- **Two-drug regimen**

Doxorubicin 25 mg/m<sup>2</sup> × 3  
 Cisplatin 100 mg/m<sup>2</sup>  
 6 cycles at 21 day intervals

- **Multidrug regimen**

Preoperative: Vincristine 1.5 mg/m<sup>2</sup>  
 Methotrexate 8 g/m<sup>2</sup>  
 (12 g/m<sup>2</sup> for < 12 yr)  
 Folinic acid rescue started  
 at 18 h after end of MTX  
 VCR/MTX given weekly × 4  
 Doxorubicin 25 mg/m<sup>2</sup> × 3

Postoperative: Bleomycin 15 mg/m<sup>2</sup> }  
 Cyclophosphamide 600 mg/m<sup>2</sup> } × 2 days  
 Actinomycin D 0.6 mg/m<sup>2</sup> }  
 Doxorubicin 30 mg/m<sup>2</sup> } × 2 days  
 Cisplatin 120 mg/m<sup>2</sup> }

**Figure 2.9** Chemotherapy doses. Reprinted from Souhami *et al.* (full reference on p. 40) with permission from Elsevier.

The type of surgery ultimately carried out was compared in the two arms. Fewer amputations were performed than planned in arm A (22/40) compared with arm B (27/41). Where conservative surgery was planned, it was achieved in 87% arm A and 83% in arm B.

Clinical response in arm A was 59% and in B, 42% (odds ratio 2.02). All initial pathology was reviewed centrally but only 66% of resection samples were ultimately centrally reviewed. For pathological response, a good response was defined as at least 90% necrosis of the tumor, and poor response as any degree less than this. In arm A there was a 30% good response and in arm B, 29%.

Progression-free survival and overall survival were identical in both arms: 65% at 3 years and 55% at 5 years for arm B. The outcome for good pathological responders was 75% at 5 years, compared to 45% for bad responders. There was the same difference for both study arms.

### Conclusion

There was no difference between the two-drug and the multidrug regimens, although a difference of 10% or less would not be detectable in the trial. The two-drug regimen is cheaper, of shorter duration and concluded to be the treatment of choice despite its higher early toxicity.

### Comments

The inevitably increased late effects of doxorubicin and cisplatin in children are not given specific consideration when discussing the merits of the two regimens.

combination as preoperative chemotherapy, reserving cisplatin/doxorubicin for poor responders.

## Study 11

Winkler K, Beron G, Delling G, Heise U, Kabisch H, Purfurst C, Berger J, Ritter J, Jurgens H, Gerein V, Graf N, Russe W, Gruemayer ER, Ertelt W, Katz R, Preusser P, Prindull G, Brandeis W, Landbeck G. Neoadjuvant chemotherapy of osteosarcoma: results of a randomized cooperative trial (COSS-82) with salvage chemotherapy based on histological tumor response. *J Clin Oncol* 1988;6:329–37.

The trial was designed and run by the German COSS Group between 1982 and 1984.

### Objectives

The study asked the question:

- Whether a combination of bleomycin, cyclophosphamide and actinomycin D (BCD) could replace the more toxic cisplatin and doxorubicin

### Details of the study

This was a prospective, randomized trial. Patients eligible had any primary classic osteosarcoma of the extremities, were free from detected metastases, under the age of 40 years, and had started chemotherapy less than 3 weeks after biopsy.

The method of randomization was not specified. Patients were stratified on the basis of age, above and below 12 years, sex, site and size of tumor (more or less than one-third of total bone). It was assumed that the 2-year metastatic-free survival (MFS) would be 80%. To detect a 20% difference, a total of 150 patients were planned, with 80% power, 5% significance. A stopping rule was included, so that if MFS was equal or more



than 15% worse than in the previous COSS-80 study in the first 50 patients the trial would be stopped.

Patients were randomized to receive high dose methotrexate in combination with either bleomycin, cyclophosphamide and actinomycin D (BCD) or cisplatin and doxorubicin (see Figure 2.10). Poor responders on the BCD arm were treated with cisplatin and doxorubicin and poor responders on the cisplatin/doxorubicin arm received a combination of cisplatin, ifosfamide and BCD.

The major outcome measure was MFS.

**Outcome**

Two hundred and fifty-nine patients were registered, of whom 118 were excluded for a variety of reasons, including over the age of 40 years, flat bone primary, presence of metastases, surgery at diagnosis or delayed chemotherapy. Of 141 entered on the trial, 16 were non-evaluable, predominantly due to chemotherapy violations.

Overall, clinical response showed a poor correlation with histological response. Of 81 patients, 42% of good responders had poor pathological response. There were 5 events other than metastases, 3 local relapses and

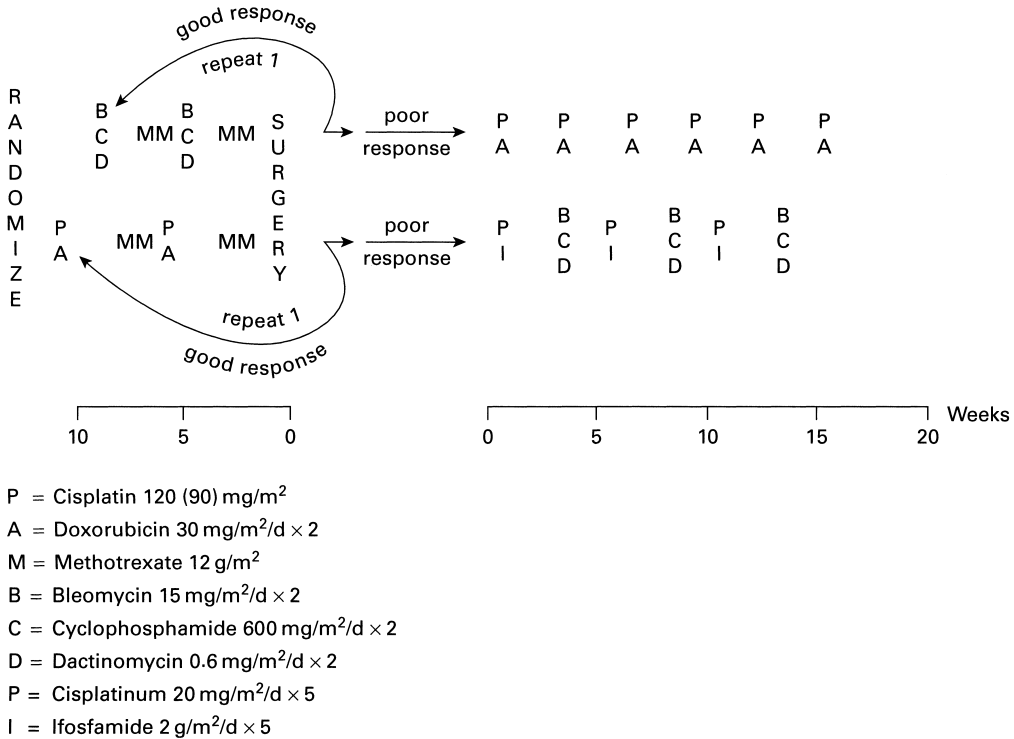
2 toxic deaths. Of 125 patients evaluable, the favorable pathological response defined as  $\geq 90\%$  tumor cell destruction was seen in 15 of 57 patients (26%) with BCD compared to 35 of 58 patients (60%) with doxorubicin/cisplatin ( $p < 0.001$ ). The 4-year MFS was 49% for BCD versus 68% for doxorubicin/cisplatin ( $p = 0.1$ ), but 5-year MFS was 45% versus 68% ( $p < 0.05$ ).

Overall, the 4-year MFS for poor responders was 44%, compared to 77% for favorable responders ( $p < 0.001$ ). The outcome in poor responders following BCD was 41%, compared to 53% following doxorubicin/cisplatin, when the appropriate second line chemotherapy was given (not significant).

The trial was stopped early due to the appearance of a significant difference in MFS. The number recruited when the study was discontinued was not specified.

**Toxicity**

There were two toxic deaths, one in each treatment arm. There was no significant difference in delays to chemotherapy in the two arms but in poor responders those given the ifosfamide-based regimen had the greatest delays between courses.



**Figure 2.10** Treatment protocol. © American Society of Clinical Oncology (full reference on p. 41).

There appears to have been a higher incidence of renal toxicity where cisplatin was combined with doxorubicin, compared to cisplatin alone than in the COSS-80 study. The cause of this was unclear.

**Conclusion**

Doxorubicin/cisplatin is significantly more effective than BCD in achieving a good response and MFS.

**Comments**

Full data regarding the stopping rule decision are not given. Overall, the follow up of patients was comparatively short.

**Study 12**

Meyers P, Gorlick R, Heller G, Casper E, Lane J, Huvos A, Healey J. Intensification of pre-operative chemotherapy for osteogenic sarcoma: results of the Memorial Sloan-Kettering (T12) protocol. *J Clin Oncol* 1998;16:2452–8.

Study carried out between 1986 and 1993 at the Memorial Sloan-Kettering Hospital, New York.

**Objectives**

The aim of the study was:

- To determine whether increased intensity preoperative chemotherapy would increase the percentage of good histological responses in consequently overall outcome.

**Eligibility**

Untreated adults and children with high grade osteogenic sarcoma. Sequentially presenting patients

were included apart from 15 who had primary resections on their tumor and 10 who declined to be enrolled.

There was institutional review of all pathology.

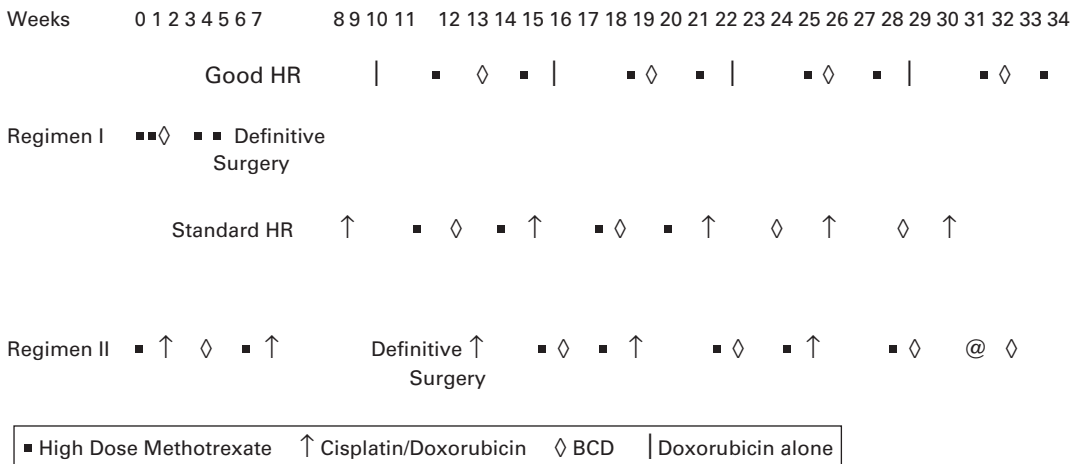
Randomization was by block randomization method using envelopes and was carried out in the local biostatistics office at MSK.

The primary outcome measure was event-free survival. No details of the difference expected power or anticipated numbers required are given.

**Study design**

Patients were randomized at presentation between two different initial regimens.

Regimen I was the Rosen T10 protocol consisting of high dose methotrexate and bleomycin, cyclophosphamide and actinomycin D (BCD) with doxorubicin postoperatively for good responders (Huvos grade I and II) or doxorubicin and cisplatin for standard responders (Huvos grade III and IV). Surgery took place at approximately 8 weeks from diagnosis.



**Figure 2.11** Outline of the chemotherapy administered as part of the T12 protocol used at MSKCC. HR, histologic response. © American Society of Clinical Oncology (full reference above).

The intensified regimen II comprised high dose methotrexate, BCD and the addition of Doxorubicin and Cisplatin preoperatively. The same postoperative chemotherapy was given as for regimen 1. Surgery took place approximately 12 weeks from presentation (see Figure 2.11).

### Outcome

Seventy-three patients were randomized, they were well balanced for age, sex, primary site, presence of secondaries, presenting alkaline phosphatase and LDH levels. Ages ranged from 4 to 36 years. Median age at diagnosis was 16 years in both groups. Twelve presented with lung metastases.

The pathological responses in group I were grade I and II; 22 patients, grade III and IV; 14 patients and regimen II grade I and II; 20 patients, grade III and IV; 16 patients. They had a median follow up of around 90 months. There was no difference in outcome between the two regimens. Event-free survival at 5 year was 73% for regimen I and 78% for regimen II.

### Conclusion

The addition of doxorubicin, cisplatin preoperatively neither improved histological response or outcome when added to the Rosen T10 regimen.

## Study 13

Bacci G, Ferrari S, Tienghi A, Bertoni F, Mercuri M, Longhi A, Fiorentini G, Forni C, Bacchini P, Rimondini S, De Giorgi U, Picci P. A comparison of methods of loco-regional chemotherapy combined with systemic chemotherapy as neo-adjuvant treatment of osteosarcoma of the extremity. *Eur J Surg Oncol* 2001; 27:98–104.

Study carried out between 1990 and 1994. Single institution study at the institute Rizzoli Bologna Italy.

### Objectives

The aim of the study was:

- To determine the value of intra-arterial cisplatin combined conventional livid chemotherapy in the treatment of extremity osteosarcoma.

### Details of the study

Eligibility comprised typical radiological and pathological features of high grade osteosarcoma. Tumor located at an extremity. Patient less than 40 years old. No metastases or lung metastasizes that were considered to be resectable. Initial staging mandated lung, CT and bone scan.

There was central institutional review by two pathologists.

The randomization method was not stated or its location. Patients were stratified in the basis of age, above

and below 15 years and on tumor site, distal femur or proximal tibia versus other sites.

The study was designed to recruit 100 patients which would have an 80% power alpha 0.05 to detect a 25% increase in good response rate following chemotherapy, i.e. an increase from 45% to 60%.

The primary end point was the rate of response based on pathological examination of the entire coronal section of the resected tumor. Between 5 and 25 blocks were examined and a good response was defined as greater than 90% tumor necrosis. Event-free survival was a secondary end point.

Initially 49 patients receive intra-arterial (IA) chemotherapy and 39 intravenous (IV). This was part of the high dose methotrexate, cisplatin and doxorubicin combination and the study was stopped early because of a higher response rate in the IA arm (77% versus 46% good response). The second component was a four-drug regimen with the addition of ifosfamide but asking the same question regarding IA chemotherapy; 142 patients were recruited between 1993 and 1994; 119 had localized tumors and 23 had resectable lung metastases. There was a good balance of risk factors for IA versus IV; under 15 years 62% versus 56%, femoral site 60% versus 67%, volume greater than 150 cm<sup>3</sup> 57% versus 54%, secondary metastases 5% versus 10%.

### Outcome

Overall the good response rate was higher than in the previous study 76% versus 62% ( $p < 0.04$ ). There was however no difference between the two study arms

80% (71–90%), 95% confidence interval versus 71% (61–82%) for IA versus IV, respectively. Similarly no difference in 5-year event-free survival (EFS) in either study. First study 53% versus 61%, second study 62% versus 54% for IA versus IV, respectively.

In the combined studies there are two chemotherapy related deaths, the hematological toxicity for both arms was similar. In the IA arm 7 of 112 patients developed local skin necrosis.

The limb salvage rate was the same for both groups 99/112 versus 91/109.

### Conclusion

With more aggressive chemotherapy including ifosfamide IA chemotherapy was not superior to cisplatin given IV.

## Study 14

Goorin AM, Schwartzenuber DJ, Devidas M, Gebhardt MC, Ayala AG, Harris MB, Helman LJ, Grier HE, Link MP, Pediatric Oncology Group. Presurgical chemotherapy compared with immediate surgery and adjuvant chemotherapy for non-metastatic osteosarcoma: Pediatric Oncology Group Study POG-8651. *J Clin Oncol* 2003;21:4662–3.

Study carried out between 1986 and 1993 by the American POG group. Study POG 8651.

### Objectives

The aim of the study was:

- To determine whether outcome was improved by the administration of preoperative chemotherapy with delayed surgery versus immediate surgery followed by chemotherapy.

### Details of the study

Eligibility was under 30 years of age with high grade non-metastatic osteosarcoma. All patients had CT scan of chest and bone scan within 2 weeks of study entry. Primary tumor had to be in an expendable bone or at an extremity site. There had to be no history of cancer and no prior therapy. All pathology was centrally reviewed and there was also a review of surgical reports to confirm nature and extent of surgery. Randomization was carried out at the POG central office. Randomization method not stated. Randomization was balanced for site (above knee/elbow versus the rest) LDH level and whether amputation or resection was planned.

It was planned to recruit 215 patients over a 4-year period. This would have an 80% power, alpha 0.05 to detect a 2-year event-free survival (EFS) difference of 15%. Two armed design detecting increase or

decrease in outcome, i.e. from 65% to 80% or 50% from 65%.

Poor recruitment in the first 2 years lead to an amendment of the protocol with a change to a one-sided test where 110 patients would be recruited with an 80% power of detecting a worsening of 15% from base line 65% EFS.

### Study design

Patients who were treated with initial chemotherapy were commenced on chemotherapy within 3 days of registration. Surgery was carried out at week 10. The adjuvant therapy arm had surgery at presentation with chemotherapy commencing within 21 days of surgery. Follow up consisted of monthly chest X-ray, 4 monthly chest CT scan and primary site X-ray, and 6 monthly bone scan for a total of 2 years. Chemotherapy details are shown in Figure 2.12.

### Outcome

A total of 106 patients were enrolled, 5 were ineligible due to pathology or stage discrepancy; 45 had presurgical chemotherapy (group A) and 55 immediate surgery (group B). There was a good balance between the two groups over 12 years 58% versus 58%, femur primary site 58% versus 64% planned local resection 51% versus 53%, planned amputation 49% versus 47% A versus B, respectively. Five patients randomized to group B in fact received presurgical chemotherapy.

In group A 8 patients had distant relapses, 1 local relapse, 6 developed progressive disease during presurgical chemotherapy at primary site, with or without metastases. In group B there were 15 metastatic relapses. Overall EFS of 5 years for group A was  $69 \pm 8$ , group B  $61 \pm 8$ .

The surgery carried out in the two groups was limb sparing surgery achieved in 50% group A and 55% of

R	Weeks	0	1	2	3	4	5	6	7	8	9	10	11	12	13	14	15	16	17	18	19	20	21	22
A		↑	↑	A		↑	↑	A				S			↑	↑	B			↑	↑	‡		
N				P				P				U					C							
D												R					D							
O												G												
M												E												
I												R												
Z												Y												
E	Weeks	0	1	2	3	4	5	6	7	8	9	10												
		S		↑	↑	A				↑	↑	A												
		U				P						P												
		R																						
		G																						
		E																						
		R																						
		Y																						
		23	24	25	26	27	28	29	30	31	32	33	34	35	36	37	38	39	40	41	42			
		↑	↑	A			A			B		B				↑	↑	B		B				
				P			P			C		C					C		C					
										D		D					D		D					

**Figure 2.12** Chemotherapy regimen: the timing of surgery was determined by randomization to be performed at either week 0 or week 10; ↑, administration of high-dose methotrexate and leucovorin rescue; AP, doxorubicin and cisplatin administration; BCD, cyclophosphamide, bleomycin and dactinomycin and ‡, doxorubicin administration. © American Society of Clinical Oncology (full reference on p. 45).

group B. No information is provided regarding complete resection margins in either group. When analyzed according to treatment received there was no difference in outcome.

There was no difference in the toxicity between the two arms. There were two cardiac deaths, one bleomycin lung mortality and one secondary tumor – medulloblastoma. Surgical complications showed no difference between group A and group B.

**Conclusion**  
 No difference was seen whether chemotherapy was given preoperatively or postoperatively with regard to EFS or nature of surgery. A high overall amputation rate was observed in both arms of this study (approximately half the patients).

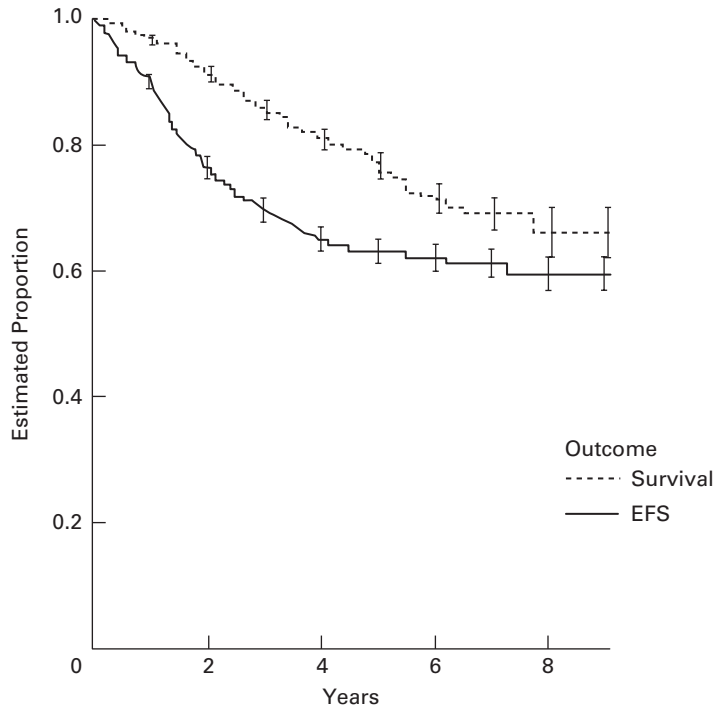
### Study 15

Meyers PA, Schwartz CL, Krailo M, Kleinerman ES, Betcher D, Bertstein ML, Conrad E, Ferguson W, Gebhardt M, Goorin AM, Harris MB, Healey J, Huvos A, Link M, Montebello J, Nadel H, Nieder M, Sato J, Siegal G, Weiner M, Wells R, Wold L, Womer R and Grier H. Osteosarcoma: a randomised, prospective trial of the addition of ifosfamide and/or myramyl tripeptide to cisplatin, doxorubicin, and high-dose methotrexate. *J Clin Oncol* 2005;23(9):2004–11.

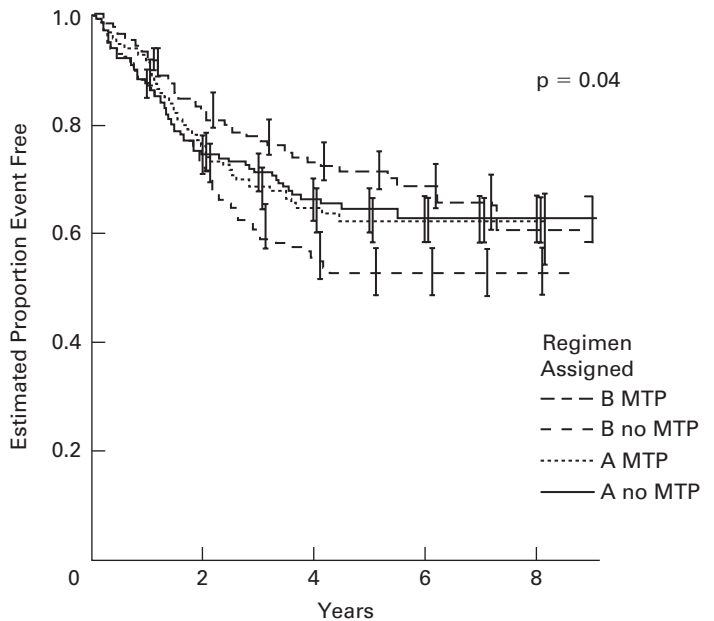
This study was carried out by the combined CCG and POG groups between 1993 and 1997.

**Objectives**  
 The aim of the study was to determine:

- Whether adding ifosfamide to a chemotherapy regimen comprising high dose methotrexate, doxorubicin and cisplatin would improve event-free survival.
- Whether adding the immuno-modulator muramyl tripeptide (MTP) to chemotherapy would improve outcome.



**Figure 2.13** EFS and overall survival for patients newly diagnosed with osteosarcoma without clinically detectable metastatic disease. © American Society of Clinical Oncology (full reference on p. 46).



**Figure 2.14** EFS for patients according to treatment arm. Regimen A consisting of cisplatin, doxorubicin and high dose methotrexate was the standard arm of this study. Regimen B included the same agents with the addition of ifosfamide. Regimens A+ and B+ also included the investigational agent muramyl tripeptide (MTP). Overall trend for difference was significant ( $p = 0.04$ ). © American Society of Clinical Oncology (full reference on p. 46).

## Details of the study

Eligibility included patients under the age of 30 years with osteogenetic sarcoma. Initial biopsy was recommended but amputation was permitted. Patients with metastases were eligible but only entered by the Children's Cancer Group (CCG). Only patients with non-metastatic disease were included in this analysis. Renal, liver and cardiac function had to be normal prior to therapy and treatment had to start within 30 days of surgery.

Patients were randomized at the outset of study. This was a  $2 \times 2$  factorial design. Randomization was in blocks of eight and patients stratified for presence of metastases, LDH level, nature of initial surgery and location of primary tumor.

The study required 585 patients over a 4-year period with 2 years observation beyond this time to detect a 0.64 reduction in risk for events with 80% power, two-sided test,  $p = 0.05$ . This design assumed the absence of any interaction between the two test treatments.

Adverse events were defined as progressive disease, secondary neoplasia or death in remission. Doing the study, due to temporary unavailability of filters for the muramyl tripeptide (MTP) approximately 6 months recruitment was regarded as non-compliant due to delayed start of MTP. This involved 101 patients. Recruitment was extended to allow for this.

Patients were allocated to regimen A or regimen B.

Regimen A comprised cisplatin  $120 \text{ mg/m}^2$  infused over 4 hours combined with doxorubicin  $75 \text{ mg/m}^2$  infused over 72 hours. These were given on week 0, 5, 12 and 17. Doxorubicin alone given at week 22 and 27. High dose methotrexate  $12 \text{ g/m}^2$  (maximum dose 20 g) was infused over 4 hours with 10 g leucovorin given over 24 hours. This was administered week 3, 4, 8, 9, 15, 16, 20, 21, 25, 26, 30 and 31.

Regimen B included ifosfamide  $1.8 \text{ g/m}^2$ , daily for 5 days, with mesna given weeks 0, 5, 17, 27 and 35. Cisplatin  $120 \text{ mg/m}^2$  was given 4 times, all during maintenance therapy postoperatively weeks 12, 22, 32 and 38. Doxorubicin and methotrexate were given in the same dose and timing as in regimen A. The total doses of doxorubicin and high dose methotrexate were the same in the two arms.

With this design, tumor necrosis at the time of surgery could be used as an end point to compare the efficacy of substituting ifosfamide for cisplatin during induction chemotherapy.

MTP ( $2 \text{ mg/m}^2$ ) was given twice weekly for 12 weeks and then weekly for an additional 24 weeks. The dose was increased if necessary to ensure signs of biological activity defined as fever, chills or increase in C reactive protein (CRP). If these were not evident then the dose was increased by 1 mg in the subsequent course and 2 mg in the next course up to a maximum of 5 mg.

## Results

Number of patients enrolled: 793, 16 were not eligible; 10 due to delay postbiopsy, 3 were not osteosarcoma, 1 had poor cardiac failure and 2 due to IRB issues.

100 had secondaries, leaving 677 eligible. 373 were male.

12 had initial amputation, 19 had axial primaries. On 105 there was inadequate information regarding surgery. Of the remaining, 415 had limb sparing surgery and 126 had amputations.

There were five treatment related deaths, four due to sepsis and one during surgery. There were two non-treatment related deaths. There were 11-second malignancies.

Following surgery there was no difference in the grade of necrosis between the protocols; Huvos grade III and IV; regimen A 125/292, regimen B, 140/292.

With regard to 5-year event-free survival (EFS), regimen A 64%, regimen B, 53%. In the arm where regimen B was combined MTP the EFS at 5 years was 72%, whereas for regimen A combined with MTP 5-year EFS was 63%. The overall trend for difference between the four arms was significant ( $p = 0.04$ ) (Figures 2.13, 2.14).

This unexpected finding, i.e. that MTP appeared to improve the outcome in the otherwise worse arm suggested significant interaction between ifosfamide and MTP. It was therefore necessary to analyze the four arms individually rather than using a  $2 \times 2$  factorial analysis and this reduced the power of the study. With this method no significant difference was observed between the arms.

## Conclusion

The addition of ifosfamide was of no significant benefit. There was a possible benefit from MTP specifically when combined with ifosfamide. It was postulated that this could involve the additive effect on Ifosfamide of MTP induced upregulation of Fas ligand expression. This mechanism could lead to enhanced tumor apoptosis (Figures 2.13 and 2.14).

## CHAPTER 3

# Ewing's sarcoma

*Commentary by Alan Craft*

James Ewing's original patient presented with a spontaneous fracture of the ulna and very soon the appearance of a tumor. It was initially suspected to be an osteogenic sarcoma and was treated with a radium pack with dramatic results – the tumor had completely regressed in 5 weeks. However, 18 months later the tumor recurred and eventually Ewing decided after histological examination of the tumor that it was a “diffuse endothelioma of bone”. The patient subsequently developed pulmonary metastases from which she died.

The problems encountered by Ewing are exactly those that we face today; that is, the dual control of the local tumor and micrometastatic spread. Historically, amputation alone could cure less than 5% of patients whilst radiotherapy to the primary does little better. The vast majority of patients must, therefore, have metastases at the time of diagnosis. The majority of these are in the lungs but a few patients have bone or bone marrow metastases.

In the late 1960s, early 1970s chemotherapy began to be used with dramatic effect. The survival went up from 5% to almost 50%. Mark Nesbit, one of the pioneers in the development of pediatric oncology in the United States, initiated the first randomized trial in this condition whose aim was to determine whether chemotherapy really was as good as it seemed from descriptive studies and secondly to evaluate whether doxorubicin, radiotherapy to the lungs, or both was superior (Study 1). Nesbit recognized the need for large studies and had the vision, and the leadership skills, to bring together the different children's cancer study groups in the United States to undertake the Intergroup Ewing's Sarcoma Study (IESS).

The original “no chemotherapy” arm was quickly dropped because of an excess of deaths. There has thus never been a completed randomized controlled trial (RCT) of chemotherapy versus no chemotherapy in this

condition. However, the consistent historic survival of 5–10% without chemotherapy compared to at least 45–50% makes it unnecessary to demand an RCT.

IESS-1 was a pioneering study undertaken between 1973 and 1978. It is not surprising therefore when the late results were reported in 1990 that they discovered that some of the important prognostic factors were imbalanced between the randomized groups. Nevertheless, for 342 eligible patients to be entered into a study of a very rare tumor was a triumph in itself. It was quite clear from the results that doxorubicin was an essential drug but lung irradiation was almost as good. Almost 30 years after the initiation of this study the basic design of treatment is similar. Ifosfamide has now replaced cyclophosphamide in most treatment schedules but otherwise we have advanced very little with survival rates, now perhaps only 10% higher than they were for patients presenting in 1975. The second IESS study, which ran from 1978 to 1982, compared a pulsed, more intensive, regimen than that used in IESS-1. A significant improvement was found for the intensive treatment (Study 2).

Until 1980 there was little coordinated clinical trial activity in Europe. As far as Ewing's sarcoma is concerned, the United Kingdom Children's Cancer Study Group (UKCCSG), the German Cooperative Ewing Sarcoma Study (CESS), the French Paediatric Oncology Group (SFOP) and the Rizzoli Institute in Bologna all developed separate protocols and studies with the aim of improving survival but none had sufficient patients to be able to mount a RCT. However, the CESS group did study the effect of hyperfractionated irradiation and found no difference when compared to its conventional delivery (Study 3).

A most important contribution came from Sara Donaldson and her Pediatric Oncology Group colleagues, who showed that the previously perceived



wisdom that successful treatment of the primary tumor required irradiation to the whole bone was in fact wrong and standard treatment now is for the field to include only the tumor and a surrounding safe margin but sparing the epiphysis at the growing end of the bone wherever possible. Although survival was not influenced by this trial, the late morbidity on the bone certainly has been (Study 4). The third IESS study has now been fully reported (Studies 5, 8 and 9), it shows a survival benefit for the addition of ifosfamide and etoposide to standard therapy but only for patients non-metastatic at diagnosis.

In 1990 the Europeans belatedly woke up to the need to cooperate outside of their traditional boundaries. The UKCCSG/MRC and CESS formed the European Intergroup Collaborative Ewing's Sarcoma Study Group (EICESS). At last they had sufficient patients to ask a randomized question. They set up two parallel studies, one for high risk (tumors >200 ml in original volume) and the other for standard risk. The question for standard risk was a toxicity one: could the toxicity be reduced by substituting cyclophosphamide for ifosfamide in the later part of treatment. For high risk it was a dose intensity question: would the addition of a fifth drug, etoposide, improve survival? In spite of running for almost 8 years, only the high risk arm accrued sufficient patients to answer the question posed. Early results suggest that the addition of etoposide slightly improves survival, although the differences are not significant and the median follow up is still too short to make definitive statements.

The success of the EICESS-92 study in terms of patient accrual has prompted several other major trial groups to join with EICESS for the next EUROEWING's study. SFOP, Swiss Institute for Applied Cancer Research (SIAC) and European Organization for Research and Treatment of Cancer (EORTC) are all entering patients into the latest study. In EICESS-92 stratification into standard and high risk was on the basis of tumor volume. For EUROEWING's, some 8 years later, it is now known that the response of the primary tumor to initial chemotherapy is a much more powerful prognostic factor. The latest trial is investigating the role of high

dose chemotherapy and autologous stem cell rescue for tumors that do not respond well to initial very intensive chemotherapy. For those who do have a good response a toxicity question is again being asked, similar to that in EICESS-92.

In the United States the Children's Cancer Group (CCG)-7942 study opened for patient accrual in 1995. This is an RCT comparing a 5-day regimen given over 48 weeks to an intensified treatment using the same drugs over a 30-week period. Results are awaited.

There is general agreement that we are reaching the limit of improvements that we might expect from existing therapy. There may be a place in the future for RCTs to refine existing treatments, for example, timing of surgery, amount and timing of chemotherapy or different methods of delivery of radiotherapy. Although whole lung radiation was studied in the first IESS study its role is not clear with modern intensive chemotherapy. There is now almost universal consensus that ifosfamide is the alkylating agent of choice but there has never been an RCT of maximally tolerated doses of cyclophosphamide and ifosfamide.

The past 10 years have seen a huge increase in our knowledge about the basic biology of Ewing's tumor. Virtually all carry an 11:22 chromosomal translocation and we know that there are several different genes and their products involved. EWS:Flt1 is the commonest gene rearrangement but there are several others. Work is continuing to elucidate how these very specific gene rearrangements contribute to the production of an Ewing's sarcoma. Prospects for the future include the identification of tumor-specific targets and then the design of highly specific drugs to interact with these sites. There is also considerable work on the immunology of this tumor and in the future immunotherapy may well have a role to play.

RCTs have allowed us to reach the position where 65–70% of Ewing's tumors can now be cured. Further improvements will either be in very small incremental steps or a bigger jump if a highly specific therapy is identified. Whichever is the case, any RCT in this tumor in the future is going to have to be very large and certainly multinational.

# Studies

## Study 1

Nesbit Jr ME, Gehan EA, Bergert Jr EO, Vietti TJ, Cangir A, Tefft M, Evans R, Thomas P, Askin FB, Kissane JM, Pritchard DJ, Herrmann J, Neff J, Makley JT, Gilula L. Multimodal therapy for the management of primary, nonmetastatic Ewing's sarcoma of bone. A long-term follow-up of the First Intergroup Study. *J Clin Oncol* 1990;8:1664-74.

The study was carried out between 1973 and 1978 by the Intergroup Ewing's Sarcoma Study collaboration between the American cancer study groups CCG, SWOG and CLGB.

### Objectives

The aim of the study was:

- To determine the value of VAC chemotherapy as post-surgical adjuvant therapy.
- To determine the role of lung irradiation to prevent lung metastases.

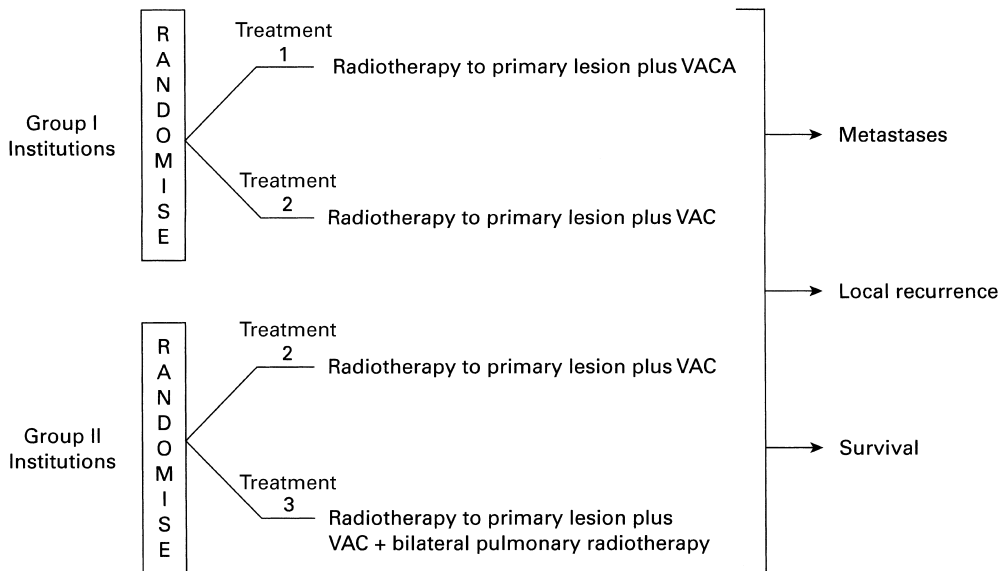
## Details of the study

The eligibility criterion was localized, previously untreated Ewing's sarcoma, with no age limit. Patients who had initial amputation of the primary lesion were ineligible for randomization.

Centers were to initially choose between one of two concurrent randomized studies, the randomization was a three-to-two balance between treatments 1 and 2 and treatments 2 and 3 (see below). No details of randomization method or location are given. No detailed statistical predictions with regard to differences sought or numbers of patients required are given. Full details of statistical analytical methods are given.

Study 1 was a comparison of VAC (vincristine, actinomycin D and cyclophosphamide) chemotherapy versus no adjuvant chemotherapy. However, after a 7-month recruitment, two of the three patients who were randomized to receive no chemotherapy had relapsed and the study was therefore closed. The design was modified to be a comparison of VAC versus VAC plus doxorubicin (Adriamycin) (VACA).

Study 2 was a randomized comparison of VAC versus VAC plus bilateral lung irradiation (see Figure 3.1).



**Figure 3.1** Randomization for institutions in Groups I and II. © American Society of Clinical Oncology (full reference above).

Bilateral lung irradiation consisted of a midplane dose of between 15 and 18 Gy through the anteroposterior and posteroanterior ports immediately following local therapy for the primary tumor. Five fractions were delivered each week, 1.5–2 Gy daily dose.

After 3 years, entry of patients into treatment 2 was closed because of a significantly high early relapse rate compared with other treatments, and randomization continued between treatments 1 and 3, i.e. VACA versus VAC plus lung radiotherapy. Local irradiation to the primary site was given during weeks 1–6 concurrently, with weekly vincristine 1.5 mg/m<sup>2</sup> and cyclophosphamide 500 mg/m<sup>2</sup>. Lung irradiation was given during weeks 4–6. This was followed by a 7-week block, comprising actinomycin 15 µg/kg IV on 5 consecutive days during week 1, followed by vincristine and cyclophosphamide weekly for 5 weeks. Doxorubicin, where used, was given during week 7 at a dose of 60 mg/m<sup>2</sup>.

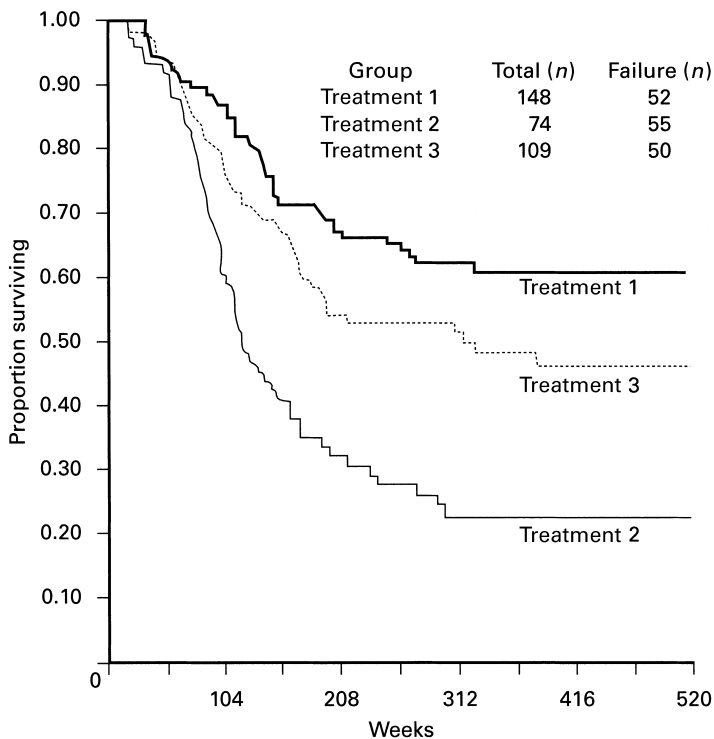
Primary outcome measures were survival and time to relapse. All pathology was centrally reviewed, as were the chemotherapy details and both initial imaging and radiotherapy planning films.

Of the 372 patients entered, 342 were eligible. Eighteen were excluded due to metastatic disease, eight had wrong diagnosis and four had an unconfirmed diagnosis; 148 received treatment 1, VACA; 74 treatment 2, VAC and 109 treatment 3, VAC plus lung irradiation. Four patients were subsequently excluded from the analysis because of major violations.

### Outcome

Despite randomization there was some imbalance between groups. More had an initial surgical complete remission (CR) in treatment 1 than treatment 2. There were more girls and initial surgical CR in treatment 3, than treatment 2. Five-year relapse-free survival (RFS) was 60% for those receiving VACA, compared to 24% for those receiving VAC ( $p < 0.01$ ) for the randomized study, and ( $p < 0.001$ ) when all patients receiving these two regimens are considered (Figure 3.1). Five-year survival was 60% versus 28% ( $p < 0.02$ ) for the randomized group (Figure 3.2).

Treatment 3, VAC plus lung irradiation, was superior to treatment 2, VAC alone, both with respect to



**Figure 3.2** Survival curves for eligible patients by treatment. © American Society of Clinical Oncology (full reference on p. 51).

RFS and overall survival. Five-year RFS was 44% and overall survival 53%. For the comparison of treatment 3, VAC plus radiotherapy, versus treatment 1, VACA, the patients receiving VACA had a superior outcome, 60% versus 44% 5-year RFS, although this did not quite reach statistical significance ( $p=0.06$  for the randomized group). For all eligible patients  $p=0.001$ .

The above differences were not apparent when patients with pelvic primaries alone were considered. This was claimed to be due to an underestimate of the soft tissue extension taken into account for local radiotherapy planning. Fifty-one percent of those that relapsed had lung secondaries. The incidence of lung metastases was 20% in treatment 2, versus 15% in treatment 3, i.e. no significant difference.

### Toxicity

Details of toxicity were somewhat limited, but severe toxicity was reported to have occurred in 70%, 57%

and 61% of treatment 1, 2 and 3, respectively and severe leucopenia in 21%, 4% and 11%, respectively. There was one severe cardiac toxicity in treatment 1.

### Conclusion

It was concluded that VACA was superior to VAC and that lung irradiation was equivalent to adding doxorubicin to VAC.

An initial analysis was published by Nesbit Jr ME, Perez CA, Tefft M, Burgert Jr EO, Vinetti TJ, Kissane J, Pritchard DJ, Gehan EA. Multimodal therapy for the management of primary, nonmetastatic Ewing's sarcoma of bone: an Intergroup Study. *Natl Cancer Inst Monogr* 1981;56:255–62.

## Study 2

Bergert EO, Nesbit ME, Garnsey LA, Gehan EA, Herrmann J, Vietti TJ, Cangir A, Tefft M, Evans R, Thomas P, Askin FB, Kissane JM, Pritchard DJ, Neff J, Makley JT, Gilula L. Multimodal therapy for the management of nonpelvic, localized Ewing's sarcoma of bone: Intergroup Study IESS-II. *J Clin Oncol* 1990; 8:1514–24.

This study was carried out between 1978 and 1982 by the Intergroup Ewing's Sarcoma Study (IESS) and included 64 institutions.

### Objectives

The aim of this trial was:

- To compare two chemotherapy regimens that differed in drug schedule and route of administration.

### Details of the study

Patient eligibility included those with non-pelvic primaries and only bone involvement. They were to have had no previous treatment and be less than 1 month from initial diagnosis. Excluding features were node positivity, pleural or ascitic fluid, CSF positivity, soft tissue involvement only or distant metastases.

No details of randomization method or location are given. Patients were stratified by site, sex and initial

surgery. It was projected that 80 patients per randomized group would be required to detect a 15% increase in disease-free survival at 2 years at 5% significance and 80% power.

All clinical data were centrally reviewed, 72% were fully assessable, 10% were non-assessable on review. All patients were included for analysis. Local radiotherapy at 55 Gy was given unless there was an initial surgical complete remission (CR) (15% of cases).

Treatment 1 included vincristine and doxorubicin (Adriamycin), alternating with vincristine and cyclophosphamide (see Figure 3.3). This was given 3 weekly for a total of 12 courses. The doxorubicin dose was 75 mg/m<sup>2</sup> and cyclophosphamide 1.4 gm/m<sup>2</sup>. This was then followed by seven courses of low dose continuing chemotherapy. Treatment 2 comprised weekly vincristine and cyclophosphamide for a total of six courses, followed by lower dose therapy adapted from IESS-I.

Outcome measures were survival and time to relapse.

### Outcome

Following initial surgery 15 patients had a complete response, 16 a partial response and 50 had a biopsy only. Twelve percent had initial amputation. A total of

**Treatment 1** (Total 78 weeks)

Schedule A:	Radiation		
	V	V	(Repeat A × 6 then B)
	A	C	
Week:	0	3	6
Schedule B:	V	V	(Repeat 6 weeks × 7)
	D × 5 days		C
Week:	36	39	
Doses:	Vincristine (V) = 1.5 mg/m <sup>2</sup> (max. = 2 mg)		
	Doxorubicin (A) = 75 mg/m <sup>2</sup>		
	Cyclophosphamide (C) = 1400 mg/m <sup>2</sup>		
	Actinomycin D (D) = 0.45 μg/m <sup>2</sup> (max. = 0.5 mg)		
	Radiation = 45 Gy to whole bone and shrinking field to 55 Gy		

**Treatment 2** (Total 76 weeks)

Schedule C:	Radiation						
	V	V	V	V	V	V	(6 weeks C only then to D)
	C	C	C	C	C	C	
Week:	0	1	2	3	4	5	6
Schedule D:	V		V	V	V	V	(Repeat D every 10 weeks × 7)
	D × 5 days		C	C	C	C	C
							A
Week:	9		11	12	13	14	15
Doses:	Vincristine (V) = 1.5 mg/m <sup>2</sup> (max. = 2 mg)						
	Cyclophosphamide (C) = 500 mg/m <sup>2</sup>						
	Doxorubicin (A) = 60 mg/m <sup>2</sup>						
	Actinomycin D (D) = 0.45 μg/m <sup>2</sup> (max. = 0.5 mg)						
	Radiation = 45 Gy to whole bone and shrinking field to 55 Gy						

**Figure 3.3** Details of radiotherapy and chemotherapy schedules. © American Society of Clinical Oncology (full reference on p. 53).

234 patients were entered into the study, of whom 214 were eligible. Twenty were excluded, there were no data in 10, secondaries in 5, a wrong diagnosis in 4 and 1 refused treatment. One hundred and eight patients were randomized on to treatment 1 and 106 on treatment 2.

Five-year event-free survival was 73% and 56%, respectively for treatments 1 and 2 ( $p < 0.03$ ). Five year overall survival was 77% versus 63% ( $p < 0.05$ ) (Figure 3.4). A similar number achieved a complete response (84% versus 78%), local relapses occurred in 7% versus 10% and lung relapses in 11% versus 22% for treatments 1 and 2, respectively.

### Toxicity

There were three cardiac toxic deaths, all on treatment 1, but overall severe toxicity was comparable (68% and 67%, respectively). The only significant difference was

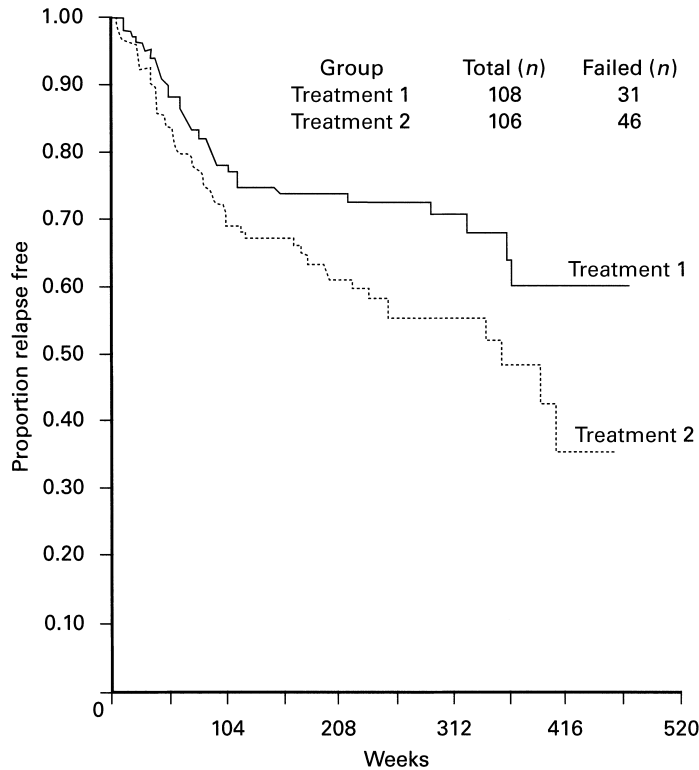
in significant cardiac toxicity (8% versus 2%,  $p < 0.03$ ), being higher in treatment 1.

### Conclusion

It was concluded that the pulsed intensive regimen that contained early doxorubicin was superior to the lower dose regimen used in the prior IESS-I study.

### Comments

It is of note, that the 5-year relapse-free survival for the non-pelvic tumors on IESS-I was 70%. The figure quoted of 57% for non-pelvic patients in IESS-I was the overall survival for all three-study groups, not those on the VACA regimen. It appears, therefore, that the outcome in the control, i.e. less intensive, arm was poorer in this comparative study than in the previous trial. Reasons for this are unclear.



**Figure 3.4** Relapse free survival by treatment group. © American Society of Clinical Oncology (full reference on p. 53).

### Study 3

Dunst J, Jurgens H, Sauer R, Pape H, Paulussen M, Winkelmann W, Rube C. Radiation therapy in Ewing's sarcoma: an update of the CESS-86 trial. *Int J Rad Oncol Biol Phys* 1995;32:919–30.

This study was carried out between 1986 and 1991 by the German CESS group, involving collaboration between 60 centers.

#### Objectives

The study addressed the issue of:

- Whether fractionated radiotherapy achieved comparable or better local control than conventional fractionation.

#### Details of the study

Eligibility criteria comprised Ewing's tumor of bone, including bone primitive neuroectodermal tumor

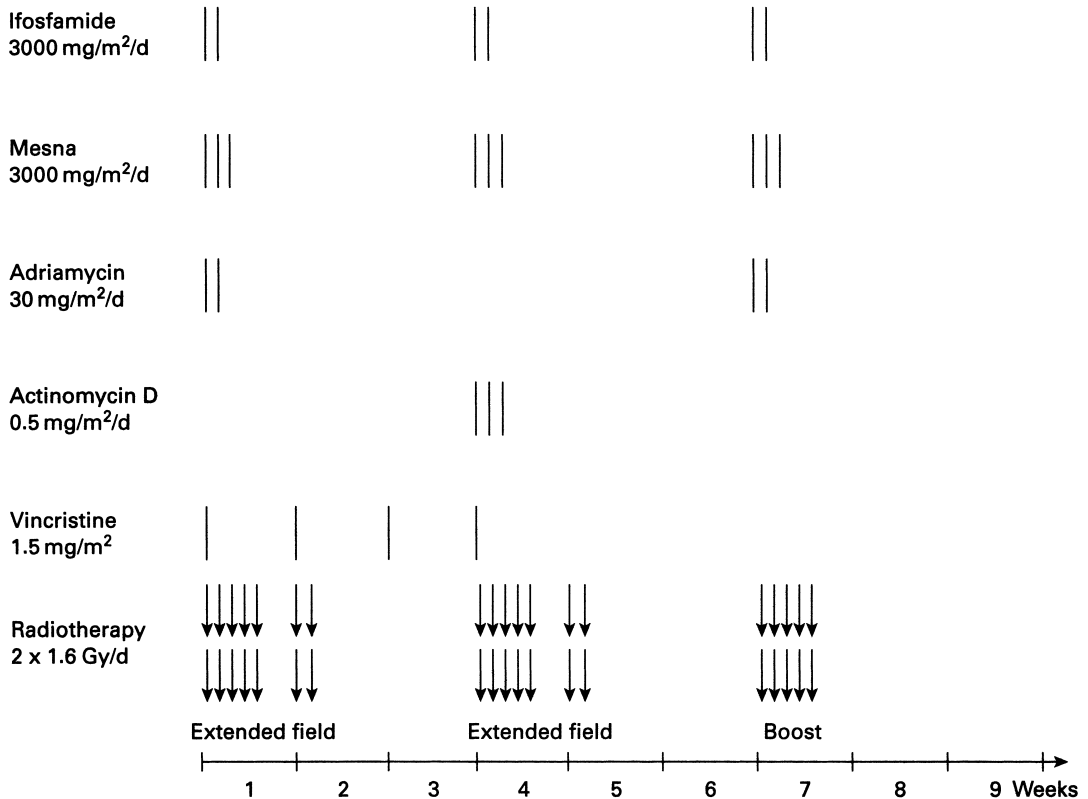
(PNET); patients were under the age of 25, with localized tumors, who commenced treatment 4 weeks or less from the time of diagnosis.

No details are given regarding the randomization method or where this was done. No statistical predictions are given with regard to differences sought or numbers required.

The study involved initial stratification of patients on the basis of tumor volume, those with volume  $<100\text{ cm}^3$  receiving VACA (vincristine/actinomycin D/cyclophosphamide/doxorubicin), whereas those  $>100\text{ cm}^3$  received VAIA (vincristine/actinomycin/ifosfamide/doxorubicin).

Surgery was performed, if possible, at around week 10 from diagnosis. If not possible, patients were randomized to either receive conventional radiotherapy or hyperfractionated split-course irradiation simultaneous with continued chemotherapy.

The radiotherapy target volume included the pre-treatment tumor volume, with a safety margin of at least



**Figure 3.5** Hyperfractionation split-course irradiation with simultaneous VAIA (or VACA, not shown) chemotherapy. Reprinted from Dunst J *et al.*, *Int J Rad Oncol Biol Phys* (full reference on p. 55) with permission from Elsevier.

2 cm in lateral width and depth and at least 5 cm in the proximal and distal extension in extremity tumors. In the case of non-infiltrating extension of tumors in preformed cavities, e.g. pelvis or thorax, the target volume included only the actual tumor volume after chemotherapy with a 1–2 cm safety margin. The target area received a dose of up to 45 Gy and patients who received definitive radiotherapy, that is, as the only locally directed therapy, were given up to 60 Gy to the actual tumor volume with a 1–2 cm safety margin. Radioplanning programs were centrally reviewed as part of the protocol.

Conventional irradiation was given in daily fractions of 1.8–2 Gy five times per week, with no simultaneous chemotherapy. Hyperfractionated split-course irradiation was given at a dose of 1.6 Gy twice a day in two separate courses, each totaling 22.4 Gy. In the case of definitive radiotherapy without surgery a further boost of 16 Gy was given (see Figure 3.5).

Study outcome measures were RFS, local control and overall survival. It was also planned to determine if it was feasible to give split dose radiotherapy with concomitant chemotherapy.

### Outcome

One hundred and seventy-seven patients were registered: 111 Ewing's sarcoma, 34 bone PNET (neurone specific enolase positive) and 32 non-specified tumors.

A total of 123 patients appear to have been randomized. The reasons for non-randomization are not given in detail. The overall 5-year survival of the whole group of patients registered was 69% and the frequency of relapse was not influenced by the type of local treatment. Relapse rate was 30% after definitive radiotherapy, 26% after radical surgery and 34% after combined local treatment. After definitive irradiation 14% local failures occurred, either isolated or combined. The frequency of distant metastases was higher after surgery

(26%) and resection plus radiotherapy (29%) as compared to definitive radiotherapy (16%). No statistical analysis is given.

The type of fractionation appeared to have no impact on local tumor control. When the randomized patients alone are considered, 43 received definitive radiotherapy—21 conventional, 22 hyperfractionated—with a RFS rate of 53% and 58%, respectively. Local control rates were 82% versus 86%, respectively. Of the 80 patients receiving post-operative radiotherapy, 40 received conventional and 40 received hyperfractionated. RFS in the two groups was 58% and 64%, respectively.

## Toxicity

Toxicity did not appear to be influenced by fractionation. There were two patients who developed significant proctitis, although the radiation schedule is not detailed.

## Conclusion

It was concluded that no benefit was achieved with hyperfractionated radiotherapy.

## Study 4

Donaldson SS, Torrey M, Link MP, Glicksman A, Gilula L, Laurie F, Manning J, Neff J, Reinus W, Thompson E, Shuster JJ. A multidisciplinary study investigating radiotherapy in Ewing's sarcoma: end results of POG #8346. *Int J Rad Oncol Biol Phys* 1998; **42**:125–35.

This study was carried out by the Pediatric Oncology Group between 1983 and 1988.

### Objectives

The aims of the study was:

- To determine whether involved field irradiation was equivalent to standard whole bone irradiation in achieving local control.

### Details of the study

Eligible patients were less than 30 years of age with bone Ewing's sarcoma. Extrasosseous Ewing's and primitive neuroectodermal tumor were excluded and no prior treatment was allowed.

The randomization method is not detailed, nor where this was done. Although analytical statistics are described, no anticipated patient number or predicted differences in outcome are detailed.

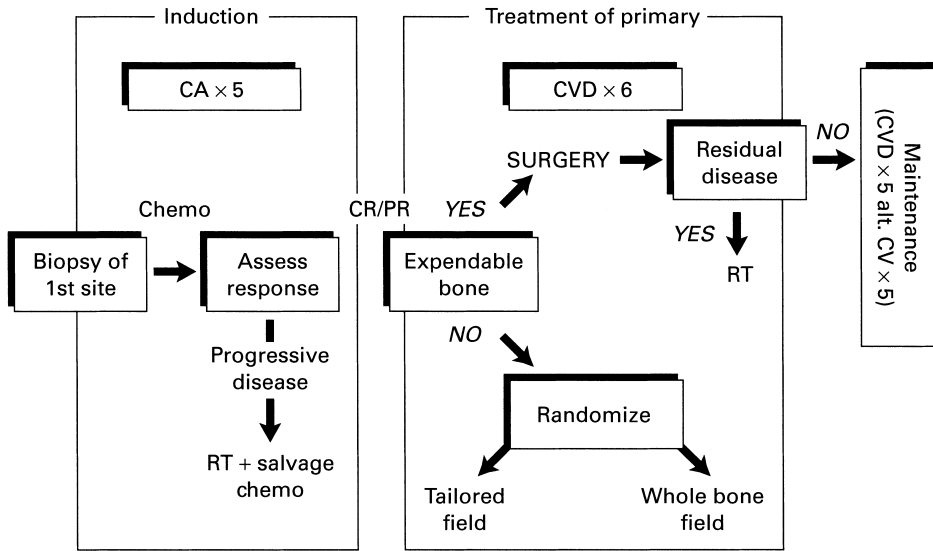
The protocol is as in Figure 3.6. All patients initially received a combination of cyclophosphamide 150 mg/m<sup>2</sup> orally for 7 days, combined with doxorubicin (Adriamycin) 35 mg/m<sup>2</sup>, both drugs given every

14 days for a total of five courses (CA × 5). Cyclophosphamide, vincristine and actinomycin (CVD) were then given for six courses. This was followed by local radiotherapy, in the case of expendable bone, such as proximal fibula, distal four-fifths of the clavicle, body of scapula, iliac wing and ribs. Patients who underwent surgery and were left with microscopic or gross residual disease were given post-operative radiotherapy and were eligible for randomization. Patients in whom surgery was not appropriate received either tailored field or whole field radiotherapy. This was given concomitantly with maintenance chemotherapy, which comprised cyclophosphamide 150 mg/m<sup>2</sup> combined with alternating doxorubicin 35 mg/m<sup>2</sup> and actinomycin D 1.5 mg/m<sup>2</sup>. Chemotherapy was given for a total of 12 months.

Radiotherapy guidelines required a radiation course of 55.8 Gy given in 1.8 Gy daily fractions. Large irradiation fields, i.e. pelvic fields, could be delivered at 1.5 Gy daily fractions at the discretion of the radiation oncologist. Standard radiation treatment was defined as radiation to the whole bone, including the tumor, to a dose of 39.6 Gy followed by a boost to 55.8 Gy to the initial tumor plus a 2 cm margin. The tailored involved field (IF) was the same as the field that was boosted in standard radiation, also to a total dose of 55.8 Gy. Patients who had involvement of a small bone, such as a vertebral body, where there would have been no difference between boost volume and whole bone volume, were not randomized but assigned to involved field radiation.

In 1986 randomization was discontinued owing to low recruitment. This was apparently due to a high





**Figure 3.6** Protocol study design. Reprinted from Donaldson SS *et al.*, *Int J Rad Oncol Biol Phys* (full reference on p. 57) with permission from Elsevier.

number of patients with secondaries or initial complete resection, and subsequently all patients received involved field radiotherapy.

Outcome measures included local control, event-free survival (EFS) and overall survival.

### Outcome

One hundred and eighty-four patients were enrolled, of whom 178 were eligible. Six were excluded due to unconfirmed pathology. Primary sites comprised proximal extremity 30%, distal extremity 25%, pelvis 24% and other 21%.

All pathology was centrally reviewed, as were radiation planning fields. A major deviation in volume was defined as a field that missed a portion of the tumor, while a mild deviation was a field with less than a 2 cm margin. Major dose deviation was  $>10\%$  variation, and a 6–10% deviation was considered as mild. The influence of radiation deviations was analyzed, although the percentage with minor or major deviations was not specified. Patients with major deviation, in either volume or dose, had a 5-year local control of only 16%, those with minor deviation 48%, while those treated appropriately had a 5-year local control rate of 80%. Of 141 patients with localized disease, 104 non-surgical patients were eligible for randomization or assigned to receive radiotherapy as local treatment.

Five-year survival and EFS for this group was 52% and 41%, respectively. Ninety-four patients actually received radiotherapy, the others are lost to follow-up, refused radiotherapy or had progressive disease. Forty patients were ultimately randomized to receive either standard field (SF), i.e. whole bone, or involved field (IF) radiotherapy, with 20 in each group. The remaining patients were electively given involved field radiotherapy but these included 11 in whom the standard and involved fields would have been equivalent and who were therefore not eligible for randomization (Figure 3.7).

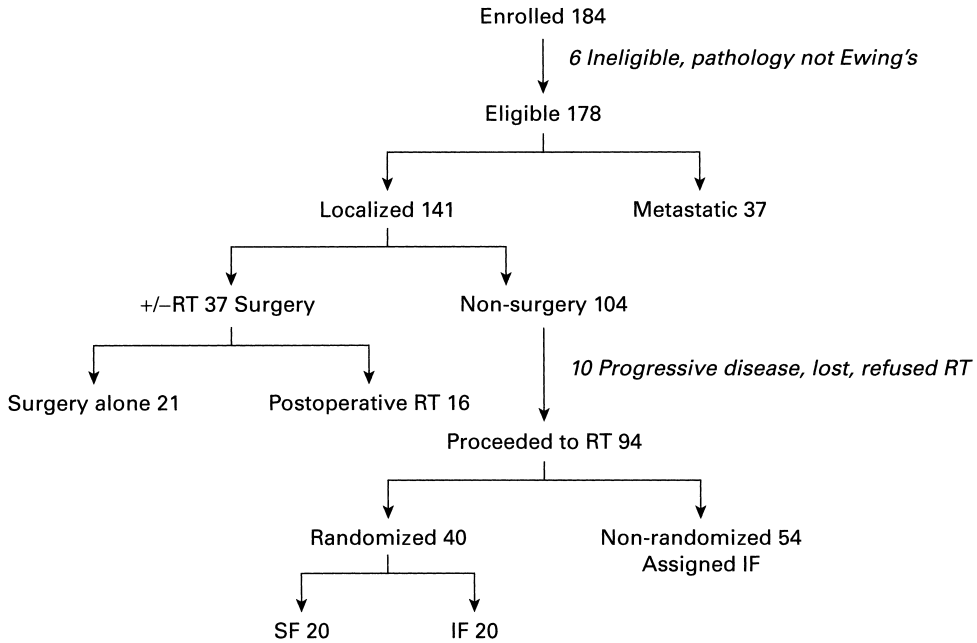
Patients randomized to standard field had a 5-year local control rate of  $53 \pm 15\%$  compared to  $53 \pm 14\%$  for those receiving involved field treatment. Overall 5-year EFS in randomized patients was 37% for whole bone, versus 39% for involved field.

### Toxicity

No difference was documented in acute toxicity and follow-up was too short to document any difference in late effects.

### Conclusion

Involved field irradiation is equivalent to whole bone treatment in localised Ewing's sarcoma.



**Figure 3.7** Flow chart showing patient distribution for all patients by extent of disease and treatment. Reprinted from Donaldson SS *et al.*, *Int J Rad Oncol Biol Phys* (full reference on p. 57) with permission from Elsevier.

## Study 5

Shamberger RC, LaQuaglia MP, Krailo MD, Miser JS, Pritchard DJ, Gebhardt MC, Healey JH, Tarbell NJ, Fryer CJH, Meyers PA, Grier HC. Ewing sarcoma of the rib: results of an Intergroup study with analysis of outcome by timing of resection. *J Thorac Cardiovasc Surg* 2000;**119**:1154–61.

This study was carried out by the Pediatric Oncology Group, CCG Intergroup between 1988 and 1992.

### Objectives

The aims of the study was:

- To address the value of intensified chemotherapy adding ifosfamide/etoposide to vincristine/doxorubicin/cyclophosphamide and actinomycin D (VACA).
- To mainly address the issue of surgical timing by considering only a subgroup within this large trial, namely those with rib primaries.

### Details of study

Patient eligibility for the Intergroup study comprised those under 30 years of age with Ewing's sarcoma, PNET or primitive sarcoma of bone and in whom treatment commenced less than 1 month from diagnosis.

Site of randomization or randomization details are not given. Patients were stratified by the presence of metastases. No predicted numbers or anticipated differences in the two chemotherapy groups are described.

Patients were randomized at study entry to receive standard chemotherapy with VACA or to receive experimental therapy consisting of these four drugs alternating with courses of ifosfamide and etoposide. Sizes of doses and schedules are not given in this publication, although the treatment was carried out around week 12.

For patients receiving radiotherapy alone, the initial treatment volume plus a 3 cm margin was treated with 45 Gy. This was followed by a reduction in treatment volume to the post-chemotherapy, pre-radiotherapy extent of tumor for an additional 10.8 Gy, resulting in a total dose of 55.8 Gy. Patients with residual tumor after

surgery were irradiated, using the same dose volume guidelines in the case of gross residual disease, or 45 Gy with a 1 cm margin for microscopic residual disease.

The outcome measure of the study was event-free survival (EFS).

### Conclusion

Three hundred and ninety-three patients were entered in the overall study, with an EFS of 61%. Patients receiving VACA alone had a 54% 5-year EFS. The addition of etoposide/ifosfamide produced a 5-year EFS of

68%, hazard ratio 0.61,  $p < 0.002$ . In the patients in this study with rib primaries alone the EFS was 64% versus 51%, hazard ratio 0.6, although not statistically significant. No details of toxicity in the chemotherapy arms were given.

### Note

The authors were more concerned with describing the timing of local surgery than the chemotherapy question and no specific analysis of the randomized group was presented. The full Intergroup study results have only been published in abstract form.

## Study 6

Marina N, Pappo A, Parham D, Cain A, Rao B, Poquette C, Pratt C, Greenwald C, Meyer W. Chemotherapy dose-intensification for paediatric patients with Ewing's family of tumours and desmoplastic small round-cell tumours: a feasibility study at St. Jude children's Research Hospital. *J Clin Oncol* 1999;17:180–90.

This study was carried out between 1992 and 1996 at St. Jude Children's Research Hospital, Memphis.

### Objectives

The aims of the study was:

- To evaluate the feasibility of dose intensification during post-operative chemotherapy with randomization between two doses of cyclophosphamide.

### Eligibility

Patients under the age of 25 years with ECOG performance status 0–1, no marrow metastases with desmoplastic small round cell tumors (DSRG) and primitive neuroectodermal tumor (PNET). Included bone and soft tissue Ewing's Sarcoma. Initial staging comprised CT or MRI of primary, bone scan and CT chest.

There was institutional review of all pathology.

Method and site of randomization are not described.

The primary end point of the study was to estimate the proportion of patients receiving the planned induction within 8 weeks and to compare the percentage of

patients in the two maintenance arms receiving therapy without significant dose reductions.

The first phase of the trial was planned to stop after recruitment of 24 patients if less than 65% completed therapy within the 8-week period. For the second phase, success of maintenance therapy was defined as completion and recovery from maintenance by 28 weeks without reducing the planned dose by more than 50%. The study had a 85% power of detecting a difference of 35% versus 75% success rates for the high and standard dose for cyclophosphamide arms.

Planned number of patients for the second phase is not described.

### Study design

Patients received standard induction chemotherapy with ifosfamide and etoposide, cyclophosphamide and doxorubicin (see Figure 3.8). Local control from week 9 consisted of surgical resection and radiation therapy depending on tumor size and response (see Table 3.1). Following this, patients were randomized to receive cyclophosphamide at 1 g/m<sup>2</sup> versus 1.5 g/m<sup>2</sup> combined with doxorubicin and alternated with ifosfamide and etoposide (see Figure 3.8). Treatment lasted 41 weeks.

### Outcome

Fifty-four patients were entered, one was not randomized. The two with DSRCT were excluded in the outcome analysis. There was a good balance of risk factors including tumor size, presence of secondaries, patient age and bone versus soft tissue disease. Of 53 patients

## Treatment schema

iii c eee a	iii c eee a	iii c eee a	SR RAD	V Dac	V Dac	V Dac	V Dac	V Dac	I E	C A
0	3	6	9	11			15	17	20	23
I E	C A	I E	C A	I E	C A					
26	29	32	35	38	41			44		

**Induction (weeks 0–8)**

I = Ifosfamide 2 g/m<sup>2</sup>/d × 3  
 e = etoposide 150 mg/m<sup>2</sup>/d × 3  
 c = cyclophosphamide 1.5 g/m<sup>2</sup>/d/5  
 a = doxorubicin 45 mg/m<sup>2</sup>/d/5

**Local control (weeks 9–17)**

SR = surgical resection  
 V = vincristine 1.5 mg/m<sup>2</sup>  
 Dac = dactinomycin 1.5 mg/m<sup>2</sup>  
 RAD = start radiotherapy

**Maintenance (weeks 20–44)**

I = Ifosfamide 2 g/m<sup>2</sup>/d × 5  
 E = etoposide 150 mg/m<sup>2</sup>/d × 5  
 C = cyclophosphamide 1.0 OR 1.5 g/m<sup>2</sup>/d × 2  
 A = doxorubicin 60 mg/m<sup>2</sup> continuous infusion over 24 hours

**Figure 3.8** Chemotherapy schedule for patients with EFT. © American Society of Clinical Oncology (full reference on p. 60).

**Table 3.1** Radiation doses (Gy) for Ewing's patients with bone and soft tissue primary tumors.

Tumor Size	Bone Primary			Soft Tissue Primary		
	Complete Resection	GTR	Number of Resection	Complete Resection	GTR	Number of Resection
≤8 cm						
≥PR	Number of radiation	36	36	36	36	36
<PR	Number of radiation	60 HF	68.4 HF	36	60 HF	68.4 HF
>8 cm						
≥PR	Number of radiation	36	68.4 HF	36	36	68.4 HF
<PR	Number of radiation	60 HF	68.4 HF	36	60 HF	68.4 HF

PR: partial response; GTR: Gross total resection (defined as complete resection with positive margins) and HF: hyperfractionated radiotherapy at 1.2Gy/fraction twice daily.

19 had secondaries at presentation. The median age was 13 years, range 4–25 years; 26 were bony primaries; 25 were randomized to high dose and 28% to standard dose.

**Result**

Induction chemotherapy was well tolerated, 50 of 51 PNET received treatment on time. For the second phase, 71% of standard dose versus 60% of high dose completed full dose regimen on time. Toxicities were significant but not related to the dose of cyclophosphamide.

Four patients died before developing disease progression and three initial patients developed secondary myeloid malignancies. There was no difference in event-free survival or overall survival between the two arms of study.

**Conclusion**

The higher dose of cyclophosphamide was feasible but of no benefit.

## Study 7

Miser JS, Krailo MD, Tarbell NJ, Link MP, Fryer CJ, Pritchard DJ, Gebhardt MC, Dickman PS, Perlman EJ, Meyers PA, Donaldson SS, Moore S, Rausen AR, Vietti TJ, Grier HE. Treatment of metastatic Ewing's Sarcoma or primitive neuroectodermal tumour of bone: evaluation of combination ifosfamide and etoposide – a Children's Cancer Group and Paediatric Oncology Group Study. *J Clin Oncol* 2004;22(14):2873–6.

This study was undertaken by the CCG and POG study groups between 1988 and 1992.

### Objectives

This study was designed:

- To determine intensification of a standard vincristine, doxorubicin, cyclophosphamide, actinomycin D regimen by the addition of ifosfamide.
- To determine how etoposide will improve outcome in patients with metastatic Ewing's sarcoma.

### Details of the study

This was a multicenter prospective randomized trial. Eligibility was patients with Ewing's Sarcoma or PNET of bone with metastases at diagnosis. Diagnostic slides were reviewed by one investigator but central review was not required.

Evaluation for metastatic disease included chest X-ray and CT lung, bone scan, bone marrow biopsy and bone marrow aspiration.

Method and site of randomization was not described.

The study was part of a large trial asking the same question in non-metastatic disease and the study was designed to accrue approximately 400 patients with non-metastatic disease. Randomization was stratified according to metastatic diagnosis and those with metastases were analyzed concurrently. The expected difference in event-free survival (EFS) and overall survival in the group with metastatic disease was not mentioned or the power study.

Treatment arms are shown in Figure 3.9.

Therapy for both arms was planned to last 51 days. Local control of the primary and metastatic disease was recommended at week 9. Surgery was used if feasible and radiation therapy was delivered to all sites of the metastatic disease. This was given concurrently with radiation to the primary site. Initial tumor volume received 45 gray with reduced two post-chemotherapy volume to deliver up to 55.8 gray. Radiation was given concurrently with chemotherapy.

### Outcome

One hundred and twenty patients with metastatic disease were entered, 62 assigned to standard and 58 to experimental therapy median age in arms A and B were 13 years and 11 years, respectively, 37% and 20% had lung metastases only, 49% and 64% had multiple metastatic sites. Extremity primary in 38% and 29% and pelvic primary in 34% and 43%, respectively.

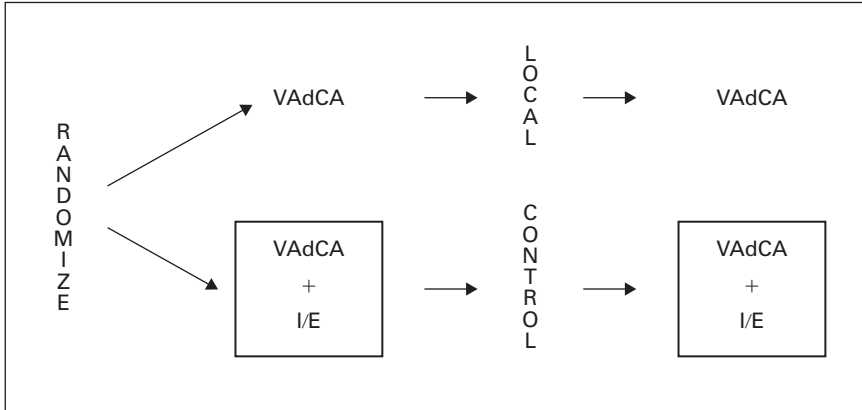
### Toxicity

There were six treatment related deaths, four on regimen B and two on regimen A. Four of the six were due to cardiac toxicity, two were sepsis related. Two patients developed second malignant neoplasm, one chondrocytic osteosarcoma and one acute lymphoblastic leukemia (ALL).

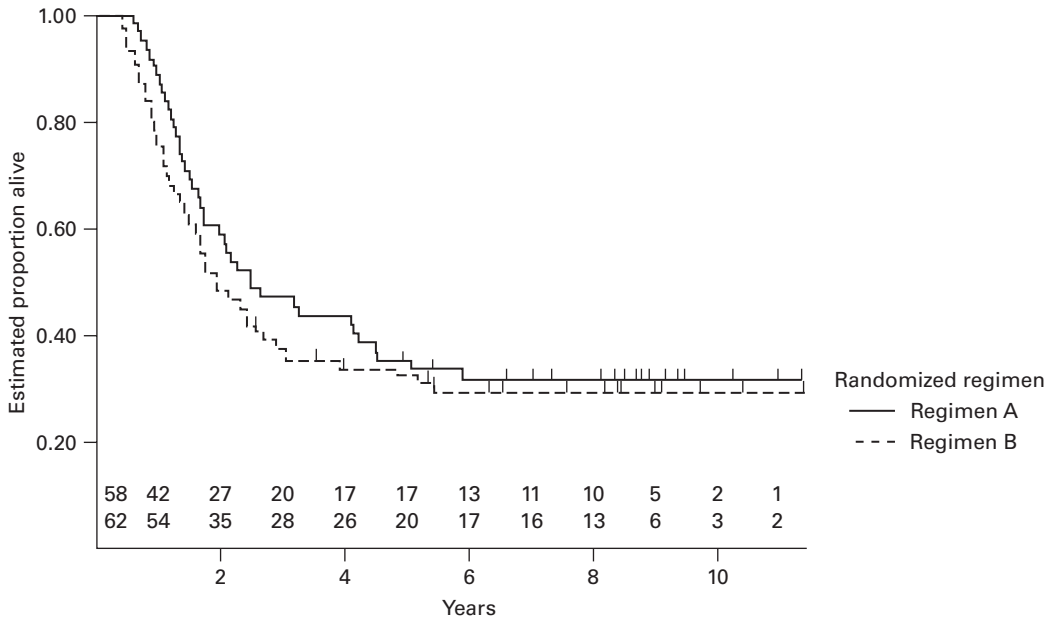
EFS and overall survival are shown in Figure 3.10. EFS was 20% in both arms and overall survival 32% and 29%, respectively for arms A and B, i.e. no significant difference. Patients with initial lung metastases alone had somewhat better outcome overall with 34% event free compared to 17% with metastases at other sites ( $p = 0.06$ ).

### Conclusion

Unlike in the study with non-metastatic disease, intensification with ifosfamide and etoposide had no influence on the poor outcome of those with metastatic disease.



**Figure 3.9** Schema for the randomized trial. VAdCA, vincristine (2 mg/m<sup>2</sup>), doxorubicin (75 mg/m<sup>2</sup>), cyclophosphamide (1200 mg/m<sup>2</sup>) and dactinomycin (1.25 mg/m<sup>2</sup>); I/E, ifosfamide (1800 mg/m<sup>2</sup>/day for 5 days) with etoposide (100 mg/m<sup>2</sup>/day for 5 days). © American Society of Clinical Oncology (full reference on p. 62).



**Figure 3.10** Survival for patients by regimen. Regimen A: standard therapy VAdCA (vincristine, doxorubicin, cyclophosphamide and dactinomycin). Regimen B: experimental therapy (VAdCA + Ifosfamide with etoposide). © American Society of Clinical Oncology (full reference on p. 62).

## Study 8

Grier HE, Krailo MD, Tarvell NJ, Link MP, Fryer CJ, Pritchard DJ, Gebhardt MC, Dickman PS, Perlman EJ, Meyers PAQ, Donaldson SS, Moore S, Raysen AR, Vietti VJ, Misre JS. Addition of ifosfamide and etoposide

to standard chemotherapy for Ewing's sarcoma and primitive neuro ectodermal tumour of bone. *N Eng J Med* 2003;**348**:747–9.

Study carried out between 1988 and 1992 by the American Children's Cancer Group (Study 7881) and Paediatric Oncology Group (Study 8850).

## Objectives

This study aims:

- To determine whether the addition of ifosfamide and etoposide alternating with a conventional vincristine doxorubicin cyclophosphamide regimen would improve survival in localized Ewing's sarcoma.

## Eligibility

Eligibility included age under 30 years. Primary bone tumor – Ewing's Sarcoma, primitive neuroectodermal tumor and primitive sarcoma. Soft tissue Ewings were not included. Patients had to start chemotherapy within 1 month of diagnostic biopsy. There was central review of all pathology.

Method and site of randomization is not stated.

The study planned to initially include both metastatic and non-metastatic patients but because of higher than anticipated recruitment it was changed to address the questions specifically in those without distant metastases at presentation. It was planned to recruit 400 patients which would detect a 50% reduction in failure rate within 3 years of presentation. Power would be 80% significance  $p = 0.05$ . The anticipated event-free survival was not stated.

## Study design

Patients were randomized at entry to receive standard VAC with or without alternating ifosfamide and etoposide (see Table 3.2). A total of 17 courses were given with local therapy at week 12 which was dependent on nature of surgery and completeness of resection. Radiation was not given to those with complete resection and was independent of histological response.

## Outcome

Five hundred patients were enrolled. Five had primitive sarcoma, the other had Ewing's tumor or PNET. Nine were excluded because of wrong pathological diagnosis central review and three excluded due to delayed commencement of chemotherapy. One hundred and

**Table 3.2** Treatment details.

---

Vincristine 2 mg/m <sup>2</sup>
Doxorubicin 75 mg/m <sup>2</sup>
Cyclophosphamide 1200 mg/m <sup>2</sup>
(Actinomycin D replaced doxorubicin once dose reached 375 mg/m <sup>2</sup> )
± Ifosfamide 1800 mg/m <sup>2</sup> daily × 5
Etoposide 100 mg/m <sup>2</sup> daily × 5
• Every 3 weeks for 17 courses
• Local therapy at week 12
Radiation alone 45 Gy to initial volume + 10.8 Gy boost to post-chemotherapy volume
Residual tumor after surgery 45 Gy
Complete resection – no radiation

---

twenty had initial metastases. Of the remaining 398 patients, 200 were randomized to standard therapy and 198 to the intensified fosfamide and etoposide arm.

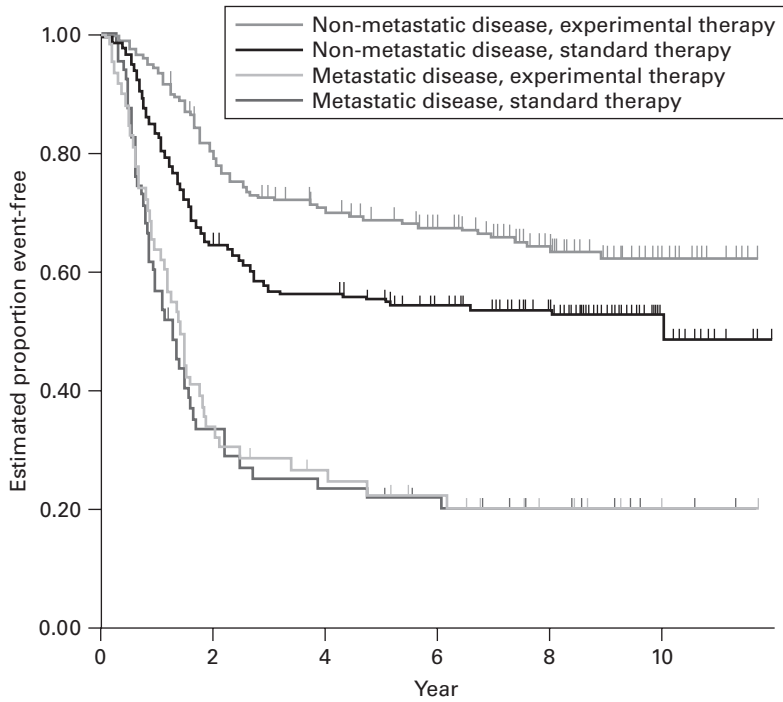
For local control 39% overall received radiation therapy alone; 38% surgery alone and 23% both; 1% had neither.

There were 12 toxic deaths, 7 from infection and 4 from anthracycline-related cardiac toxicity. There were seven secondary cancers.

Five-year event-free survival was  $69 \pm 3$  versus  $54 \pm 4$  for the intensified versus standard therapy. Relative risk of an event 1.6 ( $p = 0.005$ ). Overall survival was  $72 \pm 3$  versus  $61 \pm 4$ , respectively ( $p = 0.01$ ) (see Figure 3.11). The improvement was related largely to a reduction in local recurrence rate 5% for intensified versus 15% standard. There is no significant difference in the instance of systemic relapse. Outcome also appeared to be significantly improved in those with pelvic primary tumors although this did not reach statistical significance.

## Conclusion

The addition of ifosfamide and etoposide significantly improves local control and overall survival in localized Ewing's sarcoma.



**Figure 3.11** Event-free survival according to study group and the presence or absence of metastatic disease. Reprinted with permission from Grier *et al.* (full reference on p. 63). © 2003 Massachusetts Medical Society.



## CHAPTER 4

# Wilms' tumor

*Commentary by Daniel Green*

The treatment of Wilms' tumor has been the model for the multidisciplinary management of a pediatric solid tumor. Advances in anesthesia, surgical techniques, radiation therapy equipment and planning, and the demonstration that Wilms' tumor was responsive to several chemotherapeutic agents resulted in a transformation of the prognosis for children with this disease.

In this chapter the results of randomized clinical trials conducted by four groups are reviewed: the National Wilms' Tumour Study Group, the International Society of Paediatric Oncology, the United Kingdom Children's Cancer Study Group and the Brazilian Wilms' Tumour Study Group. The results of these trials form the basis for the management of children with Wilms' tumor throughout the world. The trials have had as a general objective defining the minimum necessary treatment for children with various stages and histologies of Wilms' tumor. The hypothesis has been that minimum necessary therapy would produce maximum survival rates with minimum late effects of therapy.

The trials conducted by the International Society of Paediatric Oncology (SIOP) had as a premise that treatment success was correlated with the presence or absence of residual intra-abdominal disease. They hypothesized that preoperative treatment would reduce the frequency of tumor rupture at the time of nephrectomy. This would lead to a lower frequency of post-nephrectomy abdominal radiation therapy in children with stages I–III Wilms' tumor. They demonstrated that pre-nephrectomy chemotherapy with vincristine and actinomycin D was as effective as abdominal radiation therapy in lowering the risk of tumor rupture. The most recent randomized trial conducted by SIOP demonstrated that 4 and 8 weeks of pre-nephrectomy chemotherapy were equivalent with respect to prevention of intraoperative tumor rupture and long-term survival.

The trials conducted by the National Wilms' Tumour Study (NWTS) Group focused on minimizing therapy for children treated with immediate nephrectomy. In their series of randomized trials, the Group demonstrated that abdominal irradiation was not necessary for children with stages I or II/favorable histology tumor. The addition of a third agent, doxorubicin, improved the outcome for those with stage III/favorable histology tumor randomized in NWTS-2, but a similar effect was not demonstrated in NWTS-3 when an intensified two-drug regimen was compared to the three-drug regimen. The most recent study of the NWTS Group demonstrated that single dose administration of actinomycin D and doxorubicin was as effective as the historical 5- and 3-day divided dose treatment courses.

The results of the SIOP and NWTSG studies are very difficult to compare due to the patient exclusions required by each study design. The SIOP studies exclude those with surgical emergencies (preoperative tumor rupture), a group that is at high risk of subsequent relapse. The number of patients excluded due to doubt in diagnosis, registration after nephrectomy or surgical emergency is 37–52% the number of patients that were actually entered into the randomized trials. All of those considered to be surgical emergencies would have received post-nephrectomy abdominal radiation therapy. Thus the published figures regarding the percentage of children who receive post-nephrectomy abdominal radiation therapy are artifactually lowered due to the exclusion of those with preoperative tumor rupture from the randomized trials. Conversely, an increasing percentage of children registered on the NWTS Group protocols have not been eligible for randomization because they received pre-nephrectomy chemotherapy. In general these children have large tumors, many of which may have been stage III. Thus

the NWTS results may also underestimate the percentage of children who would require post-nephrectomy abdominal radiation therapy.

The role of doxorubicin in the management of children with favorable histology Wilms' tumor remains unclear. The intensity of the two-drug treatment regimen has an effect on the relapse-free survival rate observed among those with stage II or III favorable histology disease. An anthracycline was added to the treatment regimen for SIOP patients with stage IIN0 disease, based on the results of SIOP-6, but it is unclear from the most recent published results if there is a difference in outcome between children treated with doxorubicin (German Pediatric Oncology Group) or epiadriamycin (remainder of SIOP institutions).

The goal of maximizing survival while minimizing toxicity has historically been dependent on light microscopic interpretation of histological findings, such as surgical margins and tumor subtype. More recent work has suggested that variables such as loss of heterozygosity at 1p or 16q may predict outcome, independent of traditional staging criteria. This hypothesis is being tested in the current NWTS Group protocol, where therapy is not being randomized. Future trials will build upon this model, with therapy first randomized and ultimately stratified, based on a combination of surgical, pathological and biological prognostic factors.

## Study 1

Lemerle J, Voute PA, Tournade MF, Delemarre JF, Jereb B, Ahstrom L, Flamant R, Gerard-Marchant R. Preoperative versus postoperative radiotherapy, single versus multiple courses of actinomycin D in the treatment of Wilms' tumour. Preliminary results of a controlled clinical trial conducted by the International Society of Paediatric Oncology (SIOP). *Cancer* 1976; **38**:647–54.

The study was carried out between 1971 and 1974 by the International Society of Paediatric Oncology (SIOP) Collaborative Group.

### Objectives

The main objectives were:

- To evaluate the role of preoperative radiotherapy.
- To compare two schedules of actinomycin D.

### Details of the study

Eligibility included patients aged from 1–15 years with unilateral non-metastatic Wilms' tumor. Excluded were patients deemed to have very large tumors, in whom initial surgery was felt to be impossible without undue risk. Patients were excluded from the chemotherapy trial if they had marked intolerance to the first course of actinomycin D and also those in whom postoperative treatment could not be initiated 3 weeks after nephrectomy.

The randomization method is not given in detail, but patients were stratified at the time of the second randomization, based on stage, the use of radiotherapy, age and center. An estimated 200–270 patients were planned to be included, at an accrual rate of 50–60/year. The predicted difference between arms was not specified.

The first randomization took place after a clinical diagnosis was made on the basis of imaging alone. Arm A

received preoperative radiotherapy (20 Gy in 15–18 fractions). Following surgery those with stage I received no radiation treatment, stages II and III received a further 30 Gy. Arm B had primary surgery. Postoperative stage I received 20 Gy, stage II 30 Gy + boost to tumor residue and stage III 30 Gy + boost to residue  $\pm$  30 Gy to the whole abdomen in case of tumor rupture.

Second randomization was to either a single dose of actinomycin D following surgery, versus 3-weekly actinomycin D for a total of six courses (Figure 4.1).

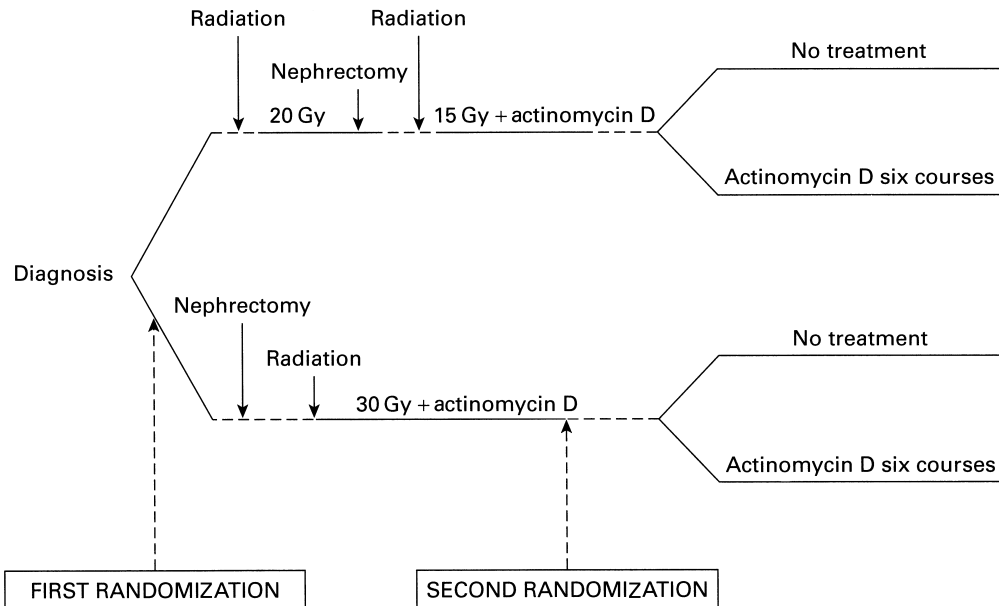
The main outcome measures were relapse-free survival (RFS), operative complications and treatment tolerance.

A total of 422 patients were registered, 44 were excluded as not having Wilms' tumor (of these 19 were neuroblastoma). Another 203 were excluded from randomization due to age <1 year or >15 years, stage IV or V, prior treatment, late registration or other causes. Ultimately, 169 patients were eligible for radiotherapy trial randomization of whom 90 received preoperative irradiation and 79 received postoperative irradiation. In these two groups 17 and 15 patients, respectively, were excluded after randomization because the tumor was not Wilms' or was stage IV. Therefore, a total of 137 were suitable for analysis.

### Outcome

Stage distribution in arm A was as follows: stage I – 31, stage II – 33, stage III – 9; there were 3 tumor ruptures at surgery. Arm B: stage I – 14, stage II – 28, stage III – 22; there were 20 ruptures. The percentage of stage I tumors was significantly higher in arm A,  $p < 0.025$ , and there were significantly fewer ruptures in arm A,  $p < 0.001$ . RFS at 3 years was 52% for arm A, 44% for arm B and overall survival was 83% and 71%, respectively, i.e. no significant difference.

In the actinomycin study, there were 161 eligible patients randomized, of whom 80 received a single



**Figure 4.1** SIOP-1 trial schedule. Copyright © 1976 American Cancer Society. Adapted and reprinted from Lemerle *et al.* (full reference on p. 68) with permission from Wiley-Liss, Inc., a subsidiary of John Wiley & Sons, Inc.

dose. The RFS was 54% and overall survival 82%. Eighty one patients received repeated actinomycin, in whom RFS was 58% and overall survival 86%, i.e. no significant difference.

The toxicities of the randomized arms with regard to other radiotherapy or chemotherapy were not given in detail.

### Conclusion

It was concluded that preoperative radiotherapy reduced the tumor rupture rate at surgery but the administration of radiotherapy postoperatively diminished any potential outcome difference.

## Study 2

Lemerle J, Voute PA, Tournade MF, Rodary C, Delemarre JE, Sarrazin D, Burgers JM, Sandstedt B, Mildenerger H, Carli M. Effectiveness of preoperative chemotherapy in Wilms' tumour: results of an International Society of Paediatric Oncology (SIOP) clinical trial. *J Clin Oncol* 1983;1:604–9.

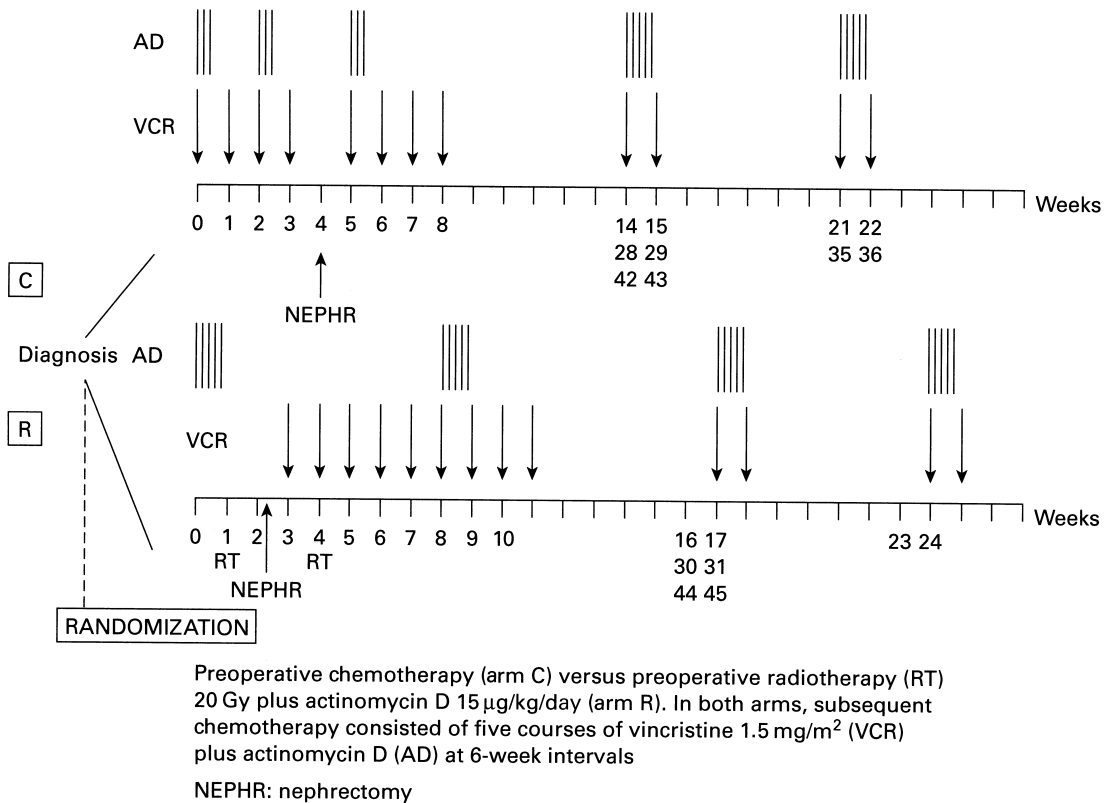
The trial was carried out between 1977 and 1979 by the International Society of Paediatric Oncology Group (SIOP-5).

### Details of the study

Patients aged between 1 and 15 years with non-metastatic or bilateral tumors were eligible, the only exclusion being those with small polar tumors.

The randomization methodology was not described and the predicted numbers required not detailed.

The trial consisted of randomizing patients to receive either a combination of actinomycin D (AD) plus local radiotherapy prior to nephrectomy followed by 6 months of vincristine and actinomycin D (VA), or four doses of vincristine and two doses of actinomycin alone, prior to surgery, followed by VA plus local radiotherapy as appropriate. The patients with stage I disease post-surgery received no radiotherapy; stages II and III received 15-Gy postoperatively in the preoperative radiotherapy arm, or 30-Gy postoperatively in those receiving chemotherapy alone. The same total dose of chemotherapy was given postoperatively, although a slightly higher dose was given preoperatively where chemotherapy alone was given (Figure 4.2).



**Figure 4.2** SIOP-5 trial schedule. © American Society of Clinical Oncology (full reference on p. 69).

Major outcome measures were event-free and overall survival.

## Outcome

There were 397 eligible patients, of whom 233 were excluded. This was due to age <1 or >15 years (46), stage IV or V (56), small tumor (15), doubt in diagnosis (44), late registration (41) and other reasons (31). Ultimately 164 were randomized. Of these, 10 were excluded as not having Wilms' tumors.

With preoperative chemotherapy alone there was a clinical reduction in size in 84%. Tumor rupture occurred in five patients. After radiotherapy 88% showed tumor reduction and there were seven ruptures after chemotherapy or radiotherapy. Stage distribution after chemotherapy or radiotherapy was similar: stage I, 43%

and 52%; stage II, 36% and 32%; stage III, 21% and 16%, respectively. A "major change" in pathological features (reflecting response) was seen in 53% of radiotherapy patients, compared to 17% after chemotherapy.

Event-free survival at 4 years with chemotherapy alone was 76% and overall survival 89%, compared with 67% and 83% for radiotherapy.

## Toxicity

Overall, there were four toxic deaths but it was not clearly specified in which arm this occurred.

## Conclusion

It was concluded that preoperative chemotherapy was equivalent to radiotherapy.

### Study 3

Tournade MF, Com-Nougue C, Voute PA, Lemerle J, de-Kraker J, Delemarre JF, Burgers M, Habrand JL, Moorman CG, Burger D. Results of Sixth International Society of Paediatric Oncology Wilms' Tumour trial and study: a risk-adapted therapeutic approach in Wilms' tumour. *J Clin Oncol* 1993;11:1014–23.

The study was carried out between 1980 and 1987 by the International Collaborative International Society of Paediatric Oncology Group (SIOP-6).

#### Objectives

This study addressed:

- The issue of the duration of postoperative chemotherapy in stage I.
- The role of local radiotherapy in stage II node negative patients.
- The role of doxorubicin (Adriamycin) in stage II node positive and stage III patients.

#### Details of the study

Eligible patients were 6 months to 15 years of age with stage I, II or III favorable histology. Patients could only have received vincristine and actinomycin preoperatively.

The method of randomization is not defined and patients were stratified only on the basis of center. Patients were randomized immediately after surgery before the initiation of continuing therapy. In stages I and IIN0 these were de-escalation trials for chemotherapy and therefore designed as equivalence trials. For stage IIN1 and stage III the design was of an efficacy trial. The same criteria were used for all trials: 2 years disease-free survival (DFS), with type I error 5%.

For stage I patients, given the likelihood of complications due to chemotherapy and the 85% level of DFS at 2 years with the longer chemotherapy used previously, the short regimen would be considered to be equivalent if the 2-year DFS proved to be >75%. A one-sided formulation to test the null hypothesis of inequivalence was applied, which stated that the difference in 2-year DFS between the long and short arm was >10%.

The minimum number of patients required for a given power of 80% was at least 390. As this was not feasible within the time period, it was decided that the

inclusion period would last 5 years and therefore the expected power would be approximately 45%.

For stage IIN0, with the baseline DFS of 67%, too many patients would have been required to detect a difference of 10%. Therefore, again 5-year accrual was planned. The stopping rule was instituted whereby if the local recurrence increased from 5% to 15% this would be considered unacceptable. For stage IIN1 patients and stage III patients a 5-year accrual would allow a 10% difference in 2-year DFS, with an error risk of 10%.

The protocol designed is outlined in Figure 4.3. The same preoperative chemotherapy comprising vincristine and actinomycin D over a 3-week period was followed by surgery. This consisted of radical nephrectomy, with examination and sampling of at least one hilar and one para-aortic node, as well as any suspicious regional lymph nodes. Patients were then stratified according to stage, lymph node involvement and histology.

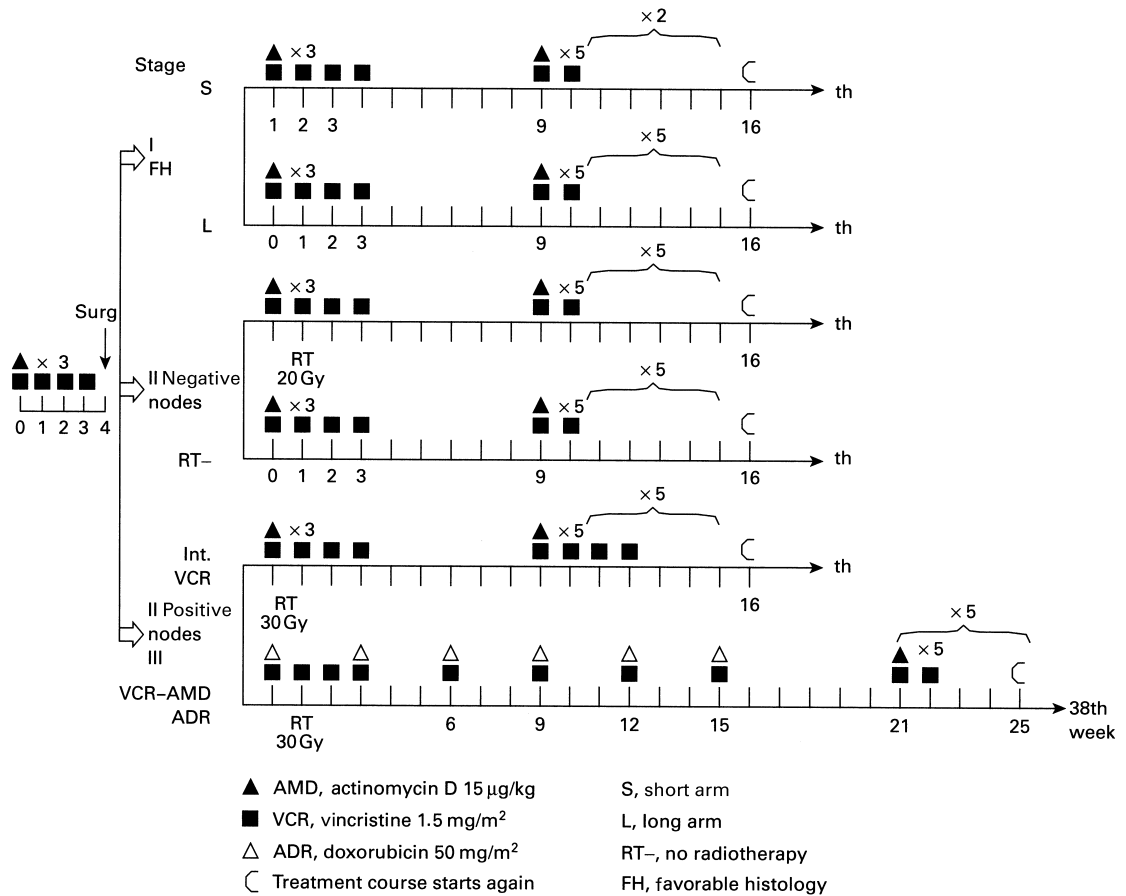
Postoperative chemotherapy was started 1 week after surgery.

Radiation therapy, when given, had to be initiated within 2 weeks of surgery. The tumor bed was to be defined as the whole area of the kidney and the tumor according to the preoperative clinical and radiological extension criteria and based on the surgical and pathological reports. Total dose was 20 Gy in stage IIN0 and 30 Gy in stage IIN1 and III. A 5-Gy boost was permitted on areas of residual disease or in case of positive para-aortic lymph nodes.

The major outcome measure was 2-year DFS and 5-year overall survival.

#### Outcome

A total of 1095 patients were registered, of these 509 were assigned to the randomized trial group. Of the 586 who were found to be non-eligible, 421 were not included at initial registration due to age, stage or late registration. One hundred and sixty-two were excluded after nephrectomy due to other pathology or unfavorable histology. Fifty patients were taking part in the pilot study of SIOP-9. Patient accrual for stage I ended prematurely, whilst recruitment for stage II continued for a further period. A total of 442 patients with stage I–III disease were recruited in the initial period. In 7% tumor rupture occurred at the time of surgery. Of the 509 patients, 303 were stage I, 123 stage IIN0, 83 stages IIN1 and III. On central review, 47 patients



**Figure 4.3** SIOP-6 Wilms' tumor protocol. © American Society of Clinical Oncology (full reference on p. 71).

were found to be misstaged (9% of the randomized tumors). Understaging mainly concerned stage IIN0 patients; 14 patients were overstaged.

Histological review was carried out in 86% of the trial patients and 34 tumors that had unfavorable histology not identified by the local pathologist were redefined. Overall, the total rate of tumors with an unfavorable histology that were misclassified was 51%. Seventy-one patients were found to have a non-Wilms' tumor, 16 had benign disease and 22 a malignancy. Overall, benign disease represented 1.5 of the 1095 registered tumors.

Therapy compliance was reviewed by the Trial Committee, on the basis of recorded information regarding chemotherapy, irradiation, surgery and pathology. Complete evaluation was possible for all trial patients. Overall, 62% were treated strictly according to the protocols. Minor modifications involving a small reduction in dose or timing of radiotherapy were noted in 30%. Major

deviations were noted in 8% (the precise definition of major deviation was not given). For chemotherapy a major deviation was a dose reduction to <75% or the omission of one or more prescribed drugs, or delays of >1 week in starting therapy.

For stage I patients the 2-year DFS rate was 92% in the short arm, versus 88% in the long arm, with a 5-year survival of 95% and 92%, respectively. In stage IIN0, abdominal recurrence occurred in six patients treated in the no-radiotherapy arm and as a consequence the trial was stopped in accordance with the stopping rule. Subsequently all stage II patients received local radiotherapy. The difference between the two regimens was less evident in terms of DFS. The number of events observed was higher in the radiotherapy arm, 18 versus 13, but 2-year DFS and 5-year survival were 72% versus 78% and 88% versus 85%, respectively. Statistical analysis concluded that there was equivalence between the

radiation and non-radiation arms in terms of 2-year DFS,  $p < 0.05$ .

For node positive stage II and stage III patients the trial was also stopped prematurely but this was because of emerging results from the American National Wilms' Tumour Study trial, indicating an 80% event-free survival at 5 years using a three-drug regimen. The 60% 2-year DFS rate obtained in SIOP-6 regardless of treatment was considered unsatisfactory. Despite this early closure, the DFS analysis shows a preference in favor of the doxorubicin-containing regimen,  $p < 0.03$ . Two-year DFS and 5-year survival rates were 49% versus

74% and 77% versus 80%, respectively. The difference is not significant in terms of overall survival.

### Conclusion

There was no significant difference in relapse sites in any treatment arm, although there was a suggestion of an increased rate of lung metastases in the radiation-plus non-doxorubicin-containing regimen. It is possible that the higher rate of protocol modification in the radiation-containing arm could have been responsible for this.

## Study 4

De Camargo B, Franco EL. A randomised clinical trial of single-dose versus fractionated-dose dactinomycin in the treatment of Wilms' tumour. Results after extended follow-up. Brazilian Wilms' Tumour Study Group. *Cancer* 1994;73:3081–6.

The study was carried out between 1986 and 1988 by the Brazilian Wilms' Tumour Study Group.

### Objectives

The aim of the study was:

- To evaluate the toxicity and efficacy of the more convenient single dose regimen of actinomycin D.

### Details of the study

Eligible patients were those of any age with unilateral stage I–IV Wilms' tumor.

The method of randomization was not described in detail and no predicted number of patients required was given. Patients did not appear to be stratified for any factor.

The main outcome measures were local and distant relapse rates, disease-free and overall survival. The Cox's proportional hazards regression method was used to control for subset analysis bias.

This was a prospective randomized study with three regimens as shown in Figure 4.4 and radiotherapy in stages III and IV. Chemotherapy comprised vincristine (VCR) and actinomycin D (AMD) or VCR/AMD and doxorubicin (ADR). The only variable was the dose and method of administration of AMD. In arm A this

was given as a fractionated dose of 15  $\mu\text{g}/\text{kg}$  over 5 days and in arm B a single dose of 60  $\mu\text{g}/\text{kg}$ . Courses of chemotherapy were given every 6 weeks.

### Outcome

One hundred and ninety patients were registered, of whom 176 were confirmed with Wilms' tumor. One hundred and fifty-six patients were randomized. Physician decision or data entry problems were the main cause of non-randomization. There were 33 major violations, which included the wrong chemotherapy, the wrong radiotherapy or non-completion of chemotherapy.

With arm A, at mean follow-up of 38 months and median follow-up of 47 months, there was an 80% 4-year relapse-free survival and 84% overall survival. In arm B at mean and median follow-up of 38 and 44 months, respectively; the 4-year relapse-free survival was 77% and overall survival 83%, i.e. no significant difference.

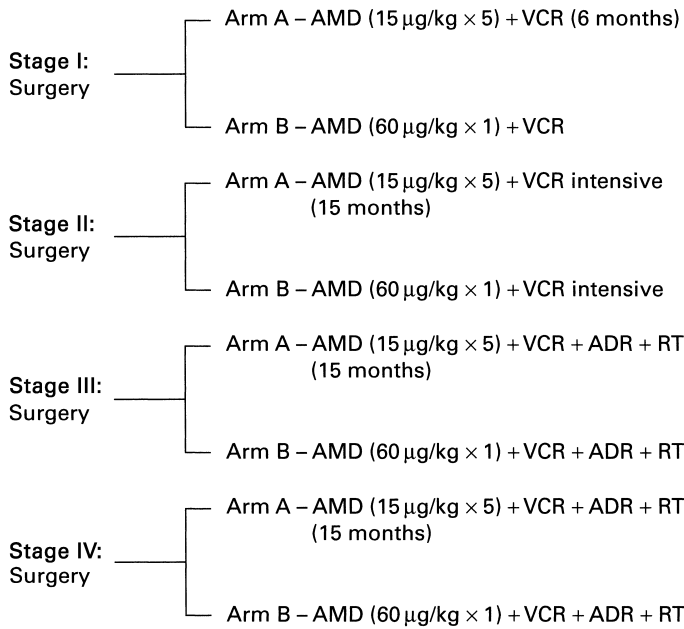
### Toxicity

Little detail was given about the toxicity, although no clear difference appears to have been documented. Only a single toxicity was reported with regimen A, and hepatic toxicity was not observed in either arm. The 6-week gap between chemotherapies may account for the low toxicity observed in this study.

### Conclusion

It was concluded that there was no significant difference between AMD schedules, either in terms of efficacy or toxicity and the single dose was concluded to be more cost effective.





**Figure 4.4** Treatment regimens according to disease stage. Copyright © 1994 American Cancer Society. Adapted and reprinted from De Camargo *et al.* (full reference on p. 73) by permission of Wiley-Liss, Inc., a subsidiary of John Wiley & Sons, Inc.

## Study 5

D'Angio GJ, Evans AE, Breslow N, Beckwith B, Bishop H, Feigl P, Goodwin W, Leape LL, Sinks LF, Sutow W, Tefft M, Wolff J. The treatment of Wilms' tumour. Results of the National Wilms' Tumour Study. *Cancer* 1976; **38**:633–46.

The study was carried out between 1969 and 1973 by the National Wilms' Tumour Study Group (NWTS-1).

### Objectives

The study evaluates:

- The role of radiotherapy in stage I patients
- Three chemotherapy regimens in groups II and III (VCR alone, actinomycin alone or VA)
- The role of preoperative vincristine in group IV patients.

### Details of the study

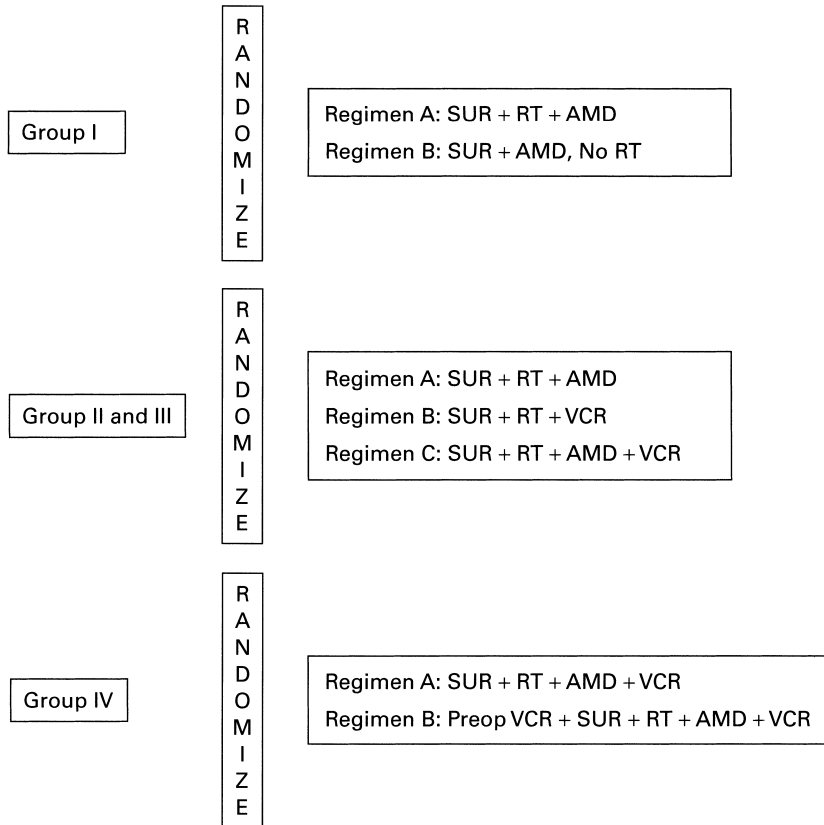
Eligible patients were those of any age or stage or pathology.

Randomization method was by telephone to the regional center within 2 days of surgery for group I–III patients and group IV patients were randomized prior to surgery. Patients were stratified by age. The predicted number required or the differences to be detected were not detailed.

The primary outcome measures were relapse-free and overall survival.

Details of treatment regimens are given in Figure 4.5.

For group I patients who received actinomycin D (AMD) with or without radiotherapy the radiation therapy had to be started within 48 hours of surgery. The dose regimen was adjusted for age, ranging from 18 to 24 Gy for 18 months or less, up to 40 Gy for those >40 months. The radiation field was designed to encompass the site of the kidney and associated tumor as visualized on a preoperative excretory urogram. Group I patients received AMD administered within 48 hours of diagnosis. Five daily injections were given at the time of surgery and at 6 weeks then 3, 6, 9, 12 and 15 months thereafter. Groups II–IV patients who received vincristine (VCR) alone were given a dose at diagnosis and weekly for seven doses and



SUR, surgery; RT, radiotherapy; AMD, actinomycin D 15  $\mu$ g/kg; VCR, vincristine 1.5 mg/m<sup>2</sup>

**Figure 4.5** Treatment schemas of NWTs-1. Copyright © 1976 American Cancer Society. Adapted and reprinted from D'Angio *et al.* (full reference on p. 74) by permission of Wiley-Liss, Inc., a subsidiary of John Wiley & Sons, Inc.

thereafter at 3-monthly intervals for a period of 15 months. Vincristine and actinomycin D (VA) combined drugs in the same schedule, omitting the first VCR.

### Outcome

Six hundred and six patients were registered, of whom 359 were randomized. Reasons for exclusion are given in detail, and included prior treatment, parental and institutional decisions. A diagnosis other than Wilms' tumor occurred in 30 patients. On central review, 16% of patients had been allocated to the wrong group.

Overall, there was good compliance with radiotherapy and chemotherapy. In only one patient there was a major deviation of radiotherapy due to a reduced

dose, and there were eight chemotherapy deviations due to a reduced dose or delay.

For stage I patients <2 years of age there was no difference between those given radiotherapy or AMD alone, with 2-year disease-free survival (DFS) of 90% and 88%, respectively, and overall survival of 97% and 94%, respectively. For those >2 years of age the 2-year DFS appeared to be higher in those who had received local radiotherapy, being 77% versus 58% ( $p = 0.04$ ), although overall survival was not different, at 97% versus 91%.

For stage II and III patients there was a significant advantage to the combination of vincristine and AMD, with 2-year DFS of 81% for VA, versus 57% for actinomycin and 55% for vincristine alone. This was

translated into an overall survival advantage with 86% for VA, versus 67% and 72% for actinomycin and vincristine, respectively ( $p = 0.002$ ).

In stage IV patients only 13 were included in each arm and the overall survival appeared to be superior in those who had immediate surgery without preoperative vincristine, 83% versus 29% ( $p = 0.02$ ).

### Conclusion

- In group I patients >2 years of age the relapse rate appeared to be higher in the absence of radiotherapy, as the overall survival was no different; this did not justify the late effects associated with radiation in this good outcome group.
- In group II/III VA is superior to A or V alone.

## Study 6

D'Angio GJ, Evans A, Breslow N, Beckwith B, Bishop H, Farewell V, Goodwin W, Leape L, Palmer N, Sinks L, Sutow W, Tefft M, Wolff J. The treatment of Wilms' tumour. Results of the Second National Wilms' Tumor Study. *Cancer* 1981;47:2302–11.

The study was carried out between 1974 and 1978 by the National Wilms' Tumor Study Group (NWTs-2). It considered the role of treatment duration in Group I, and the value of adding doxorubicin to vincristine and actinomycin in groups II–IV.

### Details of the study

Eligible patients were those of any age or stage or pathology.

Randomization method was not given in detail. Patients were stratified by institution, group and age. No predicted number of patients required or anticipated differences in outcome were given.

Treatment strategies are outlined in Figure 4.6. Group I patients did not receive any radiotherapy (RT) after surgery and all received actinomycin D (AMD) with vincristine (VCR) postoperatively and at 6 weeks, 3 months and 6 months. AMD dose was  $15 \mu\text{g}/\text{kg}/\text{day} \times 5$  days and VCR was given on days 7, 14, 21, 28 and 35 at  $1.5 \text{ mg}/\text{m}^2$ . Patients were randomized to receive either 6 or 15 months VA treatment.

Group II–IV patients all received local RT, the dose to the tumor bed being age related, ranging from 18 Gy in those up to 18 months of age to 40 Gy for those >40 months. Group IV patients initially received whole lung dose of 14 Gy but because of a 10% incidence of pneumonitis this was reduced to 12 Gy. Other tumor sites received up to 30 Gy. Patients were randomized to receive two (VA) or three (AVA) drugs – doxorubicin

(Adriamycin) 60 mg/m was given every 3 months for four doses.

Main outcome measures were relapse-free survival (RFS) and overall survival.

### Outcome

Of 755 patients registered, 513 were randomized. The reasons for non-inclusion and non-randomization were given in detail and included 35 children who were deemed to be inoperable by the local physician and received preoperative chemotherapy. Thirty-four tumors were bilateral and 15 patients received alternative chemotherapy. There were 12 cases of misdiagnosis.

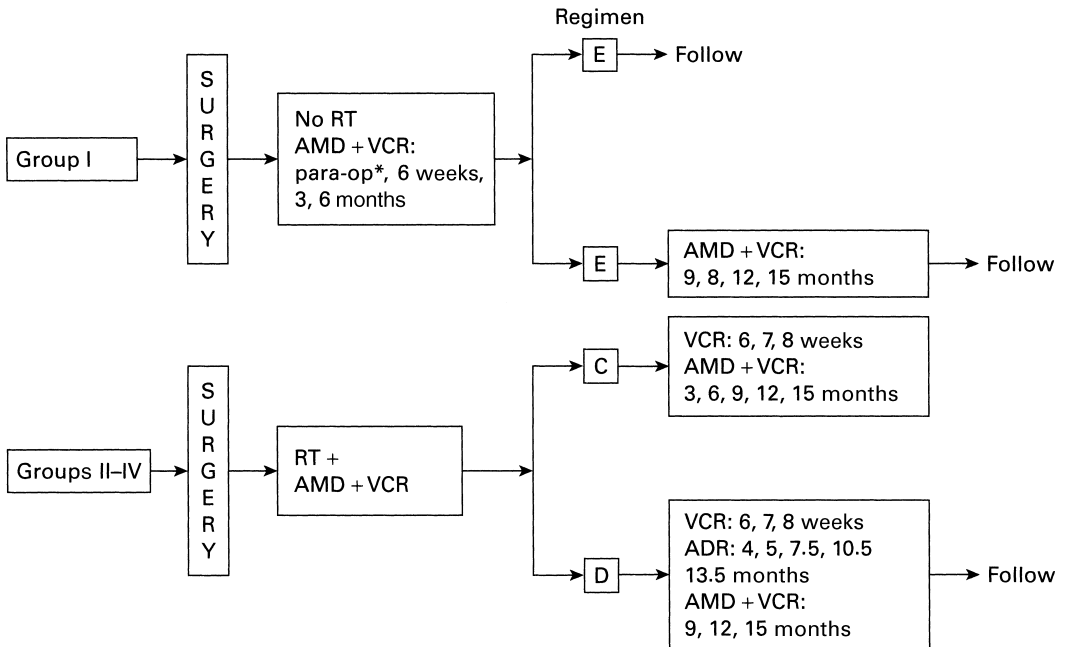
Of the patients randomized, 22 switched chemotherapy regimens after central review resulted in a change of group. There were 31 major chemotherapy dose violations and 13 RT deviations.

For 188 group I patients there was no difference in outcome, with an overall 2-year RFS of 88%. There were 5/91 events in the short treatment arm versus 8/91 events in the long arm.

In groups II and III patients with favorable histology the addition of doxorubicin significantly improved outcome – 12/111 events versus 31/121 ( $p < 0.004$ ). Overall, group II–IV patients randomized to AVA had RFS at 2 years of 77% versus 62% ( $p < 0.0004$ ). For unfavorable histology patients there was no difference in RFS, although the overall survival appeared to be superior in the three-drug arm – 9/16 versus 4/19 ( $p < 0.05$ ). For favorable histology group IV patients alone, the RFS was 59% versus 43%, again favoring the three-drug arm, although this was not statistically significant.

### Toxicity

There was one toxic death in a group IV patient, who had received doxorubicin in addition to thoracic RT.



\*Para-op = day 1: actinomycin D (AMD)  $\times 15 \mu\text{g}/\text{kg}/\text{day} \times 5$   
days 7, 14, 21, 28, 35: vincristine (VCR)  $1.5 \text{ mg}/\text{m}^2$

Subsequent courses = AMD doses as above, VCR days 1 and 5, doses as above  
doxorubicin (ADR)  $60 \text{ mg}/\text{m}^2$

**Figure 4.6** Treatment schemas of NWTS-2. Copyright © 1981 American Cancer Society. Adapted and reproduced from D'Angio *et al.* (full reference on p. 76) by permission of Wiley-Liss, Inc., a subsidiary of John Wiley & Sons, Inc.

The three-arm drug was predictably more myelosuppressive but there was no documented increase in other toxicity.

The authors mentioned that the outcome using the two-drug arm in the previous NWTS-1 study was superior for unexplained reasons. It is suggested perhaps the omission of AMD on week 6 compared to NWTS-1 could have contributed to this difference.

### Conclusion

The conclusions were that the short regimen is adequate for group I patients without the use of RT and that the addition of doxorubicin improves outcome in all other stages, particularly those with favorable histology.

## Study 7

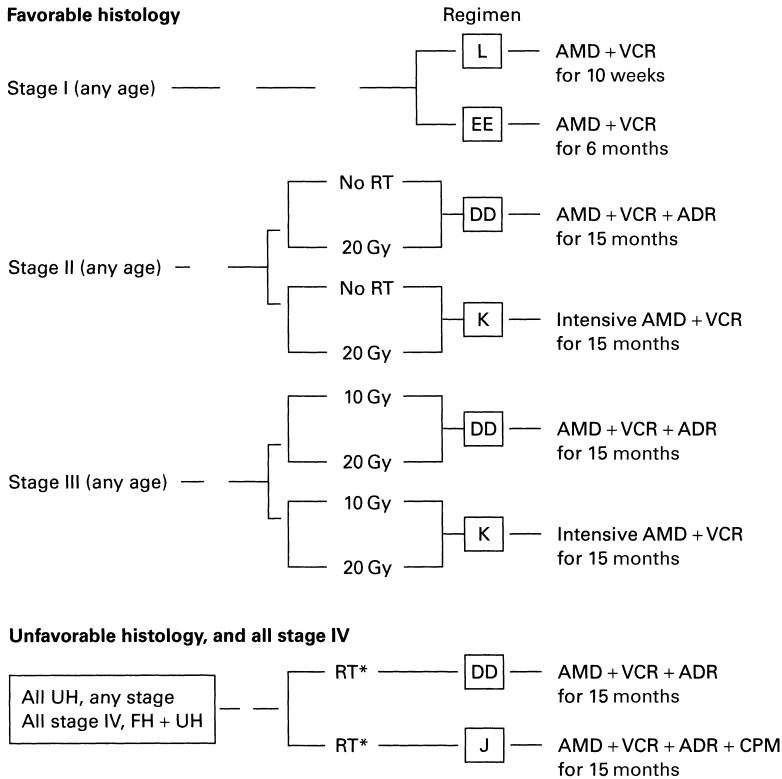
D'Angio GJ, Breslow N, Beckwith JB, Evans A, Baum H, deLorimier A, Fernbach D, Hrabovsky E, Jones B, Kelalis P. Treatment of Wilms' tumour. Results of the Third National Wilms' Tumor Study. *Cancer* 1989; **64**:349–60.

The study was carried out between 1979 and 1985 by the National Wilms' Tumor Study Group (NWTS-3).

### Objectives

The study addressed:

- The issue of further shortening of the duration of treatment for stage I with favorable histology.
- The role of doxorubicin (Adriamycin) and local irradiation in stage II.



**Figure 4.7** Treatment schemas of NWTS-3. Copyright © 1989 American Cancer Society. Adapted and reprinted from D'Angio *et al.* (full reference on p. 77) by permission of Wiley-Liss, Inc., a subsidiary of John Wiley & Sons, Inc.

AMD, actinomycin D; VCR, vincristine; ADR, doxorubicin; CPM, cyclophosphamide  
\*All FH stage IV receive 20 Gy flank RT flank RT and RT to other sites as in NWTS-2  
All UH, all stages receive age-adjusted flank RT and to other sites as in NWTS-2

- The role of doxorubicin and the dose of radiotherapy in stage III.
- The role of adding cyclophosphamide to AVA in stage IV and unfavorable histology.

### Details of the study

Patients <16 years of age with any stage of pathology or histology were eligible.

Details of the randomization method are not given. This was a factorial design, enabling the question regarding radiation and radiation dose, in addition to the role of doxorubicin, to be evaluated in the same patient group. Patients were stratified for histology and stage. No predictions of the numbers required or differences anticipated are given.

The outline of the study is given in Figure 4.7.

Stage I patients received a combination of vincristine and actinomycin D (VA) at a dose of 15 µg/kg/

day × 5 and 1.5 mg/m<sup>2</sup>/week for 10 weeks. Patients were randomized to receive treatment for either 10 or 26 weeks.

Stage II or III patients with favorable histology (FH) received the same initial 10 weeks but were randomized between VA with 5-day actinomycin D followed by 5 weekly injections of vincristine, repeated every 9 weeks, versus alternating actinomycin with two doses of vincristine and doxorubicin 20 mg/m<sup>2</sup>/day on 3 consecutive days (AVA). Treatment duration was 65 weeks in both arms.

Stage IV patients with both favorable and unfavorable histology (UH) were randomized between the AVA regimen with or without cyclophosphamide 10 mg/kg/day IV on 3 consecutive days.

Stage II FH patients were randomized to receive or not receive 20-Gy local radiotherapy (RT) given not >10 days after nephrectomy. Stage III FH patients were randomized between 10 and 20 Gy. All stage IV

patients received 12 Gy to the lung and mediastinum and FH patients with liver metastases received 20 Gy, UH received 30–40 Gy for metastases sites.

Close quality assurance monitoring took place, with deviations from timing and dosage of chemotherapy documented. All radiation therapy, machine calibrations, dose rates, physics and technical specifications were checked. All planning records and fields and doses used with imaging studies, operative and pathology reports were checked. Protocol deviations were defined as a delay in RT starting >10 days after nephrectomy, doses below the protocol stipulated level by >25% and failure to include all the tissues at risk as defined by the protocol. The Central Surgical Committee reviewed all operative and pathology reports.

## Outcome

A total of 2496 patients were registered and of these 1489 were randomized. Three hundred and eight were non-eligible due to inoperability, age and stage V. Five hundred and twenty-five eligible patients were treated with the protocol but not randomized and 174 eligible patients did not receive the protocol. Of the randomized patients, 24 were excluded. In 4 cases this was due to preoperative treatment, in 17 to stage IV disease which had been defined on the basis of CT scan alone. A further 26 children who had no follow-up data of any kind were excluded from the survival and relapse-free survival (RFS) analysis; 10% of patients switched regimen on review.

No significant difference was apparent relating to duration of treatment in stage I. The conclusions were less clear for the doxorubicin question. When stages II and III together are considered, there was no difference in outcome. Similarly, there was no difference for stage II alone. When stage III alone is considered, the relapse risk ratio for those receiving two versus three drugs was 1.6 ( $p = 0.07$ ). There appeared to be fewer intra-abdominal relapses among those who receive doxorubicin, 4/134 versus 11/141, although this was not statistically significant. More than half the intra-abdominal relapses for stage III patients occurred among those given reduced irradiation of 10 Gy without doxorubicin. RFS and survival were no different in stage II patients who received no irradiation versus 20 Gy, or in stage III patients who received 10 Gy versus 20 Gy.

For high-risk patients, namely the 279 patients with metastases at diagnosis, or tumors of UH, the 4-year survival and RFS were 73% and 68%, respectively, and the addition of cyclophosphamide did not improve outcome.

A separate analysis for UH patients showed that the outlook for children with rhabdoid tumors was very poor whether or not cyclophosphamide was used, with only 25% alive at 4 years, contrasting with clear cell sarcoma, where the outcome was good, with 75% of patients alive at 4 years, irrespective of the chemotherapy given. For stages II, III and IV anaplastic tumors cyclophosphamide appeared to improve outcome, although the numbers are small – only 21 in the standard arm and 12 in the short arm. Four-year survival was 37% versus 82%, respectively. Combining log-rank scores for all anaplastic tumors, there were two relapses observed versus 6.7 expected for patients receiving four drugs ( $p < 0.02$ ).

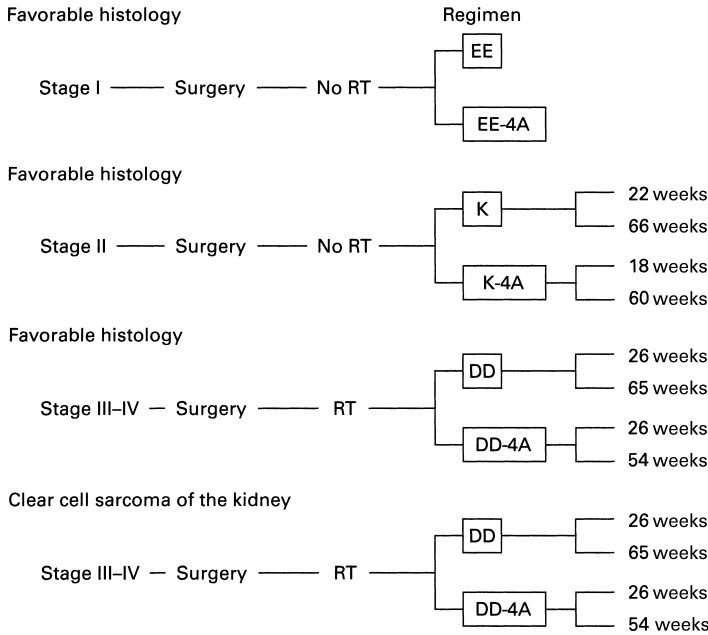
## Toxicity

Eighteen patients with stage IV disease developed radiological signs of pneumonitis; 3 with identified pneumocystis survived, 11 of the remaining 15 died. Although the addition of anthracycline was a specific question, there was no prospective documentation of cardiac function. Only “episodes of transient cardiotoxicity” were reported and these were seen more frequently in the doxorubicin-containing arm.

## Conclusion

The conclusions from this study, which were brought forward into NWTs-4, were somewhat at odds with the published data. Although the short arm appeared to be equivalent for stage I patients, because “subset analyses, corrected for certain aberrations”, resulted in a statistically significant better survival for patients treated initially with 6 months rather than 10 weeks of chemotherapy, although the RFS rates were not different, it was decided to retain 6 months of treatment. Although the role of doxorubicin was not clearly demonstrated, the Committee favored the use of the doxorubicin-containing regimen for stage III patients because this appeared to compensate for the lower dose of irradiation. RT was concluded to play no role in stage II or FH patients.

The apparently beneficial effect of cyclophosphamide in stage II–IV anaplastic tumors was carried forward into the next study to obtain further data. The outline of NWTs-4 is given in Figure 4.8.



**Figure 4.8** Treatment randomization for NWTs-4. Copyright © 1989 American Cancer Society. Adapted and reprinted from D'Angio *et al.* (full reference on p. 77) by permission of Wiley-Liss, Inc., a subsidiary of John Wiley & Sons, Inc.

## Study 8

Green DM, Breslow NE, Beckwith JB, Finklestein JZ, Grundy PE, Thomas PRM, Kim T, Schochat SJ, Haase GM, Ritchey ML, Kelalis PP, D'Angio GJ. Comparison between single-dose and divided-dose administration of dactinomycin and doxorubicin for patients with Wilms' tumour: a report from the National Wilms' Tumor Study Group. *J Clin Oncol* 1998;16:237–45.

This study was carried out by the National Wilms' Tumor Study Group between 1986 and 1994 (NWTs-4).

### Objectives

The study was designed:

- To evaluate the efficacy, toxicity and cost of fractionated versus single dose of actinomycin D.

### Details of the study

Eligibility included all those with Wilms' tumor <16 years of age with untreated stage I–IV favorable

histology, stage I anaplastic and stage I–IV clear cell sarcoma of the kidney.

Patients were treated by initial nephrectomy and lymph node biopsy. After surgical staging they were randomized within 5 days of surgery to receive a chemotherapy regimen that included actinomycin D, either as a single or divided dose. The initial dose of single fraction actinomycin D was 60  $\mu\text{g}/\text{kg}$  but this was reduced to 45  $\mu\text{g}/\text{kg}$  after early concern about hepatic toxicity.

Regimens were based on stage, as detailed in Figures 4.8–4.11. In summary, stage I patients received either 18 or 25 weeks of therapy with the frequency of actinomycin varying in addition to the schedule. For stage II, in addition to the schedule difference, the total number of doses differed: 8 in one treatment arm and 21 in the other. In stage III and patients with unfavorable histology, the number of doses of actinomycin D varied between study arms (10 versus 6) as did the total number of doxorubicin doses (5 versus 9), although the total dose was the same.

The study design was based on a two-sided test, with 95% power at the 0.05 level to detect a 2.5-fold reduction in the relapse rate, using the repeated dose

schedule (pulse intensive) versus the standard regimen, or a 2-fold increase in relapse rate if the divided dose schedule was inferior.

### Outcome

NWTS-4 registered 3335 patients, of whom 1756 were randomized. A further 1039 patients were treated on the same protocol but off study. Two hundred and seventy were not monitored. Of those randomized, 49 were excluded due to no pathological review or inadequate follow-up and 69 due to anaplastic histology stages II–IV.

Five hundred and thirty-six low-risk patients were randomized to standard and 528 to pulse intensive actinomycin D. In these patients the 2-year relapse-free

survival (RFS) for the standard regimen was 91.4% (98.6% overall), and 91.3% RFS (97.9%) for the pulse intensive regimen. For the high-risk patients, 284 received the standard regimen, with 90% RFS and 96% overall survival; 290 received pulse intensive therapy, with 87% RFS and 95.4% overall survival.

### Toxicity

There was no significant difference in the hematological toxicity, nor at the 45 µg/kg dose level in the frequency of severe hepatic toxicity.

### Conclusion

Single dose actinomycin D is equivalent to fractionated.



	Week																										
Regimen	0	1	2	3	4	5	6	7	8	9	10	11	12	13	14	15	16	17	18	19	20	21	22	23	24	25	
EE	A					A								A												A	
		V	V	V	V	V	V	V	V	V	V			V	V											V	V
EE-4A	A*			A*			A*			A*			A*			A*			A*								
		V	V	V	V	V	V	V	V	V	V		V*			V*			V*								

A, actinomycin D 15  $\mu\text{g}/\text{kg}/\text{day} \times 5$  days IV; A\*, actinomycin D 45  $\mu\text{g}/\text{kg}$  IV; V, vincristine 1.5  $\text{mg}/\text{m}^2$  IV; V\*, vincristine 2.0  $\text{mg}/\text{m}^2$  IV

**Figure 4.9** Treatment randomization for children with stage I/FH and stage I/anaplastic Wilms' tumor. © American Society of Clinical Oncology (full reference on p. 80).

	Week																				
Regimen	0	1	2	3	4	5	6	7	8	9	10	11	12	13	14	15	16	17	18	19	20
K	A					A								A							
		V	V	V	V	V	V	V	V	V	V					V	V	V	V	V	V
K-4A	A*			A*			A*			A*			A*			A*			A*		
		V	V	V	V	V	V	V	V	V	V	V*			V*			V*			V*

	Week																											
	21	22	23	24	25	26	27	28	29	30	31	32	33	34	35	36	37	38	39	40	41	42	43	44	45	46	47	
K		A									A										A							
				V	V	V	V	V	V				V	V	V	V	V	V					V	V	V	V	V	V
K-4A	A*			A*			A*			A*			A*			A*			A*			A*			A*			
	V*			V*			V*			V*			V*			V*			V*			V*			V*			

	Week																	
	48	49	50	51	52	53	54	55	56	57	58	59	60	61	62	63	64	65
K		A									A							
				V	V	V	V	V	V				V	V	V	V	V	V
K-4A	A*			A*			A*			A*			A*			A*		
	V*			V*			V*			V*			V*			V*		

A, actinomycin D 15 µg/kg/day × 5 days IV; A\*, actinomycin D 45 µg/kg/IV; V, vincristine 1.5 mg/m<sup>2</sup> IV; V\*, vincristine, 2.0 mg/m<sup>2</sup> IV

**Figure 4.10** Treatment randomization for children with stage II/FH Wilms' tumor. © American Society of Clinical Oncology (full reference on p. 80).

Regimen	Week																												
	0	1	2	3	4	5	6	7	8	9	10	11	12	13	14	15	16	17	18	19	20	21	22	23	24	25	26	27	
DD	A						D							A						D								A	
		V	V	V	V	V	V	V	V	V	V			V	V													V	V
DD-4A	A*			D+			A*			D+			A*			D*			A*			D*			A*			D*	
		V	V	V	V	V	V	V	V	V	V		V*			V*			V*			V*			V*			V*	
	RT																												
Regimen	Week																												
	28	29	30	31	32	33	34	35	36	37	38	39	40	41	42	43	44	45	46	47									
DD					D							A						D											
												V	V																
DD-4A			A*			D*			A*			D*			A*			D*											
			V*			V*			V*			V*			V*			V*											
Regimen	Week																												
	48	49	50	51	52	53	54	55	56	57	58	59	60	61	62	63	64	65	66										
DD					A						D							A											
					V	V												V	V										
DD-4A	A*			D*				A*																					
	V*			V*				V*																					

A, actinomycin D 15 µg/kg/day × 5 days IV; A\*, actinomycin D 45 µg/kg IV; V, vincristine 1.5 mg/m<sup>2</sup> IV; V\*, vincristine 2.0 mg/m<sup>2</sup> IV; D, doxorubicin 20 mg/m<sup>2</sup> day × 3 days IV; D\*, doxorubicin 30 mg/m<sup>2</sup> IV; D+, doxorubicin 45 mg/m<sup>2</sup> IV; RT, abdominal irradiation

**Figure 4.11** Treatment randomization for children with stage III/FH and IV/FH Wilms' tumor and stages I–IV/clear cell sarcoma of the kidney. © American Society of Clinical Oncology (full reference on p. 80).

## Study 9

Tournade MF, Com-Nougue C, de Kraker J, Ludwig R, Rey A, Burgers JMB, Sandstedt B, Godzinski J, Carli M, Potter R, Zucker JM. Optimal duration of preoperative therapy in unilateral and nonmetastatic Wilms' tumour in children older than 6 months: results of the Ninth International Society of Pediatric Oncology Wilms' Tumour trial and study. *J Clin Oncol* 2001; **19**:488–500.

The study was carried out between 1987 and 1991 by the International Society of Paediatric Oncology Group (SIOP-9 trial).

### Objectives

The purpose of this trial was:

- To determine whether prolonged preoperative chemotherapy increased the proportion of stage I tumors, by comparing two regimens, one lasting 4 weeks and one lasting 8 weeks.

### Details of the study

Eligibility criteria included patients aged 6 months to 16 years with untreated unilateral, non-metastatic tumors, where the clinical diagnosis appeared unequivocal and the child was fit to receive preoperative chemotherapy.

Randomization was carried out at the Paris data center. The method used is not stated. Patients were stratified by center and balanced using randomized block permutation.

The baseline percentage of stage I patients was assumed to be 53%, on the basis of prior SIOP trials. It was predicted that 150 patients would be required in each arm to show a 15% increase in the number of stage I patients using the longer chemotherapy (80% power).

All patients following a clinical diagnosis of Wilms' tumor received a combination of vincristine and actinomycin D. Patients were randomized only if they had responded to the initial 4 weeks chemotherapy. Surgery was carried out 1 week following completion of either 4 or 8 weeks chemotherapy and subsequent treatment depended on the surgical stage. Local radiotherapy (15-Gy favorable histology, 30-Gy unfavorable

histology) was given to stage IIN, III and IIN0 unfavorable histology (Figure 4.12).

Because of an apparently high incidence of veno-occlusive disease, the schedule of actinomycin D was changed in April 1989 from single to split dose and two-thirds of the dose was given if the child was <12 kg.

The main outcome measure was the percentage of stage I patients and tumor size following preoperative chemotherapy. Event-free survival (EFS) and overall survival were secondary endpoints.

### Outcome

A total of 852 children were registered for the study, of whom 341 registered were not entered on the trial for a range of reasons, including age, doubt about diagnosis, surgical emergency and advanced stage. Five hundred and eleven patients received study chemotherapy but 129 were excluded from randomization following 4 weeks preoperative chemotherapy. This was due to non-response, toxicity or refusal. Ultimately, 382 patients were randomized, 193 to 4 weeks and 189 to receive 8 weeks preoperative chemotherapy.

There was no difference in the rupture rate at time of surgery, 1% versus 3%, or in the 2-year EFS, 92% versus 87%, and no difference in the site of failure between those receiving 4 or 8 weeks chemotherapy.

Volume assessment was available in 86% of patients, showing a >50% reduction occurred in 52% of patients after four courses, and 64% of patients were stage I at operation. Following an additional four courses of chemotherapy, a further reduction of 50% volume was seen in 33% of patients but the percentage of stage I was not further increased (62%). In both study arms 58% of patients received stage I postoperative therapy. Including non-randomized patients who received four courses of chemotherapy, there was no significant correlation between initial tumor reduction and EFS.

Central pathology review showed an 82% agreement overall, with more discordance relating to unfavorable histology.

### Toxicity

Toxicity was described in all patients receiving 4 weeks preoperative chemotherapy, with hepatic toxicity



		Week																											
Regimen		0	1	2	3	4	5	6	7	8	9	10	11	12	13	14	15	16	17	18	19	20	21	22	23	24	25	26	27
DD-RT	A							D							A						D								A
	RT		V	V	V	V	V	V	V	V	V	V			V	V													V
J			V	V	V	V	V	V	V	V	V				V	V					V	V						V	V
	A							D							A						D							A	
	RT							C							C						C							C	

		Week																			
		28	29	30	31	32	33	34	35	36	37	38	39	40	41	42	43	44	45	46	47
DD-RT						D							A							D	
	RT												V	V							
J						V	V					V	V						V	V	
	A					D						A							D		
	RT					C						C							C		

		Week																		
		48	49	50	51	52	53	54	55	56	57	58	59	60	61	62	63	64	65	66
DD-RT						A						D							A	
	RT					V	V												V	V
J						V	V					V	V						V	V
	A					A						D							A	
	RT					C						C							C	

A, Actinomycin D 15 µg/kg/day × 5 IV  
D, Doxorubicin 20 mg/m<sup>2</sup>/day × 3 IV  
C, Cyclophosphamide 10 mg/kg/day × 3 IV

V, Vincristine 1.5 mg/m<sup>2</sup> IV  
RT, Radiotherapy

**Figure 4.13** Treatment schemas for children with anaplastic Wilms' tumor: regimen DD-RT and regimen J. © American Society of Clinical Oncology (full reference on p. 86).

## Objectives

The main objectives were:

- A retrospective subgroup analysis of centrally reviewed anaplastic tumors in patients <16 years of age.
- To examine the influence of the addition of cyclophosphamide to a combination of vincristine, actinomycin D and doxorubicin (Adriamycin) in patients treated on NWTS-3 (Study 5) and NWTS-4 (Study 6).

## Details of the study

On both studies the same chemotherapy regimens were used. Patients were randomized at presentation to receive either regimen DD with radiotherapy or regimen J, a similar protocol with the addition of cyclophosphamide at 10 mg/kg/day on 3 consecutive days every 6 weeks (Figure 4.13).

Details of the randomization method are not given in the report.

For this study the definition of focal anaplasia was altered from an earlier quantitative definition, which included all cases in which <10% of microscopic fields contained anaplastic nuclear changes. This permitted the inclusion of cases in which anaplasia was widespread throughout the primary tumor, provided the affected cells were sparsely distributed. The new topographic definition required that anaplastic nuclear changes be strictly confined to a specified region of the

primary tumor and absent from the surrounding portion of the lesions.

The outcome measure was relapse-free survival (RFS) and overall survival.

## Outcome

Seventy-two randomized patients were evaluated, 59 with diffuse anaplasia and 13 with focal anaplasia. No information is given on patients with anaplastic pathology who were not included in the randomized study. Thirty-four received regimen DD and 38 regimen J.

The 4-year RFS for regimen DD was 35%, overall survival 38%, and for regimen J 64%, overall survival 61%,  $p \leq 0.03$  and  $p = 0.04$ , respectively. For diffuse anaplasia, RFS for regimen DD was 27% versus regimen J 55%. Individual subgroup by stage contained small numbers, but a non-significant trend was clear for RFS: stage II, regimen DD 40% versus 72% for regimen J; stage III, 33% versus 58%; and stage IV, 0% versus 17%.

No details of any additive toxicity in the more intensive regimen are given.

## Conclusion

Cyclophosphamide is of significant benefit with regard to outcome in anaplastic Wilms' tumor, particularly the diffuse subgroup.

## Study 11

Green DM, Breslow NE, Beckwith JB, Finklestein JZ, Grundy P, Thomas PR, Kim T, Shochat S, Haase G, Ritchey M, Panayotis K, D'Angio GJ. Effect of duration of treatment on treatment outcome and cost of treatment for Wilms' tumour: a report from the National Wilms' Tumour Study Group. *J Clin Oncol* 1998; **16**:3744–51.

The study was carried out between 1986 and 1994 by the National Wilms' Tumour Study Group (NWTS-4).

## Objectives

The study was designed:

- To evaluate the efficacy, toxicity and cost of the administration of different regimens for the treatment of Wilms' tumor, which differed in schedule and duration (see Study 8).

## Details of the study

Patients were aged <16 years of age with Wilms' tumor but full eligibility requirements are not detailed. Patients with stage II–IV favorable histology and stage I–IV clear

cell sarcoma were included. The randomization method was based on a factorial design. The first randomization was between single dose versus fractionated actinomycin D and the second between 6 and 15 months of chemotherapy. The first randomization occurred within 5 days of nephrectomy and required neither final staging nor final histological information. Second randomization was performed approximately 6 months after nephrectomy. The study was powered to detect an 80% increase in relapse rate in the short arm and 95% power,  $\alpha = 0.05$ .

The combinations of chemotherapy and the use of radiotherapy were stage dependent, but patients continued with the initial allocated schedule of actinomycin D.

The main outcome measures were relapse-free and overall survival (RFS and OS, respectively).

## Outcome

Of 3230 patients registered, 1756 were randomized. Sixty-nine patients with anaplastic pathology were excluded from this analysis. Of 1687 randomized, 29 patients relapsed or died before the second randomization, 665 patients had stage I favorable histology or anaplastic histology and were not randomized to receive additional therapy. The second randomization

was refused by patients or physicians in 88 cases. Forty patients had clear cell sarcoma stages I–V and are also not included in the analysis. The report describes the outcome of the 838 assessable patients randomized to the short or long treatments. The influence of actinomycin D schedule has been separately reported.

Patients were divided into low risk, i.e. stage II favorable histology, and high risk, stage III–IV favorable histology. One hundred and ninety low-risk patients were randomized to the short arm and had a 4-year RFS of 84% and OS 96%. One hundred and eighty-seven low-risk patients received the long arm therapy, with 4-year RFS of 88% and OS of 97% (not significant).

In the high-risk group, 232 were randomized to the short arm, with 90% RFS, 94% OS, and 229 received the long arm therapy, with 89% RFS, 94% OS. There was no significant difference between the arms.

## Conclusion

A complex analysis of cost concluded that the cost of treatment on the short arm, with the single dose actinomycin D, was approximately one-half that of those receiving the long arm with fractionated actinomycin D.

## Study 12

Seibel N, Li S, Breslow N, Beckwith B, Green D, Haase G, Ritchey, Thomas P, Grundy P, Finklestein J, Kim T, Shochat S, Kelalis P, D'Angio G. Effect of duration of treatment on treatment outcome for patients with clear-cell sarcoma of the kidney: a report from the national Wilms' Tumour Study Group. *J Clin Oncol* 2004;22:3.

Carried out between 1986 and 1994 by the National Wilms' Tumour Study Group (NWTS-4). This was a subgroup analysis of the main study described in Study 8.

## Objectives

The main objective was:

- To compare drug schedule (conventional standard therapy ST versus pulse intensive chemotherapy PI), and duration (short versus long) in the subgroup of clear cell sarcoma of the kidney entered on NWTS-4.

## Eligibility

As for the main protocol.

This analysis was not planned in the main study so that no numbers were predicted to show differences. This resulted in an imbalance within randomization.

## Study design

The treatment regimens are shown in Figure 4.14.

Chest X-ray, skeletal survey, and CT or MRI of head were required. CT scan of liver was performed if secondary disease was documented.

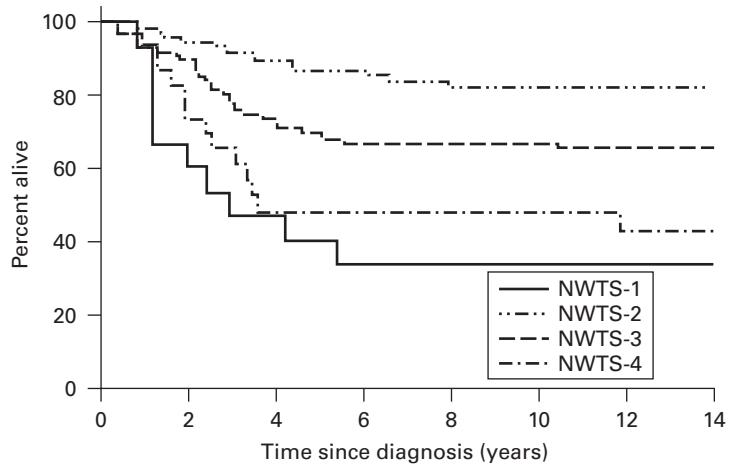
All patients received radiotherapy to tumor bed or abdominal sites and metastases.

## Outcome

Eighty six cases of clear cell sarcoma of the kidney (CCSK) were randomized, 59 male, 27 female. Thirty-five stage I, 21 stage II, 28 stage III and 2 stage IV. One early relapse was excluded from the second randomization, 29 refused randomization and were







**Figure 4.16** Overall survival of patients with clear cell sarcoma of the kidney on National Wilms' Tumor Studies. © American Society of Clinical Oncology (full reference on p. 89).

Compared to the results of CCSK patients in the previous NWTS-3 study there was a significant improvement RFS and overall survival (71% versus 60%, and 83% versus 67%) (Figure 4.16).

### Conclusion

In CCSK there was an improvement in RFS using longer duration chemotherapy but there was no difference in survival.

## Study 13

De Kraker J, Graf N, Van Tinteren H, Pein F, Sandstedt B, Godzinski J, Tournade MF, SIOP. Reduction of post-operative chemotherapy in children with stage I intermediate-risk and anaplastic Wilms' tumour (SIOP 90-01 trial): a randomised controlled trial. *Lancet* 2004;**364**:1229–35.

The study was carried out between 1993 and 2000 by the International Society of Paediatric Oncology (SIOP 93-01).

### Objectives

The main objective was:

- To determine whether postoperative chemotherapy for stage I intermediate risk and anaplastic Wilms' tumor could be shortened from 18 to 4 weeks while maintaining event-free survival.

### Eligibility

Patients from 6 months to 80 years of age were recruited. Chest X-ray was used to stage pulmonary disease and tumor biopsy was not mandatory.

There was central review of all pathology.

Randomization was carried out at three data centers in France, Germany and the Netherlands Study data were held in Amsterdam.

The trial was designed as a non-inferiority study based on the assumption of a 2-year event-free survival (EFS) of 85%. A margin of 10% was allowed,  $\alpha = 5\%$ , one-sided test 80% power. A total of 175 patients per arm were required.

### Study design

All patients recruited to Wilms' Study 9301 received preoperative chemotherapy with vincristine 1.5 mg/m<sup>2</sup>/week × 4 and actinomycin D in three divided doses of 15 (g/kg at 2 weekly intervals).

Surgery was then carried out and those patients shown to have stage I disease and intermediate risk pathology or anaplastic changes were entered on the randomized study (Table 4.1). Pathological staging was

**Table 4.1** SIOP 93-01 staging and histological classification.

---

Stage I: Tumor limited to the kidney, complete excision
Stage II: Tumor extending outside the kidney, complete excision
<ul style="list-style-type: none"> <li>• Invasion beyond the capsule, perirenal/perihilar</li> <li>• Invasion of regional lymph nodes</li> <li>• Invasion of extra-renal vessels</li> <li>• Invasion of ureter</li> </ul>
Stage III: Incomplete excision, without hematogenous metastases
<ul style="list-style-type: none"> <li>• Preoperative biopsy</li> <li>• Preoperative or perioperative rupture</li> <li>• Invasion of extra-regional nodes</li> </ul>
Stage IV: Distant metastases
Stage V: Bilateral renal tumors
Low-risk tumors (favorable)
<ul style="list-style-type: none"> <li>• Cystic partly differentiated nephroblastoma</li> <li>• Nephroblastoma with fibroadenomatous – like structures</li> <li>• Nephroblastoma of highly differentiated epithelial type<sup>a</sup></li> <li>• Nephroblastoma completely necrotic (after preoperative chemotherapy)</li> <li>• Mesoblastic nephroma<sup>b</sup></li> </ul>
Immediate-risk tumors (standard)
<ul style="list-style-type: none"> <li>• Non-anaplastic nephroblastoma with its variants.</li> <li>• Nephroblastoma necrotic but some features left (&lt;10%)</li> </ul>
High-risk tumors (unfavorable)
<ul style="list-style-type: none"> <li>• Nephroblastoma with anaplasia</li> <li>• Clear cell sarcoma of the kidney<sup>b</sup></li> <li>• Rhabdoid tumor of the kidney<sup>b</sup></li> </ul>

---

<sup>a</sup>Variants under investigation during study.

<sup>b</sup>Variants not thought to be nephroblastoma.

based on central review or local results with a later verification. Postoperatively patients received four courses of weekly vincristine and one of actinomycin D, and were then randomized at 9 weeks postoperatively to either two further courses of vincristine, actinomycin D at weeks 10 and 17 or no further treatment.

## Outcome

The 1940 patients were registered on study 9301; 24% of tumors were bilateral or in infants <6 months or patients >18 years and 50% had initial metastases; 1480 were, therefore, eligible. There were 650 with stage I disease whom 410 were randomized; 210 to the standard regimen, 200 to the study regimen. Of those assigned stage I at surgery central review revealed 37 to be stage II. Overall histology concordance was 86%. In 47% of cases where patients were not randomized it was due to parental refusal.

The 378 patients received the correct chemotherapy, 12 switched arms for a variety of reasons. Over 90% received the correct timing and dose of chemotherapy.

At 5-years median follow-up 11% had relapsed and there was one death in remission; 57% of recurrences were in the lung. At 2 years there were 18 events in the standard arm, EFS 91% (87–95%) and 22 events in the study arm EFS 88% (84–93%).

Five-year EFS was 88% versus 87% and overall survival 97% versus 95%, respectively, for standard and study patients. Thus no significant difference. Hematological toxicity was somewhat greater in the prolonged therapy arm with anemia and thrombocytopenia being seen more commonly.

## Conclusion

Shortened duration of chemotherapy maintained effectiveness and could reduce acute and late side effects and inconvenience for patients and parents.

## CHAPTER 5

# Neuroblastoma

*Commentary by Katherine Matthay*

Neuroblastoma, the most common extra-cranial tumor of childhood, remains a challenge among pediatric tumors, despite the astonishing advances seen in the outcome for children with leukemia over the past 25 years. Fifty percent of children with neuroblastoma present with high risk disease at diagnosis, with 5-year survival below 40%, even with intensive multimodal therapy. In addition, late effects of treatment are particularly important in this tumor, where the peak age incidence is at 2 years. Thus, children with this tumor will be exposed to chemotherapy and radiotherapy at a critical period of growth and development, such that survivors will be very susceptible to late effects of treatment, such as orthopedic deformities, growth delay, cardiac and renal dysfunction, hearing loss and second malignancies. Rapid testing of promising therapies and of means to diminish acute and long-term side effects in a randomized fashion has been difficult, due to the relative rarity of this tumor, with only approximately 650 new cases diagnosed yearly in the United States, for an incidence of 9.1 per million children age 0–15 years. This chapter evaluates nine randomized studies that have been completed and published in the past 20 years.

The important hypotheses to test in a randomized fashion for their possible contribution to an improvement of outcome in this disease are (1) increased dose intensity; (2) overcoming drug resistance using agents with new mechanisms of action; (3) local tumor control; (4) detecting and eliminating minimal residual disease and (5) how changes in therapy affect quality of life and late effects. The nine randomized studies summarized in this chapter have addressed the question of dose intensity using autologous hematopoietic cell support (Studies 1, 2 and 8); new non-cross-resistant chemotherapy for induction (Studies 4 and 5); local

control with radiation therapy in stage 3 neuroblastoma (Study 3); use of a differentiating agent for minimal residual disease (Studies 1 and 7) and decreasing acute and late toxicity by adding G-CSF and erythropoietin and by changing the schedule of drug administration (Studies 6 and 9).

### **Dose intensification to overcome resistance to therapy**

The demonstration that hematopoiesis could be restored with autologous stem cells allowed the use of much higher doses of chemotherapy with autologous bone marrow support for treatment of solid tumors. The further advance showing that bone marrow tumor cells could be diminished or eliminated using immunomagnetic purging gave credence to the use of autologous marrow support in neuroblastoma, a tumor which is metastatic to bone marrow in 80% of children with high risk stage 4 disease. Early pilot studies showed that responses were seen in resistant patients after high dose melphalan and bone marrow reinfusion, and many subsequent single arm studies in the United States and Europe verified an apparent improvement in outcome for purged or non-purged autologous bone marrow transplantation (ABMT) compared retrospectively to results for chemotherapy.<sup>1</sup>

Both cooperative pediatric groups in the United States – the Pediatric Oncology Group (POG) and the Children’s Cancer Group (CCG) – attempted statistical non-randomized comparisons of outcome for two concomitant groups of patients treated either with conventional doses of chemotherapy or myeloablative chemotherapy, total body irradiation and purged ABMT with mixed results.<sup>2,3</sup> On the basis of two POG studies, one a surgery plus conventional chemotherapy

study (POG-8441) and the other an elective autologous transplant pilot protocol (POG-8340), there was no significant prognostic benefit of switching in remission from the chemotherapy protocol to the transplant protocol ( $p = 0.91$ ). The analysis was based on 116 patients achieving a complete or partial remission (PR), 32 of whom received transplants on the pilot protocol. The CCG examined the outcome of stage 4 patients under 1 year of age treated with identical induction chemotherapy on a CCG pilot protocol, who then either continued on the same chemotherapy ( $n = 73$ ) for 1 year (CCG-321P2) or proceeded to CCG-321P3, with myeloablative chemotherapy, total body irradiation and purged ABMT ( $n = 94$ ).<sup>3</sup> The decision to use ABMT was non-random and depended on parental, investigator and institutional choice. The analysis was performed using Cox regression for censored failure-time data, treating time to ABMT as a time-varying covariate, and also by Kaplan Meier analysis comparing event-free survival (EFS) from time of ABMT to EFS from 8 months after diagnosis for chemotherapy patients.

The advantage for ABMT versus chemotherapy was significant for the group as a whole, with respective 3-year EFS of 40% versus 19%, different from the finding of Shuster *et al.*<sup>2</sup> The advantage for ABMT was greatest for certain very high risk subgroups, including those under 2 years of age at diagnosis, those with bone or bone marrow metastases, those with *MYCN* gene amplification and those who had only a partial, rather than complete, response to the first four to six cycles of induction chemotherapy.

The European Neuroblastoma Study Group (ENSG) attempted the first randomized study, opened in 1983–1985, using intensive therapy with autologous bone marrow support in neuroblastoma, very shortly after completion of the first pilot phase II studies of high dose melphalan (Study 2). This study was actually a comparison of high dose melphalan compared to no further therapy, and showed a significant advantage in progression-free survival (PFS) for those patients with stage 4 disease over 1 year of age at diagnosis undergoing high dose therapy with bone marrow support.<sup>4,5</sup>

There are several problems, however, in application of these results. First, randomization was performed only for those patients achieving complete or good PR, and was not performed at a uniform time point in relation either to time of diagnosis or number of chemotherapy courses, and occurred between 5 and 9 months

from diagnosis, after six to ten cycles of chemotherapy. Of 72 eligible stage 4 patients with good response, only 52 (72%) were randomized, predominantly due to parental or physician preference. Thus, the applicability of these results is limited, because the group as a whole excludes the highest risk patients, including the 15% who are expected to progress early in the course of induction, and those who show a lesser response at the end of induction (perhaps another 20%), are not included in this study population. Secondly, bias may have been introduced by the high proportion of non-randomized patients and the variation in timing of randomization. Nonetheless, in the recent update of this study, there remains a significant improvement in long-term outcome, both for EFS and overall survival (OS) from the time of randomization, for the children who had stage 4 disease and were over 1 year of age at diagnosis. For the small number of surviving patients with a median follow-up of 14 years, the 5-year EFS for high dose melphalan compared to standard continuation chemotherapy is 33% versus 17%, and for OS, 46% versus 21%.

At the time of publication of preliminary results from this study,<sup>4</sup> the CCG launched the first, large, randomized study comparing high dose chemoradiotherapy with purged ABMT to a new intensive non-myeloablative chemotherapy intensification (Study 1).<sup>6</sup> This study differed from that of the ENSG by performing the randomization much earlier in the course, after only two cycles of chemotherapy, at a time when 95% of the patients were still in the pool. In addition, the transplant group was compared to a very intensive but non-myeloablative consolidation, instead of no further therapy. The study was also much larger, with 190 patients in each randomized group. However, it still had the problem of refusal of randomization, with a randomization rate of 70%. Since ABMT was considered the experimental arm, patients who refused randomization were assigned to the chemotherapy arm, but analyzed separately. The results clearly showed a significant improvement for EFS for the patients randomly assigned to ABMT, both by an intent-to-treat analysis and also by treatment received.

As in the previous CCG non-randomized comparison, the highest risk patients, those with *MYCN*-amplified tumors or those older than 2 years at diagnosis, had the most significant benefit. At the time of the analysis, with a median follow-up of 43 months,

there was no significant difference in survival. Further follow-up will be required to see if high dose therapy with hematopoietic support has truly made an impact on long-term survival in this disease. The other notable finding from this randomized study was that there was no significant difference in the percentage of toxic deaths overall for patients randomized to the two arms, and the hospital days were identical, helping to validate the cost effectiveness of this treatment.

Shortly after the US study was completed, the German cooperative group initiated a randomized study of myeloablative therapy compared to a brief oral maintenance therapy (Study 8).<sup>7</sup> All patients then received therapy for minimal residual disease with 13-cis-retinoic acid and anti-GD2 monoclonal antibody. This was a large study, which entered 339 high risk patients, of whom 295 were randomized, with 149 assigned to megatherapy and 146 assigned to maintenance oral cyclophosphamide. This should have given the study a very good power. However, a number of inadequately controlled variables may have introduced bias. Firstly, the timing of randomization was allowed to occur anywhere from 7 to 224 days after diagnosis. Secondly, large variations in treatment were permitted, ranging from administration of <sup>131</sup>I-MIBG to some of the patients with residual metastases prior to transplant, no specification of surgery timing or whether local radiation was administered, and variability in timing of stem cell collection. The actual chemotherapy conditioning also was changed for some patients. There were also variations in the maintenance chemotherapy regimen, as some of these patients also received <sup>131</sup>I-MIBG, and others received external beam radiotherapy. There were high cross-over rates, with 35 (23%) of the patients assigned to megatherapy actually receiving maintenance chemotherapy and 48 (30%) assigned to maintenance, receiving megatherapy. These inconsistencies may have biased the results, which seem to show that by the intent-to-treat analysis, megatherapy was significantly better than maintenance for EFS, though, as in the CCG study, not significantly better for OS. Nonetheless, the 3-year EFS in the intent-to-treat analysis was 47% (CI 38–55) for the megatherapy group versus 31% (CI 23–39) for the maintenance chemotherapy group, with  $p = 0.022$ . It is interesting to speculate if the apparently higher EFS in both groups on this study may have been due to more aggressive therapy for minimal residual disease, with

both 13-cis-retinoic acid and anti-GD2 antibody, and some patients receiving <sup>131</sup>I-MIBG. However, the answer must await a randomized trial, due to the multiple other differences in treatment, ranging from different hematopoietic stem cell source, different induction and different consolidation therapy.

At present, many investigators are pursuing the strategy of trying to benefit from the further increase in dose intensity obtainable with repetitive high dose myeloablative therapies with stem cell rescue, but a randomized study will be required to verify whether this approach truly improves EFS or survival. Other groups are pursuing the use of further increase in chemotherapy dose intensity by eliminating total body irradiation, and instead using higher doses of chemotherapy and local irradiation. The current cooperative trial in North America in the Children's Oncology Group (COG) is testing increased chemotherapy intensity with only local radiotherapy but no total body irradiation, with a randomization to test the effect of tumor cell purging of peripheral blood stem cells on relapse. The current European trial, HR-ESIOP, is a cooperative randomized study testing two different high dose myeloablative regimens, busulfan with melphalan, compared to carboplatin, etoposide and melphalan. In the future, high dose chemotherapy with the addition of targeted radiotherapy in the form of <sup>131</sup>I-metaiodobenzylguanidine may improve results in resistant tumors.<sup>8</sup>

## Overcoming drug resistance with agents using new mechanisms of action

Since the limit of tissue tolerance has been nearly reached with current cytotoxic agents, even with hematopoietic support new approaches are required to overcome drug resistance, either by targeting therapy specifically to the tumor or by discovering agents that are non-cross-resistant. The active cytotoxic agents added to the regular armamentarium of chemotherapy for neuroblastoma after 1985 have been the platinum compounds, ifosfamide and the inhibitors of topoisomerase, the epipodophyllotoxins (topoisomerase II inhibitors) and most recently the camptothecins (topoisomerase I inhibitors).<sup>9,10</sup> Yet only one randomized study has been done to test the activity of these agents against the previous standard induction

chemotherapy of doxorubicin and cyclophosphamide (Study 4).<sup>11</sup>

This study compared the regimen which was the standard induction at that time when the study began, in 1981 (1050 mg/m<sup>2</sup> cyclophosphamide and doxorubicin, 35 mg/m<sup>2</sup>), to the two newer agents with proven activity, teniposide (100 mg/m<sup>2</sup>) and cisplatin (90 mg/m<sup>2</sup>). There was no significant difference either in response rate or EFS, although the cisplatin regimen had an apparently slightly higher complete remission (CR) plus PR rate. The toxicity was not very different.

The value of this study was actually to show the tolerability and equivalent or better response with the newer agents. This, and other phase II studies using carboplatin with VP-16, led to the use of all four agents together in multiple induction regimens, with modestly improved overall response rates in cooperative studies in advanced neuroblastoma.<sup>6,12</sup>

Further attempts to improve response rate were made in testing new agents in the context of an up-front phase II window (Study 5), rather than in relapsed patients, where resistance is known to develop to many agents.<sup>13</sup> This study showed excellent and almost identical response rates (partial and minor response) of approximately 70% for ifosfamide, carboplatin and iproplatin, but an inferior response rate with epirubicin. The two platinum compounds were assigned in a randomized fashion, whereas the ifosfamide and epirubicin were given to sequential patients. The question of impact of the new drug on eventual outcome was not addressed in this study, although no deleterious effect of using a phase II window was demonstrated by comparing disease-free survival or progression free survival in the group receiving the window therapy or not receiving it. However, as the 2-year PFS was only 40%, it is unknown whether further improvements in survival using combination therapy would result in the group receiving the single-agent phase II window therapy for two courses to have a poorer outcome due to the possible more rapid development of drug resistance. In contrast, the European phase II window study of ifosfamide, given in a slightly different schedule, followed by conventional therapy, showed a lower survival and lower complete response rate for patients receiving the window therapy compared to previous results, despite good activity of the ifosfamide (44% response).<sup>14</sup>

The overall outcome for the two, randomized, continuation chemotherapy regimens in the Castleberry

study has not yet been reported. An adjustment must be made to compare the response rate in the phase II window study reviewed here to previously reported results, since minor responses were included. If one only looks at those with partial response (there were no complete responses), then the response rates were ifosfamide 44%, identical to the up-front results in the European study,<sup>14</sup> carboplatin 54%, iproplatin 35% and epirubicin 17%. These response rates are generally higher than those in heavily pre-treated patients, as one would expect, but it is not clear that new information is gained, since traditional phase II testing also showed activity. The advantage of the phase II window approach is that it gives better information on quantitative response to the single agent in untreated patients, but these agents still then must be tested in a randomized fashion as part of a combination chemotherapy regimen to see if they improve overall response, or, more importantly, survival.

## Local control

Recurrence in the local or regional area of primary disease is a component of relapse in a high proportion of children with high risk neuroblastoma, in rates ranging from 20% to 80% in reports that often include local radiotherapy and myeloablative therapy. There are both single arm studies and the randomized study reviewed here that demonstrate the benefit of local control measures for children with advanced but non-metastatic neuroblastoma,<sup>15</sup> but the impact of local control in stage 4 disease has been mixed,<sup>16-18</sup> possibly also due to problems with control of metastatic disease.

The study of Castleberry *et al.* (Study 3) showed a benefit for the group of children with unresectable neuroblastoma who received radiotherapy.<sup>19</sup> However, this group included both high risk and intermediate risk patients, since no biological markers were reported. There are problems in extrapolating the results of this randomized study, which took 8 years to complete, to current management, because of a chemotherapy regimen that was significantly less dose-intensive than those used currently, and the lack of biological risk factors. Because the protocol opened in 1981, this group only received cyclophosphamide and doxorubicin, without the benefit of platinum compounds or etoposide. Furthermore, the group was heterogeneous in prognosis, since the only risk factors well known at the

time were age and stage. It was shown in a subsequent CCG study that local control by surgery made a significant difference in EFS for stage 3 patients with biological high risk disease, but not those patients with stage 3 disease and favorable biology.<sup>15</sup> However, all patients on the CCG study were treated with four chemotherapy agents, and some of the high risk patients also had myeloablative therapy and ABMT.

Because of the POG study showing benefit from local radiation in incompletely resected tumors, all patients on the CCG study received local radiation for residual tumor. Therefore, no difference was shown in the CCG study for EFS of patients receiving radiation or those not receiving it, since those receiving the radiation were a higher risk group due to their residual disease.<sup>18</sup> Thus, although the study by Castleberry *et al.* showed that radiotherapy in the dose of 24–30 Gy may make a contribution to EFS in loco-regional neuroblastoma, it is unknown whether with more intensive chemotherapy the radiotherapy would have contributed to the EFS. The lessons to be extracted are that randomized studies that take more than 3–5 years to complete are likely to lose their usefulness because of changes in other factors, and that more information from treatment randomization can be obtained in treating biologically homogeneous risk groups.

## Minimal residual disease

Even with intensive myeloablative therapy and hematopoietic stem cell support, relapse occurs in 50% of patients, including many who appear to be in CR at the time of consolidation. This suggests that microscopic viable disease is often present, which may not be entirely eradicated by myeloablative therapy, due to intrinsic resistance or anatomical problems with tumor cell hypoxia or uneven drug delivery. Approaches to this problem have suggested the use of non-cytotoxic therapy and therapy with a different mechanism of action such as immunological or differentiating agents. Study 1 showed that the addition of the differentiating agent 13-cis-retinoic acid, resulted in a significant increase in EFS when administered to patients post-transplant, in a state of minimal residual disease.<sup>6</sup> This study was based on previous data showing that 13-cis-retinoic acid caused differentiation and growth arrest of neuroblastoma *in vitro*,<sup>20</sup> and anecdotal reports of responses in patients and one phase II study.<sup>21</sup>

A phase I study of children with high risk neuroblastoma after bone marrow transplantation found that an intermittent schedule of high dose 13-cis-retinoic acid (using 13-cis-retinoic acid for 14 days consecutively out of every 28 days) had low toxicity and achieved levels known to be effective against neuroblastoma *in vitro*. The maximum tolerated dose was 160 mg/m<sup>2</sup> daily, which achieved peak levels of 7 μM. This schedule had minimal toxicity, achieved levels that were effective against neuroblastoma cell lines *in vitro* and resulted in the clearing of tumor cells in bone marrow, as determined by morphologic assessment, in 3 of 10 patients.<sup>22</sup> Thus, the second part of the CCG-3891 study (Study 1) examined by prospective randomization, the effect of treatment with 13-cis-retinoic acid using the high dose intermittent schedule after maximal reduction of the tumor with the use of chemotherapy, radiotherapy and surgery, with or without transplantation. There was a significant improvement in EFS among children who were given 13-cis-retinoic acid, regardless of the type of prior consolidation therapy. The EFS for the group randomized to 13-cis-retinoic acid (n = 130) was 46%, significantly higher than that of patients randomized to no further treatment (n = 128), at 29% (p = 0.027). The results suggested that 13-cis-retinoic acid is most effective in patients with minimal residual disease, because it did not appear to be effective in patients with proven residual disease who were non-randomly assigned to receive 13-cis-retinoic acid. The greatest effect of 13-cis-retinoic acid in patients with stage 4 neuroblastoma was found among those who had an initial complete response.<sup>6</sup>

In contrast, a European double blind randomized study of low dose continuous 13-cis-retinoic acid given after myeloablative therapy showed no significant impact (Study 7).<sup>23</sup> The most likely reason for the lack of efficacy in the ENSG trial is the low dose employed for 13-cis-retinoic acid. The study was begun in 1989, prior to publication of the data from the *in vitro* studies and the phase I trial that led to the CCG randomized study. The ENSG study was designed using a dose that was approximately 15% of that shown to be the maximum tolerated dose in the phase I study by Villablanca and colleagues.<sup>22</sup> At that lower dose, drug levels would be well below those shown to be effective for sustained growth arrest of neuroblastoma cell lines.<sup>20</sup>

Another possible explanation for the difference in results between the two studies is the somewhat later



start of the 13-cis-retinoic acid in the European trial, at a median of 341 days from diagnosis, compared to an average of 290 days in the CCG study. Beginning 13-cis-retinoic acid relatively soon after cytotoxic therapy, before tumor cells can begin to grow, may be critical for efficacy, since it appears to work best in the setting of minimal residual disease. Although the ENSG study selectively treated only children whose disease was in remission, it is possible that the longer interval from ablative chemotherapy to the use of the differentiating agent allowed regrowth of tumor. The current North American group, the COG, is starting the 13-cis-retinoic acid after myeloablative therapy at an earlier time point, beginning 8 weeks after hematopoietic stem cell transplantation. In an attempt to further minimize minimal residual disease, both the European HR-ESIO trial and the COG trial (ANBL0032) are testing the addition of anti-GD2 antibody to the 13-cis-retinoic acid in a randomized fashion, given after myeloablative therapy.

The induction regimens and myeloablative therapy were treatment center dependent in the Kohler study, leading to a considerable variation in the different therapies given to patients prior to beginning 13-cis-retinoic acid. Furthermore, patient numbers were smaller in the ENSG study relative to the US CCG study. In addition to the above, these issues could have diminished the power of the ENSG study to identify a positive benefit for 13-cis-retinoic acid.

Minimal residual disease in bone marrow by immunocytology was shown, in the CCG protocol (Study 1), to adversely affect outcome. Patients with quantitatively higher tumor content in bone marrow or blood at diagnosis and at the time of bone marrow harvest were shown to have a lower EFS.<sup>24</sup> This suggests that minimal residual disease in bone marrow may be either an important source of relapse or that it is a marker of general tumor resistance.

Recent studies using the polymerase chain reaction techniques for detection of minimal disease have also found that detection of circulating tumor cells at diagnosis or later also correlates with a worse outcome.<sup>25</sup> The CCG study used centralized quality controlled immunomagnetic purging of the autologous bone marrow. This had been used in other studies but not with the methodological improvements shown to eliminate 5 logs of tumor cells with immunocytologic testing before and after.

The contribution to EFS of elimination of residual tumor from the bone marrow graft cannot be determined from Study 1, since purging was performed for all patients. The utility of purging deserves study as a randomized question in the future, given the increase in expense and cell requirement for purging versus the possible benefit by elimination of the minimal residual disease shown to be present in bone marrow and in peripheral blood stem cells using the sensitive RT-PCR technique for detection. The COG protocol (opened February 2001) for high risk neuroblastoma, A3973, is a randomized study of stem cell purging, as well as a prospective study of the impact of minimal residual disease by RT-PCR and immunocytology on EFS.

## Acute and late effects of therapy

Study 6 reports the results for the French Society of Paediatric Oncology of an induction chemotherapy protocol, which included a randomized study of two methods of cisplatin administration.<sup>26</sup> The goal of this randomization was to determine whether changing cisplatin from a 1-hour daily infusion for 5 days to a continuous 5-day infusion of the same total dose would diminish renal or ototoxicity.

A previous European pilot study had shown activity of the high dose cisplatin–etoposide regimen, but an associated high incidence of renal impairment, since 7 of 15 patients developed significant decreases in creatinine clearance.<sup>27</sup> This is of concern both acutely during induction, then for later ability to tolerate myeloablative chemotherapy, and long term, for development of late effects, including renal deficits or ototoxicity. Overall, renal toxicity was lower in both treatment arms than expected, with only 8% of patients in the continuous infusion arm and 18% in the bolus arm having a final creatinine clearance of  $<90$  ml/min/1.73 m<sup>2</sup>, a difference that was not significant. Ototoxicity was also not significantly different on the two arms. Possibly, the toxicity was low due to the relatively low cumulative dose of cisplatin of 400 mg/m<sup>2</sup>. It is stated in the article that response rates to the two regimens were equivalent, with an overall response rate (CRVGPR<sub>PR</sub>) of 74%. However, neither response nor survival data are given for the randomized regimens. It would have been useful to know if the late renal toxicity and ototoxicity

were also similar, as many of these patients went on to receive carboplatin during consolidation.

Future important studies for toxicity and late effects in neuroblastoma should examine second malignancy, which has become increasingly prominent with the use of radiation, high doses of alkylating agents and epipodophyllotoxins during induction and consolidation, as well as radiation. The genetics as well as the incidence could be compared on randomized treatment regimens. New studies to ameliorate renal, cardiac, hematological and otologic toxicity could incorporate randomized addition of chemoprotectants.

## Questions for future studies

The most important questions to address continue to be in the categories above, but with the emphasis on control of both local and late metastatic recurrence. Since dose intensity is close to the limits of tolerance, the emphasis should be either on ways to deliver dose intensity without increasing toxicity, or on agents with new mechanisms of action and on eradication of minimal residual disease. Increased dose intensity in the setting of myeloablative therapy might be accomplished by comparing a repetitive myeloablative consolidation to a single course. Adding agents with new mechanisms of action include comparing standard therapy to therapy with the addition of new immune modulators or new combinations of retinoids or anti-angiogenic agents in combination with chemotherapy. Treatment of minimal residual disease post-myeloablative consolidation will be studied in a randomized fashion both in the ENSG and the COG studies testing the addition of anti-GD2 monoclonal antibody to 13-cis-retinoic acid. The COG study will also test, in a randomized fashion, the contribution of stem cell purging to elimination of minimal residual disease. Optimization of the use of tumor radiation is also important, with a possible randomization of  $^{131}\text{I}$ -MIBG versus external beam therapy, or a radiation dose question. Ways to decrease acute and late toxicity of treatment can also be tested in a randomized fashion, by the addition of chemoprotectants, schedule and dose alterations and substitution of less toxic therapies. Only by timely, cooperative randomized studies will it be possible to verify the contribution of often costly and toxic new therapies to survival in this disease.

## References

- 1 Dini G, Philip T, Hartmann O, *et al*. Bone marrow transplantation for neuroblastoma: a review of 509 cases. EBMT Group. *Bone Marrow Transplant* 1989;**4**(Suppl 4):42–6.
- 2 Shuster JJ, Cantor AB, McWilliams N, *et al*. The prognostic significance of autologous bone marrow transplant in advanced neuroblastoma [see comments]. *J Clin Oncol* 1991;**9**(6):1045–9.
- 3 Stram DO, Matthay KK, O’Leary M, *et al*. Consolidation chemoradiotherapy and autologous bone marrow transplantation versus continued chemotherapy for metastatic neuroblastoma: a report of two concurrent. Children’s Cancer Group Studies [see comments]. *J Clin Oncol* 1996;**14**(9):2417–26.
- 4 Pinkerton CR. ENSG 1-randomised study of high-dose melphalan in neuroblastoma. *Bone Marrow Transplant* 1991; **7**(Suppl 3):112–13.
- 5 Pritchard J, Cotterill SJ, Germond SM, Imeson J, de Kraker J, Jones DR. High dose melphalan in the treatment of advanced neuroblastoma: results of a randomised trial (ENSG-1) by the European Neuroblastoma Study Group. *Pediatr Blood Cancer* 2005;**44**(4):348–57.
- 6 Matthay KK, Villablanca JG, Seeger RC, *et al*. Treatment of high-risk neuroblastoma with intensive chemotherapy, radiotherapy, autologous bone marrow transplantation, and 13-cis-retinoic acid. Children’s Cancer Group. *N Engl J Med* 1999;**341**(16):1165–73.
- 7 Berthold F, Boos J, Burdach S, *et al*. Myeloablative megatherapy with autologous stem-cell rescue versus oral maintenance chemotherapy as consolidation treatment in patients with high-risk neuroblastoma: a randomised controlled trial. *Lancet Oncol* 2005;**6**(9):649–58.
- 8 Matthay KK, Tan JC, Villablanca JG, *et al*. Phase I dose escalation of iodine-131-metaiodobenzylguanidine with myeloablative chemotherapy and autologous stem-cell transplantation in refractory neuroblastoma: a new approach to neuroblastoma Therapy Consortium Study. *J Clin Oncol* 2006;**24**(3):500–6.
- 9 Saylors III, RL, Stewart CF, Zamboni WC, *et al*. Phase I study of topotecan in combination with cyclophosphamide in pediatric patients with malignant solid tumors: a Pediatric Oncology Group Study. *J Clin Oncol* 1998;**16**(3):945–52.
- 10 Vassal G, Doz F, Frappaz D, *et al*. A phase I study of irinotecan as a 3-week schedule in children with refractory or recurrent solid tumors. *J Clin Oncol* 2003;**21**(20):3844–52.
- 11 McWilliams NB, Hayes FA, Green AA, *et al*. Cyclophosphamide/doxorubicin vs. cisplatin/teniposide in the treatment of children older than 12 months of age with disseminated neuroblastoma: a Pediatric Oncology Group Randomized Phase II study. *Med Pediatr Oncol* 1995;**24**(3):176–80.
- 12 Pinkerton CR, Blanc Vincent MP, Bergeron C, Fervers B, Philip T. Induction chemotherapy in metastatic neuroblastoma – does dose influence response? A critical review of published data standards, options and recommendations (SOR) project of the national federation of French cancer centres (FNCLCC). *Eur J Cancer* 2000;**36**(14):1808–15.
- 13 Castleberry RP, Cantor AB, Green AA, *et al*. Phase II investigational window using carboplatin, iproplatin, ifosfamide,

- and epirubicin in children with untreated disseminated neuroblastoma: a Pediatric Oncology Group Study [see comments]. *J Clin Oncol* 1994;**12**(8):1616–20.
- 14 Kellie SJ, De Kraker J, Lilleyman JS, Bowman A, Pritchard J. Ifosfamide in previously untreated disseminated neuroblastoma. Results of Study 3A of the European Neuroblastoma Study Group. *Eur J Cancer Clin Oncol* 1988;**24**(5):903–8.
  - 15 Matthay KK, Perez C, Seeger RC, *et al.* Successful treatment of stage 3 neuroblastoma based on prospective biologic staging: a Children's Cancer Group study. *J Clin Oncol* 1998;**16**(4):1256–64.
  - 16 Adkins ES, Sawin R, Gerbing RB, London WB, Matthay KK, Haase GM. Efficacy of complete resection for high-risk neuroblastoma: a Children's Cancer Group study. *J Pediatr Surg* 2004;**39**(6):931–6.
  - 17 Kushner BH, Wolden S, LaQuaglia MP, *et al.* Hyperfractionated low-dose radiotherapy for high-risk neuroblastoma after intensive chemotherapy and surgery. *J Clin Oncol* 2001;**19**(11):2821–8.
  - 18 Haas-Kogan DA, Swift PS, Selch M, *et al.* Impact of radiotherapy for high-risk neuroblastoma: a Children's Cancer Group study. *Int J Radiat Oncol Biol Phys* 2003;**56**(1):28–39.
  - 19 Castleberry RP, Kun LE, Shuster JJ, *et al.* Radiotherapy improves the outlook for patients older than 1 year with Pediatric Oncology Group stage C neuroblastoma [see comments]. *J Clin Oncol* 1991;**9**(5):789–95.
  - 20 Reynolds CP, Kane DJ, Einhorn PA, *et al.* Response of neuroblastoma to retinoic acid *in vitro* and *in vivo*. *Prog Clin Biol Res* 1991;**366**:203–11.
  - 21 Finklestein JZ, Krailo MD, Lenarsky C, *et al.* 13-cis-retinoic acid (NSC 122758) in the treatment of children with metastatic neuroblastoma unresponsive to conventional chemotherapy: report from the Childrens Cancer Study Group. *Med Pediatr Oncol* 1992;**20**(4):307–11.
  - 22 Villablanca JG, Khan AA, Avramis VI, *et al.* Phase I trial of 13-cis-retinoic acid in children with neuroblastoma following bone marrow transplantation. *J Clin Oncol* 1995;**13**(4):894–901.
  - 23 Kohler JA, Imeson J, Ellershaw C, Lie SO. A randomized trial of 13-cis-retinoic acid in children with advanced neuroblastoma after high-dose therapy. *Br J Cancer* 2000;**83**(9):1124–7.
  - 24 Seeger RC, Reynolds CP, Gallego R, Stram DO, Gerbing RB, Matthay KK. Quantitative tumor cell content of bone marrow and blood as a predictor of outcome in stage 4 neuroblastoma: a Children's Cancer Group Study. *J Clin Oncol* 2000;**18**(24):4067–76.
  - 25 Burchill SA, Lewis IJ, Abrams KR, *et al.* Circulating neuroblastoma cells detected by reverse transcriptase polymerase chain reaction for tyrosine hydroxylase mRNA are an independent poor prognostic indicator in stage 4 neuroblastoma in children over 1 year. *J Clin Oncol* 2001;**19**(6):1795–801.
  - 26 Coze C, Hartmann O, Michon J, *et al.* NB87 induction protocol for stage 4 neuroblastoma in children over 1 year of age: a report from the French Society of Pediatric Oncology. *J Clin Oncol* 1997;**15**(12):3433–40.
  - 27 Hartmann O, Pinkerton CR, Philip T, Zucker JM, Breatnach F. Very-high-dose cisplatin and etoposide in children with untreated advanced neuroblastoma. *J Clin Oncol* 1988;**6**(1):44–50.

# Studies

## Study 1

Matthay K, Villablanca JG, Seeger RC, Stram DO, Harris RE, Ramsay NK, Swift P, Shimada H, Black CT, Brodeur GM, Gerbing RB, Reynolds CP. Treatment of high-risk neuroblastoma with intensive chemotherapy, radiotherapy, autologous bone marrow transplantation, and 13-cis-retinoic acid. *N Engl J Med* 1999;**341**: 1165–73.

The study was carried out between 1991 and 1996 by the American Children's Cancer Group evaluated the role of high dose therapy and the differentiating agent 13-cis-retinoic acid.

### Details of the study

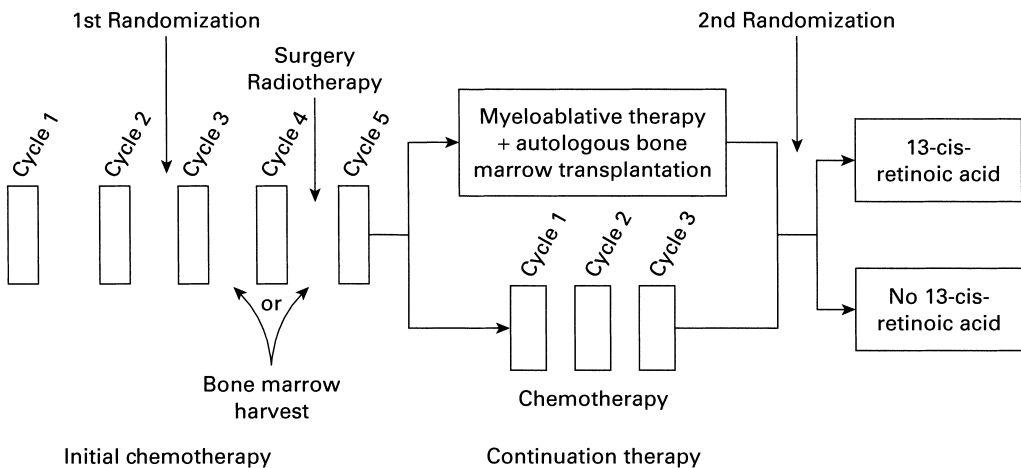
Eligible patients were aged 1–18 years with stage 4 pathology or <1 year with *NMYC* amplification, stage 3 poor risk patients on the basis of *NMYC* amplification, ferritin >143 ng/ml or unfavorable Shimada pathology.

The first randomization was carried out just prior to cycle 3 of chemotherapy at week 8 for all patients

with non-progressive disease. The second randomization followed bone marrow transplant (BMT) or week 34 of the end of continuation (Figure 5.1). Details of the randomization method are not given.

A permuted-block design was used for the random assignment of patients from two stratified groups, those with and those without metastatic disease, to receive transplantation or continuation chemotherapy. The second randomization was similarly balanced with respect to the number of patients from each group of the first randomization and non-randomized patients who were ineligible for transplantation.

Initial chemotherapy consisted of standard dose cisplatin 60 mg/m<sup>2</sup>, doxorubicin 30 mg/m<sup>2</sup>, etoposide 100 mg/m<sup>2</sup> × 2, cyclophosphamide 1 g/m<sup>2</sup> × 2 combination (see Figure 5.1). The patients received five cycles at 28-day intervals. They then received surgery plus local radiation to primary gross residual disease. Those randomized to receive high dose therapy were given carboplatin 1 g/m<sup>2</sup> combined with etoposide 640 mg/m<sup>2</sup> over 3 days with melphalan 210 mg over



**Figure 5.1** Treatment regimens. The conditioning regimen for autologous bone marrow transplantation consisted of carboplatin, etoposide, melphalan and total body irradiation. Adapted with permission from Matthay K *et al.* (full reference above). © 1999 Massachusetts Medical Society.

2 days and total body irradiation  $333 \text{ cGy} \times 3$ . Bone marrow was purged at a centralized purging center, using immunomagnetic separation.

Patients randomized to continuing chemotherapy received cisplatin  $60 \text{ mg/m}^2$ , etoposide  $500 \text{ mg/m}^2$  and doxorubicin  $40 \text{ mg/m}^2$ , all infused over 96 hours, combined with ifosfamide  $2.5 \text{ g/m}^2 \times 4$  doses. This was followed by prophylactic G-CSF. A total of three courses was given.

For the second randomization patients received six courses of cis-retinoic acid  $160 \text{ mg/m}^2/\text{day}$  orally in two divided doses for 14 consecutive days in a 28-day cycle or no further therapy.

The primary end point was event-free survival (EFS) from time of randomization. No details of the anticipated difference between the groups or the required predicted numbers are given.

## Outcome

Five hundred and sixty patients were assessed for the study, of whom 539 were deemed eligible. Ineligibility included patients not of defined high risk, incorrect diagnoses, organ dysfunction and problems with local protocol review boards. Ultimately, 379 patients were randomized for high dose therapy and 258 were randomized for cis-retinoic acid. Overall, the treatment arms were well balanced for clinical features, except that 21% of stage 3 patients ended up in the non-randomized group, compared to 12% in the randomized group, i.e. more patients with lower stage disease refused randomization.

One hundred and ninety patients were allocated to continuing chemotherapy, 189 to high dose therapy. One hundred and eighteen were non-randomly assigned to continuing chemotherapy. The remaining 42 patients never underwent randomization, because of disease progression (16 patients), lack of parental consent (8), physician decision (4) and protocol deviations (11). A total of 128 of 189 received BMT as per protocol, 150 of 190 received the full protocol chemotherapy. Overall, there was 86% compliance if progressive disease is excluded.

Three hundred and nineteen patients completed induction and consolidation or BMT. One hundred and thirty patients were randomly allocated to cis-retinoic acid and 128 to no further treatment. Thirty-seven non-randomized patients were electively assigned to

cis-retinoic acid due to residual disease and 24 declined randomization. Overall, there was 98% compliance with the protocol of the second randomization; two patients in the cis-retinoic group did not receive treatment according to protocol and four in the group assigned to no further treatment received cis-retinoic.

For the whole group of 539 eligible patients the 3-year EFS was 30% and overall survival 45%; for the 379 randomized patients the 3-year EFS was 28%; in the 118 non-randomized patients who received chemotherapy alone it was 33%. In 189 patients randomized to BMT the 3-year EFS was 34%, compared with 22% in the 190 randomized to chemotherapy alone ( $p < 0.03$ ). (Figure 5.2). Overall survival was 43% and 44%, respectively (no significant difference). If only patients who actually received either BMT or continuing chemotherapy are analyzed, the 3-year EFS is 43% and 27%, respectively.

The 3-year EFS (from week 34) for patients receiving cis-retinoic was 46%, compared to 29% for those with no further treatment ( $p < 0.03$ ) (Figure 5.3). Again, overall survival was not significantly different, at 56% and 50%, respectively. If the two study groups are combined, the best outcome was in the 50 patients who received both high dose therapy and cis-retinoic where 3-year EFS was 55% from the time of second randomization. The worst outcome was in the 53 patients receiving standard chemotherapy alone, where 3-year EFS was 18% (Figure 5.4). In the subgroup non-randomly assigned to chemotherapy and then included in the cis-retinoic randomization, there again appeared to be benefit, although non-significant: 53% versus 31% 3-year EFS ( $p = 0.13$ ).

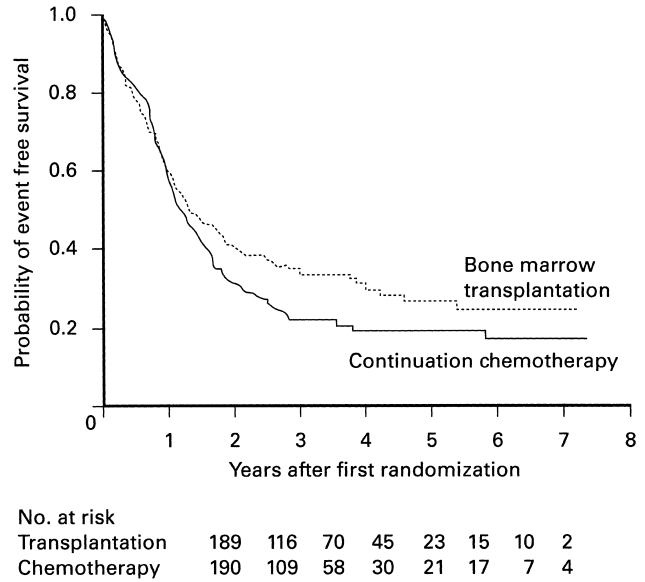
Overall, the EFS for high dose therapy was greater in all prognostic subsets, which was evident on univariate analysis but particularly for those over 2 years of age ( $p < 0.01$ ) and those with MYCN amplification ( $p < 0.03$ ). Cis-retinoic acid was only of significant benefit for those in complete remission at the end of therapy, as opposed to those in partial remission.

If only stage 3 patients are considered, EFS for BMT was 30% versus 20% for chemotherapy alone, and for cis-retinoic 40% versus 25% for no further treatment.

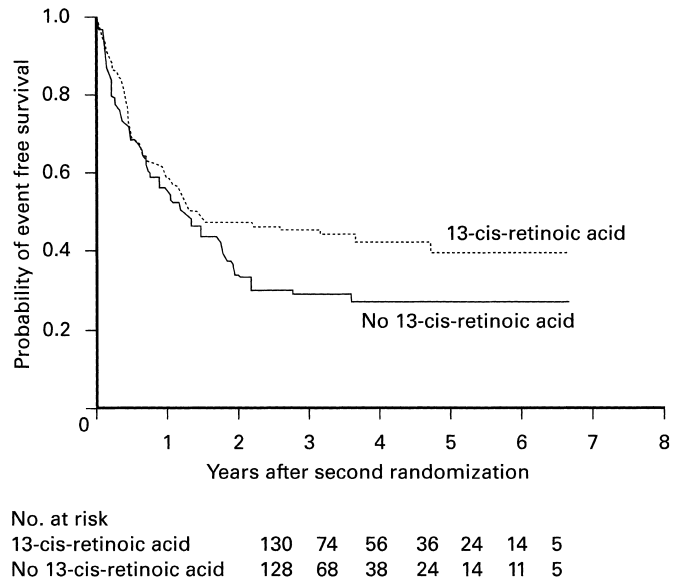
## Toxicity

The toxic mortality in the BMT group was 6% compared to 3% for chemotherapy alone. The incidence of

**Figure 5.2** Probability of EFS among patients assigned to BMT or continuation chemotherapy. Follow-up began at the time of the first randomization (8 weeks after diagnosis). The difference in survival between the two groups was significant at 3 years ( $p = 0.034$ ). Adapted with permission from Matthay K *et al.* (full reference on p. 101). © 1999 Massachusetts Medical Society.



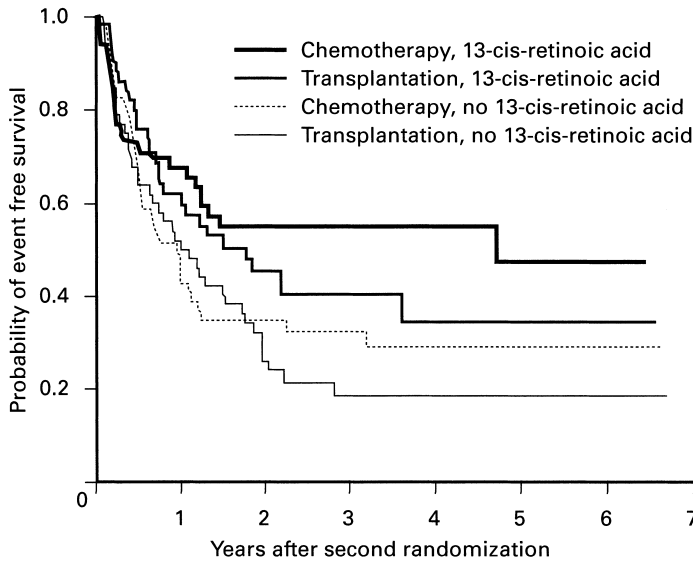
**Figure 5.3** Probability of EFS among patients assigned to receive 13-cis-retinoic acid or no further treatment. Follow-up began at the time of the second randomization (34 weeks after diagnosis). The difference in survival between the two groups was significant at 3 years ( $p = 0.027$ ). Adapted with permission from Matthay K *et al.* (full reference on p. 101). © 1999 Massachusetts Medical Society.



grade 3 or 4 renal toxicity was 8% for chemotherapy versus 18% for BMT. There was a 10% incidence of interstitial pneumonitis and 9% incidence of veno-occlusive disease with high dose therapy. Overall, the hospital stay duration did not differ: median 45 days

for chemotherapy alone compared to 47 days for high dose therapy.

With cis-retinoic acid, 2% of patients had grade 3 or 4 significant skin toxicity and 2% had liver function test abnormalities.



No. at risk							
Transplantation, 13-cis-retinoic acid	50	33	25	13	10	4	1
Transplantation, No 13-cis-retinoic acid	48	28	18	11	6	5	1
Chemotherapy, 13-cis-retinoic acid	52	21	16	12	9	6	3
Chemotherapy, No 13-cis-retinoic acid	53	26	13	7	6	4	2

**Figure 5.4** Probability of EFS in the four randomized groups. Adapted with permission from Matthay K *et al.* (full reference on p. 101). © 1999 Massachusetts Medical Society.

Second malignancy occurred in two patients on study, one randomly assigned to transplantation and the other randomly assigned to continuation chemotherapy. One also occurred in a non-randomized chemotherapy patient.

### Conclusion

Both high dose therapy and cisretinoic acid improve outcome in stage 4 neuroblastoma.

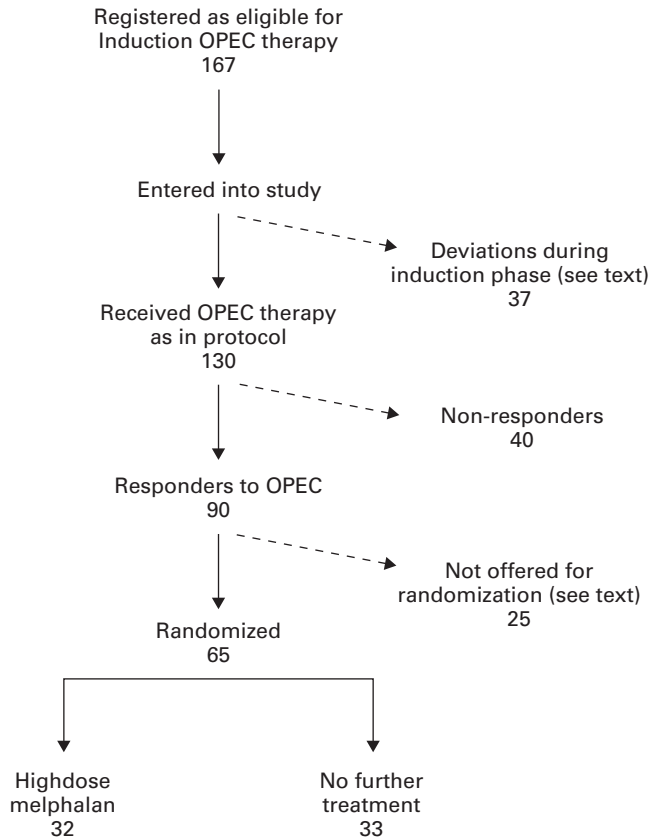
## Study 2

Pritchard J, Cotterill SJ, Germond SM, Imeson J, de Kraker J, Jones DR. High dose melphalan in the treatment of advanced neuroblastoma: results of a randomised trial (ENSG-1) by the European Neuroblastoma Study Group. *Pediatr Blood Cancer* 2005;**44**(4): 348–57.

### Objectives

The study aims:

- To address the issue whether the addition of high dose melphalan improved survival in patients with stage 3 and 4 neuroblastoma who were responding to initial induction chemotherapy.



**Figure 5.5** Flow diagram of the study.

Reprinted from Pritchard *et al.* (full reference on p. 104) with permission from Wiley-Liss, Inc., a subsidiary of John Wiley & Sons, Inc.

The study was carried out between 1983 and 1985 by the European Neuroblastoma Study Group.

### Details of the study

Eligibility included all newly diagnosed patients with Evans' stage 3 or 4 disease aged over 6 months at diagnosis.

Patients received OPEC chemotherapy as induction, with cyclophosphamide at 600 mg/m<sup>2</sup>, vincristine 1.5 mg/m<sup>2</sup>, cisplatin 60 mg/m<sup>2</sup> and VM-26 150 mg/m<sup>2</sup>. If the marrow was in complete remission (CR) after six courses patients proceeded to surgery and then received four further courses of OPEC. At this time, provided the patient was in CR or GPR (good partial remission), they were randomized to either 180 mg/m<sup>2</sup> of high dose melphalan followed by unpurged fresh autologous bone marrow, or no further treatment (Figure 5.5).

Randomization was performed in consenting patients after 6–10 courses of induction chemotherapy, if patients

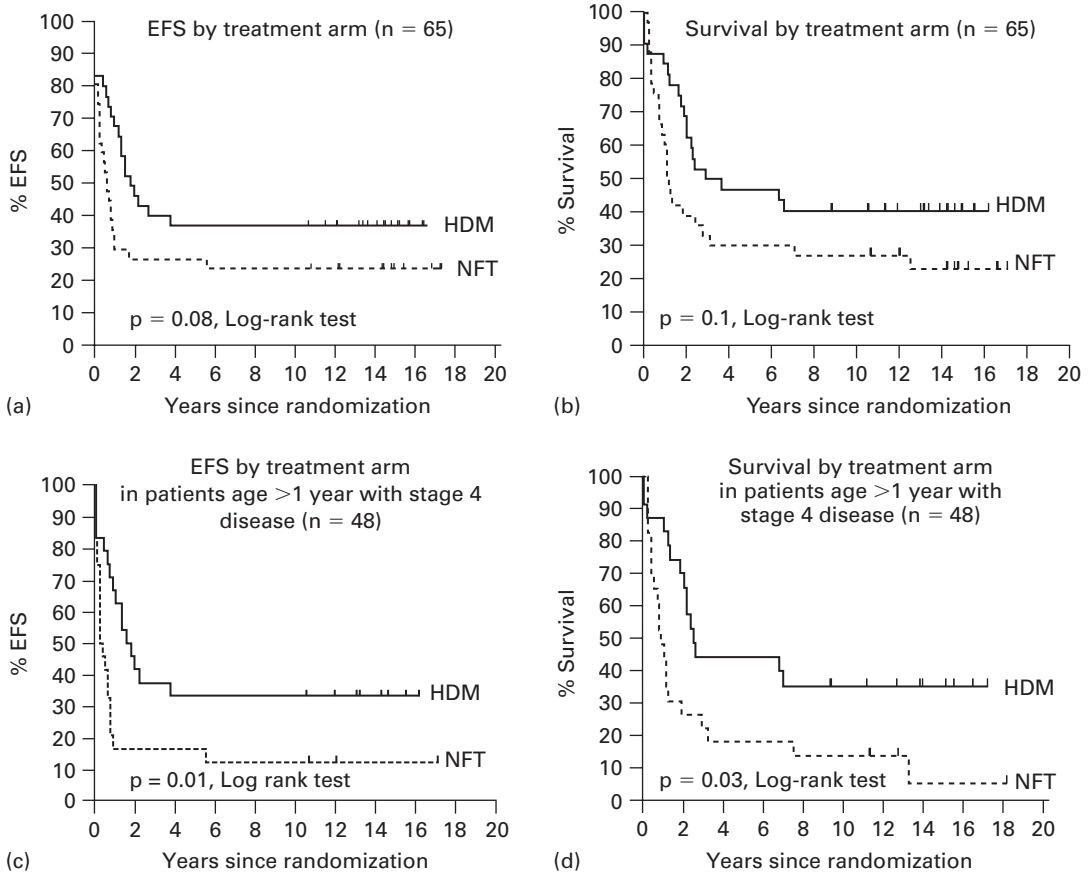
had a complete or very good partial response to therapy. Randomization was performed using a minimization technique using stages 3 or 4 and participating entries as stratification variables. The aim was to randomize 60 patients, with the power of 0.53 to detect an improvement in 2-year survival from 20% to 40%.

The outcome measure was event-free survival (EFS) and overall survival (OS).

### Outcome

One hundred and sixty-seven patients were registered. Of these 90 achieved CR or GPR with induction chemotherapy and surgery, and of these 65 were randomized. Reasons for non-randomization included six early deaths between response evaluation and randomization, and 19 who declined. Of the randomized patients, 32 patients were assigned to high dose melphalan and 33 to no further treatment. The melphalan cohort included 26 with stage 4 and 6 with stage 3





**Figure 5.6** Survival and EFS from randomization to death by treatment groups. HDM: high dose melphalan and NFT: no further treatment (no melphalan). (a) EFS by treatment arm (n = 65); (b) survival by treatment arm (n = 65); (c) EFS by treatment arm in patients aged >1 year with stage 4 disease (n = 48) and (d) survival by treatment arm in patients aged >1 year with stage 4 disease (n = 48). Reprinted from Pritchard *et al.* (full reference on p. 104) with permission from Wiley-Liss, Inc., a subsidiary of John Wiley & Sons, Inc.

disease; the no further treatment group included 26 with stage 4 and 7 with stage 3 disease. Two relapsed prior to high dose melphalan, so only 30 actually received the treatment; there was one toxic death. Analyses of EFS and OS for the 65 randomized patients favored the high dose therapy arm, but was not significant for either EFS or OS. However, when the analysis was restricted to patients with stage 4 disease over 1 year at diagnosis (n = 48), then both outcome measures were significant: EFS (p = 0.01) and OS (p = 0.03) (Figure 5.6).

### Conclusion

It was concluded that high dose melphalan significantly prolonged progression-free survival and survival in patients with stage 4 neuroblastoma greater than 1 year of age at diagnosis, who achieved complete or GPR after remission after induction chemotherapy and surgery.

### Study 3

Castleberry RP, Kun LE, Shuster JJ, Altshuler G, Smith IE, Nitschke R, Wharam M, McWilliams N, Joshi V, Hayes FA. Radiotherapy improves the outlook for patients older than 1 year with Pediatric Oncology Group stage C neuroblastoma. *J Clin Oncol* 1991;9:789–95.

#### Objectives

The study aims:

- To address the role of local radiotherapy in patients with initially unresected stage C disease, i.e. those with complete or incomplete resection of primary tumor, with intracavitary lymph nodes not adhered to primary tumor, which were histologically positive.

This study was carried out between 1981 and 1989 by the Pediatric Oncology Group.

#### Details of the study

Eligible patients were those 1–21 years of age with surgically proven node positivity and no prior chemotherapy or radiotherapy. The precise randomization method is not given in detail.

It was predicted that 64 patients would be required to show a 50% reduction in local relapse for those receiving irradiation (single arm 80% power at 5% level), assuming that there was a 15% 2-year event-free survival (EFS) based on historical data.

After clinical staging all patients had surgery to the primary tumor. The aim of this was to achieve maximum resection without vital organ damage, to search and sample non-adherent lymph nodes and to perform liver biopsy if the primary was in the abdomen. If the tumor was too large for attempted resection, then it was assumed to be lymph node positive.

Patients received five courses of chemotherapy, with cyclophosphamide 150 mg/m<sup>2</sup> orally for 7 days and doxorubicin 35 mg/m<sup>2</sup> on day 8, given at 3 weekly intervals. Patients were randomized to receive local radiotherapy to the tumor plus regional lymph nodes. A dose of 24 Gy was given to those between 1 and 2 years

of age and 30 Gy for those over 2 years of age. For abdominal primaries the field included the thoracic paravertebral and supraclavicular nodes, which were given 18–24 Gy depending on age. All patients had second-look surgery, except those with CT negative initial thoracic primaries. All patients achieving complete remission went on to receive alternating cyclophosphamide/doxorubicin with cisplatin 90 mg/m<sup>2</sup> and VM-26 100 mg/m<sup>2</sup>, two courses of each.

Patients randomized to receive radiotherapy were treated within 3 weeks of initial surgery, concurrently with chemotherapy.

#### Outcome

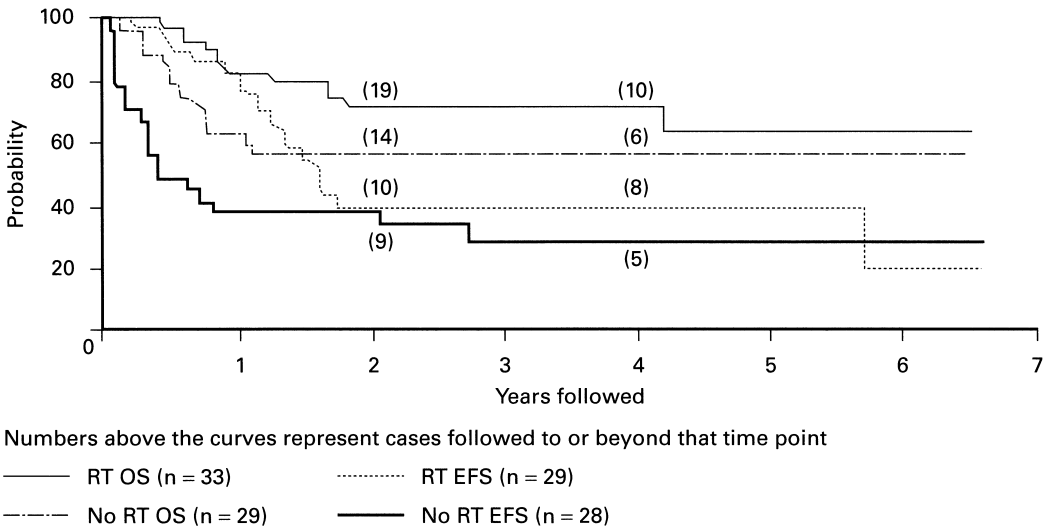
Seventy-four patients were registered, of whom 8 were non-eligible due to diagnostic or staging errors and 4 were not randomized due to clinician decision. Twenty-nine received chemotherapy alone, 33 received chemotherapy plus radiotherapy. Five patients were non-evaluable due to protocol violations. Overall, the arms were balanced for clinical features.

There was a 46% complete response rate for chemotherapy alone, compared to 76% for chemotherapy plus radiotherapy ( $p < 0.01$ ). Nine of 28 patients randomized to chemotherapy remain disease free with a follow-up off therapy of 1–52 months. Relapses occurred in both local (3) and metastatic (1) sites at 1–17 months after stopping treatment. In the combined therapy arm, 17 patients were disease-free at 1–77 months off treatment. Relapses were again seen at local sites alone (1), metastatic sites alone (2) or combined sites (2). All occurred within 2 months of stopping treatment. In the radiotherapy group, only patients having less than 50% resection of primary tumor at diagnosis developed recurrent disease.

The significant difference in survival remained when adjusted for Shimada classification. No biological studies were done (Figure 5.7).

#### Conclusion

It is concluded that local radiotherapy increases the initial complete response rate and reduces subsequent disease relapse.



**Figure 5.7** EFS ( $p = 0.009$ ) and overall survival ( $p = 0.008$ ) for patients  $>1$  year treated with chemotherapy (CT) alone versus identical chemotherapy plus radiotherapy (RT). © American Society of Clinical Oncology (full reference on p. 107).

## Study 4

McWilliams NB, Hayes FA, Green AA, Smith EI, Nitschke R, Altshuler GA, Shuster JJ, Castleberry RP, Vietti TJ. Cyclophosphamide/doxorubicin v. cisplatin/teniposide in the treatment of children older than 12 months of age with disseminated neuroblastoma: a Pediatric Oncology Group randomized phase II study. *Med Ped Oncol* 1995;**24**:176–80.

The study was carried out between 1981 and 1984 by the Pediatric Oncology Group and compared two induction chemotherapy regimens in patients with stage 4 disease.

### Objectives

The study was designed:

- To compare two induction chemotherapy regimens in advanced neuroblastoma.

### Details of the study

Eligible patients were over 1 year of age with Pediatric Oncology Group (POG) stage D disease or Evans stage 4. Patients with dumbbell tumors were excluded from randomization.

Patients were randomized at diagnosis to receive either cyclophosphamide  $150 \text{ mg/m}^2 \text{ PO} \times 7$  doxorubicin  $35 \text{ mg/m}^2$  or cisplatin  $90 \text{ mg/m}^2$ , VM-26 (teniposide)  $100 \text{ mg/m}^2$  (or etoposide  $200 \text{ mg/m}^2$  if allergic reaction). Both were given for a total of five courses prior to assessment of response.

No details of the precise randomization method are given. Complete response (CR) rate and toxicity are compared by two-sided exact unconditional Z-test and event-free survival by log-rank test. The predicted number or details required are not specified.

Outcome measures were remission rate, disease-free survival and CR post-surgery to primary tumor.

### Outcome

Of 157 patients registered, 4 were ineligible (reason not stated) and 13 patients with dumbbell tumors were excluded. The initial CR rate to cyclophosphamide/doxorubicin was 13% compared to 22% for cisplatin/teniposide. CR rate following surgery was 27% versus 34%, respectively. Overall, CR and partial response including surgery was 59% versus 77% ( $p = 0.077$ ). There was no difference in event-free survival – 6% and 3%, respectively at 5 years.

The cyclophosphamide/doxorubicin arm was significantly more myelosuppressive with a lower white cell count ( $p < 0.02$ ). The cisplatin/teniposide produced more nausea and vomiting ( $p < 0.01$ ) and more allergic reactions ( $p = 0.001$ ).

### Conclusion

It was concluded that the cisplatin/teniposide arm appeared to be an effective induction regimen, although overall outcome was very poor.

## Study 5

Castleberry RP, Cantor AB, Green AA, Joshi V, Berkow RL, Buchanan GR, Leventhal B, Mahoney DH, Smith EI, Hayes FA. Phase II investigational window using carboplatin, iproplatin, ifosfamide, and epirubicin in children with untreated disseminated neuroblastoma: a Pediatric Oncology Group study. *J Clin Oncol* 1994; **12**:1616–20.

The study was carried out between 1987 and 1990 by the Pediatric Oncology Group (POG).

### Objectives

A randomized comparison of carboplatin with iproplatin as initial chemotherapy in metastatic neuroblastoma.

### Details of the study

Eligible patients were those aged 1–21 years with POG stage D disease. Normal liver and renal function was required.

Patients were randomly assigned to receive carboplatin  $560 \text{ mg/m}^2$  over 1 hour or iproplatin  $325 \text{ mg/m}^2$  infused over 2 hours. In a separate group of patients, ifosfamide  $2 \text{ g/m}^2$  daily  $\times 4$  was given and a sequential group received epirubicin  $90 \text{ mg/m}^2$ . The reason for allocation of patients to randomized or non-randomized therapy are not stated. With the carboplatin/iproplatin study a second course was given 14–21 days later depending on count recovery.

No details of randomization method are given nor of the predicted difference between arms and numbers required.

Following the accrual of an initial 25 cases within any of the single-agent stratum, the stratum was temporarily closed for analysis and a different stratum was

opened. If five or more complete remissions (CRs) and/or partial remissions (PRs) were noted in the first 21 assessable patients treated with a particular drug, this stratum for that drug was again opened to accrue an additional 25 patients. If less than five CRs and/or PRs were noted in the first 21 patients analyzed, the treatment arm was not opened for secondary accrual. This ensured that with 90% confidence the population CR/PR rate would be no less than 10% below the observed rate.

Following this window comparative study, patients proceeded to the phase III study (POG-8742) in which the efficacy and toxicity of two chemotherapy regimens were compared.

The major end point of the window study was the response to two courses of single-agent therapy. Because it was anticipated there would be few, if any, complete responses after only two courses the number of objective responses, defined as PR plus minor response (MR), was used as a measure of efficacy.

### Outcome

One hundred and seventy-nine patients were eligible. Six were excluded due to diagnostic error, early death or parental reluctance.

In the sequential study, 50 patients received ifosfamide, 23 received epirubicin. In the randomized arm 48 patients received carboplatin, 52 received iproplatin.

The patients in both arms were well balanced for primary site and nature of metastases. There were 26/48 partial responses with carboplatin, compared to 18/52 with iproplatin. The overall objective response rate PR MR was 77% with carboplatin and 67% with iproplatin, i.e. no significant difference. In the sequential arm, the objective response rate was 70% with ifosfamide, 26% with epirubicin.

Ultimately, disease-free survival did not differ in the subsequent phase III study for patients receiving, or not receiving, window chemotherapy.

### Conclusion

Carboplatin and iproplatin had comparable activity in untreated metastatic neuroblastoma.

## Study 6

Coze C, Hartmann O, Michon J, Frappaz D, Dusol F, Rubie H, Plouvier E, Leverger G, Bordigoni P, Cehar C, Beck D, Mechinaud F, Bergeron C, Plantaz D, Otten J, Zucker JM, Philip T, Bernard JL. NB87 induction protocol for stage 4 neuroblastoma in children over 1 year of age: a report from the French Society of Pediatric Oncology. *J Clin Oncol* 1997;15:3433–40.

The study was carried out between 1987 and 1992 by the French Paediatric Oncology Group. This was a single arm study assessing multiagent chemotherapy but it included a randomized comparison of cisplatin scheduling.

### Objectives

The aim of this trial was:

- To compare continuous infusion versus bolus cisplatin in metastatic neuroblastoma.

### Details of the study

Eligible patients were those over 1 year of age with INSS stage 4 disease.

No details of randomization method are given. It was predicted that 44 patients would be needed in each randomized group to detect a reduction from 47% to 20% of decreased creatinine clearance. This was based on the incidence of renal dysfunction documented in the high dose cisplatin/etoposide phase II trial. This would have 80% power at 5% level.

Initial chemotherapy comprised (CADO) cyclophosphamide 1.5 g/m<sup>2</sup>, doxorubicin 60 mg/m<sup>2</sup>, vincristine 1.5 mg/m<sup>2</sup> × 2, alternating with (CVP) cisplatin 200 mg/m<sup>2</sup> divided over 5 days and etoposide 500 mg/m<sup>2</sup> over 5 days. Patients were randomized to receive the cisplatin either as a continuous infusion over 5 days or as a 1-hour bolus infusion.

In this trial there was also a randomization question regarding the use of prophylactic granulocyte colony-stimulating factor (G-CSF) and patients on this study were excluded from the cisplatin schedule randomizations.

Both groups had the same hyperhydration with added potassium chloride and the same post-hydration schedules were given.

Creatinine clearance was used to document renal function and audiometry was done before and after chemotherapy.

### Outcome

Two hundred and eleven patients were registered onto the study. Nine were non-eligible due to prior chemotherapy or performance status, and 10 were excluded due to inadequate data collection. One hundred and eighty-three patients completed induction chemotherapy. Ninety-one patients were randomized on the schedule study: 43 received continuous infusion platinum and 48 bolus. They were well matched for age, sex, primary location, catecholamine increase, MIBG, marrow positivity and other secondary sites. Two patients who were given G-CSF were excluded for hematological evaluation. Three failed to complete the trial due to two early deaths and one progressive disease.

The glomerular filtration rate fell to below 90 ml/min/1.73 m<sup>2</sup> in 8% of those receiving continuous infusion cisplatin, compared to 18% with bolus infusion (difference was not significant). Hearing was maintained at a Brock A level, i.e. none or <40 dB loss at any frequency in 81% of the continuous infusion and 86% of the bolus. Two patients in the bolus regimen had grade C ototoxicity, 3 had grade B; 6 in the continuous infusion had grade B ototoxicity (grade B >40 dB at 8000 Hz, grade C >40 dB at 6000 Hz). No patient had more severe hearing loss. The only significant difference between the two schedules was the degree of neutropenia after the first course of CVP,

with 70% versus 43%, the higher incidence being in those who received continuous infusion ( $p = 0.02$ ). This difference was not seen after the second course of CVP.

### Conclusion

No significant differences were found between the two schedules with the exceptions of more severe neutropenia after course 1 with the continuous infusion.

## Study 7

Kohler JA, Imeson J, Ellershaw C, Lie SO. A randomized trial of 13-cis-retinoic acid in children with advanced neuroblastoma after high-dose therapy. *Br J Cancer* 2000;**83**:1124–27.

The study was carried out between 1989 and 1997 by the European Neuroblastoma Study Group.

### Objectives

The aim of the trial was:

- To establish whether 13-cis-retinoic acid used as continuation therapy after obtaining a good response to conventional chemotherapy could prolong disease-free survival in children with advanced neuroblastoma.

### Details of the study

Eligible patients comprised those with stage 3 or 4 disease of any age who had achieved complete response or very good partial response after induction and consolidation chemotherapy and surgery to the primary site.

Randomization was carried out at the United Kingdom Children's Cancer Study Group (UKCCSG) Data Centre. Method of randomization, difference anticipated or numbers of patients needed are not given in detail. There was no stratification for risk factors.

This was a double blind placebo controlled trial. The dose of 0.75 mg/kg/day of cis-retinoic acid or masked placebo was given with milk or a fatty meal for a total of 4 years, or until disease recurrence. The primary end point was event-free survival.

### Outcome

One hundred and seventy-two patients were recruited on to the study. All received vincristine, carboplatin/

cisplatin, etoposide and cyclophosphamide based regimens, with minor variations on the standard OPEC/OJEC regimen. Radiotherapy was not given routinely and high dose melphalan was recommended for children with stage 4 disease over the age of 1 year and stage 3 disease with MYCN amplification. Some patients received BCNU and VM-26 in addition to melphalan, and in a small number MIBG therapy was used.

High dose therapy was given to 126 patients. The median time to start cis-retinoic acid from diagnosis was 341 days. Eighty-eight patients were randomized to receive retinoic acid and 87 received placebo. Patients were well matched for age (under or over 1 year), complete response, very good partial response, UK center versus non-UK center, stage 3 disease and stage 4 disease.

The 3-year event-free survival for retinoic acid was 37% versus 42% for those on placebo. Adjusting for prognostic factors, such as age, abdominal primary and bone marrow metastases, did not change the lack of difference between the two arms. There was one death due to a second malignancy and one due to a cerebral hemorrhage following autologous bone marrow transplant.

Six patients relapsed before treatment started, within 2 months of randomization. Four patients relapsed within 2 months of randomization but had started treatment. A further 20 patients took treatment for less than 2 months from starting the first course, in 5 because of early relapse, and 15 were unable to take the capsules for a variety of reasons. Compliance with treatment assessed by parental reporting was a problem since the capsules were large and median age at randomization was 3.5 years. Omitting all 30 patients, of whom 15 were taking retinoic acid and 15 placebo, there was still no difference in the outcome between the two randomized groups.

## Toxicity

Treatment was discontinued because of presumed toxicity in 5 cases, one a recurrent skin problem and one bone pain, both on retinoic acid. Two children had eye symptoms, but were found to be on placebo. One who stopped medication because of slow blood count recovery was also on placebo.

Triglyceride and liver enzymes were monitored in 44 patients. They were normal in 35 and abnormal in 9.

## Conclusion

It was concluded that this dose and schedule of retinoic acid did not significantly influence event-free survival.

## Study 8

Berthold F, Boos J, Burdach S, Ertmann R, Henze G, Hermann J, Klingebiel T, Kremens B, Schilling FH, Schrappe M, Simon T, Hero B. Myeloablative megatherapy with autologous stem-cell rescue versus oral maintenance chemotherapy as consolidation treatment in patients with high-risk neuroblastoma: a randomized controlled trial. *Lancet Oncol* 2005;6(9):649–58.

This study was carried out between 1997 and 2002 by the German Society of Paediatric Oncology and Hematology.

## Objectives

This study aims:

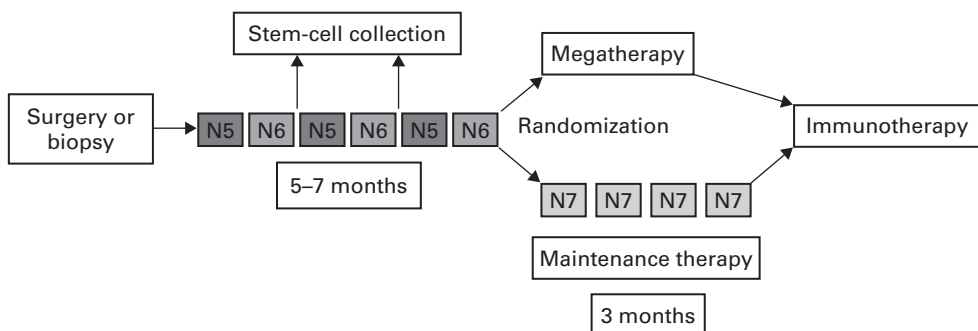
- To compare outcome in patients with high risk neuroblastoma depending on treatment with either myeloablative therapy with autologous stem cell transplantation or oral chemotherapy maintenance.

## Details of the study

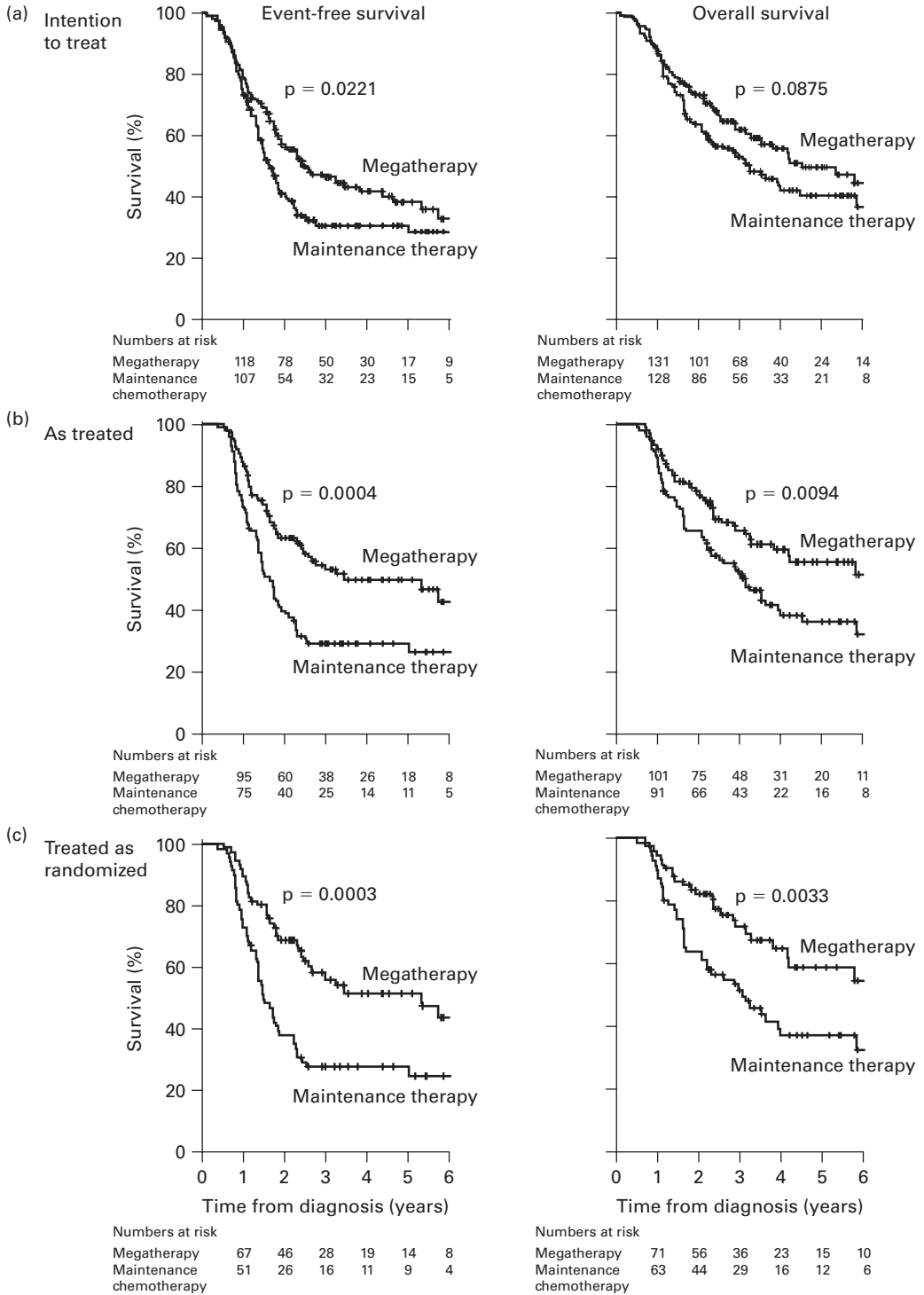
Eligible patients included 339 newly diagnosed patients age 0–20 years with either stage 4 disease over 1 year at diagnosis, or MYCN-amplified tumors with stage 1, 2, 3, 4 or 4S disease of any age.

Randomization was done at a median of 39 days (7–224 days) after diagnosis, with stratification by MYCN, LDH, age 1 to <2 versus  $\geq 2$ . No criteria are given for eligibility for randomization or requirements for the timing of randomization.

The overall treatment schema is shown in Figure 5.8. The induction chemotherapy was prescribed as six cycles of alternating therapy named N5 (cisplatin 40 mg/m<sup>2</sup>/day on day 1–4 continuous infusion, etoposide, 100 mg/m<sup>2</sup>/day on day 1–4 continuous infusion and vindesine 3 mg/m<sup>2</sup> in 1 hour on day 1) and N6 (vincristine 1.5 mg/m<sup>2</sup> IV/1 hour day 1 and 8, dacarbazine 8.2 g/m<sup>2</sup> IV/1 hour days 1–5, ifosfamide 1.5 g/m<sup>2</sup>/day continuous infusion days 1–5, doxorubicin 30 mg/m<sup>2</sup> IV/4 hours days 6 and 7). The timing of surgery to remove the primary tumor was left to the investigator.



**Figure 5.8** Flowchart of treatment. Reprinted from Berthold *et al.* (full reference above) with permission from Elsevier.



**Figure 5.9** EFS and Survival for 295 randomized patients by intent-to-treat, as-treated and treated-as-randomized. Reprinted from Berthold *et al.* (full reference on p. 112) with permission from Elsevier.



The stem cell collection was recommended after three to four cycles of induction, and whenever the bone marrow was clear by four site aspirate with immunocytological and morphological analysis. The myeloablative regimen consisted of melphalan 45 mg/m<sup>2</sup>/day days -8 to -5, etoposide 40 mg/kg/day IV/4 hours day -4, carboplatin IV/1 hour days -4 to -2, with stem cell infusion on day 0. There was considerable variability in the therapy actually administered to patients on the myeloablative arm, since some of those with residual metastatic lesions received therapeutic doses of <sup>131</sup>I-MIBG (n = 26), and others had radiotherapy to the primary tumor (n = 12).

The 3-year event-free survival (EFS) of all 295 patients was 39% [95% CI 33–45] and the 3-year overall survival was 58% [95% CI 52–64]. The median follow-up in the patients alive at the censoring date was

3.57 years (range 1.01–7.02). There was a significant advantage for EFS in the group randomized to myeloablative therapy (intention to treat), and an even greater advantage in the as-treated analysis (Figure 5.8). Subgroup analysis also showed a significant advantage for myeloablative therapy for patients with high LDH at diagnosis and for those with CR/VGPR at the end of induction, while features of MYCN amplification or stage 4 >1 year were of borderline significance in the intent-to-treat group, but significant in the as-treated analysis and in a multivariable analysis (Figure 5.9).

### Conclusion

Megatherapy was significantly better than maintenance therapy in poor risk neuroblastoma.

## CHAPTER 6

# Hepatoblastoma and malignant germ-cell tumors

*Commentary by Ross Pinkerton*

Few randomized studies have been published for either of these tumor types. This reflects the problem that it is difficult, if not impossible, to run such trials in the rarer types of children's cancer. More recently, collaborative groups such as the Children's Cancer Group (CCG) and International Society of Paediatric Oncology (SIOP) have shown that if the question being addressed is of sufficient importance, and the infrastructure exists to support multi-center working, these trials can be done successfully.

Hepatoblastoma (HBL) and malignant germ-cell tumors (MGCT) have a number of common features with regard to the questions that need to be addressed in their management. Both have subgroups in which the prognosis with current treatment strategies is good, namely localized HBL where complete resection is feasible after non-intensive chemotherapy, and MGCT arising in the testis or ovary, where cure rate is high even with lung metastases. For these subgroups it is appropriate to determine whether chemotherapy with fewer early and late sequelae can maintain high cure rates. In contrast, those with non-localized HBL or extra-gonadal MGCT require more intensive treatment to try and improve outcome.

### **Hepatoblastoma**

The CCG trial in HBL (6.1) addressed the issue of whether, in a combination regimen with cisplatin, doxorubicin with its attendant cardiotoxicity could be replaced by 5-fluorouracil/vincristine (5FU/VCR). The conclusion appears to be that this is the case. Unfortunately, the size of the trial was rather small and it is difficult to separate out the different prognostic subgroups.

The outcome in those with metastatic disease was poor in both groups and seems somewhat worse than that published in single arm studies by the German Society for Paediatric Oncology and Haematology and in the SIOPEL-1 study.<sup>1-4</sup>

In SIOPEL-1 the small group of children with initially completely resected tumors had good outcome when given doxorubicin alone as adjuvant therapy. The SIOPEL-2 pilot study has suggested that cisplatin alone as pre-surgical therapy achieves tumor shrinkage and rates of operability comparable to cisplatin/doxorubicin (PLADO). The unpublished randomized study SIOPEL-3 compares these two regimens in children with tumors that are localized to a single lobe, even if large. It is a matter of opinion whether the potential late sequelae of cisplatin alone, i.e. hearing loss and nephrotoxicity, are necessarily more desirable than a comparatively non-cardiotoxic low dose of doxorubicin. This, when given as a single agent can be infused over a 24-hour period with no concern about acute morbidity such as oral mucositis. Future studies in this good-prognosis group could compare the parent compound with either of the less toxic analogs – carboplatin and one of the liposomal anthracyclines.

In the poorer-prognosis group a dose intensification strategy was piloted as part of SIOPEL-2 in a single arm study of "super PLADO" in which carboplatin is combined with cisplatin and doxorubicin. Unfortunately, it was concluded that insufficient numbers could be recruited to carry out a randomized comparison with standard PLADO and this regimen is now incorporated in the single arm SIOPEL-4 study. For this study high-risk patients are defined as those with PRETEXT IV disease, extra-hepatic tumor, lung metastases, low

alfa fetoprotein ( $\alpha$ FP) ( $<100$  IU/ml) and tumor rupture. The outcome will be compared with matched historical controls on previous SIOP studies.

A recent Children's Oncology Group (COG) trial (P9645) has evaluated the possible cardioprotection provided by amifostine when combined with the standard 5FU, cisplatin, vincristine and fluorouracil (CDDP), VCR regimen.

To date, no useful biological prognostic marker has been identified on which to stratify treatment, other than the initial level and pattern of  $\alpha$ -fetoprotein ( $\alpha$ FP) decline, which have been shown to predict outcome.

Chemoembolization has been recently used to try to improve resectability in tumors where standard approaches have failed. This technique should be evaluated further as failure to achieve complete resection remains the main cause of recurrent disease.

Outcome in hepatocellular carcinoma (HCC) remains disappointing and chemotherapy has had a much smaller effect on outcome. Surgical resection remains the mainstay of therapy. The role of intra-hepatic infusion of chemotherapy in HCC is the subject of a randomized study in Kyoto, Japan in which patients are randomized after complete resection to receive either intra-hepatic 5FU, CDDP or no adjuvant therapy.

## Malignant germ-cell tumors

The introduction of cisplatin-based treatment regimens in pediatric MGCT based on effectiveness in adults with testicular tumors had a dramatic effect,<sup>5-8</sup> with outcome superior to the standard vincristine, actinomycin D and cyclophosphamide (VAC) protocol. It is less clear whether regimens with higher doses of both cyclophosphamide or ifosfamide and doxorubicin would have achieved the same result. Subsequently PVB (cisplatin, vinblastine and bleomycin) or BEP (bleomycin, etoposide and cisplatin) regimens became part of standard protocols, although many groups continued to add these drugs to VACA (vincristine, actinomycin D, doxorubicin and cyclophosphamide) based combinations.

The only randomized study in pediatric MGCT that has been completed is the CCG-8882/POG-9049 trial. It did not take account of the good prognosis of those with advanced gonadal and localized extra-gonadal tumors and evaluated dose escalation across a wide range of prognostic subgroups. The study introduced

the high-dose cisplatin Einhorn regimen, which had been shown to have efficacy in relapsed or refractory testicular teratoma. It was clear from earlier studies in metastatic neuroblastoma that this combination would have significant ototoxicity and renal toxicity, which one could argue would not be acceptable in children with already highly curable disease. The results of this study showed a small advantage to the high-dose regimen in terms of relapse-free survival (RFS), but not overall survival (OS). It is difficult to be clear in what specific subgroups the significant toxicity is justified. Further publications have presented subgroup analysis by site but the numbers in each group are too small to draw any further conclusions.

The United Kingdom Children's Cancer Study Group (UKCCSG) has taken the opposite approach and has introduced carboplatin in the carboplatin, etoposide and bleomycin (JEB) regimen to reduce cisplatin toxicity.<sup>9</sup> No alkylating agent or anthracycline is given. Although this has never been evaluated in a randomized trial, the results have been encouraging. It appears important that a relatively high dose of carboplatin ( $500-600$  mg/m<sup>2</sup>) is used, as poorer results have been reported by the French Pediatric Oncology Society (SFOP) group using lower doses than the glomerular filtration rate (GFR) formula base dose method achieves in the UK protocol.

Randomized trials in adults with good-risk testicular teratoma have shown that cisplatin-based chemotherapy provides a small but significant relapse-free advantage. Some of these studies have again used a smaller dose of carboplatin than the UKCCSG. It would seem appropriate that the European and American groups consider a randomized trial to assess the role of carboplatin as there is no doubt about the significant hearing loss seen with cisplatin, particularly in this very young age group. There is also the possibility that cisplatin exacerbates bleomycin lung toxicity. The SIOP group has recently reached a consensus of risk grouping in MGCT which could be applied in such a study. For the poorer-risk groups, such as those with extra-gonadal primaries and high  $\alpha$ FP level, the addition of IVAd (ifosfamide, vincristine, doxorubicin) to PVB requires evaluation.

High-dose chemotherapy with stem cell rescue has been introduced in relapse protocols following practice in adults. To date no adult study has shown any clear benefit, although a number are under way. Whilst

the number of children with relapsed MGCT is relatively small, the high number of failures following second-line therapy means that in a combined international study this issue could be addressed.

## References

- 1 Pritchard J, Brown J, Shafford E, Perilongo G, Brock P, Dicks-Mireaux C, Keeling J, Phillips A, Vos A, Plaschkes J. Cisplatin, doxorubicin and delayed surgery for childhood hepatoblastoma: a successful approach – results of the first prospective study of the International Society of Pediatric Oncology. *J Clin Oncol* 2000;**18**:3819–28.
- 2 Perilongo G, Brown J, Shafford E, Brock P, DeCamargo B, Keeling JW, Vos A, Philips A, Pritchard J, Plaschkes J. Hepatoblastoma presenting with lung metastases: treatment results of the first cooperative, prospective study of the International Society of Paediatric Oncology on childhood liver tumours. *Cancer* 2000;**89**:1845–53.
- 3 Von Schweinitz D, Byrd DJ, Hecker H, Weinel P, Bode U, Burger D, Erttmann R, Harms D, Mildemberger H. Efficiency and toxicity of ifosfamide, cisplatin and doxorubicin in the treatment of childhood hepatoblastoma. Study Committee of the Cooperative Paediatric Liver Tumour Study HB89 of the German Society for Paediatric Oncology and Haematology. *Eur J Cancer* 1997;**33**:1243–9.
- 4 Shafford EA, Pritchard J. Hepatoblastoma – a bit of a success story? *Eur J Cancer* 1994;**30**:1050–1.
- 5 Pinkerton CR, Pritchard J, Spitz L. High complete response rate in children with advanced germ cell tumours using cisplatin-containing combination chemotherapy. *J Clin Oncol* 1986;**4**:194–9.
- 6 Ablin AR, Krailo MD, Ramsay NK, Malogolowkin MH, Isaacs H, Raney RB, Adkins J, Hays DM, Benjamin DR, Grosfeld JL, et al. Results of treatment of malignant germ cell tumors in 93 children: a report from the Children's Cancer Study Group. *J Clin Oncol* 1991;**9**:1782–92.
- 7 Schneider DT, Calaminus G, Reinhard H, Gutjahr P, Kremens B, Harms D, Gobel U. Primary mediastinal germ cell tumors in children and adolescents: results of the German cooperative protocols MAKEI 83/86, 89 and 96. *J Clin Oncol* 2000;**18**:832–9.
- 8 Gobel U, Schneider DT, Calaminus G, Haas RJ, Schmidt P, Harms D. Germ-cell tumors in childhood and adolescence. GPOH MAKEI and the MAHO study groups. *Ann Oncol* 2000;**11**:263–71.
- 9 Mann JR, Raafat F, Robinson K, Imeson J, Gornall P, Sokal M, Gray E, McKeever P, Hale J, Bailey S, Oakhill A. The United Kingdom Children's Cancer Study Group's second germ cell tumour study: carboplatin, etoposide and bleomycin are effective treatment for children with malignant extracranial germ cell tumours, with acceptable toxicity. *J Clin Oncol* 2000;**18**:3809–18.

## Study 1

Ortega JA, Douglass EC, Feusner JH, Reynolds M, Quinn JJ, Finegold MJ, Haas JE, King DR, Liu-Mares W, SENSEL MG, Drailo MD. Randomized comparison of cisplatin/vincristine/fluorouracil and cisplatin/continuous infusion doxorubicin for treatment of pediatric hepatoblastoma: a report from the Children's Cancer Group and the Pediatric Oncology Group. *J Clin Oncol* 2000;18:2665–75.

This study was carried out by the combined Pediatric Oncology Group and Children's Cancer Group (POG-8945, CCG-8881) between 1989 and 1992.

### Objectives

The study was designed:

- To determine whether the potentially more toxic combination of cisplatin/doxorubicin was more effective than cisplatin/vincristine/5FU in hepatic cancers. Data from hepatoblastoma only are presented here.

### Details of the study

Eligibility included all those under 21 years of age with untreated hepatoblastoma (HBL) or hepatocellular carcinoma (HCC). There was central pathology review. Normal creatinine clearance or glomerular filtration rate (GFR) and normal cardiac function on echocardiogram or scan were required.

Patients were randomized immediately after surgery and staging and were stratified by stage. No other details of randomization method are given.

Patients with stage I favorable histology, defined as pure fetal histology with minimal mitoses, were excluded from randomization and electively given four doses of doxorubicin. It was calculated that 144 patients would need to be randomized to detect a 1.8-fold reduction in event risk between the two treatment arms, using a two-sided test with 80% power at the 0.05 level. This would require a 3-year accrual with an 18-month

interim analysis that required a significant difference,  $p = 0.005$ , to close prematurely.

Stage I was complete resection with clear margins; stage II gross total resection with microscopic residue; stage III gross resection with nodal involvement or tumor spill or incomplete resection with gross residual intra-hepatic disease; stage IV metastatic disease with either complete or incomplete resection.

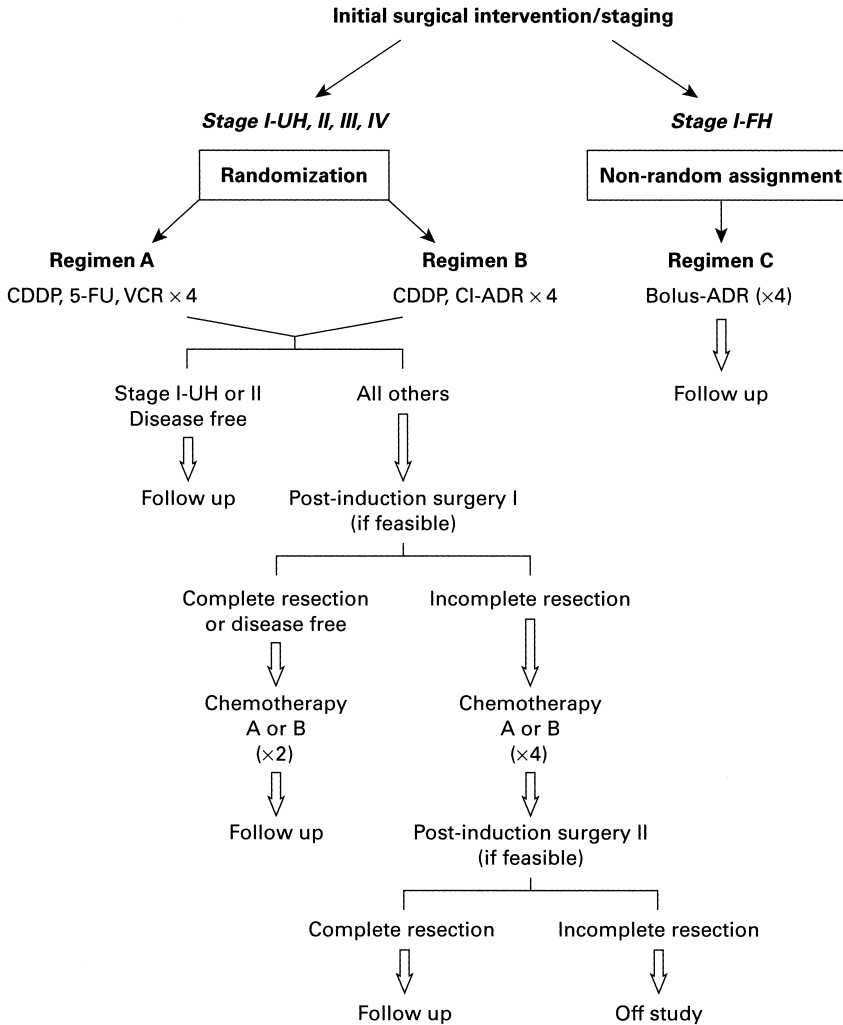
Regimen A comprised cisplatin 90 mg/m<sup>2</sup> infused over 6 hours, vincristine 1.5 mg/m<sup>2</sup> and 5FU 600 mg/m<sup>2</sup>. Regimen B was also cisplatin 90 mg/m<sup>2</sup>, with doxorubicin (Adriamycin) 60 mg/m<sup>2</sup> continuous infusion over 72 hours. All patients received four cycles of either regimen and then subsequent treatment depended on the response and surgical feasibility (see Figure 6.1).

Initial chemotherapy was delayed 2 weeks if more than 50% of the liver was resected. The cycles were given 3 weekly if the count had recovered to neutrophils greater than or equal to 1000 cells/ $\mu$ l and platelets greater than or equal to 100,000 cells/ $\mu$ l. The doxorubicin dose was modified in relation to liver function tests, as was the dose of cisplatin in relation to GFR. Doses were also reduced if there was a delay in the time of chemotherapy.

The primary outcome measure was event-free survival (EFS).

### Outcome

Two hundred and forty-two patients were entered. One patient, who had stage I disease with unfavorable histology, was incorrectly given regimen C, i.e. doxorubicin alone, and was excluded. Ten patients were excluded owing to incorrect pathological diagnoses and three further patients were excluded due to local review board issues or prior chemotherapy. Two hundred and twenty-eight patients remained, of whom 182 had HBL and 46 HCC; 9 received regimen C. Of the remaining 173 patients, 43 were classed as stage I unfavorable histology, 83 stage III and 40 stage IV. Ninety-two were randomized to regimen A and 81 to regimen B.



**Figure 6.1** Treatment regimen for intergroup study (5-FU: 5-fluorouracil; ADR: doxorubicin; CDDP: cisplatin; CI: continuous infusion; FH: favorable histology; UH: unfavorable histology and VCR: vincristine). © American Society of Clinical Oncology (full reference on p. 118).

Five-year EFS was 57% ( $\pm$ SD 5%), overall survival (OS) 69% ( $\pm$ 5%). For regimen B, EFS 69% ( $\pm$ 5%), OS 72% ( $\pm$ 5%),  $p = 0.09$  (see Figure 6.2). Although no statistical difference was observed in EFS, the disease progression rate at 4 years was significantly higher for regimen A (39%) compared to regimen B (23%) ( $p = 0.02$ ).

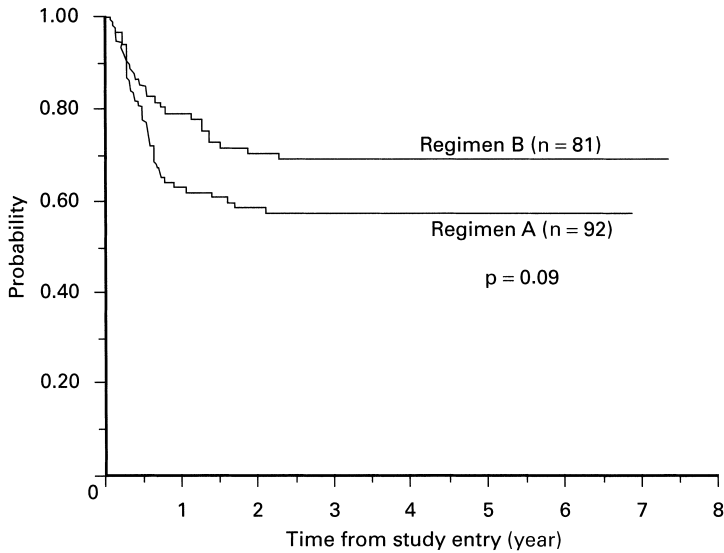
### Toxicity

The toxicity for regimen B was significantly worse with regard to myelosuppression, stomatitis, cardiac

toxicity and renal toxicity. Significantly more total parenteral nutrition was required and the hospital stay was longer (median 46 versus 20 days). Rates of infection were, however, no different. There were three toxic deaths on regimen A and five toxic deaths on regimen B.

### Conclusion

It was concluded that cisplatin doxorubicin was more toxic but produced a higher disease free progression rate.



**Figure 6.2** EFS for children with HBL according to regimen. © American Society of Clinical Oncology (full reference on p. 118).

## Study 2

Katzenstein H, Krailo M, Malogolowkin M, Ortega J, Qu W, Douglass E, Feusner J, Reynolds M, Quinn J, Newman K, Finegold M, Haas J, Sensel M, Castleberry R, Bowman L. Fibrolamellar hepatocellular carcinoma in children and adolescents. *Cancer* 2003;**15**:2006–12.

This study was carried out between 1989 and 1992 by the Paediatric Oncology Group and Children's Cancer Study Group – Pediatric Intergroup Hepatoma protocol INT 0098.

### Objectives

This study aims

- To sub-analyze patients with hepatocellular carcinoma (HCC) treated in a randomized study
- To compare cisplatin 5FU vincristine with cisplatin doxorubicin in children with hepatoblastoma or HCC.

### Eligibility

Eligibility was less than 21 years of age with untreated hepatoblastoma or HCC included Stages I–IV as defined:

Stage I: Complete microscopic resection with clear margins.

Stage II: Microscopic total resection with microscopic residual disease at the margins of resection.

Stage III: Microscopic total resection with lymph node involvement or tumor spill or incomplete resection with microscopic residual intra-hepatic disease.

Stage IV: – Metastatic disease with other complete or incomplete resection on biopsy.

There was central review of pathology and staging. Randomization method and site are not described. Details of difference expected power or number required were not described but the numbers were too small to make any difference likely to be detected.

Randomized study design as shown in Figure 6.1.

### Outcome

Forty-six patients with HCC were included; 10 had fibrolamellar HCC. Significantly more of these were over 10 years old and 90% had a low alpha fetoprotein (<20,000) compared to 18% of other histologies.

Eight were stage 1, 25 stage 3 and 13 stage 4. Event-free survival (EFS) in these groups was 75%, 8% and 0%, respectively.

Overall 5-year EFS was  $17 \pm 6\%$ . Outcome did not differ with regard to histology or between the chemotherapy regimens.

## Conclusion

Children with initially resected HCC have a good prognosis irrespective of histological type whereas outcome

is uniformly poor for children with advanced stage disease. No conclusion could be drawn about the use of different chemotherapy regimens.

## Study 3

Cushing B, Giller R, Cullen J, Marina N, Lauer S, Olson T, Rogers P, Colombani P, Rescorla F, Billmire D, Vinocur C, Hawkins E, Davis M, Perlman E, London W, Castleberry R. Randomised comparison of combination chemotherapy with etoposide, bleomycin and either high-dose or standard dose cisplatin in children and adolescents with high-risk malignant germ cell tumours: a paediatric intergroup study – Paediatric Oncology Group 3049 and Children's Cancer Group 8882. *J Clin Oncol* 2004;22:2691–700.

This study was carried out between 1990 and 1996 by the Paediatric Oncology Group and Children's Cancer Group (Paediatric Intergroup study).

## Objectives

The main objective of the study was:

- To determine whether dose escalation of cisplatin in combination with etoposide and bleomycin improves event-free survival and survival in high-risk malignant germ-cell tumors (MGCT).

## Eligibility

Patients with extra-cranial MGCT less than 21 years of age. Stage III or IV gonadal tumors or stages I–IV extra-gonadal tumors (Table 6.1). Relapsed resected stage I disease or recurrent immature or benign teratoma.

There was central review of all pathology. The presence of malignant elements was a prerequisite, i.e. yolk-sac, embryonal carcinoma, choriocarcinoma and dysgerminoma.

Patients were stratified by state, site, metastases and randomization balanced one to one for age, marker and treatment. Randomization, method or site were not described. No details of the required number or predicted difference were given.

Staging of tumors was shown in Table 6.1.

## Study design

Those with testicular disease had radical orchiectomy and also resection of nodes if CT positive. For ovarian disease there was bilateral oophorectomy and de-bulking of all nodal or retroperitoneal disease.

Baseline lung function and renal function studies were done. There was no central review of audiological data.

Chemotherapy consisted of bleomycin 15 units/m<sup>2</sup> day 1, etoposide 100 mg/m<sup>2</sup> days 1–5 and cisplatin was randomized between 40 mg/m<sup>2</sup> daily × 5 versus 20 mg/m<sup>2</sup> daily × 5. Chemotherapy was given every 21 days. Children under 12 months of age had doses based on weight. Patients were evaluated after four courses of chemotherapy. Those achieving a complete remission (CR) stopped chemotherapy, the others proceeded to surgery. If there was pathological CR then no further treatment was given otherwise two further courses. Progressive disease, in terms of marker increase or greater than 25% tumor growth, resulted in the patient being taken off study.

## Outcome

Three hundred and seventeen patients were enrolled. Eighteen were excluded; 8 due to wrong pathology, 5 consent missing, 2 wrong stage, 2 randomization refused and 1 received prior therapy.

Sites of disease were testis 60, ovary 74, extra-gonadal 165; 10% were stage I and II, 45% stage III and 45% stage IV.

Pathology was yolk-sac tumor 65%, mixed 20%, germinoma 10% and choriocarcinoma 3%.

One hundred and forty-nine were randomized to high-dose platinum and 150 to standard-dose platinum.

There was a significant event-free survival (EFS) advantage for those receiving high-dose platinum, 6-year EFS 90% ± 4 versus 80 ± 5,  $p = 0.028$ . There was



**Table 6.1** Staging of testicular, ovarian and extra-gonadal tumors.*Testicular*

- |     |  |
|-----|--|
| I   | Limited to testis, completely resected by high-inguinal orchiectomy; no clinical, radiographic, or histologic evidence of disease beyond the testis; tumor markers normal after appropriate half-life decline; patients with normal or unknown markers must have negative ipsilateral retroperitoneal lymph node sampling to confirm stage I disease |
| II  | Transcrotal orchiectomy; microscopic disease in scrotum or high in spermatic cord (<5 cm from proximal end); retroperitoneal lymph node involvement (<2 cm) and/or increased tumor markers after appropriate half-life decline   |
| III | Tumor-positive retroperitoneal lymph node(s) >2-cm diameter: no visceral or extra abdominal involvement  |
| IV  | Distant metastases that may include liver  |

*Ovarian*

- |     |  |
|-----|--|
| I   | Limited to ovary peritoneal washings negative for malignant cells; no clinical, radiologic or histologic evidence of disease beyond the ovaries (gliomatosis peritoneal did not result in upstaging); tumor markers positive or negative |
| II  | Microscopic residual or positive lymph nodes (<2 cm); peritoneal washings negative for malignant cells (gliomatosis peritoneal did not result in upstaging); tumor markers positive or negative  |
| III | Gross residual or biopsy only, tumor-positive lymph node(s) > 2-cm diameter; contiguous visceral involvement (omentum, intestine, bladder); peritoneal washings positive for malignant cells   |
| IV  | Distant metastases that may include liver  |

*Extra-gonadal*

- |     |   |
|-----|---|
| I   | Complete resection at any site, coccygectomy included as management for sacrococcygeal site, negative tumor margins |
| II  | Microscopic residual; lymph nodes negative  |
| III | Gross residual or biopsy only; regional lymph nodes negative or positive  |
| IV  | Distant metastases that may include liver   |

no difference in overall survival (92% versus 86%) (see Figures 6.3 and 6.4).

Survival outcome by site was testes 90%, ovary 95%, and extra-gonadal 80% at 6 years. Poor-prognostic factors were mediastinal primary,  $\alpha$ FP > 10,000 and  $\beta$ HCG > 5000.

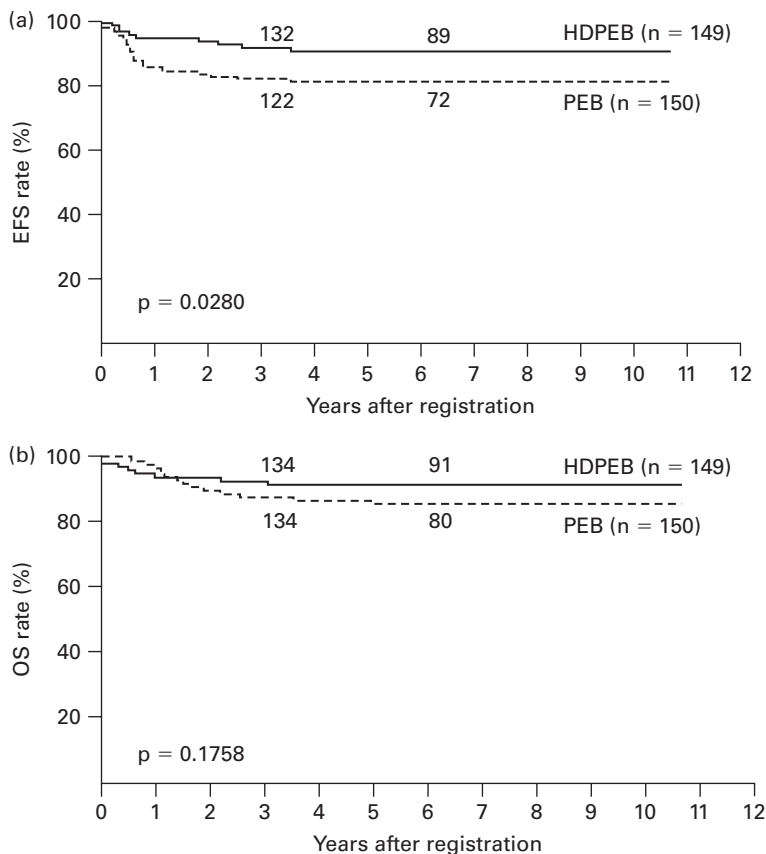
**Toxicity**

Comparing high dose versus standard dose there was reduced creatinine in 7% versus 0%, hypo-magnesium 13% versus 0%, objective hearing loss 14% versus 0%; 67% were reported to have required hearing aids in the high-dose arm.

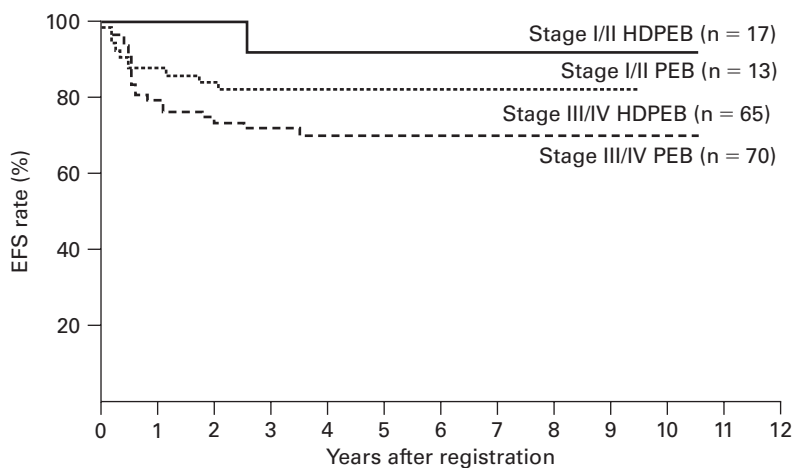
**Conclusion**

There was an improvement in event-free survival which is particularly noted in stage III and IV extra-gonadal tumors. Overall, there were 4 relapses in the high-dose arm versus 20 in the standard dose. Excessive toxicity in the high-dose arm reduced benefit and also makes this approach unacceptable in the context of a high cure rate.

There were two cases of acute myeloid leukemia in those with mediastinal disease. Neither tumor had 11q23 abnormalities. There were seven infection-related deaths, six in the high-dose arm.



**Figure 6.3** (a) EFS curves by treatment group: high-dose cisplatin (HDPEB, n = 149) versus standard-dose cisplatin (PEB, n = 150; p = 0.0284). (b) Overall survival (OS) curves by treatment group: high-dose cisplatin (HDPEB, n = 149) versus standard-dose cisplatin (PEB, n = 150; p = 0.1756). © American Society of Clinical Oncology (full reference on p. 121).



**Figure 6.4** EFS curves for extra-gonadal MGCT by stage and treatment group: stage I and II patients treated with high-dose cisplatin (HDPEB, n = 17) versus stage I and II patients treated with standard-dose cisplatin (PEB, n = 13) versus stage III and IV patients treated with HDPEB (n = 65) versus stage III and IV patients treated with PEB (n = 70). © American Society of Clinical Oncology (full reference on p. 121).

The following three additional publications reported the outcome in specific subgroups but do not provide any additional information regarding the outcome of randomized arms:

- 1 Billmire D, Vinocur C, Rescorla F, Colombani P, Cushing B, Hawkins E, London WB, Giller R, Lauer S. Malignant mediastinal germ cell tumours: an intergroup study. *J Pediatr Surg* 2001;**36**:18–24.
- 2 Billmire D, Vinocur C, Rescorla F, Colombani P, Cushing B, Hawkins E, David M, London WB, Lauer S, Giller R, Children's Oncology Group. Malignant retroperitoneal and abdominal germ cell tumours: an intergroup study. *J Pediatr Surg* 2003;**38**:315–8.
- 3 Rescorla F, Billmire D, Stolar C, Vinocur C, Colombani P, Cullen J, Giller R, Cushing B, Lauer S, Davis M, Hawkins E, Shuster J, Krailo M. The effect of cisplatin dose and surgical resection in children with malignant germ cell tumours at the sacrococcygeal region: a paediatric intergroup trial (POG 9049/CCG 8882). *J Pediatr Surg* 2001;**36**:12–7.

## CHAPTER 7

# Medulloblastoma

*Commentary by Joann Ater*

Medulloblastoma is one of the more common brain tumors in childhood, accounting for about 20% of CNS system tumors in children less than 21 years old. While it does occur in adults, the peak incidence is in early childhood. Despite the frequency, it is still a relatively rare tumor for performing clinical trials. Only approximately 300 cases of medulloblastoma are diagnosed in the United States each year.

In its narrowest definition, it is a highly malignant neoplasm that originates in the vermis of the cerebellum and roof of the IVth ventricle and because of its contiguity with the pia frequently enters the cerebrospinal fluid (CSF) and metastasizes to all regions of the CSF space. In many clinical trials, the *supratentorial* primitive neuroectodermal tumor (PNET) has been included because of its similar microscopic appearance.<sup>1</sup> However, more information has evolved based on the cytogenetic abnormalities present in medulloblastoma and not present in supratentorial PNETs (gain of chromosome 17q).<sup>2</sup> Hence, whether supratentorial PNETs are included in a trial, and if so whether or not a randomized trial includes stratification of this subset, is important.

The treatment of medulloblastoma in children has clearly improved over the past 10–15 years, albeit many patients still succumb to the disease, and in most patients therapy-related morbidity is not acceptable. Considerable diagnostic, prognostic and therapeutic information has been gained from phase II clinical trials and randomized phase III trials presented in this chapter.

### **Prognostic factors**

Advancement in the care of children with medulloblastoma was also made with the identification of prognostic

factors to help identify those patients who might best benefit from chemotherapy. In 1985 a group met in Niagara, NY and established criteria and definitions for response and relapse in children with brain tumors.<sup>3</sup> This group proposed using the Chang staging system for medulloblastoma, first proposed by Dr. Chang in 1969. The Chang staging system utilized both T (tumor) staging, which quantified the size and extent of tumor at diagnosis, and M (metastatic) staging, which identified extent of CNS and systemic metastases. With this system, those children with metastatic medulloblastoma (M1–M4) or high T stage (T3 and T4) had a worse survival with radiotherapy. The Chang staging system was used with variations in the randomized studies described in this chapter to divide children with medulloblastoma into average risk and average risk groups. When reviewing these studies, one must be aware that the definitions of average (or low risk) and high risk were not identical, thus making comparisons between studies difficult. Recently, several groups of investigators have proposed combining gene expression profiles and the clinical parameters of the Chang system into new risk stratifications.<sup>4,5</sup> These systems will require verification in prospective studies before they will be used to stratify patients on randomized studies.

### **Surgery**

The role of surgery is undeniable, not only for therapeutic benefit but also in establishing the correct diagnosis and stage. Moreover, the beneficial effects of both radiotherapy and chemotherapy are largely dependent, when possible, on surgical debulking of disease to enable maximum benefit from the other treatment modality(ies). What seems remarkable is how long it

took to demonstrate that prognosis after surgery is dependent on the degree of surgical resection, an observation that had been made years earlier in other types of brain tumors, particularly the gliomas. The difficulty in demonstrating the benefit of surgery on ultimate survival was probably due to the more difficult surgery in patients of younger age and in a location near the brain stem, and the propensity of CSF dissemination and a higher proportion of patients with metastases at diagnosis. Also, the conundrum of whether the improved prognosis is due to the extent of surgical resection *per se* or to the intrinsic nature of the tumor that makes it more resectable and is thereby independent of the operative intervention may apply more to medulloblastoma than to other brain tumors. Nonetheless, the recent phase III trials provide at least circumstantial evidence that the completeness of the primary surgery is of benefit and should be accomplished without increasing the rate of intra- or postoperative mortality or unacceptable morbidity.

## Radiotherapy

As early as 1926 Bailey and Cushing recognized that, following surgery alone, medulloblastoma was uniformly fatal within a year unless craniospinal radiation was applied postoperatively. Radiotherapy of the entire neuroaxis (craniospinal), as opposed to cranial alone, was recognized as important because of the contiguity of the site of origin of most medulloblastomas with the CSF space and the high propensity for meningeal dissemination, including the spinal compartment. In 1930, Bailey and Cushing reported that they were able to improve the median survival from 12 months with surgery alone, to 34 months with surgery followed by postoperative craniospinal radiation.

Further progress was made over the next two decades with improvements and refinements in radiotherapy equipment and techniques. Also it was found that there was a definite relationship between the radiation dose and the chance of curing the child. During the 1970s and early 1980s multiple radiotherapists reported over 70% 5-year survival rates for children with medulloblastoma with megavoltage radiation to >54 Gy to the posterior fossa and 35 Gy to the brain and spine. The standard dose based on these related non-randomized studies became 35 Gy to the brain and spine with a boost to the entire posterior fossa resulting in a total of 54–55 Gy.

The efficacy of this treatment with radiation mode has been reviewed in numerous single-institution studies with slightly variable results. However, these multiple studies reported similar 5-year survival rates ranging from 56% to 78% with cranial–spinal radiation and posterior fossa boost to at least 54 Gy.<sup>6</sup> This improvement with radiation from 0% to 70% 5-year survival rate was so dramatic that no randomized study is necessary to prove the efficacy of radiotherapy.

The current issue is how to limit the amount of radiotherapy necessary and, if possible, identify subsets of patients, who will undoubtedly be relatively small in number, in whom radiotherapy is not necessary. The goal of the latter is paramount in very young children, in whom radiotherapy is not only more morbid but may of itself cause cancer.<sup>7</sup> From 50 years of study of nuclear bomb survivors, it is now known that the lifetime risk of cancer associated with radiation exposure is 10 times greater in children than it is in adults, and that this relative risk is similar at both low and high exposures of ionizing radiotherapy.<sup>8</sup> Several of the randomized trials discussed below have addressed lowering the dose of cranial–spinal radiotherapy while attempting to maintain survival rates.

## Chemotherapy

Prior to 1985 there was no definitive evidence that chemotherapy could be of benefit in medulloblastoma, other than for the treatment of recurrence. The subsequent evidence for activity is irrefutable, but the overall contribution of chemotherapy to cure of children with medulloblastoma remains relatively modest compared to the strides that were made before 1980 with application of improvements in radiotherapy and surgery. Documentation of the value of chemotherapy for recurrent medulloblastoma was accumulated over many years, from the outcome of small groups of patients with recurrent disease.

## Randomized clinical trials

Randomized clinical trials in medulloblastoma have addressed the following important hypotheses:

- 1 Adjuvant or neoadjuvant chemotherapy will improve survival.
- 2 A new chemotherapy regimen will be superior to the standard regimen in improving survival.

3 The dose of cranial–spinal radiotherapy can be reduced and thereby reduce long-term morbidity of therapy in some groups.

4 Utilizing chemotherapy with reduced dose cranial–spinal radiotherapy will improve survival rates while decreasing long-term morbidity.

These issues will be discussed below as they pertain to the randomized trials. It should be noted that all these hypotheses were not necessarily born out by the results of the studies, further showing the importance of randomized trials to provide evidence for clinical practice.

### **Benefit of adding chemotherapy to radiotherapy**

The first randomized trial in medulloblastoma was conducted by the Southwest Oncology Study Group and is described under Study 9 in this chapter. In this study van Eys *et al.* evaluated the efficacy of the addition of vincristine (intravenous) and intrathecal hydrocortisone and methotrexate compared to radiation therapy alone. The doses of radiation given were 50 Gy to the primary site and 35 Gy whole brain and spine. Of the 34 children randomized, 8 of the 16 who received chemotherapy died, and 5 of the 18 who did not receive chemotherapy died, therefore showing no benefit to this chemotherapy. There were two toxic deaths and it was identified that the risk of administering intrathecal methotrexate in children with potential for meningeal disease has some risk of developing leukoencephalopathy. However, based on the randomized results of the study, there was no benefit to delivering the chemotherapy. Possibly, the toxic death and small number of patients obscured the small benefit of vincristine.

The next randomized trials were conducted simultaneously by cooperative groups in Europe (International Society of Paediatric Oncology, SIOP) and the United States (Children's Cancer Group, CCG). Both randomized newly diagnosed patients between craniospinal radiation alone versus craniospinal radiation with chemotherapy and hence were adjuvant chemotherapy trials. The CCG study, Study 4 in this chapter, was performed from 1975 to 1981 and during the latter years of the trial was joined by the Radiation Therapy Oncology Group (RTOG). In this trial, vincristine, prednisone and CCNU constituted the adjuvant chemotherapy. The patients were randomized following surgery and, unlike previous studies, both M and T stages were identified

for these patients and the randomization was stratified by these factors. Radiation doses were similar in previous studies. Of 233 patients with medulloblastoma, 179 were randomized, 88 to chemotherapy and radiotherapy and 91 to radiotherapy alone. Based on the prospective goal of the study the difference was not significant. Five-year event-free survival (EFS) was 57% for chemotherapy and 52% for the control group. However, subset analysis showed that patients with a worse prognosis, based on M stage and T stage, had a statistically better outcome. Patients with M1, M2, M3, T3 and T4 disease had a 46% 5-year EFS on chemotherapy regimen in contrast to no survivors on the radiotherapy arm. The reciprocal observation, of course, showed no benefit of the chemotherapy for patients with no evidence for metastases (M0) and small tumors (T1, T2).

The SIOP trial (Study 1) was a randomized study carried out between 1975 and 1979. This study evaluated the role of chemotherapy added to the standard cranial–spinal radiation. The eligibility allowed patients under 16 years of age with medulloblastoma and anaplastic ependymoma, either infratentorial or supratentorial. The staging requirements were based on T staging and assessment of preoperative tumor volume and extension as well as brain stem involvement. The M staging was apparently an exclusion criterion if metastatic disease was detected, but it was unclear how many patients actually had metastatic work ups that by current standards would have included lumbar puncture (LP), CSF examinations with cytology and myelography. During the time period of this study MRI was not yet available and accuracy of staging must be viewed with that in mind. Evaluating the extent of brain stem involvement is difficult even with contrast enhanced MRI and extremely difficult based on CT scans. However, even with this limitation, the group is large enough that the randomization should have been able to eliminate the bias in the final results related to the metastatic patients entered on this study incorrectly. However, the issue of accuracy of staging may have influenced the subgroup analysis.

Despite this concern, the differences observed in the control group ( $n = 72$ ) versus the T3–T4 ( $n = 91$ ) disease group were extremely significant with 10-year EFS 55% with chemotherapy, versus 25% with radiation alone ( $p < 0.005$ ). Similarly for patients with incomplete resection, those who received chemotherapy had a 5-year EFS rate of 55% versus 36% for radiation

alone ( $p < 0.01$ ). As in the CCG study of similar time period (Study 4), those patients that would now be considered good or average risk with T1–T2 disease and complete resection had no significant benefit from the CCNU and vincristine.

Despite the limitations and concerns, when this study is combined with others it appears to support the conclusion that chemotherapy is of benefit to children with medulloblastoma, especially those that have higher risk disease than average. This study's conclusion was reached for T stage, because M stage had to be M0 or was ineligible for this study. While a large number of patients were able to be recruited, the study closed prematurely due to the observation that there was a significance difference of survival at 2 years. Subsequently, the difference disappeared because the follow-up was inadequate to draw a conclusion about 5-year survival at that point.

The SIOP trial differed from the CCG trial in two basic ways. First, the chemotherapy was vincristine and CCNU and excluded prednisone. Second, the outcome of all patients entered, including the better prognosis patients, resulted in a statistically significant advantage for chemotherapy, at least in the initial reports. The trial showed a greater benefit in the worse prognosis patients, and a minimal benefit in the best prognosis patients, but the overall difference was greater than in the CCG–RTOG trial. This raised the question of whether prednisone was deleterious, since it was used in the trial with less of a beneficial outcome. It was subsequently shown that steroids might decrease the brain capillary permeability to chemotherapy agents, along with the general steroid effect of reducing cerebral edema. Hence, in retrospect, the transatlantic difference in the simultaneous cooperative group trials may indeed have been due to adverse effects of the steroid.

A follow-up randomized study performed by the Pediatric Oncology Group (POG) tested MOPP adjuvant chemotherapy following radiation for newly diagnosed children with medulloblastoma. This is Study 3 in this chapter, reported by Kushner *et al.* for the POG conducted between 1979 and 1986. This trial addressed the issue of adjuvant MOPP chemotherapy following radiation. The use of MOPP was supported by results from Study 6 comparing MOPP to OPP. Progression-free survival (PFS) was the main outcome measure. Again, this early study did not apply stringent staging criteria and the M stage and other prognostic factors

were not identified in these patients. After surgery patients were randomized between standard radiation and radiation plus chemotherapy. The radiation varied from 35 to 40 Gy to the cranial spinal axis with the posterior fossa boost to 54 Gy, and the children were given lower doses. Over this 7-year period the study accrued only 78 patients, with seven refusing randomization. The 5-year EFS was 68% with MOPP and 57% with radiation alone. However, despite this difference, the  $p$ -value was only 0.18. Subgroup analysis was attempted only with the significant difference in the EFS in children over 5 years old where the EFS was 77% with MOPP versus 52% for radiation alone ( $p = 0.05$ ). There were similar differences for every subgroup, including extent of resection, T1–T2 stages, and T3 stage with superior survival with MOPP. Again, the number of patients was really insufficient to reach a statistically significant conclusion and therefore, although there is a suggestion that MOPP may be useful in chemotherapy, the study does not definitively prove this.

These early studies for the most part demonstrated improved survival with relatively moderate outpatient chemotherapy for the high risk patients with medulloblastoma. None of these studies truly proved that chemotherapy improved survival rates in average risk medulloblastoma above the survival rates achievable with standard radiotherapy alone. Study 12 reviewed in this chapter conducted between 1992 and 2000 by SIOP and the United Kingdom Children's Cancer Study Group (PNET 3 study) was the first to show benefit of more aggressive chemotherapy given pre-radiation to children with "standard risk" medulloblastoma. The purpose of this study was to determine whether pre-radiotherapy chemotherapy would improve outcome for Chang stage M0–M1 medulloblastoma when compared to radiotherapy alone. This study differed from the previous in that children who were M1 (positive CSF cytology without visible metastases on MRI) were included in this otherwise "average risk" group. Also some patients with residual tumor were included. The radiotherapy dose was 35 Gy cranial–spinal with a total of 55 Gy. EFS was significantly better for those receiving combined chemotherapy and radiotherapy. Along with staging, the type of chemotherapy and timing was different than on previous studies. The chemotherapy consisted of vincristine, etoposide, carboplatin ( $500 \text{ mg/m}^2$ ) and cyclophosphamide ( $1.5 \text{ g/m}^2$ ) given every 3 weeks for four cycles prior to radiotherapy. The

5-year EFS was 74% with chemotherapy and 59% without chemotherapy ( $p < 0.04$ ), with a median follow-up of 5.4 years. Multivariate analyses identified the use of chemotherapy and time to complete the radiotherapy as having significant effect on EFS, but not overall survival. Patients who required more than 50 days to complete radiotherapy had a significantly worse outcome. The presence of residual tumor had no significant effect on outcome.

Study 12 can be most directly compared to Study 10 in this chapter. The correct timing of radiotherapy and chemotherapy was also investigated in Study 10, reported by Kortmann *et al.* for the German GPOH group in 2000 (HIT '91). This study was also conducted between 1991 and 1997 compared pre- and post-radiotherapy chemotherapy with chemotherapy given after radiotherapy. The chemotherapy used following radiotherapy was a regimen of CCNU, vincristine and cisplatin, previously reported by Packer *et al.*<sup>9</sup> The “sandwich” regimen did not improve survival for any group. For average risk patients the 3-year PFS was 65% for the “sandwich” regimen and 78% for post-radiation chemotherapy ( $p < 0.03$ ). This 78% 3-year EFS is very similar to the 78.5% 3-year EFS with adjuvant chemotherapy on the PNET 3 study (Study 10). For high risk patients, the pre-radiation chemotherapy also did not provide any benefit. This along with other single arm phase II studies, has shown that the survival in medulloblastoma was not improved with neoadjuvant or pre-radiation chemotherapy. Therefore, Study 12 (PNET 3) was unique in finding a benefit.

## **Trials to determine best chemotherapy regimen**

Several studies have randomized to determine the better of two chemotherapy regimens for treatment of medulloblastoma. One early study (Study 6) was carried out by the POG and reported in 1984. This early study was conducted in the current patients and randomized between MOPP chemotherapy versus the same regimen without nitrogen mustard (OPP) in children with recurrent brain tumors. The main outcome measure was clinical response. This was actually a randomized response study, and not a two-phase trial, therefore the results are not as conclusive. The numbers are very small and demonstrated 4 out of 9 patients with medulloblastoma had complete or

partial response after MOPP, and 3 of 12 receiving OPP had partial response. It was concluded that MOPP produced more responses but with the very small numbers, this is hardly a justifiable conclusion.

Based on these early studies, Study 5 in this chapter, reported by Seltzer *et al.* for the CCG was conducted between 1986 and 1992. This study compared chemotherapy with an 8-in-1 regimen to adjuvant vincristine, CCNU and prednisone in medulloblastoma. Patients up to age 21 years were eligible in high risk grouping and identified as M1–M4 disease and T3B–T4. Again, the study required detailed investigations including postoperative myelograms, CTs or MRIs, CSF cytology and bone marrow evaluations.

Following surgery and staging all patients received radiotherapy. The vincristine, CCNU, prednisone regimen included weekly vincristine during radiation. The 8-in-1-chemotherapy arm included two cycles of chemotherapy prior to radiation and no vincristine during radiation. Radiotherapy doses were standard as reported in similar trials with 54 Gy to the posterior fossa and 36 Gy to the spine. The study included 155 medulloblastoma and 45 supratentorial PNET. Only patients considered high risk by M or T staging were allowed on the study. The results showed that PFS at 5 years was 53% for vincristine, CCNU and prednisone and 45% for the 8-in-1 regimen ( $p < 0.006$ ). In addition, the 8-in-1 regimen was more toxic, with complications related to gastrointestinal, electrolytes and renal toxicity.

Following the results of this study, many have attempted to analyze the reasons for the significantly lower survival rate with the 8-in-1. Eight-in-1 chemotherapy includes vincristine, CCNU and prednisone given at similar dose intervals. It adds other chemotherapeutic agents to the regimen. The only differences between the two regimens other than the additional agents were that there was an approximate 6-week delay in beginning radiotherapy on the 8-in-1 arm and, additionally, possible delays in therapy because of toxicity. Also, one group did not receive weekly vincristine during radiation. Therefore, concern has been expressed that although the study provided other agents, these agents were not delivered in as dose intensive a manner as the more standard vincristine, CCNU. However, for high risk patients this study provides additional evidence that chemotherapy with vincristine, CCNU and prednisone is of benefit – not only compared to radiation alone, as shown in the previous



study with subgroup analysis, but also when compared to another chemotherapy regimen.

SIOP also initiated a second randomized trial of chemotherapy in medulloblastoma, which is reported by Bailey *et al.* and evaluated as Study 2 in this chapter. This study was carried out between 1984 and 1989 as collaboration between SIOP and the German Society of Paediatric Oncology. Whereas the SIOP-I study was a direct, uncomplicated clinical study design, this study attempted both to address the role of chemotherapy as well as to evaluate the efficacy of radiation in low risk patients. Unlike the first study, the SIOP-II study attempted to divide the patients into two risk groups, again primarily utilizing T staging. The low risk group was defined as those with total resection or only microscopic residual disease and neither brain stem involvement nor metastases. Again, however, the CSF cytology, CT and MRI imaging of the spine were not mandatory so the number of patients entered on the study without complete staging is unclear (refer to the detailed discussion of the study in this chapter).

There were many logistical difficulties in this study, some of which were directly related to the lack of complete staging that allowed “low risk” patients to be entered and randomized to lower dose cranial–spinal radiation without complete front-end staging. In the low risk group only 132 of 229 had adequate imaging and proven negative CSF cytology. However, in the low risk group EFS was 55% for reduced dose radiation, 68% with standard dose radiation. Probably the most useful information derived from this study was the analysis of low and high risk grouped together with the therapy received. The most significant finding when adjusting for age and T staging was that there was a direct relation between radiation and chemotherapy. The negative effect on survival was associated with chemotherapy prior to radiation when the radiation dose was reduced. This was significant at  $p < 0.005$ . Both these facts suggested that the results were inferior when the radiation dose was reduced to 25 Gy to the cranial–spinal axis, both with and without chemotherapy.

Although this study had many flaws, it raised concerns about reducing the dose of cranial–spinal radiation in children with medulloblastoma. This must, of course, be taken into context with the type of chemotherapy, which was of relatively low dose intensity. Despite these results, further studies have been implemented with different types of more aggressive

chemotherapy to reduce the dose of cranial–spinal radiation. This effort is due to the very real risk of long-term deficits produced by the radiation to the cranial–spinal axis. There have been a number of studies that indicate that 30–35 Gy to the whole brain can produce deficiencies, including growth hormone, thyroid deficiencies and, more significantly, intellectual deficit, especially in children less than 7 years old.

### **Reduced dose of cranial–spinal radiotherapy to improve long-term morbidity**

The goal of most therapeutic trials in brain tumors is not only to cure the child, but also to provide a meaningful quality of life. This is of paramount concern. These concerns explain the continued study with the hope of providing therapy with reduced dose cranial spinal radiation. In fact, the recently completed study conducted by the Children’s Oncology Group (COG) for average risk medulloblastoma included much more aggressive post-radiation chemotherapy given after 24 Gy to the cranial–spinal axis. This same issue was explored in Study 7 in this chapter, reported by Deutsche *et al.* for the combined CCG and POG. This study was conducted from 1986 to 1990 and randomized good risk patients between full and reduced dose cranial radiation. Unlike the European studies, stringent staging was a requirement for study entry. This staging included myelography, MRI, CSF cytology, bone marrow examination and bone scan. The good risk group was required to have posterior fossa tumors that were T1–T2 with more than 50% resection and less than 1.5 ml of residual tumor. They also could have no evidence of metastases. The difference of the relapse rate between the two arms of therapy was most significant when recurrences outside the posterior fossa were considered, with 7 out of 60 relapses in the low dose group versus 0 out of 34 in the full dose group ( $p < 0.004$ ). Based on these results, the study was closed relatively early with a small number of patients entered.

Follow up of the patients entered on this study (Study 7) was continued because of concern that the difference may become less significant as time passes. Study 11 reported by Thomas, Deutsch *et al.* for CCG and POG in 2000 confirmed this concern. Mature

analysis confirmed that there was an increased risk of early relapse with reduced dose cranial–spinal radiotherapy. However, at 8 years there was no significant difference in EFS. Despite this finding no future studies have evaluated reduced dose cranial–spinal radiotherapy without the addition of chemotherapy to compensate. COG has conducted a pilot study that has shown that 24 Gy could be given with excellent 3-year survival rates of when adjuvant chemotherapy is given with the radiation. As a result a randomized study was conducted by COG to determine whether lomustine, cisplatin and vincristine versus cyclophosphamide, cisplatin and vincristine resulted in the best survival rates and least morbidity. The results of this randomization are not yet available.

In children less than 3 years old at diagnosis of medulloblastoma, studies for over 20 years have sought to delay or even omit radiotherapy by using chemotherapy, with moderate degrees of success. Many studies have shown that younger the child, the higher the risk of intellectual deterioration following whole brain radiotherapy. In 2005 Geyer *et al.*<sup>10</sup> for the COG reported the results of a randomized study between two different chemotherapy regimens (vincristine, cisplatin, cyclophosphamide and etoposide versus ifosfamide, carboplatin and etoposide). Radiotherapy was not given unless there was tumor progression. There were 299 infants entered on this study. At 5 years from study entry the EFS rate was 27% and survival rate 43%, with no significant difference between the two arms. Fifty-eight percent of children surviving at 5 years did not receive radiotherapy. These results are similar to other chemotherapy regimens, including lower dose cyclophosphamide, cisplatin, vincristine and etoposide. Another study also reported in 2005 by the German Pediatric Brain Tumor Study Group showed improved survival in young children with cyclophosphamide, vincristine, methotrexate, carboplatin and etoposide IV and intraventricular methotrexate without radiotherapy. In the 43 children treated on protocol, the EFS was  $68 \pm 8\%$  in 31 patients without macroscopic metastases and  $33 \pm 14\%$  in these with metastasis. This study is significant in that it reports the highest EFS for children less than 3 years treated without radiotherapy. In addition, the intelligence of children tested a mean of 4.8 years after diagnosis was significantly higher than children treated on a previous protocol with radiotherapy.<sup>11</sup>

The key issue in all these radiotherapy reduction or omission trials is whether intellectual outcome can be improved while maintaining or improving survival rates. The results of the endocrine and neuropsychological testing on the randomized studies with reduced dose radiotherapy are critical but often take longer to accumulate and report. For young children less than 3 years old, it is clear that those who survive without radiotherapy have improved outcome.<sup>12</sup> However, in the randomized studies in older children reducing the cranial–spinal dose to 24 Gy, it is yet to be proven that this reduction significantly improves outcome. Further follow-up on the studies described above is needed.

## Important issues for future studies

Despite these randomized trials, several important questions concerning the best use of radiotherapy and chemotherapy for treatment of medulloblastoma still need to be explored. And, as is usually the case in clinical trial outcomes, the results have also led to more questions being asked than were answered by the trials themselves. These include:

- 1 Does reducing the dose of cranial–spinal irradiation with chemotherapy provide adequate survival rates and improve neuropsychological outcome, neuroendocrine outcome, physical and physiological growth, overall quality of life and survival?
- 2 Will a reduction in volume provided by conformal radiotherapy techniques (including proton radiation)<sup>13</sup> be used to improve control of the tumor bed and simultaneously decrease the morbidity of normal tissue; to decrease late hearing loss without jeopardizing tumor control; to enable an increase in the use of radiosensitizing chemotherapy that will offer better tumor control without increasing hearing loss and other adverse outcomes from local normal tissue effects?
- 3 Can gene profile microarrays identify patterns that can adequately predict a more favorable prognosis to allow treatment of some children with chemotherapy alone, especially young children?
- 4 What is the role of other types of chemotherapy during radiotherapy?
- 5 Can neoadjuvant chemotherapy, radiotherapy or both, be helpful to improve surgical resectability and postoperative function?

6 Can intrathecal chemotherapy or biological agents provide prophylaxis to the cranial–spinal axis and replace some of the cranial–spinal radiation?

7 Will radioprotectors be clinically effective?

8 What targeted molecular therapies can be discovered for the treatment of medulloblastoma/PNET and other brain tumors?

Overall, chemotherapy not only has a prominent, justified role in the treatment of medulloblastoma/PNET, but also there is every reason to believe that chemotherapy will be increasingly used, particularly in multimodal settings, over the coming decades.

## References

- Rorke LB. Experimental production of primitive neuroectodermal tumors and its relevance to human neuro-oncology. *Am J Pathol* 1994;**144**:444–48.
- Russo C, Pellarin M, Tingby O, Bollen AW, Lamborn KR, *et al*. Comparative genomic hybridization in patients with supratentorial and infratentorial primitive neuroectodermal tumors. *Cancer* 1999;**86**:331–39.
- Zeltzer PM, Friedman HF, Norris DG, Ragab AH. Criteria and definitions for response and relapse in children with brain tumors. *Cancer* 1985;**56**:1824–26.
- Gajjar A, Hernan R, Kocak M, Fuller C, Youngsoo L, *et al*. Clinical, histopathologic, and molecular markers of prognosis: toward a new disease risk stratification system for medulloblastoma. *J Clin Oncol* 2004;**22**:984–93.
- Fernandez-Teijeiro A, Betensky RA, Sturla LM, Kim JYH, Tamayo P, Pomeroy SL. Combined gene expression profiles and clinical parameters for risk stratification in medulloblastomas. *J Clin Oncol* 2004;**22**:994–98.
- Bloom HFG. Medulloblastoma in children: increasing survival rates and further prospects. *Int J Radiat Oncol Biol Phys* 1982;**8**:2023–27.
- Pierce CA, Shimizu Y, Preston DL, Vaeth M, Mabuchi K. Studies of the mortality of atomic bomb survivors. Report 12, Part I. Cancer: 1950–90. *Radiat Res* 1996;**146**:1–27.
- Brenner D, Elliston C, Hall E, Berdon W. Estimated risks of radiation-induced fatal cancer from pediatric CT. *Am J Roentgenol* 2001;**176**:289–96.
- Packer RJ, Sutton LN, Elterman R, *et al*. Outcome of children with medulloblastoma treated with radiation, cisplatin, CCNU and vincristine chemotherapy. *J Neurosurg* 1994;**81**:690–98.
- Geyer JR, Spoto R, Jennings M, Boyett JM, Axtell RA, *et al*. Multiagent chemotherapy and deferred radiotherapy in infants with malignant brain tumors: a report from the Children's Cancer Group. *J Clin Oncol* 2005;**23**:7621–31.
- Rutkowski S, Bode U, Deinlein F, Ottenmeier H, Warmuth-Metz M, *et al*. Treatment of early childhood medulloblastoma by postoperative chemotherapy alone. *New Engl J Med* 2005;**352**:978–86.
- Ater JL, van Eys J, Woo SY, Moore III B, Copeland D, Bruner J. MOPP chemotherapy without irradiation as primary post-surgical therapy for brain tumors in infants and young children. *J Neurooncol* 1997;**32**:243–52.
- Lee CT, Bilton SD, Famiglietti RM, Riley BA, Mahajan A, *et al*. Treatment planning with protons for pediatric retinoblastoma, medulloblastoma, and pelvic sarcoma: how do protons compare with other conformal techniques? *Int J Radiat Oncol Biol Phys* 2005;**63**:362–72.

# Studies

## Study 1

Tait DM, Thornton Jones H, Bloom HJG, Lemerle V, Morris-Jones P. Adjuvant chemotherapy for medulloblastoma: the first multi-centre control trial of the International Society of Paediatric Oncology (SIOP-I). *Eur J Cancer* 1990;26:464–9.

The study was carried out between 1975 and 1979 by the SIOP Group (SIOP Study I).

### Objectives

The study aimed to compare craniospinal radiation alone with radiation given simultaneously with vincristine and followed by a combination of vincristine and CCNU.

### Details of the study

Patients under 16 with medulloblastoma or grade III or IV ependymoma were eligible; supra- and infratentorial tumors were included and patients were to have no

detectable metastases. The latter was based on CSF examination, with or without myelography or CT scans. Radiation had to be given within 1 month of initial surgery.

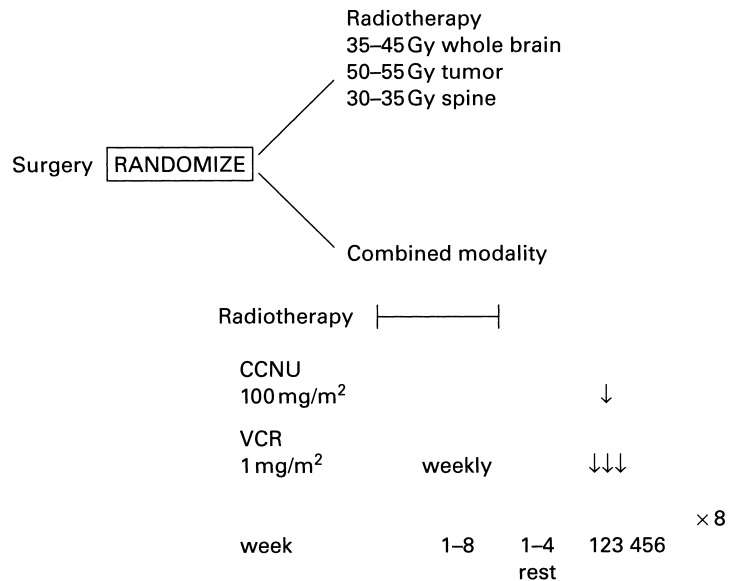
The method of randomization is not stated. Patients were stratified according to age, sex and extent of surgery. No details of anticipated number of patients or differences in outcome are provided.

Standard radiotherapy comprised 50–55 Gy to the primary tumor, with 35–45 Gy to the whole brain and 30–35 Gy to the spinal cord. Doses were reduced in children under 2 years of age.

They received 40–45 Gy to the posterior fossa with 30–35 Gy to the whole brain and 30 Gy to the cord.

In the chemotherapy arm, vincristine (VCR) was given weekly during the 8 weeks of radiotherapy, followed by a 4-week rest. CCNU and VCR were given as a 3-week cycle every 6 weeks for a total of eight cycles (Figure 7.1).

Major outcome measures were overall survival and even-free survival(EFS).



**Figure 7.1** Study schema for SIOP-I. Reprinted from Tait *et al.* (full reference above) with permission from Elsevier.

## Outcome

A total of 286 patients with medulloblastoma were identified. Only patients who agreed to be randomized and were subsequently randomized are the subject of this report. No details about the overall patient population or reasons for refusal to be randomized are given.

Of the patients with medulloblastoma, 141 were randomized to receive adjuvant chemotherapy and 145 to receive radiotherapy alone. Twenty-six children were under the age of 2 years at the time of treatment. Chemotherapy details were available for review in 110 of 141 patients, as were radiotherapy details in 260 patients. Pathology was reviewed in 99% of cases: there were 286 medulloblastoma and 45 ependymoma. No case was excluded irrespective of the extent of protocol violation.

At 2 years the EFS was 71% in the chemotherapy arm, versus 53% in the radiotherapy alone ( $p = <0.005$ ). At subsequent follow ups there were more late relapses in the chemotherapy arm and as a result at 10-year EFS was 50% versus 46% ( $p = 0.07$ ). Subgroup analysis suggested an advantage from chemotherapy. Of the 94 patients with brain stem involvement 48 were randomized to the chemotherapy arm and 46 to the control arm. At 10 years the EFS was 55% versus 25%,  $p < 0.005$ . Similarly, the 91 patients with T3/T4 disease who received chemotherapy had better disease-free survival than the 72 control patients (40% versus 20%,

$p = <0.002$ ). For patients with incomplete resection the EFS with chemotherapy was 55% versus 36% for those with radiation alone,  $p = <0.01$ . No difference was seen with chemotherapy for those without brain stem involvement, with T1/T2 disease or complete surgical resection.

## Toxicity

There was one chemotherapy-related death but this patient had received 2 years maintenance chemotherapy rather than one. Two patients died of second malignancy but neither had received adjuvant chemotherapy.

## Conclusion

A number of reservations were mentioned by the authors with regard to drawing firm conclusions from this study. The trial was closed before the anticipated accrual of 350 patients due to the large differences seen at 5 years, but follow-up was probably too short. The multi-center international nature of the trial led to some problems with the staging of all patients. For example, of the 94 patients said to have brain stem involvement, 18 were reported as having had total removal of tumor, which seems unlikely. Because of the duration of the study, toward the end recruitment fell off, in part because of the perception that the study chemotherapy was suboptimal compared to multiagent regimens.

## Study 2

Bailey CC, Gneko A, Wellek S, Jones M, Round C, Brown J, *et al.* Prospective randomised trial of chemotherapy given before radiotherapy in childhood medulloblastoma. International Society of Paediatric Oncology (SIOP) and the (German) Society of Paediatric Oncology (GPO): SIOP-II. *Med Pediatr Oncol* 1995;25:166–78.

The study was carried out between 1984 and 1989 by the SIOP and GOP groups.

## Objectives

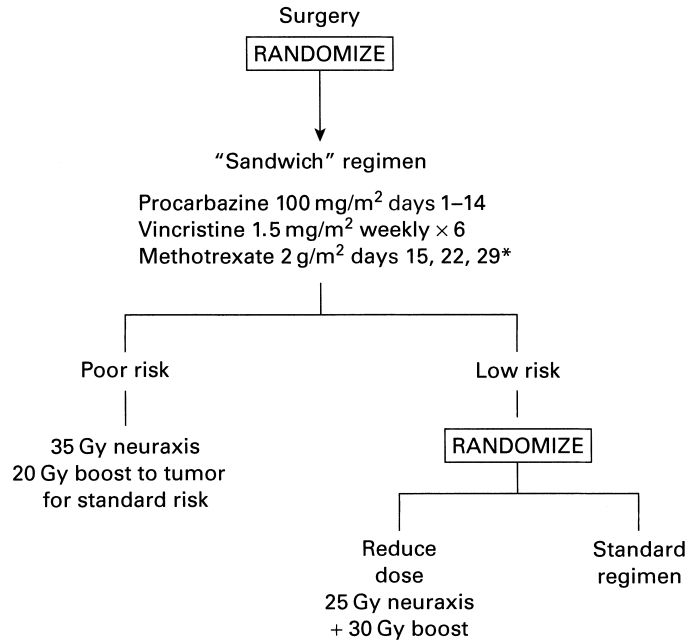
The study was designed to evaluate the possible benefit of adding vincristine, procarbazine and high dose

methotrexate to radiotherapy and secondly to evaluate the efficacy of a reduced dose of irradiation to whole neuraxis in low risk patients.

## Details of the study

Patients were eligible if under 16 years of age and were divided into two risk groups. The high risk group includes those with incomplete excision, brain stem involvement or metastases. It is unclear what method was used to define metastases, CSF cytology was recommended but was not mandatory and some, but not all, patients had CT or MR imaging.

The low risk group was defined as those with total resection or only microscopic residue and where there was neither brain stem involvement nor metastases.



**Figure 7.2** Study schema for SIOP-II.

\*Plus FA rescue at 24 hours from start of methotrexate. Reprinted from Bailey *et al.* (full reference on p. 134) with permission of Wiley-Liss, Inc., a subsidiary of John Wiley & Sons, Inc.

Randomization was done centrally by the GPO group in Mainz, using a minimizing approach to avoid imbalance regarding age, sex and center size.

Chemotherapy details are shown in Figure 7.2 and consist of a “sandwich” regimen with pre-irradiation chemotherapy combining procarbazine, vincristine and methotrexate. A single course was given prior to radiotherapy and six further cycles at 42-day intervals, given after irradiation to all patients considered high risk. Radiotherapy was commenced within 28 days of surgery, or 1 week of the last dose of methotrexate: 35 Gy in 1.66 Gy fractions to the brain and spine with a boost of 20 Gy in 2.0 Gy fractions to the posterior fossa was compared with 25 Gy to the neuraxis and a 30 Gy boost. Some “variation” was allowed between centers, with dose schedules that were regarded as being biologically equivalent.

Patients with low risk could thus receive either no chemotherapy or pre-radiation chemotherapy, and one of two radiation schedules. High risk patients were randomized to receive pre-radiation chemotherapy or not, but all received standard dose irradiation and/or post-operative post-radiation chemotherapy.

It was calculated that 150 patients would need to be recruited per arm to detect an improvement in event-free survival (EFS) from 50% to 65% at 5 years, with

80% power at 5%. The level for the equivalence between the two doses of irradiation,  $P_S - P_R$  was  $>0.15$  and a stopping rule was set at detecting a reduction in the EFS from 80% to 60% at 1 year.

## Outcome

Four hundred and forty-six patients were registered. Of these, 60 were excluded by centers and 22 following randomization. In 17 of these the diagnosis was incorrect. Three hundred and sixty-four patients were analyzed but 40 of these did not receive the treatment for which they were randomized. Overall EFS was 58% for those receiving sandwich chemotherapy and 60% for those receiving radiation treatment alone. In the high risk groups this was 56% and 52%, respectively. In the low risk group, only 132 of 229 had adequate imaging and 132 had proven negative CSF cytology. Of the 229 registered, 73 were not randomized. Of 74 patients receiving reduced dose radiotherapy EFS was 55%, and of the 79 receiving standard dose the EFS was 68% ( $p < 0.07$ ).

When the groups were combined, for those receiving standard dose radiotherapy (40 patients) the EFS was 60%; in those who received reduced dose irradiation treatment (36 patients) the EFS was 69%; in those receiving initial chemotherapy and standard dose

irradiation treatment (38 patients) the EFS was 75%, whereas in those receiving chemotherapy and reduced irradiation (36 patients) the EFS was only 42%. Analysis of these data, adjusting for age, sex, center size and TNM stage, showed a significant interaction between chemotherapy and radiotherapy ( $p < 0.005$ ), with a negative effect on survival associated by the insertion of chemotherapy prior to radiation where the radiation dose is reduced.

There were 12 non-tumor-related deaths. Six were immediate postoperative deaths that occurred after randomization had been carried out; six were treatment related: one methotrexate, two pneumonitis and two leukoencephalopathy. One died of transfusion-related AIDS.

### Study 3

Krischer JP, Ragab AH, Kun L, Kim TH, Laurent JP, Boyett JM, *et al.* Nitrogen mustard, vincristine, procarbazine, and prednisone as adjuvant chemotherapy in the treatment of medulloblastoma. *J Neurosurg* 1991;74:905–9.

The study was conducted between 1979 and 1986 by the Pediatric Oncology Group.

#### Objectives

The study addressed the question whether the addition of MOPP chemotherapy (mustine, vincristine, procarbazine and prednisolone) improved outcome when given after radiotherapy.

#### Details of the study

Patients aged 1–21 years were eligible. They had to have received no prior chemotherapy except corticosteroids and to have no evidence of metastases outside the central nervous system. The precise methods of spinal or CSF staging are unclear.

Randomization method was not specified but was balanced by center and patient age. Details of MOPP chemotherapy are given in Figure 7.3. Chemotherapy was given at 4-weekly intervals for a total of 12 courses, with a 25% reduction in dose if the white cell count fell below  $3.0 \times 10^9/l$ .

#### Conclusion

As for SIOP-I, there was concern expressed by the authors about the quality of data and the central review showed a 30% discordance with regard to risk grouping and a 50% discordance regarding documentation of brain stem involvement. It was suggested that the dose of methotrexate was suboptimal and the folinic acid (FA) rescue given too early. Chemotherapy appeared to be of no benefit to any subgroup and, moreover, appeared to have an adverse effect when given prior to reduced dose irradiation treatment.

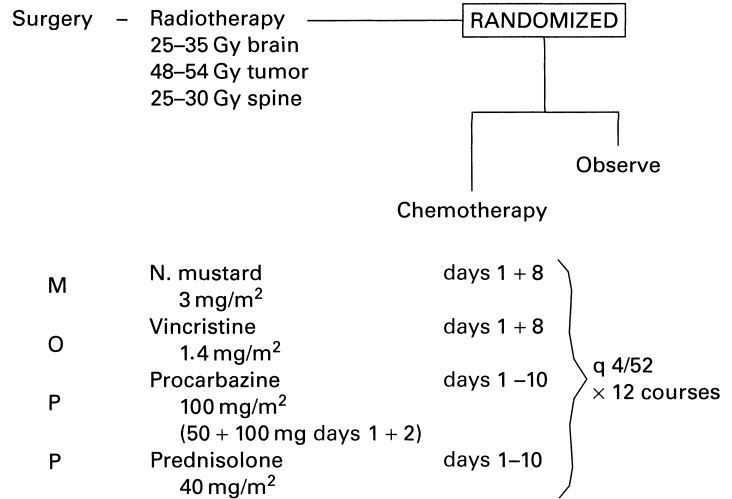
Radiation dose to those over 3 years of age was 35–40 Gy, and less than 3 years 25–35.2 Gy (dose was increased 3 years into study). Boost to posterior fossa consisted of 54–54.4 Gy in total, reduced to 48 Gy for patients under 3 years. Spinal irradiation consisted of 30 Gy, reduced to 25 Gy for patients less than 3 years.

Progression-free survival (PFS) was the main outcome measure. It was predicted that there would need to be 26 patients on each treatment arm to detect a 100% increase in the median time to progression, with 80% power at 5% significance level.

#### Outcome

Seventy-eight patients were eligible, of whom seven refused randomization.

Five-year event-free survival (EFS) was at 68% for MOPP and 57% for radiation alone ( $p = 0.18$ ). When subgroups such as race, sex extent of surgery and Change stage were separately analyzed, EFS appeared to favor irradiation plus MOPP, compared to irradiation alone, except for female patients (72% versus 75%, respectively) and in those under age 4 years (51% versus 67%). For children 5 years of age or older, EFS was statistically superior with MOPP–EFS 77% versus 52% ( $p = 0.05$ ). For other subgroups the trend was in favor of MOPP (not statistically significant): for subtotal excision, 66% versus 56%; total removal, 75% versus 58%; Change T1 T2, 64% versus 57%; T3 72% versus 61%.



**Figure 7.3** Study schema. Adapted and reproduced with permission from Krischer *et al.* (full reference on p. 136).

### Toxicity

There were no deaths associated with radiotherapy but one death occurred in the radiation alone arm from herpes zoster infection.

### Conclusion

It was concluded that MOPP was beneficial in male patients over 5 years of age. The difference, however, was not apparent beyond 7-year follow-up.

## Study 4

Evans AE, Jerkin DT, Sposto R, Ortega JA, Wilson CB, Wara W, *et al.* Results of prospective randomised trial of radiation therapy with and without CCNU, vincristine, and prednisone. *J Neurosurg* 1990;72:572-82.

The study was performed between 1975 and 1981 by the CCSG and the Radiation Therapy Oncology (RTOG) Group and evaluated the role of adding vincristine, prednisone and CCNU to standard surgery and radiotherapy.

### Details of the study

Eligible patients were those aged 2-16 years with either medulloblastoma or infratentorial ependymomas with M0 to M3 disease. Method of spinal imaging was variable and documentation of CSF cytology was not mandatory.

Randomization method is not specified but patients were stratified for T and M stage. Numbers required for a significant outcome measure are not specified.

The chemotherapy regimen is detailed in Figure 7.4. Vincristine (VCR) was given weekly for 8 weeks during radiotherapy and then eight 6-weekly cycles of post-radiation chemotherapy comprising VCR, CCNU and prednisone (PDN).

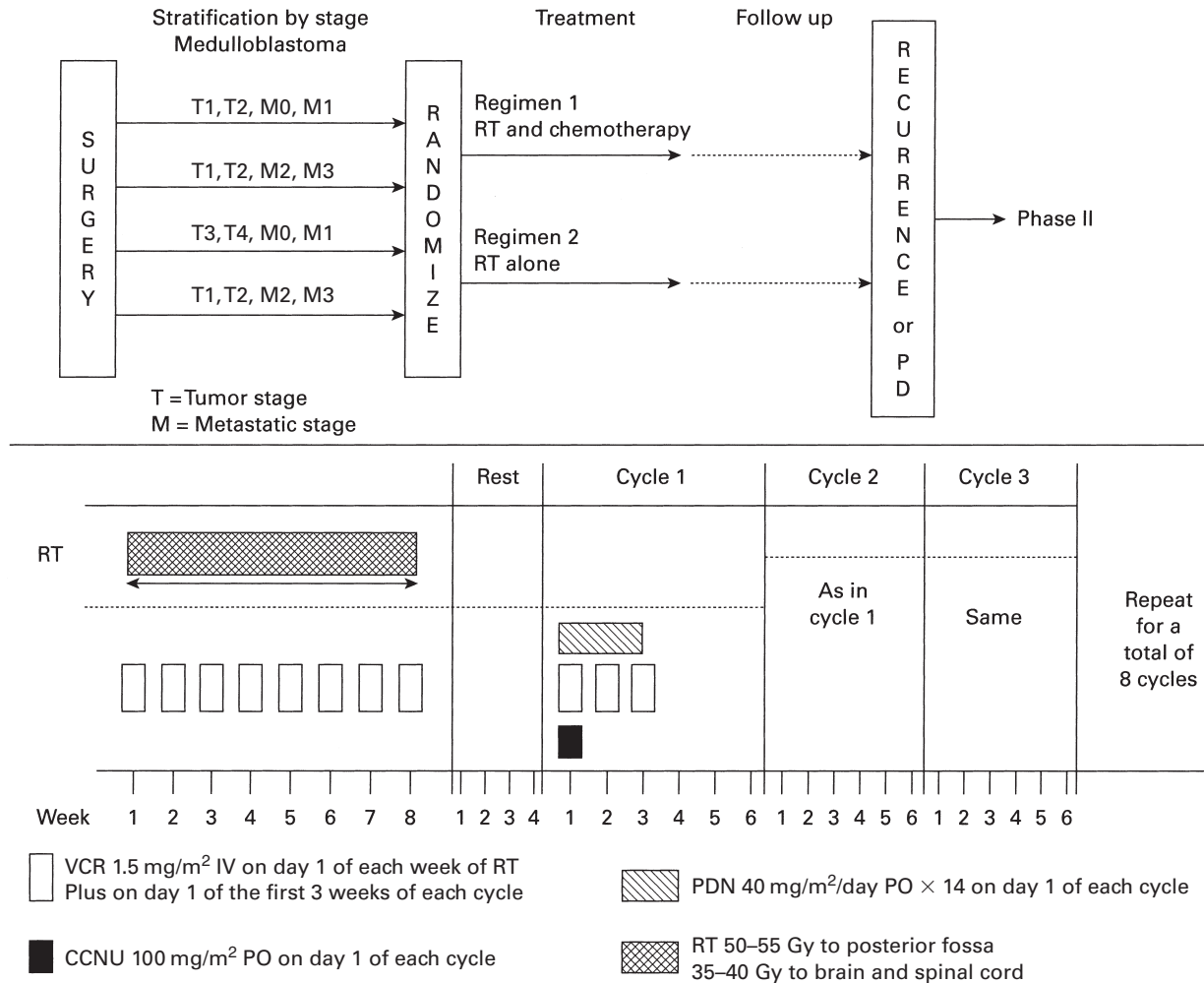
The radiation dose was 35-40 Gy to the whole neuraxis, with 50-55 Gy to the tumor and 50 Gy to spinal metastases. Patients under 3 years of age received 5 Gy less. The extent of surgical removal was evaluated by the surgeon. There was no postoperative CT scanning.

Primary outcome measures were event-free survival (EFS) and overall survival.

### Outcome

Three hundred and eleven patients were registered: 36 were not evaluable, 12 due to relapse or prior therapy, 10 due to supratentorial disease, 10 due to incorrect pathology and 4 other reasons. One hundred and seventy-nine patients had medulloblastoma confirmed on central pathology review, plus 54 diagnosed on local pathology alone. Thirty-six patients with ependymoma





**Figure 7.4** Study schema. IV: intravenous; PO: orally; PD: progressive disease. Adapted and reproduced with permission from Evans *et al.* (full reference on p. 137).

were excluded from this analysis. Of the 233 patients with medulloblastoma, 179 were randomized, 88 to chemotherapy and radiotherapy and 91 to radiotherapy alone. A further 12 patients switched treatment after randomization and 42 patients were electively treated without being randomized.

Of the 191 randomized, the 5-year EFS was 52% for radiation treatment alone and 57% with chemotherapy. For the whole group of 233 patients, both randomized and non-randomized, EFS for radiation alone was 50%, 59% for chemotherapy.

If T and M stages were considered, for M0, T1 and T2, 26 had radiation plus chemotherapy and 41 radiation alone. There was no difference in 5-year EFS. By contrast, for patients with M1–M3 or T3/T4 disease, 19 received chemotherapy and radiotherapy and 11 radiotherapy alone. There were no survivors in the

radiotherapy alone arm, compared to 46% with chemotherapy ( $p = 0.006$ ).

### Toxicity

Chemotherapy was associated with four fatal infections.

### Conclusion

It was concluded that these data suggest a potential improvement for patients with advanced disease but not those with standard risk. Reservations were raised about the lack of standardization in the initial staging and few had myelography or CSF, leading to a relatively small percentage of M3 patients. When only randomized patients were considered in this subgroup, all the numbers were smaller but there was still a significant difference in EFS.

## Study 5

Zeltzer PM, Boyett JM, Findlay JL, Albright L, Rorke LB, Milstein JM. Metastasis stage, adjuvant treatment, and residual tumor are prognostic factors for medulloblastoma in children: conclusions from the Children's Cancer Group 921 randomised phase III study. *J Clin Oncol* 1999;17:832–45.

This study was performed between 1986 and 1992 by the CCG Group (CCG-921) and compared sandwich chemotherapy with the 8-in-1 regimen to adjuvant PCV in advanced medulloblastoma.

### Details of the study

Patients between the age of 1.5 and 21 years were eligible. This high risk group was defined as having M1–M4 and T3b–T4 (T3a was included between 1986 and 1988). Patients with more than 1.5 ml of tumor residue following surgery on CT or MRI were also eligible. Detailed staging investigations were done and this was based on a combination of operative report, postoperative myelogram and CT or MRI, CSF cytology and bone marrow examination.

The randomization method is not specified, nor where this was done. There was stratification by histology, site and T and M stage. It was calculated that a total of 204 patients would be required to detect an increase from 40% to 60% 4-year survival with 84% power.

The two chemotherapy regimens are detailed in Figure 7.5.

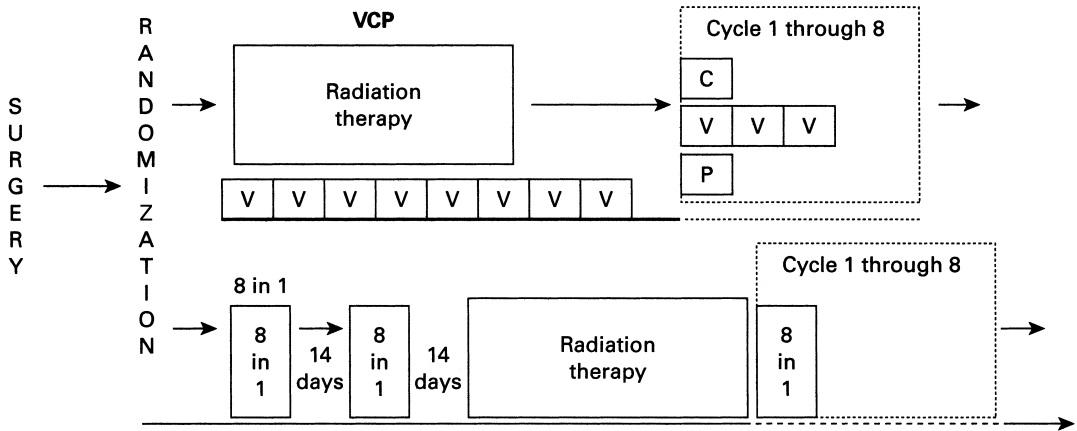
Following surgery, all patients received radiotherapy. They were randomly assigned to receive either weekly vincristine for 8 weeks during irradiation followed by eight cycles of VCP given every 6 weeks or two courses of 8-in-1 chemotherapy prior to radiotherapy, followed by eight courses of 8-in-1 at 6-weekly intervals. Overall, patients were well balanced for clinical features, however 24 patients in the PCV arm had M3 disease, compared to 13 patients in the 8-in-1 arm.

Radiation doses were 54 Gy total and 36 Gy to the posterior fossa in patients over 3 years of age and 45 Gy total and 23.4 Gy in those between 1.5 and 2.9 years. The dose of 18 Gy was given to any spinal disease. There was central review of planning fields in all cases.

Main outcome measures were progression-free survival and overall survival.

### Outcome

A total of 212 patients were registered, of whom nine were excluded due to inadequate data. Of the 203 remaining, 155 were registered as medulloblastoma and 48 as primitive neuroectodermal tumors. Pathology was reviewed centrally in 89% of cases. After review, there were a total of 188 confirmed medulloblastomas, on whom survival analysis was based.



8-in-1 = Vincristine 1.5 mg/m<sup>2</sup>  
 Methylprednisolone 300 mg/m<sup>2</sup> × 3  
 Lomustine (CCNU) 75 mg/m<sup>2</sup>  
 Hydroxyurea 1.5 g/m<sup>2</sup>  
 Procarbazine 75 mg/m<sup>2</sup>  
 Cisplatin 60 mg/m<sup>2</sup>  
 Cyclophosphamide 300 mg/m<sup>2</sup>  
 Cytarabine 300 mg/m<sup>2</sup>

PCV = Vincristine 1.5 mg/m<sup>2</sup> weekly during radiotherapy  
 then  
 Vincristine 1.5 mg/m<sup>2</sup> weekly × 3  
 Lomustine (CCNU) 100 mg/m<sup>2</sup>  
 Prednisone 40 mg/m<sup>2</sup> × 14 days

**Figure 7.5** Schema of Study CCG-921. © American Society of Clinical Oncology (full reference on p. 139).

Progression-free survival at 5 years was 63 ± 5% for PCV and 45 ± 5% for 8-in-1 chemotherapy (p < 0.006).

### Toxicity

The 8-in-1 regimen was more toxic with hematological complications, gastrointestinal, electrolyte and renal toxicity, and ototoxicity. Patients on 8-in-1 started radiotherapy on average 5 days later than planned.

### Conclusion

It was concluded that the 8-in-1 chemotherapy was inferior due either to the timing in relation to chemotherapy, i.e. the sandwich approach, with a delay in administering radiotherapy following surgery, or the reduced vincristine dose intensity compared to the PCV regimen.

## Study 6

Cangir A, Ragab AH, Steuber P, Land VJ, Berry DH, Krischer JP. Combination chemotherapy with vincristine (NSC-67574), procarbazine (NSC-77213), prednisone with or without nitrogen mustard (NSC-762)

(MOPP v OPP) in children with recurrent brain tumours. *Med Pediatr Oncol* 1984;12:1-3.

The study was carried out by the Pediatric Oncology Group and evaluated the role of mustine as part of combination chemotherapy in children with recurrent brain tumors. The trial date was not reported.

## Details of the study

Patients under 18 years of age with a range of recurrent brain tumors were eligible. This was a randomized phase II study and randomization was centralized in the POG office. The method of randomization was not specified. Patients were stratified into the four major tumor groups, depending on histological type: medulloblastoma, grade III and IV glioblastoma, ependymoma and miscellaneous tumors. The Mantel–Haenszel statistic (log-rank) method was used to compare life tables of survival duration and median remission and survival comparisons were made using the Wilcoxon rank-sum test.

The main outcome measure was clinical response on CT scan.

## Outcome

Fifty-four and fifty-two patients were randomized to MOPP (mustine 6 mg/m<sup>2</sup> days 1 + 8, vincristine 1.4 mg/m<sup>2</sup> days 1 + 8, procarbazine 50 mg/m<sup>2</sup> day 1, 100 mg/m<sup>2</sup> days 2–10, prednisone 40 mg/m<sup>2</sup> days 1–10 every 28 days) and OPP, respectively. Thirty-one patients

receiving MOPP and 14 patients receiving OPP were non-evaluable. This was due to a large percentage of early deaths and insufficient data. Overall, 4 of 9 patients with medulloblastoma had a complete or partial response after MOPP and 3 of 12 with medulloblastoma receiving OPP had a partial response. All patients on MOPP were reported to have myelosuppression with nausea and vomiting, and one life-threatening myelosuppression and two cases of pneumonia were reported in patients receiving MOPP but not among those receiving OPP. No clear details of these toxicities were presented.

## Conclusion

It was concluded that the MOPP regimen produced more responses than the OPP regimen in patients with recurrent medulloblastoma. This conclusion was drawn despite the very small numbers and the absence of any statistical difference between the two groups.

## Study 7

Deutsch M, Thomas PRM, Krischer J, Boyett JM, Albright L, Aronin P, *et al.* Results of a prospective randomised trial comparing standard dose neuraxis irradiation with reduced neuraxis irradiation in patients with low-stage medulloblastoma. *Pediatr Neurosurg* 1996;24:167–77.

The study was carried out between 1986 and 1990 by the combined Children's Cancer Group and Pediatric Oncology Group.

## Objectives

The study addressed the issue whether reduced dose whole neuraxis irradiation could be safely given to good risk patients without adverse effect on recurrence rate and survival.

## Details of the study

Patients between the ages of 3 and 21 years were eligible. Stringent staging was necessary, including myelography,

MRI, CSF examination, bone marrow examination and technetium bone scan. A good risk low stage subgroup was identified, comprising those with posterior fossa tumors with T1/T2 (T3a was added in 1988), more than 50% resection, and <1.5 ml residue.

No details of randomization methods are given. Stratification was by age alone.

It was predicted that 136 children would be recruited over 6.5 years and this would be sufficient to detect an increase in neuraxis relapse rate from 4% to 16% at 3 years, at the 10% level with 90% power. It would also detect an overall increase in recurrence rate, including primary site, from 23% to 33%.

In the control arm, a total of 36 Gy was given in 20 fractions at 180 cGy per day for 5 days per week, with an additional posterior fossa boost of 18 Gy in 10 fractions. Total posterior fossa dose was therefore 54 Gy. In the study arm, doses were reduced to 23.4 Gy in 13 fractions to whole neuraxis with a boost to the posterior fossa to achieve the same dose of 54 Gy. There was central review of all surgical details and radiotherapy, in addition to imaging.

The outcome measures were survival, progression-free survival and isolated spinal relapses.

### Outcome

One hundred and twenty-six patients were randomized. No details were given about the precise population base or randomization refusal rate. Following randomization, 32 patients were deemed to have been ineligible due to lack of postoperative contrast enhanced CT scan, >1.5 ml residue, no myelography or evidence of brain stem involvement.

Patients' outcomes were analyzed, both on the basis of the total group randomized ( $n = 123$ ) and those deemed eligible after full review of eligibility ( $n = 71$ ).

The overall relapse rate in the whole population was 5/63 (8%) for standard dose, versus 17/60 (28%) for reduced dose ( $p < 0.002$ ). For eligible patients only this was 2/34 (6%) versus 2/37 (32%) ( $p = 0.02$ ). If only recurrences outside the posterior fossa are considered in the whole patient group, there were 7/60

relapses versus 0/34 in the full dose group ( $p = 0.004$ ). In the eligible group this was 4 versus none ( $p = 0.015$ ).

On the basis of these findings accrual was discontinued in 1990 and with follow up there continued to be an excess in the number of total recurrences and neuraxis recurrences amongst patients treated with the reduced dose regimen.

### Conclusion

It was concluded that in this good risk group dose reduction is not feasible and leads to a higher failure rate.

### Comment

It is of note that there was a high ineligibility rate due to the stringent review and criteria, and numbers were relatively small once this was taken into account.

## Study 8

Gerosa, M, DiStefano E, Carli M, Iraci G. Combined treatment of pediatric medulloblastoma. A review of an integrated program (two-arm chemotherapy trial). *Child's Brain* 1980;6:262–73.

The study was carried out by the Padova Group and compared two different adjuvant chemotherapy strategies in surgically resected medulloblastoma. The date of the study is not stated.

### Details of the study

Eligibility criteria were age 15 years or under and posterior fossa location medulloblastoma. No details of randomization method or location are given. No details of anticipated difference in outcome or patient numbers are detailed.

Vincristine and cyclophosphamide were compared with vincristine combined with intrathecal (IT) methotrexate as adjuvant therapy. The vincristine dose was 1.5 mg/m<sup>2</sup>, cyclophosphamide 600 mg/m<sup>2</sup>, methotrexate 10 mg/m<sup>2</sup>; IT radiation dose was 55 Gy to the primary tumor with 40 Gy to the whole brain and 35 Gy to the spine. The overall dosage was reduced by 5–15 Gy in those under 3 years of age (Figure 7.6).

The primary outcome measure was event-free survival (EFS).

### Outcome

A total of 34 consecutively diagnosed patients were entered on the study, of whom three were lost to follow up and two excluded. Sixteen patients received cyclophosphamide/vincristine and 13 patients received vincristine/methotrexate. The mean interval to local recurrence was 30 months for the former and 27 months for the latter.

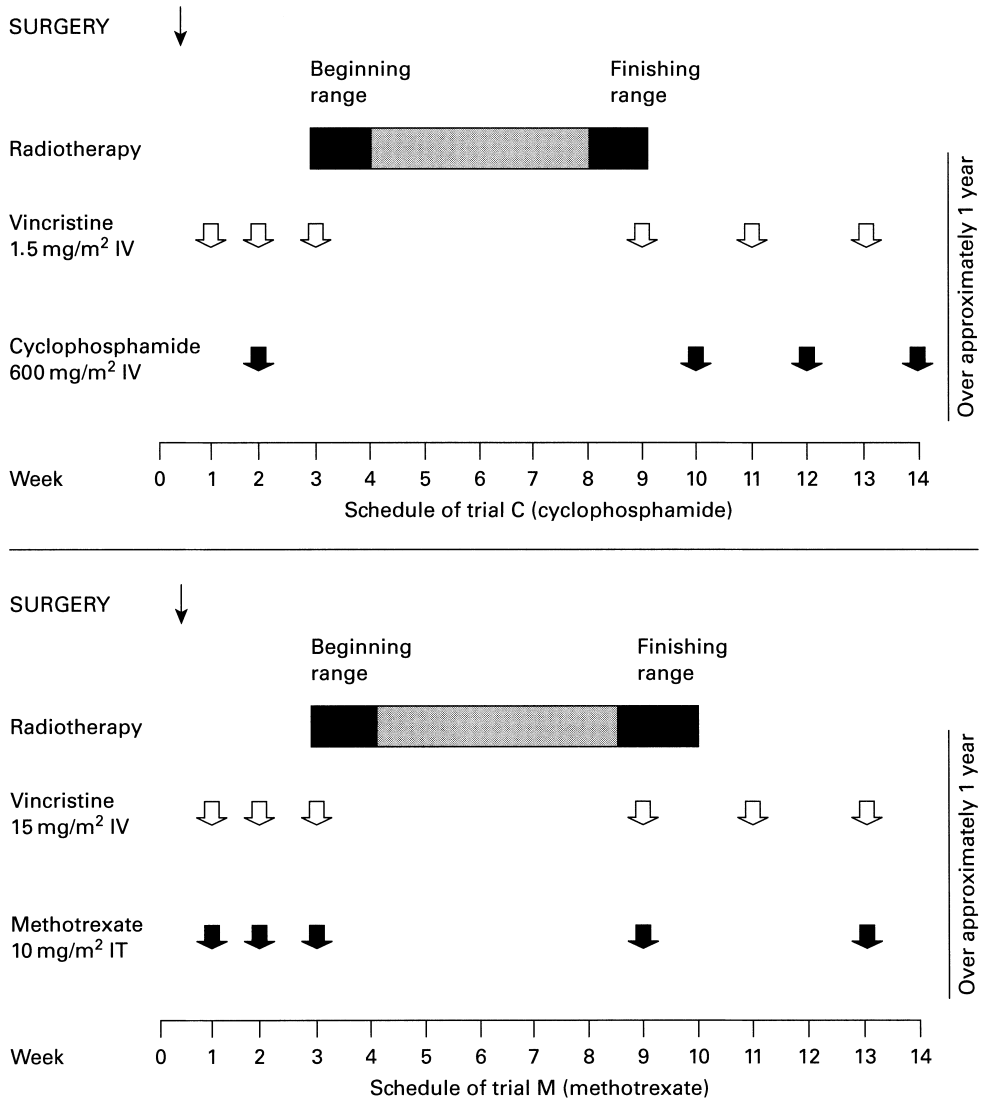
The local relapse rate with vincristine and cyclophosphamide alone was 69% and it was identical for the combination of vincristine with IT methotrexate.

### Conclusion

The conclusion was that neither regimen appeared to be particularly effective and there was no difference between the two regimens.

### Comment

This was an early study with limited details regarding patient evaluation or methodology.



**Figure 7.6** Combined treatment of pediatric medulloblastoma. Reprinted from Gerosa *et al.* (full reference on p. 142) with permission from Springer Science and Business Media.

## Study 9

Van Eys J, Chen T, Moore T, Cheek W, Sexauer C, Starling K. Adjuvant chemotherapy for medulloblastoma and ependymoma using IV vincristine, intrathecal methotrexate, and intrathecal hydrocortisone: a Southwest Oncology Study Group. *Cancer Treat Rep* 1981;65:681–84.

The study was carried out by the Southwest Oncology Group. The date of the study is not stated.

### Objectives

This was one of the first studies to address the issue of adjuvant chemotherapy and assess the use of intravenous vincristine and intrathecal methotrexate and hydrocortisone.

## Details of the study

The eligibility criterion was biopsy proven diagnosis, either medulloblastoma or ependymoma.

No details of randomization method or location are given. Patients were stratified by pathological type and also by the presence or absence of a ventriculoperitoneal or atrial shunt. No predicted differences in outcome or anticipated numbers are detailed.

Following trial details for initial surgery, radiotherapy commenced at around 10 days postoperatively. All patients received a total dose of 50 Gy to the primary site, with 35 Gy to the whole brain. Those under 3 years of age had a dose reduction to the posterior fossa of 45 Gy.

Vincristine 2 mg/m<sup>2</sup>, hydrocortisone 15 mg/m<sup>2</sup> and methotrexate 15 mg/m<sup>2</sup> were initially commenced in combination 1 week following radiotherapy and then given weekly. This was found to be excessively myelosuppressive and therefore only vincristine was given for 4 weeks and the combination was then given monthly for a total of 1 year.

The main outcome measure was survival.

## Outcome 1

Sixty-three patients were entered, of whom 2 were excluded due to incorrect diagnosis and 12 due to insufficient follow-up data. Of 44 evaluable patients, 9 had inadequate data or refused to be randomized.

Of 34 children with medulloblastoma, 8 of 16 randomized to receive chemotherapy died, 5 of 18 who did not receive chemotherapy died. Median survivals were 128 days and >134 days.

## Toxicity

There were two toxic deaths in this group, one due to sepsis and one due to unclear reasons.

## Conclusion

It was concluded that although this was a very small study, chemotherapy appeared to have no beneficial effect. The apparent adverse effect of chemotherapy was put down to the fact that these patients had closer surveillance and therefore relapse was noted earlier than in the radiotherapy alone arm.

## Study 10

Kortmann R-D, Kuhl J, Timmermann B, Mittler U, Urban C, Budach V, *et al.* Postoperative neoadjuvant chemotherapy before radiotherapy as compared to immediate radiotherapy followed by maintenance chemotherapy in the treatment of medulloblastoma in childhood: results of the German prospective randomised trial HIT '91. *Int J Rad Oncol Biol Phys* 2000;46:269–79.

This study was carried out between 1991 and 1997 by the German GPOH group (HIT '91 trial).

## Objectives

This study compared two chemotherapy strategies. The first a “sandwich” scheduling with chemotherapy before and after radiotherapy, the second less intensive chemotherapy given following radiotherapy.

## Details of the study

The eligibility criteria included patients between the age of 3 and 18 years. Study entry had to be within 4 weeks of surgery and no prior therapy apart from steroids was allowed.

Data were held centrally at Wuerzburg and quality control data in Tuebingen.

No details of the randomization method are given, nor are there any details regarding predicted differences or numbers required. There was central pathological review and central review of all radiotherapy planning data.

Patients were randomized following initial surgery. Those who were to receive pre-radiotherapy chemotherapy were given a combination of ifosfamide 3 g/m<sup>2</sup> × 3 and etoposide 150 mg/m<sup>2</sup> × 3 at around 2 weeks post-surgery. At weeks 5 and 6 high dose methotrexate 5 g/m<sup>2</sup> was given, and at week 7, cisplatin 40 mg/m<sup>2</sup> × 3 combined with cytarabine 400 mg/m<sup>2</sup> × 3 (see Figure 7.7).

Radiotherapy comprised doses of 35.2 Gy in 22 fractions to the whole neuraxis, with a boost to 55.2 Gy

to the primary site. Spinal metastases received a dose of 50 Gy. Those receiving initial radiotherapy were given weekly vincristine during radiotherapy and at 6 weeks following completion of irradiation a combination of oral CCNU 75 mg/m<sup>2</sup>, cisplatin 70 mg/m<sup>2</sup> and vincristine 1.5 mg/m<sup>2</sup> was commenced. Vincristine was repeated on days 8 and 15 of each cycle. Cycles were repeated at 6-weekly intervals for a total of eight courses.

The main outcome measures were progression-free survival (PFS), overall survival and the toxicity of this NROadjuvant chemotherapy approach.

## Outcome

One hundred and eighty-four patients were enrolled by 70 centers, of whom 137 were randomized, with 72 receiving arm 1, the “sandwich” regimen, and 65 arm 2, post-radiation chemotherapy. Forty-seven patients were not randomized due to parental refusal, but these are included in the subsequent analysis.

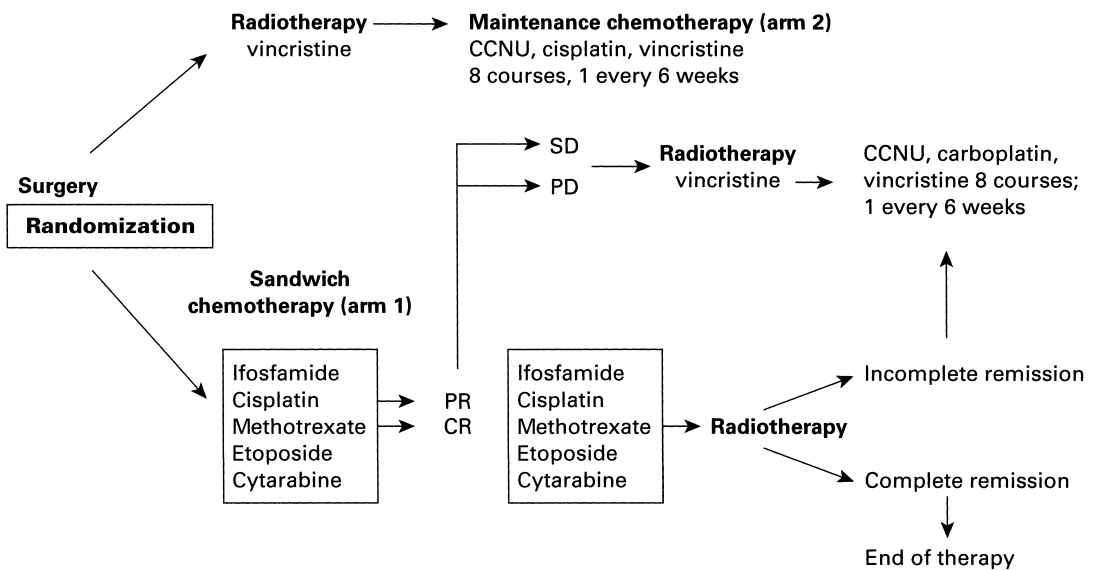
Of the randomized patients, 14% had M2/M3 disease and 60% had initial surgical complete excision.

Overall, 121 patients had full review of radiotherapy planning and a total of 23% were found to contain errors. This included incomplete coverage of cribriform plate, middle cranial fossa and posterior fossa, or a gap between whole brain and craniospinal fields.

The response rate in the whole patient group with measurable disease entered into arm 1 was 13/23 patients with complete response. There were 5/12 complete responses in patients with M2/M3 disease.

For the randomized study group only, the PFS was 66 ± 5% for those with no surgical residue, compared to 68 ± 9% for those with residue. In M2/M3 disease PFS was 30 ± 15%. In those with M1 disease, treated with arm 1, i.e. sandwich therapy, 3-year PFS was 65 ± 5%; in arm 2, post-radiation chemotherapy, it was 78 ± 6% (*p* < 0.03). For those between 3 and 5.9 years of age, PFS was 60% versus 64%, respectively, in contrast to those between 6 and 18 years of age where it was 62% versus 84%.

The relapse sites in the whole patient group were local 17%, other CNS sites 47% and combined 35%. There was only one extracranial recurrence in bone.



Radiotherapy: prescribed total dose and fractionation: 35.2 Gy craniospinal axis, 5 × 1.6 Gy/week; 20.0 Gy posterior fossa, 5 × 2.0 Gy/week

**Figure 7.7** Treatment schedule of HIT '91 trial. CR: complete remission; PR: partial remission; PD: progressive disease; SD: stable disease. Reprinted from Kortmann *et al.* (full reference on p. 144) with permission from Elsevier.



## Toxicity

There were two toxic deaths: one septic death in arm 1 and one leukoencephalopathy in arm 2, in a patient given intrathecal therapy following irradiation contrary to protocol.

## Conclusion

The conclusion is that although sandwich therapy is feasible, it does not appear to be of any benefit and may adversely affect outcome. Lower dose “maintenance” therapy appears to be superior, particularly in older children.

## Study 11

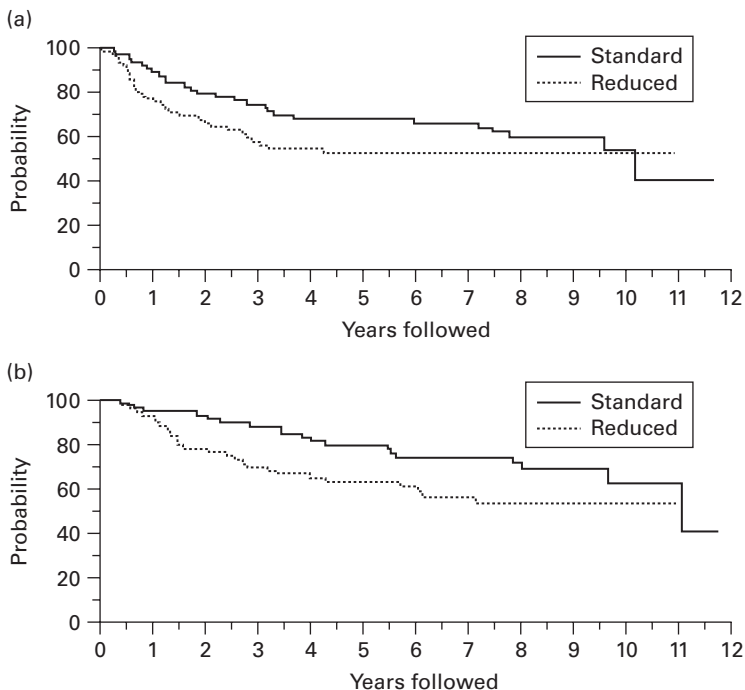
Thomas P, Deutsch M, Kepner JL, Boyett JM, Krischer J, Aronin P, *et al.* Low stage medulloblastoma: final analysis of trial comparing standard-dose with reduced-dose neuraxis irradiation. *J Clin Oncol* 2000;18:3004–11.

This is a follow-up analysis of the study report by Deutsch *et al.* 1996 (see Study 7).

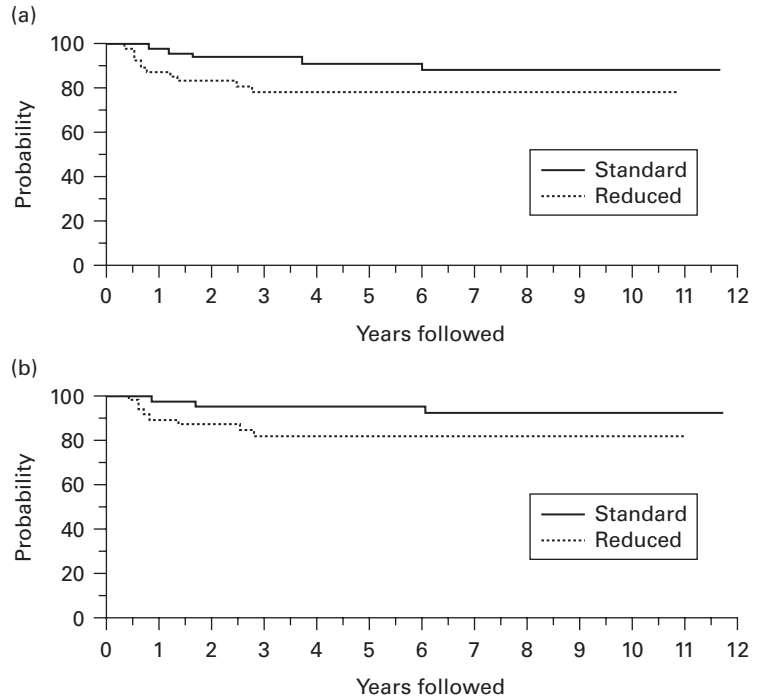
## Results

Estimates of event-free survival (EFS) and survival distribution for the 126 registered patients are shown in Figure 7.8.

With this longer follow-up and using a one-sided log tests there is insufficient evidence to conclude that EFS is lower among registered patients who received reduced dose radiotherapy than among registered patients who received standard dose radiotherapy ( $p = 0.11$ ). However, survival is lower in patients who received reduced dose radiotherapy ( $p = 0.03$ ). When patients are analyzed by received therapy there was a non-significant disadvantage to reduced dose  $p = 0.07$  for EFS and 0.07 for overall survival. A 5-year EFS is 67% for those receiving standard dose and 52% for those receiving reduced dose and at 8 years the figures are 67% and 52%, respectively. The isolated



**Figure 7.8** (a) Estimates of treatment-specific EFS and (b) survival distributions for all registered patients ( $N = 126$ ). © American Society of Clinical Oncology (full reference above).



**Figure 7.9** (a) Estimates of INR-free survival distributions by treatment for all registered patients and (b) similar estimates for all eligible patients. © American Society of Clinical Oncology (full reference on p. 146).

neuraxial relapse rate (INR) was higher in those who received lower dose radiotherapy for both registered and eligible patients ( $p = 0.03$  and  $0.015$ , respectively) (Figure 7.9).

There were 46 failures and 3 patients developed second malignancies; 16 treatment failures involved the posterior fossa 22 were isolated neuraxis and 8 were extraneural involving bone.

### Conclusion

Mature analysis confirmed that there was an increased risk of early relapse with reduced radiotherapy but with time the differences were less pronounced so that at 8 years there is no significant difference in EFS. It is suggested that more effective treatment may prolong the time to recurrence rather than increase the overall chance of a cure.

## Study 12

Taylor R, Bailey C, Robinson K, Weston C, Ellison D, Ironside J, *et al.* International Society of Paediatric Oncology; United Kingdom Children's Cancer Study Group. Results of a randomized study of pre radiation chemotherapy versus radiotherapy alone for non-metastatic medulloblastoma: The international Society for Pediatric Oncology/United Kingdom Children's Cancer Study Group PNET-3 Study. *J Clin Oncol* 2003;21: 1581–91.

This study was carried out by the International Society of Pediatric Oncology and the United Kingdom Children's Cancer Study Group (PNET 3 study) between 1992 and 2000.

### Objectives

To determine whether chemotherapy given after surgery and before radiation therapy would improve outcome in non-metastatic PNET.

**Table 7.1** Chemotherapy protocol. The regimen consisted of four cycles of chemotherapy at 3-week intervals using alternating cycles.

Drugs taken on days	1	2	3	4	5	6	7	8	9	10	11	12	13	14
<b>Vincristine</b> 1.5 mg/m <sup>2</sup> (day 1 only for cycle 4)														
<b>Etoposide</b> 100 mg/m <sup>2</sup>														
<b>Carboplatin</b> 500 mg/m <sup>2</sup>														
<b>Cyclophosphamide</b> 1.5 g/m <sup>2</sup>														
<b>Mesna</b> 750 mg/m <sup>2</sup> was administered 15 minutes before and 4 and 8 hours after cyclophosphamide														

### Eligibility

Eligibility included children aged 3–16 years of age with histologically proven primitive neuroectodermal tumor (PNET) and the absence of leptomeningeal disease. Diagnostic MRI of spine or myelogram was mandatory and had to be done before or within 2 weeks of surgery. CT or MRI of the cranium was to be done 48–72 hours postoperatively. CSF examination was not mandatory and ventricular sampling was common. For this reason patients with M1 disease were included. Initially, children with supratentorial disease were included but because the poor outcome of these patients was identified they were subsequently not eligible.

Randomization was done in the UK data center using a computer-based minimization technique. Patients were stratified by age and extent of tumor.

It was planned to include 420 patients. This would have a 90% power to show a 15% increase in survival, i.e. 60–75%. Due to increasingly poor recruitment the trial was closed in 2000 with 217 patients recruited thus reducing the power of the study.

### Study design

Following diagnosis and staging patients were randomized to receive craniospinal radiation or pre-radiation chemotherapy. Radiation therapy commenced with a craniospinal radiation. This was given in daily fractions, 5 days per week. Dose was 35 Gy in 21 daily fractions of 1.67 Gy. Radiotherapy dose to the posterior fossa was 20 Gy in 12 fractions at 1.67 Gy. Radiotherapy dose to

the posterior fossa was 20 Gy and 12 fractions at 1.67 Gy each. The total dose to posterior fossa was 55 Gy in 33 fractions of 1.67 Gy. For craniospinal radiation the lower border of the cranial field was set at C3–C4 junction. However, toward end of the study for many patients the lower borders of the spinal field was individualized according to the position of the lower border of the thecal sac seen on MRI. There was retrospective review of radiotherapy simulator or machine verification films by a panel of two radiation oncologists. There was central pathological review of all tumor samples.

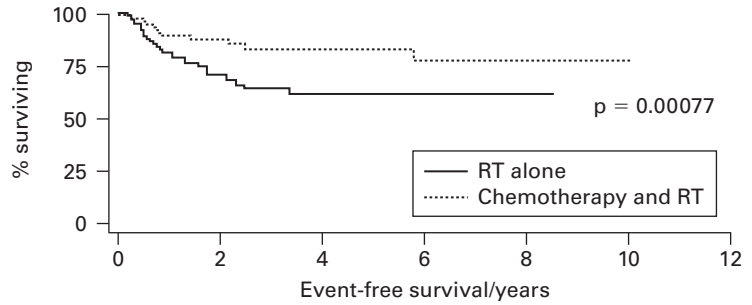
Chemotherapy consisted of four cycles given at 3-week intervals (Table 7.1).

### Outcome

Two hundred and seventeen patients were randomized; 27 were ineligible; 21 due to initial metastatic disease and 6 due to unclear staging; 11 patients with supratentorial PNET were removed; 104 cases were recruited from the United Kingdom.

There was concurrence of pathology in 98%. Of the reviewed three cases were diagnosed as ganglioneuroblastoma; 96% received all planned chemotherapy with the median duration of 78 days; 170 of 179 receiving radiation were reviewed. In three cases radiotherapy was not given due to refusal, progressive disease or toxic death; 90 patients received chemotherapy and radiotherapy; 89 patients received radiotherapy alone. There was no difference in the duration of radiation therapy between the two arms. Median 49 days (32–67)

**Figure 7.10** Event-free survival in patients with complete tumor resection. © American Society of Clinical Oncology (full reference on p. 147).



for combined therapy, median 48 days (17–62) for radiation therapy alone.

### Toxicity

No formal audiology was done. Three percent of patients developed grade III or IV renal toxicity. There were 3 deaths in complete remission. One due to neutropenic sepsis, one sudden unexplained early death following radiation and one unrelated death.

### Result

Event-free survival (EFS) was significantly better for those receiving combined therapy; 3 years 78% (70–81) versus 65% (55–75) and 74% versus 59% respectively for 5 years,  $p < 0.04$ . Overall survival was not significantly different 83% versus 76% at 3 years and 76% versus 64% at 5 years. There were 56 recurrences; 36 include posterior fossa, 26 included supratentorial region and 24 included spine.

EFS was significantly better in those taking less than 50 days to complete the course of radiation therapy, compared with those taking more than 50 days; 3-year EFS 78% (71–86) versus 54% (38–61)  $p < 0.009$ .

Ninety-nine patients had complete surgical resection of tumor at presentation and in these cases both EFS and overall survival were significantly better if given combined therapy ( $p = 0.04$ ). There was no significant benefit to those receiving chemotherapy who had had an incomplete resection (Figure 7.10).

### Conclusion

Treatment with four courses of intensive combination chemotherapy given postoperatively prior to radiation is feasible and advantageous particularly in patients with surgical complete resection.

## CHAPTER 8

# Glioma

*Commentary by Joann Ater*

Gliomas constitute over 50% of central nervous system tumors in children, and most are low grade. Several clinical trials address the treatment of low grade glioma, but none of the randomized studies is yet published. Hence this review will focus on treatment of high grade glioma.

The high grade glioma category of brain tumors includes anaplastic astrocytoma (AA), glioblastoma multiforme (GBM), high grade mixed glioma, anaplastic oligodendroglioma and high grade glioma not otherwise specified (NOS). They occur in any location in the central nervous system. Most studies that address treatment of high grade glioma have either focused primarily on the supratentorial tumors or brain stem glioma. The supratentorial high grade glioma group is only 10% of brain tumors treated in children under the age of 21 years and children with intrinsic pontine glioma make up another 8–10% of pediatric brain tumors. There are only approximately 150 cases in each group diagnosed annually in the United States. The reports cited in this chapter are specifically related to either supratentorial and cerebellar high grade gliomas or intrinsic pontine gliomas (brain stem glioma).

With the limitations imposed by small numbers, randomized clinical trials can only be performed within cooperative groups such as International Society of Pediatric Oncology (SIOP), Children's Cancer Group (CCG) and the Pediatric Oncology Group (POG), that have now merged to form the Children's Oncology Group (COG). Indeed, all phase III studies included in this chapter are reports from these groups. However, over the last decade, COG has not initiated any randomized studies in pediatric high grade glioma, choosing to focus on phase 1 and 2 trials based on pre-clinical laboratory and adult trial information. Some of these phase 1 and 2 studies from COG and other groups will be

discussed as providing information for future randomized studies.

### Surgery

The first element of treatment in high grade glioma is surgery. While there is no prospective trial of the benefit of extent of resection on pediatric high grade gliomas, there is now evidence from the CCG that surgical removal of over 90% of the tumor is a favorable prognostic factor.<sup>1</sup> This group reports a better 5-year progression-free survival (PFS) for children who have greater than 90% resection for both AA (44% versus 22%,  $p = 0.55$ ) and GBM (26% versus 4%,  $p = 0.046$ ). Nonetheless, this trial does not ascertain whether this benefit is a surrogate for biology of the tumor and invasiveness, or simply a reflection that more aggressive removal will improve survival.

For most brain stem gliomas, surgery is not a useful treatment modality; 85–90% of tumors that arise in the brain stem are diffuse, intrinsic pontine AA or GBM and 15% are focal low grade astrocytomas. The recognition of the relatively favorable focal low grade tumors is essential because of the relatively indolent course and distinctly different management. These tumors can be managed with surgery, observation and radiation or chemotherapy with progression, with good outcome. The focal brain stem gliomas are now excluded from clinical trials on intrinsic brain stem tumors, such as Study 2 in this chapter, reported by Mandell *et al.* for the Pediatric Oncology Group (POG-9239). On the other hand, intrinsic pontine glioma is a diagnosis that is made by MRI criteria, has a very poor prognosis, and biopsy or surgery is usually of no benefit.<sup>2</sup> The risk of the biopsy and/or surgery seems to outweigh the benefit in the attempted resection.

In summary, from the evidence we now have it appears that, with one exception, high grade glioma should be completely resected whenever possible without inflicting life-threatening neurological deficit. The CCG trial indicates that this can improve survival, especially when given with other treatment. The exception is diffuse pontine glioma surgery in which the diagnosis rarely needs to be established with tissue confirmation and resection is neither of evidence-based benefit nor of sufficient safety.

## Radiation therapy

The role of radiation dose and schedule in pediatric high grade glioma has been studied primarily in diffuse pontine glioma. There have been no randomized studies between surgery alone versus radiotherapy for high grade gliomas in children. However, there is evidence based on a number of adult studies that radiotherapy is of benefit in at least relieving symptoms and prolonging survival.<sup>3</sup>

In the 1980s and early 1990s, there was initial interest in whether higher doses and different schedules of radiation fractionation may be beneficial in treatment of brain tumors. This approach was utilized in Study 2 by Mandell *et al.* which investigated the issue of higher dose hyperfractionated radiation for brain stem gliomas. This study was based on numerous phase II studies from single institutions,<sup>4</sup> CCG<sup>5</sup> and POG,<sup>6</sup> that attempted to increase the dose of radiotherapy using a hyperfractionated (twice daily) treatment schedule to a variety of doses ranging from 64.5 to 78 Gy depending on the study. In retrospect, the early promising results may have included some patients with focal, more favorable tumor. The POG-9239 study (Study 2) randomized children with intrinsic pontine glioma between either the standard radiotherapy of 180 cGy daily to a total of 54 Gy or 117 cGy twice daily to 70.2 Gy. Both groups received concomitant cisplatin. The median time to progression (MTP) is 6 months for 54 Gy and 5 months for 70.2 Gy. The survival at 2 years was 7% in both groups, showing no benefit for hyperfractionated radiation. In addition, these survival rates are the same as previous studies with radiation alone, showing no suggestion of benefit of the cisplatin as a radiation sensitizer. Finally, the hyperfractionated radiation was more toxic. Based on this study standard radiation is still the recommended treatment for intrinsic pontine

glioma because of the benefit derived from temporary clinical improvement in most patients and tumor response in about 30%. These trials of radiation in brain stem glioma are important because when carefully done they demonstrated that hyperfractionation provided no objective benefit in prolonging survival beyond the benefit achieved with standard radiation. Numerous phase I and II studies are still ongoing to determine the effectiveness of chemotherapy and other radiation sensitizers for treatment of pontine glioma. These will be discussed below. As of now, despite numerous trials, there is no chemotherapy that appears to be of benefit in this disease.

In summary, the survival rates in brain stem gliomas are no better today than they were a quarter of a century ago, despite the trials and biological studies that have been conducted to date. This lack of progress is as dramatic as any failure in the discipline of pediatric oncology. To say that there is an urgent need for further laboratory and clinical studies in this type of glioma would be an understatement.

## Chemotherapy

The role of chemotherapy has been the subject of most cooperative group studies in high grade glioma of children throughout the world. The results of randomized clinical trials related to the use of chemotherapy in supratentorial high grade glioma in childhood are difficult to interpret because of small numbers, changing neuropathological classification systems and discrepancy in diagnosis between neuropathology reviewers. These problems are most apparent in Study 3, a report by Sposto *et al.* for the CCG. Seventy-two children aged 2–21 years with high grade glioma were enrolled over a 5-year period between 1976 and 1981. This was the first randomized study in pediatric high grade glioma at a time when chemotherapy was not well accepted as a treatment for brain tumors in children. Therefore, only a small percentage of high grade gliomas diagnosed at CCG institutions were enrolled on this study. Thirteen patients were excluded for various appropriate reasons, leaving only 58 patients to be randomized between involved field radiation alone and involved field radiation with concurrent weekly vincristine followed by CCNU, vincristine and prednisone. The randomization was not stratified by tumor type, and unfortunately the radiotherapy arm included 83% GBM

and the radiotherapy and chemotherapy arm included 54% GBM. Overall event-free survival (EFS) at 5 years was 46% with chemotherapy versus 18% for radiotherapy alone ( $p < 0.05$ ). For only the GBM patients, the 5-year EFS was 42% with chemotherapy versus 6% without ( $p = 0.01$ ). These results appear to statistically prove that chemotherapy with CCNU, vincristine and prednisone is superior to radiation alone in pediatric high grade glioma.

The main concern is the small number of patients. When forced to statistically analyze studies with sub-optimal numbers of patients, the results can often be indefinite and require further studies for confirmation. The second concern about this study is the pathology of these tumors. The survival rates on this study are much better than those reported in adult patients with similar treatment. One must conclude that either children have biologically different tumors that respond better to therapy than similar adult tumors, or perhaps subtypes of childhood low grade tumors were included erroneously. In reality it may have been a combination of both, as found in the review of the subsequent CCG-945 study (Study 1 in this chapter). (See further discussion below.)

Study 1 by Finlay *et al.* reports the results of CCG-945, the study that followed Study 3 discussed above. This study logically seeks to build upon the finding that chemotherapy is of benefit to children with high grade glioma and to compare a then promising regimen “8-in-1” regimen to the CCNU, vincristine and prednisone regimen. The patients were randomized after surgery. Both groups received involved field radiation to 54 Gy. Weekly vincristine was given during radiation with PCV but not with the 8-in-1 regimen. In a 5-year period 185 patients were randomized, enabling further analysis of the effects of histology and extent of resection on PFS. The median survival of 14 months for both regimens is similar to results reported in adult patients with radiation and chemotherapy, with 5-year PFS 28% in AA, 16% in GBM and 64% for anaplastic ganglioglioma and anaplastic oligodendroglioma. These results show disappointingly lower survival rates than those achieved in the previous study, but are probably not statistically different.

This study suggests that the 8-in-1 regimen is not superior to PCV, but two design flaws compromise this conclusion. First, chemotherapy was not administered during radiotherapy on the 8-in-1 regimen and it was

on the PCV regimen, so the conclusion remains tenuous. Had weekly vincristine also been given during radiotherapy on the 8-in-1 regimen the outcome may have been different. Secondly, the 8-in-1 regimen was administered for two cycles before radiation, thus delaying the start of the radiotherapy for at least 5 weeks.

The difference in survival compared to the previous study (CCG-943) led to renewed concern about the neuropathological diagnosis of the cases and discrepancy between reviewers. As noted, there was a large incidence of discordance for AA and glioblastoma between reviewers. In 1998 Boyett *et al.* reported a re-review of the cases enrolled on this study.<sup>7</sup> They found that when five expert neuropathologists reviewed 226 cases (98.3% of those enrolled on CCG-945), the five reviewers agreed on a specific diagnosis for only 25.2% of the cases. The consensus diagnosis confirmed high grade glioma in 136 patients (68.3%), while 75 (37.7%) of those entered on the study as high grade gliomas by institutional review were felt not to be high grade. When the 5-year PFS rates for each reviewer were compared for each tumor group to the institutional review, the survival of GBM and other high grade astrocytoma was relatively unchanged. However, the 5-year PFS rate for AA dropped from 37% by institutional review to 18–27% for the reviewers. Since the reviewers were selected because they were experts in their field, the discrepancy was not due to incompetence or an inability to make the appropriate diagnosis. This discrepancy may be based on such items as insufficient tumor for review (the necessity for making a diagnosis with only one or two slides without immunohistochemistry). While the reviewers reportedly used a uniform system, the interpretations of the individual systems vary between neuropathologists. This variation is amplified when studies from different institutions using different neuropathologic classification systems are compared. Therefore, one must be particularly careful in over interpreting the results of single institution studies in pediatric high grade glioma. Despite the difficulties, randomized multi-institutional studies that report both the institutional and reviewed diagnosis may provide the most reliable information for determining the treatment of childhood high grade glioma. Given these limitations, the papers and randomized studies published provide evidence-based information that can be useful in the treatment of children with high grade gliomas.

Clinical trials have shown that high grade gliomas in children can respond to a variety of chemotherapeutic agents. Study 4 by Kobrinsky *et al.* for the CCG and Study 5 by Friedman *et al.* for POG are essentially randomized phase II studies that evaluate response of tumor in recurrent patients. The Kobrinsky study had the hypothesis that mannitol could increase the efficacy of VP-16 by opening the blood–brain barrier in brain tumors. There were 15 low grade astrocytomas, 20 high grade gliomas, 22 brain stem gliomas and 42 primitive neuroectodermal tumors (PNETs) entered on the study. The response rate on central review was 8% with mannitol and 13% without disproving the hypothesis. In addition, the response rate to VP-16 given with this intermittent dose schedule is low enough not to appear encouraging to pursue. Study 5 by Friedman *et al.* randomized progressive or recurrent patients with brain tumors between carboplatin and iproplatin. The study was stratified by tumor histology to allow an assessment of response rate for each tumor type. For high grade glioma there was a 1/14 response with carboplatin and 0/12 for iproplatin and no responses in brain stem glioma. Based on this study carboplatin has a slightly higher response rate than iproplatin. These randomized phase II studies must be viewed in the same way as any other phase II study, in that they provide suggestive evidence of low levels of drug activity that would require further investigation in order to conclude that these drugs have any role in the treatment of children with newly diagnosed high grade glioma.

The efficacy of chemotherapy has been tested in both recurrent patients and pre-irradiation phase II window studies performed by the POG, COG and various other groups worldwide. The CCG and POG trials are complete but have not yet been reported in the literature. It is hoped that they will provide further evidence as to which types of chemotherapy would be most beneficial in high grade glioma. However, adult studies have shown that response rate alone is not sufficient to adequately choose the best chemotherapy. Therefore, they have taken the approach of evaluating both tumor response and also time to progression. The opinion is that while some agents provide a rapid response, the response is so short lived that it is not significantly beneficial. On the other hand, some agents may produce a slower response, but one that is longer lasting and consequently more beneficial to the patient. The adult North American Brain Tumour Consortium is now

evaluating chemotherapy trials in high grade glioma using statistical methods that evaluate both response and time to progression.

## Future studies

In an effort to improve efficacy of chemotherapy in childhood high grade gliomas investigators have utilized methods that include the following:

- 1 Neoadjuvant chemotherapy in a phase II window before radiation. This approach is based on the following premises: (a) reduction in the volume of the tumor enhances the efficacy of radiotherapy; (b) initiating multiple agent chemotherapy as soon as possible reduces the advent of multidrug resistance which increases as a function of the time that the tumor is not treated with chemotherapy (Goldie Coldman hypothesis); (c) chemotherapy takes less time to initiate than radiotherapy which requires referral to a radiotherapy unit, simulation, etc. and (d) chemotherapy is more able to more effectively penetrate the blood–brain barrier before radiation. The CCG and POG have completed studies utilizing this approach, and the COG study has been recently reported. In newly diagnosed patients with residual high grade glioma after surgery, CCG-randomized pairs of agents for the phase II window (prior to radiotherapy). The pairs were etoposide (VP-16) and carboplatin (regimen A), VP-16 and ifosfamide (regimen B), and VP-16 and cyclophosphamide (regimen C). In 76 evaluable patients, objective response rates were: 27% (A), 8% (B) and 29% (C). The median event-free survival were 283 days (A), 83 days (B) and 91 days (C), with an overall survival of  $24 \pm 5\%$  at 5 years and did not differ between groups. Patients who responded to pre-radiation chemotherapy had a slightly higher survival rate ( $p = 0.03$  for trend). However, the authors concluded that these relative high dose regimens did not add clinical benefit to more conventional regimens after radiation. COG does not plan to investigate these regimens further. However, other groups, such as the Society for Pediatric Oncology in Germany found in a small study of completely resected children with high grade gliomas that survival was significantly better in the group that received pre-radiation chemotherapy with ifosfamide, etoposide, methotrexate, cisplatin and cytosine arabinoside followed by cisplatin, lomustin and vincristine compared to radiation and the same maintenance chemotherapy.<sup>8</sup> However,



the numbers are small (only 19 children with >90% resection). The German group is now utilizing chemotherapy during radiation and randomizing between pre-radiation methotrexate and no methotrexate. Therefore, further studies may still be warranted to further explore the neoadjuvant chemotherapy approach.

2 High dose chemotherapy with autologous bone marrow or stem cell rescue is currently under investigation by a number of groups as a method of increasing dose intensification. There is a notable lack of randomized phase III trials of this approach and it is unlikely that any of the current trials will definitively demonstrate that high dose chemotherapy is a standard of treatment. Phase II studies have shown that this method is not helpful with brain stem glioma or ependymoma, but it is still being pursued in supratentorial high grade glioma.<sup>9</sup>

3 New agents and novel combinations are currently under investigation. In 2005 a large randomized study of adult GBM showed significant improvement in survival with concomitant and adjuvant temozolomide with radiotherapy compared to radiotherapy alone. This study is important in that it is the first randomized study in adult glioblastoma to show benefit of chemotherapy. The survival benefit was 2.5 months, which was significant statistically but modest clinical improvement.<sup>10</sup> Because it is given orally and is well tolerated, it is likely to be incorporated into future studies evaluating different dose schedules and combined with other drugs. Adult groups are currently testing combinations with BCNU, CCNU, tamoxifen, thalidomide, cis-retinoic acid, carboplatin, O<sub>6</sub>-benzylguanine and others. Perhaps these studies will provide clues for future studies in childhood high grade glioma. Irinotecan (CPT-11) is also an active drug in adult high grade gliomas. Evaluation of different dose schedules of irinotecan in combination with a variety of agents shows some promise. Topotecan in a phase 1 study given concomitantly with radiotherapy to children with brain stem glioma also showed promise in prolonging time to progression.<sup>11</sup> A phase 2 study of radiotherapy and topotecan is currently underway in COG.

4 Blood-brain barrier disruption in the form of a bradykinin analog that specifically opens the blood-brain barrier and not peripheral circulation (RMP-7) is under investigation in all types of brain tumors, including high grade glioma and brain stem glioma.

5 A new emphasis on chemotherapy during radiation as radiation sensitizer is now under investigation with a number of agents, including gadolinium-texaphyrin, topotecan, VP-16, temozolomide and others.

6 Identification of new targets for therapy in laboratory-based studies and phase I clinical trials may provide evidence of new areas to pursue, including anti-angiogenesis agents, anti-invasiveness agents and small molecule drugs such as tyrosine kinase inhibitors. Over the last 5 years the number of targeted small molecule therapies have dramatically increased and led to much excitement. Studies in pediatric high grade gliomas with agents such as ZD1839 (Iressa), R115777 (Zarnestra), SU5416 and others alone and in combination have proliferated. It is yet to be seen whether the efficacy justifies the excitement. Anti-EGFR therapies with antibodies such as Erbitux may also hold promise for some high grade gliomas.

7 One interesting new therapy involves adjuvant dendritic cell-based tumor vaccination. One study in relapsed malignant glioma in children and adults utilized vaccination with autologous mature dendritic cells loaded with autologous tumor homogenate. The treatment was well tolerated and responses were seen. In 2 of 6 patients with complete tumor resections that also received dendritic cell vaccine are in continued clinical remission (CCR) for 3 years.<sup>12</sup> While this individualized therapy will be difficult to ever test in a randomized trial, it appears to have sufficient promise to warrant further investigation.

It appears that currently in childhood high grade glioma there is no new treatment that appears promising enough to commit to a large phase III study that will take many years. Thus, most groups such as COG are continuing to pursue phase I and II studies. In the future with more individualized therapies directed at specific tumor markers, immunotherapy, anti-angiogenic therapy, etc., we will need to devise more creative ways to measure response and efficacy of therapy.

## Conclusion

Although the publications reviewed in this chapter may suggest otherwise, the treatment of pediatric high grade glioma continues to be a dilemma. The number of reported trials in childhood glioma is limited and their results are of insufficient power to provide unequivocal evidence-based outcomes for clear diagnostic,

prognostic and therapeutic directions. In particular, they do not resolve the role of high dose chemotherapy in high grade glioma; the optimal radiotherapy volume, dose or fractionation; the best treatment in the youngest patients; when and how to manage the low grade astrocytomas and how to follow patients for earliest sign of disease progression or recurrence. One of the reasons for this conundrum is that there are too few well-conducted trials. Compared to the number of clinical trials available for review in adult glioma, the number of trials in children is small. Despite the trials conducted to date, there is a compelling urgency to engage in clinical trials that will answer the questions that remain, many of which are generated by the very trials that were designed to settle some of these issues.

## References

- 1 Wisoff JH, Boyett JM, Berger MS, *et al*. Current neurosurgical management and the impact of extent of resection in the treatment of malignant gliomas of childhood. A report of the Children's Cancer Group trial CCG-945. *J Neurosurg* 1998;**89**:52–9.
- 2 Epstein F, McCleary EL. Intrinsic brain-stem tumours of childhood: surgical indications. *J Neurosurg* 1986;**64**:11–15.
- 3 Levin VA. Neuro-oncology: an overview. *Arch Neurol* 1999;**56**(4):401–4.
- 4 Prados MD, Wara WM, Edwards MSB, *et al*. The treatment of brain stem and thalamic gliomas with 78 Gy of hyperfractionated radiation therapy. *Int J Radiat Oncol Biol* 1995;**32**:85–91.
- 5 Packer RJ, Boyett JM, Zimmerman RA, *et al*. Hyperfractionated radiotherapy [72 Gy] for children with brain stem gliomas. A Childrens Cancer Group phase I/II trial. *Cancer* 1993;**72**:1414–21.
- 6 Freeman CR, Krischer JP, Sanford RA, *et al*. Final results of a study of escalating doses of hyperfractionated radiotherapy in brain stem tumours in children: a Paediatric Oncology Group Study. *Int J Radiat Oncol Biol Phys* 1993;**27**:197–206.
- 7 Boyett JM, Yates AJ, Gilles FH, Burger PC, Becker LE, *et al*. When is a high grade astrocytoma (HGA) not a HGA? Results of 226 cases of anaplastic astrocytoma (AA), glioblastoma multiforme (GBM), and other HGA (OTH HGA) by five neuropathologists. *Proc ASCO* 1998;**17**:526a.
- 8 Wolff JE, Gnekow AK, Kortmann RD, *et al*. Preradiation chemotherapy for patients with high grade glioma. *Cancer* 2002;**94**:264–71.
- 9 MacDonald TJ, Arenson EB, Ater J, Sposto R, Beven HE, *et al*. Phase II study of high-dose chemotherapy before radiation in children with newly diagnosed high-grade astrocytoma: final analysis of Children's Cancer Group Study 9933. *Cancer* 2005;**104**:2862–71.
- 10 Stupp R, Mason WP, van den Bent MJ, *et al*. Radiotherapy plus concomitant and adjuvant temozolomide for glioblastoma. *New Engl J Med* 2005;**352**:987–996.
- 11 Sanghavi SN, Needle MN, Krailo MD, Geyer JR, Ater J, Mehta MP. A phase I study of topotecan as a radiosensitizer for brain-stem glioma of childhood: first report of the Children's Cancer Group-0952. *Neuro-Oncol* 2003;**5**(1):8–13.
- 12 Rutkowski S, De Vleeschouwer S, Kaempgen E, Wolff JEA, Kuhl J, *et al*. Surgery and adjuvant dendritic cell-based tumour vaccination for patients with relapsed malignant glioma, a feasibility study. *Brit J Cancer* 2004;**91**:1656–62.

## Study 1

Finlay JL, Boyett JM, Yates AJ, Wisoff JH, Milstein JM, Geyer JR, Bertolone SJ, McGuire P, Cherlow JM, Tefft M, Turski PA, Wara WM, Edwards M, Sutton LN, Berger MS, Epstein F, Ayers G, Allen JC, Packer RJ. Randomised phase III trial in childhood high grade astrocytoma comparing vincristine, lomustine, and prednisone with the eight-drugs-in-1-day regimen. *J Clin Oncol* 1995;13:112–23.

The study was carried out between 1985 and 1990 by the Children's Cancer Group (Study CCG-945).

### Objectives

The aim was:

- To determine whether pre- and postoperative 8-in-1 chemotherapy was superior to PCV as post-radiotherapy adjuvant treatment in high grade astrocytoma.

### Details of the study

Eligible patients were required to have pathologically confirmed high grade astrocytoma outside the brain stem or spinal cord. Patients had to be less than 28 days from surgery unless pathological diagnosis had caused delay. No prior therapy was allowed. There was central pathology review but entry was based on the local pathology report. Histological types included were glioblastoma multiforme grade IV, anaplastic astrocytoma grade III, anaplastic ganglioglioma and anaplastic oligodendroglioma grade III.

The location and method of randomization is not stated. It was planned to enter 60 patients in each arm, in order to show a 50% decrease in the estimated hazards ratio of 0.46 per year in the control group with 80% power and a two-sided test. To achieve the secondary

objective, namely to study subgroups on pathological review with regard to prognostic factors, 172 patients were to be randomized, in order to have a 90% power to detect a 20% difference in 2-year progression-free survival (PFS) (40–60%) with a two-sided test ( $p = 0.05$ ).

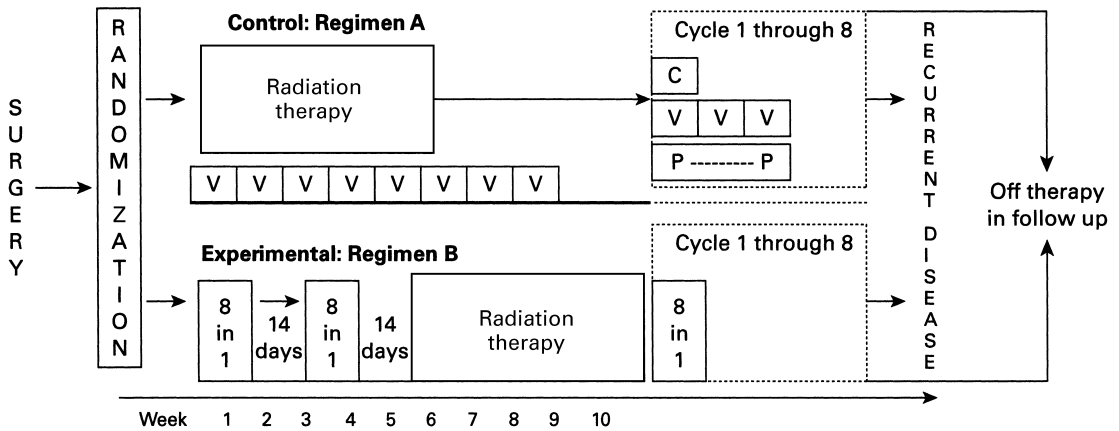
Study design involved standard treatment with local irradiation 54 Gy in 30 fractions at 1.8 Gy/fraction over 6 weeks with simultaneous weekly vincristine (eight doses), followed at week 10 by eight cycles of PCV chemotherapy with procarbazine, CCNU and vincristine, given every 6 weeks (Figure 8.1). Radiotherapy volume was the tumor on CT or MRI, including edema, and adding a 2 cm margin. The experimental arm consisted of two courses of 8-in-1 chemotherapy given 2 weeks apart, followed by the same radiotherapy and subsequently eight courses of 8-in-1 chemotherapy given every 6 weeks.

### Outcome

One hundred and eighty-five patients were randomized but it is unclear what number were eligible. Thirteen of those randomized were subsequently excluded, due to site (spinal cord) in two, local review of pathology in seven or withdrawal in four of parental consent. Eighty-five patients received standard therapy with PCV and 87 the 8-in-1 chemotherapy (one patient given the treatment arm to which they were not randomized was analyzed as randomized).

Age ranged from 21 months to 19 years, median 10 years. Resection greater than 90% varied by site, being achieved in only 7% of those with midline tumors, compared to 56% for the posterior fossa and 56% of those with hemisphere tumors. It was also lower in those with anaplastic astrocytoma, 34% versus 47% for glioblastoma multiforme.

Only one patient was noted to have spinal metastases on MR or myelography and two had positive cytology in the CSF.



**Figure 8.1** Schema for Children's Cancer Group Study CCG-945. © American Society of Clinical Oncology (full reference on p. 156).

Central pathology review revealed a high incidence of discordance. For anaplastic astrocytoma concordance was 63%, for glioblastoma multiforme 67%, but only 21% for other eligible tumor types. The radiotherapy planning volume was reviewed in 77% of patients, in whom 30% had inadequate margins.

Overall, the 5-year PFS was 33%,  $26 \pm 8\%$  with PCV and  $33 \pm 7\%$  with 8-in-1. Median survival was 14 months in both arms. Five-year PFS for anaplastic astrocytoma was 28%, 16% for glioblastoma multiforme and 64% for other pathology. Ninety-seven percent of failures were local.

### Toxicity

Grade III or IV toxicity, predominantly neurotoxicity, was seen in 14% of those receiving PCV; 45% of these receiving the 8-in-1 chemotherapy had grade III or IV toxicity, predominantly myelosuppression. These were

documented prior to radiotherapy. Following radiotherapy the degree of myelosuppression was comparable in the two arms.

### Conclusion

It is concluded that the more intensive 8-in-1 chemotherapy was of no significant benefit.

### Comment

A subsequent paper gives further details of the tumour resection rates in the study arm of CCG-945: Wisoff JH, Boyett JM, Berger MS, Brant C, Li H, Yates AJ, McGuire-Cullen P, Turski PA, Sutton LN, Allen JC, Packer RJ, Finlay JL. Current neurosurgical management and the impact of the extent of resection in the treatment of malignant gliomas of childhood: a report of the Children's Cancer Group trial CCG 945. *J Neurosurg* 1998;**89**:52–9.

## Study 2

Mandell LR, Kadota R, Freeman C, Douglass EC, Fontanesi J, Cohen ME, Kovnar E, Burger P, Sanford RA, Kepner J, Friedman H, Kun LE. There is no role for hyperfractionated radiotherapy in the management of children with newly diagnosed diffuse intrinsic brainstem tumours: results of a Pediatric Oncology Group phase III trial comparing conventional v. hyperfractionated radiotherapy. *Int J Radiat Oncol Biol Phys*

1999;**43**:959–64. The study was carried out by the Pediatric Oncology Group between 1992 and 1996 (study POG-9239).

### Objectives

The aim of the study was:

- To assess the value of hyperfractionated radiotherapy in brain stem glioma.

## Details of the study

Eligibility for the study required a clinical history of less than 6 months and at least two of the following clinical features: cranial nerve deficit, long tract signs or ataxia. Pathological confirmation was not required in all cases. A gadolinium enhanced MRI had to show at least two-thirds of a lesion to be intrinsic to the pons.

Details of randomization location or method are not given nor any prediction of the difference anticipated or numbers of patients required.

Radiotherapy started not more than 28 days from diagnosis. The study compared 180 cGy given in daily fractions to a total dose of 54 Gy, with 117 cGy fractions given twice a day to a total dose of 70.2 Gy. The radiation field included tumor volume plus a 2 cm margin.

Concurrent cisplatin was given as a continuous infusion over 120 hours on weeks 1, 3 and 5, combined with steroids. The exact dose is not given but prior dose finding studies suggest this was 100 mg/m<sup>2</sup>.

## Outcome

One hundred and thirty-two patients were entered on the study, of whom 67 received conventional radiotherapy and 65 hyperfractionated radiotherapy. Two patients were excluded due to diagnostic errors. The median ages

were 78 and 74 months, respectively. A pathological diagnosis was obtained in 22 patients; 10 were anaplastic astrocytoma or glioblastoma multiforme.

Although 95% of patients had documented clinical improvement, the event-free survival was short in both treatment arms. Three patients developed progressive disease during radiotherapy. Imaging reassessment 4 or 8 weeks after treatment in 108 evaluable patients showed a partial response in 18 patients with conventional radiotherapy, compared to 15 patients with hyperfractionated radiotherapy, stable disease in 25 versus 23 patients, and progressive disease in 13 versus 12 patients, respectively. The median time to progression was 6 months (range 2–15) with conventional radiotherapy and 5 months (range 1–12) with hyperfractionated. Median time to death was 8 months in both arms of the study.

Overall survival at 1, 2 and 3 years with conventional treatment was 30%, 7% and 3%, compared to 27%, 7% and 4% with hyperfractionation.

No difference in toxicity was documented.

## Conclusion

It is concluded that hyperfractionation did not appear to be of any benefit in this patient population.

## Study 3

Spoto R, Ertel IJ, Jenkins RDT, Boesel CP, Venes JL, Ortega JA, Evans AE, Wara W, Hammond D. The effectiveness of chemotherapy for treatment of high grade astrocytoma in children: results of a randomised trial. *J Neuro-Oncol* 1989;7:165–77.

The study was performed between 1976 and 1981 by the Children's Cancer Group (Study CCG-943).

## Objectives

The aim of the study was:

- To evaluate the role of adding chemotherapy with vincristine, CCNU and prednisolone to standard radiotherapy in high grade astrocytoma.

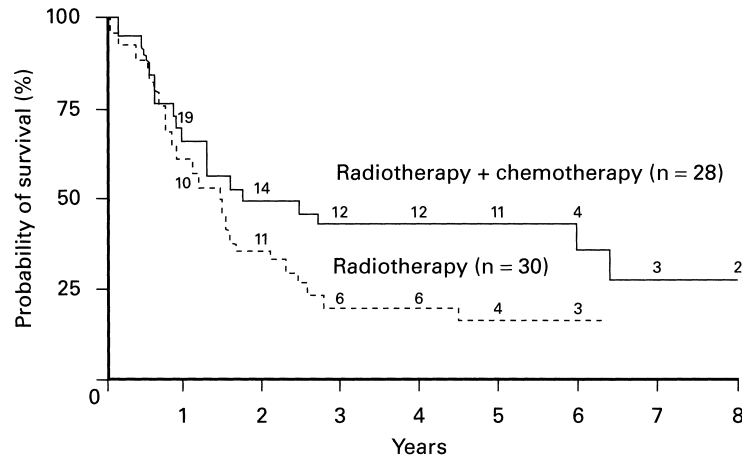
## Details of the study

Eligible patients were between 2 and 21 years of age with biopsy proven high grade astrocytoma (Kernohan grade II–IV). Brain stem and spinal cord tumors were excluded. Patients were grouped into those with anaplastic astrocytoma or glioblastoma multiforme. The latter was defined as one or more foci of necrosis in malignant astrocytes. There was central review of both pathology and radiotherapy planning fields.

Patients were randomized within 4 weeks of the time of surgery. The location and precise method of randomization was not detailed. An adaptive procedure was used to balance for two major prognostic factors, namely extent of resection (total, partial or biopsy alone) and site (supratentorial and infratentorial).

The difference that was sought between the two study arms is not defined, nor is the number of patients required for the study.

**Figure 8.2** Survival (in years) by randomized treatment assignment. Reprinted from Sposto *et al.* (full reference on p. 158) with permission from Springer Science and Business Media.



The patients in both arms received standard radiotherapy 52.5 Gy in 28 fractions. Children between the ages of 2 and 3 years received a reduced dose of 45 Gy. The radiation field was to encompass all tumor plus a 4 cm margin. The lower surface of C2 was the field margin for cerebellar tumors. There was to be a minimum field of 100 ml.

Patients randomized to chemotherapy received weekly vincristine ( $1.5 \text{ mg/m}^2$ ) for six doses and, following a 4-week break after completion of radiation, were given 6-week cycles of vincristine on days 1, 8 and 15 ( $1.5 \text{ mg/m}^2$ ), CCNU on day 2 ( $100 \text{ mg/m}^2$ ) and prednisone days 1–14 ( $40 \text{ mg/m}^2$ ). Total duration of treatment was planned for 58 weeks.

At relapse, all patients were eligible for a phase II study of either procarbazine alone, in those who were previously treated with chemotherapy, or vincristine/CCNU in those who had received chemotherapy.

Major outcome measures were event-free survival (EFS) and overall survival.

## Outcome

Seventy-two patients were enrolled on the study. Thirteen were excluded: 3 had received prior therapy, in 6 there was an “incorrect pathological diagnosis”, there was insufficient material for review in 2, 1 had a spinal tumor and 1 withdrew; 58 of 59 were randomized, 28 to radiotherapy plus chemotherapy and 30 to radiotherapy alone. Three patients randomized to radiation alone were given chemotherapy and were included in the analysis. Overall, the two arms were well balanced, except

that a higher percentage of patients in the radiotherapy alone arm had glioblastoma (83% versus 54%,  $p < 0.03$ ).

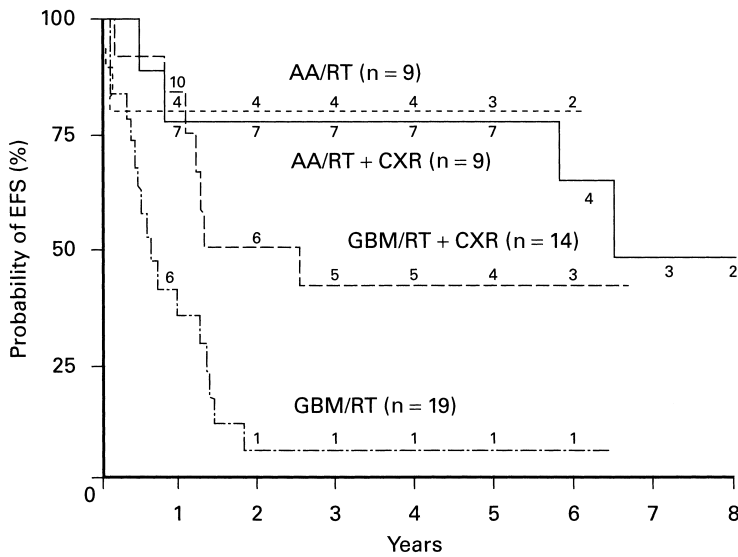
Three patients died but there were no details of EFS. In the remaining population, the EFS at 5 years was  $46 \pm 10\%$  in the combined therapy arm, versus  $18 \pm 7\%$  or radiotherapy alone ( $p < 0.05$ ). Overall survival at 5 years was  $43 \pm 9\%$ , versus  $17 \pm 7\%$  ( $p = 0.1$ ) (Figure 8.2).

The difference was most marked for children with glioblastoma, where at 5 years 42% remained event free, versus 6% ( $p = 0.01$ ) (Figure 8.3).

Eighty-two percent of the patients received radiotherapy, within 10% of the planned protocol. In 19 patients chemotherapy was delayed or drugs omitted. This was mainly due to infection. Of the 31 patients who were given chemotherapy, only 13 completed treatment. Of the 18 who failed to complete treatment, there were 10 with progressive disease and 4 refused further chemotherapy.

## Conclusion

It was concluded that adjuvant chemotherapy may prolong event free and overall survival, particularly in glioblastoma multiforme. Unfortunately, the numbers in this study were too small to provide a reliable answer to the question posed.



**Figure 8.3** EFS (in years) by pathology and randomized treatment assignment. CXR: chemotherapy; RT: radiotherapy. Reprinted from Sposto *et al.* (full reference on p. 158) with permission from Springer Science and Business Media.

## Study 4

Kobrinsky NL, Packer RJ, Boyett JM, Stanley P, Shiminski-Maher T, Allen JC, Garvin JH, Stewart DJ, Finlay JL. Etoposide with or without mannitol for the treatment of recurrent or primarily unresponsive brain tumours: a Children's Cancer Group Study, CCG-9881. *J Neuro-Oncol* 1999;45:47–54.

The study was carried out by the Children's Cancer Group between 1988–1992 (Study CCG-9881).

### Objectives

The aims of the study was:

- To document the response in relapsed brain tumors to etoposide and the efficacy of mannitol when combined with this drug.

### Details of the study

Eligible patients had recurrent or refractory brain tumors, and had received prior chemotherapy or radiotherapy. Disease types included medulloblastoma/primitive neuroectodermal tumor (PNET), grade I–IV astrocytoma and brain stem glioma. Patients were aged less than 21 years and at least 3 weeks had elapsed since prior treatment. They had a life expectancy of 12 months or over, creatinine clearance  $>50$  ml/min/1.73 m<sup>2</sup>,

bilirubin  $<2.5$  mg/dl, neutrophils  $>1000/\text{mm}^3$  and platelets  $>100,000/\text{mm}^3$ .

No details of the randomization site or method used are given. No details are given of the predicted difference between the two arms or number of patients required. Patients were stratified by histological subtypes.

There was central review of response on imaging and a clinical scoring system was used that was based on steroid usage, signs and symptoms of raised intracranial pressure and neurological status.

### Outcome

Ninety-nine patients were registered. The histological subtypes included 15 low grade astrocytomas, 20 high grade gliomas, 22 brain stem gliomas and 42 PNETs. Six patients were non-evaluable as they had complete surgical resection, and 6 had inadequate data. Of 87 patients, only 67 had evaluable imaging. Local review showed a total of 12 partial and no complete responses. This was reduced to seven partial remission on central review of imaging. Overall response rate was 14% with local reporting and 10% after central review. Local reporting showed a 17% response rate with mannitol, compared to 10% without mannitol. On central review this was 8% with mannitol versus 13% without, that is no significant difference between the two arms. Survival

with mannitol was  $36 \pm 7$  months and without mannitol it was  $28 \pm 6$  months. The clinical scoring system showed a poor correlation with radiological response and was not included in the analysis of response or outcome.

## Study 5

Friedman HS, Krischer JP, Burger P, Oakes BW, Hockenberger B, Weiner MD, Falletta JM, Norris D, Ragab AH, Mahoney Jr DH, Whitehead MV, Kun LE. Treatment of children with progressive or recurrent brain tumours with carboplatin or iproplatin: a Paediatric Oncology Group randomised phase II study. *J Clin Oncol* 1992;10:249–56.

This study was carried out by the Pediatric Oncology Group between 1986 and 1990 (POG-8638).

### Objectives

The aims of the study was:

- To compare the activity of two non-nephrotoxic platinum analogs in relapsed brain tumors.

### Details of the study

Eligibility included patients under 21 years of age with a range of intracranial malignancies. With the exception of brain stem glioma, this had to be histologically proven. A repeat biopsy was required if the relapse occurred more than 2 years from initial presentation. No more than one previous phase II study was allowed, neither was radiotherapy within 3 months, chemotherapy or increased dose of steroids within 6 weeks and no prior carboplatin or iproplatin. There had to be CT or MRI measurable disease, a predicted survival of at least 8 weeks and Karnofsky score  $> 30$ . Other criteria were base line neutrophil count  $> 1500/\text{mm}^3$ , platelets  $> 100,000/\text{mm}^3$ , creatinine  $< 1.2 \text{ mg/dl}$  and bilirubin  $< 1.5 \text{ mg/dl}$ .

No details are given about the site of randomization or the technique used. No predicted difference between the two groups is given or anticipated numbers required. It is stated that randomization was done mainly to document the comparative myelosuppression of the two agents. Patients were stratified by histology and prior

### Conclusion

It was concluded that the overall response rate to single agent etoposide was low and mannitol did not significantly improve the efficacy of etoposide.

cisplatin with regard to response analysis, and prior spinal irradiation with regard to toxicity.

### Outcome

One hundred and seventy-one patients were enrolled. One with neuroblastoma was excluded, whereas 30 were non-assessable due to early death, inadequate trial of chemotherapy, parental refusal or insufficient data.

The complete response/partial response rate with carboplatin was  $9.5 \pm 2.6\%$  and with iproplatin,  $6.3 \pm 2.7\%$ . No difference was seen in response rates in patients who had received cisplatin prior to carboplatin, whereas the response rate to iproplatin was higher in cisplatin naïve patients (20% versus 3% for those with prior therapy). Thirty-two percent of patients had stable disease. Response by histological subtype for patients receiving carboplatin or iproplatin is shown in Table 8.1. Neutropenia was more marked with carboplatin – 20/83 versus 4/88,  $p < 0.001$ . No difference in thrombocytopenia and no difference in life-threatening sepsis were observed.

**Table 8.1** Response to therapy (PR/CR) in relation to histology.

Histology	Carboplatin	Iproplatin
Low grade astrocytoma	0/7	1/15
High grade astrocytoma	1/14	0/12
Medulloblastoma	1/15	1/14
Ependymoma	1/12	0/7
Brain stem glioma	0/14	0/14
Other	2/10	0/9

PR: partial remission; CR: complete remission.

### Conclusion

It was concluded that both the drugs had limited activity in this range of relapsed tumors and differed only with regard to toxic neutropenia.



## CHAPTER 9

# Non-Hodgkin's lymphoma

*Commentary by Tim Eden and Ross Pinkerton*

It is difficult for the current practitioner to realize that before the mid-1970s the outcome for children with non-Hodgkin's lymphoma (unless they had truly localized disease treated with surgery and local radiation) was very poor. The use of pulsed chemotherapy with regimens such as CHOP yielded 5-year event-free survival rates of 20% or less. The advent of truly intensive regimens for acute lymphoblastic leukemia (ALL) protocols and their application to the non-Hodgkin's lymphomas (NHL) transformed the picture, not least the key study comparing the Sloan-Kettering intensive regimen LSA2-L2 with COMP (see Study 1 for details of regimens). Although Anderson *et al.* reported the results in 1983, a dramatic change in survival was already evident in the late 1970s and spawned a series of other studies.

Identification by the Children's Cancer Study Group (CCSG) (Study 1, CCG-551) that patients with lymphoblastic disease fared better with the LSA2-L2 protocol whilst those with non-lymphoblastic disease fared better with COMP quite dramatically changed therapeutic approaches throughout the world. Suddenly there was a meaningful way in which to stratify treatment, although it is true to say that the argument as to how you should classify NHL and what constitutes adverse histological features has grumbled on to the present day (although in pediatric practice there has been less dispute about classification and histology, and less of an ability to write a book about the classification of classifications that has been the case in adult practice). The long-term follow-up from CCG-551 has confirmed the original finding.

Jenkin *et al.* reported in 1984 (Study 2) a follow up of the treatment of localized disease on CCG-551 showing no difference either in randomized or non-randomized patients between those who were treated

either with COMP or LSA2-L2. Perhaps surprisingly in this series they had more deaths due to toxicity with COMP (3) than with LSA2-L2 (1), although one additional patient on the latter therapy developed a second malignancy. This report set the scene for attempts in localized disease to achieve comparable event-free survival of 85–90% with least toxicity.

Subsequent studies for non-localized disease generally consider three groups: lymphoblastic, mature B cell (non-lymphoblastic) and diffuse large cell (more recently excluding ALCL). Localized disease trials still often included a homogeneous group of pathologies.

Study 4 reported on a follow up study to CCG-551. Because of excess toxicity for those patients with localized disease receiving LSA2-L2 and given the fact that they appeared to have comparable outcome with COMP, after March 1979 patients with localized disease were treated on CCG-551 with 18 months on COMP and after October 1979 there was a randomization introduced to stop therapy at 6 or 18 months. The next study, which opened in 1982, continued the randomization, although they did change one or two other items, particularly radiation doses and intrathecal therapy. It is always a pity if minor or apparently minor changes are made because one is never certain that they do not have an influence on the overall outcome and consequently it is wiser not to make ongoing small changes until a trial is concluded. As a result of an interim analysis in 1984, CCG actually removed lymphoblastic disease from this trial. Even with localized disease, such patients appeared to be faring adversely. The shortened therapy appeared to be adequate for all non-lymphoblastic patients, with a high event-free and overall survival in excess of 90%. However, there were clearly defects in the trial apart from the minor changes that were brought about as the trial progressed, most

notably a very low uptake for randomization. Only 78 out of 115 patients/parents consented in CCG-551 and only 49 out of 99 in the subsequent CCG-501. It is always immensely difficult to get consent to trials with such a significant difference in length of treatment between arms of a trial. Details are not really included of the reasons for refusal. It would be interesting to note whether patients/parents or physicians opted for longer or shorter therapy since the standard arm had been 18 months previously.

Link *et al.* reported in 1990 (Study 6) on the Pediatric Oncology Group (POG) follow-up study for children with localized NHL to address the question whether or not irradiation was required for such patients receiving a 6-week induction, 3 weeks of consolidation and 24 weeks of maintenance therapy. The irradiation was given during induction (27 Gy to the involved field, 15 Gy for abdominal tumors with a boost to the right lower quadrant and with any primary bone tumors receiving 37.5 Gy). This study showed comparable event-free survival for those receiving chemotherapy alone and those receiving chemotherapy plus radiotherapy. This was the definitive study to confirm that for localized Murphy stage I and II lymphoma involved field irradiation was not required, particularly as it was associated with more severe toxicity. It also confirmed that 8 months of therapy was quite adequate for such tumors.

A further study reported by Link *et al.* in 1997 (Study 10) tested whether a short 9-week regimen was adequate in patients with localized lymphoma. This study was conducted between 1983 and 1991 and was limited to Murphy stage I and II disease. The control arm was the same therapy given in their previous study for approximately 8 months. Randomization was on a 2-to-1 basis to put more patients into the shorter therapy. The key finding was that for low stage disease with non-cleaved cell lymphoma and large cell lymphoma 9 weeks of therapy was found to be adequate. For lymphoblastic disease event-free survival was poorer but overall salvage with further therapy appeared possible, yielding no significant overall survival difference between the two arms. The conclusion was clearly that for selected patients very short therapy based around a CHOP induction with a short duration of consolidation/maintenance including intrathecal therapy was quite adequate.

The POG (Study 3) conducted a randomized trial comparing LSA2-L2 with a regimen containing

doxorubicin, vincristine, prednisolone, cyclophosphamide, intrathecal methotrexate and maintenance with the same drugs in addition to intravenous methotrexate and oral 6 mercaptopurine known as A-COP. This trial was for lymphoblastic lymphoma only and patients with stages I–III disease received 2 years of treatment and those with advanced disease, 3 years, more in line with the then current thinking on duration of therapy for ALL. Cranial irradiation was given in the first 2 years of the protocol and primary site radiation was given to patients with stage I and II disease and to residual sites at 4 weeks for those with stage III and IV disease with a variable radiation dose. There was a bias in the randomization toward the A-COP protocol and only 85 patients were eligible for analysis. This A-COP protocol was much more intensive than COMP and gave comparable results to LSA2-L2. It is important to remember in both this and the original CCG-551 protocol that for stage IV disease event-free survival was still very poor, the biggest advance being in stage III disease. But what would not be acceptable now was the use of adjuvant radiotherapy on top of such intensive chemotherapy. Of interest was the fact that patients with LSA2-L2 did not receive cranial irradiation, something that was generally ignored until almost two decades later, as was the truly remarkable event-free survival of 93%, albeit from a small group of 15 patients with stage III disease treated on the intensive LSA2-L2 protocol.

The success of the LSA2-L2 protocol for LL had also led to a pilot study at Stanford Children's Hospital (Mott and Eden personal communication) which then resulted in the use of a modified LSA2-L2 protocol as the backbone of the UKCCSG T cell leukemia/lymphoma study reported in Study 5. This study attempted to address in a limited number of centers whether adjuvant low dose irradiation, in particular 15 Gy delivered to the mediastinum, would carry any advantage over those treated with chemotherapy only. Forty-seven patients were randomized and the study showed a highly significant benefit in favor of those receiving radiation (66% failure-free survival for those who received radiation versus 18% who did not). This therapy was for T cell leukemia and lymphoma but held up even if the leukemic patients were excluded. Strangely the benefit for the radiotherapy appeared to be a reduction in frequency of spread to the bone marrow and/or CNS. This trial was run in parallel with a study by the remaining

UKCCSG centers for all childhood non-Hodgkin's lymphoma which received a similar randomization. Lymphoblastic disease treated either in the very intensive protocol or the standard protocol with or without irradiation was analyzed. The benefit of local radiation was confirmed. The conclusion of the authors of those studies was that if more effective systemic chemotherapy had been given there would not be a requirement for irradiation, and of course that has proven true with more recent trial results, albeit in a non-randomized fashion.

The CCSG focused on lymphoblastic patients and reported (Study 8) on a study conducted between 1983 and 1990 (CCG-502 for lymphoblastic lymphoma) using the addition of daunorubicin and asparaginase to the basic COMP regimen, creating a protocol known as ADCOMP, and comparing that with the results of LSA2-L2. Both arms contained 18 months of therapy. Only patients with advanced disease had a more favorable outcome than previous reports, with an overall event-free survival of 74% for LSA2-L2 and 64% for ADCOMP. Both arms were associated with toxic deaths but more on LSA2-L2(3) compared with 1 on ADCOMP. There were three cases of secondary AML, all in the ADCOMP arm.

In 1987 the POG initiated a protocol (POG-8704) onto which they enrolled patients with advanced stage T cell lymphoma and leukemia (Study 11). The important randomized question was whether patients would benefit from 12 weekly doses of high dose L-asparaginase (25,000 units/m<sup>2</sup> IM) during continuing therapy. There was perhaps a surprisingly significant benefit for the high dose asparaginase arm for those with ALL, and to a lesser degree those with non-Hodgkin's lymphoma. Of course, sadly the actual survival in the T-ALL group was poor at 30% (7 years) and around 50% for those with NHL. What was much more difficult to explain was an excess of second malignancies in the high dose asparaginase arm. This is an observation that still requires full clarification but has been seen in other non-randomized trials. Though lymphoblastic disease may be sensitive to a higher dose of asparaginase, it may carry with it this unusual and life threatening risk.

Whether the preparation of asparaginase was of importance in LL was studied by the EORTC group (Study 14). Both LL and leukemia were included. The same dose of asparaginase either *Erwinia* or *E. coli* was given twice weekly up to a total of 12 doses. The results

favored *E. coli* although at the cost of increased but reversible toxicity. It remains unclear if the disadvantage to *Erwinia* could be overcome by changes in dose or schedule.

The best published results in LL are from the non-randomized studies from the BFM and describe event-free survival in excess of 80% overall. The EORTC have evaluated the possible benefit of adding high dose cytarabine to consolidation therapy. The outcome was comparable to the BFM achieving 76% disease-free survival for lymphoblastic lymphoma. Overall the addition of cytarabine appeared to have no benefits.

The current Pan-European collaborative study addresses whether prolonged or short infusion of high dose with methotrexate is superior and if 18 months duration of therapy is adequate; when patients have received more intensive induction and intensification.

Some of the most successful studies, particularly in advanced stage B cell lymphoma and leukemia, have been introduced by the French Paediatric Oncology Society in a series of studies some of which have not been randomized. The report by Patte referred to a study carried out between 1984 and 1987, building on their tremendously successful treatment for advanced stage B cell lymphomas (Study 7). This report refers only to patients with less than 25% bone marrow involvement and no CNS disease. Following cytoreductive therapy with COP (two courses of COPADM and one course of CYM; for details see Table 9.1 in Study 7), patients were randomized between further CYM with either a short or long arm of maintenance. This was clearly another key study demonstrating that an intensive 4-month regimen was comparable to a longer 18-month course in advanced stage B cell NHL, which did not involve the CNS or more than 25% of blasts in the bone marrow. It laid the foundations for further subsequent reduction in therapy for other treatment groups.

Brecher *et al.* reported in 1997 (Study 9) on a randomized trial from the POG comparing a new "Total B" regimen which added doxorubicin along with fractionated cyclophosphamide to vincristine followed by cytosine and intravenous methotrexate in escalating dosages compared with a basic "best previous" regimen which consisted of cyclophosphamide, vincristine, prednisolone and methotrexate along with intrathecal therapy. Their more intensive protocol clearly demonstrated benefit in terms of event-free survival.

As with lymphoblastic lymphoma, the BFM results for mature B cell lymphoma are excellent although these studies have not contained randomized questions until recently. In Study 16 the issue of methotrexate schedule was addressed. A 4-hour versus a 24-hour schedule both with 42-hour folinic acid rescue were compared. For low risk groups outcome was similar although toxicity higher with prolonged infusion. In contrast, for the high risk groups R3 and R4 the 24-hour infusion was superior (93% versus 70% progression free over 1 year). In these latter groups this significantly higher incidence of severe mucositis appear to be justified by the lower relapse rate.

The CCG (Study 15) was carried out in the late 1980s and contained a mixture of pathological subtypes. The chemotherapy was less intensive than what is currently used and this was reflected in the poor overall survival (less than 60%). The study failed to show any advantage to the addition of doxorubicin (50 mg/m<sup>2</sup>) to the basic COMP protocol. This indicates that a key factor in the improved outcome with recent, more intense, regimens is based on agents other than anthracycline, that is, higher dose of cyclophosphamide and methotrexate with the application of intensive intrathecal therapy. This would suggest that in future studies strategies to produce early morbidity could perhaps focus on reduction or omission of the anthracycline perhaps facilitated by the use of the monoclonal antibody Rituximab. The potential of the latter agent is currently being assessed with regard to tolerability when combined with the COPADM regimen both by the Children's Oncology Group (COG) group and in other institutions.

Two POG trials have considered therapy for diffuse large cell lymphoma specifically. The regimens have been based on the early POG and CCG protocols. Study 15 failed to show any benefit with the addition of cyclophosphamide (800 mg/m<sup>2</sup>) to the APO regimen. The small number randomized and the variability of pathology limited conclusions from this trial.

Heterogeneity in pathology was also a limitation to Study 16 which included DLBC, ALCL and PTCL. In this study the APO regimen was intensified by the addition of intermediate dose methotrexate and high dose of cytarabine. For DLCL the event-free survival was 70% and ALCL 72% using the APO regimen alone. This is a very encouraging result considering it was comprised stage III and IV disease although the

patients recruited were limited in number. There was no advantage to intensified therapy.

There is a continued debate about the optimum therapy for ALCL. The European approach using adaptations of the intense but short B cell protocols have achieved results which may be slightly superior to those with the relatively simple APO protocol. It must be emphasized that the total dose of anthracycline in APO regimen is considerably higher than that in the shorter intense of regimens and the choice of protocol may therefore depend on perceptions around the importance of acute early morbidity and late cardiac toxicity.

In conclusion, in a small number of randomized trials since 1977 it has been confirmed that for non-Hodgkin's lymphoma: (1) therapy should be stratified by pathological subtype; (2) lymphoblastic disease, whether it be low stage or more advanced, requires a different therapeutic approach and treatment more akin to that given to patients with ALL; (3) localized non-lymphoblastic disease can be treated with short course pulsed therapy without adjuvant radiotherapy and (4) it is crucial to monitor for late sequelae, as exemplified by the excess of second malignancies in the long asparaginase arm of the POG-8704 protocol.

It is salutary to reflect upon the fact that it is only over the past decade or so that we have learnt that up to 15% of childhood NHL may consist of anaplastic large cell lymphomas and that we have only been able to define them clearly with the use of immunohistochemistry and molecular genetics (with the characteristic KI-1 antigen positivity (CD30) and the presence of gene rearrangements involving the nucleolar phosphoprotein gene at 5q35 partnered with a range of protein kinase genes, commonly on chromosome 2 or 1). These patients appear to require rather different therapy but we are only now beginning to run the randomized trials to test for the truly optimal therapy for them. It is such a rare condition that international collaboration is required. This has spurred an interest in running international trials also in lymphoblastic and non-lymphoblastic disease. Many of the answers to the questions that we have posed over the past 30 years could have been answered quicker if we had collaborated earlier and more enthusiastically. Only with large numbers in each trial, inclusion of all eligible patients, strict randomization procedures and protocol compliance can results be trusted and applied more generally.

# Studies

## Study 1

Anderson JR, Wilson JF, Jenkin DT, Meadows AT, Kersey J, Chilc RR, Coccia P, Exelby P, Kushner J, Siegel S, Hammond GD. Childhood non-Hodgkin's lymphoma. The results of a randomized therapeutic trial comparing a 4-drug regimen (COMP) with a 10-drug regimen (LSA2-L2). *New Engl J Med* 1983; **308**:559–65.

This study was undertaken by the American Children's Cancer Study Group (CCSG) between 1977 and 1979 (CCG-551).

### Objectives

The aims of the study were:

- To compare the two chemotherapy regimens.
- To determine the influence of disease extent and histopathological subtype.

### Details of the study

This was a multi-institutional prospective randomized trial. Initially, eligible patients were those aged less than 18 years with untreated, biopsy proven non-Hodgkin's lymphoma with no peripheral blood blasts and less than 25% blasts in the bone marrow (BM), but after 5 months all patients with "undifferentiated" lymphoma regardless of peripheral blood blasts or BM status were deemed eligible.

Staging investigations included clinical examination, BM and CSF examination, chest X-ray, bone survey, intravenous (IV) pyelogram and radionuclide or CT scans of liver, spleen and bone. Localized disease was defined as a tumor limited anatomically either to a single extranodal site, with or without positive regional nodes, or to lymph nodes in one or two adjacent lymphatic regions. Grossly complete excision was required for tumors in the gastrointestinal system to be classed

as localized. All other tumors (including mediastinal) were classified as non-localized.

The histopathological system of Rappaport was used and all specimens were reviewed by the study pathologist.

Randomization was undertaken by phoning the Study Group's central office. Patients who met the eligibility criteria were assigned to one of the two treatments by means of an adaptive randomization plan, to ensure a satisfactory balance of factors that were potentially important in the prognosis – namely, localized versus non-localized, anatomic site, histology, BM and CSF status and age above or under 13 years.

Interim analysis in 1979 showed no difference in outcome in those with localized disease treated on either regimen, but increased toxicity with LSA2-L2, and all patients with localized disease were thereafter assigned to COMP.

Predictions of expected difference or numbers required are not given in the study.

COMP (regimen 1) comprised induction therapy with 1.2 g/m<sup>2</sup> of cyclophosphamide, four doses of vincristine, IV methotrexate 300 mg/m<sup>2</sup> on day 12 and 4 weeks of oral prednisolone, with three doses of intrathecal (IT) methotrexate. Subsequent maintenance courses comprised 1 g/m<sup>2</sup> cyclophosphamide, with two doses of vincristine, 5 days prednisolone, one IT methotrexate and one IV methotrexate.

Modified LSA2-L2 (regimen 2) employed a similar induction regimen, but with the addition of daunorubicin at days 15 and 16. The major difference was in the addition of a consolidation phase, using cytarabine, 6-TG (thioguanine), asparaginase and carmustine, and more complex maintenance cycles, including cyclophosphamide, 6-TG, hydroxyurea, daunomycin, methotrexate, carmustine, cytarabine, vincristine and two doses of IT methotrexate.

Both regimens lasted for 18 months.

The same schedule of radiation was used in all patients. The objective was to irradiate all tissue volumes that were the sites of bulk disease ( $>3$  cm). Localized disease confined to lymph nodes was irradiated to 30 Gy with a 3 cm margin. Bulk disease (e.g. whole abdomen) was irradiated to 20 Gy. Radiation treatment was initiated during induction. CNS radiation was used only for patients with CNS disease at presentation or in those suffering a CNS relapse within 6 months of commencing treatment.

The primary outcome measure was failure-free survival (FFS). Adverse events included no response by the end of induction, a relapse of any kind and death. The product limit method was used to estimate the distribution of FFS and of overall survival. The statistical significance of observed difference in FFS was assessed with the log-rank test.

## Outcome

Two hundred and thirty-four eligible patients entered the study, of whom 23 were not randomized but treated according to an assigned regimen, including the 11 patients with localized disease who were assigned to COMP treatment after the interim analysis. These 11 were not included in the comparison of treatment regimens. Specimens from 25 patients were not reviewed by the study pathologist, and were not analyzed in the comparisons of treatment regimens within histopathological

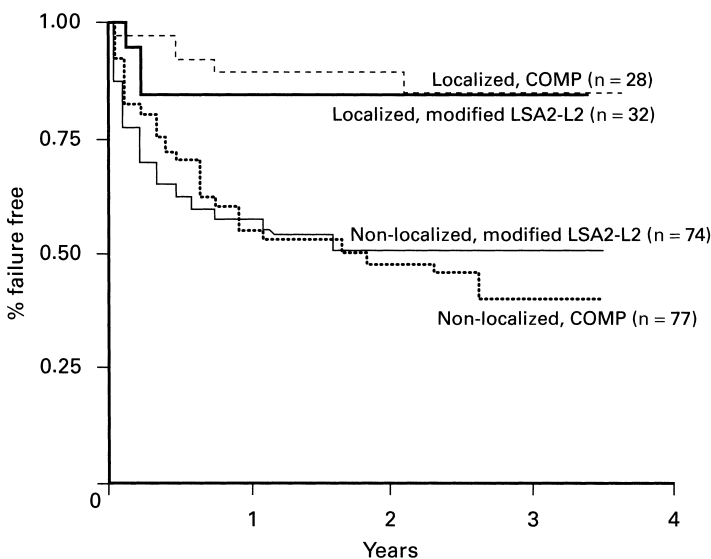
groups. Median follow up for patients who had not had any adverse events was 28 months.

About one-third of patients had localized disease, and 34% were classified as lymphoblastic, 51% as undifferentiated Burkitt or non-Burkitt lymphoma, and 14% as histiocytic.

Sixty patients with localized disease were randomly assigned to treatment: 28 received COMP, 32 received modified LSA2-L2. Two-year FFS was 89% and 84%, respectively ( $p > 0.50$ ) (Figure 9.1).

One hundred and fifty-one patients with non-localized disease were randomly assigned to a treatment group: 77 received COMP and 74 modified LSA2-L2. Overall results did not differ according to regimen, with 24-month FFS being 47% and 50%, respectively ( $p > 0.50$ ).

Significant differences were found only when treatments were compared within histopathological subgroups in patients with non-localized disease. Patients with lymphoblastic lymphoma had a significantly higher FFS at 24 months when treated with LSA2-L2 (76%) than when treated with COMP (26%) ( $p = 0.0002$ ) (Figure 9.2). However, the opposite was true with non-lymphoblastic disease (including histiocytic as well as undifferentiated). FFS at 24 months for non-lymphoblastic disease was 57% for those treated with COMP compared with 28% for those treated with LSA2-L2 ( $p = 0.008$ ) (Figure 9.3).



**Figure 9.1** FFS according to extent of disease at diagnosis and treatment regimen. Adapted with permission from Anderson *et al.* (full reference on p. 166). © 1983 Massachusetts Medical Society.

Further analyses of this group according to whether or not patients with non-localized disease had CNS or BM involvement seemed to show that patients with lymphoblastic disease benefited from treatment with LSA2-L2 regardless of whether or not there was CNS/BM involvement, although the number of patients in this category was very small. Seven patients with CNS/BM involvement treated with LSA2-L2 had FFS of 71%, compared to six patients treated with COMP who had

FFS of 0% ( $p = 0.01$ ). However, COMP treatment benefited only those patients with non-lymphoblastic disease without CNS/BM involvement. For this group the FFS was 29% with LSA2-L2 ( $n = 7$ ) and 33% with COMP ( $n = 6$ ).

CNS relapse was rare and equally distributed between the two treatments.

### Toxicity

There were nine toxic deaths, equally distributed between the two regimens. Hematological toxicity was more common with LSA2-L2, although precise data were not presented.

### Conclusion

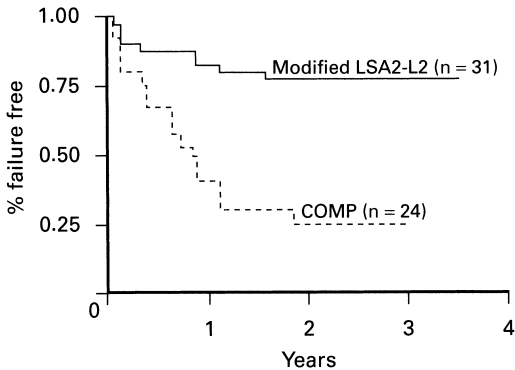
For non-localized non-Hodgkin's lymphomas (NHL), LSA2-L2 was more effective than COMP for the lymphoblastic subtype and the opposite was the case for diffuse undifferentiated NHL. This was a landmark study demonstrating the importance of treating NHL according to histopathological subtype. However, follow up was relatively short, especially as late relapse is relatively more common in lymphoblastic disease compared with non-lymphoblastic disease.

### Comment

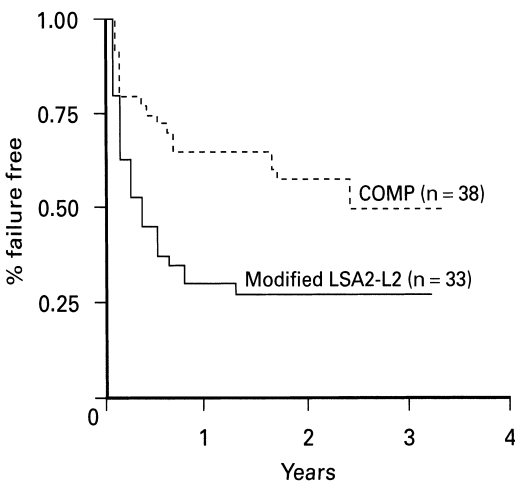
A follow-up analysis of patients on CCG-551 was also reported:

Anderson JR, Jenkin DT, Wilson JF, Kjeldsberg CR, Spasto R, Chilcote RR, Coccia PF, Exelby PR, Siegel S, Meadows AT, Hammond GD. Long-term follow-up of patients treated with COMP or LSA2L2 therapy for childhood non-Hodgkin's lymphoma: a report of CCG-551 from the Children's Cancer Group. *J Clin Oncol* 1993;11:1024-32.

Event-free survival (EFS) of patients with localized disease was 84% at 5 years. No differences were noted between the two regimens. For disseminated disease, outcome was dependent on histological subtype. Patients with lymphoblastic lymphoma did better when treated with LSA2L2; 5-year EFS 64% versus 35% for COMP. COMP produced better results for those with undifferentiated lymphoma: 5-year EFS 50% versus 29%. In large cell lymphoma, results were similar: 5-year EFS of 52% for COMP versus 43% for LSA2-L2.



**Figure 9.2** FFS according to treatment regimen in patients with non-localized disease and lymphoblastic lymphoma only. Adapted with permission from Anderson *et al.* (full reference on p. 166). © 1983 Massachusetts Medical Society.



**Figure 9.3** FFS according to treatment regimen in patients with non-localized disease and non-lymphoblastic lymphoma only. Adapted with permission from Anderson *et al.* (full reference on p. 166). © 1983 Massachusetts Medical Society.

## Study 2

Jenkin RD, Anderson JR, Chilcote RR, Coccia PF, Exelby PR, Kersey JH, Kushner JH, Meadows AT, Siegel SE, Sposto R, Wilson JF, Hammond GD. The treatment of localised non-Hodgkin's lymphoma in children: a report from the Children's Cancer Study Group. *J Clin Oncol* 1984;2:88–99.

This was a collaborative group prospective randomized study which ran between 1977 and 1979.

### Objectives

The aims of the study were:

- To determine the outcome of children with localized disease treated on CCG-551.
- To compare a four-drug regimen (COMP) with the 10-drug LSA2-L2.

### Details of the study

Eligible patients for CCG-551 were those aged less than 21 years with previously untreated non-Hodgkin's lymphoma, provided there were less than 25% blasts. Localized disease was defined as:

- 1 Disease limited to a single extranodal site, with or without regional lymph node involvement.
- 2 Disease limited to one or two adjacent nodal regions.
- 3 Gastrointestinal disease was only defined as localized if a grossly complete surgical excision had been achieved.

Mediastinal disease was excluded, as were patients with Murphy stage II disease at more than two adjacent nodal sites, or those with disease at more than one extranodal site.

Central histology review was undertaken.

Randomization was undertaken by phoning the study group's central office. A method of adaptive randomization was employed to balance patient numbers with regard to localized versus non-localized disease, anatomical site of origin, institutional histological classification and age over or under 13 years. Following an interim analysis, randomization for patients with localized disease was discontinued because of increased toxicity for those patients treated with LSA2-L2 regimen, and from March 1979 all patients with localized disease were treated with COMP.

Treatment was for 18 months on both regimens. Details were given in Study 1. Statistical predictions were not performed.

The primary outcome measure was relapse-free survival.

### Outcome

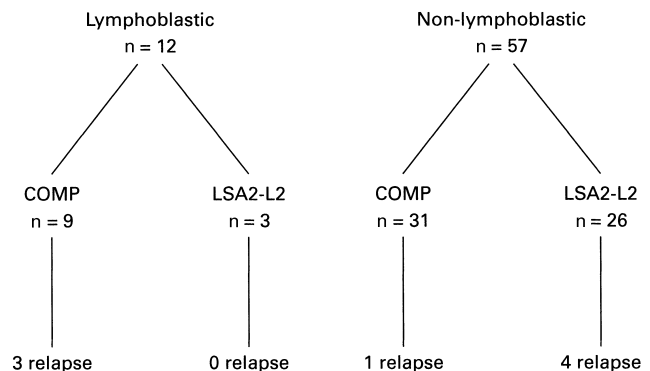
Of the total of 240 patients entered, 73 had localized disease. Follow up at the time of publication was 29–63 months, median 48 months.

Sixty patients were randomized. Two patients received COMP (investigators' choice) and 11 were electively given COMP after the protocol amendment discontinuing randomization.

Overall event-free survival by treatment regimen was 85% for COMP and 84% for LSA2-L2 (including non-randomized patients).

Outcome according to histology is shown in Figure 9.4.

The analysis of the subsets of patients for prognostic factors was not fruitful. Overall analysis of relapse-free



**Figure 9.4** Outcome according to histology. © American Society of Clinical Oncology (full reference above).



survival rates by age, sex, site and treatment regimen gave no significant differences.

### Toxicity

There were four toxic deaths, three with COMP and one with LSA2-L2. One patients who received LSA2-L2 developed a second malignancy.

### Conclusion

It was concluded that the overall results were good and outcome did not appear to be influenced by the regimen used.

## Study 3

Hvizdala EV, Berard C, Callihan T, Falleta J, Sabio H, Shuster JJ, Sullivan M, Wharam MD. Lymphoblastic lymphoma in children – a randomised trial comparing LSA2-L2 with the A-COP therapeutic regimen: a Pediatric Oncology Group Study. *J Clin Oncol* 1988; 6:26–33.

This study was undertaken by the Pediatric Oncology Group (POG) between the years of 1979 and 1983 (POG-7905).

### Objectives

The aim of the study was:

- To address the comparative efficacy of a six-drug regimen, A-COP, with the 10 drugs and modified LSA2-L2.

### Details of the study

The study was conducted as a collaborative group multi-institutional prospective randomized trial.

The original design employed a stratification for histology, but did not plan for stratum-specific analysis. However, following publication of the results of another study (CCG-551), this design was made obsolete, leading to a complete separation of the lymphoblastic and non-lymphoblastic patients. A second major change occurred when patients were retrospectively staged according to the Murphy system. For the first 2 years the randomization was weighted 3:1 in favor of A-COP (regimen I), as the LSA2-L2 (regimen II) was identical to a previous study, but this was then discontinued.

Eligible patients were those aged less than 21 years with untreated biopsy proven lymphoblastic lymphoma.

Specimens underwent central pathological review and were classified according to the system of Rappaport.

The randomization method is not described and statistical predictions were not performed.

Both treatment regimens lasted 2 years for patients with stages I–III disease and 3 years for stage IV disease. The A-COP regimen comprised induction with doxorubicin, vincristine, prednisolone, cyclophosphamide, intrathecal methotrexate and maintenance with the same drugs, in addition to intravenous methotrexate and oral 6 mercaptopurine. Cranial radiation was only given to patients receiving A-COP. Primary site radiation was given in both regimens to stage I and II disease, and to residual sites at 4 weeks for those with stage III/IV disease. The dose for regimen I was 21 Gy compared with 30 Gy for regimen II.

The primary outcome measure was disease-free survival (DFS).

### Outcome

Eighty-five patients with histologically confirmed lymphoblastic lymphoma were entered. Eleven had localized (stage I and II) disease, 56 had stage III and 18 had stage IV. Fifty were randomized to A-COP and 35 to LSA2-L2. Nine patients were non-evaluable (failure to follow randomization in two, major protocol violation in six and inadequate data in one).

Overall DFS for A-COP was 53% (SE 8%) and 58% (SE 10%) for LSA2-L2 at 3 years. This was not statistically significant.

For stage IV disease, 3-year event-free survival was 14% and 12%, respectively; in stage III, 93% and 54% (15/33 failures compared to 2/15;  $p = 0.055$ ).

There was no increase in CNS relapse rates in the LSA2-L2 group who did not receive cranial radiation.

## Toxicity

Induction toxicity was greater with regimen LSA2-L2, with three life threatening sepsis episodes compared to none with A-COP. Maintenance therapy toxicity was comparable, although there were two remission deaths due to infection on A-COP. There were also two deaths from cardiotoxicity in the A-COP group.

## Conclusion

It was concluded that, unlike COMP, the more intensive regimen A-COP was comparable to LSA2-L2 for lymphoblastic NHL. There appeared to be an advantage with LSA2-L2 for stage III disease, although numbers were too small to confirm this statistically.

## Study 4

Meadows AT, Sposto R, Jenkin RD, Kersey JH, Chilcote RR, Siegel SE, Coccia PF, Rosenstock J, Pringle KC, Stolar CJ, Kadin ME, Hammond GD. Similar efficacy of 6 and 18 months of therapy with four drugs (COMP) for localized non-Hodgkin's lymphoma of children: a report from the Children's Cancer Study Group. *J Clin Oncol* 1989;7:92-9.

This study was undertaken between the years 1979 and 1986 by the Children's Cancer Study Group (CCSG).

### Objectives

The aim of the study was:

- To address the question whether a shortened duration of therapy (6 months) was sufficient for localized non-Hodgkin's lymphoma.

### Details of the study

The study design entailed the randomization of patients in two consecutive CCSG non-Hodgkin's lymphomas (NHL) studies, CCG-551 and CCG-501.

The CCG-551 study had originally randomized all NHL patients between COMP and LSA2-L2. Because of excess toxicity for patients with localized disease receiving LSA2-L2, from March 1979 all those with localized disease were allocated to 18 months of COMP. From October 1979 these patients were randomized between discontinuing therapy after 6 and 18 months therapy. The follow on study, CCG-501, opened in 1982, with slight modifications with respect to intrathecal (IT) and radiation doses but continuing randomization between 6 and 18 months therapy with the same eligibility criteria. In 1984 a preliminary analysis suggested

that those with lymphoblastic histology were doing less well and these were excluded from entry.

Eligible patients were those under the age of 21 years with localized disease, defined as no more than two lymph node regions on one side of the diaphragm, or a single primary site with or without regional node involvement. For abdominal disease, only those with a grossly complete excision were included. External review of the histology was undertaken and the classification was based on the system of Rappaport.

Patients were randomized after five cycles of maintenance therapy using an unstratified randomization.

Primary endpoints were event-free survival (EFS) and survival. Analysis of EFS was based only on patients accepting randomization, whilst the analysis of overall survival included patients who electively continued or discontinued. Plots of survival and EFS were derived from the product limit (Kaplan-Meier) estimate, and based on a one-sided log-rank test with 10% type I error. The power to detect a 10% decrease in EFS 2 years after randomization was estimated to be >75%. Statistical predications of the number of patients required are not given in the study.

COMP treatment was detailed in Study 1. CCG-501 included minor modifications in the dosage and timing of IT methotrexate doses and omitted IT chemotherapy for patients with localized abdominal disease. The radiation guidelines were modified, reducing the margin from 3 to 2 cm, and the dose to 15 Gy to the abdomen and 20 Gy to other areas.

### Outcome

A total of 241 patients with localized NHL were registered. Nine were excluded on the basis of ineligibility: three were not localized, three were not classified as having NHL on pathological review and three who were

diagnosed after 1984 with lymphoblastic histology were electively treated with LSA2-L2.

One hundred and thirty patients were registered on CCG-551, of whom 11 had an event before completing six cycles and four discontinued prior to completing six cycles at either parents' or physician's preference. Of 115 patients eligible for randomization, 78 consented. For the CCG-501 study, 102 eligible patients were registered, of whom two had an event prior to completing six cycles, and one electively stopped treatment prior to completing 6 months' therapy. Of 99 eligible for randomization, 49 consented.

Of the total randomized patients ( $n = 127$ ), 12 had lymphoblastic histology and 115 non-lymphoblastic.

For the patients with non-lymphoblastic histology, 104 of the 115 patients followed the assigned length of treatment and results were presented for these patients (rather than on an intention to treat basis). There was

no difference in EFS for those randomized to receive 6 months' treatment (EFS 95%) compared with those randomized to 18 months' treatment (EFS 98%).

Overall survival from diagnosis for patients with NHL treated on CCG-551 (median follow-up 60 months) was 91%.

For patients with lymphoblastic histology, because of small numbers, it was not possible to compare the efficacy of the two different lengths of treatment. Overall survival from diagnosis for patients with lymphoblastic disease treated on CCG-551 was less than 70% (i.e. 11/15 patients alive).

No details of toxicity are given in the study.

### Conclusion

It was concluded that 6 months of therapy for patients with non-lymphoblastic localized lymphoma is sufficient.

## Study 5

Mott MG, Chessells JM, Willoughby ML, Mann JR, Morris-Jones PH, Malpas JS, Palmer MK. Adjuvant low dose radiation in childhood T cell leukaemia/lymphoma. *Br J Cancer* 1984;50:457–62.

The study was carried out by the United Kingdom Children's Cancer Study Group (UKCCSG) between 1977 and 1983. Six centers within the UKCCSG contributed patients to the study.

### Objectives

The aim of the study was:

- To determine whether 15 Gy mediastinal radiation was necessary in the treatment of T cell leukaemia/lymphoma.

### Details of the study

Eligible patients were those with localized or non-localized T cell lymphoma or T cell leukemia with mediastinal disease.

It is not clear at what point patients were randomized to receive or not receive mediastinal radiation,

but this appears to have been at the completion of successful induction treatment.

The chemotherapy was a complex multiagent regimen (Figure 9.5) including induction, consolidation and 2 years maintenance therapy.

All patients received cranial radiation therapy, 17.6 Gy. Patients were randomly assigned to receive 15 Gy to the mediastinum irrespective of whether there was a mediastinal mass at diagnosis.

The method of randomization is not detailed and statistical predictions are not given.

Outcome measures were survival and failure-free survival (FFS).

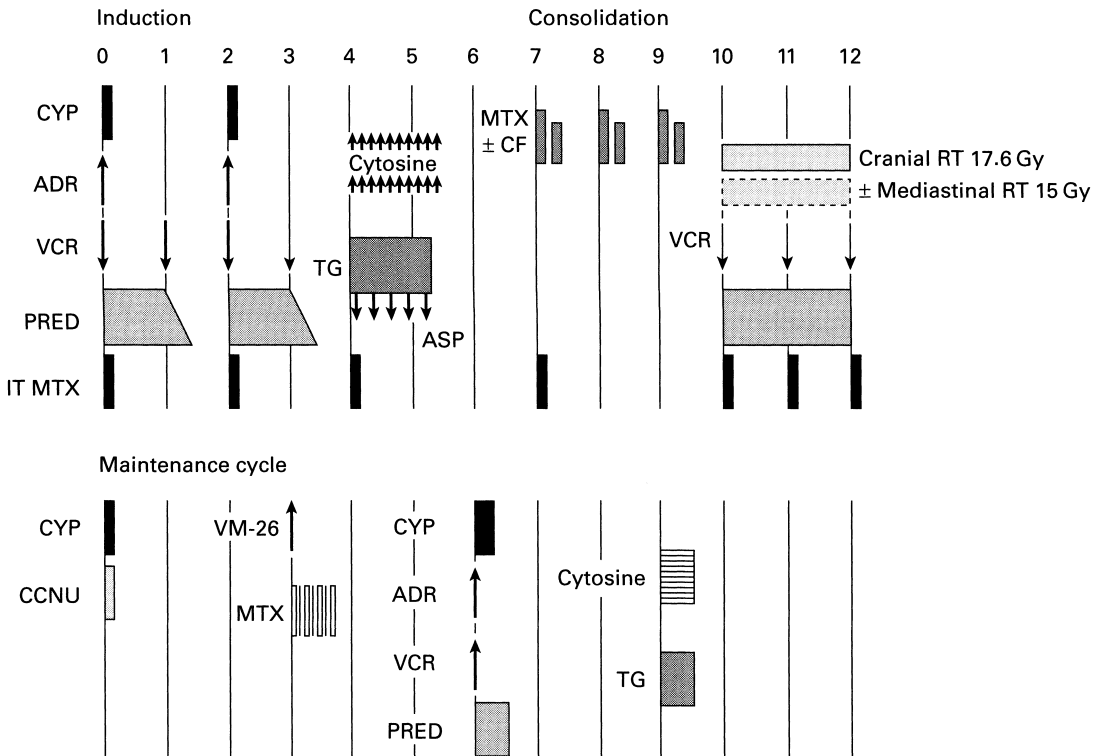
### Outcome

Eighty-two patients were entered on the study, of whom 57 had more than 25% lymphoblasts in the bone marrow and/or peripheral blood blasts and were classified as having T leukemia. Twenty-five were designated as having T lymphoma.

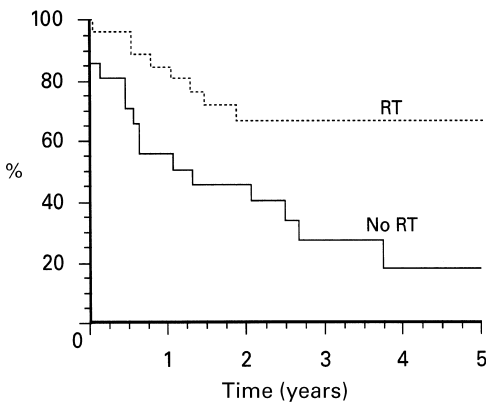
There were 27 patients who presented with a mediastinal mass.

The overall FFS for patients with T leukemia was 27%. FFS for patients with T lymphoma treated was 40%.

Forty-seven of fifty-two successfully completed induction and were randomized to receive or not receive



**Figure 9.5** Treatment schema: T cell protocol. ADR: adriamycin (doxorubicin); ASP: asparaginase; CF: folinic acid; CYP: cyclophosphamide; MTX: methotrexate; PRFD: prednisone; RT: radiotherapy; TG: thioguanine; VCR: vincristine. Adapted from Mott *et al.* (full reference on p. 172) with permission from Nature, Macmillan Publishers Ltd.



**Figure 9.6** FFS for T lymphoma patients randomized with or without mediastinal radiation (RT). Adapted from Mott *et al.* (full reference on p. 172) with permission from Nature, Macmillan Publishers Ltd.

mediastinal radiation. There was a highly significant difference in favor of those randomized to receive radiation (FFS 66% versus 18%,  $p = 0.01$ ) (Figure 9.6).

The difference remained significant when patients with T leukemia were included (FFS 51% versus 21%,  $p = 0.01$ ).

### Conclusion

Review of the first adverse events showed that the major differences in the two arms of the trial were in the frequency of spread to the bone marrow and/or CNS, and in the late occurrence of relapse in the non-irradiated patients. There were three patients randomized to receive radiation before completion of induction who then had early adverse events, but even

when these patients were excluded from the analysis the difference between the two arms of the trial remained significant. It is suggested by the authors that the benefit observed from radiation would not have been seen if given in conjunction with more effective systemic chemotherapy.

A second paper describes all 120 children with T and B NHL in the same study showing no difference for non-mediastinal primary disease.

Mott MG, Eden OB, Palmer MK. Adjuvant low dose radiation in childhood non-Hodgkin's lymphoma. *Br J Cancer* 1984;**50**:463–9.

## Study 6

Link MP, Donaldson SS, Costan WB, Shuster JJ, Murphy SB. Results of treatment of childhood localized non-Hodgkin's lymphoma with combination chemotherapy with or without radiotherapy. *New Engl J Med* 1990;**322**:1169–74.

This study was undertaken by the Pediatric Oncology Group (POG) between 1983 and 1987.

### Objectives

The aim of the study was:

- To address the question of whether or not irradiation of primary involved sites could be safely omitted from the treatment of children with localized NHL; in addition, treatment duration was shorter than in previously described regimens.

### Details of the study

This was a multicenter, prospective randomized trial. Eligibility criteria were previously untreated patients aged under 21 years with biopsy proven non-Hodgkin's lymphoma (NHL), categorized as either Murphy stage I or II. Histology was reviewed by a panel of pathologists. Staging investigations included clinical evaluation, FBC, bone marrow aspirate, CSF examination, chest X-ray, bone scan and CT scan in children with head and neck tumors or intra-abdominal disease.

Randomization was performed by phoning the statistical office of the POG.

It was calculated that in order to detect a 10% improvement in event-free survival (EFS) after 2 years, assuming an accrual rate of 80 patients per year, a power of 80%, and a one-sided p-value of 5%, 127 patients were required. Because of the rarity of the disease this

number of patients was deemed to be unachievable within an acceptable time frame and therefore a reduced power for the study was accepted.

The primary endpoints were EFS and overall survival (OS). Adverse events were defined as failure to achieve remission, relapse, death or a second malignancy.

Treatment consisted of a four drug, 6-week induction, including vincristine, cyclophosphamide, doxorubicin and prednisolone, followed by a 6-week consolidation using the same drugs, and 24 weeks of maintenance with mercaptopurine and methotrexate. CNS treatment comprised three doses of intrathecal methotrexate during induction, with further doses during maintenance only for those with head and neck tumors. For those assigned to receive radiation treatment, this commenced during induction, and comprised 27 Gy to the involved field. Abdominal tumors received 15 Gy whole abdominal radiation with a boost to the right lower quadrant. Primary bone tumors were all treated with 37.5 Gy to the involved bone.

### Outcome

The study registered 144 patients, of whom seven were ineligible following review, two because the diagnosis of NHL could not be confirmed and five because the staging definitions of localized disease could not be satisfied. Seven patients had primary bone disease and were not randomized. An additional patient was not randomized in error, leaving 129 eligible randomized patients. Three patients who were assigned to received chemotherapy plus radiation but who did not comply, receiving chemotherapy alone, were analyzed on the arm to which they were allocated. Twenty-one patients had lymphoblastic disease, 72 had small non-cleaved cell and 27, large cell.

All patients achieved complete remission at the end of induction.

Projected EFS at 4 years was  $87.9 \pm 8.8\%$  for patients receiving chemotherapy alone and  $87.3 \pm 9.4\%$  for those receiving chemotherapy plus radiotherapy.

There were seven treatment failures in each group. These were all relapses in the chemotherapy group, but in the combined therapy group there were five relapses, one toxic death and one acute myeloid leukemia. Five of the twenty-one patients with lymphoblastic disease suffered a relapse, compared with 6 of the 72 with small non-cleaved cell.

### Toxicity

Hematological toxicity was more severe in the combined group (36% severe neutropenia) than in the chemotherapy group (15% severe neutropenia).

### Conclusion

Involved field radiation therapy is unnecessary for localized Murphy's stage I/II lymphoma. A shorter duration of therapy seems to cure the majority of children.

## Study 7

Patte C, Philip T, Rodary C, Zucker J-M, Behrendt H, Gentet J-C, Lamagnere J-P, Otten J, Duffillot D, Pein F, Caillou B, Lemerle J. High survival rate in advanced-stage B-cell lymphomas and leukemias without CNS involvement with a short intensive polychemotherapy: results from the French Paediatric Oncology Society of a randomized trial of 216 children. *J Clin Oncol* 1991; 9:123–32.

The study was organized by the French Paediatric Oncology Society (SFOP) between 1984 and 1987.

### Objectives

The aim of the study was:

- To address the possibility of reducing the length of treatment with multiagent chemotherapy from 7 to 4 months.

### Details of the study

Eligibility included patients 17 years or younger, with B cell lymphoma, defined by surface immunoglobulin positivity in addition to B cell antigen positivity. In the absence of immunophenotyping, only Burkitt or diffuse small non-cleaved lymphoma or lymphoma arising in the bowel were included. "Advanced" disease comprised Murphy stage III and IV without CNS involvement. Patients with more than 25% bone marrow or CNS disease were eligible for a more intensive regimen, LMB 86. Patients with extensive nasopharyngeal or facial stage II tumors were also included. Pre-treatment specimens were reviewed by a panel of pathologists and cytologists.

Bone marrow evaluation consisted of at least two iliac crest bone marrow aspirates.

Randomization was performed centrally at the Institut Gustave-Roussy. Patients were randomized after completion of CYM1, that is, the third intensive induction course, when in first complete remission (CR). Two arms were balanced in blocks of four and were stratified to take into account both stage and institution (Figure 9.7).

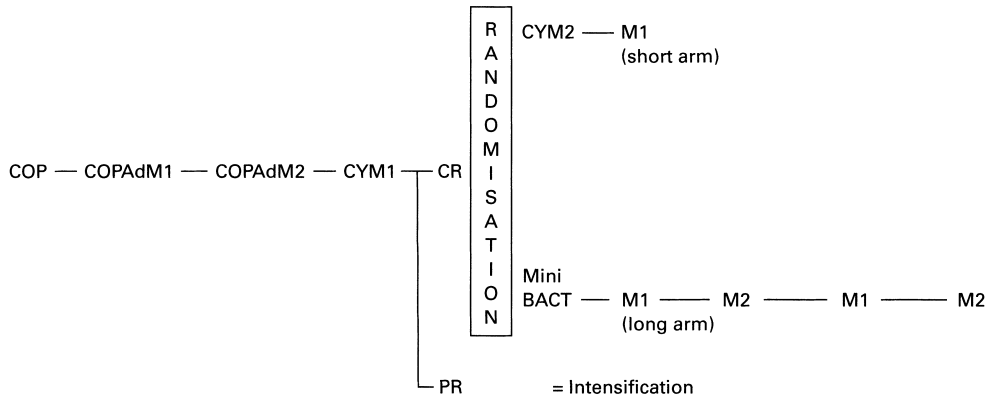
A sequential stopping rule was planned in order to detect an increase in the 9-month relapse rate from 5% to 25% ( $\alpha$  error 10%,  $\beta$  error 5%). The 18-month event-free survival (EFS) for patients in CR after the third induction course and receiving the long treatment was estimated to be equal to 90% in the previous study (LMB 81). The null hypothesis of inequivalence to be tested was whether short treatment reduced EFS by 15% or more than 18-month. A sample size of 75 patients in each group was required ( $\alpha$  5%,  $\beta$  15%). Two successive analyses were planned: the first when the last patient was included and the final one 18 months later. The upper limit of a one-sided 95% confidence interval for the difference between the 15-month EFS rate was calculated using the nominal significance levels of 5% and 4.8%, respectively, for the first and second analysis, necessary to achieve a 5% overall significance level. If this observed confidence limit was less than 15%, one could assume the two arms were equivalent.

The outline chemotherapy is given in Table 9.1 along with the drug doses in each arm.

The primary outcome measure was EFS at 18 months.

### Outcome

Two hundred and sixteen patients were registered, aged 6 months to 17 years, median 5.5 years. One hundred



**Figure 9.7** Schema of protocol LMB 84 (for abbreviations and details of chemotherapy see Table 9.1). © American Society of Clinical Oncology (full reference on p. 175).

**Table 9.1** LMB-84 chemotherapy regimens.

COP	Cyclophosphamide 300 mg/m <sup>2</sup> , vincristine 1.5 mg/m <sup>2</sup> , prednisolone 2 mg/kg/day × 7, IT methotrexate/hydrocortisone
COPAdM1	Cyclophosphamide 500 mg/m <sup>2</sup> /day × 3, doxorubicin 60 mg/m <sup>2</sup> , vincristine 1.5 mg/m <sup>2</sup> , prednisolone 2 mg/kg/day × 7, IT methotrexate/hydrocortisone × 2, methotrexate 3 g/m <sup>2</sup> + folinic acid rescue
COPAdM2	As for COPAdM1 but vincristine added on day 6 and cyclophosphamide dose increased to 1 g/m <sup>2</sup> /day × 3
CYM	Methotrexate 3 g/m <sup>2</sup> + folinic acid rescue, cytarabine 100 mg/m <sup>2</sup> continuous infusion × 5 days, IT cytarabine/hydrocortisone
Mini BACT	CCNU 60 mg/m <sup>2</sup> , cytarabine 100 mg/m <sup>2</sup> /day × 5, 6 thioguanine 150 mg/m <sup>2</sup> /day × 5 cyclophosphamide 500 mg/m <sup>2</sup> /day × 3
M1	Vincristine 1.5 mg/m <sup>2</sup> , methotrexate 3 g/m <sup>2</sup> + folinic acid rescue, prednisolone 2 mg/kg × 5, cyclophosphamide 500 mg/m <sup>2</sup> /day × 2, IT methotrexate/hydrocortisone
M2	CCNU 60 mg/m <sup>2</sup> , cytarabine 100 mg/m <sup>2</sup> /day × 4 subcutaneously, 6 thioguanine 150 mg/m <sup>2</sup> /day × 4, IT cytarabine/hydrocortisone

and seventy-two patients were male. Sixty patients were of North African origin and nine from other countries. Fifteen had stage II disease, 167 stage III and 34 stage IV, of whom 20 had more than 25% blasts in the bone marrow.

Two hundred and two patients achieved a CR, and of these 192 had received the planned initial treatment. In three cases CR was achieved with treatment modified due to toxicity, and seven who were in partial remission at time of CYM1 achieved subsequent CR with intensified treatment. Fourteen patients failed to achieve CR and they all died. Of the 192 patients who received the planned protocol, 166 were randomized, 84 to the long

arm and 82 to the short arm. Of the 26 not randomized, in 4 this was due to early toxic death and in 4 to early disease relapse. The variety of other reasons are also defined. Four African patients were lost to subsequent follow up.

In the randomized group, the overall survival and EFS at 18 months were 90 ± 4% and 89 ± 3% in the short arm and 89 ± 4% and 87 ± 4%, respectively for the long arm. Numbers were insufficient to perform subgroup analysis on the basis of stage. For stage IV the EFS was not significantly different if there were less or more than 25% blasts in the bone marrow, 71% and 65%, respectively. In the short study arm all eight deaths occurred after a relapse, in the long arm seven

died after a relapse and three in first CR (one sepsis, one after sternal marrow puncture and one with EBV infection). The final analysis carried out in March 1989 showed the upper confidence limit of the observed difference between the 18-month EFS (87% and 89%, respectively) for the long and short arm was 6%. This was, therefore, less than 15% value fixed a priori. A comparison between the two proportions of failures (9 of 80 versus 11 of 82, respectively for the short and long arm) according to the null hypothesis of inequivalence was significant (one-sided  $p < 0.001$ ).

The equivalence between the two arms was therefore concluded.

### Conclusion

This study demonstrates that a short intensive 4-month regimen produces excellent event-free survival in advanced B cell NHL and provided the basis for subsequent randomizations with further reduction of treatment intensity.

## Study 8

Tubergen DG, Krailo MD, Meadows AT, Rosenstock J, Kadin M, Morse M, King D, Steinherz PG, Kersey JH. Comparison of treatment regimens for pediatric lymphoblastic non-Hodgkin's lymphoma: a Children's Cancer Study Group study. *J Clin Oncol* 1995;13:1368–76.

The study ran between the years of 1983 and 1990 was undertaken by the Children's Cancer Study Group (CCSG), and was a collaborative group prospective randomized study (CCG-502).

### Objectives

The aim of the study was:

- To determine whether in lymphoblastic lymphoma the addition of daunorubicin and asparaginase to the basic COMP regimen (ADCOMP), would improve or at least equal the results achieved with modified LSA2-L2, but with lower toxicity.

### Details of the study

The study was open to newly diagnosed patients with lymphoblastic non-Hodgkin's lymphomas aged less than 22 years with 25% or less lymphoblasts in bone marrow aspirate. Marrow involvement up to 5% was defined as M1, whilst marrow involvement of 5–25% was defined as M2. Central review of histology was undertaken. A diagnosis of lymphoblastic histology was made when there was a monotonous population of medium sized cells, with sparse cytoplasm, irregular, often convoluted nuclear membrane, fine delicate chromatin and small nucleoli. Immunophenotyping was performed if there was sufficient material.

Randomization was performed separately for each of five groups defined by presentation:

- 1 Localized disease.
- 2 Disseminated disease without mediastinal involvement with M1 bone marrow.
- 3 Disseminated disease without mediastinal involvement with M2 marrow.
- 4 Disseminated disease with mediastinal disease with M1 marrow.
- 5 Disseminated disease with mediastinal disease with M2 marrow.

Localized disease was defined as:

- 1 Completely grossly resected gastrointestinal disease.
- 2 Waldeyer's ring with/without cervical and or supraclavicular disease.
- 3 Single extralymphatic site with/without regional node involvement.
- 4 Nodal disease limited to a single or two adjacent lymphatic regions.
- 5 Exclusions: mediastinal, bone, bone marrow, CNS involvement.

The study was designed to accrue sufficient patients to detect a twofold decrease in the failure rate associated with LSA2-L2 as compared with the ADCOMP regimen with probability 0.80 when using a two-sided log-rank test at the 0.05 level of significance.

Treatment details of modified LSA2-L2 were given in Study 1 (Anderson *et al.*).

ADCOMP added daunorubicin at day 16 to the basic COMP induction, and nine doses of asparaginase also commencing at day 16. "Maintenance" COMP cycles added daunorubicin at 30 mg/m<sup>2</sup>. Both regimens lasted for a minimum of 18 months and included radiation therapy to areas of bulk disease greater than



3 cm diameter either in the mediastinum or elsewhere, beginning on day 5 of induction therapy.

The primary outcome measure was event-free survival (EFS). The duration of EFS was from entry on to the study to disease progression, death in remission, occurrence of a second neoplasm or last contact. Plots of estimated survivor functions were constructed using the method of Kaplan–Meier, and treatment comparisons made using the stratified log-rank test. Analyses were performed according to intent to treat.

### Outcome

Three hundred and seven patients were entered, of whom 26 were excluded. In 19 this was following histopathological review. Six patients were not randomized and one who was not entered had more than 25% lymphoblasts in the bone marrow. Twenty-eight patients had localized disease. One hundred and forty-four specimens had immunophenotyping performed locally, showing a T cell phenotype in 79%, B cell in 5% and null cell in 17%.

The overall 5-year EFS was 74% for LSA2-L2 and 64% for ADCOMP ( $p = 0.17$ ). When analyzed according to the extent of disease groupings, there was no difference by treatment group, except in those with the most advanced disease, that is mediastinal disease and a M2 marrow, who had fewer relapses with LSA2-L2 (3/12) than on the ADCOMP therapy (8/11) ( $p = 0.026$ ).

### Toxicity

Toxicity was moderately severe on both regimens. There were four toxic deaths, three with LSA2-L2 and one with ADCOMP. There were three cases of AML, all in ADCOMP patients.

### Conclusion

The addition of daunorubicin and asparaginase to COMP therapy for patients with lymphoblastic lymphoma did not result in a more effective treatment than LSA2-L2.

## Study 9

Brecher ML, Schwenn MR, Coppes MJ, Bowman WP, Link MP, Costan WB, Shuster JJ, Murphy SB. Fractionated cyclophosphamide and back to back high dose methotrexate and cytosine arabinoside improves outcome in patients with stage III high grade small non-cleaved cell lymphomas: a randomised trial of the Pediatric Oncology Group. *Med Ped Oncol* 1997;29: 526–33.

This was a multicenter prospective randomized trial undertaken by the American Pediatric Oncology Group (POG) between 1986 and 1991 (POG-8616).

### Objectives

The aim of the study was:

- To address the question of whether the “Total B” regimen, which had been reported to give encouraging results in a single institution study, would prove superior when compared in a prospective randomized fashion against the group’s previous best standard therapy, protocol 8106.

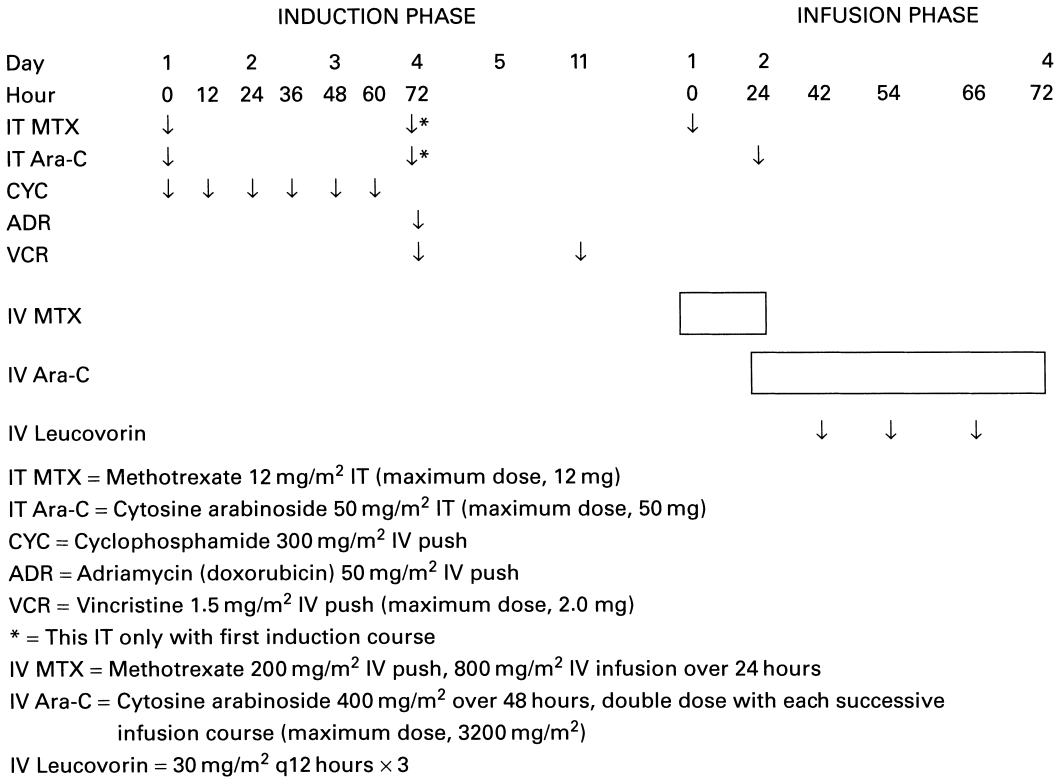
### Details of the study

Eligible patients were under the age of 21 years, with newly diagnosed diffuse, undifferentiated non-Hodgkin’s lymphomas, small non-cleaved cell (Burkitt or non-Burkitt), according to the Working Formulation, which was stage III according to the Murphy staging system. Staging investigations included clinical evaluation, FBC, bone marrow and CSF examination, and CT scan of involved areas.

Other than stating that all patients were randomized no further details are given in the study about randomization methods.

Statistical predictions do not seem to have been performed prospectively. However, calculations were performed based on the number of eligible patients actually recruited, and it was calculated that based on a proportional hazards model, a study of 123 eligible patients has a 80% power to detect a 20% improvement in event-free survival (EFS) from 65% at  $p = 5\%$ , one-sided. The power number is exact if failure is deemed impossible after 2 years, and higher if failure is possible.

Protocol 8106 (regimen A) employed cyclophosphamide, vincristine, prednisolone and methotrexate,



**Figure 9.8** Regimen B chemotherapy. Reprinted from Brecher *et al.* (full reference on p. 178) with permission from Wiley-Liss, Inc., a subsidiary of John Wiley & Sons, Inc.

with triple intrathecal chemotherapy throughout the 7 months of therapy, whereas “Total B” (regimen B) added doxorubicin, along with fractionated cyclophosphamide and vincristine, followed by cytosine and intravenous methotrexate, the doses of which escalated with subsequent courses (Figures 9.8 and 9.9). No patient received radiotherapy.

Intention to treat was utilized in all of the analyses, and EFS was the primary end point measured from the time of initial therapy. Events were defined as induction death, progressive disease, relapse and death in remission or second malignancy.

**Outcome**

One hundred and thirty-four patients were registered, of whom 11 were excluded after central pathology review. Sixty-five patients were randomized to regimen

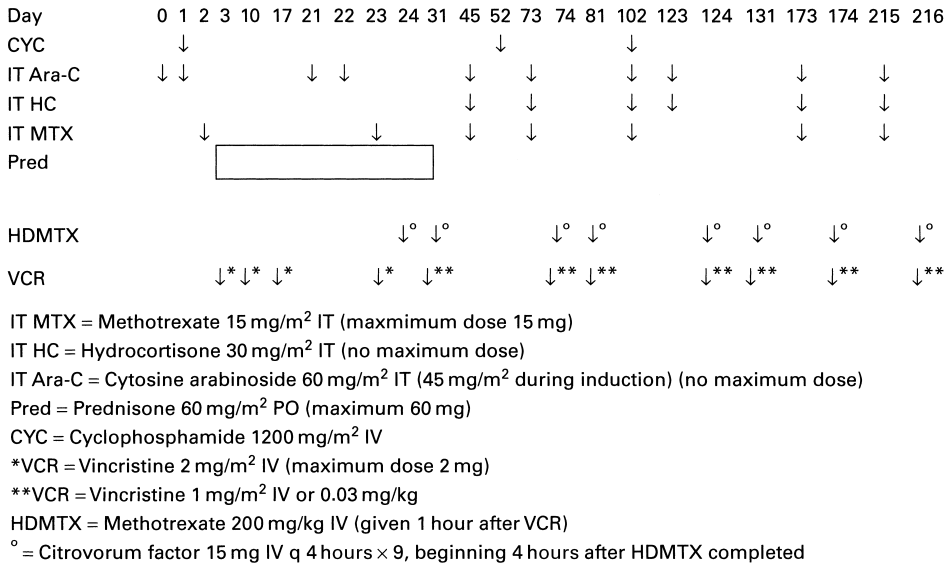
A, 58 to regimen B. On regimen A 52/64 achieved complete response, compared to 55/58 on regimen B. The difference was statistically significant with a p-value of 0.014. EFS was 64% for regimen A compared to 79% for regimen B (p = 0.027) (Figure 9.10).

**Toxicity**

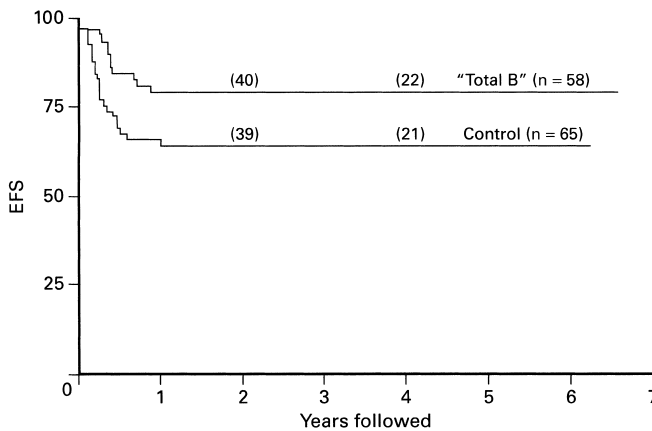
There were two induction deaths on each regimen, but hematological toxicity was more severe on regimen B.

**Conclusion**

The “Total B” therapy resulted in a significant improvement in EFS, which seemed mainly to result from a better initial complete response rate.



**Figure 9.9** Regimen A chemotherapy. Reprinted with permission (see Figure 9.8).



**Figure 9.10** EFS for patients treated on the control arm (regimen A) and total B therapy (regimen B). EFS was measured from time of initial therapy, utilizing the log-rank method. Reprinted with permission (see Figure 9.8).

## Study 10

Link MP, Shuster JJ, Donaldson SS, Berard CW, Murphy SB. Treatment of children and young adults with early-stage non-Hodgkin’s lymphoma. *New Engl J Med* 1997;337:1259–66.

This was a Pediatric Oncology Group study undertaken between 1983 and 1991.

### Objectives

The aim of the study was:

- Whether a short 9-week regimen was adequate in patients with localized non-Hodgkin’s lymphoma.

**Details of the study**

Eligible patients were those aged under 21 years with untreated biopsy proven non-Hodgkin's lymphomas categorized as Murphy's stage I/II. The histopathological findings were classified according to the Working Formulation.

The study was designed to allow the inclusion of patients treated on a study undertaken between 1983 and 1987 in which all patients had received 8 months of chemotherapy, with a 6-week induction, 3-week consolidation and 24-week "maintenance" phase, but had been additionally randomized to receive or not receive radiation therapy. In the second trial, undertaken between 1987 and 1991, patients who were in complete remission after induction/consolidation were randomly allocated between 9 weeks of induction/consolidation treatment only *or* 9 weeks of induction/consolidation *plus* 24 weeks of therapy (Figure 9.11).

Patients were allocated between the 9-week versus the 8-month therapy on a 2:1 basis.

Chemotherapy comprised standard CHOP, with 6 MP/methotrexate maintenance and intrathecal methotrexate, cytarabine and hydrocortisone (Table 9.2).

Because the study question was negative, a one-sided p-value of 0.10 or less in favor of the 8-month

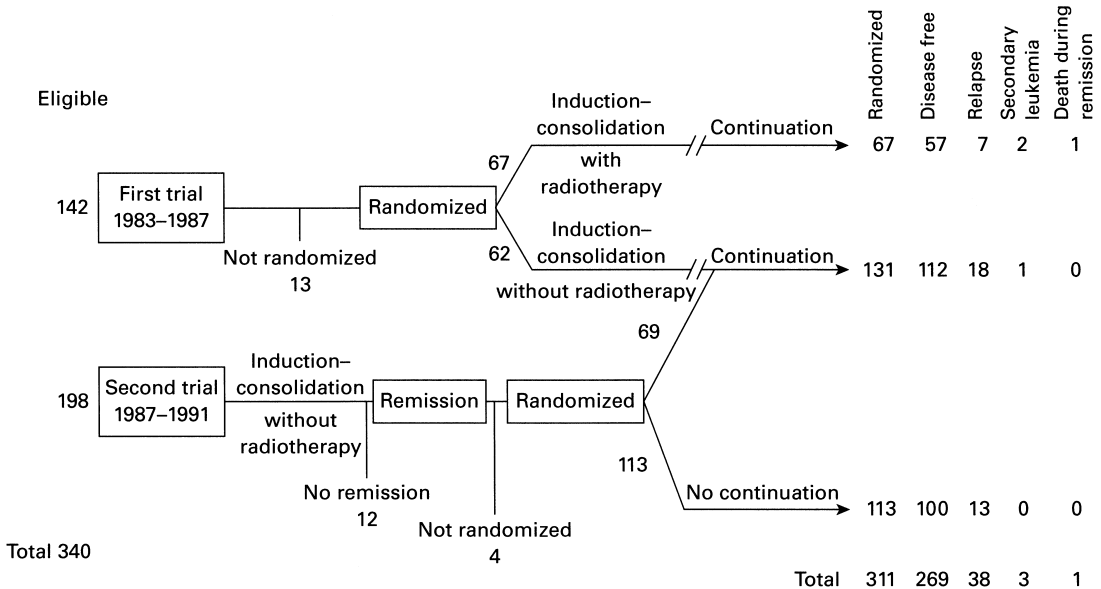
therapy was taken as evidence of the efficacy of "maintenance" therapy. For a power of 90% to detect this difference it was calculated that an additional 183 patients were required as well as the patients accrued from the first study.

The primary outcome measures were event-free survival, continuous complete remission and overall survival. Comparisons were made with the log-rank test and life tables constructed according to Kaplan–Meier.

**Outcome**

Three hundred and fifty-five patients entered the two studies. Fifteen were excluded: pathology unconfirmed in seven, non-localized disease in eight. In the first study 13/42 were not randomized, seven of whom had primary lymphoma of bone. In the second trial 16/198 were not randomized: four declined and twelve failed to achieve complete remission. One hundred and thirteen patients were randomly assigned to the 9 weeks treatment arm and 69 to receive treatment for 8 months.

Sixty-two patients from the first study who had received 8 months of treatment and no radiotherapy were analyzed with the latter group to produce a total of 131.



**Figure 9.11** Design of two consecutive trials of therapy for patients with early stage non-Hodgkin's lymphoma, with the treatment assignments and outcomes shown for all 340 eligible patients. Adapted with permission from Link *et al.* (full reference on p. 180). © 1997 Massachusetts Medical Society.

**Table 9.2** Treatment regimens for patients with early-stage non-Hodgkin's lymphoma.

Therapy	Route of administration	Schedule			
Induction and consolidation therapy (9 weeks)					
Vincristine	Intravenous	1.5 mg/m <sup>2</sup> weekly for 7 weeks			
Doxorubicin	Intravenous	40 mg/m <sup>2</sup> on days 1, 22 and 43			
Cyclophosphamide	Intravenous	750 mg/m <sup>2</sup> on days 1, 22 and 43			
Prednisone	Oral	40 mg/m <sup>2</sup> daily on days 1–28 and 43–47			
Continuation therapy (24 weeks)					
Mercaptopurine	Oral	50 mg/m <sup>2</sup> daily			
Methotrexate	Oral	25 mg/m <sup>2</sup> weekly			
Central nervous system		Age adjusted doses given on days 1, 8, 22, 43 therapy* and 64 on induction–consolidation therapy and every 6 weeks during continuation therapy			
		<b>1 year olds    2 year olds    3–8 years olds    &gt;9 years olds</b>			
Methotrexate (in mg)	Intrathecal	8	10	12	15
Cytarabine (in mg)	Intrathecal	16	20	24	30
Hydrocortisone (in mg)	Intrathecal	8	10	12	15

\* Intrathecal methotrexate alone (12mg/m2) was used in the first trial.

There were no differences in the projected 5-year rates of continuous complete remission:  $89 \pm 4\%$  for those treated with 9 weeks of chemotherapy compared to  $86 \pm 4\%$  for those treated with 8 months of chemotherapy. Details on those randomized are not given.

A total of 54 patients had adverse events: 12 did not achieve a complete remission (all from the second trial), 38 had recurrent disease, 1 died of sepsis and 3 had second malignancies.

Important differences were found when results were analyzed according to histopathological subtype. Projected complete clinical remission rates for those with lymphoblastic disease was 63% compared with 89% for those with small non-cleaved cell lymphoma. The failure

rate was higher in those with lymphoblastic disease treated for 9 weeks (8/14) compared with those treated for 8 months (7/21) ( $p = 0.24$ ). There was, however, no difference in overall survival between histological groups, suggesting that there is a high salvage rate with further therapy in relapsed lymphoblastic disease (Figures 9.12 and 9.13).

### Conclusion

It was concluded that 9 weeks treatment is sufficient for localized Murphy's stage I/II small non-cleaved cell lymphoma and large cell lymphoma.

## Study 11

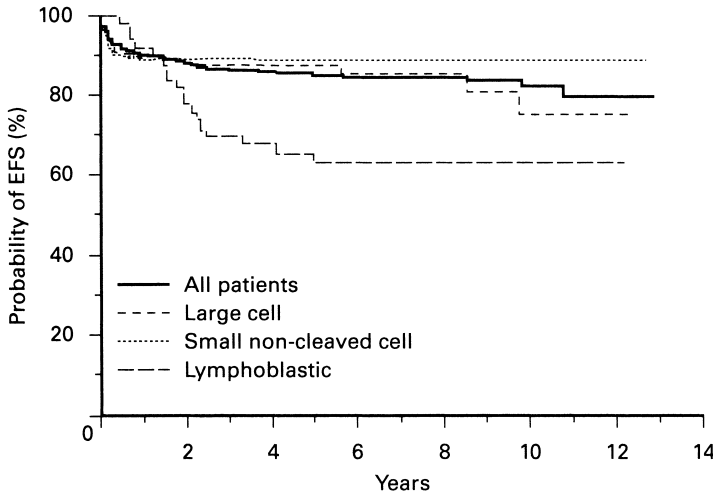
Amylon MD, Shuster J, Pullen J, Berard C, Link MP, Wharam M, Katz J, Yu A, Laver J, Ravindranath Y, Kurtzberg J, Desai S, Camitta B, Murphy SB. Intensive high-dose asparaginase consolidation improves survival for pediatric patients with T cell acute lymphoblastic leukemia and advanced stage lymphoblastic lymphoma: a Pediatric Oncology Group study. *Leukemia* 1999; **13**:335–42.

The study was carried out between 1987 and 1992 by the Pediatric Oncology Group (POG-8704).

### Objectives

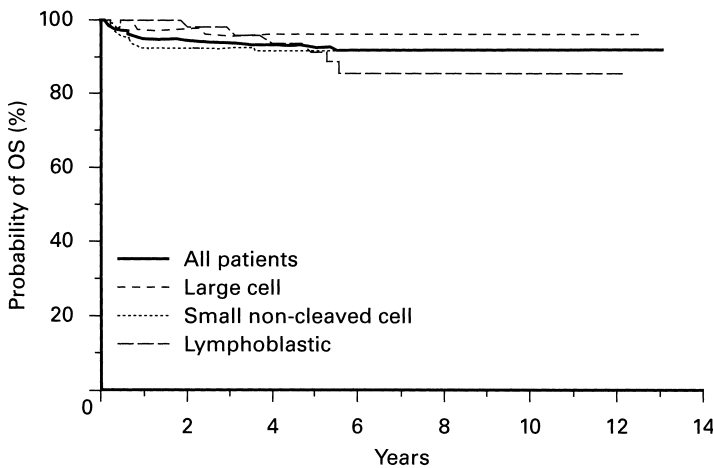
This study was designed:

- To test the hypothesis that high dose asparaginase consolidation therapy improves survival in pediatric patients with T cell acute lymphoblastic leukemia and advanced stage lymphoblastic lymphoma.



**Figure 9.12** Event-free survival (EFS) in relation to histology. Adapted with permission from Link *et al.* (full reference on p. 180). © 1986 Massachusetts Medical Society.

No. at risk											
All patients	340	305	294	282	265	211	165	127	97	77	48
Large cell	81	72	70	66	65	51	38	26	20	16	12
Small non-cleaved cell	185	164	161	159	151	121	95	73	54	42	23
Lymphoblastic	50	46	40	35	32	24	21	18	15	12	8



**Figure 9.13** Overall survival (OS) in relation to histology. Adapted with permission from Link *et al.* (full reference on p. 180). © 1986 Massachusetts Medical Society.

No. at risk											
All patients	340	324	317	308	290	231	177	135	100	80	49
Large cell	81	79	77	73	69	55	42	27	20	17	13
Small non-cleaved cell	185	171	167	164	156	125	97	74	54	42	23
Lymphoblastic	50	50	49	49	45	36	27	24	18	14	8

**Details of the study**

Eligibility included patients up to 21 years of age. Those with T cell lymphoma were allowed to have received previous mediastinal radiotherapy and up to 7 days of prednisolone as emergency therapy. Standard

immunophenotyping was not mandatory but central pathological review was done in all cases. Patients with Murphy stage III and IV disease were eligible.

In the main trial, children with leukemia and lymphoma were included. For this review, only those

with T cell non-Hodgkin's lymphomas (NHL) will be considered.

The randomization site and method are not defined but involved call back to an automated telephone registration system once the patient was in complete remission. No details of the anticipated difference between study arms or number required are given.

The study involved multiagent induction chemotherapy, which included three doses of asparaginase, followed by a consolidation and a CNS directed therapy component. During maintenance therapy, patients were randomized to receive 20 weekly doses of 25,000 units/m<sup>2</sup> of L-asparaginase intramuscularly, beginning on day 99 (Table 9.3).

Measured endpoints were duration of complete clinical remission (CCR) time from randomization to relapse, second cancers and death. One-sided analysis of CCR was performed.

## Outcome

In the overall study, including acute lymphoblastic leukaemia (ALL), 552 patients were enrolled. Twenty-seven did not meet the eligibility requirement, mainly because central pathology review failed to confirm the diagnosis, 22 did not achieve a documented complete remission, as required for post-CR randomization, and an additional 19 patients were lost due to failure

to call the automated telephone registration system to be randomized. Ultimately, 484 patients, 317 ALL and 167 T-NHL, were randomized. For the T-NHL group, 180 of 195 had achieved a complete remission (two were non-evaluable). Of the 167 randomized, 83 received standard treatment and 85 high dose asparaginase.

The 4-year CCR for the standard treatment arm was 64 ± 6%, versus 78 ± 5% for high dose asparaginase ( $p < 0.048$ ). Overall, there was no outcome difference between stage III and IV NHL.

In the standard treatment arm, 31 patients relapsed, 8 in the mediastinum alone, 4 in the CNS alone. In the asparaginase arm, 17 relapsed, 3 in the mediastinum alone and 2 with CNS disease. There was 1-second cancer in the standard arm, compared to 7 in the high dose asparaginase arm. There were two deaths, one from bronchiolitis obliterans and one accidental injury.

Details of infection are given only for the whole study group. There was no difference in myelosuppression or sepsis between groups. There were increased incidences of thrombocytopenia (6.2% versus 2.6%) liver function abnormalities (2.6% versus 0.9%) hyperbilirubinemia (1.2% versus 0.05%) and pancreatitis (0.8% versus 0.1%) in the high dose asparaginase arm. There were no grade 3 or 4 bleeding or thrombotic episodes. Allergic reactions were higher in the asparaginase arm (24% versus 10%).

**Table 9.3** Treatment regimen.

Induction	Vincristine 1.5 mg/m <sup>2</sup> IVP weekly × 5 begin day 1, prednisone 40 mg/m <sup>2</sup> /day PO ÷ tid × 28 days, cyclophosphamide 1000 mg/m <sup>2</sup> IV on day 1, doxorubicin 50 mg/m <sup>2</sup> IV on day 1, cytarabine 100 mg/m <sup>2</sup> /day IVCI for 5 days begin day 22, cyclophosphamide 600 mg/m <sup>2</sup> IV on day 22 L-asparaginase 10,000 U/m <sup>2</sup> IM on days 27, 29 and 31
Consolidation	Teniposide 300 mg/m <sup>2</sup> IV twice weekly × 4 doses begin day 43, cytarabine 150 mg/m <sup>2</sup> IVP twice weekly × 4 doses after teniposide, vincristine 1.5 mg/m <sup>2</sup> IVP twice weekly × 4 begin day 71, prednisone 40 mg/m <sup>2</sup> PO ÷ tid × 28 days begin day 71, doxorubicin 40 mg/m <sup>2</sup> IV on day 71
CNS prophylaxis	Intrathecal triple drugs twice weekly × 7 begin day 1, then q9 weeks throughout maintenance. Cranial RT 2400 cGy begin day 71 for T-ALL patients with WBC > 50K only
Maintenance	9 week cycle repeated 10 times: cytarabine 150 mg/m <sup>2</sup> /day IVCI × 3 days begin day 1, cyclophosphamide 75 mg/m <sup>2</sup> IVP q12 hours × 6 doses begin day 1, vincristine 2 mg/m <sup>2</sup> IV on day, doxorubicin 30 mg/m <sup>2</sup> IV on day 22, prednisone 120 mg/m <sup>2</sup> PO ÷ tid × 5 days begin day 22 6-MP 225 mg/m <sup>2</sup> /day PO ÷ tid × 5 days begin day 22, teniposide 300 mg/m <sup>2</sup> IV q3 days × 2 doses begin day 43, cytarabine 150 mg/m <sup>2</sup> /dose IVP × 2 doses following teniposide
Randomization	L-asparaginase 25,000 U/m <sup>2</sup> IM weekly × 20 doses begin day 99

IVP: intravenous push; IVCI: intravenous continuous infusion.

**Conclusion**

It was concluded that despite the surprisingly high level of second malignancy, there was an overall benefit to asparaginase.

**Comment**

The difference is only marginally significant for NHL. When the ALL data are added, the differences are more

marked, with 4-year CCR of  $71 \pm 3\%$ , versus  $58 \pm 3\%$ . The authors concluded that in the overall population one could be 95% confident that there was a benefit equal to or greater than 6.8% at 4 years with regard to CCR. It should be noted that the outcome in T-ALL was poor, with only 30% of patients event free at 7 years, and around 50% of those with NHL survived. Moreover, from the survival curve the differences decreased with follow up time.

**Study 12**

Murphy SB, Hustu H. A randomised trial of combined modality therapy of childhood non-Hodgkin's lymphoma. *Cancer* 1980;45:630–37.

This study was carried out between 1975 and 1978 at St. Jude Children's Research Hospital.

**Objectives**

The aims of the study were:

- To determine the contribution of involved field radiotherapy in patients with stage III–IV disease.
- To determine the efficacy of "prophylactic" treatment to the CNS using cranial irradiation and intrathecal methotrexate in stage II–IV disease.

**Details of the study**

Eligible patients were all those presenting at St. Jude during this period with previously untreated non-Hodgkin's lymphomas of any histological subtype.

The randomization method involved a card envelope technique and was carried out at St. Jude. Patients were stratified for poor risk features, such as stage IV, mediastinal mass and widespread abdominal disease. No anticipated difference in outcome or numbers required to draw conclusions are detailed.

Induction therapy for stage I–II disease was vincristine, prednisolone, cyclophosphamide and involved field radiotherapy 30–35 Gy. Stages III–IV received the same three drugs plus doxorubicin and were randomized to receive, or not receive, involved field radiotherapy. Involved field was defined as the area involved by

the bulky primary tumor. In the case of abdominal disease, the whole abdomen was treated to 20–25 Gy, with the primary site boosted to 30–35 Gy. With thoracic or mediastinal primaries, where the pleura was involved, the affected hemithorax received 12–15 Gy with a boost of 30–35 Gy to the primary area.

If a complete response to induction therapy was documented, children with stage I or completely resected stage II gastrointestinal primaries began two-drug oral maintenance chemotherapy and received no CNS prophylaxis. All other children (stage II–IV) who achieved a complete response were randomly selected to receive, or not, the standard regimen of 24 Gy cranial irradiation and five doses of intrathecal methotrexate. Maintenance therapy was then given (Table 9.4).

Primary outcome measures were disease-free survival and overall survival.

**Outcome**

Sixty-nine patients aged 2–19 years were entered, of whom 56 were male. Histological subtype comprised 24 lymphoblastic, 27 undifferentiated, 11 histiocytic and 7 other (Rappaport classification). Twenty-five had abdominal tumors, 18 mediastinal, 12 head and neck, 7 peripheral and 7 other. Twenty-one had stage I and II disease, 48 were stage III and IV.

Forty-six of forty-eight stage II–IV patients were eligible for the radiotherapy randomization. One had multifocal disease with no obvious primary and in one follow up was too short at time of publication. Twenty-one received chemotherapy alone, 25 the addition of radiotherapy.



**Table 9.4** Treatment outline.**Phase I** Induction (6–9 weeks)

For stages I–II:

Vincristine 1.5 mg/m<sup>2</sup> IV weekly × 6 doses on days 0, 7, 14, 21, 28 and 35Cyclophosphamide 1200 mg/m<sup>2</sup> IV on days 0, 21 and 42Prednisone 40 mg/m<sup>2</sup> PO × 28 days

Involved field radiotherapy (3000–3500 rad)

For stages II–IV:

Same drugs, as above, plus

Doxorubicin 45 mg/m<sup>2</sup> IV on days 0, 21 and 42

Randomization for radiotherapy, as above, versus none

**Phase II** CNS prophylaxis (2–3 weeks)

For stages I and II with completely resected gastrointestinal primary tumors:

No prophylaxis

For (other) stages II, III, IV

Randomize for cranial irradiation (2400 rad) plus intrathecal methotrexate (12 mg/m<sup>2</sup>) × 5 doses, versus no prophylaxis**Phase III** Maintenance (for a total duration of 2 years following diagnosis)

For stages I–IV:

6-Mercaptopurine 75 mg/m<sup>2</sup> PO dailyMethotrexate mg/m<sup>2</sup> PO weekly

There was no difference in the observed complete response rate, 17/21 versus 21/25, respectively. Thirty-four patients were randomized for CNS directed therapy: 18 received additional therapy, of whom 4 relapsed

(one isolated CNS); 16 received no additional therapy: 5 relapsed (4 with isolated CNS disease). Although not statistically significant, it was concluded that there were more CNS relapses in those not given additional CNS directed therapy.

Overall survival was 58% in the group receiving radiotherapy versus 51% in those without, and disease-free survival was 42% versus 33%, respectively.

**Toxicity**

The main toxicities were gastrointestinal and/or mucositis, which were observed only in the patients receiving radiotherapy. There was one death due to interstitial pneumonitis, which occurred early in the study before the routine use of septrin prophylaxis.

**Conclusion**

It was concluded that radiotherapy had no significant benefit on remission rate or overall outcome in patients with stage III and IV disease.

**Comment**

It should be noted that the study included a range of histological subtypes and the overall high CNS relapse rate could have obscured events at other sites.

**Study 13**

Millot F, Philippee N, Benoit Y, Mazingue A, Uyttebroeck P, Lutz F, Mechinaud A, Robert P, Boutard G, Marguerite A, Ferster A, Plouvier A, Rialland X, Behard C, Plantaz D, Dresse M, Philippet P, Norton L, Thyss A, Dashugue N, Waterkeyn C, Vilmer E and Otten J for the Children's Leukemia Cooperative Group of the European Organization for Research and Treatment of Cancer. Value of high dose cytarabine during interval therapy of Berlin–Frankfurt–Munster–Based protocol in increased-risk children with acute lymphoblastic and lymphoblastic lymphoma: Results of the European Organisation for Research and Treatment of

Cancer 5888 randomised phase III trial. *J Clin Oncol* 2001;19:1936–42.

Study carried out between 1990 and 1996 by the European Organization for Research and Treatment of Cancer.

**Objectives**

The aim of the study was:

- To determine the value of adding high dose cytarabine to high dose methotrexate in reducing central nervous system and systemic relapses in increased risk acute lymphoblastic leukemia and stage III and IV lymphoblastic lymphoma.

## Eligibility

Less than 18 years of age with untreated acute lymphoblastic leukaemia (ALL) or lymphoblastic lymphoma. Mature B ALL and mature B lymphoma were excluded. Increased risk group was defined as BFM risk factor greater than 0.8 (based on white cell count, liver and spleen size), all T-lineage leukemia and stage III or IV lymphoblastic lymphoma. Poor response and residual lymphoma following induction therapy reclassified the patient as very high risk and they were excluded from randomized study. Poor response was defined as more than 30% residual initial tumor diameter.

Randomization was performed centrally in the Brussels EORTC data center. Stratification by center, by risk group and by asparaginase arm. The trial included the other randomizations.

The planned patient number was 592 to demonstrate an increase in disease-free survival (DFS) at 5 years from 70% to 80%. Hazard ratio 0.67, alpha 5%, beta 20%, on an intention to treat analysis.

## Study design

The protocol was based on the BFM 86 regimen but excluded cranial irradiation. Patients were also randomized to receive either *E. coli* or *Erwinia* asparaginase during induction and intensification therapy and monthly intravenous 6 mercaptopurine in addition to oral 6 MP and methotrexate during maintenance therapy. These two questions were not the subject of this report (see Study 14). For protocol, see Table 9.5.

Four courses of cytarabine ( $1 \text{ g/m}^2 \times 2$ ) were added to high dose methotrexate ( $5 \text{ g/m}^2$ ) on days 8, 22, 36 and 50.

## Outcome

Six hundred and fifty-six patients were eligible. one failed to achieve complete remission, one relapsed early and one had inadequate details. Three hundred and twenty-three were randomized to arm A and 330 to arm B. There were 31 lymphoma in arm A and 29 in arm B, of these 42 were stage III and 18 stage IV. The regimen was well tolerated, less than 1% had documented neurotoxicity, none were in the cytarabine arm.

Overall, there was no difference in outcome for lymphoblastic lymphoma versus ALL; 6-year DFS 70% versus 76%, respectively or CNS relapse rate (10% versus 6%) or between treatment arms: group A  $70 \pm 3\%$ , group B  $71 \pm 2\%$ . The overall 6-year event-free survival was 76% for lymphoma versus 70% for ALL. No difference observed between arms in lymphoma, but numbers were too small for firm conclusion. The duration of interval therapy was longer in the intensified arm B 33% versus 17% of patient exceeded 8 weeks.

## Conclusion

High dose cytarabine was well tolerated but did not improve outcome in acute lymphoblastic leukemia and lymphoblastic lymphoma.

## Study 14

Duval M, Suci S, Ferster A, Rialand X, Nelken B, Lutz P, Benoit Y, Robert A, Manel AM, Vilmer E, Otten J, Phillippe N. Comparison of *Escherichia coli*-asparaginase with *Erwinia*-asparaginase in the treatment of childhood lymphoid malignancies: results of a randomized European Organisation for Research and Treatment of Cancer – Children's Leukemia Group phase 3 trial. *Blood* 2002;**99**:2734–39.

This study was run by the EORTC (study 58881) between 1990 and 1993.

## Objectives

The aim of the study was:

- To compare the toxicity and effectiveness of *E. coli*-asparaginase versus *Erwinia* asparaginase in children with lymphoblastic leukemia and lymphoma.

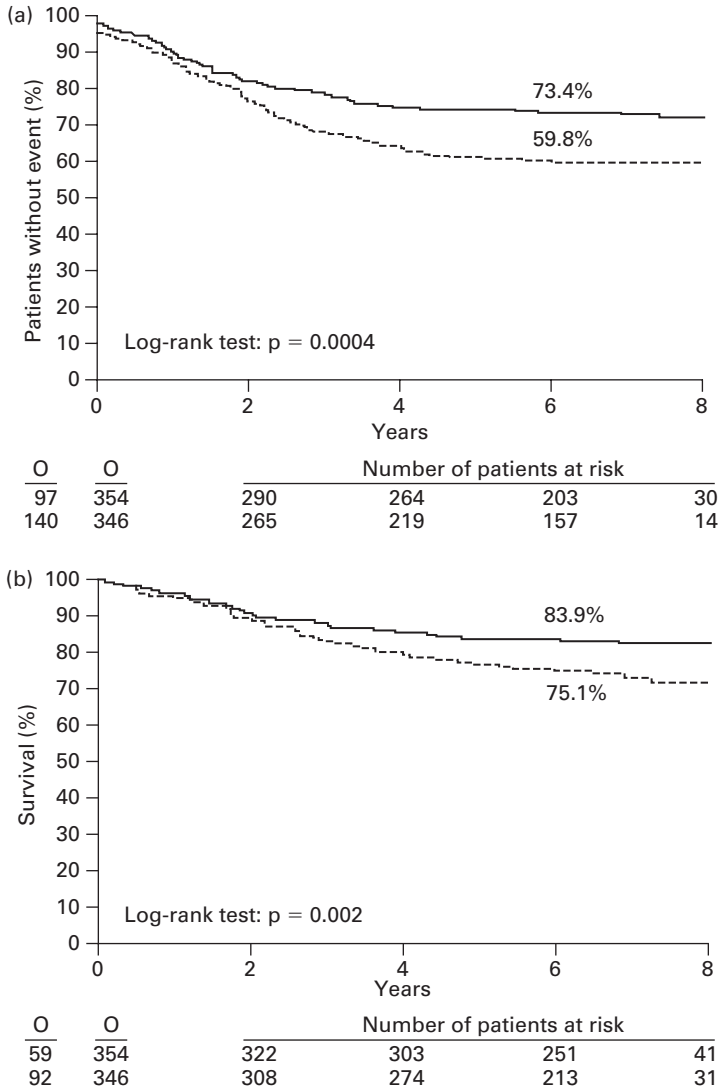
## Details of the study

Patients were enrolled in Belgium, France and Portugal. Eligibility was less than 18 years of age, with acute lymphoblastic leukemia or lymphoblastic non-Hodgkin's lymphoma.

**Table 9.5** Treatment schedule for increased risk patients according to EORTC 58881 protocol.

Drug	Dose <sup>a</sup>	Applied on days
<b>Induction</b>		
Prednisolone (orally)	60	1–7 (prophase)
Prednisolone (orally)	60	8–28, then tapered over 9 days
Vincristine (IV)	1.5 (max. 2.5 mg)	8, 15, 22, 29
Daurorubicin (IV)	30	8, 15, 22, 29
L-asparaginase (IV) ( <i>E. coli</i> or <i>Erwinia</i> according to randomization)	10,000 IU/m <sup>2</sup>	12, 15, 18, 22, 25, 29, 32,35
Methotrexate (IT)	According to age <sup>b</sup>	1, 8, 22
<b>Consolidation</b>		
Cyclophosphamide (IV)	1 g/m <sup>2</sup>	36, 63
Cytarabine (IV)	75	38–41, 45–48, 52–55, 59–62
Methotrexate (IT)	According to age <sup>b</sup>	38, 52
6-Mercaptopurine (orally)	60	36–63
<b>Interval therapy</b>		
<i>Arm A</i>		
6-Mercaptopurine (orally)	25	1–56
Methotrexate (24-hour infusion)	5 g/m <sup>2</sup>	8, 22, 36, 50
Methotrexate (IT)	According to age <sup>b</sup>	9, 23, 37, 51
<i>Arm B</i>		
6-Mercaptopurine (orally)	25	1–56
Methotrexate (24-hour infusion)	5 g/m <sup>2</sup>	8, 22, 36, 50
Methotrexate (IT)	According to age <sup>b</sup>	9, 23, 37, 51
Cytarabine (IV)	1 g/m <sup>2</sup> × 2	8, 22, 36, 50
<b>Intensification</b>		
Dexamethasone (orally)	10	1–21 then tapered over 11 days
Vincristine (IV)	1.5 (max. 2.5 mg)	8, 15, 22, 29
Doxorubicin (IV)	30	8, 15, 22, 29
L-asparaginase (IV) ( <i>E. coli</i> or <i>Erwinia</i> according to the first randomization)	10,000 IU/m <sup>2</sup>	8, 11, 15, 18
Cyclophosphamide (IV)	1 g/m <sup>2</sup>	36
6-Thioguanine (orally)	60	36–49
Cytarabine (IV)	75	38–41, 45–48
Methotrexate (IT)	According to age <sup>b</sup>	38
<b>Maintenance (up to 2 years after day 1 of induction)</b>		
<i>Arm M1</i>		
6-Mercaptopurine (orally)	50	Every day
Methotrexate	20	Once a week
<i>Arm M2–</i>		
6-Mercaptopurine	50	Every day
Methotrexate (orally)	20	Once a week
6-Mercaptopurine (IV)	1 g/m <sup>2</sup>	Every 4 weeks

<sup>a</sup>Unless otherwise indicated, doses are given in milligrams per meter squared.<sup>b</sup>Less than 1 year: 6 mg; 2 years: 10 mg; 3 years and more: 12 mg.



**Figure 9.14** Event-free survival and survival for the patient cohort. (a) Event-free survival for patients randomized to *E. coli*-asparaginase (solid line) or *Erwinia*-asparaginase (broken line). (b) Survival for patients randomized to *E. coli* asparaginase (solid line) or *Erwinia*-asparaginase (broken line). O: observed number of events (remission failure, relapse or death in CR); N: total number of patients randomized. Reprinted with permission of the American Society of Hematology (full reference on p. 187).

Patients were randomized to *Erwinia* asparaginase or *E. coli* asparaginase. Asparaginase was administered intravenously twice weekly with a total of 12 doses of 10,000 IU planned; 8 during protocol I and 4 during protocol II. For details of chemotherapy, see Table 9.5.

Physicians were to switch to alternative asparaginase in the case of allergy grade I or higher. In the case

of pancreatitis or thrombosis the asparaginase was eliminated from the treatment.

Unlike the previous protocol which applied only to high risk patients the asparaginase study involved low, high and very high risk patients. Very high risk patients received an intensified rotating chemotherapy regimen and allogeneic bone marrow transplantation for those with an HLA identical sibling.

The primary end point was event-free survival from the date of complete remission (CR) to the date of first relapse or death. Secondary end points were the rate of CR after induction and consolidation, disease-free survival and survival. A total of 750 patients were initially planned to detect a significant (alpha 5%) difference of 10% in event-free survival rate at 5 years (from 65% to 75%) with a power of 85%.

### Conclusion

*E. coli* asparaginase is associated with a higher incidence of coagulopathy and neurotoxicity but leads to a higher event-free survival. Numbers of patients with lymphoma were too small for a direct comparison but the overall outcome in this group was comparable.

### Outcome

Seven hundred and two patients were enrolled; 700 were eligible for entry into the study; 354 in the *E. coli* arm and 346 in the *Erwinia* arm; 2 patients with Burkitt lymphoma (one in each arm) were excluded; 47 patients with lymphoblastic lymphoma were

randomized, 20 to *E. coli* and 27 to *Erwinia*; 43 patients were Murphy stage III or IV and 31 documented T-lineage.

### Toxicity

During block 1A, 81% of patients on *E. coli* received all planned doses compared to 88 on *Erwinia*; 11% switched to the other asparaginase compared to 7%, respectively. After block 2A, 66% of patients on *E. coli* received all planned doses compared to 69% on *Erwinia* and 29% switched compared to 29%. There was no difference in the incidence of liver toxicity, insulin dependent diabetes or pancreatitis.

Coagulation abnormalities were higher with *E. coli*, 30%, compared to *Erwinia*, 12%. Neurotoxicity grades III and IV and convulsions were also slightly higher in the *E. coli* arm 2.5% and 1.7% versus 1.4% and 0.3%. Incidence of grade III and IV allergy was identical in both arms 2.5% and 2.6%, respectively for *E. coli* and *Erwinia*.

Event-free survival at 6 years for *E. coli* was 73.4% compared with 59.8% for *Erwinia* ( $p = 0.0004$ ). Overall survival was 84% versus 75% ( $p = 0.002$ ) (see Figure 9.14).

## Study 15

Spoto R, Meadows A, Chilcote R, Steinherz P, Kjeldsberg C, Kadin M, Krailo M, Termuhlen A, Morse M, Siegel S. Comparison of long term outcome of children and adolescents with disseminated non-lymphoblastic non-Hodgkin lymphoma treated with COMP or daunomycin-COMP: a report from the children's cancer group. *Med Pediatr Oncol* 2001; 37:432–41.

Studies carried out from 1983 and 1990 by the American Children's Cancer Group Study CCG 503.

### Objectives

The aim of the study was:

- To determine the value of adding an anthracycline to induction and continuing chemotherapy in disseminated non-lymphoblastic lymphoma.

### Details of the study

Eligibility included patients with non-lymphoblastic lymphoma, that is those with small non-cleaved cell lymphoma, Burkitt, non-Burkitt and Burkitt like large cell lymphoma T, B, histiocytic. Patients under 21 years of age, excluding disease localized to the gastrointestinal (GI) tract with or without regional lymph nodes, tumor in Waldeyer's ring with or without cervical or supraclavicular nodes, those with single extra nodal disease and one regional extension or those with single nodal site and with or without less than two adjacent nodal regions. All mediastinal tumors and bone tumor were included. All patients with bone marrow involvement greater than 5% or initial CNS involvement, that is cytology or nerve palsy, were not randomized and electively given the daunorubicin containing regimen.

There was central pathology review in over 90% of patients. Precise immunohistochemical classification was not required.

**Table 9.6** Induction and maintenance dosage.

Induction	Maintenance
CPM day 0	CPM day 0
VCR days 2, 9, 16, 23	VCR day 0, 14 × 15 cycles
Pred 2–29	Pred days 0–4
MTX day 16	MTX day 14
± DNR day 16	± DNR day 14 × 6 cycles
IT ARAC days 0, 4, 9, 16, 23 MTX	
<i>Doses</i>	
CPM 1200 mg/m <sup>2</sup>	VCR 1.5 mg/m <sup>2</sup>
MTX 300 mg/m <sup>2</sup>	CPM 1000 mg/m <sup>2</sup>
VCR 2 mg/m <sup>2</sup>	MTX 300 mg/m <sup>2</sup>
Pred 60 mg/m <sup>2</sup>	Pred 60 mg/m <sup>2</sup>
DNR 50 mg/m <sup>2</sup>	DNR 50 mg/m <sup>2</sup>

Details of randomization, method and site are not stated. Patients were stratified for large cell versus non-large cell and abdominal site versus other sites.

In the analysis an isolated CNS relapse which received subsequent therapy was not counted as an event. It was only an event if there was persistent disease or subsequent recurrence. The reason for this exclusion is unclear.

With a planned 140 patients in each arm there would be an 80% power, alpha 0.05, to detect a ±16–17% difference in relapse-free survival on two-sided tests.

### Study design

Patients received identical chemotherapy with the exception of the addition of daunorubicin at a dose of 50 mg/m<sup>2</sup> (see Table 9.6).

### Outcome

Four hundred and twenty-six children were enrolled this included 43 who had no central pathology review

but the local diagnosis accepted; 22 were ineligible due to a wrong diagnosis or other form of non-Hodgkin's lymphomas; 284 of 404 were randomized. Of these, 7 should have received D COMP due to CNS or bone marrow disease but were randomized; 120 were not randomized; 91 were electively given D COMP; 23 had equivocal bone marrow involvement, and others due to a variety of errors. Ultimately, 139 received COMP and 145 D COMP. There was a good balance between the extent of initial disease, i.e. stage III, LDH and patient age. Toxicity was worse with D COMP with regard to dermatitis, 20% versus 13%; grade III, IV thrombocytopenia, 17% versus 10%; neutropenia, 86% versus 78%; 10 patients died of toxicity in the first 10 weeks, 5 infection, 1 tumor lysis syndrome, 1 adult respiratory distress syndrome, 1 GI bleed, 1 CNS bleed and 1 other.

There were two further on treatment deaths, 11 of the 12 deaths occurred in the D COMP arm. There were 6-second malignant neoplasms. There were nine remission deaths, three were due to anthracycline-induced cardiac dysfunction.

Overall, there were 172 relapses with 10-year event-free survival (EFS) 55 ± 44% COMP and 57 ± 44% D COMP. In non-randomized patients EFS was 39 ± 5%. For histological subgroups large cell lymphoma 48 ± 5%, small non-cleaved cell lymphoma 61 ± 3%. Despite the difference in relapse-free survival the overall survival was similar at 65% versus 63% because of the high salvage rate in large cell lymphoma.

### Conclusion

The addition of daunorubicin to the COMP regimen added significantly to acute and late toxicity and was of no value with regard to disease control in this chemotherapy setting.

## Study 16

Laver J, Mahmoud H, Pick T, Hutchinson R, Weinstein H, Schwenn M, Weitzman S, Murphy S, Ochoa S, Shuster J. Results of a randomized phase III trial in children and adolescents with advanced stage

diffuse large cell non-Hodgkin's lymphoma: a Paediatric Oncology Group Study. *Leuk Lymphoma* 2002; 43:105–9.

Study carried out between 1986 and 1991 by the Paediatric Oncology Group.

## Objectives

The aim of the study was:

- To determine whether adding cyclophosphamide to doxorubicin, vincristine and prednisolone was of benefit in the treatment of diffuse large cell lymphoma..

## Eligibility

Less than 2 years of age, Murphy stage III and IV disease with no prior therapy. Central pathology review was mandatory. The following pathological categories were included:

- diffuse histiocytic or mixed lymphocytic–histiocytic (Rappaport);
- diffuse large cell (cleaved and/or non-cleaved), immunoblastic or diffuse, mixed, small and large (Working Formulation);
- diffuse large cleaved, large non-cleaved, immunoblastic-B, immunoblastic-T or true histiocytic (Lukes Collins);
- centroblastic–centrocytic, T-zone, lympho-epithelioid cell (Lennert's), immunoblastic-T or -B, anaplastic large cell, pleomorphic or centroblastic-centrocytic diffuse (updated Kiel).

The method or site of randomization was not specified.

The major study end points were event-free survival, time to relapse, progression or second malignancy or death. Log-rank test analysis was used. Assuming proportional hazards and zero hazard after 2 years the study had a 70% power to detect a 20% improvement in 2-year event-free survival from baseline of 65%.

Chemotherapy details given in Table 9.7.

The need for radiation therapy was determined the end of induction (day 42) unless used in an initial emergency situation.

The dose of cyclophosphamide was 800 mg/m<sup>2</sup> given on days 1 and 22 in the study arm. Treatment was given every 21 days for the duration of 1 year.

## Outcome

One hundred and twenty patients were randomized, 58 to ACOP and 62 to APO.

Forty-eight tumors had detailed immunohistochemistry of which 30 were B, 37 were T and 32 indeterminate lineage.

**Table 9.7** Paediatric Oncology Group Study No. 8615 treatment program paediatric diffuse large cell lymphoma.

ARM	Induction	Maintenance <sup>a</sup>
APO	Doxorubicin 75 mg/m <sup>2</sup> days 1 and 22 Vincristine 1.5 mg/m <sup>2</sup> days 1 and 22 Prednisone 40 mg/m <sup>2</sup> daily for 28 days IT-methotrexate days 1, 8, 22	Doxorubicin 30 mg/m <sup>2</sup> day 1 <sup>b</sup> Methotrexate 60 mg/m <sup>2</sup> day 1 Vincristine 1.5 mg/m <sup>2</sup> day 1 Prednisone 120 mg/m <sup>2</sup> days 1–5 vIT methotrexate day 1 (cycles 1–3)
ACOP+	Cyclophosphamide 800 mg/m <sup>2</sup> days 1 and 22 Doxorubicin 75 mg/m <sup>2</sup> days 1 and 22 Vincristine 1.5 mg/m <sup>2</sup> days 1 and 22 Prednisone 40 mg/m <sup>2</sup> daily for 28 days IT methotrexate days 1, 8, 22	Cyclophosphamide 800 mg/m <sup>2</sup> day 1 Doxorubicin 30 mg/m <sup>2</sup> day 1 <sup>b</sup> Methotrexate 60 mg/m <sup>2</sup> days 1 and 22. Vincristine 1.5 mg/m <sup>2</sup> days 1 and 22 Prednisone 120 mg/m <sup>2</sup> days 1–5 6-Mercaptopurine 225 mg/m <sup>2</sup> days 1–5 IT methotrexate day 1 (cycles 1–3)

<sup>a</sup>Maintenance cycles were given q21 days for APO and Q35 days for ACOP+ total length of therapy was 1 year on both arms.

<sup>b</sup>Methotrexate substituted for doxorubicin when total dose of doxorubicin reached 450 mg/m<sup>2</sup>.

Seven patients failed induction; three on ACOP and four on APO. There were three induction deaths.

Radiation therapy was given in 10 patients, 2 was an emergency and 8 given electively for residual or initial bulky disease.

Five-year event-free survival for ACOP was 62 ± 7% and APO 72 ± 6% (p = 0.03). However, it was pointed out that due to the small numbers recruited the possible range was from 28% inferior with APO to 8% superior for ACOP (95% confidence interval). The overall survival was 76% and 82%, respectively, for ACOP and APO.

Relapse sites were lymph nodes in 13, mediastinum in 6, bone in 3, skin in 2, central nervous system in 1 and bone marrow in 1.

There were four secondary tumors: one AML, one Hodgkin's disease, one teratoma and one rhabdomyosarcoma.

## Conclusion

No significant advantage was demonstrated for cyclophosphamide but the numbers recruited were too few to draw firm conclusions.

## Study 17

Laver JH, Kravaka JM, Hutchison RE, Change M, Kepner J, Schwenn M, Tarbell N, Desai S, Weitzman S, Weinstein HJ, Murphy SB. Advanced stage large cell lymphoma in children and adolescents: results of a randomised trial incorporating intermediate-dose methotrexate and high dose cytarabine in the maintenance phase of the APO regimen: a Paediatric Oncology Group Phase III trial. *J Clin Oncol* 2005;23:541-7.

The study was carried out by the Paediatric Oncology Group in the USA, between 1994 and 2000.

### Objectives

The aim of the study was:

- To determine whether the addition of high dose cytarabine and intermediate dose methotrexate to maintenance chemotherapy improves outcome in advanced large cell lymphoma.

### Details of the study

Eligibility included patients less than 22 years of age with stage III and IV diffuse large cell lymphoma. All pathology was centrally reviewed but because multiple terminologies were being used by centers, patients were accepted on study with any of the following pathological categories of lymphoma:

- 1 diffuse histiocytic or mixed lymphocytic histiocytic;
- 2 diffuse large cell, immunoblastic or diffuse mixed small and large cell;
- 3 diffuse large cleaved large non-cleaved immunoblastic-B, immunoblastic-T or true histiocytic;
- 4 centroblastic, centroblastic-centrocytic T-zone, lympho-epithelioid cell, immunoblastic-T, immunoblastic-B, anaplastic large cell lymphoma, pleomorphic centroblastic-centrocytic diffuse.

Following central review patients were reclassified according to the WHO nomenclature. Eighty-six were defined as ALCL of which 58 were T cell, 28 were null cell, 10 were peripheral T cell lymphoma, 75 were B cell large cell lymphoma of which 73 were defined as diffuse large B cell. There was 1 follicular lymphoma, 1 MALT and 9 unclassified large cell lymphoma.

Randomization method and site were not stated.

It was planned to recruit 237 patients which would provide an 80% power of demonstrating a difference in event-free survival (EFS) at 2 years of 87% versus 75%  $p < 0.05$ .

### Study design

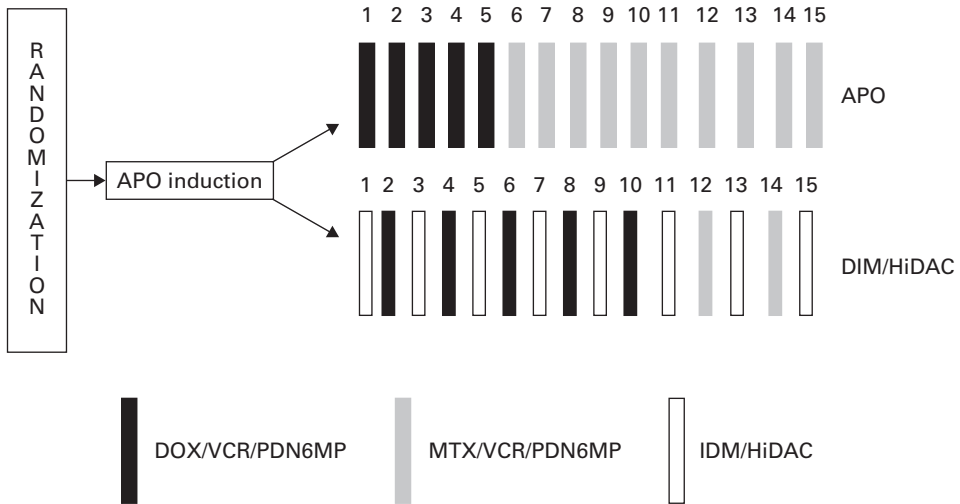
The protocol was based on the standard APO regimen as shown in Figure 9.15.

All patients received induction chemotherapy with doxorubicin, vincristine, prednisolone and intrathecal therapy and the standard arm received conventional maintenance therapy. The study arm received additional cytarabine and methotrexate. Eleven patients were given radiation therapy after induction including patients with CNS disease who were assigned to the APO arm with radiation, four without CNS disease had biopsy proven viable disease and the rest on the basis of imaging results.

Ninety patients were randomized to standard APO and 90 to the intensified arm. There were two induction failures and two early deaths. The 4-year EFS for all patients as 67% (standard error 4%) and overall survival (OS) 80% (standard error 3.6%). EFS for both arms was identical.

There were no significant differences in EFS between the different histological subgroups for diffuse large B cell lymphoma (37 and 34 patients on investigation and standard arm, respectively) the EFS were 64% and 70%. For all 86 ALCL patients, EFS and OS were 72% and 88%, respectively and no difference for randomly assigned ALCL patients.





Arm	Induction	Maintenance (every 21 days)
APO	Doxorubicin 75 mg/m <sup>2</sup> days 1 and 22 Vincristine 1.5 mg/m <sup>2</sup> days 1 and 22 Prednisolone 40 mg/m <sup>2</sup> daily for 28 days IT methotrexate days 1, 8 and 22 (IT methotrexate days 15, 29 and 36 for CNS + pts) IT methotrexate day 1 cycles 1, 3 and 5	Doxorubicin 30 mg/m <sup>2</sup> day 1 (300 mg/m <sup>2</sup> ) <sup>a</sup> Methotrexate 60 mg/m <sup>2</sup> day 1 <sup>b</sup> Vincristine 1.5 mg/m <sup>2</sup> day 1 Prednisolone 120 mg/m <sup>2</sup> days 1–5 6-Mercaptopurine 225 mg/m <sup>2</sup> days 1–5  (IT methotrexate day 1 (cycles 2 and 4) for CNS + pts)
IDM/HiDAC	Doxorubicin 75 mg/m <sup>2</sup> days 1 and 22 Vincristine 1.5 mg/m <sup>2</sup> days 1 and 22  Prednisolone 40 mg/m <sup>2</sup> daily for 28 days IT Methotrexate days 1, 8 and 22  (IT methotrexate days 15, 29 and 35 for CNS + pts)	As above alternating every 21 days with 8 cycles of Methotrexate 1 g/m <sup>2</sup> over 24 hours, followed by HiDAC 500 mg/m <sup>2</sup> bolus and continuous infusion of 60 mg/m <sup>2</sup> /h for 48 hours. IT Methotrexate day 1 cycles 1, 3 and 5  (IT Methotrexate day 1 (cycles 2 and 4) for CNS + pts)

<sup>a</sup> Doxorubicin substituted with methotrexate at a cumulative dose of 300 mg/m<sup>2</sup>.

<sup>b</sup> For patients with CNS disease who received cranial irradiation, the methotrexate dose was reduced to 40 mg/m<sup>2</sup>.

**Figure 9.15** Paediatric Oncology Group Study 9315 Treatment Program, APO, protocol with doxorubicin (DOX), vincristine (VCR), prednisolone (PDN), 6-mercaptopurine (6MP) and methotrexate (MTX); IT, intrathecal; IDM/HiDAC, intermediate dose methotrexate/high dose cytarabine. © American Society of Clinical Oncology (full reference on p. 193).

There was no significant difference between the regimens after 180 patients had been entered with 18 and 19 failures on the respective arms. A futility analysis was performed which suggested that all 15 additional failures would all need to be on the APO arm to show a significant difference and the likelihood of this was less than 0.006 the study was, therefore, closed.

### Conclusion

- Intensification of treatment did not significantly improve outcome in this heterogeneous group of lymphomas.

## Study 18

Wossmann W, Seidemann K, Mann G, Zimmerman M, Burkhardt B, Oschlies I, Ludwig W, Klingebiel T, Graf N, Gruhn B, Juergens H, Niggli F, Parwaresch R, Gadner H, Riehm H, Schrappe M, Reiter A, for the BFM Group. Impact of methotrexate administration schedule and dose in the treatment of children and adolescents with B-cell neoplasms: a report of the BFM group study NHL-BFM95. *Blood* 2005;105:948–53.

The study was carried out between 1996 and 2001 by the BFM group in Germany, Austria and Switzerland.

### Objectives

The aims of the study were:

- To determine whether, in mature B cell lymphoma or leukemia, high dose methotrexate given over 4 hours is comparable to, but less toxic than, a 24-hour infusion.
- To incorporate a non-randomized comparison of 1 g/m<sup>2</sup> versus 5 g/m<sup>2</sup> of methotrexate in good risk patients comparing with historical series.

### Eligibility

Up to 18 years of age with mature B cell lymphoma or B cell leukemia. The St. Jude staging system was used. The definition of CNS disease was cells in CSF, infiltration on CT or MRI or cranial nerve palsy not due to extra-dural mass. LDH level was documented in each case. There was central pathology review.

The site and method of randomization was not described. The study was planned to be a per-protocol analysis that is on the basis of actual treatment received. It was intended to demonstrate non-inferiority on the basis that the lower limit of the 95% confidence interval for events did not exceed –11% in group II patients or –17% in group III and IV patients. The study power was 80% if progression-free survival (PFS) was 95% for the 24-hour infusion. Type I error 5%.

It was expected to recruit 405 patients with a stage distribution in risk groups 1–4 of 17, 43, 13 and 27, respectively. For groups 3 and 4, 80% power if PFS was 80%. Type I error 5%.

**Table 9.8** Treatment strategy. Patients were stratified into four risk groups: R1, R2, R3 and R4. The composition of therapy courses is given in Table 9.9.

Risk groups	Definition	Therapy courses
R1	Stage I + II, completely resected	A B
R2	Stage I + II, not resected Stage III and LDH < 500 U/L	VA B A B
R3	Stage III and LDH ≥ 500 to < 1000 U/L Stage IV + B + AL and LDH < 1000 U/L And CNS – negative	V AA BB CC AA BB
R4	Stage III + IV + B – AL and LDH ≥ 1000 U/L or/and CNS – positive	V AA BB CC AA BB CC

V: cyto-reductive pre-phase.

### Study design

Patients were stratified into four risk groups R 1–4 (see Table 9.8).

The treatment regimen is shown in Table 9.9.

GCSF was recommended for groups R3 and R4. An intraventricular reservoir was inserted for those with CNS disease at presentation. Following course 5 secondary surgery was recommended for any imageable disease and if active tumor was found treatment was intensified.

Randomization was between two methotrexate schedules (at doses of 1 g or 5 g/m<sup>2</sup> depending on group) infused either over 4 or 24 hours. Intrathecal therapy was given at 24 hours after the beginning of the infusion in both arms. Leukovorin rescue (15 mg/m<sup>2</sup>) was given intravenously at hours 42, 48 and 54 after the beginning of methotrexate. The dose of methotrexate in groups 1 and 2 was 1 g/m<sup>2</sup> in groups 3 and 4, 5 g/m<sup>2</sup>.

### Outcome

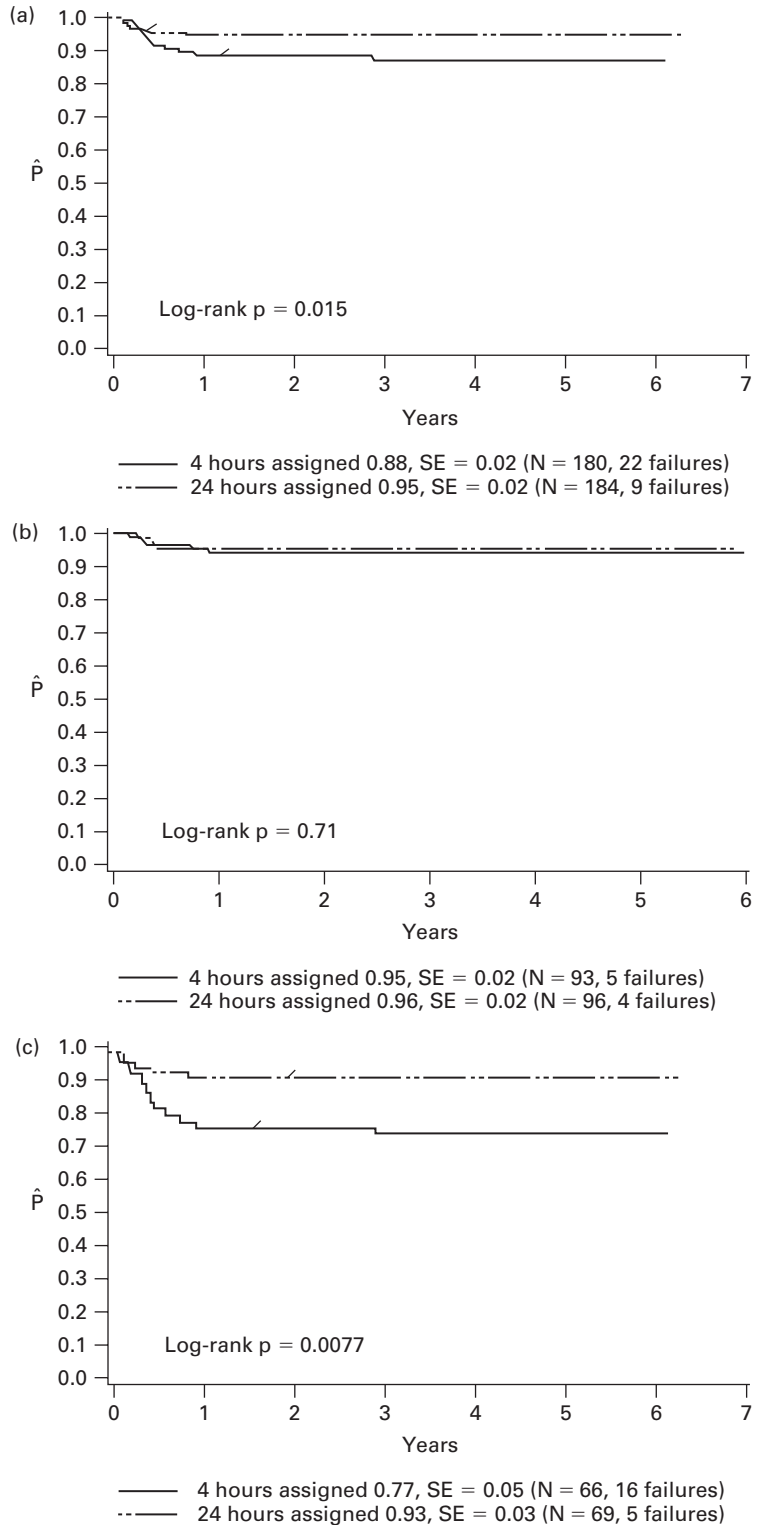
Five hundred and sixty-six patients were registered; 61 were excluded for a variety of reasons including prior

**Table 9.9** Therapy courses.

Drug	Dose	Day				
		1	2	3	4	5
<i>Pre phase V</i>						
Dexamethasone orally I/V	10 mg/m <sup>2</sup>	5	5	10	10	10
Cyclophosphamide IV 1 hour	200 mg/m <sup>2</sup>	X	X			
Methotrexate <sup>a</sup> IT	12 mg	X				
Cytarabine <sup>a</sup> IT	30 mg	X				
Prednisolone <sup>a</sup> IT	10 mg	X				
<i>Course A</i>						
Dexamethasone orally I/V	10 mg/m <sup>2</sup>	X	X	X	X	X
Vincristine IV	1.5 mg/m <sup>2</sup>	X				
Ifosfamide IV 1 hour	800 mg/m <sup>2</sup>	X	X	X	X	X
Cytarabine IV 1 hour	150 mg/m <sup>2</sup>				X-X	X-X
Etoposide IV 1 hour	100 mg/m <sup>2</sup>				X	X
Methotrexate IV <sup>b</sup>	1 g/m <sup>2</sup>	X				
Methotrexate <sup>a</sup> IT	12 mg	X				
Cytarabine <sup>a</sup> IT	30 mg	X				
Prednisolone <sup>a</sup> IT	10 mg	X				
<i>Course B</i>						
Dexamethasone orally I/V	10 mg/m <sup>2</sup>	X	X	X	X	X
Vincristine IV	1.5 mg/m <sup>2</sup>	X				
Cyclophosphamide IV 1 hour	200 mg/m <sup>2</sup>	X	X	X	X	X
Doxorubicin IV 1 hour	25 mg/m <sup>2</sup>				X	X
Methotrexate IV <sup>b</sup>	1 g/m <sup>2</sup>	X				
Methotrexate <sup>a</sup> IT	12 mg	X				
Cytarabine <sup>a</sup> IT	30 mg	X				
Prednisolone <sup>a</sup> IT	10 mg	X				
<i>Courses AA ‡§ and BB ‡§</i>						
Methotrexate IV <sup>b</sup>	5 g/m <sup>2</sup>	X				
Methotrexate <sup>a</sup> IT	6 mg	X				X
Cytarabine <sup>a</sup> IT	15 mg	X				X
Prednisolone <sup>a</sup> IT	5 mg	X				X
<i>Course CC ‡</i>						
Dexamethasone orally I/V	20 mg/m <sup>2</sup>	X	X	X	X	X
Vindesine IV	3 mg/m <sup>2</sup>	X				
Cytarabine IV 3 hours	3 g/m <sup>2</sup>	X-X	X-X			
Etoposide IV 2 hours	100 mg/m <sup>2</sup>			X-X	X-X	X
Methotrexate <sup>a</sup> IT	12 mg					X
Cytarabine <sup>a</sup> IT	30 mg					X
Prednisolone <sup>a</sup> IT	10 mg					X

<sup>a</sup>Doses were adjusted for children younger than 3 years. In courses A, B, AA and BB, intrathecal therapy was administered 24 hours after beginning of MTX intravenous infusion.

<sup>b</sup>With folinic acid rescue.



**Figure 9.16** Kaplan–Meier estimate ( $\hat{P}$ ) of a 1 year failure-free survival of patients randomized to receive methotrexate as intravenous infusion either over 4 hours or 24 hours. Intent-to-treat analysis. (a) For the whole group; (b) for patients in risk group R2 and (c) for patients in combined risk groups R3 + R4. SE: standard error. Reproduced with permission of the American Society of Hematology (full reference on p. 195).

therapy, second malignancy and immunodeficiency related tumor; 505 patients were eligible for trial. Risk group distribution was R1;48, R2; 233, R3; 382 and R4; 142.

364/505 were randomized. Non-randomization was due to parental decision in 63, due to suspension of randomization following interim analysis in 20; 57 were in risk groups 3 and 4 after randomization was permanently terminated. Others were due to physician decision.

One hundred and eighty were randomized to 4-hour infusion, 10 of whom chose to receive a 24-hour infusion; 184 were randomized to 24 hours; one chose 4 hours.

There were 11 treatment related deaths, 1 due to tumor lysis syndrome and 10 due to neutropenic sepsis.

At second interim analysis the failure risk was five times higher in those receiving 4-hour infusion. The study was, therefore, suspended and subsequently changed, to test if there was a significant difference in the two arms rather than lack of inferiority. This was done on the basis on intention to treat analysis. PFS at 1 year was found to be 91% versus 75% ( $p = 0.03$ ) and the study was closed.

Final analysis of the randomized patient group showed overall 1 year PFS  $88 \pm 2\%$  for 4 hours versus  $95 \pm 2\%$  for 24 hours ( $p = 0.015$ ). For R1; 95% versus 100%, R2; 95% versus 96%, R3 and 4; 77% versus 93% ( $p = 0.008$ ) (see Figure 9.16).

Sites of failure were local 22, bone marrow 15, CNS 10, testes 2, other 13. Seven out of a hundred and fifteen patients with mediastinal large cell lymphoma failed locally.

When analyzed on the basis of received protocol there was no difference for group 2 but groups 3 and 4 had PFS well outside the planned lower limit of confluence interval, i.e.  $-25\%$ .

Analysis of serum methotrexate levels showed them to be higher with the 24-hour infusion, particularly at the earlier time points (see Table 9.10).

**Table 9.10** MTX levels with different schedules and doses (micro-moles).

Time (h)	1 g/m <sup>2</sup>		5 g/m <sup>2</sup>	
	4 hours	24 hours	4 hours	24 hours
24	0.32	8.2	0.88	46.4
42	0.06	0.18	0.18	0.43
48	0.06	0.1	0.13	0.24

The incidence of grade III and IV mucositis was higher in 24-hour versus 4-hour infusion, occurring in 44% versus 25%, respectively of courses for risk group R3 and 4.

Forty-eight patients had second look surgery. This included 15 in R3 and 16 in R4. Of these only one had viable tumor. Of 17 patients in R2 surgery revealed two with viable tumor. All three with residual disease received high dose therapy with hematopoietic stem cell rescue of whom two remained progression free.

Three-second malignancies were reported. One melanoma and two Burkitt lymphoma with a different malignant clone. Eleven relapses occurred on treatment and 28 off treatment. All but two relapses occurred within 1 year of diagnosis.

In the non-randomized component, which compared outcome with that in the BFM 95 study, there was no difference for group R2 who received 1 g/m<sup>2</sup>. PFS was 95% versus 97% in BFM 95 where 5 g/m<sup>2</sup> was used.

### Conclusion

Reducing the infusion time of methotrexate from 24 to 48 hours reduced the toxicity and appears to be equally effective in risk groups 1 and 2. However, for risk groups 3 and 4 there was a significantly higher failure rate.

## CHAPTER 10

# Hodgkin's disease

*Commentary by Tim Eden and Ross Pinkerton*

In a malignancy like Hodgkin's disease, which has carried with it such a high overall survival rate since the introduction of aggressive systemic as well as localized disease control, the onus has been on physicians to cure patients with least long-term toxicity. This is especially so for children where increasing reports of infertility, especially in boys, cardiorespiratory dysfunction and therapeutically induced second malignancies have marred the successful control of the primary disease. The big questions for childhood Hodgkin's disease in the modern era have been:

- 1 Can cure be obtained without resort to mixed modality therapy, especially in low stage disease?
- 2 Can a successful chemotherapy regimen be developed which minimizes long-term toxicity?
- 3 How much therapy is really needed for advanced disease?

Although the questions to be addressed have been recognized worldwide, what is really surprising is that for such a relatively rare disease comprising only 5–6% of all childhood tumors (corresponding to perhaps 65–75 new cases of all stages per annum in the United Kingdom for those in the childhood age range) there has been little attempt to establish international consensus let alone run randomized controlled trials. There has in addition been little adult and pediatric collaboration. As a consequence, the number of well organized, properly constituted randomized controlled trials for childhood Hodgkin's disease carried out in the past two to three decades has been very small and furthermore the number of patients recruited into each trial is frequently too few to achieve meaningful results. Such recruitment is especially important in a disease with such a long time course where the real benefit of any individual therapy may not emerge for 10–15 years or even longer.

Those trials that have been conducted have also frequently included stratification of patients and assumptions made about long-term prognosis on the basis of anecdotal rather than strong evidence, for example the absence of a mediastinal mass or limited extent of disease in the abdomen, focusing on the number of nodules in the spleen, may constitute more favorable prognostic groups. Once you start to sub-classify, the numbers entered into any particular randomization dwindle dramatically. Finding the actual evidence historically to support such stratification is often extremely difficult.

Studies 1 and 2 exemplify some of these problems. Hutchinson *et al.* (Study 1) report the Children's Cancer Group (CCG)-521 study where they compared 12 cycles of alternating mustine, vincristine, procarbazine and prednisolone (MOPP) (the original successful protocol) and doxorubicin, bleomycin, vinblastine and dacarbazine (ABVD) (introduced to reduce the long-term toxicity of MOPP) versus six courses of ABVD followed by regional irradiation (20 Gy). It is very difficult to find any evidence equating numbers of cycles of therapy required to achieve a favorable outcome and also what dose of irradiation is equivalent to, for example, six cycles of chemotherapy. In essence, when choosing particular chemotherapy regimens you are selecting between different constellations of long-term toxicity, for example, with the alkylator-based therapy, long-term infertility especially in boys and second tumors, whilst with ABVD, potential cardiorespiratory sequelae and some degree of risk of secondary leukemia. This study, despite a planned recruitment of 50 patients per year for 4 years, ended up with only 125 patients entered. Clearly recruitment to protocols with such different therapeutic approaches is often difficult. Numbers are further reduced by exclusions.

They failed to demonstrate any significant difference in terms of event-free or overall survival although there was a trend to benefit from combined modality therapy, but what the authors do not report, indeed may not be in a position to assess, are the long-term sequelae. What is also not clear from their publication is whether patients can be salvaged if they relapse, having not previously received radiotherapy. It should be mandatory in all future publications of randomized controlled trials in Hodgkin's disease to report explicitly on late sequelae and also for collaborative groups to re-report longer-term follow-up of studies. Hodgkin's disease is a truly "long" disease!

Study 2 attempts, also in advanced Hodgkin's disease, to compare the addition of low dose total-nodal irradiation to therapy containing alternating MOPP and ABVD cycles. Weiner *et al.* included a rather broader group of patients in their definition of advanced stage, including patients with stage IIB, and they also did not make the distinction made by the CCG with regard to abdominal stage IIIA disease. They used just eight cycles of chemotherapy and similar overall radiation dosages. However, their fraction dosage was lower. Their recruitment was higher, but again they really did not find a significant difference in outcome in terms of event-free survival although there was a trend for better survival for those not irradiated. For both these studies one could conclude that irradiation was not required and it may just increase toxicity long term, but the numbers are really too small to draw absolute conclusions. Given the somewhat different selection of patients it is difficult to be sure whether you could put these two trials into a systematic review and come up with any firm conclusions.

Cramer and Andrieu (Study 3) reported on a study conducted between 1972 and 1980 in two categories. They looked at low stage disease treated with three courses of MOPP chemotherapy and then randomized between mantle radiotherapy or involved field radiotherapy. There were only 5 and 10 patients, respectively, in the randomization. Again because of some stratification problems, the results are uninterpretable. In the second half of their report they looked at patients with stage II, IIIA and IIB. They compared three courses of MOPP with three courses of CVPP (CCNU, vincristine, procarbazine and prednisone) followed by laparotomy and supradiaphragmatic radiotherapy. In this study only 16 patients were randomized. There was a favorable

response to chemotherapy but with the small numbers no conclusions could be drawn. This further confirms the need for proper large and if necessary multicenter international trials to answer important questions.

The fourth study, also from France, reported by Oberlin *et al.*, compared ABVD to MOPP plus ABVD both with reduced dose radiotherapy. They limited the number of cycles of therapy and dose of radiation to 20 Gy for good responders and 40 Gy for poor responders. They showed comparability of MOPP plus ABVD to ABVD alone and also demonstrated that there appeared to be no advantage of higher dose irradiation.

Study 5 reported by Sackmann-Muriel *et al.* came from a joint adult and pediatric trial but only the pediatric patients were included in the report. They were looking only at favorable patients in their randomized study and included stage IA and B, IIA and B and stage IIIA. They used a fairly complex prognostic index, including age, symptoms, stage and number of involved regions, to classify their patients into favorable, intermediate or unfavorable groupings. The evidence on which they based such stratification is not reported. Their favorable group was randomized between three and six courses of CVVP, their intermediate group between three courses prior to involved field radiation or to AOPE (doxorubicin, vincristine, etoposide and prednisolone) with three courses prior and three courses after involved field radiotherapy. They did make a useful contribution in that they showed that three courses of CVPP chemotherapy were adequate for patients defined as having favorable features. Those were essentially patients who were under the age of 15 years with no B symptoms, and stage I disease with less than three nodal regions involved. No patient with bulky mediastinal involvement could be included in that category and slightly older patients could only be if they were symptom free, of either stage I or II, again with limited nodal involvement. Once you start to sub-categorize patients in this way you need a lot of patients to prove for sure what you are delivering is safe efficacious therapy.

Study 6, reported by Sullivan *et al.*, was a worthwhile study in that it particularly reported on a longer follow-up, but it was limited to stage III patients and unfortunately involved poor recruitment. They attempted to compare MOPP plus bleomycin versus an alkylating regimen that contained doxorubicin (Adriamycin) (A-COPP, A-combined cyclophosphamide, vincristine,

procarbazine and prednisone). Poor recruitment and a very high number of exclusions detracted from their power to answer the questions that they had raised. The study did report comparison of toxicity, demonstrating excess cardiac complications in the A-COPP arm compared with one malignancy with MOPP and one secondary osteosarcoma with A-COPP. Although the regimens were comparable in terms of 10-year event-free and overall survival, no firm conclusions about benefit could be reached.

Finally, Gehan *et al.* (Study 7) reported in 1990 on the question of benefit or not of adjuvant MOPP to involved field or extended field radiotherapy in stage I or II disease. They clearly had a problem with randomization and a high exclusion rate. Five out of six second tumors were in the involved field plus MOPP arm. Their conclusion was that involved field irradiation plus combination chemotherapy gave superior disease control but did not influence overall survival and, of course, was associated with the predictable increase in second malignancy.

Policy regarding the use of radiation therapy has differed between collaborative groups for many years. This is generally based on prejudices regarding the severity of late effects or the likelihood of salvage after local relapse rather than on any firm evidence for either of these key considerations.

The important CCG trial (Study 9) compared outcome with and without low dose involved field radiation therapy (21 Gy) in those who achieved radiological complete remission (CR) and gallium negativity following COPP/ABV (in which ABV means doxorubicin, bleomycin and vinblastine) chemotherapy. This trial recruited over 800 patients and should have provided unequivocal evidence. Unfortunately 23/251 who were randomized to receive radiation therapy refused this treatment after randomization. There was also a large percentage that declined to be randomized (333 out of 834 eligible) Most of these patients or families did not wish to receive local radiation therapy. Although on intention-to-treat analysis no difference was found between the two randomized arms, if analyzed in relation to treatment received there was significant advantage to radiotherapy. Consequently, in a rather unsatisfactory manner a conclusion was reached that combination treatment should remain the standard approach. This emphasizes the need for clarity and understanding of the implications of consent to study

participation, problems with which lead to invalidation of results from this large collaborative trial.

The conclusion that radiotherapy is required is supported by an Indian single center trial (Study 10) in which radiotherapy was either omitted after a CR was achieved with ABVD chemotherapy or administered as involved field radiation to a recommended dose of 30 Gy. Some variability in practice is reported but dose was always at least 20 Gy. Half the patients were children. The event-free survival was 88% with radiation compared to 70% with chemotherapy alone. Marked differences were observed for those under 15 years of age, with bulky and advanced disease.

The current COGAHODOO31 trial is a further attempt to address the need for radiation therapy. In this study those with advanced disease are divided on the basis of initial response to combination chemotherapy with doxorubicin, bleomycin, vincristine, etoposide, prednisolone and cyclophosphamide (ABVEPC). Patients with greater than 60% disease reduction after two cycles are randomized to receive or not receive low dose involved field radiation. The slow initial responders are randomized to receive two further courses of ABVEPC with or without a combination of dexamethasone, etoposide, cytarabine and cisplatin. All receive subsequent radiation therapy. Provided the problems reported on the previous trial with regard to protocol violations are not seen, in this trial a firm conclusion may be drawn regarding the role of radiation therapy in early responding of advanced disease.

The increased availability of PET scanning has resulted in this modality now being incorporated in a number of single arm studies. The current German and UK studies are examples where treatment is stratified on the basis of PET response. Such trials will provide information regarding the confidence with which a PET negative result indicates true CR.

It is always easy to be retrospectively clever, but if some of the collaborative groups throughout the world had worked earlier together to address the questions they were trying to answer they might have recruited adequate numbers of patients to have answered all of these questions clearly. We are still left not knowing whether favorable localized disease is best treated with limited chemotherapy or low dose involved field irradiation. Only the truly long-term reports of the relative toxicities of the two modalities will help us to answer that question. Whereas for more advanced or



unfavorable disease, we again do not know the optimal chemotherapy with least toxicity and how much therapy is really required. Even with more sophisticated statistical analysis and systematic reviews applied to this

paucity of randomized trials, non-comparable stratification of patients and poor randomization rates may prevent us from concluding what is the optimal therapy for Hodgkin's disease in childhood.

# Studies

## Study 1

Hutchinson RJ, Fryer CJH, Davis PC, Nachman J, Krailo MD, O'Brien RT, Collins RD, Whalen T, Reardon D, Trigg ME, Gilchrist GS. MOPP or radiation in addition to ABVD in the treatment of pathologically staged advanced Hodgkin's disease in children: results of the Children's Cancer Group phase III trial. *J Clin Oncol* 1998;16:897-906.

The study was carried out between 1986 and 1990 by the Children's Cancer Group (CCG-521).

### Objectives

This trial was designed:

- To compare MOPP and ABVD versus ABVD combined with extended field radiotherapy in children and adolescents with stage III and IV Hodgkin's disease.

### Details of the study

Patients were less than 21 years of age with stage III and IV disease that was untreated and pathologically staged. Stage IIIA patients with no mediastinal mass and disease limited to splenic, celiac or portal nodes were excluded, as were those with less than five splenic nodules. These patients were regarded as having a favorable outcome.

Randomization site and method are not stated. Patients were balanced for sex, B symptoms, favorable histology and mediastinal involvement. The study was designed to detect a 20% difference in 5-year event-free survival, from 60% to 80%. It was planned to recruit 50 patients per year for a 4-year period.

Patients were randomized at presentation to receive either twelve 28-day cycles of chemotherapy, alternating between a cycle of MOPP and one of ABVD (regimen A), or six 28-day cycles of ABVD followed by radiation therapy to regions of initial involvement (regimen B). The radiation therapy dose was 21 Gy given in 175 cGy fractions for a total of 12 fractions to one or more of three general regions, based on extent of the disease at time of diagnosis. Regions comprised bilateral neck,

bilateral axillae and mediastinum. The pulmonary hila were irradiated in the presence of mediastinal or hilar involvement. Patients with lung involvement were irradiated to 10.5 Gy. Region 2 was the liver, spleen and upper abdominal nodes (above L2). Region 3 was the lower abdominal nodes, which included pelvic nodes. When more than one region required radiotherapy a 2-week interval between treatments was recommended, although it was permitted to treat two adjacent regions concurrently.

Patients who showed significant residual nodal enlargement after chemotherapy were eligible to receive a higher total dose of radiotherapy to those regions. In this situation, it was recommended that there was pathological verification of active disease prior to administration of an additional 1.4 Gy for a total-nodal dose of 35 Gy.

Patients were monitored during chemotherapy using cardiac echo and pulmonary function studies.

Major outcome measures were event-free and overall survival.

### Outcome 1

One hundred and twenty-five patients entered the study, of whom 14 were excluded. In 11 cases this was due to lack of pathological verification, 2 were wrong diagnoses and 1 patient had received prior therapy. There were 71 stage III and 40 stage IV patients. Fifty-seven were randomized to MOPP/ABVD alone and 54 to ABVD plus radiotherapy.

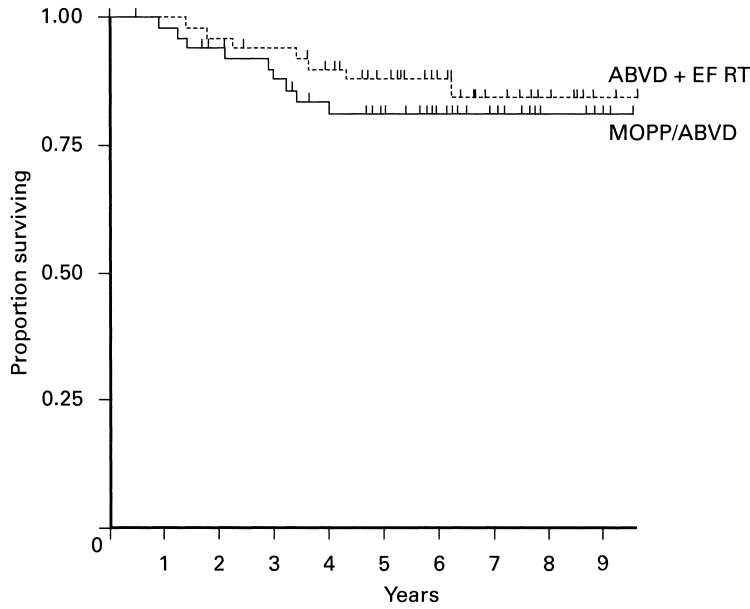
Overall compliance was good, with median dose of the different chemotherapy agents ranging from 93% to 100%. Eighty-two percent of radiotherapy was in compliance with the protocol. Six of the eight instances of non-compliance were due to reduced field, and one to reduced dose. One patient was not given radiotherapy, contrary to protocol.

### Outcome 2

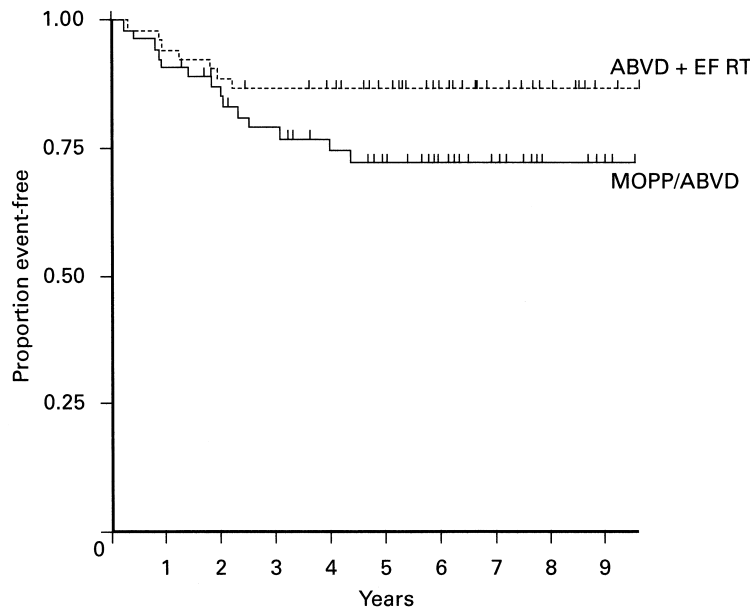
Overall survival for the study group was 87% at 4 years, 84% in regimen A and 90% in regimen B. Four-year

event-free survival for regimen A was 77% versus 87% in regimen B (Figures 10.1 and 10.2). The relative risk of death was 0.69 for those receiving radiotherapy. It is of note that all instances of relapsed disease in regimen A

were at sites that would have been included within the radiotherapy field under regimen B. There was no significant difference either for event-free or overall survival between the arms ( $p = 0.45$  and  $0.09$ , respectively).



**Figure 10.1** Survival by randomized regimens (ABVD: doxorubicin, bleomycin, vinblastine and dacarbazine; EF RT: extended field radiotherapy and MOPP: mustine, vincristine, procarbazine and prednisolone). © American Society of Clinical Oncology (full reference on p. 203).



**Figure 10.2** Event-free survival by randomized regimens (abbreviations as in Figure 10.1). © American Society of Clinical Oncology (full reference on p. 203).

## Toxicity

There were 190 neutropenic episodes on regimen A, compared to 65 on regimen B. Four patients developed grade III or IV cardiac toxicity and one patient on regimen A had a clinically significant cardiac complication. Eight patients had grade III or IV pulmonary toxicity, one clinically significant, on regimen A. There was one death due to tuberculosis. No second cancers are described.

## Conclusion

It was concluded that the outcome was comparable between both arms, although there did seem to be a somewhat lower event rate in those receiving combined modality therapy. It was suggested that both age and previous medical history should be taken into consideration when determining therapy.

## Study 2

Weiner MA, Leventhal B, Brecher ML, Marcus RB, Cantor A, Gieser PW, Ternberg JL, Behm FG, Wharam Jr MD, Chauvenet AR. Randomized study of intensive MOPP–ABVD with or without low-dose total-nodal radiation therapy in the treatment of stages IIB, IIIA2, IIIB and IV Hodgkin's disease in paediatric patients: a Pediatric Oncology Group study. *J Clin Oncol* 1997; **15**:2769–79.

The study was carried out between 1987 and 1992 by the Pediatric Oncology Group (POG) (POG protocol 8725).

### Objectives

This study was:

- To determine whether the addition of low dose nodal irradiation in pediatric patients with advanced stage Hodgkin's disease who have received alternating MOPP–ABVD chemotherapy improves event-free and overall survival when compared with patients who received chemotherapy alone.

### Details of study

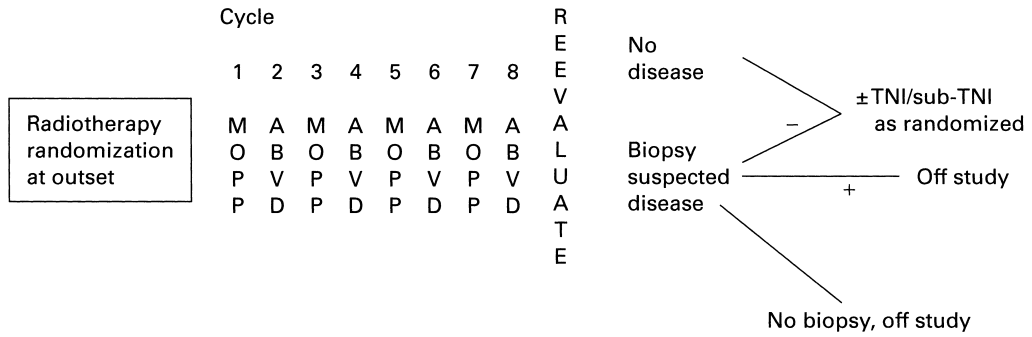
Children and adolescents were eligible (no age specified), presenting with stage IIB, IIIA2, IIIB and IV Hodgkin's disease. Stage IIIA2 was defined as involvement of both upper and lower abdominal nodes. Central pathology review was required for each patient. Staging laparotomy and splenectomy were required only in patients with clinical evidence of stage IA, IIA and IIIA1 disease. Gallium scan was routinely used in this study. If a staging laparotomy was not performed,

a minilaparotomy, which consisted of wedge biopsies plus deep-needle biopsy of both lobes of liver, and lymph node sampling were used to confirm the stage of disease. This was performed if the spleen was below the left costal margin or two or more times normal size on imaging or there were gross filling defects detected in the liver or spleen by CT or gallium scan or a greater than 3-cm lymph node was present at the porta hepatis or the splenic hilum on CT scan.

Echocardiography and pulmonary function tests were required during therapy.

Patients were randomized at diagnosis but there are no details of where or what method was used. No details of the difference anticipated or numbers required to demonstrate equivalence are given.

Standard chemotherapy comprised four 1-month cycles of MOPP, alternating with four 1-month cycles of ABVD for a total of 8 months of chemotherapy with or without radiotherapy (Figure 10.3). Response was evaluated after three and six cycles of chemotherapy, at the completion of MOPP–ABVD and after radiotherapy in those patients who received this modality. Abnormalities at the end of treatment were to be biopsied and if positive, patients came off study. Radiotherapy was administered at the end of eight cycles of chemotherapy to those patients in complete remission (CR), who were randomized at diagnosis to receive radiotherapy. The radiation field was determined by the pre-treatment evaluation. Patients with clinical evidence of pelvic disease by physical examination, imaging or laparotomy received total-nodal irradiation (TNI). Patients documented to have no evidence of disease below the aortic bifurcation received sub-TNI (mantle, spleen and para-aortic nodes). All lymphoid tissue, including the spleen, received 21 Gy. Liver, lung parenchyma, pericardium and kidney received doses of



MOPP = mustine, vincristine, procarbazine and prednisolone  
 ABVD = doxorubicin, bleomycin, vinblastine, dacarbazine

**Figure 10.3** Outline of therapy (abbreviations as in Figure 10.1). © American Society of Clinical Oncology (full reference on p. 205).

up to 10.5 Gy. Three radiation fields were sequentially treated, first the mantle, secondly the para-aortic nodes and spleen and thirdly the pelvis (if necessary). Radiation therapy was given at a dose of 1.5 Gy/day, 5 days/week and the 2-week rest period was provided between each port if hematological recovery was adequate.

Major outcome measures were event-free survival (EFS) and overall survival.

**Outcome**

One hundred and eighty-three patients were registered, of whom four were ineligible; two misdiagnoses, one with concurrent brain tumor and one institutional review board problem. The median age of those randomized was 13 years. Eighty-nine were randomized to chemotherapy alone and 90 to radiotherapy. There were 38 stage IIB, 22 stage IIIA2, 52 stage IIIB, 20 stage IVA and 47 stage IVB.

Eight patients failed to complete chemotherapy: there were two deaths due to septicemia, progressive disease in two, one developed non-Hodgkin’s lymphoma (NHL), one was lost to follow up and there were two major protocol violations.

At the end of three cycles 54 patients were in CR, after six cycles 78 were in CR and after eight cycles 132 of 171 patients (77%) attained a clinical CR as determined by physical and radiological examination. Thirty-nine patients had clinical evidence of residual disease. Five of these refused to have a biopsy performed and were removed from the study. Two of these five had

unequivocal evidence of progressive disease and were censored accordingly. Five patients had a positive biopsy and 29 a negative biopsy. Thus, 161 of 179 patients (90%) were in CR at the completion of chemotherapy.

Eighty-one had been randomized to chemotherapy alone, 80 to receive radiotherapy.

Ten of the 80 randomized to receive irradiation did not, in fact, receive this treatment. Five patients refused, four received radiation in non-POG institutions and were excluded and one developed acute myeloid leukemia (AML) prior to radiotherapy. Ultimately, 45 patients received TNI, 25 received sub-total TNI, i.e. the pelvic field was omitted.

**Toxicity**

Overall, chemotherapy was well tolerated. Two patients died of overwhelming sepsis during chemotherapy. Four patients experienced mild asymptomatic cardiac toxicity (ejection fraction <20% decrease from baseline). Six developed a second malignancy (three AML, one NHL, one melanoma).

**Outcome**

Overall EFS and survival at 5 years were 79 ± 6% and 92 ± 4%, respectively. EFS at 5 years for patients who received chemotherapy plus radiotherapy was 80 ± 8%, compared to 79 ± 9% for chemotherapy alone, with overall survivals of 87% and 96%, respectively. Two factors emerged as having prognostic significance,

namely, achievement of clinical CR after three cycles (EFS 94%, compared to 78% for those not in clinical CR), and 89% for those under 13 years of age versus 72% for those older than 13 years of age.

### Conclusion

It was concluded that there was no difference in outcome whether or not radiotherapy was added.

## Study 3

Cramer P, Andrieu J-M. Hodgkin's disease in childhood and adolescence: results of chemotherapy– radiotherapy in clinical stages IA–IIB. *J Clin Oncol* 1985;3:1495–502.

The studies were performed between 1972 and 1980 by the Hopital Saint-Louis and Hopital Laennec, Paris.

### Objectives

The aim of the study was:

- To analyze children and adolescents treated on two studies, one comparing mantle involved field irradiation following three courses of MOPP in stage IA–IIA disease, and the second study comparing MOPP and CVPP chemotherapy in stage II, IIIA and IIB disease.

### Details of the study

Patients between the ages of 5 and 19 years were included in the analysis. They had clinical stage IA–IIB disease. Surgical staging was not performed but lymphangiography was used in all patients.

The randomization method used is not stated nor where it was done. No planned numbers or differences sought in the study are described.

### Study H7701

The patients with stage IA–IIA disease were treated with three courses of MOPP chemotherapy. They were then randomized to either mantle radiotherapy, receiving 35–40 Gy, or involved field, receiving 40 Gy.

### Study H7702

The patients with stage II, IIIA and IIB disease were randomized at diagnosis to receive either three courses of MOPP or three courses of CVPP (CCNU, vinblastine, procarbazine and prednisone). At the end of chemotherapy both groups then underwent laparotomy followed by supradiaphragmatic radiotherapy, plus lumboaortic field radiotherapy when there was histologically proven splenic or lumboaortic involvement.

Major endpoints were relapse-free and overall survival.

### Outcome

#### Study 7701

Five patients received mantle and 10 patients received involved field irradiation. The numerical imbalance was because 8 patients were not stratified by age in the overall study, including adults. In the 5 receiving mantle irradiation there was one abdominal relapse. In the 10 involved field patients, there were two abdominal relapses and one mediastinal relapse.

#### Study 7702

Eight of 8 patients receiving MOPP achieved complete remission and 8 of the 9 receiving CVPP achieved complete remission. There was one abdominal relapse, in a patient who had received CVPP. There were no deaths in complete remission.

### Conclusion

The numbers in this study were too small to draw any firm conclusion, although no significant difference was observed between any of the study groups.

## Study 4

Oberlin O, Leverger G, Pacquement H, Raquin MA, Chompret A, Habrand JL, Terrier-Lacombe MJ, Bey P, Bertrand Y, Rubie H, Behar C, Zucker JM, Schaison G, Lemerle J. Low-dose radiation therapy and reduced chemotherapy in childhood Hodgkin's disease: the experience of the French Society of Paediatric Oncology. *J Clin Oncol* 1992;**10**:1602–8.

The study was carried out between 1982 and 1988 and was organized by the French Society of Paediatric Oncology.

### Objectives

The aim of the study was:

- To compare ABVD alone to MOPP plus ABVD in favorable Hodgkin's disease with the addition of reduced dose radiotherapy following a good response to chemotherapy.

### Details of the study

Eligible patients were aged up to 18 years. There was uniform clinical staging, with CT scan in all and lymphangiography in 95%. Bone marrow biopsy was obtained in children with a clinical stage IIB or more advanced disease. Laparotomy was performed for diagnostic node biopsy in three cases and for staging in one.

The study was designed to include patients with all stages of disease. Those with upper neck IA disease received four cycles of doxorubicin, bleomycin, vinblastine and dacarbazine (ABVD) and those with stage IB, IIB, III or IV disease received three cycles mustine, vincristine, procarbazine and prednisolone (MOPP) plus three cycles of ABVD, followed by involved field and lumbosplenic field irradiation. The randomized trial was limited to stage IA and IIA disease, but excluded patients with unilateral nodes localized to the upper neck, who received four cycles of ABVD, and patients with stages IA or IIA who had an ESR >80, who were treated as if they had B symptoms.

The precise randomization technique is not stated but patients were allocated randomly to treatment arms by telephone.

It was hypothesized that ABVD alone was as effective as MOPP plus ABVD in terms of overall survival and disease-free survival in favorable stages. The allowable

limit of the true difference between the two arms was 10%. The numbers required are not detailed.

Patients were randomized to receive either four courses of ABVD or alternating two courses of MOPP plus two cycles of ABVD. Response evaluation was performed at the end of chemotherapy. Good remission was defined as complete clinical or radiological disappearance of all tumor (complete remission, CR) or tumor volume reduction of more than 70% (good partial remission, PR). Failure was defined as less than 70% shrinkage or early recurrence before radiotherapy was started.

Good responders received 20 Gy and poor responders 40 Gy. This was given 1 month after completion of chemotherapy. Involved field irradiation was based on the initial clinical or radiological examination. Bilateral neck irradiation was always performed to avoid asymmetrical growth disturbance. In the supraclavicular field, the external third of the collar bone was excluded to avoid shoulder growth impairment. Lung hila were not irradiated if the patients had only mediastinal disease. For mediastinal disease, radiation was limited to the residual mediastinum after initial chemotherapy.

The major outcome measures were event-free and overall survival.

### Outcome

One hundred and thirty-six patients with stage IA or IIA disease were registered. Overall, 82% of these achieved a CR with chemotherapy and the overall disease-free survival at 6 years was 89%.

One hundred and thirty-two patients were randomized, the reason for non-randomization in the four cases is not given. Three patients who were randomized should have been excluded on the basis of elevated ESR or B symptoms.

Sixty-seven were randomized to MOPP plus ABVD and 65 to ABVD alone. There was no significant imbalance between the two groups, although 38% in the hybrid arm had mediastinal involvement, compared to 55% of those receiving ABVD alone. The actuarial risk of relapse at 4 years was 13% for MOPP/ABVD and 10% for ABVD alone.

### Toxicity

Treatments were well tolerated. One patient developed acute myeloid leukemia; 10% of patients developed

herpes zoster. No details of late cardiac or pulmonary toxicity are given.

### Conclusion

It was concluded that the treatments are comparable but no recommendation is offered on which should be chosen. The single arm evaluation of reduced dose radiotherapy in good responders suggested this was an appropriate strategy.

### Comment

Preliminary data on 174 patients from this trial were also published by Dionet C, Oberlin O, Habrand JL, Vilcoq J, Madelain M, Dutou L, Bey P, Lefur R, Thierry P, LeFloch O, Sarrazin D. Initial chemotherapy and low-dose radiation in limited fields in childhood Hodgkin's disease: results of a joint cooperative study by the French Society of Paediatric Oncology (SFOP) and Hopital Saint-Louis, Paris. *Int J Radiat Oncol Biol Phys* 1988;15:341–6.

## Study 5

Sackmann-Muriel F, Zubizarreta P, Gallo G, Scopinaro M, Alderete D, Alfaro E, Casak S, Chantada G, Felice MS, Quinteros R. Hodgkin's disease in children: results of a prospective randomized trial in a single institution in Argentina. *Med Pediatr Oncol* 1997;29:544–52.

The study was carried out between 1987 and 1994 as part of a national study including adults. The Buenos Aires Group present pediatric data, which was possible because of stratification by center in the national study.

### Objectives

The aim of the study was:

- To compare duration of chemotherapy in favorable disease and two different chemotherapies in an intermediate risk group.

### Details of the study

Eligibility had no age limits. Patients were staged clinically, predominantly with CT scanning. A small number had lymphography. Laparotomies were not performed. No central pathology review was performed for this publication.

Randomization details are not given with regard to method or site. The anticipated numbers of patients required, or the differences sought between study arms, are not detailed.

Patients were grouped on the basis of the Argentine Group for the Treatment of Acute Leukaemias (GATLA) prognostic index for Hodgkin's disease into favorable, intermediate and unfavorable groups. The randomized study applied only to the favorable and intermediate groupings (see Table 10.1 for prognostic scoring system). Twenty-six patients were in the favorable group. Using conventional staging, there were 21 stage IA and IIA, 3 stage IB or IIB and 2 stage IIIA. There were 64 patients in the intermediate risk group, comprising 32 stage IA, IIA, 12 stage IB, IIB, 18 stage IIIA, IIIB and 2 stage IVA.

The unfavorable group included 24 patients, 19 stage IIIB and 5 stage IVB. These were all given an intensive multiagent chemotherapy regimen, plus involved field radiotherapy.

The favorable group was randomized at presentation between three or six courses of CCNU, vincristine, procarbazine and prednisone (CVPP) chemotherapy. This consisted of cyclophosphamide 600 mg/m<sup>2</sup> on days 1 and 8, vincristine 6 mg/m<sup>2</sup> on days 1 and 8, procarbazine 100 mg/m<sup>2</sup> on days 1–14 and prednisolone 40 mg/m<sup>2</sup> on days 1–14.

The intermediate group was randomized between CVPP with three courses prior to involved field radiotherapy or to three courses of doxorubicin, vincristine, etoposide and prednisolone (AOPE) chemotherapy, again three courses prior to and three courses following and after radiotherapy. AOPE comprised doxorubicin 45 mg/m<sup>2</sup> day 1, vincristine 1.5 mg/m<sup>2</sup> day 1, etoposide 150 mg/m<sup>2</sup> days 1 and 3, prednisolone 100 mg/m<sup>2</sup> days 1–5. The radiotherapy dose depended on the initial response to chemotherapy. If there was a greater than 70% reduction in imageable disease a dose of 30 Gy



**Table 10.1** Score to define the prognostic index.

Age (year)	Symptoms*	Stage	Number of involved regions
≤15 = 0	A = 0	I = 0	<3 = 0
16–30 = 1	B1 = 1	II = 1	3–4 = 1
31–45 = 2	B2 = 2	III = 2	5–6 = 2
>45 = 3	B3 = 3	IV = 3	>6 = 3

\*A: absence; B: presence (number of symptoms).

Staging according to prognostic index:

Favorable group: score 0–3 (if “bulky” mediastinum, upgrade to intermediate group).

Intermediate group: score 4–5.

Unfavorable group: score >5.

was given. If a less favorable response, 40 Gy was given to the originally involved areas.

The primary outcome measures of the study were the response to chemotherapy and event-free survival (EFS) and overall survival.

### Outcome

The randomized study in the favorable subgroup closed following interim analysis in 1992. This showed no significant differences in either complete response rates (100% and 94%, respectively, for three or six courses of CVPP) on 80-month EFS ( $85\% \pm 13\%$  for three courses, compared with  $87\% \pm 8\%$  for six courses).

In the intermediate group, response rate was 98% for the CVPP regimen, versus 86% for the AOPE regimen, but the 80-month EFS was  $87\% \pm 5\%$  versus  $67\% \pm 10\%$ , respectively ( $p < 0.04$ ).

Overall, the 80-month EFS for stage IA, IIA was 78% ( $n = 53$ ), stage IB, IIB 86% ( $n = 15$ ) and 84% for stage III ( $n = 39$ ).

Three patients had progressive disease on the AOPE regimen. All achieved a second complete remission with the multiagent regimen used for the unfavorable group.

### Toxicity

There was one septic death in the intermediate risk group. No other details of late toxicity are given.

### Conclusion

It was concluded that three courses of CVPP are adequate for the good-risk group and that the etoposide-based regimen was inferior for the intermediate risk group.

## Study 6

Sullivan MP, Fuller LM, Berard C, Ternberg J, Cantor AB, Leventhal BG. Comparative effectiveness of two combined modality regimens in the treatment of surgical stage III Hodgkin's disease in children. An 8-year follow-up study by the Pediatric Oncology Group. *Am J Pediatr Hematol Oncol* 1991;13:450–8.

The study was carried out by the Pediatric Oncology Group between 1976 and 1982.

### Objectives

The aim of the study was:

- To compare two combined modality regimens in children with stage III disease, using either an alkylating regimen, including bleomycin, or an alkylating regimen with an anthracycline.

### Details of the study

Eligible patients were under 18 years of age with central pathological review in all cases. Patients

were untreated, were surgically staged and had lymphography.

The randomization method or location is not detailed. It was anticipated that 69 patients would be required in each of the study arms to give an 80% power to detect a 15% difference in complete response rates. Due to poor recruitment late in the study it was closed prematurely, resulting in an 80% power to detect a 20% difference.

Patients were randomized either to receive sandwich MOPP-B with involved field radiotherapy, which included six courses of MOPP-B every 28 days either side of involved field radiotherapy (two before, four after), or the alternative, A-COPP, which again comprised six courses given every 42–56 days (Figure 10.4).

The radiotherapy dose was 35–40 Gy. There was no central review of radiotherapy and few details of the precise fields are given. There was an 8-week rest after radiotherapy prior to continuing chemotherapy.

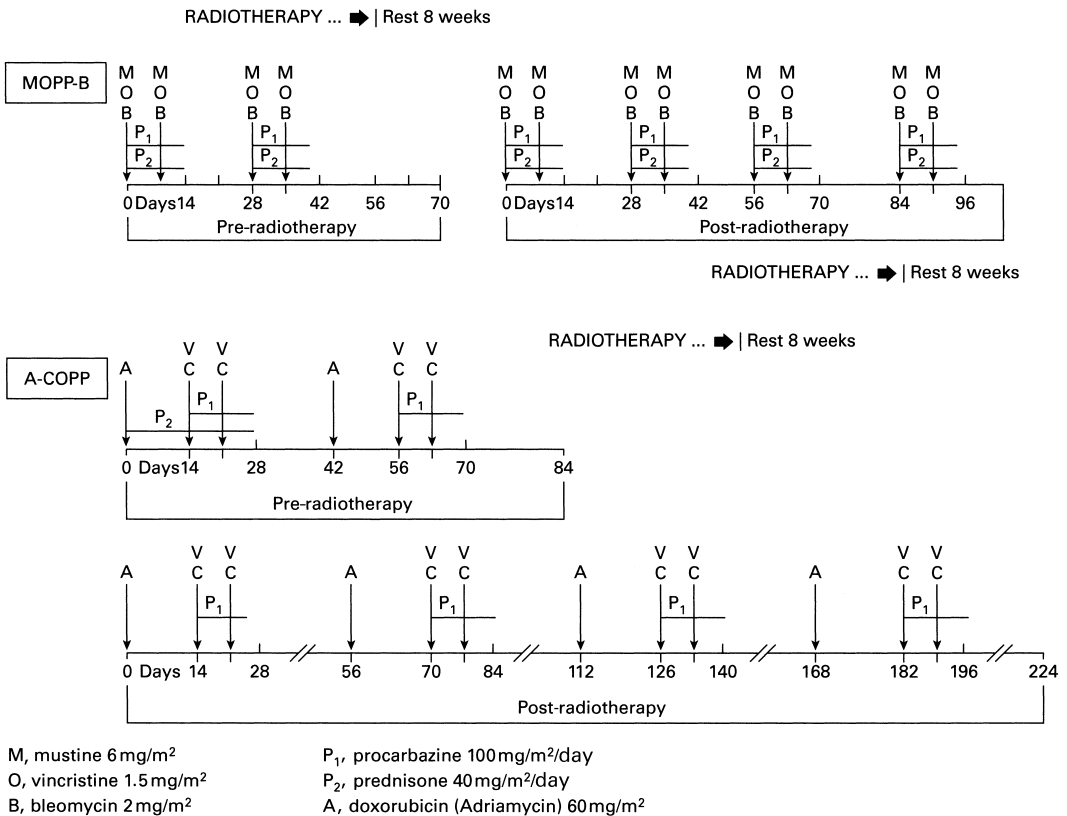
The primary outcome measure was response rate and event-free and overall survival.

**Outcome**

One hundred and thirty-two patients were entered on the study but 48 were excluded. Thirty-seven were from overseas and excluded due to quality of data, four had the wrong diagnosis, four were lost to follow up, two were protocol violations and one patient was withdrawn due to toxicity.

Of the 84 patients evaluated, all received over 90% of planned therapy. Forty-five were treated with MOPP-B, of whom 38 achieved complete remission (CR) (84%). Thirty-nine received A-COPP, of whom 36 achieved CR (92%). The precise time at which CR was documented is not given.

At 10 years event-free survival was 70% for MOPP-B versus 67% for A-COPP and overall survival 84% and 83%, respectively, i.e. no significant difference. No



**Figure 10.4** Chemotherapy regimens MOPP-B versus A-COPP. Reproduced with permission of Lippincott, Williams & Wilkins (full reference on p. 210).

difference was observed for patients with IIIA or IIIB disease or mixed cellularity or nodular sclerosing histology.

**Toxicity**

Severe infections were documented in three patients receiving MOPP-B, and cardiac complications in two patients receiving A-COPP. One patient on MOPP-B

developed acute myeloid leukemia and one patient on A-COPP developed secondary osteosarcoma.

**Conclusion**

It was concluded that there was no difference between the two regimens with regard to efficacy.

**Study 7**

Gehan EA, Sullivan MP, Fuller LM, Johnston J, Kennedy P, Fryer C, Gilchrist GS, Hays DM, Hanson W, Heller R, Jenkin RDT, Kung F, Sheehan W, Tefft M, Ternberg J, Wharam M. The Intergroup Hodgkin's disease in children. A study of stages I and II. *Cancer* 1990;65:1429–37.

The study was carried out between 1977 and 1981 by the Pediatric Oncology Group, Children's Cancer Group and the Acute Leukemia Group B.

**Details of the study**

Eligibility included less than 18 years of age, centrally reviewed pathological diagnosis, pathologically staged I or II disease, and no prior therapy except emergency mediastinal irradiation.

No details of randomization method or location are given. It was estimated that 47 patients per group were required to provide an 80% power to detect a 22% advantage to the addition of MOPP chemotherapy, with 5% significance level in a one-sided test.

Study outline for first- and second-line treatment is given in Figure 10.5.

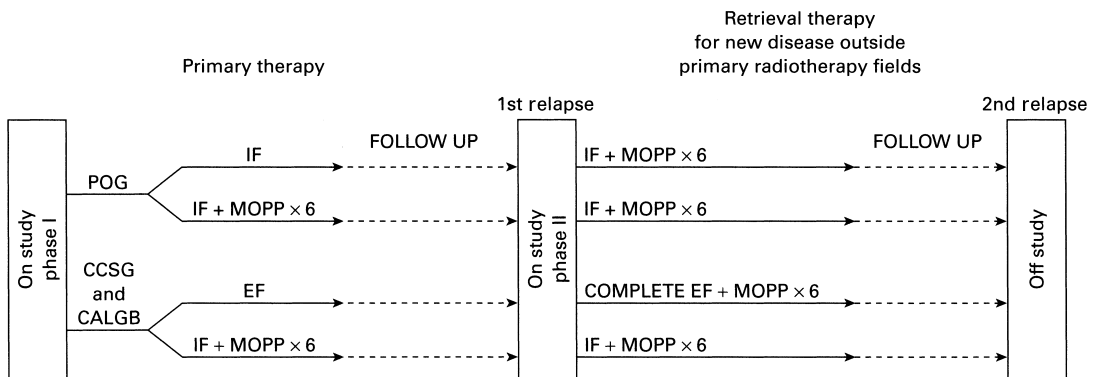
All patients received radiotherapy, which was to be administered within 28 days of pathological diagnosis.

Involved field (IF) radiotherapy included the known involved regions of disease and extended field (EF) included involved regions and continuous uninvolved nodal regions. For stage I and II nodal disease above the diaphragm, the EF volume to be irradiated included the mantle, para-aortic regions to the level of L4 and

**Objectives**

The aim of the study was:

- To combine data from two separate studies addressing the issue of the benefit of adjuvant MOPP to either involved field or extended field radiotherapy in children with stage I and II disease.



**Figure 10.5** Treatment options for initial and recurrent disease. © 1990 American Cancer Society. Adapted from Gehan *et al.* (full reference above) by permission of Wiley-Liss, Inc., a subsidiary of John Wiley & Sons, Inc.

the splenic pedicle. For stage II nodal disease in the inguinal and iliac regions without para-aortic involvement, the inverted Y volume was irradiated. Involved regions were given a dose of 35–40 Gy. Residual disease could be given further boost doses at the discretion of the radiotherapist. For EF radiotherapy 35 Gy was recommended as the lower dose limit.

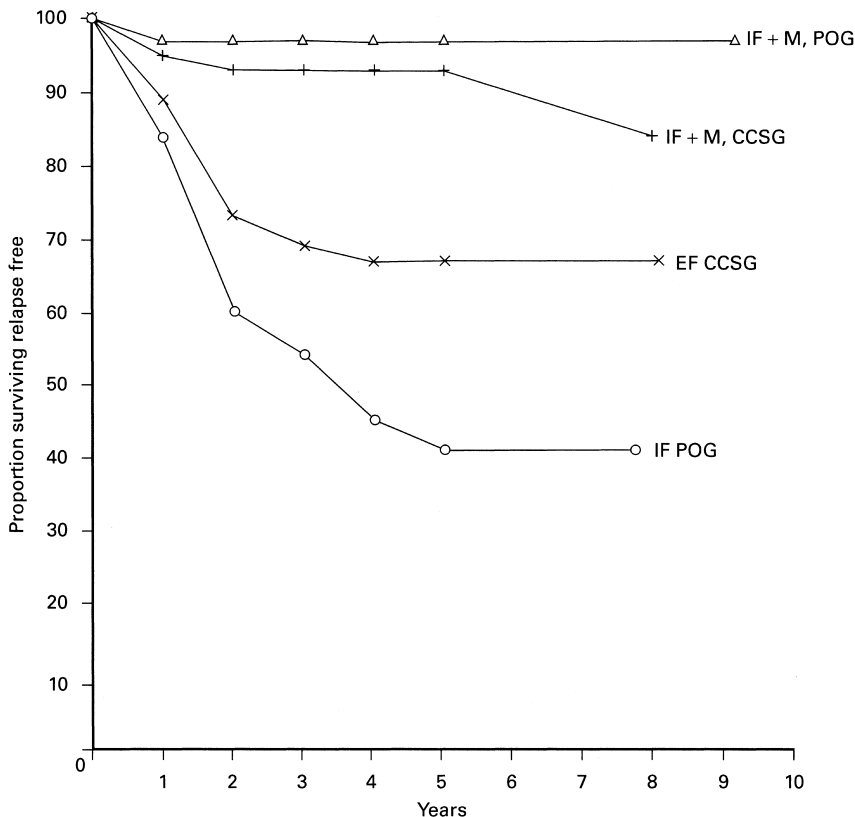
In the combined modality regimen, MOPP chemotherapy followed 4 weeks after IF therapy. Six standard courses were given at 28-day intervals.

Three clinical presentations were excluded from the randomized study, as these were regarded as a favorable subgroup and were treated as elected by the institutional investigators. These comprised stage I unilateral upper neck disease of any histological type other than lymphocyte depleted, stage I unilateral inguinal disease of any histological type and stage I mediastinal disease of the nodular sclerosing type.

The main outcome measures were relapse-free survival at 2 years and overall event-free and overall survival.

## Outcome

Three hundred and six patients were registered, of whom 24 were excluded due to lack of data; 220 of 282 were randomized, with 26 excluded after randomization: 10 wrong staging, 8 refused randomization, 6 inadequate laparotomy and 2 not Hodgkin's disease. These were excluded from the subsequent analysis. Of the remaining patients in the POG study, 39 patients were randomized to IF radiotherapy alone and 41 to IF plus MOPP; 21 of 39 who received IF alone relapsed, compared to 1 of where MOPP was also given. In the CCSG/CALGB study, 58 patients were randomized to EF radiotherapy, of whom 18 relapsed, and 56 to EF plus MOPP, of whom 5 relapsed.



**Figure 10.6** Comparisons of relapse-free survival by treatment and cooperative group for the randomized, eligible patients. Copyright © 1990 American Cancer Society. Adapted and reprinted from Gehan *et al.* (full reference on p. 212) by permission of Wiley-Liss, Inc., a subsidiary of John Wiley & Sons, Inc.

The 5-year relapse-free survival for IF plus MOPP was 97% versus 41% for IF alone ( $p = 0.01$ ) and for EF radiotherapy 67% versus IF plus MOPP 93% ( $p = 0.01$ ) (Figure 10.6). Despite the significant advantages to the addition of MOPP in both studies, there was no difference in ultimate survival. This was 89% for IF + MOPP, 95% for IF in the POG studies, 90% IF + MOPP and 96% EF in the CCG/ALGB study.

Overall, six second cancers were reported, five had received IF with MOPP, with three leukemias, one brain tumor, one germ cell tumor and one salivary gland carcinoma in a patient receiving EF radiotherapy alone.

### Conclusion

It was concluded that combination chemotherapy with IF provides a superior relapse-free survival but

little impact on overall survival. The overall burden of therapy must be taken into account as in most cases further radiation therapy was given following relapse, in addition to further alkylating agent chemotherapy.

### Comment

A preliminary report of this study on 223 randomized patients was published by Sullivan MP, Fuller LM, Chen T, Fisher R, Fryer C, Gehan E, Gilchrist GS, Hays D, Hanson W, Heller R, Higgins G, Jenkin D, Kung F, Sheehan W, Tefft M, Ternberg J, Wharam M. Inter-group Hodgkin's disease in children study of stages I and II: a preliminary report. *Cancer Treat Rep* 1982; **66**:937–47.

## Study 8

Louw G, Pinkerton CR. Interventions for early stage Hodgkin's disease in children (Cochrane Review). *The Cochrane Library* 2001;1.

This is a formal systematic review of randomized data regarding treatment for early stage Hodgkin's disease in children.

### Objectives

The objective was:

- To assess the effects of radiotherapy, chemotherapy or combined radiotherapy and chemotherapy on relapse-free and overall survival rates in children with early stage (I–IIA) Hodgkin's disease.

### Details of the study

The search strategy involved search of the Cochrane Library, Medline, 1966–98, Embase, Cinahl, Cancer CD and reference lists of relevant articles. Three journals were also hand searched.

Selection criteria were randomized controlled trials of involved field radiotherapy, extended field radiotherapy, anthracycline-based chemotherapy regimens

or alkylating chemotherapy agents in children up to 19 years of age with Hodgkin's disease.

Trial eligibility and quality were assessed and study authors were contacted for additional information.

### Outcome

Four trials involving 334 children were included. It was not possible to combine the outcomes as they covered different treatment regimens. The trials were of variable quality. One trial comparing radiotherapy alone showed no discernible difference in relapse-free survival (relative risk 0.73, 95% confidence interval 0.49–1.09) or overall survival (relative risk 0.92, 95% confidence interval 0.79–1.07) between involved field and extended field radiotherapy. No discernible difference was found between involved field radiotherapy plus chemotherapy and extended field radiotherapy and chemotherapy (based on one small trial). In another trial, involved field radiotherapy plus chemotherapy appeared to increase relapse-free survival compared to either involved field or extended field radiotherapy alone, although a discernible difference was found for overall survival. Extended field radiotherapy alone appeared to increase relapse-free survival compared to extended radiotherapy plus chemotherapy (relative risk 0.34, 95% confidence interval 0.14–0.83) but no discernible difference was apparent for overall survival (based on one trial).

Studies included in the review were:

Bayle-Weisgerber C, Lemerrier N, Teillet F, Asselain B, Gout M, Schweisguth O. Hodgkin's disease in children, results of therapy in a mixed group of 178 clinical and pathologically staged patients over 13 years. *Cancer* 1984;**54**:215–22.

Cranmer P, Andrieu JM. Hodgkin's disease in childhood and adolescence: results of chemotherapy–radiotherapy in clinical stages IA–IIB. *J Clin Oncol* 1985;**3**:1495–502.

Gehan EA, Sullivan MP, Fuller LM, Johnston J, Kennedy P, Fryer C. The Intergroup Hodgkin's disease in children. A study of stages I and II. *Cancer* 1990;**1429**–37.

Hutchison G. Radiotherapy of stage I and II Hodgkin's disease. A collaborative study. *Cancer* 1984;**54**:1928–54.

Sullivan M, Fuller L, Chen T, Fisher R, Fryer C, *et al*. Intergroup Hodgkin's disease in children. Study of stages I and II: a preliminary report (full report Gehan 1990). *Cancer Treat Rep* 1982;**66**:937–47.

## Study 9

Nachman JB, Sposto R, Herzog P, Gilchrist GS, Wolden SL, Thomson J, Kadin ME, Pattengale P, Davis PC, Hutchinson RJ, White K, Children's Cancer Group. Randomised comparison of low-dose involved-field radiotherapy and no radiotherapy for children with Hodgkin's disease who achieve a complete response to chemotherapy. *J Clin Oncol* 2002; **20**:3765–71.

### Objectives

The aim of the study was:

- To determine whether involved field radiation therapy can be omitted after a complete remission is achieved using combination chemotherapy.

Carried out by the American Children's Oncology Group between 1995 and 1998.

### Details of study

A prospective randomized trial for patients with Hodgkin's disease under the age of 21 years. Patients with localized and advanced disease were included and stratified according to clinical risk grouping (see Table 10.2).

There was central review of all pathology.

No details of randomization method or site are given.

It was planned to randomize 650 patients, which would have an 83% power to detect a 50% increase in failure rate. This is equivalent to a 6% reduction in event-free survival (EFS). There was planned to be 0.1 type 1 error with overall 1-year follow-up.

Before planned completion date the data monitoring committee recommended ceasing randomization because of a significant difference in outcome.

**Table 10.2** Clinical group definitions.

#### Group 1

Stage I patients without adverse disease features<sup>a</sup>

Stage II patients without adverse disease features<sup>a</sup> and without clinical "B" symptoms

#### Group 2

Stage I patients with adverse disease features<sup>a</sup>

Stage II patients with adverse disease features<sup>a</sup> and/or with clinical B symptoms<sup>b</sup>

Stage III patients

#### Group 3

Stage IV patients

<sup>a</sup>Adverse disease features comprise one or more of the following hilar adenopathy, involvement of more than four nodal regions; mediastinal tumor with diameter greater than or equal to one-third of the chest diameter, and node or nodal aggregate with a diameter greater than 10 cm.

<sup>b</sup>Clinical B symptoms comprise one or more of the following: unexplained loss of more than 10% of body weight, unexplained recurrent fever greater than 38°C, and drenching night sweats.

## Study design

Patients in groups 1 and 2 received COPP/ABV chemotherapy.

Patients in group 3 received an alternative intensive multiagent regimen (see Table 10.3).

All those who achieved a complete remission (CR) were randomized between no further therapy or low dose involved field radiation. This comprised 21 Gy in 12 fractions. For stage IV lung disease 10.5 Gy were given.

CR was documented using standard radiology and, as appropriate, bone scan or bone marrow aspirate. Patients with greater than 70% reduction in tumor mass with a gallium scan that changed from positive to negative were also included as CR.

Eight hundred and thirty-four patients were enrolled on study; 5 were excluded on pathology review; 29 were not assessable following chemotherapy; 650 achieved CR and were eligible for randomization; 501 were randomized of whom 251 were to receive radiation therapy; 67% of patients who declined randomization did not receive radiotherapy.

Overall, risk groups were well balanced between the two arms for radiotherapy and no radiotherapy. Stage III and IV disease, 25% versus 31%, B symptoms present, 25% versus 18%, large mediastinal mass, 18% versus 21%, nodular sclerosing pathology, 77% versus 73% and clinical group 3, 13% versus 14%, respectively.

## Toxicity

Grade III and IV hematological toxicity occurred in 30%, 33% and 69% of group 1–3, respectively. Infection rate 2% for groups 1 and 2 versus 11% group 3. Twenty-three patients refused radiotherapy following randomization.

## Outcome

The 3-year EFS did not differ between treatment arms. For Group 1 patients EFS was 95% versus 100%, for Group 2 82% versus 93% and Group 3 83% versus 93% for those receiving and not receiving radiation respectively. However, with an as-treated analysis 3-year EFS estimates were 93% for those who received radiation therapy versus 85% for those who did not ( $p = 0.02$ ) (see Figure 10.7).

**Table 10.3** Details of chemotherapy.

---

### **COPP/ABV (clinical groups 1 and 2, repeat cycle every 28 days)**

- (C) Cyclophosphamide 600 mg/m<sup>2</sup> IV, day 0
- (O) Vincristine 1.4 mg/m<sup>2</sup> IV push, day 0
- (P) Procarbazine 100 mg/m<sup>2</sup>/day, days 0–6
- (P) Prednisone 40 mg/m<sup>2</sup>/day PO, divided into two doses, days 0–13
- (A) Doxorubicin 35 mg/m<sup>2</sup> IV, day 7
- (B) Bleomycin 10 U/m<sup>2</sup> IV, day 7
- (V) Vinblastine 6 mg/m<sup>2</sup> IV, day 7

### **Group 3 chemotherapy (two full cycles)**

#### *Cycle A*

- Cytarabine 3 g/m<sup>2</sup> IV (3-hour infusion) every 12 hours for four doses, days 0 and 1
- Etoposide 200 mg/m<sup>2</sup> (1-hour infusion) every 12 hours for four doses immediately after cytarabine, days 0–1
- SC G-CSF, 5 µg/kg/day, starting day 2 and continuing until absolute neutrophil count was >1000/µl

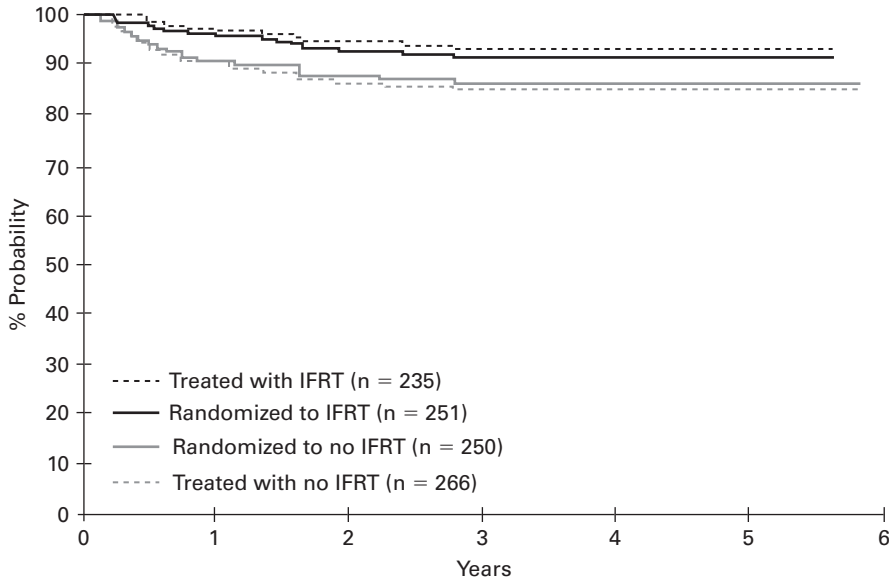
#### *Cycle B*

- COPP/ABV days 21–27 followed by G-CSF starting day 28, 5 µg/kg/day
- SC, starting day 32 and continuing until absolute neutrophil count was >1000/µl

#### *Cycle C*

- Cyclophosphamide 1,200 mg/m<sup>2</sup> IV, days 42–43
  - Vincristine 1.4 mg/m<sup>2</sup> IV, day 42
  - Doxorubicin 25 mg/m<sup>2</sup>/day continuous infusion IV, days 42–44
  - Methylprednisolone 250 mg/m<sup>2</sup> IV every 6 hours for four doses on day 42
  - Prednisone 60 mg/m<sup>2</sup> PO (divided into three doses), days 43–46
  - G-CSF 5 µg/kg/day SC, starting day 46 and continuing until absolute neutrophil count was >1000/µl
- 

G-CSF: granulocyte colony-stimulating factor.



**Figure 10.7** Three-year EFS from randomization. Intent-to-treat analysis (thick lines): 92%  $\pm$  1.0 EFS with involved field radiation (IFRT); 87%  $\pm$  2.2% EFS with no IFRT. As-treated analysis (thin lines): 93%  $\pm$  1.7% EFS with IFRT; 85%  $\pm$  2.3% EFS with no IFRT. © American Society of Clinical Oncology (full reference on p. 215).

Overall survival did not differ between the two groups, 98% versus 99%. Following relapse, salvage was better in those who received chemotherapy alone, 94% versus 84%. The sites of relapse in those who relapsed after chemotherapy alone were 29 occurring in areas of previously known disease three in previous and new sites and two in new areas. For the patients who relapsed after chemotherapy and radiation therapy seven occurred only within the radiation field, three both in and out of field and two in previously uninvolved areas alone.

### Conclusion

Although there was no significant difference in EFS in those randomized there did appear to be some benefit if the actual treatment delivered was taken into consideration. This however did not translate into any survival advantage. The investigators concluded that combined modality therapy remains a standard of care although there may be a significant fraction of patients who can be cured with chemotherapy alone.

## Study 10

Lascar S, Gupta T, Vimal S, Muckaden MA, Saikia TK, Pai SK, Naresh KN, Dinshaw KA. Consolidation radiation after complete remission in Hodgkin's disease following six cycles of doxorubicin. Bleomycin, vinblastine and dacarbazine chemotherapy: is there a need? *J Clin Oncol* 2004;22:62–8.

This was a single center study with patients attending the lymphoma clinic at the Tata Memorial Hospital. Mumbai from 1993 till 1996.

### Objectives

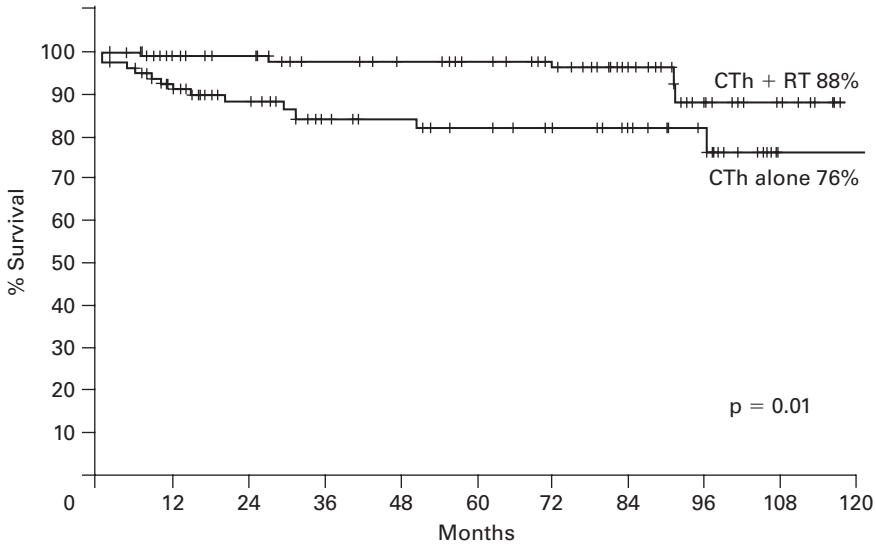
The main objective was:

- To determine whether after complete remission is achieved with ABVD chemotherapy the addition of involved field radiation improves outcome.

### Study details

Eligible patients included children and adults with stage I–IV Hodgkin's disease. CT scan of abdomen was





**Figure 10.8** Event-free survival (CTh: chemotherapy and RT: radiotherapy). © American Society of Clinical Oncology (full reference on p. 217).

mandatory if ultrasound was negative. Bulky disease was described as nodes greater than 7-cm diameter or mediastinum greater than 0.33 mediastinal tumor ratio. All pathology was reviewed by the institutional pathologist.

Methods of randomization involved “computerized software”.

Site of randomization not specified.

No details of the statistical methodology with regard to the difference expected, power or number of patients required.

### Study design

Standard ABVD chemotherapy (doxorubicin 25 mg/m<sup>2</sup> IV days 1 and 15, bleomycin 10 mg/m<sup>2</sup> IV days 1 and 15, vinblastine 6 mg/m<sup>2</sup> IV days 1 and 15 and dacarbazine 375 mg/m<sup>2</sup> IV days 1 and 15). Each cycle was repeated every 4 weeks for total of six cycles. After six cycles patients were evaluated for response, clinically and radiologically. Complete responders were randomly assigned to either observation or consolidation radiation. Radiation was started at least 3 weeks after, and within 6 weeks of completing, chemotherapy. Recommended radiation comprised involved field either clinically planned (neck) or on simulation (mediastinum, para-aortic and other sites); 84% of patients received IFRT; 10% received inverted Y as a result of extensive initial abdominal disease; 4% received

mantle field for extensive supradiaphragmatic disease. One patient received total-nodal radiation. Planned dose was 30 Gy with a 10-Gy boost to bulky disease. With extended field the dose was 25 Gy with a boost of 10 Gy to bulky disease. Total-nodal radiation dose was 21 Gy. The actual dose delivered range from 20 to 44 Gy.

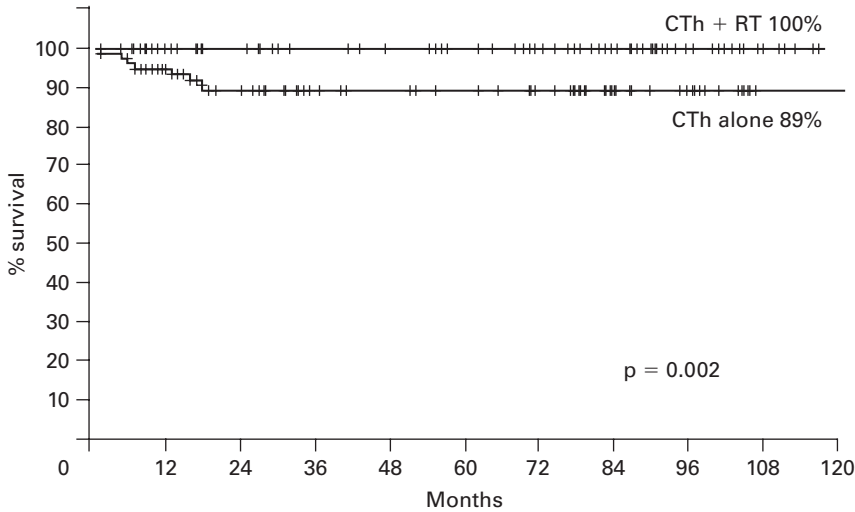
### Outcome

Two hundred and fifty-one patients were started on ABVD chemotherapy of whom 129 achieved complete remission (71%) there were 56 stage I, 43 stage II, 68 stage III and 12 stage IV. Ages ranged from 4 to 70 years, median 18 years.

Eighty-four were randomized to chemotherapy alone, 95 received radiation therapy; 49% of patients were children under the age of 15 years. Randomized groups were well balanced for clinical risk factors and histology. For chemotherapy and radiotherapy, respectively, nodular sclerosis 12% and 15%. Stages III and IV 47% and 42%, bulky disease 12% and 18%, stage B 51% and 56%.

### Toxicity

There was no difference in toxicity between the two groups. The incidence of pneumonitis was 2% and 3%, with and without radiation.



**Figure 10.9** Overall survival (abbreviations as in Figure 10.8). © American Society of Clinical Oncology (full reference on p. 217).

The 8-year event-free survival with radiation was 88% versus 76% with chemotherapy alone  $p < 0.01$  (no confidence interval stated). The difference was especially marked in patients under the age of 15 years, 97% versus 53%, those with bulk disease, 100% versus 72%, B symptoms, 86% versus 66% and advanced stage III and IV disease, 78% versus 59%. Overall survival was also significantly better for those receiving radiation 100% versus 89%  $p = 0.002$  (Figures 10.8 and 10.9).

Eleven out of 84 patients relapsed in the chemotherapy arm, of these 6 had nodal relapse only, and 4 had systemic relapses in addition to nodal relapse. One patient had an isolated systemic relapse. In the chemotherapy and radiation arm all 5 relapses were nodal, none in a previously radiated site; 3 of 11 who relapsed following chemotherapy alone were successfully

salvaged. In the radiation arm; 4 patients were successfully salvaged after a relapse. There were 3 toxic deaths during second-line therapy, 2 from cardiac toxicity and 1 from hepatitis.

### Conclusion

It was concluded that addition of involved field radiation significantly improved outcome following ABVD chemotherapy. The possibility of a biological difference in Hodgkin's disease in India was noted. In this population there is a single peak incidence age 15–20 years compared to the typical western bimodal peak and mixed cellularity rather than nodular sclerosis is the most common histology.

*This page intentionally left blank*

**PART 2**

# Leukemia

*AG Shankar*

*This page intentionally left blank*

# Acute myeloid leukemia

*Commentaries by Judith Chessells and Vaskar Saha*

The long-term survival for children with acute myeloid leukemia has improved steadily over the past 20 years.<sup>1–11</sup> Acute myeloid leukemia is a rare disease in childhood and it is difficult to accrue sufficient numbers for randomized trials. Yet the need for such trials is pressing since as survival improves it becomes more important to refine therapy and avoid late effects of treatment. One approach to this problem, adopted by the UK Medical Research Council Working Party, is to plan trials for both children and younger adults, another is to develop international studies.

## CHAPTER 11

### Induction therapy

Can modifications of induction therapy improve remission rates (now in excess of 85–90% in the best studies), improve event-free survival (EFS) and, if possible, minimize late toxicity, especially the cardiotoxicity associated with anthracyclines? The earlier Children's Cancer Group (CCG) trial reviewed here (Study 4), CCG-213, which was conducted in 1986–1989, compared classic induction therapy for acute myeloid leukemia (AML) comprising three consecutive doses of daunorubicin and a 7-day infusion of cytosine arabinoside (ARA-C) with a five-drug regimen (DCTER) containing reduced doses of anthracyclines and including other drugs, even dexamethasone – of questionable efficacy in AML. There was no significant difference in remission rate, which was of the order of 75%, or EFS, about 32% in both regimens.<sup>11</sup>

In the second CCG study, CCG-2891 (Study 2), the five-drug DCTER regimen was adopted but patients were randomized to receive the courses at conventional intervals or more intensively to ensure early blast

regression. Intensive induction resulted in a higher toxic death rate but less refractory disease and, importantly, a significantly better EFS than conventional induction.

The MRC AML-10 trial (Study 3) which included both children and adults, involved slightly higher doses of daunorubicin and more prolonged ARA-C than the CCG protocols and patients were randomized to receive either thioguanine or etoposide, as a third drug. This intensive treatment was designed to produce blast clearance in one course. The overall remission rate was 91%, with 5-year EFS of 49% with no differences in either arm. The AML-12 trial<sup>4</sup> was more intensive, produced a similar remission rate but had a 5-year EFS of 66%. It is likely that the improvement in outcome is more due to better supportive therapy and clinical management than improvements in chemotherapy. Induction in the most recent Berlin–Frankfurt–Munster (BFM) 93 study (Study 1) was also more intensive than the CCG protocols and achieved an 82% remission rate. Despite the authors' conclusions, there was no significant evidence that idarubicin was superior to daunorubicin in induction therapy.<sup>1</sup>

### Conclusion

There is no firm evidence that the addition of a third drug during induction of AML adds benefit to the combinations of an anthracycline and intensive ARA-C, but one is often added. The comparison of thioguanine and etoposide (Study 3) as third induction drugs confounded the myth that etoposide is of special benefit in leukemia with a monocytic component. Intensive induction therapy, although toxic, improves EFS (Study 2). There may be scope for further refinements of induction therapy in AML, for example the use of newer anthracyclines, but in

view of the high remission rates now achieved major improvements would seem unlikely and large numbers of patients would be needed to demonstrate a significant benefit.

## CHAPTER 12

### What next after induction?

The most controversial issue in the management of AML, and the one that lends itself least readily to randomized trials, is the role of allogeneic stem cell transplantation (allo-SCT) in first remission. It is probably true that for many years SCT from a histocompatible sibling donor was regarded as the “gold standard” in treatment of children with AML (Chapter 11, Study 4). Since most children do not have a histocompatible sibling donor, an alternative approach, derived from encouraging single arm unrandomized studies was the use of high dose therapy and rescue with autologous stem cells (ASCR).<sup>12</sup> The more conventional approach to treatment, illustrated by several studies reviewed here, is further intensive consolidation therapy.

Three similar trials in pediatric AML have compared high dose therapy and ASCR with conventional post-remission consolidation (Studies 1, 2 and 4). None found significant evidence of benefit for ASCR. In all three trials the relapse risk was in fact lower and the EFS superior in patients who received a histocompatible sibling donor allo-SCT.

AML-10 (Study 3) had a different design, in that after four courses of induction/intensification patients were randomized to receive high dose therapy and ASCR as a fifth consolidation course or to stop treatment. The full results of this trial comprising both children and adults showed that ASCR was associated with a lower relapse rate in all age groups.<sup>13</sup> However, survival in children was not improved by ASCR (Study 3), since children who relapsed after ASCR had a worse survival than those receiving four courses of chemotherapy.

It would seem reasonable to conclude from the available evidence that while there is no established place for high dose therapy and ASCR in pediatric AML there remains scope for additional intensification therapy. The BFM Study 93 (Chapter 11, Study 1) involved a randomization to receive high dose ARA-C and mitoxantrone (HAM) in higher risk patients

(defined by clinical and morphological criteria), either after induction or after 6 weeks of lower dose therapy. There was no difference in EFS between the patients treated with early or late HAM but comparison with historical controls showed an improvement.<sup>1,14</sup>

Recent improvements in EFS have been achieved in many patients without recourse to allo-SCT in first remission. While a minority of patients have a histocompatible sibling donor, allo-SCT from alternative stem cell sources has become more widely available and safer. However, in general allo-SCT is associated with a higher risk of treatment related death than chemotherapy and an increased risk of late effects of treatment, in particular in respect of growth and fertility. Trials involving allo-SCT are of necessity non-randomized and there are many inherent biases in assessment. One approach is to analyze by intention-to-treat on the basis of comparing outcome for patients with and without a sibling donor. This comparison in the pediatric AML-10 trial showed no significant improvement in EFS for patients with a donor (Study 3). By contrast, allo-SCT was superior to chemotherapy in recent American trials conducted by the Pediatric Oncology Group (Study 2) and the CCG (Study 4), and in the latter compliance for the allocated treatment was extremely high.

One recent development in AML, long fashionable in acute lymphoblastic leukemia (ALL), has been the identification of risk groups – a strategy where allo-SCT might be reserved in first remission to higher risk children as identified by clinical and morphological characteristics<sup>14</sup> or by cytogenetics.<sup>15</sup> It seems justifiable to exempt patients with a good chance of being cured from the risks of bone marrow transplantation (BMT), and whether BMT will improve outcome in the worst risk patients remains to be seen.

### Conclusion

Results of treatment have improved and for most patients this has been achieved by chemotherapy. Short-term consolidation therapy has proved as effective as high dose therapy and ASCR. The role of allo-SCT is probably evolving and the balance of risk/benefit between transplantation and chemotherapy has probably shifted towards chemotherapy in recent years.

## CHAPTER 13

### Maintenance therapy?

The combination of cytarabine, daunorubicin and 6-thioguanine, the so called DAT regimen was shown to be successful in inducing remission in patients in the majority of patients with AML.<sup>16</sup> As most patients then relapsed, taking a leaf out of the management of ALL, some trial groups instituted maintenance therapy with using doses lower than used during induction.<sup>17</sup> One randomized trial showed that maintenance treatment was clearly better than not receiving any post-remission therapy.<sup>18</sup> However subsequent studies showed that shorter more intense regimens or consolidation therapy, were also able to provide sustained remission and could supplant more prolonged courses.<sup>19–21</sup> Several studies, including Studies 1 and 2, have suggested that maintenance therapy does not appear to improve overall survival.<sup>7,18,22–24</sup> However, in BFM based protocols, prolonged maintenance seems to contribute to a higher cure rate that is not further improved even by a maximum intensity short-term treatment.<sup>25,26</sup> Our understanding is that post-remission therapy is required to eradicate residual disease. In some cases where this strategy is not successful, this may be overcome by transplantation.

Nevertheless, the key to post-remission therapy lies in the response of the leukemic cells to the therapy used. In such a setting clearly targeted therapy, specific for the cancerous cell has a higher chance of success. This is demonstrated in acute promyelocytic leukemia (APL). The majority of APL patients have blasts with a t(15;17) which results in a PML-RAR $\alpha$  fusion. The resultant blockade of the retinoic acid receptor activity can be overcome by pharmacological doses of all-trans-retinoic acid (ATRA). The use of ATRA decreases complications during induction.<sup>27</sup> Logically, ATRA could also be used as post-remission targeted therapy. The use of ATRA in maintenance therapy has been examined in a number of randomized trials,<sup>8,28,29</sup> including Studies 3 and 4. All studies show a benefit of administering ATRA either continuously or intermittently as maintenance therapy. However, continuous therapy is associated with increased toxicity.<sup>29</sup> Study 3 showed an advantage in administering low dose chemotherapy along with ATRA. In fact, the triple combination of ATRA, MTX and 6-MP resulted in a lower relapse rate. Thus, although maintenance therapy for AML

remains speculative, almost all groups have now incorporated ATRA based maintenance schedules for patients with APL.

## Conclusion

Other than in children with APL, the use of maintenance therapy in AML does not appear to improve outcome in therapeutic protocols other than those used by the BFM.

## References

- 1 Creutzig U, Zimmermann M, Ritter J, Reinhardt D, Hermann J, Henze G, Jurgens H, Kabisch H, Reiter A, Riehm H, Gadner H, Schellong G. Treatment strategies and long-term results in paediatric patients treated in four consecutive AML-BFM trials. *Leukemia* 2005;**19**(12):2030–42.
- 2 Dłuzniewska A, Balwierz W, Armata J, Balcerska A, Chybicka A, Kowalczyk J, Matysiak M, Ochocka M, Radwanska U, Rokicka-Milewska R, Sonta-Jakimczyk D, Wachowiak J, Wysocki M. Twenty years of Polish experience with three consecutive protocols for treatment of childhood acute myelogenous leukemia. *Leukemia* 2005;**19**(12): 2117–24.
- 3 Entz-Werle N, Suci S, van der Werff ten Bosch J, Vilmer E, Bertrand Y, Benoit Y, Marguerite G, Plouvier E, Boutard P, Vandercruys E, Ferster A, Lutz P, Uyttebroeck A, Hoyoux C, Thyss A, Riolland X, Norton L, Pages MP, Philippe N, Otten J, Behar C. Results of 58872 and 58921 trials in acute myeloblastic leukemia and relative value of chemotherapy vs allogeneic bone marrow transplantation in first complete remission: the EORTC Children Leukemia Group report. *Leukemia* 2005;**19**(12):2072–81.
- 4 Gibson BE, Wheatley K, Hann IM, Stevens RF, Webb D, Hills RK, De Graaf SS, Harrison CJ. Treatment strategy and long-term results in paediatric patients treated in consecutive UK AML trials. *Leukemia* 2005;**19**(12):2130–8.
- 5 Kardos G, Zwaan CM, Kaspers GJ, de-Graaf SS, de Bont ES, Postma A, Bokkerink JP, Weening RS, van der Does-van den Berg A, van Wering ER, Korbijn C, Hahlen K. Treatment strategy and results in children treated on three Dutch Childhood Oncology Group acute myeloid leukemia trials. *Leukemia* 2005;**19**(12):2063–71.
- 6 Lie SO, Abrahamsson J, Clausen N, Forestier E, Hasle H, Hovi L, Jonmundsson G, Mellander L, Siimes MA, Yssing M, Zeller B, Gustafsson G. Long-term results in children with AML: NOPHO-AML Study Group – report of three consecutive trials. *Leukemia* 2005;**19**(12):2090–100.
- 7 Perel Y, Auvrignon A, Leblanc T, Michel G, Reguerre Y, Vannier JP, Dalle JH, Gandemer V, Schmitt C, Mechinaud F, Lejars O, Piguët C, Couillaud G, Pautard B, Landman-Parker J, Thuret I, Aladjidi N, Baruchel A, Leverger G. Treatment of childhood acute myeloblastic leukemia: dose intensification improves outcome and maintenance therapy is of no



- benefit – multicenter studies of the French LAME (Leucemie Aigue Myeloblastique Enfant) Cooperative Group. *Leukemia* 2005;**19**(12):2082–9.
- 8 Pession A, Rondelli R, Basso G, Rizzari C, Testi AM, Fagioli F, De Stefano P, Locatelli F. Treatment and long-term results in children with acute myeloid leukaemia treated according to the AIEOP AML protocols. *Leukemia* 2005;**19**(12):2043–53.
  - 9 Ravindranath Y, Chang M, Steuber CP, Becton D, Dahl G, Civin C, Camitta B, Carroll A, Raimondi SC, Weinstein HJ. Pediatric Oncology Group (POG) studies of acute myeloid leukemia (AML): a review of four consecutive childhood AML trials conducted between 1981 and 2000. *Leukemia* 2005;**19**(12):2101–16.
  - 10 Ribeiro RC, Razzouk BI, Pounds S, Hijjiya N, Pui CH, Rubnitz JE. Successive clinical trials for childhood acute myeloid leukemia at St Jude Children's Research Hospital, from 1980 to 2000. *Leukemia* 2005;**19**(12):2125–9.
  - 11 Smith FO, Alonzo TA, Gerbing RB, Woods WG, Arcenci RJ. Long-term results of children with acute myeloid leukemia: a report of three consecutive Phase III trials by the Children's Cancer Group: CCG 251, CCG 213 and CCG 2891. *Leukemia* 2005;**19**(12):2054–62.
  - 12 Burnett AK, Tansey P, Watkins R, Alcorn M, Maharaj D, Singer CR, McKinnon S, McDonald GA, Robertson AG. Transplantation of unpurged autologous bone-marrow in acute myeloid leukaemia in first remission. *Lancet* 1984;**2**(8411):1068–70.
  - 13 Burnett AK, Goldstone AH, Stevens RM, Hann IM, Rees JK, Gray RG, Wheatley K. Randomised comparison of addition of autologous bone-marrow transplantation to intensive chemotherapy for acute myeloid leukaemia in first remission: results of MRC AML 10 trial. UK Medical Research Council Adult and Children's Leukaemia Working Parties. *Lancet* 1998;**351**(9104):700–8.
  - 14 Creutzig U, Ritter J, Schellong G. Identification of two risk groups in childhood acute myelogenous leukemia after therapy intensification in study AML-BFM-83 as compared with study AML-BFM-78. AML-BFM Study Group. *Blood* 1990;**75**(10):1932–40.
  - 15 Grimwade D, Walker H, Oliver F, Wheatley K, Harrison C, Harrison G, Rees J, Hann I, Stevens R, Burnett A, Goldstone A. The importance of diagnostic cytogenetics on outcome in AML: analysis of 1,612 patients entered into the MRC AML 10 trial. The Medical Research Council Adult and Children's Leukaemia Working Parties. *Blood* 1998;**92**(7):2322–33.
  - 16 Rees JK, Sandler RM, Challener J, Hayhoe FG. Treatment of acute myeloid leukaemia with a triple cytotoxic regime: DAT. *Br J Cancer* 1977;**36**(6):770–6.
  - 17 Spiers AS, Goldman JM, Catovsky D, Costello C, Galton DA, Pitcher CS. Prolonged remission maintenance in acute myeloid leukaemia. *Br Med J* 1977;**2**(6086):544–7.
  - 18 Cassileth PA, Lee SJ, Litzow MR, Miller KB, Stadtmauer EA, Tallman MS, Lazarus HM, Bennett JM, Paietta E, Dewald GW, Rowe JM. Intensified induction chemotherapy in adult acute myeloid leukemia followed by high-dose chemotherapy and autologous peripheral blood stem cell transplantation: an Eastern Cooperative Oncology Group trial (E4995). *Leuk Lymphoma* 2005;**46**(1):55–61.
  - 19 Oblon DJ, Weiner RS, Kramer BS, Ross W, Noyes WD, Boyett J, Kitchens CS. Intensive short-term chemotherapy for patients with acute myelogenous leukemia: long-term follow-up. *Cancer Treat Rep* 1985;**69**(12):1425–7.
  - 20 Link H, Frauer HM, Ostendorf P, Waller HD. Therapy for acute myeloid leukemia in 119 adults: a comparison of two treatment protocols. *Blut* 1985;**51**(1):49–56.
  - 21 Rees JK, Gray RG, Swirsky D, Hayhoe FG. Principal results of the Medical Research Council's 8th acute myeloid leukaemia trial. *Lancet* 1986;**2**(8518):1236–41.
  - 22 Palva IP, Almqvist A, Elonen E, Hanninen A, Jouppila J, Jarventie G, Koivunen E, Katka K, Lahtinen R, Oivanen T, et al. Value of maintenance therapy with chemotherapy or interferon during remission of acute myeloid leukaemia. *Eur J Haematol* 1991;**47**(3):229–33.
  - 23 Guinn BA, Bland EA, Lodi U, Liggins AP, Tobal K, Petters S, Wells JW, Banham AH, Mufti GJ. Humoral detection of leukaemia-associated antigens in presentation acute myeloid leukaemia. *Biochem Biophys Res Commun* 2005;**335**(4):1293–304.
  - 24 Miyawaki S, Sakamaki H, Ohtake S, Emi N, Yagasaki F, Mitani K, Matsuda S, Kishimoto Y, Miyazaki Y, Asou N, Matsushima T, Takahashi M, Ogawa Y, Honda S, Ohno R. A randomized, postremission comparison of four courses of standard-dose consolidation therapy without maintenance therapy versus three courses of standard-dose consolidation with maintenance therapy in adults with acute myeloid leukemia. *Cancer* 2005.
  - 25 Buchner T, Hiddemann W, Wormann B, Loffler H, Maschmeyer G, Hossfeld D, Ludwig WD, Nowrousian M, Aul C, Schaefer UW, et al. Longterm effects of prolonged maintenance and of very early intensification chemotherapy in AML: data from AMLCG. *Leukemia* 1992;**6**(Suppl 2):68–71.
  - 26 Buchner T, Hiddemann W, Wormann B, Loffler H, Ludwig WD, Schoch C, Haferlach T, Maschmeyer G, Staib P, Aul C, Heyll GA, Gruneisen A, Rasche H, Eimermacher JH, Balleisen L, Pielken HJ, Reis HE, Griesinger F, Reichle A, Sauerland MC, Heinecke A. Acute myeloid leukemia in adults: is postconsolidation maintenance therapy necessary? *Int J Hematol* 2000;**72**(3):285–9.
  - 27 Nabhan C, Rundhaugen LM, Riley MB, Rademaker A, Boehlke L, Jatoi M, Tallman MS. Phase II pilot trial of gemtuzumab ozogamicin (GO) as first line therapy in acute myeloid leukemia patients age 65 or older. *Leuk Res* 2005;**29**(1):53–7.
  - 28 de Labarthe A, Pautas C, Thomas X, de Botton S, Bordessoule D, Tilly H, de Revel T, Bastard C, Preudhomme C, Michallet M, Fenaux P, Bastie JN, Socie G, Cordonnier C, Dombret H. Allogeneic stem cell transplantation in second rather than first complete remission in selected patients with good-risk acute myeloid leukemia. *Bone Marrow Transplant* 2005;**35**(8):767–73.
  - 29 Tallman MS, Andersen JW, Schiffer CA, Appelbaum FR, Feusner JH, Ogden A, Shepherd L, Willman C, Bloomfield CD, Rowe JM, Wiernik PH. All-trans-retinoic acid in acute promyelocytic leukemia. *N Engl J Med* 1997;**337**(15):1021–8.

## CHAPTER 11

# Induction regimens in acute myeloid leukemia

## Studies

### Study 1

Crutzig U, Ritter J, Zimmermann M, Reinhardt D, Hermann J, Berthold F, Henze G, Jürgens H, Kabisch H, Havers W, Reiter A, Kluba U, Niggli F, Gadner H for the Acute Myeloid Leukaemia Berlin–Frankfurt–Munster Study Group. Improved treatment results in high risk paediatric acute myeloid leukaemia patients after intensification with high-dose cytarabine and mitoxantrone: results of study Acute Myeloid Leukaemia Berlin–Frankfurt–Munster 93. *J Clin Oncol* 2001;**19**: 2705–13.

### Study design

AML-BFM 93 was a prospective randomized multicenter study and enrolled patients from January 1993 until June 1998. Two randomizations were incorporated into the study – the first, which was performed at diagnosis and included all eligible patients, ended on 31 December 1997, while patient accrual for the second randomization (for high risk (HR) patients alone) ended 6 months later.

### Objectives

The aims of the study were:

- To compare the relative efficacy and toxicity of daunorubicin with Idarubicin in the induction chemotherapy regimen for children with AML.
- To improve the outcome of children with high risk AML with the use of high dose mitoxantrone (HAM) during the post-induction phase of therapy.

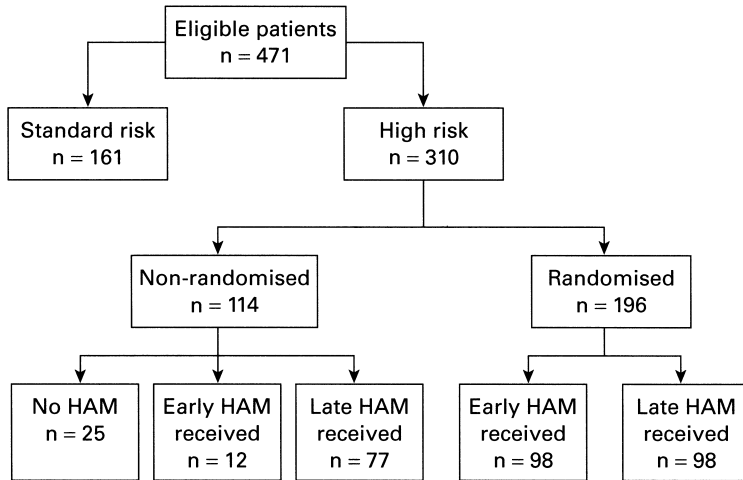
### Details of the study

Previously untreated children and adolescents between the ages of 0 and 17 years with newly diagnosed AML were entered onto the study. All patients who had secondary AML, granulocytic sarcoma, myelodysplastic syndrome or Down's syndrome were excluded from the trial.

Patients were stratified as standard or HR according to diagnostic morphology of blast cells and blast cell reduction in the bone marrow on day 15. The standard risk (SR) group included FAB M1 or M2 with Auer rods, FAB M3 regardless of bone marrow status on day 15 and FAB M4E0 with  $\geq 5\%$  blasts in the marrow on day 15. All other patients were categorized as HR. Additionally, SR patients who had  $>5\%$  blasts in the marrow on day 15 were redesignated as HR.

Randomizations were done with permuted blocks. All patients were randomized at diagnosis to an 8-day induction chemotherapy regimen with either ADE (ARA-C 100 mg/m<sup>2</sup> continuous intravenous (IV) infusion on days 1 and 2; daunorubicin 30 mg/m<sup>2</sup> as 30-minute IV infusion 12 hourly on days 3–5 and etoposide 150 mg/m<sup>2</sup> as a 2-hour infusion on days 6–8) or AIE (idarubicin 12 mg/m<sup>2</sup> as 30-minute IV infusion 24 hourly on days 3–5 with ARA-C and etoposide as in the ADE regimen).

High risk patients were randomized to either early HAM (high dose ARA-C 3 g/m<sup>2</sup> 12 hourly  $\times$  3 days and mitoxantrone 10 mg/m<sup>2</sup> on days 4–5 followed by consolidation therapy) or late HAM (consolidation therapy



**Figure 11.1** Flow of patients entered onto study AML-BFM 93. © American Society of Clinical Oncology (full reference on p. 227).

followed by HAM). SR patients received consolidation therapy without HAM.

Consolidation consisted of 6 weeks of treatment with thioguanine 60 mg/m<sup>2</sup> PO days 1–43; prednisolone 40 mg/m<sup>2</sup> PO days 1–28; vincristine 1.5 mg/m<sup>2</sup> IV days 1, 8, 15 and 22; doxorubicin 30 mg/m<sup>2</sup> IV infusion days 1, 8, 15 and 22; ARA-C 75 mg/m<sup>2</sup> IV days 3–6, 10–13, 17–20, 24–27, 31–34 and 38–41; cyclophosphamide 500 mg/m<sup>2</sup> IV days 29 and 43; and intrathecal ARA-C on days 1, 15, 29 and 43.

All patients received an intensification block of high dose ARA-C and etoposide (ARA-C 3 g/m<sup>2</sup> 12 hourly × 3 days and etoposide 125 mg/m<sup>2</sup> days 2–5). This was followed by 18 Gy cranial irradiation (in children >3 years) and maintenance therapy that consisted of daily thioguanine 40 mg/m<sup>2</sup> PO and ARA-C 40 mg/m<sup>2</sup> SC × 4 day monthly for a total of 18 months.

Allogeneic bone marrow transplant was recommended for high risk children in CR1 if a matched sibling donor was available.

Outcome measures were 5-year overall survival (OS), event-free survival (EFS) and disease-free survival (DFS).

Analysis of all data was performed according to the intention-to-treat principle.

## Outcome

Of the 471 eligible patients enrolled on the AML-BFM 93 trial, 161 patients were categorized as SR and 310

patients as HR. Figure 11.1 shows the numbers of patients according to treatment and randomization.

Of the 114 HR patients not randomized, 25 did not receive HAM (18 died of complications, 5 experienced severe toxicity and 2 were assigned to the wrong risk group), 12 were allocated to early HAM and 77 patients to late HAM. Allogeneic bone marrow transplantation was performed in 14 patients, each in the early and late HAM groups.

Complete remission (CR) was achieved in 387 (82%) of 471 patients.

Patients who underwent induction with idarubicin had significantly better blast cell reductions in the bone marrow on day 15–17% patients had >5% blasts compared to 31% patients on the daunorubicin arm ( $p = 0.1$ ,  $\chi^2$  test). However, 5-year DFS and EFS were similar in both groups of patients. The infection rate was higher in the idarubicin arm ( $p$  trend = 0.016), as was the duration of bone marrow aplasia – neutrophil recovery  $>0.5 \times 10^9/l$ , which was 2 days longer.

Five-year OS, EFS and DFS rates ( $\pm$ SE) were 74%  $\pm$  4%, 65%  $\pm$  4% and 73%  $\pm$  4%, respectively in the SR group of patients, while in the HR group it was 52%  $\pm$  3%, 44%  $\pm$  3%, and 56%  $\pm$  3%, respectively.

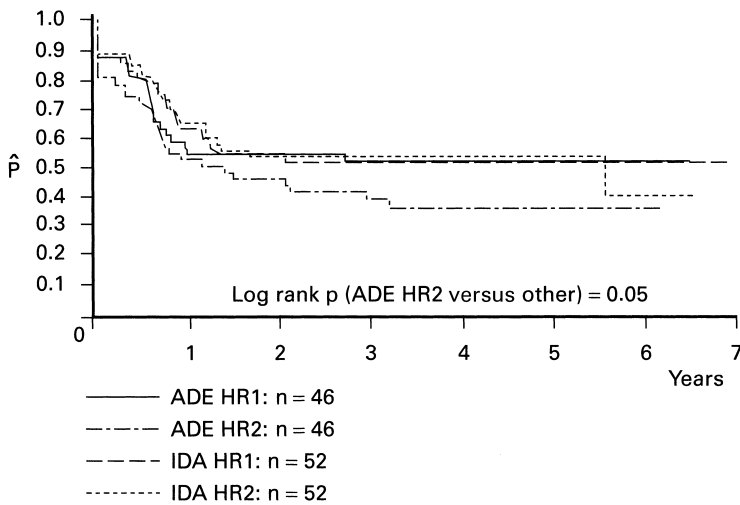
Probability of EFS (pEFS) was marginally higher among patients treated with daunorubicin and early HAM compared with patients who received daunorubicin and late HAM, whereas results with idarubicin were similar in both the early and late HAM groups of patients (Table 11.1, Figure 11.2).

**Table 11.1** Results of study AML-BFM 93, by HAM group and induction treatment.

HAM	Induction	< 5% blasts on day 15			Complete remission		pEFS ± SE (%)
		Total number of patients	Number of patients <sup>a</sup>	%	Number of Patients	%	
Early	Daunorubicin	46	10/21	48	40	87	51.9 ± 7.4
	Idarubicin	52	21/29	72	46	89	51.3 ± 7.0
Late	Daunorubicin	46	14/28	50	37	80	35.6 ± 7.3 <sup>b</sup>
	Idarubicin	52	18/28	64	46	89	53.6 ± 7.0

<sup>a</sup>Number of patients with <5% blasts/total number of patients with data available.

<sup>b</sup>Late HAM after daunorubicin induction versus other groups: p = 0.05, log-rank test.



**Figure 11.2** Estimated pEFS among high risk patients in study AML-BFM 93. For details of treatments, see text. HR1 = early HAM; HR2 = late HAM. © American Society of Clinical Oncology (full reference on p. 227).

**Conclusion**

It was concluded that though idarubicin induction resulted in a significantly greater blast cell reduction in the bone marrow on day 15, this did not translate into improved 5-year EFS or DFS in children with AML. HR

patients who received daunorubicin induction benefited with early HAM intensification. However, idarubicin induction resulted in higher infection rates and a longer duration of neutropenia secondary to bone marrow depression.

**Study 2**

Woods WG, Koblinsky N, Buckley JD, Lee JW, Sanders J, Neudorf S, Gold S, Barnard DR, DeSwarte J, Dusenbery K, Kalousek D, Arthur DC, and Lange BJ. Timed

sequential induction therapy improves post-remission outcome in acute myeloid leukaemia: a report of the Children’s Cancer Study Group. *Blood* 1996;**87**: 4979–989.

## Study design

This CCG study (CCG-2891) was a prospective randomized multicenter trial that ran from October 1989 to May 1993.

### Objectives

The study aimed:

- To determine whether intensive induction therapy improves long-term outcome of children with acute myeloid leukemia (AML).

## Details of the study

Children and adolescents younger than 21 years of age with AML (FAB M0–M7), acute undifferentiated AML or bi-phenotypic leukemia with myeloid differentiation, myelodysplastic syndrome (MDS) or granulocytic sarcoma were eligible for the study. From April 1992, children with AML M3 were registered on the intergroup acute promyelocytic leukemia (APL) study (CCG-2911). Patients with known Fanconi's anemia or Philadelphia positive chronic myeloid leukemia in chronic phase were excluded from the study. However, for analysis of results, patients with the following conditions were excluded: Down's syndrome (n = 55); *de novo* MDS (n = 19); granulocytic sarcoma without bone marrow involvement (n = 14); secondary AML (n = 9).

Results were analyzed on the principle of intention to treat. Accrual goals were set before initiation of the study, with the power of 0.88 to detect 10% difference in disease-free survival (DFS) at 2 years between the two induction arms.

Details of the randomization method are not specified in the report.

Patients were randomized at diagnosis to one of two induction regimens – standard and intensive – in which identical drugs and doses were used (Figure 11.3). Initial induction chemotherapy consisted of a five-drug regimen administered over 4 days – dexamethasone, 6-thioguanine, cytosine arabinoside (ARA-C), daunorubicin and etoposide (DCTER). Daunorubicin, etoposide and ARA-c were administered as a continuous infusion for 96 hours. Patients randomized to the intensive arm received a second cycle of DCTER chemotherapy 6 days after completion of Cycle 1 irrespective of bone marrow or hematological status. Patients randomized to the standard arm underwent bone marrow evaluation on day 14 and proceeded to

Cycle 2 (identical to Cycle 1) immediately if they had residual leukemia (>40% blasts in the bone marrow). However, if leukemic blast clearance was satisfactory or if the marrow was hypoplastic indicating significant clearance of blasts, Cycle 2 was withheld until blood counts recovered or there was clear evidence of disease progression. Patients who showed no response after two cycles were considered protocol failures and were removed from the study. Standard timing induction therapy was closed in May 1993 and GCSF (granulocyte colony stimulating factor) was introduced for all patients thereafter, during the induction phase. The overall time to administer four induction cycles was similar in the two arms – 99 days for the intensive arm versus 105 days for the standard arm.

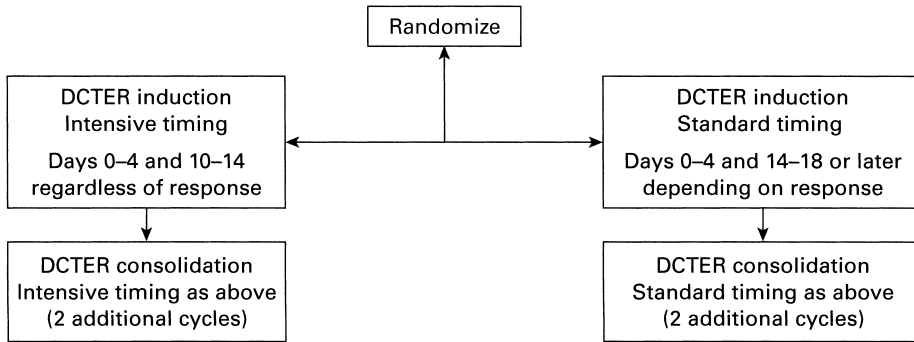
The second randomization was after four cycles of induction chemotherapy. Patients who did not have an HLA identical sibling donor were randomized to either autologous bone marrow transplantation (ABMT) or intensive post-remission chemotherapy. ABMT patients received a preparatory regimen of 4 days of oral busulphan and 4 days of intravenous cyclophosphamide (200 mg/kg total dose) and had 4-hydroxycyclophosphamide *ex vivo* purged marrow infused after 1 day's rest. Patients randomized to post-remission chemotherapy received four courses of three different chemotherapy regimens, each lasting for 4–6 weeks, (as shown in Figure 11.3). All patients who had HLA identical family donors were allocated to allogeneic BMT with an identical preparatory regimen to ABMT (see Chapter 12, Study 4).

CNS prophylaxis consisted of four doses of intrathecal cytosine arabinoside (IT ARA-C) administered at the start of each DCTER cycle. Patients with CNS leukemia had six additional doses of IT ARA-C twice a week.

Main outcome measures were disease free survival (DFS), event-free survival (EFS) and overall survival (OS).

## Outcome

A total of 589 eligible patients were randomized to either the standard induction arm (n = 294) or to the intensive induction arm (n = 295). Compliance to induction randomization was greater than 98%. Thirty-one patients withdrew prior to completion of induction therapy. Of the remaining 558 evaluable

**Day 0 through 4: DCTER induction**

Dexamethasone 6 mg/m<sup>2</sup>/day (0.2 mg/m<sup>2</sup>/kg/day) thrice daily  
 ARA-C 200 mg/m<sup>2</sup>/day (6.7 mg/kg/day) continuous infusion  
 Thioguanine 100 mg/m<sup>2</sup>/day (3.3 mg/kg/day) twice daily  
 Etoposide 100 mg/m<sup>2</sup>/day (3.3 mg/kg/day) continuous infusion  
 Rubidomycin (daunorubicin) 20 mg/m<sup>2</sup>/day (0.67 mg/kg/day) continuous infusion  
 ARA-C intrathecal (age-based doses)

**Post-remission therapy**

- 1 Patients randomized to conventional chemotherapy
  - (A) Course 1: Days 0 through 2 ARA-C, 3 g/m<sup>2</sup>/dose (100 mg/kg) IV over 3 hours every 12 hours × 4 doses. L-asparaginase 6000 IU/m<sup>2</sup> (200 IU/kg) IM, hour 42. Days 7 through 9 ARA-C and L-asparaginase repeated exactly as administered days 0 through 2.
  - (B) Courses 2 and 3: Two 28-day cycles of 75 mg/m<sup>2</sup> 6-thioguanine (2.5 mg/kg) PO daily, days 0 through 27; 1.5 mg/m<sup>2</sup> vincristine (0.05 mg/kg) IV, day 0; 75 mg/m<sup>2</sup> ARA-C (2.5 mg/kg) IV every day × 4, days 0 through 3; 75 mg/m<sup>2</sup> cyclophosphamide (2.5 mg/kg) IV every day × 4, days 0 through 3; 100 mg/m<sup>2</sup> 5-azacytidine (3.3 mg/kg) IV every day × 4, days 0 through 3.
  - (C) Course 4: 25 mg/m<sup>2</sup>/dose ARA-C (0.83 mg/kg) SC or IV every 6 hours × 5 days, days 0 through 4; 30 mg/m<sup>2</sup> daunorubicin (1 mg/kg) IV day 0; 150 mg/m<sup>2</sup> etoposide (5 mg/kg) IV/dose × 2, days 0 and 3; 50 mg/m<sup>2</sup>/dose 6-thioguanine (1.67 mg/kg) orally every 12 hours × 5 days, days 0 through 4; 2 mg/m<sup>2</sup>/dose dexamethasone (0.067 mg/kg) orally every 8 hours × 4 days, days 0 through 3.
- 2 Patients allocated to allogeneic or randomized to ABMT. Pre-BMT preparative regimen:
  - (A) Busulfan 1 mg/kg/dose, administered orally every 6 hours × 16 doses, days -9 to -6.
  - (B) Cyclophosphamide 50 mg/kg/day IV over 1 hour daily × 4 days, days -5 to -1.

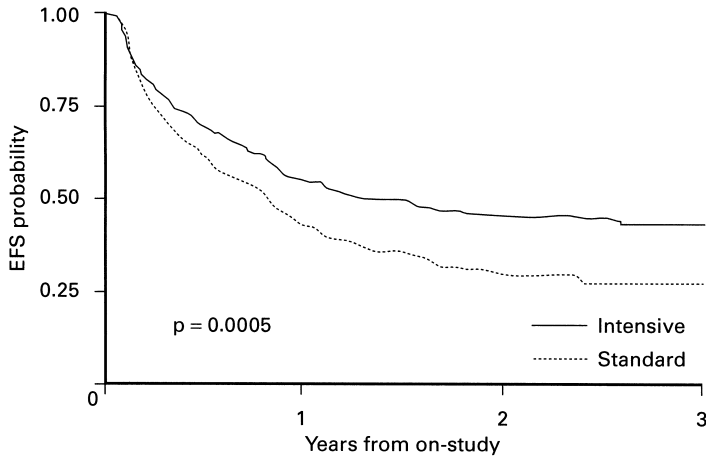
Doses in parentheses were used for children less than 3 years of age. If a leukemic response was documented, all patients received DCTER Cycles 3 and 4 in an intensive or standard fashion, based on initial randomisation, after marrow recovery.

**Figure 11.3** Details of therapy for study CCG-2891. Reproduced with permission of the American Society of Hematology (full reference on p. 229).

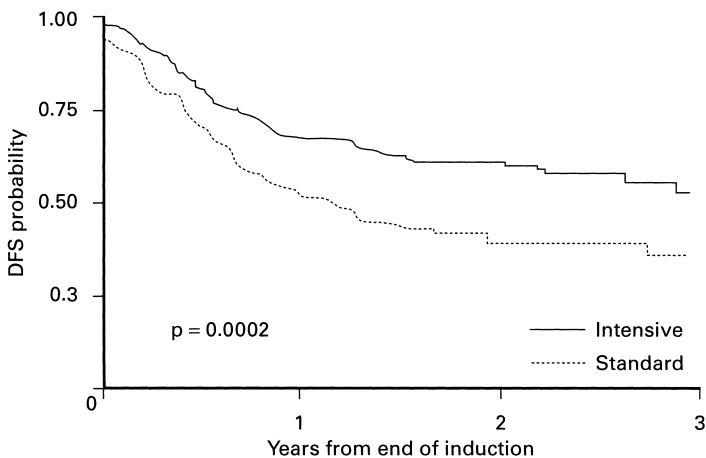
patients, 407 successfully completed four courses of intensive chemotherapy and were eligible for allocation to allogeneic BMT or randomization to ABMT or intensive chemotherapy. Seventy-nine patients refused post-remission randomization while data were not available in two patients; 105 patients were allocated to allogeneic BMT, 107 were randomized to ABMT and 114 patients to intensive chemotherapy. There were no differences between the two groups of patients based on white blood cell counts at diagnosis, FAB subtypes,

on the presence of various cytogenetic abnormalities or in the rate of deaths during the first 10 days of the study.

Four hundred and twenty-six patients achieved complete remission (CR) after two courses of DCTER therapy. For standard induction (n = 294), 195 (70%) patients achieved CR, 71 (26%) failed therapy and 11 (4%) patients died due to chemotherapy toxicity; 17 patients withdrew from the study. For intensive induction (n = 295), 212 (75%) patients achieved CR, 38 (14%) had refractory disease while 31 (11%)



**Figure 11.4** EFS from time of study entry for patients with AML, comparing patients randomized to intensive induction timing versus standard induction timing on CCG-2891. Reproduced with permission of the American Society of Hematology (full reference on p. 229).



**Figure 11.5** DFS from the end of induction for patients with AML enrolled on CCG-2891 and achieving remission, comparing intensively timed induction with standard timed induction therapy. Reproduced with permission of the American Society of Hematology (full reference on p. 229).

patients died due to toxicity; 14 patients withdrew after randomization. Figure 11.4 shows the 3-year EFS was  $42\% \pm 7\%$  for patients in the intensive arm compared to  $27\% \pm 7\%$  for the standard arm patients ( $p = 0.0005$ ) while the 3-year OS for the intensive and standard arm patients was  $51\% \pm 7\%$  and  $39\% \pm 7\%$ , respectively ( $p = 0.07$ ). Comparing the two induction arms, the failure rate was significantly higher in the standard arm ( $p = 0.0003$ ).

Post-remission outcome was as follows. The 3-year DFS (median follow-up 28 months) from the end of

induction for the intensive arm ( $n = 212$ ) patients was  $55\% \pm 8\%$  versus  $37\% \pm 8\%$  (Figure 11.5) for the standard arm ( $n = 195$ ) patients ( $p = 0.0002$ ), and actuarial survival at 3 years was  $52\% \pm 6\%$  compared to  $42\% \pm 6\%$  and at 5 years  $49\% \pm 6\%$  versus  $38\% \pm 6\%$  ( $p = 0.04$ ) for the intensive and standard arm patients, respectively.

In standard induction patients who received a second cycle of chemotherapy within 18 days of Cycle 1 (i.e. those with significant residual leukemia), 3-year EFS was non-significantly better ( $30\%$  versus  $26\%$ ;  $p = 0.51$ ).

## Toxicity

Patients receiving intensive induction had a significantly higher degree of myelosuppression than those who received standard induction therapy (43% versus 24%;  $p < 0.00001$ ). Intensive arm patients also had increased pulmonary, renal and hepatic toxicity. Death from chemotherapy toxicity was significantly higher in the intensive arm ( $p = 0.002$ ).

## Conclusion

It was concluded that intensively timed induction therapy markedly improved DFS, EFS and OS in children with AML, despite significantly higher toxic deaths.

## Study 3

Hann IM, Stevens RF, Goldstone AH, Rees JKH, Wheatley K, Gray RG, Burnett AK on behalf of the Adult and Childhood Leukaemia Working Party of the Medical Research Council. Randomised comparison of DAT versus ADE as induction chemotherapy in children and younger adults with acute myeloid leukaemia. Results of the Medical Research Council's 10th AML Trial (MRC AML 10). *Blood* 1997;**89**: 2311–18.

## Study design

The MRC AML-10 trial, which ran from May 1988 to April 1995, was a prospective multicenter randomized study, which involved 41 centers in the United Kingdom, Republic of Ireland and New Zealand.

## Objectives

The study compared the relative efficacy and toxicity of thioguanine with etoposide in the induction chemotherapy regimen in children with acute myeloid leukemia (AML).

## Details of the study

All patients below 56 years of age were eligible to be enrolled on the study. In addition to patients who had *de novo* AML, those with secondary AML or with myelodysplastic syndrome (refractory anemia with excess of blasts) were also eligible for entry.

There were two randomizations and the details of chemotherapy treatment and randomizations are shown in Figure 11.6. The first randomization was between two induction regimens – daunorubicin, ARA-C and

thioguanine (DAT) and daunorubicin, ARA-C and etoposide (ADE). The second was between autologous BMT and no further treatment. Children with an identical HLA sibling donor were allocated to allogeneic BMT. In addition, triple intrathecal therapy with methotrexate, cytarabine and hydrocortisone was given as part of each course. Children aged over 2 years who had CNS disease at presentation and not receiving BMT had craniospinal radiotherapy after completion of chemotherapy.

Patients receiving BMT had a preparatory regimen of cyclophosphamide (120 mg/kg total dose over 2 days) and fractionated total body irradiation. For children aged under 2 years, the conditioning treatment was with busulphan (16 mg/kg total dose over 4 days) and cyclophosphamide (200 mg/kg total dose over 4 days).

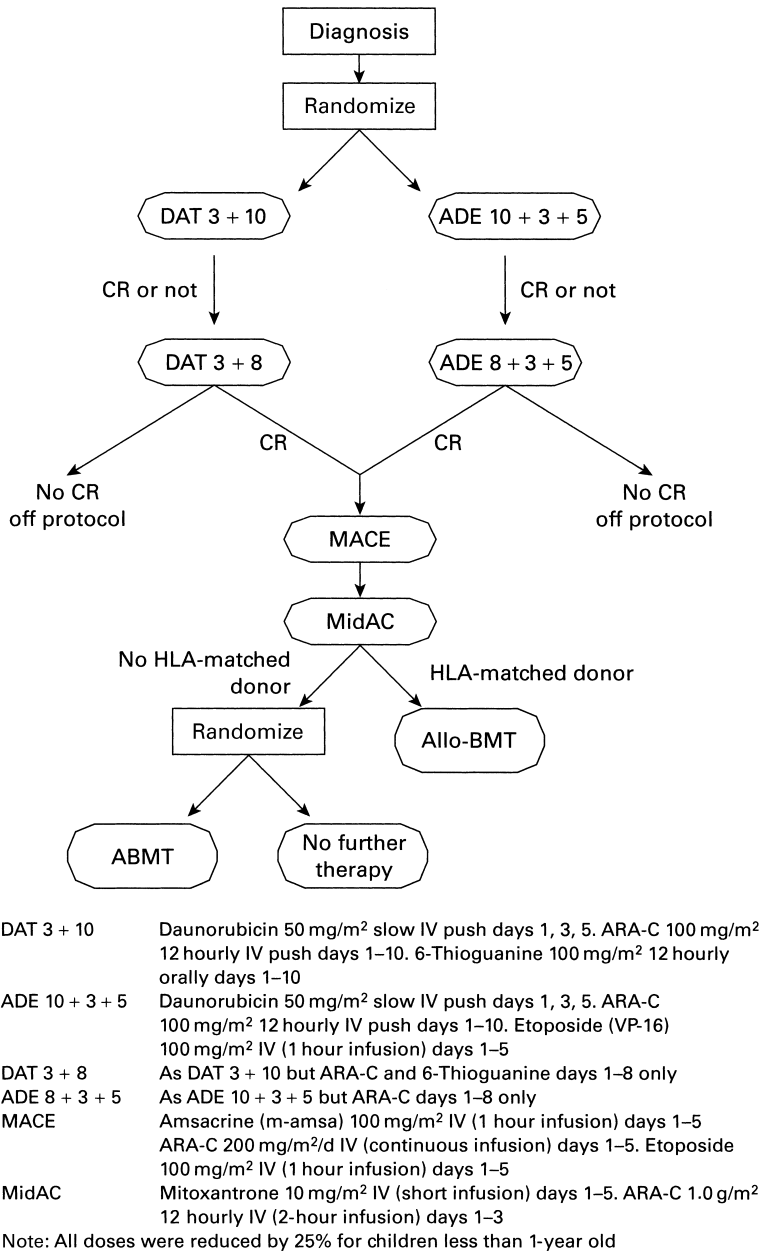
Outcome measures were complete remission (CR) rate and overall survival (OS).

## Outcome

The analysis in this report deals with the outcome in children alone ( $\leq 14$  years of age) and all analyses were by allocated treatment. Of 286 eligible patients below the age of 15 years, 143 each were randomized to DAT and ADE induction regimens, respectively (Table 11.2). There were no significant differences in the distribution of patients by age, gender, secondary AML, diagnostic white blood cell (WBC) count, FAB subtype, clonal cytogenetic abnormalities or performance status between the two treatment groups; 7% of children had CNS disease at presentation. Compliance with allocated treatment was 98% in both arms.

CR was achieved by 91% of patients. There was no significant difference in the CR rate between the DAT arm (89%) and the ADE arm (93%) nor was there any





**Figure 11.6** Protocol flow chart for study AML-10. Reproduced with permission of the American Society of Hematology (full reference on p. 233).

difference in the number of courses required to achieve CR. Five per cent of the patients had resistant disease with no significant difference between the DAT (6%) and ADE (3%) arms (Table 11.3).

OS (Table 11.3) from entry for patients in the two groups was also similar – DAT (60%) versus ADE (53%). Analysis of survival by FAB subtype showed no differences between thioguanine and etoposide in any subset.

**Table 11.2** Presentation features of patients in MRC AML-10.

Parameter	Value	Number of patients		
		DAT	ADE	% of patients <sup>a</sup>
Age	0–1	27	25	3
	2–14	116	118	13
	15–24	131	128	14
	>25	655	661	70
Sex	Male	475	471	51
	Female	454	457	49
Type of AML	<i>De novo</i>	863	859	93
	Secondary	66	69	7
<i>White blood cell count</i> (× 10 <sup>9</sup> /l)	0–9	417	412	45
	10–99	366	385	40
	100–199	4	72	8
	200+	31	38	4
	Unknown	31	21	3
FAB type	M0	16	12	2
	M1	136	172	17
	M2	254	253	27
	M3	143	130	15
	M4	184	184	20
	M5	79	81	9
	M6	28	24	3
	M7	24	18	2
	RAEB-t	13	17	2
	Bilineage	2	0	<1
	All	2	6	<1
	Unknown	48	31	4
	Cytogenetic group	Favorable	156	165
Intermediate		466	488	51
Adverse		53	56	6
Unknown		232	241	25

<sup>a</sup> Percentages may not add to 100 because of rounding.

**Table 11.3** Remission outcome in MRC AML-10 by DAT versus ADE (% of patients).

	CR			Induction death			Resistant disease			Survival at 5 years (%)	
	DAT	ADE	Total	DAT	ADE	Total	DAT	ADE	Total	DAT	ADE
All patients	81	83	82	8	9	9	11	9	10	60	53
Age											
0–14	89	93	91	6	3	5	6	3	5	47	46
15–24	83	88	85	9	5	7	8	7	7	52	46
25–34	81	90	85	9	5	7	10	5	7	33	33
35–44	81	77	79	7	11	9	12	13	12	26	34
45+	75	76	76	11	13	12	14	11	13	41	41

Percentages may not add to 100 because of rounding.

## Toxicity

The overall induction death rate was 5% with no statistical difference between the DAT (6%) and ADE (3%) arms. Hematological toxicity (recovery of neutrophils and platelets) was higher after DAT compared to ADE. In contrast, non-hematological toxicity was more pronounced after ADE (nausea, mucositis, alopecia, etc.).

## Conclusion

It was concluded that the standard DAT induction regimen was no less effective than the etoposide containing regimen (ADE) in the treatment of children with AML. The regimens were equivalent with regard to toxicity and efficacy and could be used interchangeably.

## Study 4

Wells RJ, Woods WG, Buckley JD, Odam LF, Benjamin D, Bernstein I, Betcher D, Feig S, Kim T, Ruymann F, Smithson W, Srivatsava A, Tannous R, Buckley CM, Whitt JK, Wolff L, Lampkin BC. Treatment of newly diagnosed children and adolescents with acute myeloid leukaemia: a Children's Cancer Group study. *J Clin Oncol* 1994;12:2367–77.

## Study design

This Children's Cancer Group Study (CCG-213) was a randomized prospective multicenter study that ran from January 1986 to February 1989.

## Objectives

The study addressed the following questions:

- Whether the addition of other chemotherapeutic agents to the standard regimen of cytosine arabinoside (ARA-C) and daunorubicin (DNR) improved remission rate and clinical outcome in children with acute myeloid leukemia (AML).
- Whether allogeneic bone marrow transplantation (Allo BMT) in first complete remission (CR) improves disease-free survival (DFS) and overall survival (OS) when compared with post-remission consolidation chemotherapy.
- Whether there is a place for "maintenance chemotherapy" in the treatment of childhood AML.

This review focuses on the use of additional drugs in the treatment of childhood AML. The analysis of the results of consolidation therapy (BMT versus chemotherapy) and maintenance therapy are not within the remit of this review.

## Details of the study

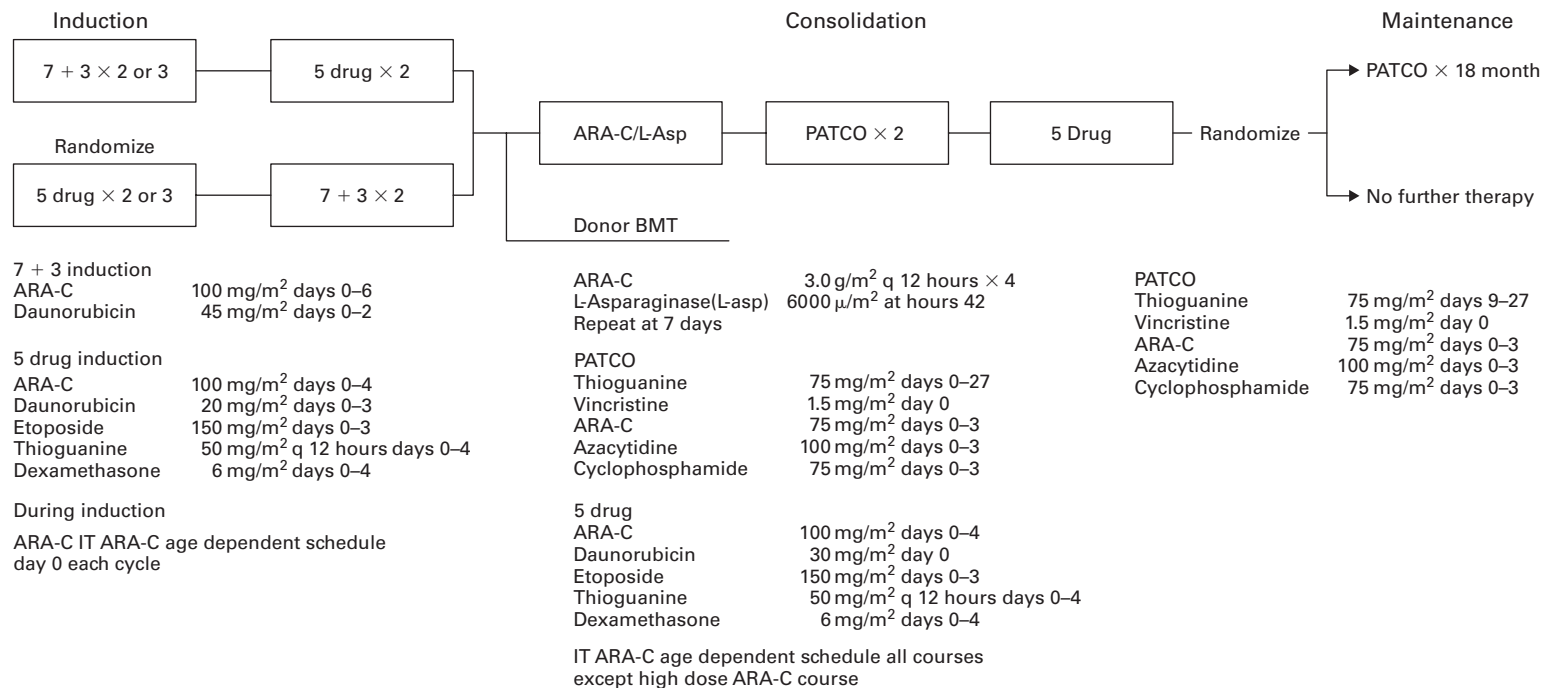
All patients below 22 years of age with a diagnosis of AML were eligible to be enrolled on the study. Infants less than 2 years of age with acute monoblastic leukemia were excluded as they were treated on a different chemotherapy regimen.

No details of the randomization methodology are given in the report.

Figure 11.7 shows the treatment schema of CCG-213. All patients were randomized at diagnosis to one of two induction regimens. For Regimen 1, the first cycle consisted of 7 days of continuous infusion of (ARA-C) and bolus doses of daunorubicin (DNR) on the first 3 days of therapy. The second cycle was shortened to 5 days of ARA-C and 2 days of DNR if reassessment bone marrow showed <5% blasts after the first cycle otherwise the second and or the third cycles were identical to Cycle 1. Regimen 2 consisted of ARA-C, DNR, etoposide (VP-16), dexamethasone (DEX) and thioguanine (TG). Depending on the response to therapy, two or three cycles were given. Patients initially randomized to Regimen 1 (7 + 3) crossed over to receive the five-drug regimen either after two cycles if in remission (blasts in marrow <5%) or after three cycles irrespective of the marrow status and vice versa.

CNS prophylaxis consisted of IT ARA-C administered on the first day of each induction cycle and throughout the consolidation phase (except during high dose ARA-C therapy) for those not transplanted. Patients who had CNS disease at diagnosis received weekly IT ARA-C during induction and monthly during consolidation.

After induction, patients who had a HLA-matched donors were assigned to BMT after one course of



**Figure 11.7** Scheme of treatment for study CCG-213. ARA-C: cytosine arabinoside; L-asp: asparaginase; IT: intrathecal. © American Society of Clinical Oncology (full reference on p. 236).

induction if in CR (two or three cycles) or after two courses (five cycles) if marrow had <16% blasts. BMT conditioning regimen consisted of fractionated total body irradiation and cyclophosphamide. Patients not assigned to BMT received post-induction consolidation as shown in Figure 11.7. Following consolidation, patients were randomized either to receive maintenance therapy or stop treatment.

Outcome measures were OS and event-free survival (EFS).

## Outcome

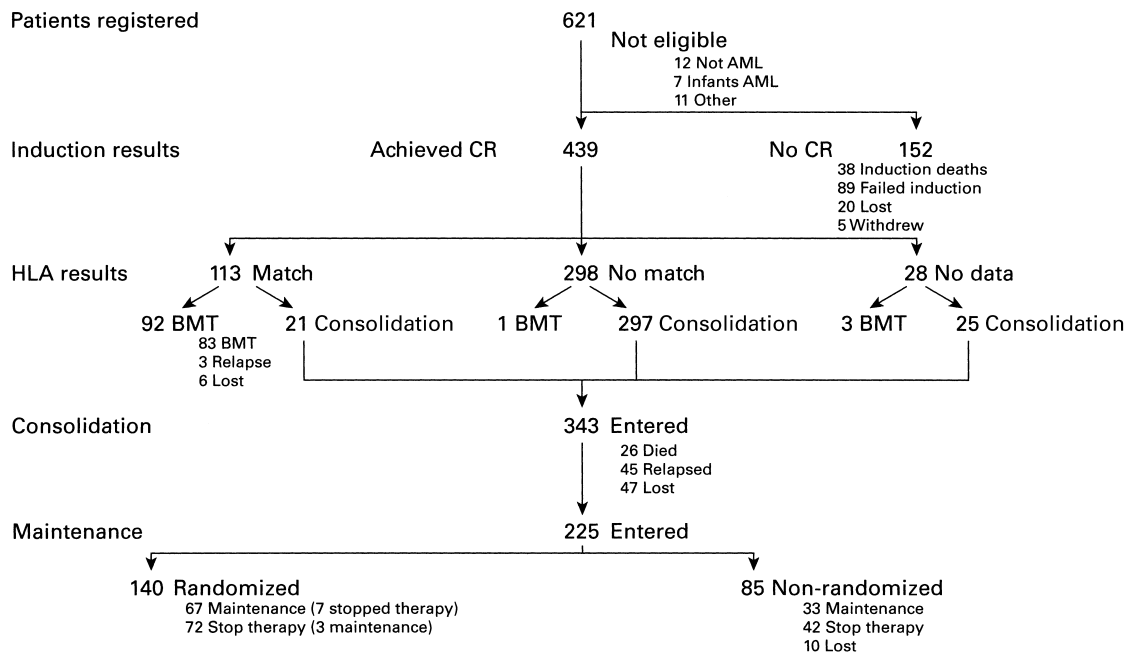
Figure 11.8 shows the number of eligible patients enrolled and who progressed or failed to progress through the various phases of therapy on the CCG-213 study. Of the 591 patients who were eligible for induction randomization, 6 were non-randomly allocated to an induction arm and were excluded from analysis of induction outcome.

Both regimens achieved similar rates of remission success: Regimen 1 (7 + 3; n = 290) 79% (95% CI 74–84) versus Regimen 2 (five drug; n = 295) 76% (95% CI 71–81), with no significant statistical difference.

After course one (two or three cycles of Regimens 1 or 2) more patients who received Regimen 1 (7 + 3) achieved CR (76%; 95% CI 71–81) compared to 67% (95% CI 60%–72%) for Regimen 2 (five drug) patients ( $p < 0.02$ ). Early response correlated to improved survival outcome irrespective of treatment regimen as 84% (95% CI 80–88) of patients who had <16% blasts on day 14 marrow achieved CR. There was no difference in OS or EFS in patients who achieved CR after the first course of induction compared with patients who achieved CR after two courses of therapy.

Five-year OS for Regimens 1 and 2 was 41% (95% CI 35–47) and 37% (95% CI 31–43) ( $p = 0.16$ ) and 5-year EFS was 32% (95% CI 26–38) and 31% (95% CI 26–36), respectively.

The projected 5-year OS from diagnosis was 39% (95% CI 35–43) and the 5-year EFS was 31% (95% CI



**Figure 11.8** CCG-213: patients entering the phases of therapy (induction, BMT, consolidation and maintenance) with explanation for failure to progress to the next phase. © American Society of Clinical Oncology (full reference on p. 233).

27–35) while the 5-year OS and EFS from the end of induction for all patients irrespective of the post-induction therapy were 47% (95% CI 42–52) and 40% (95% CI 35–45), respectively.

### **Toxicity**

Regimen 1 (7+3) patients had a higher degree of bone marrow aplasia and there were more deaths in this arm (25/290 versus 13/295;  $p = 0.06$ ).

### **Conclusion**

It was concluded that the addition of other chemotherapeutic agents to the standard induction regimen of ARA-C and daunorubicin did not improve remission rate, OS or EFS in children and adolescents with AML and early response to induction irrespective of the induction regimen, correlated with improved CR rates and improved survival.

## CHAPTER 12

# Role of autologous BMT in children with acute myeloid leukemia in first remission

## Studies

### Study 1

Amadori S, Testi AM, Aricò M, Comelli A, Giuliano M, Madan E, Masera G, Randelli R, ZanESCO L, and Mandelli F, for the Associazione Italiana Ematologia ed Oncologia Pediatrica Cooperative Group. Prospective comparative study of bone marrow transplantation and post remission chemotherapy for childhood acute myelogenous leukaemia. *J Clin Oncol* 1993;11:1046–54.

### Study design

This was a prospective randomized multicenter trial of the AIEOP Cooperative Group conducted between March 1987 and March 1990.

### Objectives

The study aimed:

- To define the role of allogeneic (Allo-BMT) and autologous bone marrow transplantation (ABMT) in first remission in children with acute myeloid leukemia.

### Details of the study

Children below 15 years of age with previously untreated acute myeloid leukemia (AML) were eligible for the study. Children with Down's syndrome, secondary AML or AML developing on a background of myelodysplasia were excluded.

Induction therapy consisted of 7 days of continuous infusion of cytosine arabinoside (ARA-C) (200 mg/m<sup>2</sup>/

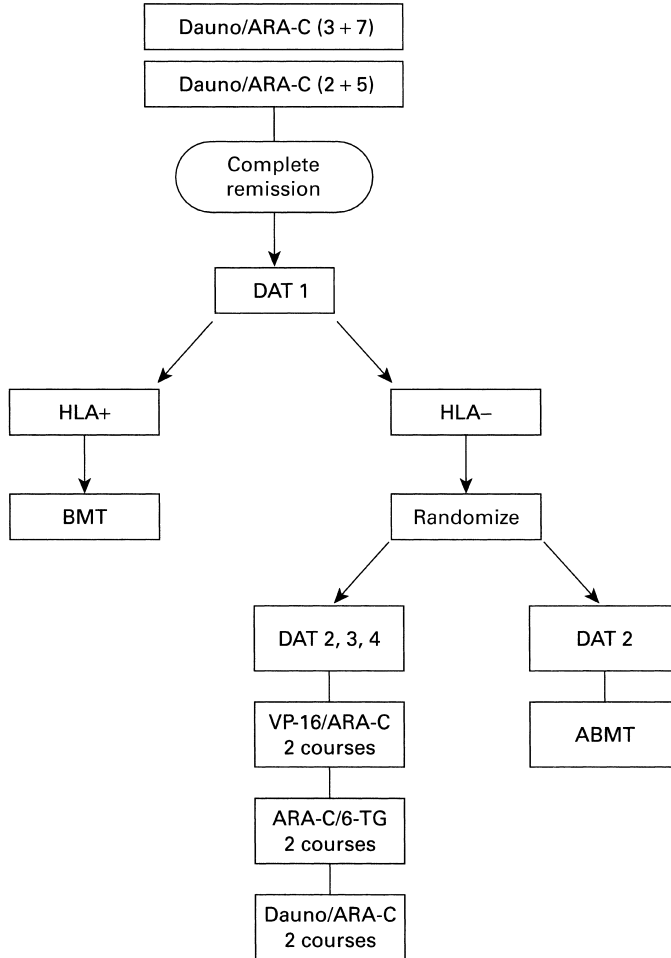
day; days 1–7) and 3 days of rapid infusion of daunorubicin (45 mg/m<sup>2</sup>/day; days 1–3). If bone marrow showed residual leukemia on day 21, a second course of daunorubicin (45 mg/m<sup>2</sup>/day × 2 days) and ARA-C (200 mg/m<sup>2</sup>/day × 5 days) was administered immediately, otherwise it was delayed until recovery of peripheral blood counts. Patients who did not achieve complete remission after the second course were removed from the study. Consolidation of remission was with the DAT regimen (daunorubicin 60 mg/m<sup>2</sup> day 1; ARA-C 60 mg/m<sup>2</sup> 8 hourly SC days 1–5; and thioguanine 70 mg/m<sup>2</sup>/day 8 hourly PO days 1–5) followed by allogeneic bone marrow transplantation (Allo-BMT) in those who had a matched sibling donor. Children without a matched sibling donor were randomized to either autologous bone marrow transplantation (ABMT) or six courses of post-remission chemotherapy (SPC). CNS prophylaxis consisted of intrathecal chemotherapy (ARA-C and prednisone). The treatment schema shown is in Figure 12.1.

Preparative conditioning for ABMT consisted of carmustine 800 mg/m<sup>2</sup> over 3 hours from day –5 (BCNU) and followed 24 hours later by 3 day courses each of amsacrine 150 mg/m<sup>2</sup>/day etoposide 150 mg/m<sup>2</sup>/day and ARA-C 300 mg/m<sup>2</sup>/day as a continuous infusion (BAVC). Cryopreserved unmanipulated marrow was infused 48 hours after completion of ARA-C infusion.

Analysis was performed on the basis of intention to treat.

### Outcome

Of the 173 children registered in the trial, only 161 were considered assessable (12 children were excluded due



**Figure 12.1** Treatment protocol for study AIEOP/LAM 87. © American Society of Clinical Oncology (full reference on p. 240).

to inadequate documentation or ineligibility). A total of 127 patients (79%) achieved CR. Twenty-four patients were allocated to Allo-BMT. Of the remaining 103 patients, 72 were randomized to either ABMT (n = 35) or SPC (n = 37). Thirty-one patients were withdrawn from randomization (NR) because of physician/patient preference in 25, early relapse in 3, severe induction toxicity in 2, and death in CR in 1.

Sixteen patients switched treatment after randomization because of parental wishes (n = 15) or late identification of a matched sibling donor in the SPC group. Twenty-three of the 35 (65%) patients randomized to ABMT received the intended treatment and, in contrast, 4 patients in the intensive chemotherapy arm switched treatment.

### Risk of leukemia relapse

There were 9 relapses in the Allo-BMT group (n = 24), 25 in the ABMT group (n = 35) and 22 in the chemotherapy group (n = 37). The leukemia relapse at 5 years was lower in the Allo-BMT group compared with either the ABMT or post-remission chemotherapy group (45% versus 78% versus 70%; p = 0.03).

### 5-year disease-free survival

Analysis by intention to treat:

Allo-BMT group: 51% (SE 13%)

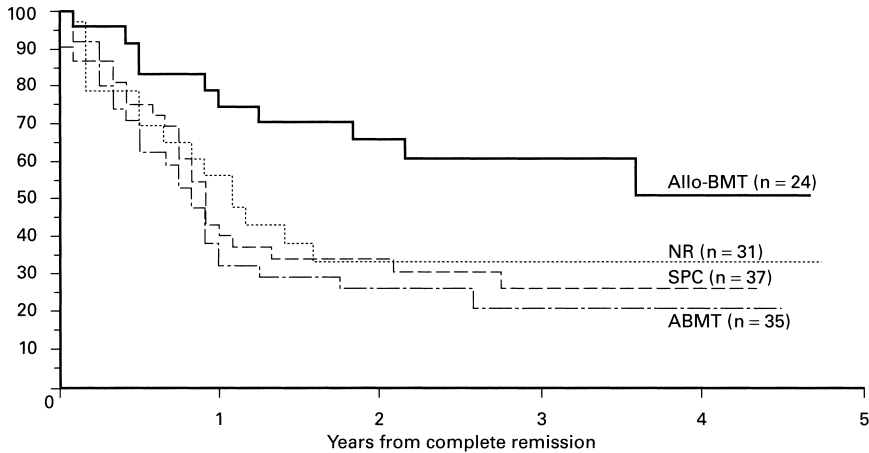
ABMT group: 21% (SE 8%)

SPC group: 27% (SE 8%)

Non-randomized (NR) patients: 34% (SE 10%)

See Figure 12.2.





**Figure 12.2** Probability of DFS by intended post-remission therapy. © American Society of Clinical Oncology (full reference on p. 240).

Analysis by actual treatment received:

Allo-BMT group: 56% (SE 13%)

ABMT group: 28% (SE 10%)

SPC group: 17% (SE 8%)

Allo-BMT was significantly better than either ABMT or post-remission chemotherapy ( $p < 0.05$ ).

No toxicity data were reported in the study.

### Conclusion

It was concluded that autologous bone marrow transplantation was not superior to post-remission chemotherapy in preventing leukemia relapse or extending DFS in children with AML in first remission.

## Study 2

Ravindranath Y, Yeagher AM, Chang MN, Steuber CP, Krischer J, Graham-Pole J, Carroll A, Inoue S, Camitta B, Weinstein HJ. Autologous bone marrow transplantation versus intensive consolidation chemotherapy for acute myeloid leukaemia. *New Engl J Med* 1996;334:1428–34.

### Study design

This was a prospective randomized trial carried out by the Pediatric Oncology Group. The study ran between June 1988 and March 1993.

### Objectives

The aim of the study was:

- To assess and compare the efficacy of autologous bone marrow transplantation (ABMT) with intensive consolidation chemotherapy in children with acute myeloid leukemia in first remission.

### Details of the study

Eligible patients were under 21 years of age with previously untreated acute myeloid leukemia (AML) (FAB M0–M7) or isolated granulocytic sarcoma.

All patients received two courses of induction treatment. Course 1 consisted of daunorubicin 45 mg/m<sup>2</sup> on days 1, 2 and 3; cytosine arabinoside (ARA-C) 100 mg/m<sup>2</sup>/day by continuous infusion on days 1–7 and thioguanine 100 mg/m<sup>2</sup>/day orally on days 1–7. Intrathecal ARA-C was administered on days 1 and 8 of the first course of induction therapy. Additional intrathecal ARA-C was given on days 12 and 19 to patients who had central nervous leukemia at the time of diagnosis. Course 2 commenced on day 15 if the bone marrow showed residual leukemia, otherwise it was begun when the ANC was  $\geq 1 \times 10^9/l$  and the platelet count was  $\geq 100 \times 10^9/l$ . The second course consisted of ARA-C 3 g/m<sup>2</sup> as a 3-hour infusion given 12 hourly for six doses.

Patients who attained disease remission M1 (<5% blasts in the bone marrow) or M2a marrow (5–15% blasts) were eligible for randomization to intensive

chemotherapy or autologous bone marrow transplantation (ABMT) or were allocated to allogeneic (Allo-BMT) where there was an identical HLA sibling donor. All patients then received one course of etoposide 250 mg/m<sup>2</sup> on days 1, 2 and 3 and azacytidine 300 mg/m<sup>2</sup> on days 4 and 5 with intrathecal ARA-C on days 1 and 7. This was followed by either intensive chemotherapy or ABMT in the randomized group, or Allo-BMT.

Patients randomized to intensive chemotherapy received six courses of additional chemotherapy at 3 weekly intervals or on recovery of blood counts. Local radiotherapy was given to those with CNS disease or extracranial mass lesions:

- Course 1: Daunorubicin 45 mg/m<sup>2</sup> on day 1  
ARA-C 3 gm/m<sup>2</sup> 12 hourly on days 1, 2 and 3 (six doses)
- Course 2: Daunorubicin 45 mg/m<sup>2</sup> on Days 1 and 2  
ARA-C 100 mg/m<sup>2</sup>/day as a continuous infusion on days 1–5  
Thioguanine 100 mg/m<sup>2</sup>/day orally on days 1–5
- Course 3: Etoposide 250 mg/m<sup>2</sup> on days 1, 2 and 3  
Azacytidine 300 mg/m<sup>2</sup> on days 4 and 5
- Course 4: ARA-C 3 gm/m<sup>2</sup> 12 hourly on days 1, 2 and 3 (six doses)
- Course 5: Same as course 2
- Course 6: Same as course 3

Patients randomized to ABMT received a regimen consisting of 4 days of oral busulphan (4 mg/m<sup>2</sup>/day) and 4 days of intravenous cyclophosphamide (200 mg/kg total dose) and had 4-hydroxy-cyclophosphamide purged cryopreserved marrow infused after 1 day's rest.

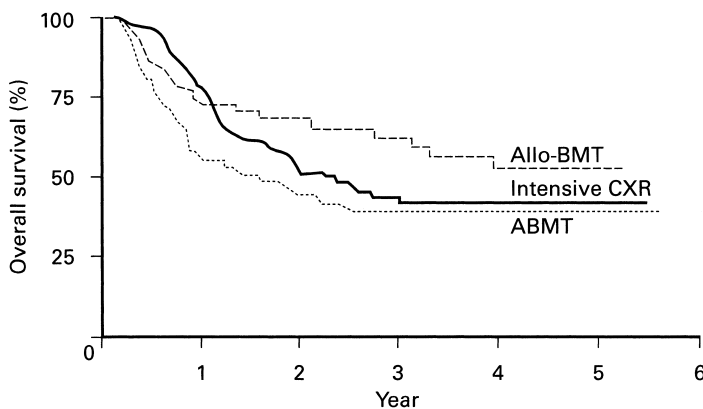
The chemotherapy preparatory regimen for Allo-BMT was identical to ABMT.

Patients who did not achieve remission after the second course of chemotherapy were withdrawn from the trial. It was predicted that 150 randomized patients were necessary to achieve a power of 80% at the 0.05 significance level to detect a difference of 20% in event free survival (EFS) 2 years after randomization between patients who underwent ABMT and chemotherapy.

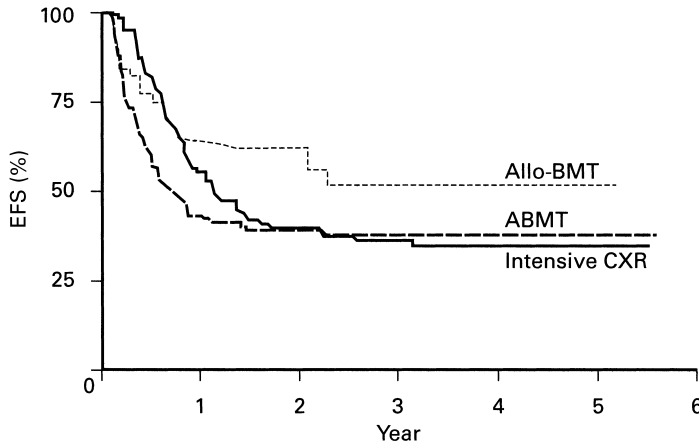
The main outcome measures were overall survival (OS) and EFS. Calculations of EFS and OS for the entire group started from the date of registration; for the randomized groups it was calculated from the date of randomization. Analysis was on the basis of intention to treat.

## Outcome

Of 666 patients registered, 17 were excluded: wrong diagnosis in 10, protocol violations in 3, withdrawal prior to completion of induction therapy in 4. Only 649 were thus considered evaluable for analysis. Of the 552 patients who attained remission (507 M1; 47 M2a marrow), only 232 (68%) patients were randomized to either intensive chemotherapy (117) or ABMT (115). A total of 209 patients were not eligible for randomization (underwent Allo-BMT, 89; non-protocol ABMT, 18; secondary AML, 5; insufficient funds, 64; no beds in transplant unit, 14; death before randomization, 6; drug toxicity, 5; relapse before transplant, 5; not specified, 3) and a further 111 patients, including 21 with Down's syndrome, declined randomization.



**Figure 12.3** OS from time of randomization or assignment to allogeneic bone marrow transplantation. Adapted with permission from Ravindranath *et al.* (full reference on p. 242). © 1996 Massachusetts Medical Society.



**Figure 12.4** EFS from the time of randomization or assignment to Allo-BMT. Adapted with permission from Ravindranath *et al.* © 1996 Massachusetts Medical Society.

Only 71 of the 115 (62%) patients randomized to ABMT received the intended treatment (withdrawal, 23; relapse before ABMT, 21) and in contrast, only 4 patients in the intensive chemotherapy arm did not receive intended treatment (all 4 underwent ABMT).

The 3-year EFS and OS for the entire group was  $34 \pm 2.5\%$  and  $42 \pm 2.6\%$ , respectively. However, 3-year OS in the intensive chemotherapy group was  $44 \pm 6\%$  and in the ABMT group it was  $40 \pm 6.1\%$  ( $p = 0.10$ ) (Figure 12.3) and the 3-year EFS was  $36 \pm 5.8\%$  and  $38 \pm 6.4\%$ , respectively ( $p = 0.20$ ). The relative risk of failure was 0.81 (95% CI 0.58–1.12) for the chemotherapy group as compared to ABMT group. The 3-year EFS

for Allo-BMT patients was  $52 \pm 8\%$  which was better than both the chemotherapy ( $p = 0.06$ ) and ABMT groups ( $p = 0.01$ ) (Figure 12.4).

### Toxicity

Procedural deaths were higher in the ABMT group (11/71, 15%) than after chemotherapy (3/113, 2.7%) ( $p = 0.005$ ).

### Conclusion

It was concluded that ABMT was not superior to intensive chemotherapy in the treatment of children with AML in first remission.

## Study 3

Stevens RF, Hann IM, Wheatley K, Gray RG, on behalf of the MRC Childhood Leukaemia Working Party. Marked improvements in outcome with chemotherapy alone in paediatric acute myeloid leukaemia: results of the United Kingdom Medical Research Council's 10th AML Trial. *Br J Haematol* 1998;101:130–40.

### Study design

This was a study by the United Kingdom Medical Research Council Childhood Leukemia Working Party.

The AML-10 trial ran from May 1988 to March 1995 involving 41 centers in the United Kingdom, Republic of Ireland and New Zealand. It was a randomized trial with a 7-year follow up.

### Objectives

The aims of the study were:

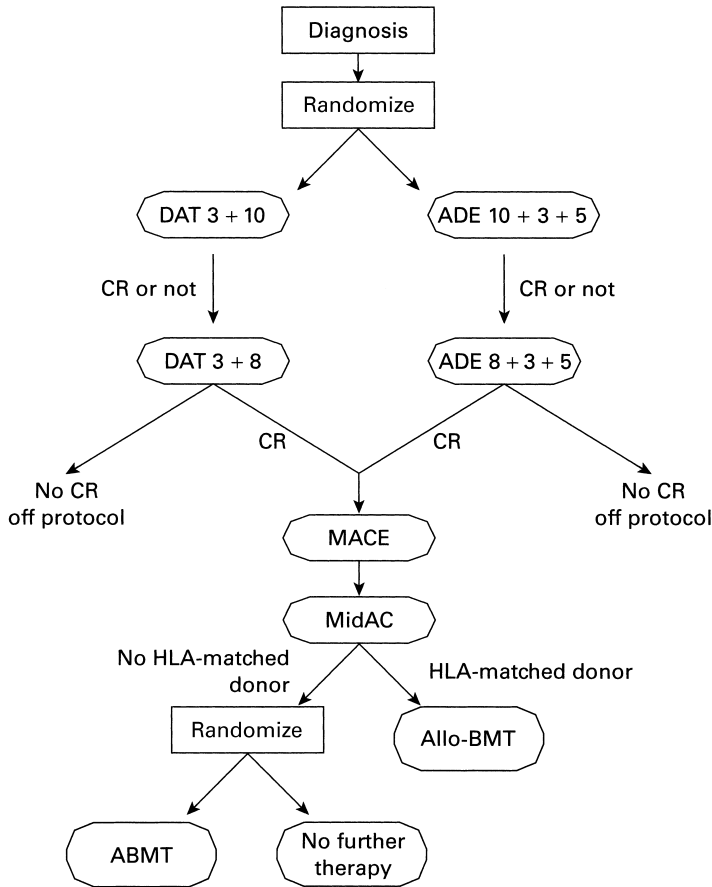
- To compare the efficacy of thioguanine with etoposide during remission induction therapy in children with acute myeloid leukemia.
- To compare high dose therapy followed by autologous bone marrow transplantation with no further treatment in children with acute myeloid leukemia in first remission after four courses of chemotherapy.

### Details of the study

All children below 15 years of age were eligible to be enrolled on the study. In addition to patients who had *de novo* acute myeloid leukemia, those with secondary acute myeloid leukemia (AML) or with MDS (refractory anemia with excess of blasts) were also eligible.

There were two randomizations and the details of chemotherapy treatment and randomizations are shown in Figure 12.5. The first randomization was between two different induction regimens while the

second was between autologous bone marrow transplantation (ABMT) and no further treatment. Children with an identical HLA sibling donor were allocated to allogeneic bone marrow transplantation (Allo-BMT).



- DAT 3 + 10**      Daunorubicin 50 mg/m<sup>2</sup> slow IV push days 1, 3, 5. ARA-C 100 mg/m<sup>2</sup> 12 hourly IV push days 1–10. 6-Thioguanine 100 mg/m<sup>2</sup> 12 hourly orally days 1–10
  - ADE 10 + 3 + 5**      Daunorubicin 50 mg/m<sup>2</sup> slow IV push days 1, 3, 5. ARA-C 100 mg/m<sup>2</sup> 12 hourly IV push days 1–10. Etoposide (VP-16) 100 mg/m<sup>2</sup> IV (1 hour infusion) days 1–5
  - DAT 3 + 8**      As DAT 3 + 10 but ARA-C and 6-Thioguanine days 1–8 only
  - ADE 8 + 3 + 5**      As ADE 10 + 3 + 5 but ARA-C days 1–8 only
  - MACE**      Amsacrine (m-amsa) 100 mg/m<sup>2</sup> IV (1 hour infusion) days 1–5  
                  ARA-C 200 mg/m<sup>2</sup>/d IV (continuous infusion) days 1–5. Etoposide 100 mg/m<sup>2</sup> IV (1 hour infusion) days 1–5
  - MidAC**      Mitoxantrone 10 mg/m<sup>2</sup> IV (short infusion) days 1–5. ARA-C 1.0 g/m<sup>2</sup> 12 hourly IV (2-hour infusion) days 1–3
- Note: All doses were reduced by 25% for children less than 1-year old

**Figure 12.5** Protocol flow chart for study AML-10. Reprinted from Stevens *et al.* with permission from Blackwell Publishing.

In addition, triple intrathecal therapy with methotrexate, cytosine arabinoside (ARA-C) and hydrocortisone was given as part of each course.

Children aged over 2 years who had CNS disease at presentation and were not receiving BMT had craniospinal radiotherapy after completion of chemotherapy.

Patients receiving BMT were treated with cyclophosphamide (120 mg/kg total dose over 2 days) and fractionated total body irradiation. For children aged under 2 years, the conditioning treatment was with busulphan (16 mg/kg total dose over 4 days) and cyclophosphamide (200 mg/kg total dose over 4 days).

Outcome measures were disease free survival (DFS) and overall survival (OS).

**Outcome**

Of 359 eligible patients 341 were considered evaluable for overall outcome and 315 achieved complete remission (CR). A total of 127 were not available for randomization (30 failed to achieve CR after two courses of chemotherapy; 19 relapsed or died before randomization; and 78

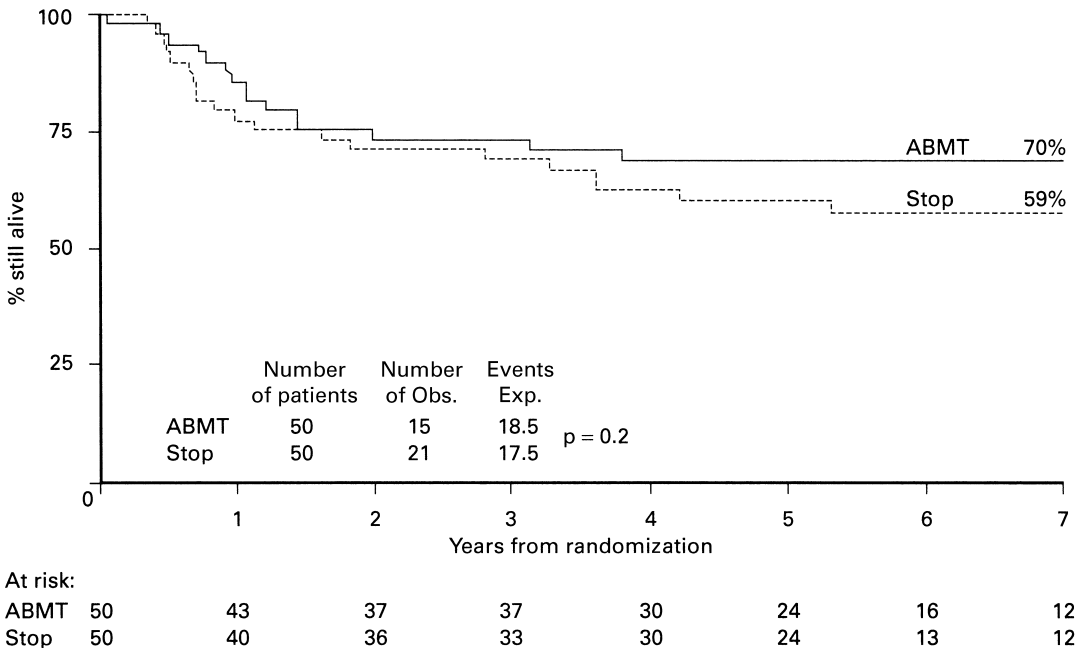
had a matched sibling donor) and 100 eligible for randomization were not randomized (5 physician choice, 8 parental choice, 87 electively received ABMT – physician choice 45, parental choice 42).

Only 100 (50%) eligible children in CR were randomized between ABMT and no further treatment. Of the 50 children randomized to ABMT, only 44 received it – non-compliance was due to infection (n = 1), death (n = 1), early relapse (n = 1), persistent eosinophilia (n = 1) and poor cardiac function (n = 2). Compliance was 100% in the stop arm.

DFS at 7 years in the ABMT group was 68% versus 46% in the stop arm (p = 0.02) while relapse free survival (RFS) at 7 years in the ABMT group was 69% versus 48% in the stop arm (p = 0.03).

OS at 7 years in the ABMT group was 70% versus 59% in the stop arm (p = 0.2) (Figure 12.6).

Though the DFS and the RFS were lower in patients who were randomized to ABMT, OS did not differ between the ABMT and no further treatment groups, and this seems to be related to inferior survival from relapse after ABMT.



**Figure 12.6** Survival by autograft versus stop randomization. Under number of events, Obs.: observed number of deaths in each arm and Exp.: expected number from log-rank analysis. Reprinted from Stevens *et al.* with permission from Blackwell Publishing.

**Toxicity**

The transplant related procedural mortality in the ABMT group was 2%.

**Conclusion**

It was concluded that ABMT did not improve survival in children with AML in first remission.

**Study 4**

Woods WG, Neudorf S, Gold S, Sanders J, Buckley JD, Barnard DR, Dusenberry K, DeSwarte J, Arthur DC, Lange BJ, Koblinsky NL. A comparison of allogeneic bone marrow transplantation, autologous bone marrow transplantation, and aggressive chemotherapy in children with acute myeloid leukaemia in remission: a report from the Children's Cancer Group. *Blood* 2001; 97:56–62.

**Study design**

This was a prospective randomized multicenter trial conducted by the Children's Cancer Group (CCG-2891). It ran from October 1989 to April 1995.

**Objectives**

The objective of the study was:

- To compare the efficacy and toxicity of allogeneic bone marrow transplantation, autologous bone marrow transplantation and aggressive post-remission chemotherapy in children with acute myeloid leukemia in first remission.

**Details of the study**

Children and adolescents younger than 21 years of age with a diagnosis of acute myeloid leukemia (AML) (M0–M7), acute undifferentiated or biphenotypic leukemia with myeloid differentiation were eligible for the study. Informed consent was obtained from families of patients in all cases. Patients with Fanconi anemia or Philadelphia positive chronic myeloid leukemia were excluded as were children with Down's syndrome. Those who developed secondary AML or had granulocytic sarcoma without bone marrow infiltration or who had *de novo* myelodysplastic syndrome were also excluded from analysis.

No details of how randomization was done are given in the report.

The first randomization was at diagnosis and patients were randomized to two induction regimens – standard

and intensive – in which identical drugs and doses were used. Patients randomized to the intensive arm received the second cycle of chemotherapy 6 days after completion of cycle 1 irrespective of bone marrow or hematological status. Initial induction chemotherapy consisted of a 5 drug regimen administered over 4 days – dexamethasone, 6-thioguanine, cytosine arabinoside (ARA-C), daunorubicin and etoposide. Daunorubicin, etoposide and ARA-C were administered as a continuous infusion for 96 hours. Chemotherapy drug doses are not indicated. Standard timing induction therapy was closed in May 1993 and granulocyte colony stimulating factor was introduced for all patients during the induction phase (see Chapter 11, Study 2).

The second randomization was after four cycles of chemotherapy. Patients randomized to autologous bone marrow transplantation (ABMT) received a regimen of 4 days of oral busulphan (16 mg/kg total dose) and 4 days of intravenous cyclophosphamide (200 mg/kg total dose) and had 4-hydroxy-cyclophosphamide *ex vivo* purged marrow infused after 1 day's rest. Patients randomized to post-remission chemotherapy received four courses of three different chemotherapy regimens each lasting for 4–6 weeks. Details of post-remission chemotherapy are not available. All patients who had HLA-identical family donors were allocated to allogeneic bone marrow transplantation (Allo-BMT) with an identical regimen to ABMT.

Main outcome measures were disease free survival (DFS) and overall survival (OS) comparing the three post-remission regimens at 4–9 years of follow up.

**Outcome**

Of 1114 children registered, 652 patients successfully completed four courses of intensive chemotherapy and were eligible for allocation to Allo-BMT or randomization to ABMT or intensive chemotherapy. One hundred and fifteen patients refused to participate in the post-remission phase of the trial. Analysis was by intention to treat.

A total of 181 patients were allocated to Allo-BMT, 177 were randomized to ABMT and 179 patients were

randomized to intensive chemotherapy. There was no difference among the three groups of patients based on white blood counts at diagnosis or the various cytogenetic abnormalities. Excluding patients with early relapses and hence not eligible to start actual post-remission treatment, compliance rates were between 83% and 97%: 164/181 (94%) Allo-BMT; 137/177 (83%) ABMT; 171/179 received post-remission chemotherapy.

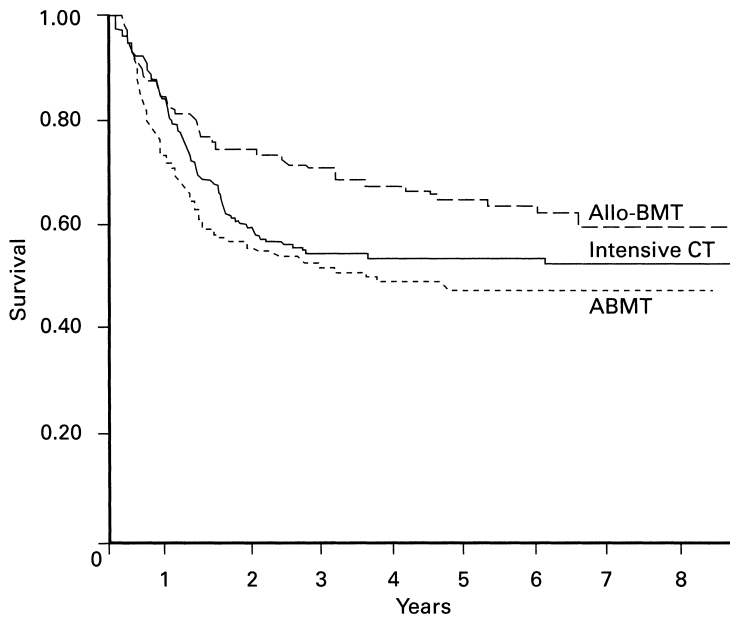
For the whole group of 537 eligible patients, the 8-year OS is  $54 \pm 4\%$  (SD = 2) and the DFS for the same period is  $48 \pm 4\%$ . Figure 12.7 and Table 12.1 summarize the post-remission outcome:

1 Allo-BMT: OS and DFS in this group (n = 181) was  $60 \pm 9\%$  and  $55 \pm 9\%$ , respectively (p value Allo versus Auto 0.002 and 0.001, respectively).

2 ABMT: OS and DFS was  $48 \pm 8\%$  and  $42 \pm 8\%$ , respectively (p value Auto versus Chemo 0.21 and 0.31, respectively).

3 Intensive non-marrow ablative chemotherapy: OS and DFS was  $53 \pm 8\%$  and  $47 \pm 8\%$ , respectively (p value Chemo versus Allo 0.05 and 0.01, respectively).

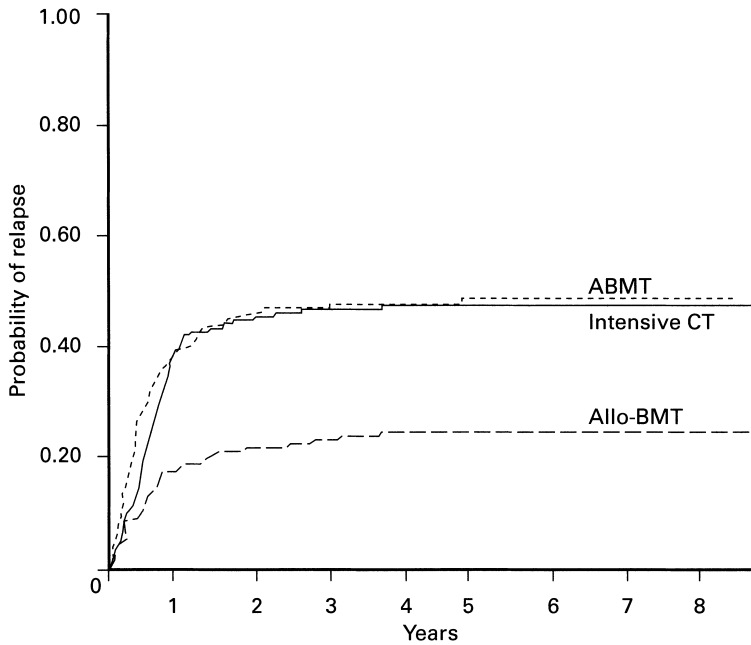
4 Relapse rates were similar for children randomized to either ABMT or intensive chemotherapy when compared with allogeneic BMT (Figure 12.8).



**Figure 12.7** Actuarial survival from AML remission, comparing the three post-remission regimens from CCG-2891. Reproduced with permission of the American Society of Hematology (full reference on p. 247).

**Table 12.1** Outcome at 8-year actuarial comparing the three post-remission regimens from CCG-2891.

	Allogeneic BMT		Autologous BMT		Chemotherapy	
		p value (Allo versus Auto)		p value (Allo versus Chemo)		p value (Chemo versus Auto)
All patients (n = 537)	181		177		179	
Survival	$60 \pm 9\%$	0.002	$48 \pm 8\%$	0.21	$53 \pm 8\%$	0.05
Disease free survival	$55 \pm 9\%$	0.001	$42 \pm 8\%$	0.31	$47 \pm 8\%$	0.01
Patients receiving intensive timing induction (n = 36)	113		115		108	
Survival	$70 \pm 9\%$	0.006	$54 \pm 9\%$	0.67	$57 \pm 10\%$	0.02
Disease free survival	$66 \pm 9\%$	0.003	$48 \pm 9\%$	0.53	$53 \pm 10\%$	0.02



**Figure 12.8** Actuarial probability of relapse after AML remission, comparing the three post-remission regimens from CCG-2891. Reproduced with permission of the American Society of Hematology (full reference on p. 247).

## Toxicity

More gastrointestinal and hepatic toxicity was seen in the Allo-BMT group. Average time to neutrophil recovery was 23 days in the Allo-BMT arm and 47 days in the ABMT arm. Overall non-leukemic deaths were 14% in the Allo-BMT arm, 5% in the ABMT arm and 4% in the chemotherapy arm. The majority of non-leukemic deaths in the ABMT arm ( $n = 7/9$ ) and all non-leukemic deaths ( $n = 8$ ) in the chemotherapy arm were due to infections. There were no apparent differences in toxicity in the post-remission arms based on which induction regimen was used.

## Conclusion

- Allogeneic bone marrow transplantation after four courses of intensive chemotherapy reduced the risk for relapse and improved overall and disease free survival in patients with acute myeloid leukemia.
- Autologous bone marrow transplantation confers no added advantage over intensive chemotherapy in children with acute myeloid leukemia.



## CHAPTER 13

# Role of maintenance treatment in childhood acute myeloid leukemia

## Studies

### Study 1

Yves Perel, Anne Auvrignon, Thierry Leblanc, Jean-Pierre Vannier, Gerard Michel, Brigitte Nelken, Virginie Gandemer, Claudine Schmitt, Jean-Pierre Lamagnere, Lionel De Lumley, Brigitte Bader-Meunier, Gerard Couillaud, Gerard Schaison, Judith Landman-Parker, Isabelle Thuret, Jean-Hugues Dalle, Andre Baruchel, Guy Leverger for the Group LAME of the French Society of Paediatric Haematology and Immunology. Impact of addition of maintenance therapy to intensive induction and consolidation chemotherapy for childhood acute myeloblastic leukemia: results of a prospective randomized trial, LAME 89/91. *J Clin Oncol* 2002;20:2774–82.

### Study design

This was a prospective randomized multi-center study that extended from December 1988 to June 1996. Randomization methodology was not specified. Written informed consent was obtained for all patients. Complete remission (CR) was defined as <5% blasts in a normocellular bone marrow with no evidence of extramedullary leukemia and normal blood counts.

### Objectives

The aim of this study was:

- To assess the role of maintenance therapy in the treatment of childhood acute myeloid leukemia (AML).

### Details of the study

Previously untreated children and adolescents with acute myeloid leukemia (AML) of French–American–British (FAB) subtype M1–M6 were included in the study. Patients with Down's syndrome, secondary AML, FAB subtype M0 or M7 AML or bi-phenotypic leukemia were excluded from trial.

Induction therapy consisted of 7 days of continuous intravenous (IV) infusion of cytosine arabinoside (ARA-C) (200 mg/m<sup>2</sup>/day) and 5 days of IV mitoxantrone (12 mg/m<sup>2</sup>/day). Children <1 year received two-thirds of these doses. Patients, who had >20% blasts in the bone marrow on day 20, received a second course of continuous IV infusion of ARA-C (200 mg/m<sup>2</sup>/day × 3 days) and IV mitoxantrone (12 mg/m<sup>2</sup>/day × 2 days). All patients in CR with a human leukocyte antigen (HLA) identical family donor underwent allogeneic bone marrow transplantation. Patients with no matched family donor received two courses of consolidation chemotherapy.

The first consolidation course consisted of 4 days each of IV etoposide (100 mg/m<sup>2</sup>/day as 1-hour infusion), IV ARA-C (100 mg/m<sup>2</sup>/day as continuous infusion) and IV daunorubicin (40 mg/m<sup>2</sup>/day as 1-hour infusion). The second consolidation course (only after complete hematological recovery) comprised two cycles of ARA-C infusions plus asparaginase administered 7 days apart (cycles 1 & 2 – ARA-C 1 g/m<sup>2</sup> 1-hour IV infusion 12 hourly × 4 followed by 6000 U/m<sup>2</sup> of asparaginase). All children above the age of 1 year also received a 1-hour IV infusion of amsacrine (150

mg/m<sup>2</sup>/day) on days 4–6 between the two cycles of ARA-C.

Maintenance therapy (MT) commenced after the second consolidation course, and consisted of daily oral 6-mercaptopurine (50 mg/m<sup>2</sup>/day) and monthly pulses of subcutaneous ARA-C (25 mg/m<sup>2</sup>/dose 12 hourly × 4 days) for 18 months. In March 1991, children still in CR after the second consolidation course were randomized either to stop or continue MT for 18 months. Randomization to stop or continue therapy was centrally performed only after hematological recovery. Patients with FAB subtypes of AML M4 and M5 or patients with a presenting white blood cell (WBC) count >50 × 10<sup>9</sup>/l also received pre-symptomatic central nervous system (CNS) intrathecal (IT) chemotherapy. This comprised of two doses of IT ARA-C, methotrexate and corticosteroid during induction (day 1 and at hematological recovery) and three doses during consolidation therapy (days 1, 5 and 20). Additionally, all patients who had evidence of CNS disease at diagnosis also received three additional courses of IT chemotherapy (two during

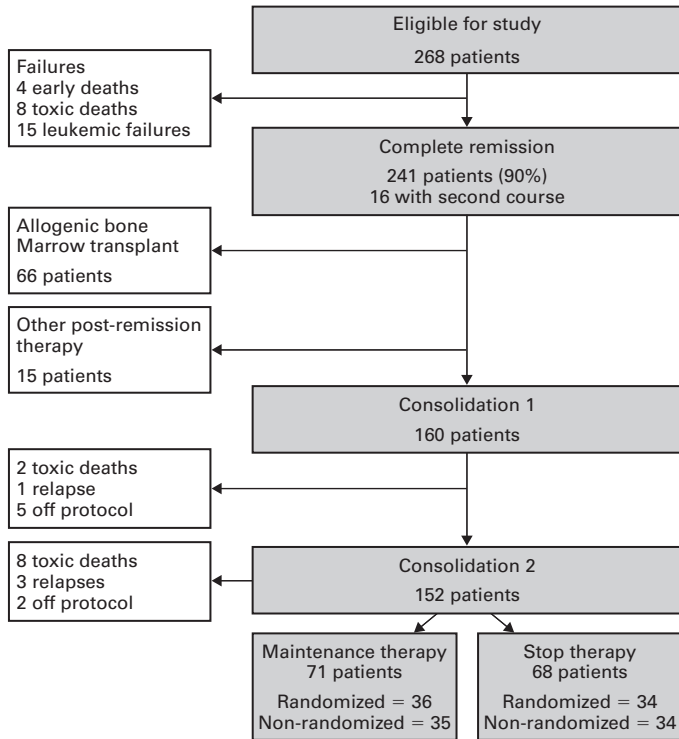
induction and one in consolidation) plus 24-Gy cranial irradiation after the second consolidation course.

**Outcome end points**

The main outcome measures were disease-free survival (DFS), event free survival (EFS) and overall survival (OS).

**Outcome 1**

Of the 268 patients enrolled in the trial, 33 (12%) were below the age of 1 year; 28 (10%) patients had CNS disease at diagnosis. The median presenting WBC count was 25.6 × 10<sup>9</sup>/l. Distribution of FAB AML subtypes were as follows: M1 (n = 34), M2 (n = 77), M3 (n = 17), M4 (n = 40), M4<sub>EO</sub> (n = 16), M5 (n = 77) and M6 (n = 7). Patient numbers according to treatment arms are shown in Figure 13.1. Of 139 patients eligible to commence MT, only 70 were randomized to either stop (n = 34) or continue MT (n = 36) for 18 months. Patient characteristics in the two randomized arms are shown in Table 13.1. Of the remaining 69 patients, 34 were non-randomly allocated to stop



**Figure 13.1** Flow diagram showing the numbers of patients according to treatment arm. © American Society of Clinical Oncology (full reference on p. 250).

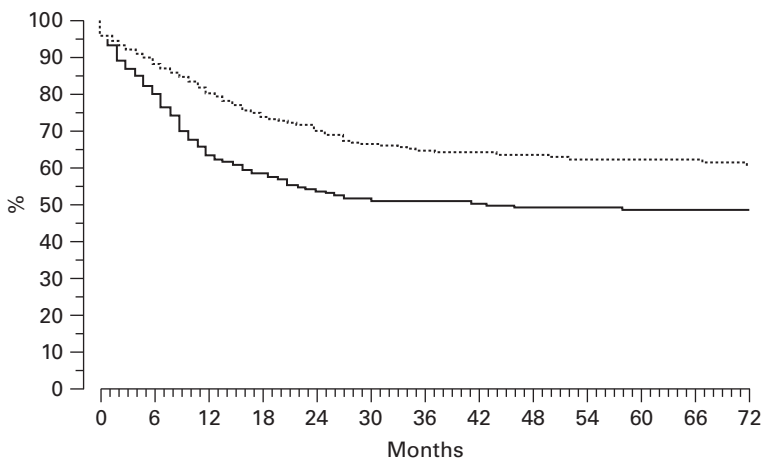
therapy (parental or physician choice – 19, poor hematological recovery – 8 and pilot phase of study – 7) and 35 non-randomly allocated to MT (parental or physician choice – 13 and pilot phase of study – 22).

Two hundred and twenty-five (84%) patients achieved CR after the first course of induction and an additional 16 achieved CR after reinforcement at day 21. The 6-year EFS and OS for the entire cohort was  $48 \pm 6\%$  and  $60 \pm 6\%$ , respectively (Figure 13.2).

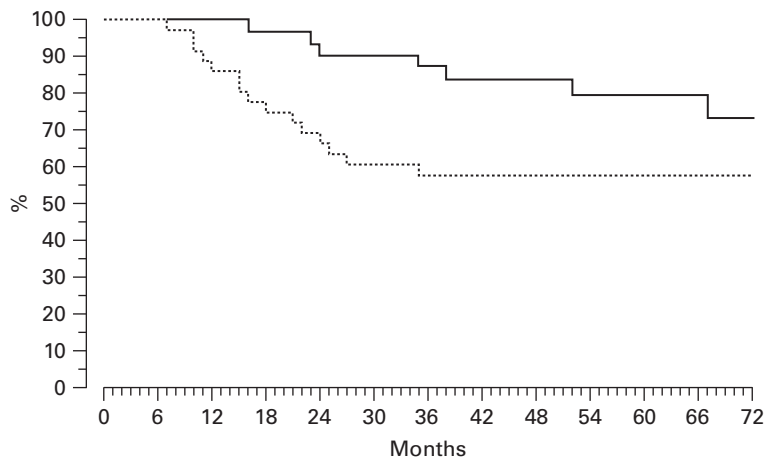
Comparing the DFS and OS for the randomized patients, the 6-year DFS was  $50 \pm 15\%$  for patients randomized to MT versus  $60 \pm 19\%$  in the stop arm ( $p = 0.25$ ) while the 6-year OS was  $58 \pm 15\%$  in the MT group versus  $81 \pm 13\%$  in the stop arm ( $p = 0.04$ ) (Figure 13.3). Table 13.2 shows the patient characteristics of relapsed patients in the two randomized arms. As shown in Table 13.3, patients randomized to the stop arm had a higher probability of achieving a

**Table 13.1** Patient characteristics by MT randomization.

Characteristic	Randomized patients		p for Homogeneity
	No MT	MT	
Number of patients	34	36	
Median age (years)	5	5.2	0.67
Female/male	17/17	20/16	0.64
Median WBC ( $\times 10^9/l$ )	15	24	0.23
FAB subtypes (number of patients)			
M1	4	4	
M2	7	10	
M3	3	2	
M4/M4 <sub>E0</sub>	5/1	6/5	
M5	12	9	
M6	2	0	0.55
Cytogenetics (number available)	24	26	
t(15;17)	2	2	0.99
t(8;21)	5	4	0.72
11q23 abnormality	6	9	0.46
inv(16)	3	5	0.70
5q-7q-	0	0	0.99
Normal	8	6	0.42
Patients needing a second course of day 21	2	1	0.61



**Figure 13.2** EFS ( $n = 268$ , solid line) and OS ( $n = 268$ , dotted line) in patients of the LAME 89/91 study. At 6 years, EFS was  $48 \pm 6\%$  and OS was  $60 \pm 6\%$ . © American Society of Clinical Oncology (full reference on p. 250).



**Figure 13.3** OS comparison of randomized patients with MT versus without MT, with time from the day of randomization. Dotted line: OS with MT (n = 36); solid line: OS without MT (n = 34) (p = 0.04). © American Society of Clinical Oncology (full reference on p. 250).

**Table 13.2** Initial features and treatment characteristics of patients relapsing after randomization.

Characteristic	No MT (n = 13)	MT (n = 18)
Median age (years)	5	5.8
Female/male	6/7	9/9
Median WBC ( $\times 10^9/l$ )	13	32
FAB subtype (number of patients)		
M1	4	4
M2	2	4
M3	1	1
M4/M4 <sub>EO</sub>	1	3
M5	4	6
M6	1	0
Cytogenetics (number available)	11	10
t(15;17)	0	1
t(8;21)	3	1
11q23 abnormality	3	4
inv(16)	2	1
5q-/-7q-	0	0
Normal	3	3
Patients needing a second course at day 21 (number)	1	1
CR1 duration (months)		
Median	10	8
Mean	14	10
Range	6-50	3-32
Re-induction therapy		
Cytarabine plus anthracycline	8	6
High dose cytarabine plus anthracycline	1	3
Fludarabine-based regimen	1	1
VP-16 plus carboplatin-based regimen	2	3
All-trans-retinoic acid	0	1
Other	1	4
CR2 achievement	11/13	8/18
Post-CR2 therapy		
Genoidentical BMT/cord-blood transplant in CR2	1/1	1/0
Phenoidentical BMT in CR2	1	2
Mismatched allogenic BMT in CR2	1	0
Autologous BMT in CR2	7	5
Cranial radiation in CR2	0	0

BMT: bone marrow transplantation and VP-16: etoposide.

**Table 13.3** Outcome according to MT of randomized patients.

Characteristic	Randomized patients	
	No MT	MT
Number of patients	34	36
Relapses	13	18
CR2 achievement	11/13	8/18 (p = 0.03)
CR2 duration (months)		
Median	28	15
Mean	38	26
Range	5–96	4–75

second CR compared to patients randomized to MT (p = 0.03).

When DFS and OS were compared for the whole group (randomized and non-randomized), once again patients who received MT had a poorer outcome (DFS in the MT group – 50 ± 11% versus 63 ± 12% in the stop arm; p = 0.48 and OS in the MT group – 59 ± 11% versus 73 ± 11% in the stop arm; p = 0.08). The probability of achieving a second CR was lower in the group who received MT (14/34) compared to the stop arm (19/28) (p = 0.04).

## Toxicity

One randomized patient in the MT group died of fulminant hepatitis during MT.

## Conclusion

Maintenance therapy had an adverse impact with regard to OS due to inferior salvage rate after relapse.

## Addendum

This report has been recently updated in a more recent publication which confirms that maintenance chemotherapy had an adverse impact on OS in children with AML.

## Publication

Perel Y, Auvrignon A, Leblanc T, Michel G, Vannier JP, Dalle JH, Gandemer V, Schmitt C, Mechinaud F, Lamagnere JP, Piguët Ch, Couillaud G, Pautard B, Baruchel A, Leverger G, Group LAME, French Society of Pediatric Hematology and Immunology. Maintenance therapy in childhood acute myeloid leukemia. *Ann Hematol* 2004;83(Suppl 1):S116–9.

## Study 2

Robert J. Wells, William G. Woods, Jonathan D. Buckley, Lorrie F. Odam, Dennis Benjamin, Irwin Bernstein, Donna Betcher, Stephen Feig, Tae Kim, Fredrick Ruymann, William Smithson, Ashok Srivatsava, Raymond Tannous, Connie M. Buckley, J. Kenneth Whitt, Lawrence Wolff, Beatrice C. Lampkin. Treatment of newly diagnosed children and adolescents with acute myeloid leukaemia: A Children's Cancer Group Study. *J Clin Oncol* 1994; 12:2367–77.

## Study design

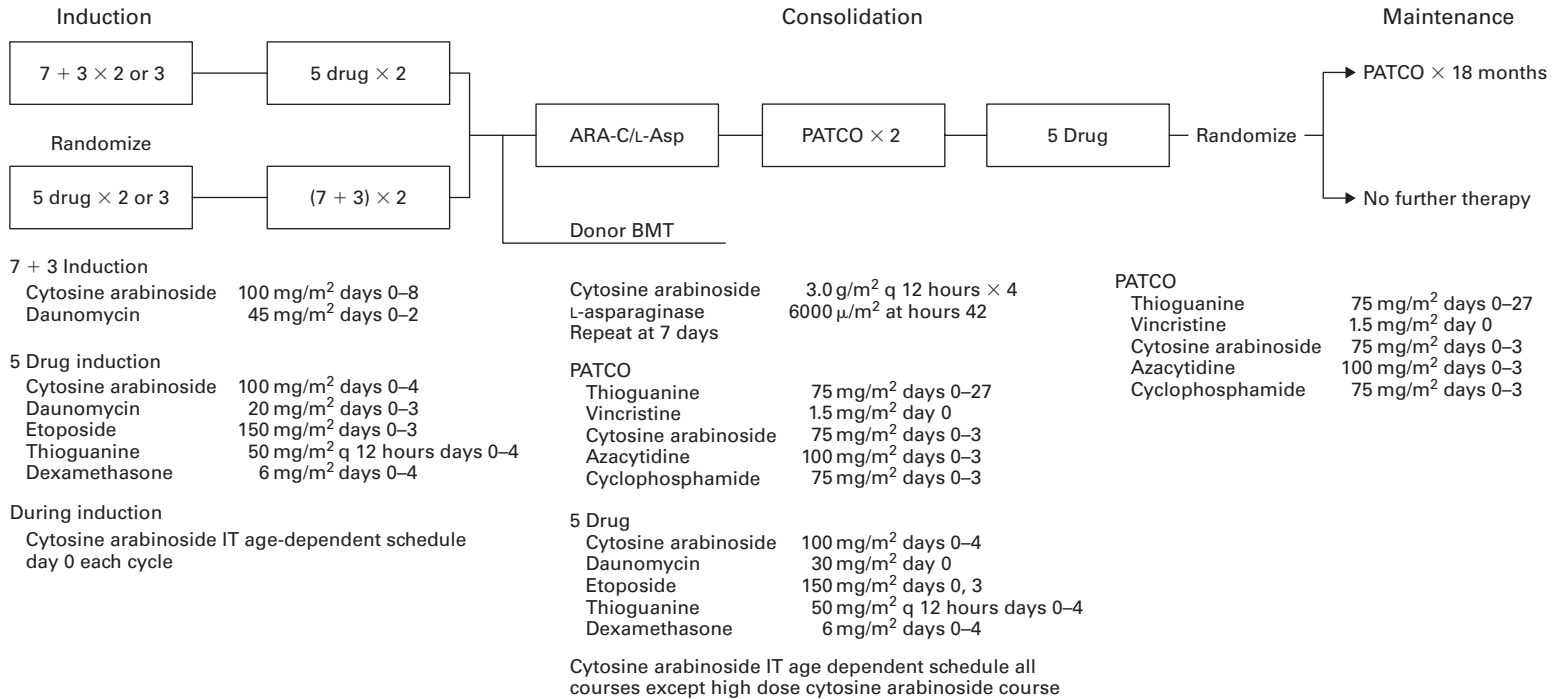
CCG 213 was a randomized prospective multi-center study that ran from January 1986 through February 1989. Methodology of randomization was not specified in the report.

## Objectives

The main questions were:

- Whether the addition of other chemotherapeutic agents to the standard regimen of cytarabine and daunorubicin improved remission rate and clinical outcome in children with acute myeloid leukemia (AML)?
- Does allogeneic bone marrow transplantation (Allo BMT) in first complete remission improve disease-free survival (DFS) and overall survival (OS) when compared with post-remission consolidation chemotherapy?
- Is there a place for “maintenance chemotherapy” in the treatment of childhood AML?

This review focuses on the role of maintenance chemotherapy in childhood AML.



**Figure 13.4** Schema of CCG 213. IT: intrathecal and L-Asp: asparaginase. © American Society of Clinical Oncology (full reference on p. 254).

## Study details

### Patients and eligibility criteria

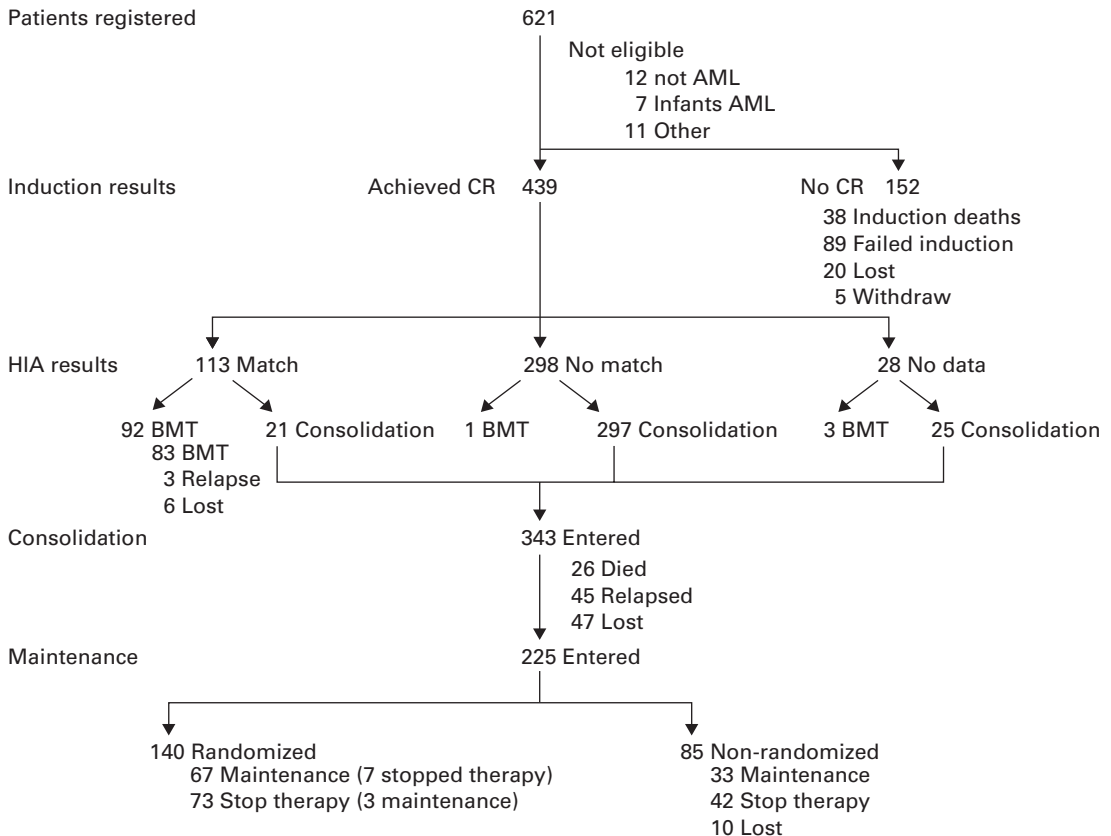
All patients <22 years of age with a diagnosis of AML were eligible to be enrolled on the study. Infants <2 years of age with acute monoblastic leukemia were excluded as they were treated on a different chemotherapy regimen.

### Treatment details

Figure 13.4 shows the treatment schema of CCG 213. All patients were randomized at diagnosis to one of two induction regimens (Figure 13.4). For regimen 1, the first cycle consisted of 7 days of continuous infusion of cytarabine (ARA-C) and bolus doses of daunorubicin (DNR) on the first 3 days of therapy. The second cycle was shortened to 5 days of ARA-C and 2 days of DNR if

reassessment bone marrow showed <5% blasts after first cycle otherwise the second and/or the third cycles were identical to cycle 1. Regimen 2 consisted of ARA-C, DNR, etoposide (VP-16), dexamethasone (DEX) and thioguanine (TG). Depending on the response to therapy, two or three cycles were given. Patients initially randomized to regimen 1 (7 + 3) crossed over to receive the five-drug regimen either after two cycles if in remission (blasts in marrow < 5%) or after three cycles irrespective of the marrow status and vice versa.

Central nervous system (CNS) prophylaxis: consisted of intrathecal cytarabine (IT ARA-C) administered on the first day of each induction cycle and throughout the consolidation phase (except during high dose ARA-C therapy) for those not transplanted. Patients who had CNS disease at diagnosis received



**Figure 13.5** CCG 213: Patients entering the phases of therapy (induction, BMT, consolidation and maintenance) with explanation for failure to progress to the next phase. © American Society of Clinical Oncology (full reference on p. 254).

weekly IT ARA-C during induction and monthly during consolidation.

Post-induction therapy: patients who had a human leukocyte antigen (HLA) matched donors were assigned to bone marrow transplantation (BMT) after one course of induction (two or three cycles) if they were in complete remission (CR). Those not in CR after induction were eligible for BMT after two courses (five cycles) provided the marrow had <16% blasts after two courses of therapy. BMT conditioning regimen consisted of fractionated total body irradiation (TBI) and cyclophosphamide. Patients not assigned to BMT received post-induction consolidation as shown in Figure 13.5. Following consolidation, patients were randomized to either receive maintenance therapy or stop treatment. Maintenance therapy was identical to the second consolidation course (PATCO) and continued for 18 months.

**Outcome measures**

The main outcome measures were overall survival (OS) and disease free survival (DFS).

**Outcome**

Of the 225 patients who completed consolidation, and were eligible for randomization for either maintenance chemotherapy or no further treatment, only 140 patients were randomized (Figure 13.5). The reasons for non-randomization were either parental or physician choice (n = 85).

*Randomized group*

Sixty-seven patients were randomized for maintenance therapy and 73 to stop therapy. However, 7 of the 67 randomized to receive maintenance stopped therapy while 3 of the 73 randomized to stop therapy received maintenance chemotherapy.

*Non-randomized group*

Of the 85 non-randomized patients, 33 received maintenance chemotherapy, 42 elected to stop therapy and 10 were lost for follow-up.

*Overall outcome*

The projected 5-year OS and DFS for the group randomized to receive maintenance therapy was 46% (95% CI 33–59%) and 42% (95% CI 30–54%), respectively, compared to 68% (95% CI 57–79%) and 52% (95% CI 40–64%), respectively, for those randomized to stop treatment (Table 13.4 & Figure 13.6).

Similar outcomes were seen in the non-randomized group of patients (Table 13.4).

In all comparisons (i.e. randomized, non-randomized and as treatment received), survival outcome was inferior for patients who received maintenance therapy (Figure 13.6 and Table 13.4).

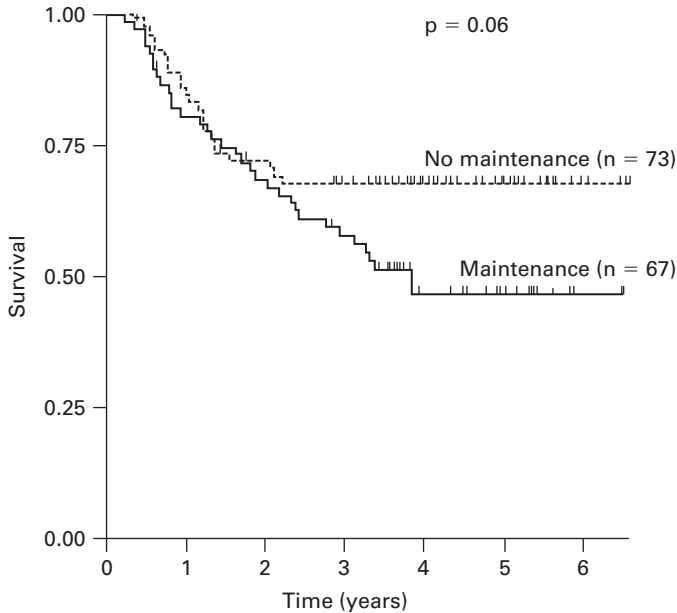
**Conclusion**

It was concluded that children who received maintenance chemotherapy had an inferior survival outcome.

**Table 13.4** Comparisons of maintenance versus no maintenance therapy following consolidation.

Variables	Survival				DFS			
	5-year estimate				5-year estimate			
	%	95% CI	p	Log rank p	%	95% CI	p	Log rank p
Randomized patients only								
Maintenance (n = 67; includes 7 stop therapy)	46	33–59	0.01	0.06	42	30–54	0.12	0.36
Stop therapy (n = 73; includes 3 maintenance)	68	57–79			52	40–64		
Non-randomized patients								
Maintenance (n = 33)	50	32–68	0.07	0.08	44	26–62	0.10	0.14
Stop therapy (n = 42)	67	52–82			59	44–74		
All patients as treated								
Maintenance (n = 96)	49	38–60	0.01	0.02	44	34–54	0.08	0.19
Stop therapy (n = 119)	65	56–74			54	45–63		





**Figure 13.6** Survival comparison of patients receiving maintenance therapy or discontinuing therapy from the end of the consolidation for randomized patients only. © American Society of Clinical Oncology (full reference on p. 254).

### Study 3

de Botton S, Coiteux V, Chevret S, Rayon C, Vilmer E, Sanz M, de La Serna J, Philippe N, Baruchel A, Leverger G, Robert A, San Miguel J, Conde E, Sotto JJ, Bordessoule D, Fegueux N, Fey M, Parry A, Chomienne C, Degos L, Fenaux P. Outcome of childhood acute promyelocytic leukemia with all-*trans*-retinoic acid and chemotherapy. *J Clin Oncol* 2004;22:1404–12.

### Study design

APL 93 was a prospective randomized European trial (April 1993 to October 1998) that combined all-*trans* retinoic acid (ATRA) with chemotherapy (CT) in the treatment of newly diagnosed patients with acute promyelocytic leukemia (APL). Randomization for induction and maintenance were performed through a centralized telephone assignment procedure. Written informed consent was obtained for all patients enrolled on the trial.

### Objectives

The primary objectives of the trial were:

- To determine the optimal timing of ATRA treatment in childhood APL and its role during maintenance therapy in APL. The focus of this review is on the role of maintenance therapy in APL.

### Study details

#### Study population

All patients with APL younger than the age of 18 years were included in this analysis. Inclusion criteria for enrollment were morphology consistent with APL, presence of the t(15;17) or PML-RAR $\alpha$  [a fusion protein of promyelocytic leukemia (PML) gene and the retinoic acid receptor- $\alpha$  (RAR $\alpha$ )] gene.

#### Treatment details

##### Induction

All APL patients with a presenting white blood cell (WBC) count of  $<5 \times 10^9/l$  were randomized at diagnosis to either an induction regimen of oral ATRA treatment (45 mg/m<sup>2</sup>/day) followed by sequential CT (ATRA  $\rightarrow$  CT) or ATRA + CT. In the ATRA  $\rightarrow$  CT group, patients received oral ATRA till the achievement of complete remission (CR) or maximum of 90 days. Following achievement of CR, all patients received daunorubicin (DNR) 60 mg/m<sup>2</sup>  $\times$  3 days along with cytarabine(ARA-C) 200 mg/m<sup>2</sup>/day as a continuous infusion for 7 days (course 1). However, if the WBC count increased rapidly (i.e.  $6 \times 10^9/l$ ,  $10 \times 10^9/l$ ,  $15 \times 10^9/l$  by days 5, 10 and 15, respectively) on ATRA treatment, CT was commenced immediately to prevent development of ATRA syndrome. Patients randomized

to ATRA + CT received the same dose of ATRA with identical CT that commenced on day 3 of ATRA treatment. Patients with a presenting WBC count  $>5 \times 10^9/l$  were not randomized but received ATRA + CT from day 1.

#### *Consolidation phase*

Patients in CR after course 1 received two consolidation courses of CT; course 2 that was identical to course 1 and course 3 that consisted of DNR  $45 \text{ mg/m}^2/\text{day} \times 3$  days and ARA-C  $1 \text{ g/m}^2$  12 hourly  $\times 4$  days.

#### *Post-consolidation phase*

Patients in CR at the end of the consolidation phase were randomized to one of four post-consolidation arms (1) no maintenance, (2) intermittent oral ATRA ( $45 \text{ mg/m}^2/\text{day}$ ) for 15 days every 3 months, (3) daily oral mercaptopurine ( $90 \text{ mg/m}^2$ ) with weekly oral methotrexate ( $15 \text{ mg/m}^2$ ) or both (CT + ATRA). Randomization for maintenance was done according to a two  $\times$  two factorial design stratified by initial induction therapy.

#### *ATRA syndrome*

This was a clinical diagnosis based on the presence of at least three of the following clinical signs/symptoms: fever, weight gain, respiratory distress, pulmonary infiltrates, pleural or pericardial effusions, hypotension and renal failure. Treatment of ATRA syndrome was with oral dexamethasone ( $10 \text{ mg/m}^2$  12 hourly) along with commencement of CT (if not already started).

### **Outcome end points**

The main end point for maintenance therapy was the time to relapse calculated from the date of randomization for maintenance (relapse-free survival (RFS)). Secondary end points included overall survival (OS) and event-free survival (EFS), again calculated from date of maintenance randomization.

### **Statistics**

EFS and OS were estimated by the Kaplan–Meier method and compared by the log rank test. The Cox's proportional hazard model was used to estimate hazards ratio with 95% CI. Time to relapse was estimated in the setting of competing risks with death before relapse being considered as a competing risk. Non-parametric estimators were used and compared by the Gray test whereas hazards ratios were estimated using the proportional Fine and Gray model. For quantitative variables, data were reported as medians (25th to 75th

centiles), whereas for qualitative variables, data were reported as number and percentage of patients. All statistical tests were two sided and p value  $<0.05$  was considered significant. All analyses were performed on the SAS 8.2 software package.

### **Outcome**

Of the 576 patients who were enrolled on APL 93 trial, 31 were  $<18$  years of age. Clinical characteristics of these 31 children are compared with the adult cohort in Table 13.5.

#### *Induction therapy*

Thirty (97%) patients achieved CR at the end of induction. One patient died of sepsis and central nervous hemorrhage during induction. Of the eight patients who were randomized to ATRA  $\rightarrow$  CT, CT was commenced early in two patients prior to confirmation of CR because of increasing WBC counts.

ATRA syndrome occurred in four patients, three of whom had a high presenting WBC count ( $>8.9 \times 10^9/l$ ,  $9 \times 10^9/l$ ,  $101 \times 10^9/l$ ) while the remaining patient had been randomized to ATRA + CT. ATRA was discontinued in three of the four patients. All received dexamethasone (5–23 days) and all four achieved CR at the end of induction.

#### *Post-remission outcome*

As shown in Figure 13.7 two patients died and two received bone marrow transplantation (BMT) (syngeneic and autologous) prior to maintenance therapy. Of the remaining 27 patients eligible for the second randomization, only 21 patients were randomized (no maintenance – 2, ATRA alone – 6, ATRA + CT – 7 and CT alone – 6). Figure 13.8 shows the EFS of the 31 children enrolled on the study.

#### *Protocol violations after randomization*

One patient refused maintenance therapy after randomization and one randomized patient relapsed prior to start of maintenance therapy. The dose of ATRA had to be reduced in two patients because of persistent headaches and in another 10 patients, dose of maintenance CT had to be reduced due to low blood counts and abnormal liver enzymes. No details of the percentage reduction in doses were specified in the report.

Seven of the twenty-nine patients who were in CR at the end of induction subsequently relapsed. One relapse each occurred after syngeneic BMT and prior to start of maintenance therapy while the remaining two

**Table 13.5** Pretreatment characteristics of childhood APL compared with adult ( $\leq 60$  years) APL (APL 93 trial).

Characteristic	Children (<18 years)		Adults ( $\leq 60$ years)		p
	Number	%	Number	%	
Number of patients	31		424		
Male sex	9	29	212	50	0.026
Age (years)	15		43		
	11–16		33–50		
WBC counts ( $\times 10^9/l$ )	6.5		2.9		0.090
	1.4–20.7		1.3–9.4		
$\leq 5.0 \times 10^9/l$	12	39	254	60	
$> 10.0 \times 10^9/l$	15	48	106	25	
Circulating blasts (%)	64		47		0.094
	12–89		10–80		
Platelet count ( $\times 10^9/l$ )	22		30		0.238
	13–47		16–55		
Fibrinogen level (g/l)	1.4		1.6		0.57
	1.0–1.9		1.0–2.4		
Extramedullary disease	1		1		
Organomegaly	6	19	47	11	0.11
Bleeding signs					
Cutaneous	22	76	273	67	0.41
Mucous	17	59	207	51	0.45
At injection sites	12	43	104	26	0.07
Fundus oculi	6	19	47	11	0.19
CNS	1	3	9	2	0.48
Microgranular variant	10	32	57	13	0.014
PML-RAR $\alpha$ breakpoint					0.09
bcr1	6	37.5	74	63	
bcr2	4	25	14	12	
bcr3	6	37.5	29	25	
t(15;17) alone	22/28	79	207/330	63	0.046
t(15;17) + others	3/28	11	89/330	27	

Note: For quantitative variables, data are given as medians and 25th to 75th percentiles.

CNS: central nervous system.

relapses occurred in the non-randomized group who received no maintenance ( $n = 1$ ) or CT alone ( $n = 1$ ). In the randomized group, one patient in the no maintenance arm and two in the ATRA alone group relapsed. None of the seven patients who received ATRA + CT during maintenance relapsed.

Six of the seven relapses were seen in the high WBC count group and four of these occurred in the M3 microgranular variant group. Six patients were reported to be alive in second CR at the time of the publication.

#### Survival outcome

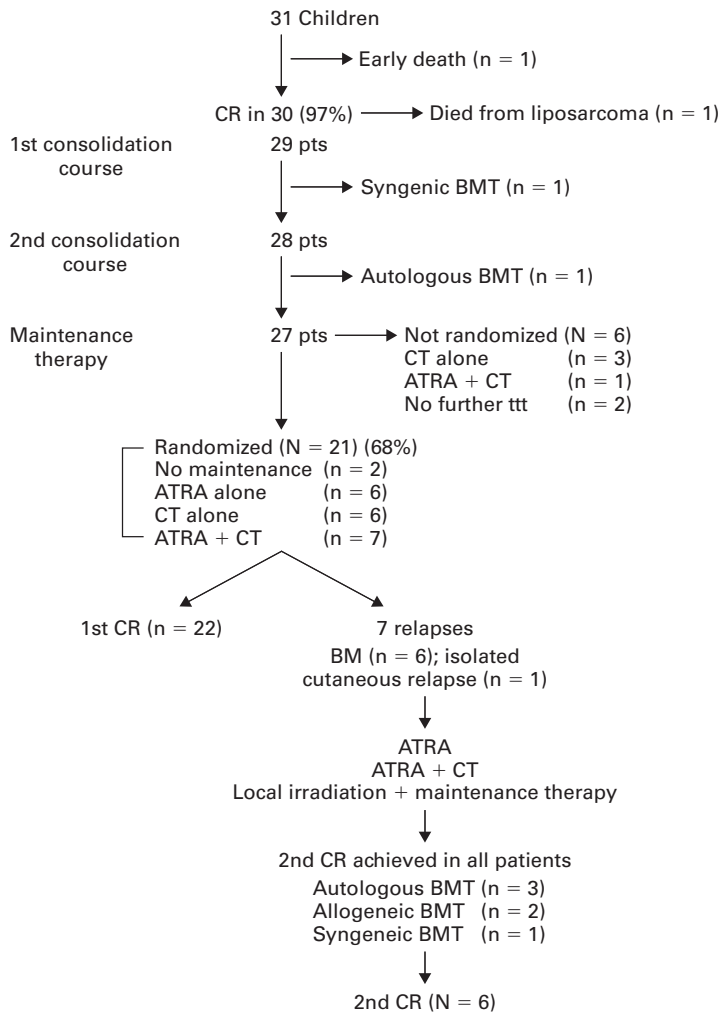
The 5-year EFS, RFS and OS were 71% (range, 62.5–80%), 27% (range, 9–45%) and 90% (range, 80–100%), respectively (Figure 13.8 and Table 13.6).

#### Toxicity

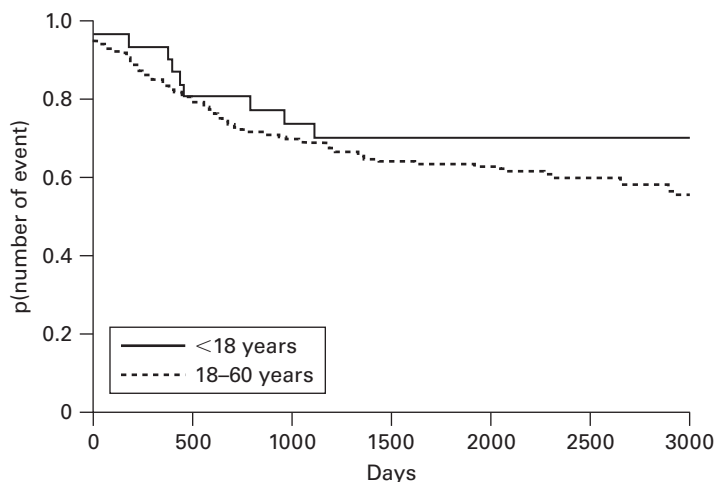
The incidence of ATRA syndrome was comparable in both children (12.9%) and adults (14%,  $p = 0.99$ ) but the incidence of headaches was higher in children (20% versus 9%;  $p = 0.083$ ). Hematological and liver and renal toxicities were similar in both children and adults.

#### Conclusions

It was concluded that ATRA combined with CT in induction and probably also in maintenance provides a favorable outcome in children. No conclusion can be drawn from the randomised comparison due to a small patient number.



**Figure 13.7** Outcome of 31 children treated in the APL 93 trial. © American Society of Clinical Oncology (full reference on p. 258).



**Figure 13.8** EFS of childhood APL compared with adult APL ( $\leq 60$  years). © American Society of Clinical Oncology (full reference on p. 258).

**Table 13.6** Outcome of childhood APL compared with adult ( $\leq 60$  years) APL.

Outcome	Children		Adults $\approx 60$ years		p
	Number	%	Number	%	
Number of patients					
Results of induction treatment					
Complete remission	30	97	392	94	0.99
Leukemic resistance	0	0	1	5	0.25
Early death	1	3	22	5	
ATRA toxicity					
ATRA syndrome	4	13	62	14.6	0.99
Headaches	12	39	135	32	0.083
Pseudotumor cerebri	5	16	1	–	
Number of days with fever $>38^{\circ}\text{C}$					
		7		9	0.108
		3–11		4–15	
Recovery from aplasia, number of days after the onset of DNR-ARA-C					
Leukocytes $>1 \times 10^9/\text{l}$		19		18	0.785
		10–23		13–23	
Neutrophils $>0.5 \times 10^9/\text{l}$		21		22	0.747
		16–25		16–26	
Platelets $>50 \times 10^9/\text{l}$		21		21	0.89
		19–26		19–24	
5-year event-free survival					
%		71		68	0.418
95% CI		62.5–80		62–72	
5-year relapse rate					
%		27		28	0.956
95% CI		9–45		23–33.5	
5-year survival					
%		90		77	0.103
95% CI		80–100		72–81	

Note: For quantitative variables, data are given as medians and 25th to 75th percentiles.

## Study 4

Testi AM, Biondi A, Lo Coco F, Moleti ML, Giona F, Vignetti M, Menna G, Locatelli F, Pession A, Barisone E, De Rossi G, Diverio D, Micalizzi C, Arico M, Basso G, Foa R, Mandelli F. GIMEMA–AIEOP AIDA protocol for the treatment of newly diagnosed acute promyelocytic leukemia (APL) in children. *Blood* 2005; 106: 447–453.

### Study design

GIMEMA–AIEOP AIDA trial (January 1993 to January 2000) was a prospective multi-center randomized study for the treatment of children and adults with newly diagnosed acute promyelocytic leukemia (APL). The methodology of randomization was not specified

in the report. Written informed consent was obtained for all enrolled study patients.

### Objectives

The main aims of the study were:

- To determine the efficacy of all-*trans* retinoic acid (ATRA) combined with idarubicin (AIDA) in inducing durable complete remission (CR) in patients with newly diagnosed APL.
- To evaluate the benefit of maintenance chemotherapy in APL

The focus of this review is on the role of maintenance therapy in APL.

## Study details

### Study population

All patients over the age of 1 year with newly diagnosed APL were eligible for enrollment. The diagnosis of APL was confirmed either by molecular genetics or cytogenetic evidence of PML-RAR $\alpha$  fusion.

Inclusion criteria for enrollment were: (1) no previous cardiac dysfunction, (2) <3 times the upper normal limit of serum creatinine, (3) serum alkaline phosphatase <3 times the upper limit and (4) serum alanine aminotransferase/aspartate aminotransferase (ALT/AST) <3 times the upper limit and (5) WHO performance status <4.

### Treatment

#### Induction therapy

Consisted of oral all-*trans* retinoic acid (ATRA) (25 mg/m<sup>2</sup>/day) combined with intravenous infusion of idarubicin 12 mg/m<sup>2</sup> (IDA) on days 2, 4, 6 and 8. ATRA was continued until the child achieved complete hematological remission (HCR) or for a maximum of 90 days.

#### Consolidation

All patients who achieved HCR received three consolidation courses of IV infusion of cytarabine (ARA-C) 1 g/m<sup>2</sup>/day on days 1–4 along with IV IDA 5 mg/m<sup>2</sup>/day on days 1–4 (course 1); IV mitoxantrone (MTZN) 10 mg/m<sup>2</sup>/day on days 1–5 and IV etoposide 100 mg/m<sup>2</sup> on days 1–5 (course 2); IV IDA 12 mg/m<sup>2</sup> on day 1, ARA-C 150 mg/m<sup>2</sup>/8 hourly subcutaneously on days 1–6 and 6-thioguanine (6-TG) 70 mg/m<sup>2</sup>/8 hourly on days 1–5 (course 3). Commencement of each consolidation course was blood count dependent (i.e. when neutrophils (ANC) > 1.5 × 10<sup>9</sup>/l and platelets (PLTS) > 100 × 10<sup>9</sup>/l).

#### Maintenance

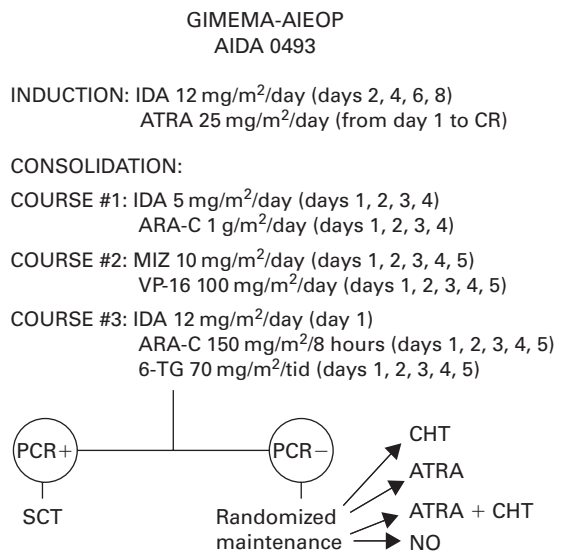
Patients in molecular remission (polymerase chain reaction (PCR) negative for the PML-RAR $\alpha$  transcript) after the third consolidation course were randomized to one of four maintenance arms: (1) daily oral mercaptopurine (90 mg/m<sup>2</sup>) with weekly intramuscular methotrexate (15 mg/m<sup>2</sup>); (2) ATRA 45 mg/m<sup>2</sup>/day for 15 days every 3 months; (3) arm 1 for 3 months followed by arm 2 for 15 days and (4) no therapy. Each of the maintenance arms had to be repeated for a total of

2 years. From April 1997, randomization arms 1 and 4 were closed and all subsequent patients were randomized to either arm 2 or 3. Patients who had persistent disease at the molecular level at the end of consolidation (i.e. PCR positivity for the PML-RAR $\alpha$  transcript) were eligible for allogeneic or autologous stem cell transplantation. No patient received central nervous system (CNS) prophylaxis. Figure 13.9 shows the GIMEMA–AIEOP treatment schema.

Bone marrow (BM) morphological response to treatment was performed at the following time points: at the end of induction, before each consolidation block, prior to commencement of maintenance after the third consolidation block, 3 monthly during the first year of maintenance and 4 monthly from the second year till the fifth year. Additionally, BM samples were also tested molecularly (PCR positivity for the PML-RAR $\alpha$  transcript) for persistent disease prior to start of maintenance, at each morphological evaluation during maintenance and at 5 years after completion of therapy.

### Outcome end points

The main end points were event-free survival (EFS) and overall survival (OS) calculated from the date of diagnosis and hematological disease-free survival (DFS) calculated from the date of achievement of



**Figure 13.9** GIMEMA–AIEOP treatment schema.

Reproduced with permission of the American Society of Hematology (full reference on p. 262).

morphological remission (HCR). Death at any time and hematological relapse were considered events for EFS while deaths in HCR and hematological relapse were considered events for hematological DFS.

### Statistics

OS, EFS and DFS were calculated according to the Kaplan–Meier method. Group comparisons were performed by the log rank test. Molecular relapses were censored for EFS and the hematological DFS curves.

### Outcome

Of the 124 patients enrolled on trial, 14 were excluded from the study (10 – no molecular or cytogenetic data, 2 – PML-RAR $\alpha$  negative, 1 – poor performance status and 1 – incorrect diagnosis). Clinical characteristics of the remaining 110 children are shown in Table 13.7.

**Table 13.7** Clinical and biological features of the 110 children at diagnosis

Median age (years)	11, 6
Range	1, 4–17, 9
<2 Years	1
Sex	
M/F	55/55
FAB	
M3	98
M3 <sub>v</sub>	12
Fever	
Yes	46
No	62
Not available	2
Hemorrhages	
Yes	78
No	30
Not available	2
Median WBC $\times 10^9/l$	3.95
Range	0.3–180
$\leq 10.0$	72
$> 10.0$	38
Median PLT $\times 10^9/l$	20.0
Range	3.0–48.0
$\leq 40.0$	87
$> 40.0$	20
Not available	3*
Type of PML-RAR $\alpha$ transcript	
bcr1	55
bcr2	5
bcr3	36
Not available	14

\*Platelet number at diagnosis was missing in three patients. Of these, two patients had WBC  $> 10 \times 10^9/l$ .

### Induction

Only 107 patients were evaluable for response as 3 were excluded because of major protocol violations; 103 (96%) patients achieved HCR at the end of induction; 4 patients died during induction (3 due to intracerebral hemorrhage and 1 due to severe infection). Definite ATRA syndrome was seen in 2 patients while a further 6 patients developed probable ATRA syndrome.

### Post-remission therapy (consolidation phase)

Two of the 103 patients who achieved HCR after induction received non-protocol consolidation therapy and were excluded from analysis. All remaining 101 patients proceeded to consolidation treatment as scheduled. Six did not complete their scheduled three consolidation blocks due to therapy-related toxicity. Of the 95 patients who completed the entire consolidation cycle, 91 were confirmed to be PCR negative for the PML-RAR $\alpha$  transcript prior to start of the maintenance phase of therapy (three patients – PML-RAR $\alpha$  positive while one was not tested).

### Maintenance phase

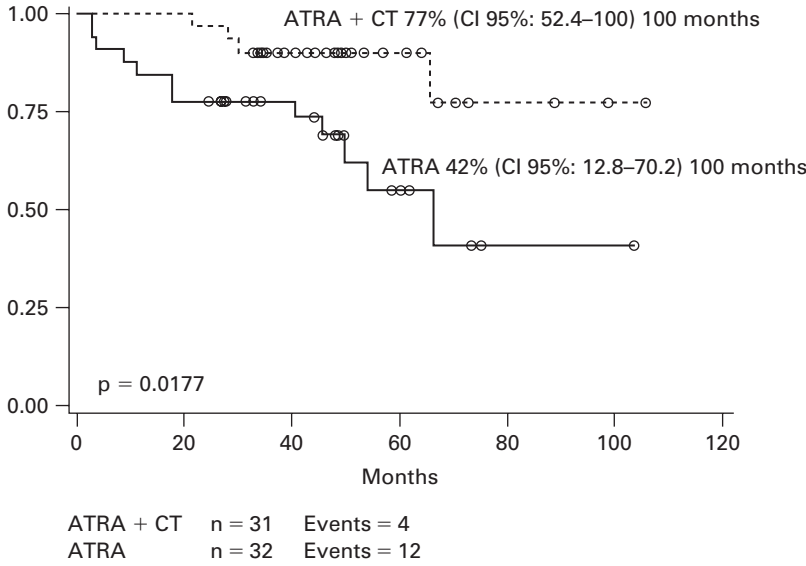
Of the 91 children who were PCR negative at the end of consolidation (PML-RAR $\alpha$  transcript negative), only 85 underwent maintenance randomization; 31 were randomized to the ATRA + CT (chemotherapy) arm and 32 to the ATRA alone arm. The molecular DFS for children randomized to ATRA + CT arm was significantly better compared to the ATRA alone arm (77% versus 42%;  $p = 0.01$ ) (Figure 13.10). All patients randomized to the four maintenance arms received treatment as scheduled. As randomization to the other two maintenance arms was closed early, comparison was not possible between the four maintenance arms because of small patient numbers.

### Survival outcome

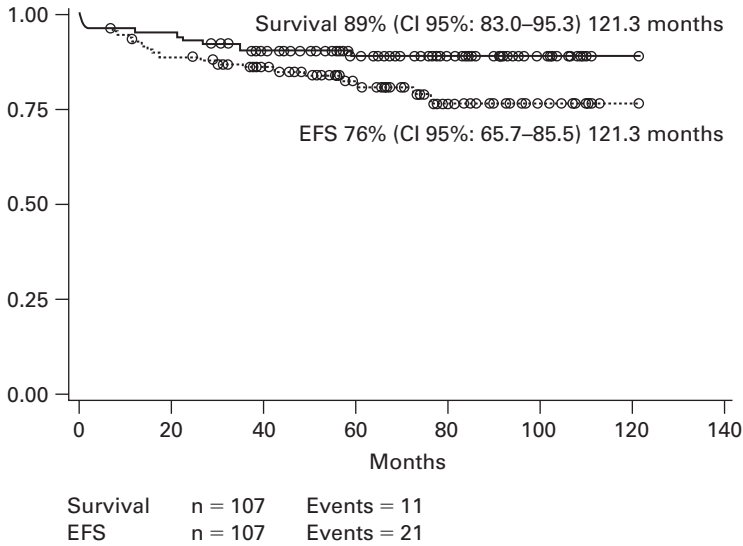
The 10-year OS and EFS for the entire cohort of 107 children were 89% (95% CI 83–95.3%) and 76% (95% CI 65–85%), respectively (Figure 13.11). Even when all 110 patients were included in the survival analysis, the OS remained identical at 89% (95% CI 83.4–95.4%).

### Protocol violations after randomization

One patient refused maintenance therapy after randomization and one randomized patient relapsed prior to start of maintenance therapy. The dose of



**Figure 13.10** “Molecular” DFS probability from randomization according to the maintenance arm assigned: ATRA vs. ATRA + CT. Reproduced with permission of the American Society of Hematology (full reference on p. 262).



**Figure 13.11** The 10-year OS and EFS probability for the whole cohort of patients. Reproduced with permission of the American Society of Hematology (full reference on p. 262).

ATRA had to be reduced in two patients because of persistent headaches and in another 10 patients, dose of maintenance CT had to be reduced due to low blood counts and abnormal liver enzymes. No details of the percentage reduction in doses were specified in the report.

*Toxicity*

The incidences of toxicities during induction and consolidation phases are shown in Tables 13.8 and 13.9. The ATRA syndrome was not seen in any child randomized to the ATRA arms of the maintenance therapy.



**Table 13.8** Induction toxicity.

ATRA related toxicity	Number of patients*
ATRA syndrome	
Definitely present	2
Indeterminate	6
Hypotension	5
Pleural/pericardial effusion	4
Dyspnea	1
Pseudotumor cerebri	10
Severe headache	14
Severe bone pain	5
Skin, mucosal dryness	6
Cheilitis	15
Hypercholesterolemia	10
Other toxicities (WHO $\geq$ 2)	
Hemorrhage	7
Pulmonary	1
Liver	3
Cardiac	2
Renal	1
Mucositis	11
Infections	27

\*The numbers are indicative of the patients who experienced each toxicity. The total number of patients who experienced at least one episode of toxicity is 29.

**Table 13.9** Consolidation toxicity (WHO  $\geq$  2).

Cycle 1	Infections: 20 patients (sepsis 9, pneumonia 4) Mucositis: 7 patients
Cycle 2	Infections: 17 patients (sepsis 10) Mucositis: 10 patients Liver: 1 patient
Cycle 3	Infections: 7 patients Mucositis: 1 patient

### Conclusion

It was concluded that ATRA combined with CT during maintenance improved survival outcome in children with APLM compared to ATRA alone. No conclusion could be made regarding the advantage of maintenance due to early closure of the control arm.

# Childhood lymphoblastic leukemia

Commentary by Vaskar Saha and Judith Chessells

## Introduction

These are exciting times for those treating children with acute lymphoblastic leukemia (ALL). Since the publication of the last edition of this book, the outcome on frontline protocols has significantly improved<sup>1</sup> and rational clinical approaches have been devised for those who relapse.<sup>2,3</sup> Key to this success has been the early identification of groups most likely to fail therapy, and in offering them more intensive chemotherapy.<sup>4</sup> Large clinical trials using this risk-stratified approach to childhood ALL have identified those in whom available chemotherapeutic agents are unlikely to achieve a long-term remission.<sup>5</sup> In this high risk group, allogeneic transplantation appears to provide a better outcome,<sup>6,7</sup> though at a much higher cost, with recurrence of disease still remaining the major problem. None of these strategies have been successful in children who fail to go into remission after induction.<sup>2,3,8</sup> This suggests that further intensification of treatment is unlikely to improve outcome any further.

In a sense, the difficult end game that we have now reached in childhood ALL is a product of the success achieved so far. No new drugs have entered into mainstream clinical trials over the last three decades. We were fortunate that many of the early chemotherapeutic agents identified were effective in the management of childhood ALL. The marked improvement in outcome has been achieved by fine-tuning of the delivery of these drugs and their combinations, mostly by “trial and error” rather than by understanding the mechanisms of response to therapy. These observations have been made from carefully conducted, large-scale randomized clinical studies. Conducted at national or international level, they have accrued the numbers of patients required to achieve sufficient sample size and

statistical power. Over the decades this approach has inevitably resulted in complicated, prolonged and intensive treatment regimens which nevertheless are highly effective. As these results are based on observation rather than understanding, we are faced with two problems: the first is, given the high success rate of current therapeutic approaches it is difficult to foresee any new intervention that will allow us to decrease the intensity or shorten the duration of treatment significantly. The second problem is perhaps that the numbers of children who fail therapy are small and they form a heterogeneous group. Thus the present strategy of using large-scale randomized clinical trials to identify the best therapeutic option is no longer applicable. The next generation of clinical trials needs innovative designs and analytical approaches that will include target validation. This requires a better understanding of the biological basis of the variations in response to therapy.

We are easing into this new era. The sensitivity of the polymerase chain reaction is being used in mainstream clinical trials to identify more accurately not only those who may benefit from more intensified therapy but also to decrease therapy in a small subset of children. Systems biology is being used to understand the origins and behavior of a leukemic cell. The small molecule, imatinib, has entered phase III clinical trials in children with Philadelphia positive (Ph+) ALL.<sup>9,10</sup> Gene expression analysis has identified *FLT3* as possible target in children with an *MLL* gene rearrangement.<sup>11,12</sup> Further pathway analysis has suggested that antagonists of the m-TOR (mammalian Target Of Rapamycin) pathway are potential therapeutic agents for childhood ALL.<sup>13</sup> Thus for the pediatric oncologist a new era begins with the availability of molecules designed to target leukemia-specific

pathways and the tools to measure their effect. How will we identify which of these drugs and targets are most likely to benefit our patients? How will we then examine the evidence that these drugs alone or in combination will help us improve our current results? These are the challenges of tomorrow.

Space does not permit a detailed critique of all the trials which have been reviewed here. Selected trials which illustrate important aspects of management will be briefly discussed.

## CHAPTER 14

### Induction

Over 95% remission induction rates can be achieved in children with ALL by using a combination of steroids, vincristine and L-asparaginase.<sup>14</sup> In older children, those presenting with a higher white cell count and those with high risk cytogenetic subtypes, the addition of anthracycline during induction appears to improve overall outcome.<sup>15</sup> The biggest variability offered is in the type and dose of steroids and L-asparaginase. This has been the focus of great interest in the last few years and forms the basis of discussion in this evidence-based review.

### Steroids

All current protocols for childhood ALL use steroids during the 4-week remission induction period. In the current trials of the Berlin–Frankfurt–Münster (BFM) group, therapy for all patients starts with a 7-day monotherapy with prednisolone and one dose of intrathecal methotrexate (IT MTX) on day 1.<sup>16</sup> About 90% of patients show a rapid decline of leukemic cells with peripheral blood blast counts of  $<1 \times 10^9/l$  by day 8, and are defined to have a prednisolone good response. These patients have a favorable outcome as compared to those who have a prednisolone poor response. Thus steroids are one of the most important drugs in the therapeutic armamentarium of childhood ALL.

The lysis of leukemic cells is initiated by binding of steroids to the group of glucocorticoid receptors.<sup>17–19</sup> Thus clearly the most effective steroids will be those which have primary glucocorticoid as opposed to mineralocorticoid activity. These include the commonly

used prednisone (or prednisolone) and dexamethasone; and the more rarely used methylprednisolone and cortivazol.<sup>20</sup> As each of these drugs has different glucocorticoid activity, they may also vary in potency. Furthermore optimal leukemia cell killing requires saturation of the glucocorticoid receptors for at least 24 hours. Therefore the dose and half-life of steroids used may also influence response. *In vivo* and *in vitro* studies suggest considerable cross-resistance to steroids. Dexamethasone shows better penetration into the cerebrospinal fluid (CSF),<sup>21</sup> and a superior cytotoxicity not explained fully by the conventional 6:1 to 7:1 ratio of glucocorticoid activity.<sup>22</sup> Although event-free survival (EFS) was similar, the Cancer and Leukemia Group B (forerunner of the Pediatric Oncology Group) found that children randomly assigned to dexamethasone had a lower central nervous system (CNS) relapse rate than those assigned to prednisone.<sup>23</sup> The Dutch ALL Study VI and Dana Farber Consortium (DFC) replaced prednisone with dexamethasone and found better outcomes than a historical control.<sup>24,25</sup> However the DFC also reported a 42% incidence of sepsis in children receiving dexamethasone during induction.<sup>26</sup>

Many chemotherapy regimens which use prednisolone as the drug of choice for induction use dexamethasone during intensification. This makes the evaluation of the effect of steroids on outcome a difficult one. Of the studies that are better equipped to answer this question, Study 2 illustrates the problems of making conclusions on underpowered observations. Studies 3 and 4 using essentially the same protocol<sup>1</sup> show that EFS was significantly improved in children who received dexamethasone compared to those who received prednisolone. Dexamethasone also appears to decrease the incidence of extramedullary relapse. Reassuringly, while dexamethasone has a higher incidence of side effects, neither of these studies nor Study 5 showed an increased mortality in those who were treated with dexamethasone. However, Study 5 showed no significant difference in outcome between those randomized to dexamethasone or prednisolone in the Tokyo Children's Cancer Study Group L95-14 protocol. The numbers are fewer than in Studies 3 and 4, but nevertheless sufficient to have shown a difference. This protocol differs in being more intensive than those used by Studies 3 and 4 with the use of both high dose methotrexate and high dose cytarabine which may have compensated for the steroid effect.

Though lymphoblasts show cross-resistance to glucocorticoids,<sup>27</sup> there is evidence to suggest that resistance can be overcome by a higher dose.<sup>28</sup> Study 1 uses this approach by randomizing patients to either receive high dose methylprednisolone or prednisolone orally. The study shows significant increase in EFS for those who received methylprednisolone, particularly in for those in the high risk group. While one would expect increased toxicity in the high dose arm, as observed with dexamethasone, these were tolerable. However, the survival rate is considerably lower than those reported for contemporary protocols and thus the potential effect of methylprednisolone is difficult to evaluate.

### L-asparaginase

The drug L-asparaginase is the only enzyme used in the treatment of ALL. Our current understanding is L-asparaginase depletes the body of the amino acid asparagine.<sup>29</sup> As lymphoblasts cannot synthesize asparagine *de novo*, protein synthesis is disrupted and apoptosis induced.<sup>30</sup> In support of this theory, leukemic blast cells that express high levels of asparagine synthetase (AS) appear to be resistant to the drug.<sup>31</sup> However some leukemic blasts that over-express AS also show an increased sensitivity to L-asparaginase.<sup>32</sup> Thus other mechanisms, including L-asparaginase mediated depletion of glutamine and altered protein synthesis may be responsible for its action.<sup>33,34</sup>

The primary source of this enzyme for therapeutic purposes has been from the two bacterial species, *Escherichia coli* or *Erwinia chrysanthemi*. Initially an *E. coli* product (Crasnitin, Bayer, Leverkusen, Germany) was used as first-line and the *Erwinia* derivative (Erwinase, Speywood, Maidenhead, UK) as second-line treatment for those with an allergic reaction to the *E. coli* preparation. Inactivating antibodies are not cross-reactive between the two derivatives<sup>35</sup> and therefore it is possible to give Erwinase to those allergic to an *E. coli* derivative. This approach, widely used, has been shown to have no adverse effect on outcome.<sup>36</sup> In the 1990s the unavailability of Crasnitin led to many European countries to adopt Erwinase as frontline therapy, with the same dosage and schedule, though another *E. coli* product, manufactured by Kyowa-Hakko and marketed by Medac (Medac, Hamburg, Germany) also became available at that time and was used front-line by the BFM group.<sup>37</sup> The BFM group also set up a drug monitoring system to evaluate the occurrence of

allergic reactions and a more detailed evaluation of the drug became possible.

At equal doses, Erwinase was shown to be less toxic than *E. coli* preparations.<sup>38,39</sup> The most severe toxicities associated with L-asparaginase are hypersensitivity, pancreatitis and an association with thrombosis. Both Studies 7 and 8 report that Erwinase has a significantly lower effect on coagulation. However in practice, on most clinical trials this is not a significant problem. At similar doses, Erwinase has shorter half-life,<sup>40</sup> and asparagine depletion is less effective and lasts for a shorter duration<sup>37</sup> than when *E. coli* products are used. Unsurprisingly, when used at the same dosage and schedule the outcome with Erwinase is inferior to that obtained with *E. coli* asparaginase.<sup>39</sup> This is described in Study 7, that was randomized and sufficiently powered to answer this question. Even within the *E. coli* derivatives, probably as a result of the different manufacturing processes used, there is a difference in activity, but not as pronounced as the differences between the *E. coli* and *Erwinia* products.<sup>37</sup> Different asparaginase products are, therefore, not directly interchangeable in a clinical context. However, knowledge of the pharmacokinetics allows adjustments to be made. Thus the asparagine depletion and asparaginase activity of Erwinase can be approximated to that seen with the *E. coli* product by increasing the dose and decreasing the time intervals between doses.<sup>41</sup> Whether this will translate to clinical efficacy needs to be evaluated. Erwinase has not been available for a number of years though at the time of the writing of this chapter it is once again available for clinical use.

Given that prolonged asparagine depletion is desirable, long acting formulations of L-asparaginase are also in clinical practice. This has been achieved by conjugating polyethylene glycol (PEG) to native *E. coli* L-asparaginase. Two products, pegylated by Enzo, are available. In the United States, Oncospar (Enzon, Bridgewater, NJ) is the pegylated product of Elspar (Merck, Whitehouse, NJ) and in Europe it is the pegylated version of Medac *E. coli* asparaginase. The method of pegylation as well as the *E. coli* strain is different in the Medac product available in Europe and therefore the two products may have different properties.<sup>42</sup> This may have resulted in the slightly different observations made in Study 6, when compared to previous analyses by the BFM group.<sup>42,43</sup> PEG asparaginase produces asparagine depletion with fewer doses<sup>42</sup> and is thought

to be associated with less overt allergic reactions, though there may be an increased incidence of silent antibody formation.<sup>44</sup> The efficacy of the drug may also depend on its route of administration. In the BFM protocols it is given intravenously while in other protocols it is given intramuscularly. In United Kingdom, both frontline and salvage childhood ALL protocols now use PEG asparaginase as first-line therapy. A new recombinant L-asparaginase, which forms an octamer rather than the traditional tetramer, is currently undergoing phase II trials.

## Conclusions

Virtually all children with ALL will achieve remission. Thus the only question that can be asked about induction therapy is whether the better use of current agents or additional drugs will improve EFS. Induction also provides an opportunity to test whether new drugs or combinations are as effective as initial treatment – the so-called “window” studies. The emphasis clearly has moved on to the intensity of post-induction therapy during the first few months of treatment and its impact on EFS.

## Intensification

A strategy, more established in ALL than AML (acute myeloid leukemia), is the use of “risk adapted” therapy; that is, delivering more intensive therapy to patients at higher risk of treatment failure. Although there are problems in risk group stratification,<sup>45</sup> it is clear that some children with ALL have a higher risk of relapse than others. These include infants, older children, those with a high leukocyte count at presentation, some cytogenetic subtypes and a slow response to induction therapy. Age and presenting white blood cell (WBC) count formed the basis of a simple and universally applicable basis for stratification developed by the Rome consensus,<sup>46</sup> and later refined by the National Cancer Institute (NCI).<sup>47</sup> The benefit of such a consensus is that it enables international comparisons of outcome without relying on the results of more sophisticated investigations.

It seemed intuitive that increasing the intensity of treatment could reduce the chances of relapse in those patients at high risk of relapse on “standard therapy”.

This concept had been tried and failed in earlier studies (perhaps because treatment was not sufficiently aggressive) but the BFM group showed that more intensified treatment did benefit these patients, albeit when compared with historical controls.<sup>16</sup>

The Children’s Cancer Group (CCG) in the United States has performed prospective randomized trials which showed that intensive therapy cured more high risk children than standard therapy.<sup>48</sup> Furthermore they were able to show that in high risk children with a slow response to induction, post-induction intensification of treatment improved outcome.<sup>49</sup> The results of these trials have been confirmed by both randomized and comparative studies performed by other collaborative groups. Children at a lower risk also benefit from intensification of therapy. In a small randomized trial the BFM group attempted to decrease therapy in a subset of lowest risk children with a consequent increase in late marrow relapses.<sup>50,51</sup> The AEIOP group had a similar experience in a non-randomized study.<sup>52</sup> The CCG<sup>53</sup> and the Medical Research Council (MRC)<sup>54</sup>, on the other hand, randomized the so-called “average risk” children and all children respectively to receive or not, further intensification therapy. Results confirm that the addition of blocks of intensified therapy during the first few months improves EFS in all children with ALL. Analysis of randomized trials of intensive re-induction therapy in seven trials including 3696 patients showed a highly significant reduction in the risk of relapse and a smaller but significant improvement in survival (Chapter 16, Study 8).

## Conclusions

Twenty-five years ago, some 35–40% of children could be cured after induction therapy, CNS directed treatment and simple continuing (maintenance) therapy with oral mercaptopurine and methotrexate, often with some type of periodic addition of prednisolone and vincristine. Survival has been doubled by the introduction of intensification therapy for all children and a more aggressive chemotherapeutic approach to those at higher risk of treatment failure. This blunderbuss therapy has been empirical but successful. There is now the prospect that widespread use of molecular genetics may allow a more sophisticated approach to treatment. Cytogenetic analysis can identify some patients

with “standard risk” features who are at high risk of treatment failure, e.g. those with Ph+ leukemia.<sup>10</sup> Persistent minimal residual disease after the first few months of treatment is highly predictive of subsequent relapse.<sup>55</sup> This type of investigation should help in more sophisticated prediction of relapse risk and thus allows more individualized treatment for many children and less toxic treatment for some at least.

## CHAPTER 15

### CNS directed therapy

While the use of combination chemotherapy, in the 1960s and 1970s, led to prolonged hematological remissions in children with ALL, up to 80% of children relapsed, primarily in the CNS. While CNS disease could be controlled with weekly injections of IT MTX it was almost always followed later by a bone marrow relapse.<sup>56</sup> More than 30 years ago randomized trials showed that children with ALL in remission who received short course of IT MTX injections (Studies 10 and 15) had a lower CNS relapse rate and ultimately a better survival than those who did not receive presymptomatic CNS directed therapy.<sup>57,58</sup> Since the early 1970s CNS directed therapy, often termed “CNS prophylaxis”, was introduced. Radiotherapy had previously proved effective in the control of overt CNS disease and early trials include craniospinal irradiation.<sup>59</sup> A dose of 24 Gy was found to be effective, though craniospinal irradiation proved to be myelosuppressive and this was replaced with cranial irradiation and continuing IT MTX.<sup>60</sup> This strategy was adopted by trial groups worldwide.<sup>61,62</sup>

A number of studies began to report on neuropsychological sequelae ascribed to cranial irradiation and a number of modifications were attempted. Comparative studies of children with ALL and those with brain tumors who had received cranial irradiation show a relationship between the dose of radiation and the degree of neuropsychological impairment, girls and younger children appearing to be more vulnerable. The contribution of cranial irradiation to this problem in children with ALL is difficult to evaluate, as both dexamethasone and intrathecal therapy also adversely affect neurocognitive function. Cranial irradiation is, however, clearly linked with the risk of premature precocious puberty, growth retardation and the occurrence

of secondary brain tumors. In an attempt to decrease the long-term effects of cranial irradiation, the radiation dose was decreased from 24 to 18 Gy<sup>63–65</sup> and even to 12 Gy.<sup>66</sup> Though these doses appeared to be as effective in preventing CNS recurrence, they did not decrease toxicity. Study 6 tested the hypothesis that hyperfractionation of the radiation dose could decrease long-term toxicity. This did not prove so and curiously there was an increase in the non-CNS relapse rate in those treated with hyperfractionated radiotherapy. Subsequent randomized trials showed that, after an initial course of IT MTX injections, regular IT MTX throughout therapy was as effective as cranial irradiation in standard (Study 11) and intermediate risk (SR and IR, respectively) (Study 17) children, and even in those higher risk children with ALL who showed a satisfactory early response to induction therapy (Study 20). Though the meta-analyses presented in Study 24 suggest that there is no overall evidence for the benefit of irradiation over IT MTX, there is controversy as to whether selective high risk patients may benefit.<sup>67,68</sup> Thus, while some trials no longer use cranial irradiation in all children with ALL in first remission,<sup>1,69</sup> others like the BFM have restricted its use to high risk ALL.<sup>66</sup>

We do not understand the mechanisms of why some children develop disease in the CNS. Pathological studies suggest that leukemic cells line the walls of arachnoid veins and proliferate slowly. They subsequently infiltrate and destroy the arachnoid trabeculae and penetrate the channels for CSF circulation. As the brain does not have lymphatic tissue, the cells that are detected originate from reticuloendothelial tissue outside the CNS. ALL is a disseminated systemic disease and it is likely that all children have subclinical CNS disease at presentation. The key to preventing CNS disease is the use of effective systemic therapy to eliminate the source of the disease. As many of the drugs used do not penetrate the blood–brain barrier well, the early use of adjunctive intrathecal therapy facilitates the eradication of subclinical or overt CNS disease. We have also begun to appreciate that technical administration of intrathecal medication is important. This requires avoidance of traumatic lumbar punctures and maintaining the patient prone to allow optimal methotrexate levels within the ventricular system.<sup>70</sup>

A number of facts support this hypothesis. Over the previous two decades most trial groups have progressively stopped the use of cranial irradiation for CNS

directed therapy. During the same period, systemic therapy has become more intensive with the use of more frequent intrathecal medication. This approach was pioneered by the Paediatric Oncology Group in the United States<sup>71</sup> and Scandinavian trialists<sup>72,73</sup> who showed that the regular use of intrathecal chemotherapy was as effective as a combination of cranial radiation with IT MTX in preventing CNS relapse. The actual incidence of CNS relapse during this period, where very few children now receive cranial irradiation, has gradually declined in all trials. A further example of the interaction of systemic and CNS directed therapy is shown by the early trial from the Cancer and Leukaemia Group B (Study 15), in which patients randomized to receive dexamethasone during induction and continuing treatment had a lower risk of CNS relapse than those receiving prednisolone. Data from two recent trials suggests that with such a strategy, dexamethasone compared to prednisolone contributes to the decrease in the incidence of CNS relapse.<sup>1,74</sup>

However 2–6% of children still relapse in the CNS on current chemotherapeutic regimens.<sup>1,25,69,74–76</sup> Another strategy to decrease the incidence of CNS disease that has been explored is the use of high dose intravenous methotrexate. This results in higher levels of methotrexate in the CSF and it was thought that this would provide better CNS protection. High dose intravenous methotrexate therapy, in doses ranging from 500 mg to 33 g/m<sup>2</sup>, has been evaluated in treatment of ALL, both for its CNS protective effects and for prevention of relapse at other sites. It has formed a mainstay of treatment in many countries, notably Scandinavia.<sup>77</sup> However the MRC UKALL-XI trial failed to demonstrate any survival advantage of high dose intravenous methotrexate over IT MTX.<sup>78</sup> A number of other studies have also shown however that there is no significant overall benefit of high dose methotrexate over IT MTX (summarized in Study 24). Therefore it is unsurprising that Study 25 found that the combining high dose cytarabine with high dose methotrexate increased toxicity without improving outcome.

Thus intrathecal therapy clearly seems to be the best option for CNS directed therapy. As stated previously it is essential to institute this early, during induction and consolidation. Whether it needs to be given subsequently during continuing therapy remains unclear. The CNS relapse rates remain similar in those who continue to receive IT MTX, such as the MRC and COG

(Children's Oncology Group), when compared those who do not as in the BFM. There is also no evidence to suggest that triple intrathecal (steroid and cytarabine in addition) is superior to the use of methotrexate alone. In CCG 1952 children were randomized triple intrathecal versus IT MTX. Triple intrathecal provided greater CNS effect, but there was a greater non-CNS relapse rate which translated into a significant decrease in overall survival.<sup>79</sup> This maybe related to the systemic effect of IT MTX. Intrathecally introduced methotrexate diffuses into the system in blood stream quite rapidly, probably as a result of the mild arachnoiditis caused by the drug.<sup>80</sup> The steroid present in triple intrathecal therapy may decrease the arachnoiditis, impairing the permeability of methotrexate.<sup>81</sup>

## Conclusions

Prevention of overt CNS leukemia can be achieved in most children with ALL by intensive systemic therapy and early use of IT MTX. Cranial irradiation and short-term IT MTX therapy are effective but have largely been abandoned because of concerns about the late effects of treatment. It remains uncertain whether there is a small group of high risk patients who may benefit from cranial irradiation. Protocols that include intravenous methotrexate as well as some IT MTX are effective but the additional benefit provided by the intravenous methotrexate is uncertain. Thus in childhood ALL, intensive systemic chemotherapy, the use of oral dexamethasone and the early use of carefully introduced IT MTX appear to be the best strategy to minimize the risk of CNS recurrence.

## CHAPTER 16

### Continuing (maintenance) therapy

Long-term, relatively low dose, continuing (maintenance) therapy with daily oral mercaptopurine and weekly methotrexate has been part of treatment of ALL for over 30 years. Usually 6-MP is given daily and methotrexate once weekly.<sup>54</sup> While some groups use monthly pulses of vincristine and steroids, others do not. Continuing treatment is unique to ALL and some types of non-Hodgkin's lymphomas (NHL) (see Chapter 9) but its precise mode of action is unknown.

Continuing treatment is immunosuppressive and in an attempt to decrease the risk of serious infections MRC UKALL-V randomized lower risk children to receive mercaptopurine and methotrexate continuously, for 3 weeks in every 4, or pulsed over 5 days every 3 weeks throughout maintenance. In the study 496 children were randomized and the EFS at 7 years was 48% in patients who received continuous treatment, 46% after semi-continuous treatment and only 35% in the group who received pulsed treatment (Study 15). By contrast, pulsed therapy was associated with a lower relapse rate than continuous therapy in a trial performed by the Japanese Children's Cancer Study Group (Study 14). This trial, however, involved only 115 patients and the methotrexate was given intravenously rather than orally.

Both methotrexate and mercaptopurine are usually given by mouth during the later phases of continuing treatment. The European Organization for Research and Treatment of Cancer – Children's Leukemia Group (EORTC) trial 58881 included a randomization to replace oral mercaptopurine with intravenous mercaptopurine for 1 week per month during continuing treatment. Intravenous mercaptopurine was associated with a higher relapse rate (Study 16). MRC UKALL-VII (Study 13) compared oral and intramuscular methotrexate during continuing treatment and found a marginally significant benefit for intramuscular methotrexate on analysis by treatment given. Another British trial showed no difference in outcome between the two routes.<sup>82</sup> Both trials were small, with 80 and 144 patients, respectively; hence these results should be interpreted with caution.

A trial from CCG (Study 12) randomized 164 children to standard continuing treatment with or without additional intravenous methotrexate infusions every 6 weeks. The additional methotrexate was not beneficial. Another approach to more complicated continuing therapy was explored in the St Jude Total XI study,<sup>83</sup> which involved a comparison of standard continuing treatment and intensive rotational therapy in SR patients. There was no difference in outcome between the two schedules.

It has been suggested that 6-thioguanine (6-TG), which is more directly activated to TG nucleotides, may be a more effective drug than mercaptopurine. The preliminary report from a randomized trial conducted by the COALL study showed that use of TG was not

superior to mercaptopurine (Study 18). While a subsequent COG study reportedly has shown a survival benefit, in the recently concluded MRC ALL 97/99 study there does not appear to be a difference in outcome in those who received 6-MP from those who received 6-TG. 6-TG is associated with hepatotoxicity<sup>84</sup> and in the United Kingdom is no longer used in the frontline childhood ALL protocol.

The main toxicity during this phase of treatment is myelosuppression. The incidence and severity of this is related to the dose of 6-MP administered and to genetic variations in xenobiotic pathways of thiopurine metabolism, principally in the polymorphisms of the enzyme thiopurine methyltransferase (TPMT).<sup>85,86</sup> The cumulative dose of thiopurine received during the continuation period is predictive of survival.<sup>87,88</sup> Children who never become neutropenic during continuation therapy have a poorer outcome than those who have episodes of neutropenia.<sup>89–92</sup> Thus, the maximum tolerated dose needs to be given. As the dose tolerated varies from time to time in every child, delivering optimal therapy while preventing severe neutropenia and thrombocytopenia requires the routine monitoring of full blood counts and regular dose adjustment. If the dose is escalated too quickly, it will lead to prolonged periods of neutropenia. As therapy needs to be temporarily stopped during this time, this will lead to a decrease in the cumulative dose, and frequent neutropenia is thus associated with an adverse outcome.<sup>87</sup> Regular, minor dose adjustments are preferred. This requires intensive monitoring and scrupulous attention to the dosing schedule. The simplest and most sensitive approach appears to be the measurement of the absolute neutrophil count (ANC) and platelet count on a weekly/fortnightly basis.<sup>93</sup>

It could be argued that, in the era of intensified treatment, there is no role for prolonged maintenance therapy. These considerations lead the Tokyo Children's Cancer Study Group to devise a protocol comprising 6 months of intensive treatment and 6 months of standard oral maintenance. Three hundred and forty-seven children were treated in this way. The relapse rate was high, particularly in lower risk patients,<sup>94</sup> a finding which echoes the outcome of many historic studies when treatment was given for 12–15 months only. There have been many other trials of duration of therapy in ALL with randomized comparisons varying from 3 with 5 years (Study 2) to 18 months with 3 years (Study 1).



In general, these trials have tended to show that shorter treatment is associated with a marginally higher risk of relapse. Sometimes, as in MRC UKALL-I, which compared 18 months with 3 years, these results have achieved statistical significance. Results of all randomized trials of duration of therapy were included in an overview and data on 3861 patients were available (Study 8). Longer maintenance therapy decreased the relapse rate in the first year of treatment but had no benefit on overall survival for three reasons. There was an excess of remission deaths in children continuing chemotherapy, an excess of relapses once those children receiving longer therapy stopped treatment and, at the time of analysis, a better response to salvage therapy in children who had received shorter treatment. These results suggest that some relapses at least are deferred rather than prevented by longer treatment. Analysis by age, sex and WBC count did not demonstrate any different effects of treatments within subgroups. Most groups treat children for a total of 24 months. There is, however, evidence from several large study groups that boys have a higher risk of late relapses than girls. The reason for this difference is unknown, but it has no doubt contributed to the decision by the COG and the MRC treat boys for 36 months, though we do not understand why there is a difference in how boys respond differently to this phase of treatment.

Thus, continuation treatment is clearly an important component of therapy for childhood ALL, though the mechanism remains unclear. What is clear is that continuing therapy requires a minimal tumor burden to be successful. This has led to the interest in the use of additional therapy or escalating doses during this period of therapy. In Study 17, increasing intensity of dosage resulted in more frequent interruptions in girls and an inferior outcome. Though boys received a higher dose, this did not appear to influence outcome. Studies 18, 19 and 21 examined the use of L-asparaginase during continuation therapy. The rationale used was that it would eradicate residual disease without myelosuppression. Both studies report that use of additional L-asparaginase did not improve outcome. However, a subsequent analysis of the second study showed that children with SR, but not with IR, disease benefited from additional L-asparaginase.<sup>52</sup> This may have been because in this trial, children in SR group received reduced treatment when compared to those in the IR group. Thus, L-asparaginase may have compensated for the

decreased intensification by reducing disease bulk further during continuation therapy. The lack of difference in outcome in the IR group who received additional doses of L-asparaginase suggests that further intensification will not improve outcome in these patients.

The role of the vincristine and steroid pulses during this phase of treatment remain unclear. While the COG and MRC use these throughout the duration of treatment and St. Jude uses them for a shorter period of time, the BFM protocols do not use these drugs during maintenance. Given that the therapeutic regimens are different but produce similar survivals, it is difficult to comment on their exact value.

## Conclusion

Continuing (maintenance) therapy remains essential in the management of ALL. None of the manipulations reviewed here have proved superior to the combination of mercaptopurine and methotrexate with or without the periodic pulses of steroids and vincristine. This long-term outpatient-based therapy is more unsupervised than other aspects of treatment. There is evidence that treatment to the level of tolerance reduces the risk of relapse and that compliance may be variable in this, as in other forms of oral treatment.<sup>95</sup> There remains uncertainty about the best length of treatment for lymphoblastic leukemia, but in general it appears that protocols of shorter than 2 years have been associated with more relapses. There have been few recent trials of duration of therapy, and it is possible that length of total treatment in future studies will be influenced by the intensity of initial treatment and by evaluation of minimal residual disease during therapy.

## References

- 1 Mitchell CD, Richards SM, Kinsey SE, Lilleyman J, Vora A, Eden TO. Benefit of dexamethasone compared with prednisolone for childhood acute lymphoblastic leukaemia: results of the UK Medical Research Council ALL97 randomized trial. *Br J Haematol* 2005;129(6):734–45.
- 2 Einsiedel HG, von Stackelberg A, Hartmann R, Fengler R, Schrappe M, Janka-Schaub G, Mann G, Hahlen K, Gobel U, Klingebiel T, Ludwig WD, Henze G. Long-term outcome in children with relapsed ALL by risk-stratified salvage therapy: Results of Trial Acute Lymphoblastic Leukemia – Relapse Study of the Berlin–Frankfurt–Münster Group 87. *J Clin Oncol* 2005;23(31):7942–50.

- 3 Roy A, Cargill A, Love S, Moorman AV, Stoneham S, Lim A, Darbyshire PJ, Lancaster D, Hann I, Eden T, Saha V. Outcome after first relapse in childhood acute lymphoblastic leukaemia – lessons from the United Kingdom R2 trial. *Br J Haematol* 2005;130(1):67–75.
- 4 Schrappe M, Camitta B, Pui CH, Eden T, Gaynon P, Gustafsson G, Janka-Schaub GE, Kamps W, Masera G, Sallan S, Tsuchida M, Vilmer E. Long-term results of large prospective trials in childhood acute lymphoblastic leukemia. *Leukemia* 2000;14(12):2193–4.
- 5 Pui CH, Evans WE. Acute lymphoblastic leukemia. *New Engl J Med* 1998;339(9):605–15.
- 6 Balduzzi A, Valsecchi MG, Uderzo C, De Lorenzo P, Klingebiel T, Peters C, Stary J, Felice MS, Magyarosy E, Conter V, Reiter A, Messina C, Gardner H, Schrappe M. Chemotherapy versus allogeneic transplantation for very-high-risk childhood acute lymphoblastic leukaemia in first complete remission: comparison by genetic randomisation in an international prospective study. *Lancet* 2005;366(9486): 635–42.
- 7 Borgmann A, von Stackelberg A, Hartmann R, Ebell W, Klingebiel T, Peters C, Henze G. Unrelated donor stem cell transplantation compared with chemotherapy for children with acute lymphoblastic leukemia in a second remission: a matched-pair analysis. *Blood* 2003;101(10):3835–9.
- 8 Silverman LB, Gelber RD, Young ML, Dalton VK, Barr RD, Sallan SE. Induction failure in acute lymphoblastic leukemia of childhood. *Cancer* 1999;85(6):1395–404.
- 9 Champagne MA, Capdeville R, Krailo M, Qu W, Peng B, Rosamilia M, Therrien M, Zoellner U, Blaney SM, Bernstein M. Imatinib mesylate (STI571) for treatment of children with Philadelphia chromosome-positive leukemia: results from a Children's Oncology Group phase 1 study. *Blood* 2004; 104(9):2655–60.
- 10 Jones LK, Saha V. Philadelphia positive acute lymphoblastic leukaemia of childhood. *Br J Haematol* 2005;130(4): 489–500.
- 11 Stam RW, den Boer ML, Schneider P, Nollau P, Horstmann M, Beverloo HB, van der Voort E, Valsecchi MG, de Lorenzo P, Sallan SE, Armstrong SA, Pieters R. Targeting FLT3 in primary *MLL*-gene-rearranged infant acute lymphoblastic leukemia. *Blood* 2005;106(7):2484–90.
- 12 Brown P, Levis M, Shurtleff S, Campana D, Downing J, Small D. FLT3 inhibition selectively kills childhood acute lymphoblastic leukemia cells with high levels of FLT3 expression. *Blood* 2005;105(2):812–20.
- 13 Avellino R, Romano S, Parasole R, Bisogni R, Lamberti A, Poggi V, Venuta S, Romano MF. Rapamycin stimulates apoptosis of childhood acute lymphoblastic leukemia cells. *Blood* 2005;106(4):1400–6.
- 14 Ortega JA, Nesbit Jr ME, Donaldson MH, Hittle RE, Weiner J, Karon M, Hammond D. L-asparaginase, vincristine, and prednisone for induction of first remission in acute lymphocytic leukemia. *Cancer Res* 1977;37(2):535–40.
- 15 Roy A, Bradburn M, Moorman AV, Burrett J, Love S, Kinsey SE, Mitchell C, Vora A, Eden T, Lilleman JS, Hann I, Saha V. Early response to induction is predictive of survival in childhood Philadelphia chromosome positive acute lymphoblastic leukaemia: results of the Medical Research Council ALL 97 trial. *Br J Haematol* 2005;129(1):35–44.
- 16 Schrappe M, Reiter A, Zimmermann M, Harbott J, Ludwig WD, Henze G, Gardner H, Odenwald E, Riehm H. Long-term results of four consecutive trials in childhood ALL performed by the ALL-BFM study group from 1981 to 1995. Berlin–Frankfurt–Münster. *Leukemia* 2000;14(12):2205–22.
- 17 Kato GJ, Qudus FF, Shuster JJ, Boyett J, Pullen JD, Borowitz MJ, Whitehead VM, Crist WM, Leventhal BG. High glucocorticoid receptor content of leukemic blasts is a favorable prognostic factor in childhood acute lymphoblastic leukemia. *Blood* 1993;82(8):2304–9.
- 18 Pui CH, Dahl GV, Rivera G, Murphy SB, Costlow ME. The relationship of blast cell glucocorticoid receptor levels to response to single-agent steroid trial and remission response in children with acute lymphoblastic leukemia. *Leuk Res* 1984;8(4):579–85.
- 19 Tissing WJ, Meijerink JP, den Boer ML, Pieters R. Molecular determinants of glucocorticoid sensitivity and resistance in acute lymphoblastic leukemia. *Leukemia* 2003;17(1):17–25.
- 20 Styczynski J, Kurylak A, Wysocki M. Cytotoxicity of cortivazol in childhood acute lymphoblastic leukemia. *Anticancer Res* 2005;25(3B):2253–8.
- 21 Balis FM, Lester CM, Chrousos GP, Heideman RL, Poplack DG. Differences in cerebrospinal fluid penetration of corticosteroids: possible relationship to the prevention of meningeal leukemia. *J Clin Oncol* 1987;5(2):202–7.
- 22 Gaynon PS, Lustig RH. The use of glucocorticoids in acute lymphoblastic leukemia of childhood. Molecular, cellular, and clinical considerations. *J Pediatr Hematol Oncol* 1995; 17(1):1–12.
- 23 Jones B, Freeman AI, Shuster JJ, Jacquillat C, Weil M, Pochedly C, Sinks L, Chevalier L, Maurer HM, Koch K, et al. Lower incidence of meningeal leukemia when prednisone is replaced by dexamethasone in the treatment of acute lymphocytic leukemia. *Med Pediatr Oncol* 1991;19(4):269–75.
- 24 Veerman AJ, Hahlen K, Kamps WA, Van Leeuwen EF, De Vaan GA, Solbu G, Suciú S, Van Wering ER, Van der Does-Van der Berg A. High cure rate with a moderately intensive treatment regimen in non-high-risk childhood acute lymphoblastic leukemia. Results of protocol ALL VI from the Dutch Childhood Leukemia Study Group. *J Clin Oncol* 1996; 14(3):911–8.
- 25 Silverman LB, Gelber RD, Dalton VK, Asselin BL, Barr RD, Clavell LA, Hurwitz CA, Moghrabi A, Samson Y, Schorin MA, Arkin S, Declerck L, Cohen HJ, Sallan SE. Improved outcome for children with acute lymphoblastic leukemia: results of Dana-Farber Consortium Protocol 91-01. *Blood* 2001;97(5): 1211–8.
- 26 Hurwitz CA, Silverman LB, Schorin MA, Clavell LA, Dalton VK, Glick KM, Gelber RD, Sallan SE. Substituting dexamethasone for prednisone complicates remission induction in children with acute lymphoblastic leukemia. *Cancer* 2000; 88(8): 1964–9.
- 27 Styczynski J, Wysocki M, Debski R, Balwierz W, Rokicka-Milewska R, Matysiak M, Balcerska A, Kowalczyk J, Wachowiak J, Sonta-Jakimczyk D, Chybicka A. Cross-resistance

- to five glucocorticoids in childhood acute lymphoblastic and non-lymphoblastic leukemia samples tested by the MTT assay: preliminary report. *Acta Biochim Pol* 2002;49(1):93–8.
- 28 Schwartz CL, Thompson EB, Gelber RD, Young ML, Chilton D, Cohen HJ, Sallan SE. Improved response with higher corticosteroid dose in children with acute lymphoblastic leukemia. *J Clin Oncol* 2001;19(4):1040–6.
  - 29 Riccardi R, Holcenberg JS, Glaubiger DL, Wood JH, Poplack DG. L-asparaginase pharmacokinetics and asparagine levels in cerebrospinal fluid of rhesus monkeys and humans. *Cancer Res* 1981;41(11 Pt 1):4554–8.
  - 30 Hannun YA. Apoptosis and the dilemma of cancer chemotherapy. *Blood* 1997;89(6):1845–53.
  - 31 Aslanian AM, Fletcher BS, Kilberg MS. Asparagine synthetase expression alone is sufficient to induce L-asparaginase resistance in MOLT-4 human leukaemia cells. *Biochem J* 2001;357(Pt 1):321–8.
  - 32 Stams WA, den Boer ML, Holleman A, Appel IM, Beverloo HB, van Wering ER, Janka-Schaub GE, Evans WE, Pieters R. Asparagine synthetase expression is linked with L-asparaginase resistance in TEL-AML1-negative but not TEL-AML1-positive pediatric acute lymphoblastic leukemia. *Blood* 2005;105(11):4223–5.
  - 33 Rotoli BM, Uggeri J, Dall'Asta V, Visigalli R, Barilli A, Gatti R, Orlandini G, Gazzola GC, Bussolati O. Inhibition of glutamine synthetase triggers apoptosis in asparaginase-resistant cells. *Cell Physiol Biochem* 2005;15(6):281–92.
  - 34 Ollenschlager G, Roth E, Linkesch W, Jansen S, Simmel A, Modder B. Asparaginase-induced derangements of glutamine metabolism: the pathogenetic basis for some drug-related side-effects. *Eur J Clin Invest* 1988;18(5):512–6.
  - 35 Wang B, Relling MV, Storm MC, Woo MH, Ribeiro R, Pui CH, Hak LJ. Evaluation of immunologic crossreaction of anti-asparaginase antibodies in acute lymphoblastic leukemia (ALL) and lymphoma patients. *Leukemia* 2003;17(8):1583–8.
  - 36 Woo MH, Hak LJ, Storm MC, Sandlund JT, Ribeiro RC, Rivera GK, Rubnitz JE, Harrison PL, Wang B, Evans WE, Pui C-H, Relling MV. Hypersensitivity or development of antibodies to asparaginase does not impact treatment outcome of childhood acute lymphoblastic leukemia. *J Clin Oncol* 2000;18(7):1525–32.
  - 37 Boos J, Werber G, Ahlke E, Schulze-Westhoff P, Nowak-Gottl U, Wurthwein G, Verspohl EJ, Ritter J, Jurgens H. Monitoring of asparaginase activity and asparagine levels in children on different asparaginase preparations. *Eur J Cancer* 1996;32A(9):1544–50.
  - 38 Eden OB, Shaw MP, Lilleman JS, Richards S. Non-randomised study comparing toxicity of *Escherichia coli* and *Erwinia* asparaginase in children with leukaemia. *Med Pediatr Oncol* 1990;18(6):497–502.
  - 39 Duval M, Suciú S, Ferster A, Rialland X, Nelken B, Lutz P, Benoit Y, Robert A, Manel AM, Vilmer E, Otten J, Philippe N. Comparison of *Escherichia coli*-asparaginase with *Erwinia*-asparaginase in the treatment of childhood lymphoid malignancies: results of a randomized European Organisation for Research and Treatment of Cancer – Children's Leukemia Group phase 3 trial. *Blood* 2002;99(8):2734–9.
  - 40 Asselin BL, Whitin JC, Coppola DJ, Rupp IP, Sallan SE, Cohen HJ. Comparative pharmacokinetic studies of three asparaginase preparations. *J Clin Oncol* 1993;11(9):1780–6.
  - 41 Vieira Pinheiro JP, Ahlke E, Nowak-Gottl U, Hempel G, Muller HJ, Lumkemann K, Schrappe M, Rath B, Fleischhack G, Mann G, Boos J. Pharmacokinetic dose adjustment of *Erwinia* asparaginase in protocol II of the paediatric ALL/NHL-BFM treatment protocols. *Br J Haematol* 1999;104(2):313–20.
  - 42 Vieira Pinheiro JP, Lanversa C, Wurthwein G, Beier R, Casimiro da Palma J, von Stackelberg A, Boos J. Drug monitoring of PEG-asparaginase treatment in childhood acute lymphoblastic leukemia and non-Hodgkin's lymphoma. *Leuk Lymphoma* 2002;43(10):1911–20.
  - 43 Vieira Pinheiro JP, Wenner K, Escherich G, Lanvers-Kaminsky C, Wurthwein G, Janka-Schaub G, Boos J. Serum asparaginase activities and asparagine concentrations in the cerebrospinal fluid after a single infusion of 2,500 IU/m<sup>2</sup> PEG asparaginase in children with ALL treated according to protocol COALL-06-97. *Pediatr Blood Cancer* 2005;May 31.
  - 44 Avramis VI, Panosyan EH. Pharmacokinetic/pharmacodynamic relationships of asparaginase formulations: the past, the present and recommendations for the future. *Clin Pharmacokinet* 2005;44(4):367–93.
  - 45 Chessells JM. Risk analysis in acute lymphoblastic leukaemia: problems and pitfalls. *Eur J Cancer* 1995;31A(10):1656–9.
  - 46 Mastrangelo R, Poplack D, Bleyer A, Riccardi R, Sather H, D'Angio G. Report and recommendations of the Rome workshop concerning poor-prognosis acute lymphoblastic leukemia in children: biologic bases for staging, stratification, and treatment. *Med Pediatr Oncol* 1986;14(3):191–4.
  - 47 Smith M, Arthur D, Camitta B, Carroll AJ, Crist W, Gaynon P, Gelber R, Heerema N, Korn EL, Link M, Murphy S, Pui CH, Pullen J, Reamon G, Sallan SE, Sather H, Shuster J, Simon R, Trigg M, Tubergen D, Uckun F, Ungerleider R. Uniform approach to risk classification and treatment assignment for children with acute lymphoblastic leukemia. *J Clin Oncol* 1996;14(1):18–24.
  - 48 Gaynon PS, Steinherz PG, Bleyer WA, Ablin AR, Albo VC, Finklestein JZ, Grossman NJ, Novak LJ, Pyesmany AF, Reaman GH, et al. Improved therapy for children with acute lymphoblastic leukemia and unfavorable presenting features: a follow-up report of the Children's Cancer Group Study CCG-106. *J Clin Oncol* 1993;11(11):2234–42.
  - 49 Nachman J, Sather HN, Cherlow JM, Sensel MG, Gaynon PS, Lukens JN, Wolff L, Trigg ME. Response of children with high-risk acute lymphoblastic leukemia treated with and without cranial irradiation: a report from the Children's Cancer Group. *J Clin Oncol* 1998;16(3):920–30.
  - 50 Henze G, Fengler R, Reiter A, Ritter J, Riehm H. Impact of early intensive reinduction therapy on event-free survival in children with low-risk acute lymphoblastic leukemia. *Haematol Blood Transfus* 1990;33:483–8.
  - 51 Reiter A, Schrappe M, Ludwig WD, Hiddemann W, Sauter S, Henze G, Zimmermann M, Lampert F, Havers W, Niethammer D, et al. Chemotherapy in 998 unselected childhood acute lymphoblastic leukemia patients. Results and conclusions of the multicenter trial ALL-BFM 86. *Blood* 1994;84(9):3122–33.

- 52 Arico M, Conter V, Valsecchi MG, Rizzari C, Boccalatte MF, Barisoni E, Messina C, De Rossi G, Lo Nigro L, Pession A, Locatelli F, Micalizzi C, Basso G. Treatment reduction in highly selected standard-risk childhood acute lymphoblastic leukemia. The AIEOP ALL-9501 study. *Haematologica* 2005;90(9):1186–91.
- 53 Gaynon PS, Trigg ME, Heerema NA, Sensel MG, Sather HN, Hammond GD, Bleyer WA. Children's Cancer Group trials in childhood acute lymphoblastic leukemia: 1983–1995. *Leukemia* 2000;14(12):2223–33.
- 54 Hann I, Vora A, Richards S, Hill F, Gibson B, Lilliman J, Kinsey S, Mitchell C, Eden OB. Benefit of intensified treatment for all children with acute lymphoblastic leukaemia: results from MRC UKALL XI and MRC ALL97 randomised trials. UK Medical Research Council's Working Party on Childhood Leukaemia. *Leukemia* 2000;14(3):356–63.
- 55 Schrappe M, Beier R, Burger B. New treatment strategies in childhood acute lymphoblastic leukaemia. *Best Pract Res Clin Haematol* 2002;15(4):729–40.
- 56 Evans AE, Gilbert ES, Zandstra R. The increasing incidence of central nervous system leukemia in children (Children's Cancer Study Group A). *Cancer* 1970;26(2):404–9.
- 57 Treatment of acute lymphoblastic leukaemia: effect of "prophylactic" therapy against central nervous system leukaemia. Report of the Medical Research Council by the Leukaemia Committee and the Working Party on Leukaemia in Childhood. *Br Med J* 1973;2(5863):381–4.
- 58 Hustu HO, Aur RJ, Verzosa MS, Simone JV, Pinkel D. Prevention of central nervous system leukemia by irradiation. *Cancer* 1973;32(3):585–97.
- 59 George P, Hernandez K, Hustu O, Borella L, Holton C, Pinkel D. A study of "total therapy" of acute lymphocytic leukemia in children. *J Pediatr* 1968;72(3):399–408.
- 60 Aur RJ, Simone J, Hustu HO, Walters T, Borella L, Pratt C, Pinkel D. Central nervous system therapy and combination chemotherapy of childhood lymphocytic leukemia. *Blood* 1971;37(3):272–81.
- 61 Improvement in treatment for children with acute lymphoblastic leukaemia. The Medical Research Council UKALL trials, 1972–84. Report to the Council by the Working Party on Leukaemia in Childhood. *Lancet* 1986;1(8478):408–11.
- 62 Riehm H, Gadner H, Welte K. [The west-Berlin therapy study of acute lymphoblastic leukemia in childhood – report after 6 years (author's transl.)]. *Klin Padiatr* 1977;189(8):89–102.
- 63 Nesbit Jr ME, Sather HN, Robison LL, Ortega J, Littman PS, D'Angio GJ, Hammond GD. Presymptomatic central nervous system therapy in previously untreated childhood acute lymphoblastic leukaemia: comparison of 1800 rad and 2400 rad. A report for Children's Cancer Study Group. *Lancet* 1981;1(8218):461–6.
- 64 Riehm H, Feickert HJ, Schrappe M, Henze G, Schellong G. Therapy results in five ALL-BFM studies since 1970: implications of risk factors for prognosis. *Haematol Blood Transfus* 1987;30:139–46.
- 65 Relling MV, Rubnitz JE, Rivera GK, Boyett JM, Hancock ML, Felix CA, Kun LE, Walter AW, Evans WE, Pui CH. High incidence of secondary brain tumours after radiotherapy and antimetabolites. *Lancet* 1999;354(9172):34–9.
- 66 Schrappe M, Reiter A, Ludwig WD, Harbott J, Zimmermann M, Hiddemann W, Niemeier C, Henze G, Feldges A, Zintl F, Kornhuber B, Ritter J, Welte K, Gadner H, Riehm H. Improved outcome in childhood acute lymphoblastic leukemia despite reduced use of anthracyclines and cranial radiotherapy: results of trial ALL-BFM 90. German–Austrian–Swiss ALL-BFM Study Group. *Blood* 2000;95(11):3310–22.
- 67 Reiter A, Schrappe M, Ludwig WD, Tiemann M, Parwaresch R, Zimmermann M, Schirg E, Henze G, Schellong G, Gadner H, Riehm H. Intensive ALL-type therapy without local radiotherapy provides a 90% event-free survival for children with T-cell lymphoblastic lymphoma: a BFM group report. *Blood* 2000;95(2):416–21.
- 68 Conter V, Schrappe M, Arico M, Reiter A, Rizzari C, Dordelmann M, Valsecchi MG, Zimmermann M, Ludwig WD, Basso G, Masera G, Riehm H. Role of cranial radiotherapy for childhood T-cell acute lymphoblastic leukemia with high WBC count and good response to prednisone. Associazione Italiana Ematologia Oncologia Pediatrica and the Berlin–Frankfurt–Münster groups. *J Clin Oncol* 1997;15(8):2786–91.
- 69 Pui CH, Pei D, Sandlund JT, Campana D, Ribeiro RC, Razzouk BI, Rubnitz JE, Howard SC, Hijjiya N, Jeha S, Cheng C, Downing JR, Evans WE, Relling MV, Hudson M. Risk of adverse events after completion of therapy for childhood acute lymphoblastic leukemia. *J Clin Oncol* 2005;23(31):7936–41.
- 70 Pui CH. Toward optimal central nervous system-directed treatment in childhood acute lymphoblastic leukemia. *J Clin Oncol* 2003;21(2):179–81.
- 71 Bleyer WA, Coccia PE, Sather HN, Level C, Lukens J, Niebrugge DJ, Siegel S, Littman PS, Leikin SL, Miller DR, et al. Reduction in central nervous system leukemia with a pharmacokinetically derived intrathecal methotrexate dosage regimen. *J Clin Oncol* 1983;1(5):317–25.
- 72 Moe PJ, Seip M, Finne PH. Intermediate dose methotrexate (IDM) in childhood acute lymphocytic leukaemia in Norway. Report on a national treatment program. *Haematologia (Budap)* 1981;14(3):257–63.
- 73 Gustafsson G, Garwicz S, Hertz H, Johansson G, Jonmundsson G, Moe PJ, Salmi T, Seip M, Siimes MA, Yssing M, et al. A population-based study of childhood acute lymphoblastic leukemia diagnosed from July 1981 through June 1985 in the five Nordic countries. Incidence, patient characteristics and treatment results. *Acta Paediatr Scand* 1987;76(5):781–8.
- 74 Bostrom BC, Sensel MR, Sather HN, Gaynon PS, La MK, Johnston K, Erdmann GR, Gold S, Heerema NA, Hutchinson RJ, Provisor AJ, Trigg ME. Dexamethasone versus prednisone and daily oral versus weekly intravenous mercaptopurine for patients with standard-risk acute lymphoblastic leukemia: a report from the Children's Cancer Group. *Blood* 2003;101(10):3809–17.
- 75 Vilmer E, Suciu S, Ferster A, Bertrand Y, Cave H, Thyss A, Benoit Y, Dastugue N, Fournier M, Souillet G, Manel AM, Robert A, Nelken B, Millot F, Lutz P, Rialland X, Mechinaud F, Boutard P, Behar C, Chantaine JM, Plouvier E, Laureys G, Brock P, Uyttebroeck A, Marguerite G, Plantaz D, Norton L,

- Francotte N, Gyselinck J, Waterkeyn C, Solbu G, Philippe N, Otten J. Long-term results of three randomized trials (58831, 58832, 58881) in childhood acute lymphoblastic leukemia: a CLCG-EORTC report. *Children Leukemia Cooperative Group. Leukemia* 2000;14(12):2257–66.
- 76 Pui CH, Sandlund JT, Pei D, Campana D, Rivera GK, Ribeiro RC, Rubnitz JE, Razzouk BI, Howard SC, Hudson MM, Cheng C, Kun LE, Raimondi SC, Behm FG, Downing JR, Relling MV, Evans WE. Improved outcome for children with acute lymphoblastic leukemia: results of Total Therapy Study XIII B at St Jude Children's Research Hospital. *Blood* 2004;104(9):2690–6.
- 77 Gustafsson G, Schmiegelow K, Forestier E, Clausen N, Glomstein A, Jonmundsson G, Mellander L, Makiperna A, Nygaard R, Saarinen-Pihkala UM. Improving outcome through two decades in childhood ALL in the Nordic countries: the impact of high-dose methotrexate in the reduction of CNS irradiation. Nordic Society of Pediatric Haematology and Oncology (NOPHO). *Leukemia* 2000;14(12):2267–75.
- 78 Hill FG, Richards S, Gibson B, Hann I, Lilleyman J, Kinsey S, Mitchell C, Harrison CJ, Eden OB. Successful treatment without cranial radiotherapy of children receiving intensified chemotherapy for acute lymphoblastic leukaemia: results of the risk-stratified randomized central nervous system treatment trial MRC UKALL XI (ISRC TN 16757172). *Br J Haematol* 2004;124(1):33–46.
- 79 Matloub Y, Lindemulder S, Gaynon PS, Sather H, La M, Broxson E, Yanofsky R, Hutchinson R, Heerema NA, Nachman J, Blake M, Wells LM, Sorrell AD, Masterson M, Kelleher JF, Stork LC. Intrathecal triple therapy decreases central nervous system relapse but fails to improve event-free survival when compared to intrathecal methotrexate: results of the Children's Cancer Group (CCG) 1952 study for standard-risk acute lymphoblastic leukemia. A report from the Children's Oncology Group. *Blood* 2006;108:1165–1172.
- 80 Bleyer WA, Nelson JA, Kamen BA. Accumulation of methotrexate in systemic tissues after intrathecal administration. *J Pediatr Hematol Oncol* 1997;19(6):530–2.
- 81 Arico M, Baruchel A, Bertrand Y, Biondi A, Conter V, Eden T, Gadner H, Gaynon P, Horibe K, Hunger SP, Janka-Schaub G, Masera G, Nachman J, Pieters R, Schrappe M, Schmiegelow K, Valsecchi MG, Pui CH. *The Seventh International Childhood Acute Lymphoblastic Leukemia Workshop Report*: Palermo, Italy, January 29–30, 2005. *Leukemia* 2005;19(7):1145–52.
- 82 Chessells JM, Leiper AD, Tiedemann K, Hardisty RM, Richards S. Oral methotrexate is as effective as intramuscular in maintenance therapy of acute lymphoblastic leukaemia. *Arch Dis Child* 1987;62(2):172–6.
- 83 Rivera GK, Raimondi SC, Hancock ML, Behm FG, Pui CH, Abromowitch M, Mirro Jr J, Ochs JS, Look AT, Williams DL, et al. Improved outcome in childhood acute lymphoblastic leukaemia with reinforced early treatment and rotational combination chemotherapy. *Lancet* 1991;337(8733):61–6.
- 84 Stoneham S, Lennard L, Coen P, Lilleyman J, Saha V. Venocclusive disease in patients receiving thiopurines during maintenance therapy for childhood acute lymphoblastic leukaemia. *Br J Haematol* 2003;123(1):100–2.
- 85 Lennard L, Lewis IJ, Michelagnoli M, Lilleyman JS. Thiopurine methyltransferase deficiency in childhood lymphoblastic leukaemia: 6-mercaptopurine dosage strategies. *Med Pediatr Oncol* 1997;29(4):252–5.
- 86 Relling MV, Hancock ML, Rivera GK, Sandlund JT, Ribeiro RC, Krynetski EY, Pui CH, Evans WE. Mercaptopurine therapy intolerance and heterozygosity at the thiopurine S-methyltransferase gene locus. *J Natl Cancer Inst* 1999;91(23):2001–8.
- 87 Relling MV, Hancock ML, Boyett JM, Pui CH, Evans WE. Prognostic importance of 6-mercaptopurine dose intensity in acute lymphoblastic leukemia. *Blood* 1999;93(9):2817–23.
- 88 Schmiegelow K. Prognostic significance of methotrexate and 6-mercaptopurine dosage during maintenance chemotherapy for childhood acute lymphoblastic leukemia. *Pediatr Hematol Oncol* 1991;8(4):301–12.
- 89 Schmiegelow K, Pulczynska MK, Seip M. White cell count during maintenance chemotherapy for standard-risk childhood acute lymphoblastic leukemia: relation to relapse rate. *Pediatr Hematol Oncol* 1988;5(4):259–67.
- 90 Schmiegelow K, Pulczynska MK. Maintenance chemotherapy for childhood acute lymphoblastic leukemia: should dosage be guided by white blood cell counts? *Am J Pediatr Hematol Oncol* 1990;12(4):462–7.
- 91 Dolan G, Lilleyman JS, Richards SM. Prognostic importance of myelosuppression during maintenance treatment of lymphoblastic leukaemia. Leukaemia in Childhood Working Party of the Medical Research Council. *Arch Dis Child* 1989;64(9):1231–4.
- 92 Chessells JM, Harrison G, Lilleyman JS, Bailey CC, Richards SM. Continuing (maintenance) therapy in lymphoblastic leukaemia: lessons from MRC UKALL X. Medical Research Council Working Party in Childhood Leukaemia. *Br J Haematol* 1997;98(4):945–51.
- 93 Schmiegelow K, Bjork O, Glomstein A, Gustafsson G, Keiding N, Kristinsson J, Makiperna A, Rosthoj S, Szumlanski C, Sorensen TM, Weinshilboum R. Intensification of mercaptopurine/methotrexate maintenance chemotherapy may increase the risk of relapse for some children with acute lymphoblastic leukemia. *J Clin Oncol* 2003;21(7):1332–9.
- 94 Toyoda Y, Manabe A, Tsuchida M, Hanada R, Ikuta K, Okimoto Y, Ohara A, Ohkawa Y, Mori T, Ishimoto K, Sato T, Kaneko T, Maeda M, Koike K, Shitara T, Hoshi Y, Hosoya R, Tsunematsu Y, Bessho F, Nakazawa S, Saito T. Six months of maintenance chemotherapy after intensified treatment for acute lymphoblastic leukemia of childhood. *J Clin Oncol* 2000;18(7):1508–16.
- 95 Lilleyman JS, Lennard L. Non-compliance with oral chemotherapy in childhood leukaemia. *Br Med J* 1996;313(7067):1219–20.

## CHAPTER 14

# Steroids and asparaginases during remission induction therapy in childhood lymphoblastic leukemia

## Studies: Steroids in ALL

### Study 1

Yetgin S, Tuncer MA, Cetin M, Gumruk F, Yenicesu I, Tunc B, Oner AF, Toksoy H, Koc A, Aslan D, Ozyurek E, Olcay L, Atahan L, Tuncbilek E, Gurgey A. Benefit of high-dose methylprednisolone in comparison with conventional-dose prednisolone during remission induction therapy in childhood acute lymphoblastic leukemia for long-term follow-up. *Leukemia* 2003;17:328–33.

### Study design

This was a single center prospective study that ran from March 1991 to March 1997.

Eligible patients were randomized according to odd and even file numbers. No other details were specified. Informed consent was obtained for all patients.

### Objectives

The aim of this study was:

- To compare the efficacy of intravenous high dose methylprednisolone (HDMP) against conventional dose of prednisolone during remission induction therapy in children with acute lymphoblastic leukemia (ALL).

### Details of the study

Previously untreated children below 18 years of age were registered on the study. Children with B cell acute

lymphoblastic leukemia (B-ALL) or with L3 morphology were excluded from the study. Chemotherapy treatment was according to the St Jude's Total Therapy Study XI protocol with some minor modifications. Patients were considered high risk if they had one or more of the following features:

- (i) Initial white blood cell (WBC)  $>100 \times 10^9/l$ .
- (ii) Children who had two or more unfavorable risk factors such as WBC  $>25 \times 10^9/l$ , age  $\leq 2$  years or  $\geq 10$  years, extramedullary leukemia, specific clonal chromosomal translocations, central nervous system (CNS) disease, clonal hypodiploid disease, CALLA-negative T or B immunophenotype and day 15 marrow containing  $>5\%$  blasts.

All others were considered standard risk.

All patients were randomized at diagnosis to either Group A or Group B. For Group A patients, induction of remission/consolidation therapy consisted of IV vincristine (VCR)  $1.5 \text{ mg/m}^2 \times 4$ , oral prednisolone (PDN)  $60 \text{ mg/m}^2 \times 4$  weeks, IM/IV L-asparaginase (L-asp)  $200 \text{ mg/m}^2 \times 6$ , daunorubicin (DNR)  $30 \text{ mg/m}^2 \times 2$ , IV cytosine arabinoside (ARA-C)  $300 \text{ mg/m}^2 \times 3$ , IV cyclophosphamide (CPM)  $300 \text{ mg/m}^2 \times 2$  IV etoposide (VP16)  $3\text{--}6 \text{ mg/kg} \times 2$  and IV methotrexate (MTX)  $50 \text{ mg/kg} \times 2$ .

Group B patients received IV high dose methylprednisolone (HDMP) ( $900 \text{ mg/m}^2 \times 7$  days) instead of oral PDN. The rest of the induction/consolidation therapy was identical to Group A patients (Table 14.1).

CNS prophylaxis consisted of intrathecal (IT) MTX, ARA-C and PDN. High risk patients also received 18-Gy

**Table 14.1** Early treatment.

Drug	Dose (Route)	Given on Days
Prednisolone (Group A)	60 mg/m <sup>2</sup> (PO)	1–29
Methylprednisolone (Group B)	900 mg/m <sup>2</sup> (PO)	1–7
	600 mg/m <sup>2</sup> (PO)	8–15, 17, 19, 21, 23, 25, 27, 29
Vincristine	1.5 mg/m <sup>2</sup> (IV)	1, 8, 15, 22
Daunorubicin	30 mg/m <sup>2</sup> (IV)	2, 8, (15) <sup>a</sup>
L-asparaginase	200 mg/m <sup>2</sup> (IV, IM)	3, 4, 6, 8, 10, 12, (15, 17, 19) <sup>a</sup>
Cytosine arabinoside	300 mg/m <sup>2</sup> (IV)	22, 25, 29
Cyclophosphamide	300 mg/m <sup>2</sup> (IV)	36, 43
Etoposide	3–6 mg/kg (IV)	36, 43
Methotrexate (IT)	12 <sup>b</sup> , 10 <sup>c</sup> , 8 <sup>d</sup> mg	2, 22, 43
Prednisone (IT)	24 <sup>b</sup> , 20 <sup>c</sup> , 16 <sup>d</sup> , mg	2, 22, 43
Cytosine arabinoside (IT)	36 <sup>b</sup> , 30 <sup>c</sup> , 24 <sup>d</sup> mg	2, 24, 43
High dose methotrexate <sup>e</sup>	50 mg/kg (IV)	50, 57

<sup>a</sup> dose in parenthesis given if bone marrow is not in remission on day 15; <sup>b</sup> if patient >3 years old; <sup>c</sup> if patient is 1–3 years old; <sup>d</sup> if patients is <1 year old; <sup>e</sup> followed by lecovorin rescue.

cranial irradiation plus five additional IT injections after the consolidation phase of therapy.

Maintenance therapy was identical for both standard and high risk patients and consisted of four pairs of drugs rotated weekly over 120 weeks:

- VP16 300 mg/m<sup>2</sup> IV plus CPM 300 mg/m<sup>2</sup> IV.
- 6-mercaptopurine (6-MP) 75 mg/m<sup>2</sup>/day PO plus MTX 40 mg/m<sup>2</sup>/day IM.
- VP16 300 mg/m<sup>2</sup> IV plus ARA-C 300 mg/m<sup>2</sup> IV.
- PDN 60 mg/m<sup>2</sup> (days 1–7) PO plus VCR 1.5 mg/m<sup>2</sup> IV.

If remission was not achieved by day 15, one additional dose of DNR and three additional doses of L-asp were given. Patients were withdrawn from the study if they failed to achieve remission after high dose MTX (day 57).

Patient characteristics are shown in Table 14.2. Of the 265 patients registered on the study, only 205 were eligible for analyses; 60 were excluded (refusal of treatment,  $n = 8$ ; main treatment at another hospital,  $n = 47$ ; intolerance to HDMP,  $n = 5$ ) from the study; 108 children were randomized to conventional dose PDN (Group A) and 97 to HDMP (Group B). It is not clear whether analysis was on the basis of intention to treat. Ninety-five percent of those eligible for analysis ( $n = 194/205$ ) achieved complete remission (CR). Excluding 7 patients who died prior to day 15 marrow assessment, 126 (64%) of the remaining 198 patients achieved M1 marrow status on day 15 of induction therapy. The number of patients in the high risk

category were significantly higher in Group B than compared to Group A ( $p = 0.01$ ). The median follow-up time was 72 (60–129) months.

### Outcome measures

The main outcome measures were event-free survival (EFS) and relapse rates.

### Outcome

The 8-year EFS for the entire group ( $n = 205$ ), Group A ( $n = 108$ ) and Group B ( $n = 97$ ) were 60%, 53% and 66%, respectively. In the high risk category, the EFS was 39% for Group A patients compared to 63% for Group B ( $p = 0.002$ ) (Figure 14.1).

EFS rate was significantly better for children who were either  $\geq 2$  or  $\leq 10$  years of age who received HDMP ( $n = 28$ , 74%) compared to PDN ( $n = 42$ , 44%) ( $p = 0.05$ ).

EFS rates were also higher for patients with either T or B immunophenotype ALL who were randomized to receive HDMP compared to PDN (60% and 77% versus 19% and 43%, respectively;  $p = 0.07$  and  $p = 0.04$ , respectively).

When remission status was considered (M1/M2), EFS rates were superior for patients randomized to HDMP compared to PDN; 61% in Group A versus 78% in Group B for M1 marrow ( $p = 0.05$ ) and 28% versus 58%, respectively, for patients with M2 marrow ( $p = 0.04$ ).

**Table 14.2** Clinical and laboratory characteristics of patients (n = 205).

	Total		Group A		Group B	
	n	%	n	%	n	%
<b>Risk<sup>a</sup></b>						
Lower	66	32	42	39	24	25 <sup>a</sup>
Higher	139	68	66	61	73	75
<b>Age, years</b>						
≤2	23	11	15	14	8	8
>2 <10	136	66	66	61	70	72
≥10	46	23	27	25	19	20
<b>Sex</b>						
Male	119	58	58	54	61	63
Female	86	42	50	46	36	37
<b>Leukocyte count (×10<sup>9</sup>/l)</b>						
0–24	138	67	66	61	72	74
25–49	20	10	13	12	7	7
50–99	24	12	14	13	10	10
>100	23	11	15	14	8	9
<b>Day 15 bone marrow</b>						
<5% blasts	126	64	67	66	59	64
≥5% blasts	56	28	31	30	25	26
Unknown	16	8	6	6	10	11
<b>Immunophenotype</b>						
CALLA-positive B	65	32	35	33	30	31
CALLA-negative B	17	8	7	6	10	11
CALLA-positive T	9	4	8	7	1	1
CALLA-negative T	26	13	18	17	8	8
CALLA-positive	24	12	9	8	15	15
Null	31	15	12	11	19	20
Mixed lineage leukemia	15	7	6	6	9	9
Unknown	18	9	13	12	5	5
<b>FAB classification</b>						
L1	106	52	59	55	47	48
L2	99	48	49	45	50	52
CNS leukemia at diagnosis	3	1.4	1	1	2	2
Mediastinal infiltration at diagnosis	17	8	10	9	7	7
CNS + mediastinal infiltration at diagnosis	1	0.5	1	1	–	–
Bone involvement	37	18	18	17	19	20

<sup>a</sup> number of high risk patients were significantly higher than low risk patients in Group B.

In multivariate analyses of the high risk group of patients, the use of HDMP was an independent factor for higher EFS and better prognosis ( $p = 0.05$ ).

There was no difference in EFS between the two groups for patients with low risk disease. Table 14.3 shows the EFS of both groups of patients.

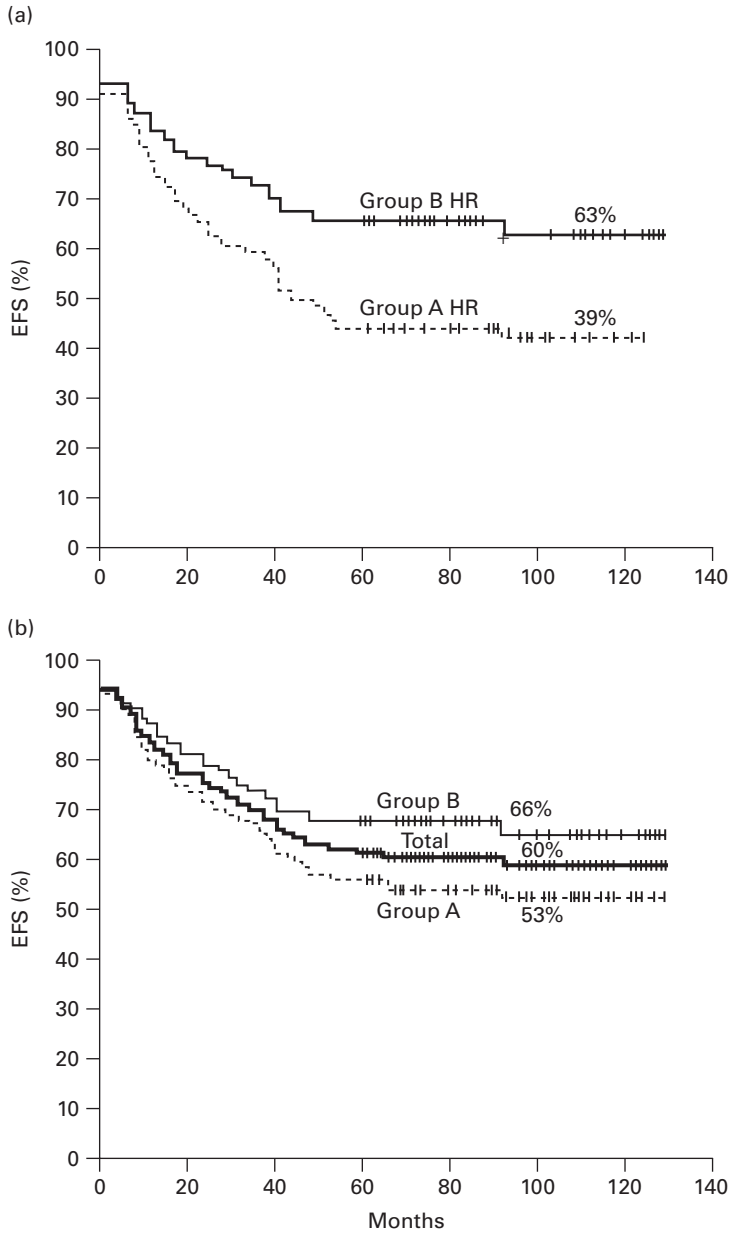
Relapses were higher in Group A patients ( $n = 42$ , 39%) compared to Group B ( $n = 22$ , 23%) ( $p = 0.05$ ). Bone marrow relapses were significantly higher in

Group A compared to Group B (Table 14.4). No differences were seen in the CNS relapse rate between the two groups of patients.

### Toxicity

There were no differences in toxicity between the two groups of patients. Bone mineral density (by dexa scans) was also similar in the two groups of children.





**Figure 14.1** (a) Eight-year EFS rate of high risk (HR) patients in Groups A and B. (b) Eight-year EFS rate in Groups A and B patients and in the total group. Reprinted from Yetgin *et al.* (full reference on p. 279) with permission from Nature, Macmillan Publishers Ltd.

### Conclusion

It was concluded that HDMP was superior to PDN during remission induction therapy for childhood ALL. The use of HDMP improved the EFS for patients with

high risk ALL and also significantly reduced the incidence of bone marrow relapses in both high and low risk patients.

**Table 14.3** Eight-year EFS in patient groups.

	Group A		Group B		p value	Total (A + B)	
	EFS (SE) %	n	EFS (SE) %	n		EFS (SE) %	n
Total	53 (5)	108	66 (5)	97	0.05	60(5)	205
High risk	39 (7) <sup>1</sup>	66	63 (6) <sup>3</sup>	74	0.002		
Low risk	71 (7) <sup>2</sup>	42	74 (9) <sup>4</sup>	23	0.8		
Age ≤2 years ≥10 years	44 (8)	42	74 (9)	28	0.05		
WBC (50 × 10 <sup>9</sup> /l)	38 (9)	29	58 (11)	20	0.07		
High risk with T cell	19 (10)	16	60 (15)	10	0.07		
High risk with B cell	43 (13)	14	77 (9)	22	0.04		
Remission on day 15 (M1)	61 (6) <sup>5</sup>	67	78 (5) <sup>7</sup>	59	0.05		
Non-remission on day 15 (M2)	28 (9) <sup>6</sup>	31	58 (12) <sup>8</sup>	25	0.04		

p values in comparison of the following parameters: 1–2 = 0.03; 3–4 = 0.6; 5–6 = 0.04; 7–8 = 0.4.

**Table 14.4** Sites of treatment failure in 205 randomized patients.

	Total			Group A		Group B	
	n	High R	Low R	High R	Low R	High R	Low R
Number of total relapses	64	50	14	32	10	18	4
Number of BM relapses	48	38	10	26	7	12	3
Number of CNS relapses	15	10	5	5	3	6	1
Number of testes relapse	1	1	–	1	–	–	–
Number of death in remission*	5	5	–	2	–	3	–
Number of secondary AML	3	3	–	1	–	2	–

The comparison of Group A with Group B: in total relapse p = 0.05; BM relapse p = 0.05.

\*Encephalopathy in two cases, meningococemia in one case, cardiomyopathy in one case, pulmonary hemorrhage in one case.

## Study 2

Lopez-Hernandez MA, Alvarado M, De Diego J, Borbolla-Escoboza JR, Jimenez RM, Trueba E. A randomized trial of dexamethasone before remission induction, in *de novo* childhood acute lymphoblastic leukemia. *Haematologica* 2004;**89**: 365–6.

## Study design

This was a single center prospective study that was conducted between 1996 and 2000. Eligible patients were randomized to receive either intravenous dexamethasone (DEX) for 4 days (days –4 to –1) prior to commencement of chemotherapy or to commence Memorial Sloan-Kettering New York protocol II

chemotherapy regimen immediately (no DEX arm). No other details were specified. Randomization methodology was not specified. Informed consent was obtained for all study patients.

### Objectives

The aim of this study was:

- To evaluate the impact of 4 days of pre-phase intravenous DEX prior to commencement of definitive therapy in reducing bone marrow disease at day 14. Improve the remission rate and disease-free survival (DFS) in children with standard risk acute lymphoblastic leukemia (ALL).

### Details of the study

Previously untreated children below 20 years of age were registered on the study. Chemotherapy treatment was according to the Memorial Sloan-Kettering New York protocol II regimen. Children with organ dysfunction or failure were excluded from the study. Chromosomal karyotyping information were unavailable. The median follow-up for both groups was 40 months.

### Outcome

#### Study population

Fifty-two patients were randomized to pre-phase DEX arm and 43 to the no DEX arm. There were no statistically significant differences in the mean age: 8.2 years versus 7.7 years ( $p = 0.66$ ); presence of mediastinal mass: 4 versus 1 ( $p = 0.48$ ); white blood count  $\times 10^9/l$

(WBC): 46 versus 56 ( $p = 0.61$ ) or B/T cell distribution: 36/6 versus 27/6 ( $p = 0.88$ ) between the two groups of patients.

The male:female ratio was, however, significantly different between the two groups – 17/35 (DEX arm) versus 26/17 (no DEX arm) ( $p = 0.01$ ).

#### Bone marrow response and DFS

The bone marrow blast percentage was lower in the DEX arm compared to the no DEX arm and was statistically significant ( $p = 0.004$ ). There was no significant difference in deaths during remission induction between the two arms ( $p = 0.81$ ) (Table 14.5) 5-year disease-free survival (DFS) rates were better in the DEX arm with a trend toward significance ( $p = 0.07$ ) (Figure 14.2).

#### Relapse and deaths

Relapses were lower in the DEX arm ( $n = 2$ ) compared to the no DEX arm ( $n = 10$ ) and distribution of relapse (bone marrow/central nervous system) was 1/1 in the DEX arm compared to 9/1 in the no DEX arm.

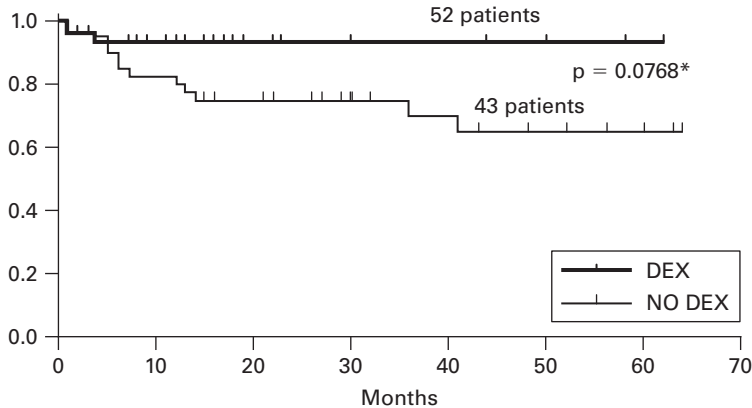
There were 4 deaths in the DEX arm (infection 2, CNS bleed 1 and combined CNS bleed plus infection 1). In the no DEX arm there were a total of 11 deaths (infection 7, CNS bleed 3 and pancreatitis 1).

### Conclusion

It was concluded that administration of dexamethasone for a very short duration prior to commencement of definitive chemotherapy in children with acute lymphoblastic leukemia (ALL) improved early bone marrow disease clearance and probably improved DFS.

**Table 14.5** Treatment outcome.

	DEX (n = 52)	No DEX (n = 43)	p
Day +14 blast percentage in the bone marrow, median (range)	3 (0–36)	9 (1–25)	0.004
Remissions (%)	92.3	74.5	0.70
Deaths during induction (n)	4	11	0.81
DFS at 40 months (%)	92.5	70	0.076



**Figure 14.2** Five-year DFS rates. Reprinted from Lopez-Hernandez *et al.* (full reference on p. 283) with permission of *Haematologica*.

\* 95% confidence interval: 0.1331–1.109

### Study 3

Mitchell CD, Richards SM, Kinsey SE, Lilleyman J, Vora A and T.O.B. Eden on behalf of the Medical Research Council Childhood Leukaemia Working Party. Benefit of dexamethasone compared with prednisolone for childhood acute lymphoblastic leukaemia: results of the UK Medical Research Council ALL97 randomized trial. *Br J Haematol* 2005; **129**:735–45.

#### Study design

ALL 97 was a multi-center prospective randomized study for children with childhood acute lymphoblastic leukemia (ALL) and the study was open from April 1997 to June 2002. Randomization was done through a central office where patient details were recorded and treatment allocated using minimization to balance treatments over gender, age, white blood count and other treatment allocation groups. Written informed consent was obtained from parents and where appropriate, the patient, prior to commencement of therapy.

#### Objectives

The primary objective of the study was:

- To determine whether dexamethasone was more effective than prednisolone in the treatment of childhood lymphoblastic leukaemia.

#### Study design

All children with previously untreated ALL between the 1 and 18 years of age were eligible for inclusion in the trial. Children with mature B cell ALL were excluded from the trial. The overall treatment template underwent several modifications during the study period. Remission induction chemotherapy comprised weekly intravenous vincristine 1.5 mg/m<sup>2</sup> (maximum dose 2 mg), daily oral steroid as randomized and *Erwinia* asparaginase 6000 µg/m<sup>2</sup>/dose × 9 given on a Monday, Wednesday and Friday. Two intensification blocks were given at weeks 5 and 20 and patients were randomized to receive or not a third intensification block at week 35. From April 1998, the number of *Erwinia* asparaginase doses were increased to 12 and these were administered on alternate days (pharmacokinetic data indicated that the dose of *Erwinia* asparaginase was suboptimal). In May 1998, interim data analysis suggested that patients who received three intensification blocks had an improved outcome and hence all subsequently diagnosed children with ALL, as well as all patients who had not reached week 35, received three intensification modules (Table 14.6).

In November 1999, the treatment protocol underwent a further revision. Though the basic template and the randomization question were retained, the intensification modules were modified to resemble the intensification regime of the Berlin–Frankfurt–Münster (BFM) group. The treatment protocol was re-designated as Medical Research Council (MRC) ALL 97/99 protocol (Table 14.7). Risk stratification during this phase

**Table 14.6** ALL 97 treatment regimens.

Induction	First IB	CNS-Directed Treatment	Second IB	Interim CT	Third IB	CT
VCR 1.5 mg/m <sup>2</sup> IV days 1, 7, 14 and 21 Randomization <sup>a</sup> Prednisolone 40 mg/m <sup>2</sup> 40 mg/m <sup>2</sup> PO days 1–28 or Dexamethasone 6.5 mg/m <sup>2</sup> /day PO days 1–28 L-asp 6000 u/m <sup>2</sup> SC/IM 3/week × nine doses IT MTX 12.5 mg/m <sup>2</sup> days 1 and 8	VCR 1.5 mg/m <sup>2</sup> IV day 1 Prednisolone 40 mg/m <sup>2</sup> PO × 7 days Etoposide 100 mg/m <sup>2</sup> IV × 5 days Cytarabine 100 mg/m <sup>2</sup> IV days 1–5 Daunorubicin 45 mg/m <sup>2</sup> days 1 and 2 Thioguanine 80 mg/m <sup>2</sup> PO days 1–5 IT MTX 12.5 mg/m <sup>2</sup> day 1	Randomization <sup>b</sup> WBC <50 × 10 <sup>9</sup> /l IT MTX 12.5 mg/m <sup>2</sup> weekly weeks 9–12 or HD MTX 6 or 8 g/m <sup>2</sup> weeks 6, 8 and 10 12 hourly × 5 days plus IT MTX weeks 5, 6, 8 and 10 WBC ≥50 × 10 <sup>9</sup> /l HD MTX as above or 24-Gy cranial radiotherapy in 15 fractions of 1.6 Gy each weeks 9–12 (except 1–2 years age who were allocated HD MTX) Interim CT Randomization <sup>c</sup> Mercaptopurine 75 mg/m <sup>2</sup> or Thioguanine 40 mg/m <sup>2</sup> PO daily Methotrexate 20 mg/m <sup>2</sup> PO weekly except during CNS-directed treatment VCR 1.5 mg/m <sup>2</sup> IV and Prednisolone <sup>d</sup> 40 mg/m <sup>2</sup> PO daily × 5 days every 4 weeks	VCR 1.5 mg/m <sup>2</sup> IV day 1 Prednisolone 40 mg/m <sup>2</sup> PO × 7 days Etoposide 100 mg/m <sup>2</sup> IV × 5 days Cytarabine 100 mg/m <sup>2</sup> IV 12 hourly × 5 days Daunorubicin 45 mg/m <sup>2</sup> days 1 and 2 IT MTX 12.5 mg/m <sup>2</sup> day 1 Thioguanine 80 mg/m <sup>2</sup> PO days 1–5	Same as weeks 8–19	Dexamethasone 10 mg/m <sup>2</sup> PO daily for 10 days, then 4-day taper VCR 1.5 mg/m <sup>2</sup> IV days 1, 7, 14 and 21 L-asp 6000 µg/m <sup>2</sup> SC/IM 3/week × nine doses IT MTX 12.5 mg/m <sup>2</sup> days 1 and 28 Cyclophosphamide 600 mg/m <sup>2</sup> days 28 and 42 Cytarabine 75 mg/m <sup>2</sup> days 28–31, 35–38, 42–45 and 49–52 Thioguanine 60 mg/m <sup>2</sup> PO days 28–56 or CT + 3-monthly IT MTX 12.5 mg/m <sup>2</sup>	Same as interim CT
Weeks 1–4	5 + 2 for recovery	8–19	20 + 2 for recovery	22–34	35–42	42–100 <sup>e</sup>

CT: continuing therapy; HD MTX: high dose intravenous methotrexate; IB: intensification block; IM: intramuscular; IV: intravenous; PO: oral; SC: subcutaneous; L-asp: *Erwinia* asparaginase and VCR: vincristine.

<sup>a</sup>Randomized in ALL 97. All patients received prednisolone in UKALL XI.

<sup>b</sup>WBC < 50 × 10<sup>9</sup>/l received IT MTX alone in ALL 97.

<sup>c</sup>Randomized in ALL 97. All patients received mercaptopurine in UKALL XI.

<sup>d</sup>Dexamethasone in ALL 97 according to induction randomization.

<sup>e</sup>105 weeks in ALL 97.

**Table 14.7** ALL 97/99 treatment regimens.

Induction	Consolidation	Interim Maintenance No. 1	Delayed Intensification No. 1	Interim Maintenance No. 2	Delayed Intensification No. 2	Continuing Therapy
<p>Regimen A</p> <p>VCR 1.5 mg/m<sup>2</sup> days 1, 8, 15, 22 and 29</p> <p>Randomization Prednisolone 40 mg/m<sup>2</sup>/day PO days 1–29 or Dexamethasone 6.5 mg/m<sup>2</sup>/day PO days 1–29</p> <p>L-asparaginase (Elspar) 6000 u/m<sup>2</sup> SC/IM, 3/week × nine doses</p> <p>If switching to regimen C, Daunorubicin 45 mg/m<sup>2</sup> IV, days 15 and 22</p>	<p>Steroids: Taper steroids over 7 days</p> <p>to zero, days 1–7</p> <p>VCR 1.5 mg/m<sup>2</sup> IV on day 1 (week 5)</p> <p>Randomization 6-mercaptopurine 75 mg/m<sup>2</sup>/day PO, or 6-thioguanine 40 mg/m<sup>2</sup>/day PO daily on days 1–29 (weeks 5–8)</p>	<p>Steroid as randomized for 5 days starting on days 1 and 29</p> <p>VCR 1.5 mg/m<sup>2</sup> days 1 and 29</p> <p>Thiopurine as randomized for days 1–49</p> <p>Methotrexate 20 mg/m<sup>2</sup> PO weekly on days 8, 15, 22, 36, 43 and 50</p>	<p>Dexamethasone 10 mg/m<sup>2</sup> PO for 7 days starting on days 1 and 15</p> <p>VCR 1.5 mg/m<sup>2</sup> days 1, 8, and 15</p> <p>Doxorubicin 25 mg/m<sup>2</sup> on days 1, 8, 15</p> <p>L-asparaginase (Elspar) 6000 µg for six doses stating on day 4</p> <p>Cyclophosphamide 1 g/m<sup>2</sup> IV on day 29</p> <p>Thioguanine 60 mg/m<sup>2</sup> days 29–42</p> <p>Cytarabine 75 mg/m<sup>2</sup> IV, days 30–33 and 37–40</p>	<p>Steroid as randomized for 5 days starting on days 1 and 29</p> <p>VCR 1.5 mg/m<sup>2</sup> days 1 and 29</p> <p>Thiopurine as randomized for days 1–49</p> <p>Methotrexate 20 mg/m<sup>2</sup> PO weekly on days 8, 15, 22, 36, 43 and 50</p>	<p>Dexamethasone 10 mg/m<sup>2</sup> PO for 7 days starting on days 1 and 15</p> <p>VCR 1.5 mg/m<sup>2</sup> days 1, 8, 15</p> <p>Doxorubicin 25 mg/m<sup>2</sup> on days 1, 8, 15</p> <p>L-asparaginase (Elspar) 6000 µg for six doses stating on day 4</p> <p>Cyclophosphamide 1 g/m<sup>2</sup> IV on day 29</p> <p>Thioguanine 60 mg/m<sup>2</sup> days 29–42</p> <p>Cytarabine 75 mg/m<sup>2</sup> IV, days 30–33 and 37–40</p>	<p>12-week cycles consisting of:</p> <p>Steroid as randomized for 5 days starting on days 1, 29 and 57</p> <p>VCR 1.5 mg/m<sup>2</sup> days 1 and 29</p> <p>Thiopurine as randomized for days 1, 29, 57</p> <p>Thiopurine as randomized</p> <p>Methotrexate 20 mg/m<sup>2</sup> PO weekly on days 8, 15, 22, 36, 43 and 50</p>
<p>Regimen B</p> <p>As per regimen A plus Daunorubicin 25 mg/m<sup>2</sup> IV on days 1, 8, 15 and 22</p> <p>No change in induction if switching to regimen C</p>	<p>Standard BFM consolidation</p> <p>Cyclophosphamide 1 g/m<sup>2</sup> IV on days 1 and 15</p> <p>Cytarabine 75 mg/m<sup>2</sup> IV, days 2–5, 9–12, 16–19 and 23–26</p> <p>6-mercaptopurine, 60 mg/m<sup>2</sup> days 1–29</p>	<p>As per regimen A</p>	<p>As per regimen A</p>	<p>As per regimen A</p>	<p>As per regimen A</p>	<p>As per regimen A</p>

(Continued)

**Table 14.7** (Continued)

<b>Induction</b>	<b>Consolidation</b>	<b>Interim Maintenance No. 1</b>	<b>Delayed Intensification No. 1</b>	<b>Interim Maintenance No. 2</b>	<b>Delayed Intensification No. 2</b>	<b>Continuing Therapy</b>
Regimen C Induction as per modification to regimen A above, or else as per regimen B above	Augmented BFM consolidation Cyclophosphamide 1 g/m <sup>2</sup> IV on days 1 and 29 Cytarabine 75 mg/m <sup>2</sup> IV, days 2–5, 9–12, 30–33 and 37–40 6-mercaptopurine, 60 mg/m <sup>2</sup> days 1–15 and 20–42 VCR 1.5 mg/m <sup>2</sup> IV on days 15, 22, 43, 50 PEG asparaginase 2500 µg/m <sup>2</sup> days 15 and 43	Capizzi I VCR 1.5 mg/m <sup>2</sup> IV on days 1, 11, 21, 31 and 41 Methotrexate 100 mg/m <sup>2</sup> increasing by 50 mg/m <sup>2</sup> every 10 days as permitted by toxicity PEG asparaginase 2500 µg/m <sup>2</sup> days 2 and 22	As per regimen A	Capizzi II VCR 1.5 mg/m <sup>2</sup> IV on days 1, 11, 21, 31 and 41 Methotrexate 100 g/m <sup>2</sup> increasing by 50 mg/m <sup>2</sup> every 10 days as permitted by toxicity PEG asparaginase 2500 µg/m <sup>2</sup> days 2 and 22	As per regimen A	As per regimen A
Intrathecal therapy Cytarabine day 1 (week 1) only. Dose by age: <2 years: 30 mg; 2 years: 50 mg; ≥3 years: 70 mg Methotrexate day 8 (week 2) Dose by age: <2 years: 8 mg; 2 years: 10 mg; ≥3 years: 12 mg	Methotrexate days 1, 8, 15, 22, dose as induction	Methotrexate on days 1 and 31, doses as induction	Methotrexate on days 1, 29 and 36, doses as induction	Methotrexate on days 1 and 31, doses as induction	Methotrexate on days 1, 29 and 36, doses as induction	Methotrexate on days 1 or each cycle, doses as induction

For abbreviations refer to Table 14.6.

was based on age and presenting white blood cell count and patients categorized as standard risk were treated on regimen A while intermediate risk patients were treated on the regimen B. High risk patients (i.e. patients with Philadelphia positive ALL, near haploidy, *MLL* gene rearrangement, etc.) as well as patients who had a slow early marrow response (>25% blasts, M3 marrow) on regimens A and B were transferred to the high risk regimen C. In addition, the total duration of therapy was increased for boys to 3 years whilst girls continued treatment for a total of 2 years.

In April 2001, the type of asparaginase was changed from the *Erwinia chrysanthemi* derived Erwinase to the *E. coli* derived Elspar. The dose was also changed to 6000 µg/m<sup>2</sup>/dose ×9 doses given on a Monday, Wednesday and Friday of the week.

### Central nervous system directed therapy

In ALL 97, pre-symptomatic central nervous system (CNS) therapy consisted of 16 doses of intrathecal methotrexate (IT MTX) with the dosage based on age. In the amended 97/99 regimen, the number of doses increased; Regimen A – girls: 19 doses, boys: 23 doses, Regimen B – girls: 22 doses, boys: 26 doses and Regimen C – girls: 22 doses, boys: 26 doses. Patients with CNS disease at diagnosis received additional IT MTX during remission induction until the cerebrospinal fluid (CSF) was clear followed by 24-Gy cranial irradiation during the consolidation phase of treatment.

### Randomization

Patients were randomized at diagnosis to receive either prednisolone (40 mg/m<sup>2</sup>/day orally) or dexamethasone (6.5 mg/m<sup>2</sup>/day orally). All patients received the same randomized steroid during remission induction, intensification blocks and the continuing phase of treatment.

In 2002, the data monitoring committee recommended closure of the trial because of the observed benefit of dexamethasone over prednisolone. It also recommended that all patients who were still on treatment should receive dexamethasone for the remainder of their therapy.

### Outcome end points

The primary end points were event-free survival (EFS) and overall survival (OS). Secondary end points included death during remission induction, remission

deaths, isolated CNS relapses, combined CNS relapses and non-CNS relapses.

### Statistics

It was estimated that a target of 1800 randomized patients would give a 99% power to detect 10% difference and 80% power to detect a 6% difference in EFS if the assumed baseline 4-year EFS was 70%. Probabilities of EFS were estimated by the Kaplan–Meier method and odds ratio plots were used to show the relative effect of steroid type within subgroups. Toxicity was analyzed with the SAS statistical package, using Chi-square and Cochrane–Mantell–Haenszel tests and by logistic regression;  $p < 0.05$  were considered significant.

### Outcome

Of the 1948 patients registered on the trial, only 1621 were randomized for the type of steroid (13 were excluded due to misdiagnosis, 165 opted for prednisolone, 16 opted for dexamethasone and 133 were treated on the high risk protocol). A further 18 patients were excluded after randomization because they were found to be high risk during remission induction and were transferred to the ALL HR1 high risk protocol. Of the remaining 1603 patients, 805 were randomized to receive prednisolone and 798 to receive dexamethasone (Figure 14.3 and Table 14.8).

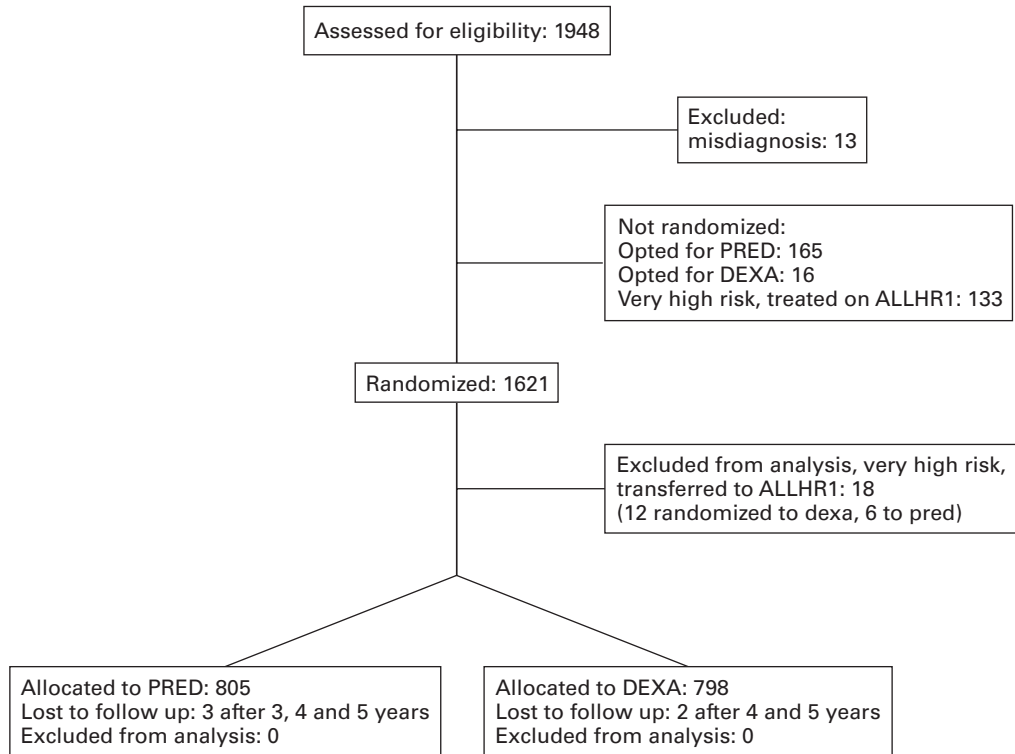
There was no difference in the demographic or leukemia characteristics between those who refused randomization and those randomized. Patient characteristics are shown in Table 14.9.

### CNS relapses

There was a significant reduction in the incidence of CNS relapses for patients who were randomized to receive dexamethasone. The isolated CNS relapse rate at 5 years was 2.5% (95% CI = 1.3–3.7%) for patients in the dexamethasone arm compared to 5% (95% CI = 3.4–6.6%) for patients in the prednisolone arm (2 $p$  = 0.007) (Figure 14.4). The overall CNS relapse rate was also significantly lower in the dexamethasone arm (2 $p$  = 0.0004) as was the incidence of non-CNS relapses (2 $p$  = 0.002).

The relative risk reduction for CNS relapse with dexamethasone was highest for those aged 10 years and above ( $p$  value for heterogeneity = 0.03) while for non-CNS relapse it was highest for those under 10 years of age ( $p$  = 0.05) (Figure 14.5).





**Figure 14.3** Consolidated Standards for Reporting of Trials (CONSORT) diagram. DEXA: dexamethasone and PRED: prednisolone. Reprinted with permission (full reference on p. 285) from Blackwell Publishing Ltd, *British Journal of Haematology*.

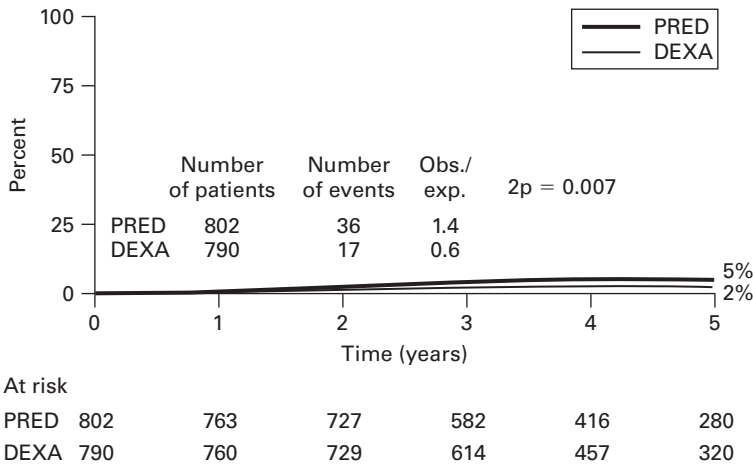
**Table 14.8** ALL 97/99 trial entrants and steroid randomization rates and numbers.

	Total Patients	ALL 97 (1997–99)		ALL 99 (1999–2002)		
		Main Trial	HR1	Regimen A	Regimen B	Regimen C*
Number entered	1935	846	151	556	232	150
Total randomization (% of entrants)	1621	781 (92%)	18	497 (89%)	199 (86%)	126 (84%)
Dexamethasone	810	389	12	248	107	54
Prednisolone	811	392	6	249	92	72
Non-randomized dexamethasone	16	1	0	4	7	4
Non-randomized prednisolone	298	64	133	55	26	20

\*Arm C patients came from Arms A and B as a result of: (1) identification of the cytogenetic abnormalities, near haploidy, Ph+ ALL, or *MLL* gene rearrangements and (2) as a result of slow response on Arm A or B. Copyright (c) 2005 Blackwell Publishing Ltd, *British Journal of Haematology*.

**Table 14.9** Patient diagnostic characteristics.

	ALL 97 (Not HR1)		ALL 99		
	Prednisolone	Dexamethasone	Prednisolone	Dexamethasone	Total
Gender					
M	195	196	240	236	867 (54%)
F	197	193	173	173	736 (46%)
Age (years)					
<2	34	32	29	29	124 (8%)
2–9	311	306	301	301	1219 (76%)
≥10	47	51	83	79	260 (16%)
WBC (×10 <sup>9</sup> /l)					
<10	208	196	198	199	801 (50%)
10–19	63	64	55	66	248 (15%)
20–49	59	71	67	55	252 (16%)
50–99	36	29	37	52	154 (10%)
≥100	26	29	56	37	148 (9%)
Ph+ or bcr-abl+	1	0	11	10	22 (1%)
t(4; 11)	1	0	5	4	10 (0.6%)
11q23/MLL rearrangement	1	2	8	4	15 (1%)



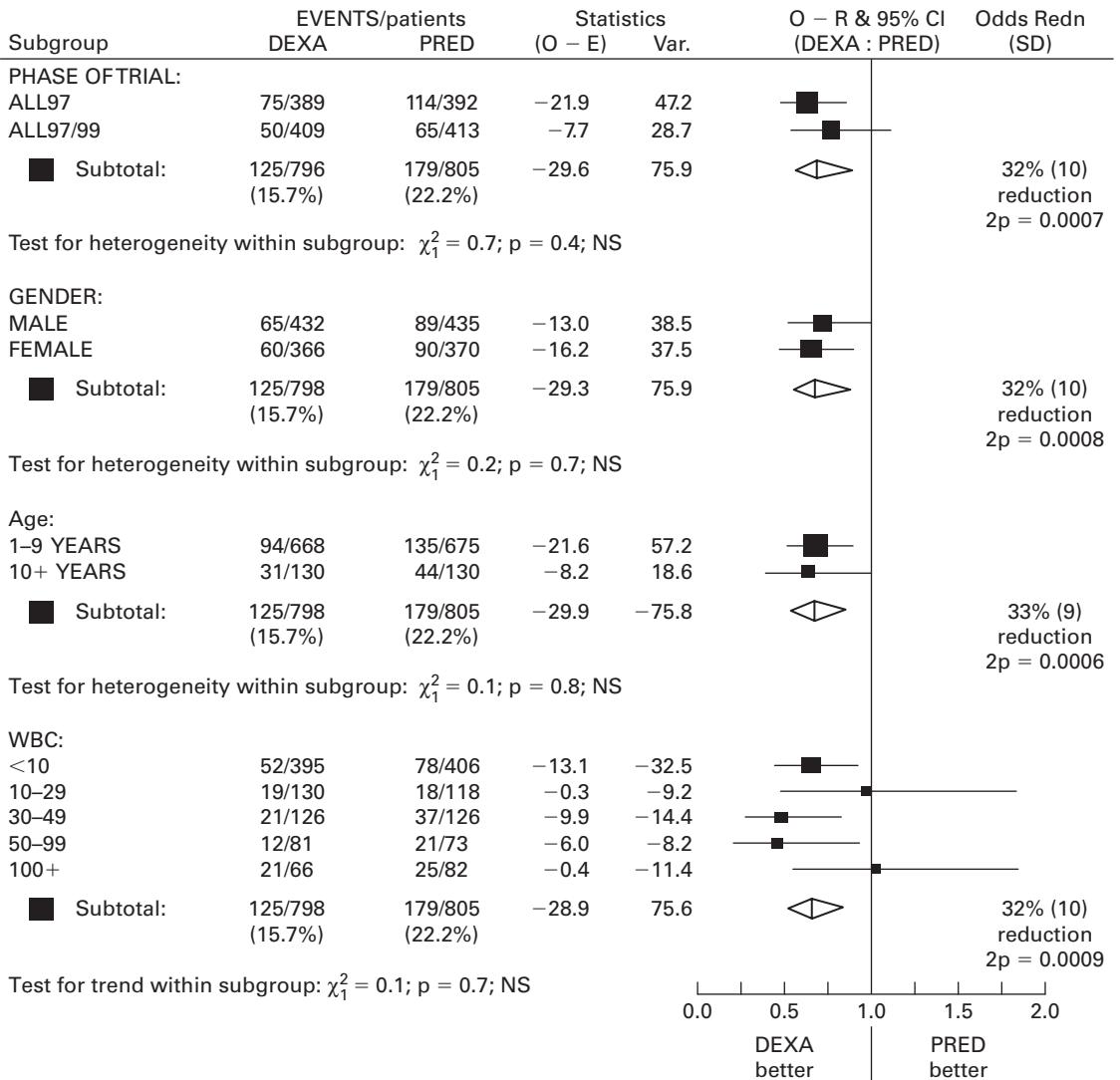
**Figure 14.4** Isolated CNS relapses according to randomized steroid. Reprinted with permission (see Figure 14.3).

There was no significant difference in induction or remission deaths between the two groups of patients (Table 14.10).

The 5-year EFS was 84.2% (95% CI = 81.5–86.9%) for the dexamethasone group compared to 75.6% (95% CI = 72.3–78.9%) for the prednisolone group (Figure 14.6). However, the 5-year OS was not significantly different between dexamethasone group (89% (95%

CI = 86.6–91.3%)) and prednisolone group (85.8% (95% CI = 83.1–88.5%)). Analyses stratified by thiopurine-type and background treatment (ALL 97, ALL 97/99 regimens A, B and C) gave similar results.

The 5-year EFS for the first phase of the ALL 97 trial was 74.1% (95% CI = 74.1–76.6%) compared with 63.1% for the UK ALL XI trial (95% CI = 60.9–65.3%). Though the follow-up for the second phase of the trial



**Figure 14.5** Forest plot showing the relative effect on EFS of steroid type within subgroups. The observed minus expected (O - E) number of events and its variance (Var.) are given for each subgroup. The odds ratio, calculated from these data, is shown as a filled box, with a line indicating the 95% CI. The overall effect after stratification by each subgroup variable is shown as a diamond

whose width indicates the 95% CI of the overall result. The results of tests for heterogeneity, or trend in the case of WBC, are displayed to indicate any evidence of a different effect in any subgroup. DEXA: dexamethasone and PRED: prednisolone. Reprinted with permission (see Figure 14.3).

(ALL 99) was short, nevertheless the 5-year EFS showed further improvement (Figure 14.7).

### Steroid toxicity

There was a significant excess of overall toxicity in patients who were randomized to dexamethasone (11%

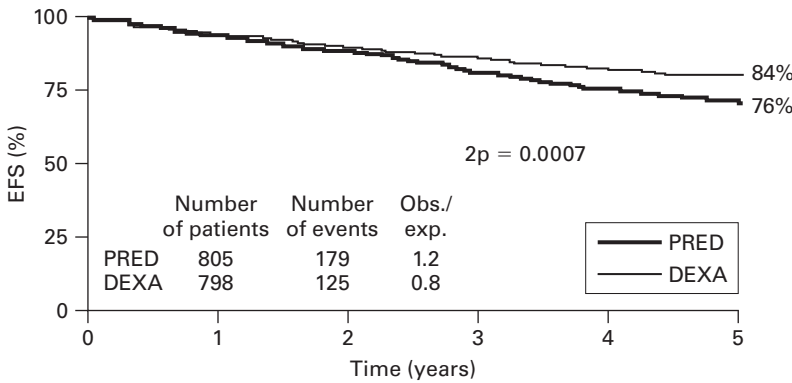
versus 5% with prednisolone). Table 14.11 shows the relative incidence of recorded toxicity by randomized steroid. Behavioral problems were more commonly seen in the dexamethasone group (6% versus 1%). Similarly, the incidence of myopathy was 5-fold higher in the dexamethasone group (2.8% versus 0.5%).

**Table 14.10** Outcome by steroid randomization.

	<b>Prednisolone (n = 805)</b>	<b>Dexamethasone (n = 798)</b>	<b>O – E</b>	<b>V</b>	<b>OR (95% CI)</b>	<b>2p</b>
Isolated CNS relapse	36 (5.0%)	17 (2.5%)	-9.70	13.25	0.48 (0.28–0.82)	0.007
No remission	3 (0.4%)	8 (1.0%)	2.52	2.73	2.52 (0.77–8.24)	0.1
Any CNS relapse	64 (9.5%)	31 (4.8%)	-17.18	23.74	0.48 (0.34–0.72)	0.0004
Non-CNS relapse	89 (13.6%)	55 (6.9%)	-18.75	35.95	0.59 (0.43–0.82)	0.002
Death in remission	23 (3.0%)	31 (4.1%)	4.00	13.50	1.34 (0.79–2.29)	0.3
Any event	179 (24.4%)	125 (15.8%)	-29.41	75.93	0.68 (0.54–0.85)	0.0007
Any death	101 (14.2%)	82 (11.0%)	-9.42	45.74	0.81 (0.61–1.09)	0.2

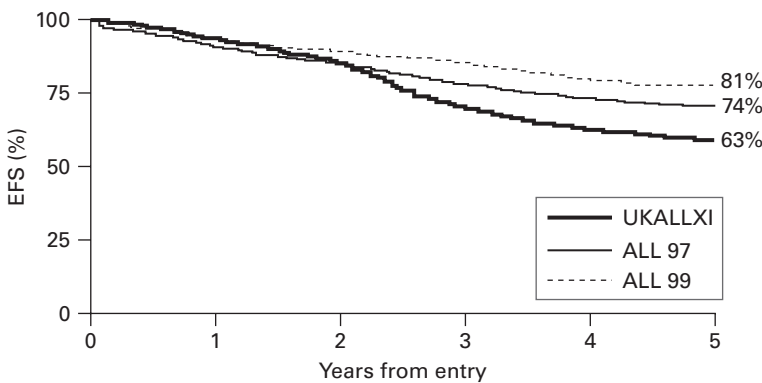
Total numbers of events, and (in brackets) actuarial percentages at 5 years by randomized steroid allocation.

O: observed; E: expected; V: variance; OR (95% CI): odds ratio with 95% confidence limits and 2p: double-sided p value. Copyright © 2005 Blackwell Publishing Ltd, *British Journal of Haematology*.



At risk		0	1	2	3	4	5
PRED	805	763	727	582	416	280	
DEXA	798	760	729	614	457	320	

**Figure 14.6** EFS by randomized steroid. Reprinted with permission (see Figure 14.3).



At risk		0	1	2	3	4	5
UKALLXI	2090	1979	1819	1511	1371	1310	
ALL 97	997	919	863	801	756	731	
ALL 99	938	889	848	615	280	0	

**Figure 14.7** EFS by treatment protocol. Reprinted with permission (see Figure 14.3).

**Table 14.11** Numbers of patients with grade III/IV steroid toxicity by randomized steroid.

	ALL 97		ALL 99		Total		Relative risk (95% CI)
	DEXA (n = 389)	PRED (n = 392)	DEXA (n = 409)	PRED (n = 413)	DEXA (n = 798)	PRED (n = 805)	
Behavior***	26	2	21	9	47	11	4.31 (2.25–8.26)
Hypertension	4	0	2	4	6	4	1.51 (0.43–5.35)
Diabetes	6	2	7	10	13	12	1.09 (0.50–2.38)
Myopathy**	13	1	9	3	22	4	5.55 (1.92–16.04)
AVN	1	1	5	8	6	9	0.67 (0.24–1.88)
Osteopenia*	4	1	3	0	7	1	7.06 (0.87–57.18)
Other*	2	0	5	1	7	1	7.07 (0.87–56.27)
Any†,***	43	7	46	32	89	39	2.30 (1.60–3.31)
Any, excluding behavior†,*	22	5	28	25	50	30	1.68 (1.08–2.62)

The relative risk of toxicity with dexamethasone (DEXA) compared with prednisolone (PRED) was greater in ALL 97 for behavior ( $p = 0.02$ ), any toxicity ( $p = 0.001$ ) and any toxicity excluding behavior ( $p = 0.01$ ).

\* $p < 0.05$ ; \*\* $p < 0.001$ ; \*\*\* $p < 0.0001$ .

†Numbers do not add up to total as some patients had more than one type of toxicity.

Copyright © 2005 Blackwell Publishing Ltd, *British Journal of Haematology*.

**Table 14.12** Early deaths (<60 days) by randomized steroid, phase of trial (ALL 97 or ALL 99) and treatment regimen excluding ALL HR1 patients.

Steroid	Rand D	Rand P	Non-rand D	Non-rand P		
Early deaths	14	6	0	2		
Total	798	805	16	165		
Age (years)	<2		2–9		10+	
Steroid	Rand D	Rand P	Rand D	Rand P	Rand D	Rand P
Early deaths	0	1	11	4	3	1
Total	61	63	607	612	130	130
Trial	ALL 97		ALL 99			
Steroid	Rand D	Rand P	Rand D	Rand P	Rand D	Rand P
Early deaths	11		4	3		2
Total	389		392	409		413
	Initial regimen		Final regimen			
Treatment regimen	A	B	A	B	C	
Early deaths	4	3	2	2	3	
Total	577	361	557	231	150	

There were no significant differences between treatment groups or age groups.

D: dexamethasone; P: prednisolone and Rand: randomized.

Severe osteopenia was rare but was almost exclusively limited to patients randomized to dexamethasone. However, there was no excess of avascular necrosis (AVN) in the dexamethasone group. AVN was more frequent in the older children, in girls and in the second phase of the trial (ALL 99).

There was a significant interaction for all toxicities combined ( $p < 0.001$ ) with increasing incidence with age and no toxicity under 2 years in the prednisolone arm. There was no such increase of toxicity with age in the dexamethasone arm.

The number of early deaths are shown in Table 14.12. There were no statistically significant differences between the two groups whether analyzed by age or treatment arm.

### Conclusion

It was concluded that dexamethasone, despite its increased toxicity, significantly reduced the incidence of isolated and overall CNS relapses and significantly improved EFS. The group also recommended that dexamethasone should be standard therapy for childhood ALL.

## Study 4

Bruce C. Bostrom, Martha R. Sensel, Harland N. Sather, Paul S. Gaynon, Mei K. La, Katherine Johnston, Gary R. Erdmann, Stuart Gold, Nyla A. Heerema, Raymond J. Hutchinson, Arthur J. Provisor, Michael E. Trigg. Dexamethasone versus prednisone and daily oral versus weekly intravenous mercaptopurine for patients with standard-risk acute lymphoblastic leukemia: a report from the Children's Cancer Group. *Blood* 2003;101; 3809–17.

### Study design

This was a Children's Cancer Group (CCG-1922) trial and was a prospective randomized study. The trial was open to recruitment from March 1993 to August 1995.

### Objectives

The objectives were:

- To determine whether dexamethasone was superior to prednisone in the prevention of central nervous system (CNS) relapse of leukemia and also improve event-free survival (EFS) in children with standard risk acute lymphoblastic leukemia (SR-ALL).
- To assess the efficacy of intravenous 6-mercaptopurine (IV 6-MP) during consolidation phase of therapy in children with SR-ALL.

This report focuses on the efficacy of dexamethasone in the treatment of childhood ALL.

### Details of the study

Previously untreated children with acute lymphoblastic leukemia (ALL), aged between 1 and 10 years with a white blood cell (WBC) count  $< 50 \times 10^9/l$  were eligible for enrollment onto the study. Children with mature B cell ALL (French-American-British (FAB) L3 morphology) or lymphoma syndrome (massive lymphadenopathy, massive splenomegaly, large mediastinal mass or any one of the following laboratory abnormalities: WBC counts  $> 50 \times 10^9/l$ , hemoglobin  $> 10$  g% or  $> 25\%$  CD2+ blasts) were excluded from the study.

During the first 6 months of the study, a subset of standard risk (SR) patients (1 to  $< 2$  years of age with a WBC counts  $< 50 \times 10^9/l$ ; 2 to  $< 10$  years of age with a WBC counts of  $10 \times 10^9/l$   $< 50 \times 10^9/l$ , and boys between 2 and  $< 10$  years of age with a WBC counts  $< 10 \times 10^9/l$  and platelet counts  $< 100 \times 10^9/l$ ) were enrolled in the CCG-1891 study for intermediate risk ALL when the study closed.

The National Cancer Institute (NCI) and the local institutional review boards had approved the treatment protocol and written informed consent was obtained from parents/guardians or patients as per national guidelines. Details of the treatment regimen are shown in Table 14.13. All patients were randomly assigned at diagnosis to one of four treatment arms ( $2 \times 2$  factorial design) as shown in Figure 14.8. All patients required having either M1 ( $< 5\%$  blasts) or M2 (5–25% blasts) marrow status by the end of induction to remain on the trial. Patients, who had M2 marrow at the end of induction, required a M1 marrow

**Table 14.13** Treatment schema.

Induction (1 month)	
Regimens OP and IP	Oral prednisone (40 mg/m <sup>2</sup> /day), vincristine (1.5 mg/m <sup>2</sup> on days 0, 7, 14 and 21), intramuscular native L-asparaginase (6000 U/M <sup>2</sup> , 3 times weekly for 9 doses, starting on days 2–4), and age-adjusted intrathecal methotrexate (age 1 to <2 years, 8 mg; age 2 to <3 years, 10 mg; >3 years, 12 mg on days 0 and 14). Patients with CNS disease at diagnosis also received intrathecal methotrexate on days 7 and 21.
Regimens OD and ID	Oral dexamethasone (6 mg/m <sup>2</sup> /day in 3 equal doses) was substituted for prednisone.
Consolidation (3 months)	
Regimen OP	Oral mercaptopurine (75 mg/m <sup>2</sup> /day on days 0–70), oral prednisone (40 mg/m <sup>2</sup> on days 28–32 and 56–60), IV vincristine (1.5 mg/m <sup>2</sup> on days 0, 28 and 56), oral methotrexate (20 mg/m <sup>2</sup> on days 28, 35, 42, 49, 56, 63 and 70) and age-adjusted (see above) intrathecal methotrexate on days 0, 7, 14 and 21 for patients without CNS disease at diagnosis and on days 0 and 7 for patients with CNS disease at diagnosis.
Regimen IP	Modification of Regimen OP, substituting IV mercaptopurine (1000 mg/m <sup>2</sup> ) over 10 hours on days 0, 7, 14, 21, 28, 35, 42, 49, 56, 63 and 70) for oral.
Regimen OD	Modification of Regimen OP, substituting dexamethasone (6 mg/m <sup>2</sup> /day on days 28–32 and 56–60) for prednisone.
Regimen ID	Modification of Regimen OP, substituting IV mercaptopurine for oral as in Regimen IP and dexamethasone for prednisone as in Regimen OD.
Delayed intensification (2 months)	
	Oral dexamethasone in all patients (10 mg/m <sup>2</sup> /day for 21 days plus a 7-day taper), IV vincristine (1.5 mg/m <sup>2</sup> on days 0, 7 and 14), intramuscular native L-asparaginase (6000 U/m <sup>2</sup> for 6 doses given M/W/F on days 3–17), doxorubicin (25 mg/m <sup>2</sup> , IV push, on days 0, 7 and 14), IV cyclophosphamide (1000 mg/m <sup>2</sup> over 30 minutes on day 28), oral 6-thioguanine (60 mg/m <sup>2</sup> /day on days 28–41), cytarabine (75 mg/m <sup>2</sup> /day, IV push, on days 29–32 and 36–39) and age-adjusted intrathecal methotrexate on day 28.
Maintenance (girls, 20 months; boys, 32 months)	
Regimens OP and IP	Oral prednisone (40 mg/m <sup>2</sup> on days 0–4, 28–32 and 56–60), oral mercaptopurine in all patients (75 mg/m <sup>2</sup> /day on days 0–83), IV vincristine (1.5 mg/m <sup>2</sup> on days 0, 28 and 56), weekly oral methotrexate (20 mg/m <sup>2</sup> beginning on day 7 of each course), and age-adjusted intrathecal methotrexate (see above) on day 0 of each course.
Regimens OD and ID	Dexamethasone (6 mg/m <sup>2</sup> /day on days 0–4, 28–32 and 56–60) was substituted for prednisone.

M: Monday; W: Wednesday and F: Friday.

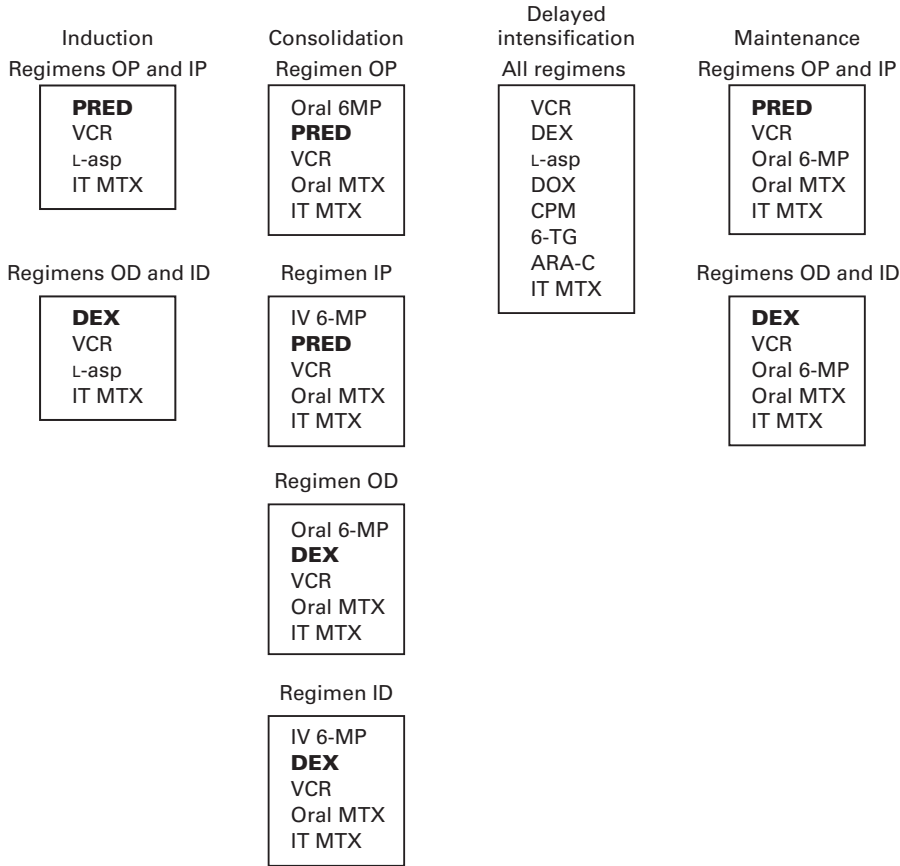
status by day 14 of consolidation to continue on study. The total duration of treatment for boys was 38 months and 26 months for girls.

Treatment was interrupted only if the hepatic transaminases were >1000 units/l on two occasions 1 week apart or if the serum bilirubin was >0.02 g/l. Similarly, maintenance therapy was interrupted if the absolute neutrophil count (ANC) was <0.75 × 10<sup>9</sup>/l or if the platelet count was <75 × 10<sup>9</sup>/l.

## Statistics

Sample size and power calculations were based on a proportional hazard assumption for the treatment

regimen, with few treatment failures assumed after 5 years of follow-up. An accrual of 1050 randomized patients were planned to have in excess of 80% power (two-sided log rank test) to detect a change in 5-year EFS from an assumed 80% baseline to 87.5%, representing a relative risk (RR) of 0.598 for the better regimen. The study also had a power >80% (two-sided Gray statistic) for detecting a change in the incidence of central nervous system (CNS) relapse rate from 10% to 5%, representing an RR of 0.487 for the better regimen. Patients were randomized at diagnosis. Data were analyzed in July 2001 using January 2001 as the cut-off. All analysis was by intention to treat. Event-free



**Figure 14.8** Details of CCG 1922 treatment schema. DEX: dexamethasone; VCR: vincristine; L-ASP: asparaginase; IT MTX: intrathecal methotrexate; IV 6-MP: intravenous 6 mercaptopurine; PRED: prednisolone; Oral MTX: Oral methotrexate; DOX: doxorubicin; CPM: cyclophosphamide; 6-TG: 6 thioguanine; ARA-C: cytosine arabinoside; Oral 6-MP: oral 6-mercaptopurine; OD: oral 6 mercaptopurine/dexamethasone; ID: intravenous 6-mercaptopurine/dexamethasone; OP: oral 6 mercaptopurine/prednisolone; IP: intravenous 6-mercaptopurine/prednisolone. Reproduced with permission of the American Society of Hematology (full reference on p. 295).

(EFS) and overall survival (OS) life table estimates were done by the Kaplan–Meier (KM) method. The standard deviation of KM estimate was calculated using the Peto variance formula. Relative hazard rates were estimated by the log rank observed by expected (O/E) method. Chi-square tests for homogeneity of distributions were used in some comparisons. Multivariate analyses of prognostic factors were done with the Cox proportional hazards model.

### Definitions

M1 marrow <5% blasts  
 M2 marrow 5–25% blasts  
 M3 marrow >25% blasts

### Outcome measures

The outcome measures were EFS, OS and isolated CNS relapse rate.

### Outcome

One thousand and eighty patients were entered onto the trial of whom 19 were excluded as they were deemed ineligible because of lack of consent or incorrect diagnosis and 1 due to incorrect randomization. Of the remaining 1060 patients, 530 were randomized to dexamethasone and 530 to prednisolone. Patient characteristics were not significantly different between the two groups and are shown in Table 14.14.



**Table 14.14** Presenting features of children with SR-ALL.

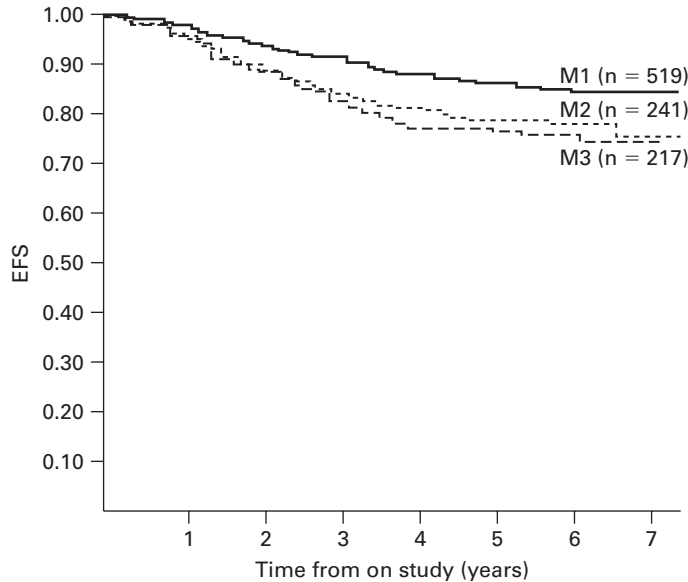
	OP (N = 270)		IP (N = 260)		OD (N = 274)		ID (N = 256)		p <sup>a</sup>
	N	(%)	N	(%)	N	(%)	N	(%)	
Age (years)									0.84
1 to <2	24	(9)	20	(8)	26	(10)	20	(8)	
2 to <4	120	(44)	108	(42)	108	(40)	115	(45)	
4 to <10	126	(47)	131	(50)	140	(51)	121	(47)	
WBC count ( $\times 10^9/l$ )									0.71
<20	230	(85)	220	(85)	226	(83)	210	(82)	
20–49	40	(15)	40	(15)	48	(18)	46	(18)	
Gender									0.25
Male	136	(50)	145	(56)	148	(54)	122	(48)	
Female	134	(50)	115	(44)	126	(46)	134	(52)	
Race									0.23
White	195	(76)	190	(76)	213	(79)	197	(79)	
Black	14	(5)	10	(4)	13	(5)	11	(4)	
Hispanic	39	(15)	43	(17)	30	(11)	37	(15)	
Other	9	(4)	8	(3)	15	(6)	3	(1)	
Down's syndrome									0.25
Yes	7	(3)	1	(0)	5	(2)	5	(2)	
No	263	(97)	258	(100)	269	(98)	251	(98)	
Liver <sup>b</sup>									0.50
Normal	133	(49)	143	(55)	144	(53)	124	(49)	
Moderately enlarged	130	(48)	107	(41)	119	(43)	125	(49)	
Markedly enlarged	7	(7)	9	(4)	11	(4)	6	(2)	
Spleen <sup>b</sup>									0.62
Normal	151	(56)	164	(64)	162	(59)	152	(60)	
Moderately enlarged	110	(41)	285	(33)	105	(38)	93	(37)	
Markedly enlarged	9	(3)	9	(4)	7	(3)	10	(4)	
Lymph nodes <sup>c</sup>									0.25
Normal	144	(53)	159	(61)	148	(54)	149	(58)	
Moderately enlarged	122	(45)	98	(38)	119	(43)	100	(39)	
Markedly enlarged	4	(2)	2	(2)	7	(3)	7	(3)	

Mediastinal mass									0.05
Absent	247	(92)	249	(96)	260	(95)	232	(93)	
Present	23	(9)	11	(4)	14	(5)	24	(7)	
Hemoglobin level (g/dl)									0.36
1–7.9	178	(66)	153	(60)	180	(67)	170	(67)	
8.0–10.9	80	(30)	85	(33)	74	(28)	71	(28)	
≥11.0	10	(4)	19	(7)	14	(5)	13	(5)	
Platelet count ( $\times 10^9/l$ )									0.24
1–49	138	(51)	105	(41)	125	(46)	125	(49)	
50–149	72	(27)	90	(35)	90	(33)	80	(31)	
≥150	60	(22)	64	(25)	59	(22)	51	(20)	
CNS disease at diagnosis									0.11
Yes	0	(0)	5	(2)	5	(2)	2	(1)	
No	269	(100)	249	(98)	263	(98)	252	(99)	
immunophenotype									0.10
B lineage	133	(99)	143	(97)	148	(97)	121	(93)	
T lineage	2	(2)	4	(3)	5	(3)	9	(7)	
Ploidy group									0.74
Normal	28	(32)	31	(33)	40	(39)	28	(30)	
Pseudodiploid	7	(8)	3	(3)	6	(6)	6	(7)	
Hypodiploid	17	(19)	19	(20)	21	(20)	23	(25)	
Hyperdiploid (47–50)	5	(6)	8	(9)	10	(10)	11	(12)	
Hyperdiploid (>50)	31	(35)	32	(34)	26	(25)	24	(26)	
t (4; 11) (q21; q23)									
Yes	1	(1)	0	(0)	0	(0)	0	(0)	
No	87	(99)	93	(100)	103	(100)	92	(100)	
t (9; 22) (q34; q11)									
Yes	3	(3)	1	(1)	1	(1)	1	(0)	
No	85	(97)	92	(99)	102	(99)	91	(100)	
t (1; 19)(q23; p13)									
Yes	1	(1)	1	(1)	3	(3)	3	(3)	
No	87	(99)	92	(99)	100	(97)	89	(97)	

<sup>a</sup>Chi-square test.

<sup>b</sup>Moderately enlarged, enlarged but above the umbilicus; markedly enlarged, organ below the umbilicus.

<sup>c</sup>Normal, shoddy nodes; markedly enlarged, visible nodes; moderate enlargement, neither normal nor markedly enlarged.



**Figure 14.9** EFS by day 7 bone marrow response. The 6-year EFS  $\pm$  SD was  $85\% \pm 2\%$  for M1 (<5% blasts, solid line);  $79\% \pm 3\%$  for M2 (5-25% blasts, dotted line) and  $76\% \pm 3\%$  for M3 (<25% blasts, dashed line) ( $p = 0.002$ ). Reproduced with permission of the American Society of Hematology (full reference on p. 295).

At risk	0	1	2	3	4	5	6	7
M1	519	507	488	464	427	395	258	59
M2	241	231	216	204	189	176	122	26
M3	217	206	194	179	153	143	85	22

### Bone marrow response

There was no difference in either the day 7 or at the end of induction marrow status by randomized steroid. Poor marrow response on day 7 of treatment was an adverse prognostic factor (Figure 14.9).

### Relapse site

Isolated CNS relapses were lower in the dexamethasone arm compared to the prednisolone arm (6-year cumulative estimates being dexamethasone,  $3.7 \pm 0.8\%$  versus prednisolone,  $7.1 \pm 1.1\%$ ;  $p = 0.01$ ) (Figure 14.10). In addition, patients randomized to dexamethasone showed a trend toward fewer bone marrow relapses, with 6-year estimates of  $7.9 \pm 1.3\%$  versus  $11.1 \pm 1.5\%$  ( $p = 0.08$ ). Table 14.15 shows the events by treatment regimen.

### Prognostic factors

Patients randomized to dexamethasone had a better 6-year EFS compared to prednisolone for patients with day 7 M1 marrow status ( $89 \pm 2\%$  versus  $82 \pm 3\%$ ), M2 marrow status ( $83 \pm 4\%$  versus  $77 \pm 4\%$ ) and M3 marrow status ( $82 \pm 4\%$  versus  $71 \pm 4\%$ ).

### EFS and OS

The 6-year EFS and OS for the entire cohort was  $81 \pm 2\%$  and  $92 \pm 1\%$ , respectively.

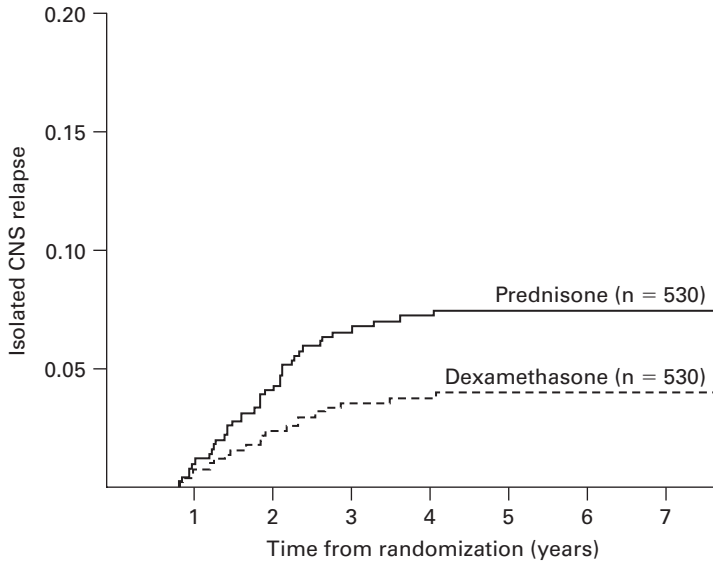
The 6-year EFS for patients randomized to dexamethasone was  $85 \pm 2\%$  versus  $77 \pm 2\%$  for prednisolone ( $p = 0.002$ , RR 0.65; Figure 14.11).

The 6-year OS was similar for both groups of patients (dexamethasone group,  $93 \pm 1\%$  versus prednisolone group,  $91 \pm 1\%$ ,  $p = 0.17$ , RR 0.74).

### Toxicity

Both groups of patients had identical incidences of bacteraemia during induction (13%) and also similar incidences of fever, neutropenia, duration of hospital stay and supportive care interventions; 6 patients died of infections during induction or shortly thereafter: 2 in the prednisolone arm and 4 in the dexamethasone arm.

During intensification when all patients receive dexamethasone, 5 died due to infectious complications (4 prednisolone assigned patients and 1 dexamethasone assigned).



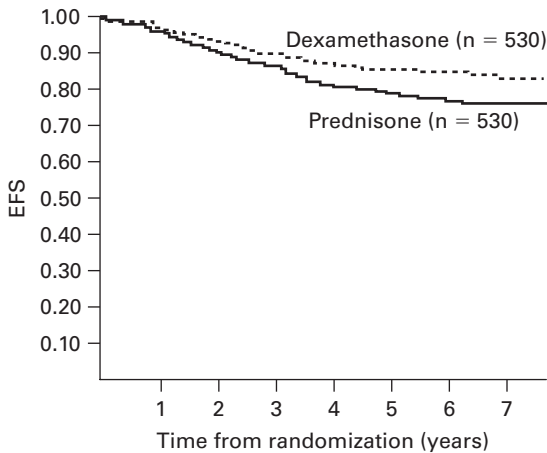
**Figure 14.10** Isolated CNS relapse by randomized steroid. The 6-year risk of isolated CNS relapse  $\pm$  SE is  $3.7\% \pm 0.8\%$  in patients randomized to receive dexamethasone and  $7.1\% \pm 1.1\%$  in patients randomized to receive prednisone ( $p = 0.01$ ). Reproduced with permission of the American Society of Hematology (full reference on p. 295).

At risk								
PRED	530	508	478	447	396	368	234	52
DEX	530	511	493	465	430	400	268	63

**Table 14.15** First event by randomized treatment regimen.

	OP	IP	OD	ID	All
Number randomized	270	260	274	256	1060
Marrow relapse	31	33	20	28	112
Isolated CNS relapse	17	20	10	10	57
Testicular relapse	2	1	1	0	4
Other relapse	0	1	0	0	1
Second malignancy	1	2	0	0	3
Death	6	3	4	4	17
Induction failure	0	1	2	0	3
Total events	57	61	37	42	197
Expected events	49.4	47.1	52.2	48.3	NA
Event ratio (total to expected)	1.15	1.3	0.71	0.87	NA
6-year EFS $\pm$ SE	$78\% \pm 3\%$	$77\% \pm 3\%$	$86 \pm 2\%$	$84 \pm 2\%$	$81 \pm 2\%$

NA: not applicable.



## At risk

PRED	530	508	478	447	396	388	234	52
DEX	520	511	493	465	430	400	268	63

**Figure 14.11** EFS by randomized treatment. (a) EFS by randomized steroid. The 6-year EFS  $\pm$  standard error is  $85\% \pm 2\%$  in patients randomized to dexamethasone (DEX) and  $77\% \pm 2\%$  in patients randomized to prednisone (PRED) ( $p = 0.002$ ). Reproduced with permission of the American Society of Hematology (full reference on p. 295).

The incidence of grades 1–3 of myopathy during induction and consolidation was higher in the dexamethasone group (6.3% versus 1.5%;  $p < 0.0001$  by Chi-square). Grade 3 weakness (inability to walk) was

seen in 22 (4.1%) patients in the dexamethasone group compared to 2 (0.3%) in the prednisolone group ( $p < 0.0001$  by Chi-square).

Symptomatic pancreatitis was reported in 5 patients in the dexamethasone arm compared to 1 in the prednisolone group.

The incidence of grades 3 and 4 hyperglycemia was higher in the dexamethasone group (26/528; 5%) compared to those who received prednisolone (8/529, 1.5%;  $p = 0.001$ ).

Neuropsychiatric problems were almost entirely seen in those randomized to receive dexamethasone and 6 patients switched from dexamethasone to prednisolone.

### Conclusion

It was concluded that despite its increased toxicity, dexamethasone significantly reduced the incidence of isolated CNS relapses and improved the EFS in children with ALL.

## Study 5

Shunji Igarashi, Atsushi Manabe, Akira Ohara, Masaaki Kumagai, Tomohiro Saito, Yuri Okimoto, Takehiko Kamijo, Keiichi Isoyama, Michiko Kajiwara, Manabu Sotomatsu, Ken-ichi Sugita, Kanji Sugita, Miho Maeda, Hiromasa Yabe, Akitoshi Kinoshita, Takashi Kaneko, Yasuhide Hayashi, Kouichiro Ikuta, Ryohji Hanada, Masahiro Tsuchida. No advantage of dexamethasone over prednisolone for the outcome of standard- and intermediate-risk childhood acute lymphoblastic leukemia in the Tokyo Children's Cancer Study Group L95-14 Protocol. *J Clin Oncol* 2005;23:6489–98.

### Study design

The Tokyo Children's Cancer Study Group (TCCSG) trial L95-14 trial was a prospective randomized controlled study that was conducted between March 1995 and March 1999.

### Details of the study

Previously untreated children with acute lymphoblastic leukemia (ALL), aged between 1 and 10 years with a white blood cell (WBC) count  $< 100 \times 10^9/l$  were eligible for enrollment onto the study. Children with mature B cell ALL (FAB L3 morphology), mediastinal mass, meningeal infiltration or with cytogenetic abnormalities such as t(9; 22), t(1; 19) or *MLL* (11q23)

## Objectives

The objectives were:

- To determine whether dexamethasone (DEX) was superior to prednisolone (PDN) both in preventing central nervous system (CNS) relapse of leukemia as well as.
- To improve the event-free survival (EFS) in children with standard (SR) and intermediate risk (IR) acute lymphoblastic leukemia (ALL).

gene rearrangement were categorized as high risk and were excluded from the study.

## Definitions

SR-ALL: A patient with a non-T phenotype ALL, who was between 1 and 6 years of age and with a WBC count at diagnosis that was  $<20 \times 10^9/l$

IR-ALL: A patient between 1 and 6 years of age and with a WBC count at diagnosis that was between 20 and  $100 \times 10^9/l$ ; or, a child between the 7 and 9 years of age who had had WBC count at diagnosis that was  $<20 \times 10^9/l$ ; or, a child who fulfilled the definition of SR-ALL except had a T cell phenotype.

## Treatment regimen

The protocol was approved the local institutional review boards of all the participating institutions. Details of the treatment protocol are shown in Tables 14.16 and 14.17. In each risk group, children were randomized to receive either dexamethasone (DEX) or prednisolone (PDN) at diagnosis. Remission induction therapy consisted of a standard four drug regimen comprising vincristine, doxorubicin, L-asparaginase and corticosteroids (PDN or DEX) along with triple intrathecal chemotherapy (Table 14.17). IR patients who had a presenting WBC count  $>50 \times 10^9/l$  received 18-Gy prophylactic cranial radiotherapy while all other IR patients received intravenous high dose methotrexate for central nervous system (CNS) prophylaxis. Maintenance chemotherapy consisted of oral 6-mercaptopurine and oral methotrexate. The treatment schema of the L95-14 protocol is shown in Figures 14.12 and 14.13.

## Statistics

Patients who did not achieve complete remission (CR) by the end of induction or died before confirmation of remission were deemed as treatment failure at day 0. Event-free survival (EFS) was estimated by the Kaplan–Meier method and tested for significant difference by the log rank test. All analyses of results were performed on the basis of intention to treat.

## Outcome measures

The main outcome measures were CNS relapse rate and EFS.

## Outcome

### Study population

Three hundred and fifty-nine patients were entered to L95-14 study of whom 231 patients were categorized as SR-ALL and the remaining 128 patients as IR-ALL. In the SR group, 114 were randomized to receive PDN and 117 to DEX while in the IR group, 66 were randomized to PDN arm and the remaining 62 to the DEX arm. Patient characteristics are shown in Table 14.18. Although there were no significant differences between the PDN and DEX arms, patients in the PDN arm of the SR group had a higher presenting WBC count than those in the DEX arm.

### Protocol violations

Three SR and two IR patients who were randomized to the DEX arm received PDN while one IR patient who was assigned to the PDN arm received DEX.

### Treatment results

Of the 359 patients registered in the trial, 352 (98%) achieved CR. The CR rates in the four groups of patients were 98.3% in the SR DEX arm, 99.1% in the SR PDN arm, 95.2% in the IR DEX arm and 98.5% in the IR PDN arm (Table 14.19).

Extramedullary relapses in the SR group were seen exclusively in patients randomized to PDN (6 versus 0) while in the IR group, one patient in the DEX arm had an isolated CNS relapse and another had a combined bone marrow and CNS relapse (Table 14.19). All 18 relapses in the SR DEX arm were bone marrow relapses. In addition, there were no significant

**Table 14.16** Treatment for the TCCSG L95-14 SR group.

Treatment Element/Drug	Single or Daily Dose	Days Administered
<b>Induction therapy</b>		
Prednisolone, oral	60 mg/day (maximum, 80 mg)	Day 3 ~ days 1–28, with a 7-day taper
Dexamethasone, oral	8 mg (maximum, 10 mg)	Substituted for prednisolone
Vincristine, IV	1.5 mg (maximum, 2 mg)	Days 1, 8, 15, 22, 29
THP doxorubicin, IV	20 mg	Days 8, 15
L-asparaginase, IV	6000 U	3 times weekly for 9 doses starting on day 15
Age-adjusted intrathecal methotrexate and hydrocortisone		Days 8, 22
<b>Early consolidation</b>		
Cytarabine, IV	75 mg/day	5 times weekly for 15 dose, on days 1–5, 8–12, 15–19
Mercaptopurine, oral	60 mg/day	For 21 days, on days 1–21
Cyclophosphamide, 2-hour infusion	1000 mg	Day 1
Age-adjusted intrathecal methotrexate, hydrocortisone and cytarabine		
<b>High dose methotrexate</b>		
Methotrexate	3 g	3 times: 12-hour infusion on day 1 and 24-hour infusion twice, 7–10 days after day 1
Age-adjusted intrathecal methotrexate and hydrocortisone		
<b>Maintenance</b>		
Mercaptopurine, oral	60 mg/day	For 14 days
Methotrexate, oral		
<b>Re-induction</b>		
Prednisolone, oral	40 mg/day	Days 1–14
Dexamethasone, oral	6 mg/day	Substituted for prednisolone
Vincristine, IV	1.5 mg (maximum, 2 mg)	Days 1, 8, 15
THP-doxorubicin, IV	20 mg	Days 1, 8, 15
L-asparaginase, SC	10,000 U	2 time weekly for 4 doses
<b>Intensive reconsolidation</b>		
Cytarabine, IV	75 mg/day	5 times weekly for 10 doses on days 1–5, 8–12
Mercaptopurine, oral	60 mg/day	For 14 days, on days 1–14
Cyclophosphamide, 2-hour infusion	1000 mg	Day 1
<b>Intermediate dose methotrexate</b>		
	500 mg	3 times, 6-hour infusion
<b>Intensive therapy<sup>a</sup></b>		
Prednisolone, oral	40 mg/day	3 times
Dexamethasone, oral	6 mg/day	Days 1-14
Vincristine, IV	1.5 mg (maximum, 2 mg)	Substituted for prednisolone
L-asparaginase, SC	10,000 U	Days 1, 8, 15
		Days 8, 15
<b>Intermittent maintenance</b>		
Mercaptopurine, oral	80 mg/day	13 times for 5 days, 2-week interval
Methotrexate, IV	50 mg	13 times, 2-week interval
	6 Mercaptopurine 80–90–100–110–120 gradual dose increment	
	Methotrexate 50-60-70-80-90 <sup>b</sup>	
<b>Continuous maintenance</b>		
Mercaptopurine, oral	40–60 mg/day <sup>b</sup>	<sup>c</sup>
Methotrexate, oral	25–30 mg weekly dose <sup>b</sup>	<sup>c</sup>

IV: intravenous; SC: subcutaneous and THP: 4'-O-tetrahydropyranyl.

<sup>a</sup>Intermediate dose methotrexate and intensive therapy are repeated 3 times alternately.

<sup>b</sup>Adjust the dosage for WBC between  $2.5$  and  $3.5 \times 10^9/l$ .

<sup>c</sup>From the end of the intermittent maintenance therapy to 2 years after the start of treatment, for about 34 weeks.

**Table 14.17** Treatment for the TCCSG L95-14 IR group.

Treatment Element/Drug	Single or Daily Dose	Days Administered
<b>Induction therapy</b>		
Prednisolone, oral	60 mg/d (max, 80 mg)	Day 3 ~ day 1–28, with a 7-day taper
Dexamethasone, oral	8 mg (max, 10 mg)	Substituted for prednisolone
Vincristine, IV	1.5 mg (max, 2 mg)	Days 1, 8, 15, 22, 29
Cyclophosphamide, 2-h infusion	1000 mg	Day 2
THP-doxorubicin, IV	20 mg	Days 8, 15
L-asparaginase, IV	6000 U	3 times weekly for 9 doses, starting on day 15
Age-adjusted intrathecal methotrexate and hydrocortisone		Days 8, 22
<b>Early consolidation</b>		
Cytarabine, IV	75 mg/day	5 times weekly for 15 doses, on days 1–5, 8–12, 15–19
Mercaptopurine, oral	60 mg/day	For 21 days, on days 1–21
Cyclophosphamide, 2-h infusion	1000 mg	Day 1
Age-adjusted intrathecal methotrexate, hydrocortisone and cytarabine		
<b>High dose methotrexate</b>		
Methotrexate	3 g	3 times: 12-h infusion on day 1 and 24-h infusion, twice 7-10 days after day 1
Age-adjusted intrathecal methotrexate and hydrocortisone		
<b>Cranial radiotherapy, IR18 arm</b>		
Cranial radiotherapy	18 Gy (>2 years old), 12 Gy (1 year old)	
Mercaptopurine, oral	60 mg/day	For 14 days
Methotrexate, oral	25 mg/day	3 times, weekly
Age-adjusted intrathecal methotrexate and hydrocortisone		
<b>Re-induction</b>		
Prednisolone, oral	40 mg/day	Days 1–14
Dexamethasone, oral	6 mg/day	Substituted for prednisolone
Vincristine, IV	1.5 mg (max, 2 mg)	Days 1, 8, 15
THP-doxorubicin, IV	20 mg	Days 1, 8, 15
L-asparaginase, SC	10,000 U	2 times weekly for 4 doses
<b>Intensive reconsolidation</b>		
Cytarabine, IV	75 mg/day	5 times weekly for 10 doses, on days 1–5, 8–12
Mercaptopurine, oral	60 mg/day	For 14 days, on days 1–14
Cyclophosphamide, 2-h infusion	1000 mg	Day 1
<b>Intensive therapy*</b>		
Prednisolone, oral	40 mg/day	Twice Days 1–14
Dexamethasone, oral	6 mg/day	Substituted for prednisolone
Vincristine, IV	1.5 mg (max, 2 mg)	Days 1, 8, 15
L-asparaginase, SC	10,000 U	Days 8, 15

(Continued)



**Table 14.17** (Continued)

Treatment Element/Drug	Single or Daily Dose	Days Administered
Intensive therapy		
High dose cytarabine, 3-h infusion	2 g	4 times, 12-h interval
L-asparaginase, SC	10,000 U	3 hours after cytarabine infusion
Intermediate dose methotrexate*	500 mg	Twice 6-h infusion
Intensive therapy		
Cyclophosphamide, 2-h infusion	1000 mg	Day 1
Mercaptopurine, oral	100 mg/d	For 5 days, on days 1–5
Cytarabine, IV	50 mg	10 times, 12-h interval, on days 1–5
Intermittent maintenance		
Mercaptopurine, oral	80 mg/d	13 times for 5 days, 2-week interval
Methotrexate, IV	50 mg	13 times, 2-week interval
	6 Mercaptopurine: 80–90– 100–110–120, gradual dose increment <sup>†</sup>	
	Methotrexate: 50–60–70–80–90 <sup>†</sup>	
Continuous maintenance		
Mercaptopurine, oral	40–60 mg/d <sup>†</sup>	‡
Methotrexate, oral	25–30 mg weekly dose <sup>†</sup>	‡
Intrathecal injection by age		
Methotrexate (mg)		
≥3 years old	12.5	
2 years old	10	
1 year old	7.5	
Hydrocortisone (mg)		
≥3 years old	25	
2 years old	20	
1 year old	15	
Cytarabine (mg)		
≥3 years old	25	
2 years old	20	
1 years old	15	

THP: 4'-0-tetrahydropyranlyl; IR18: intermediate risk group patients who received 18 Gy of cranial radiotherapy; IV: intravenous and SC: subcutaneous.

\*Intensive therapy and intermediate dose methotrexate are repeated twice.

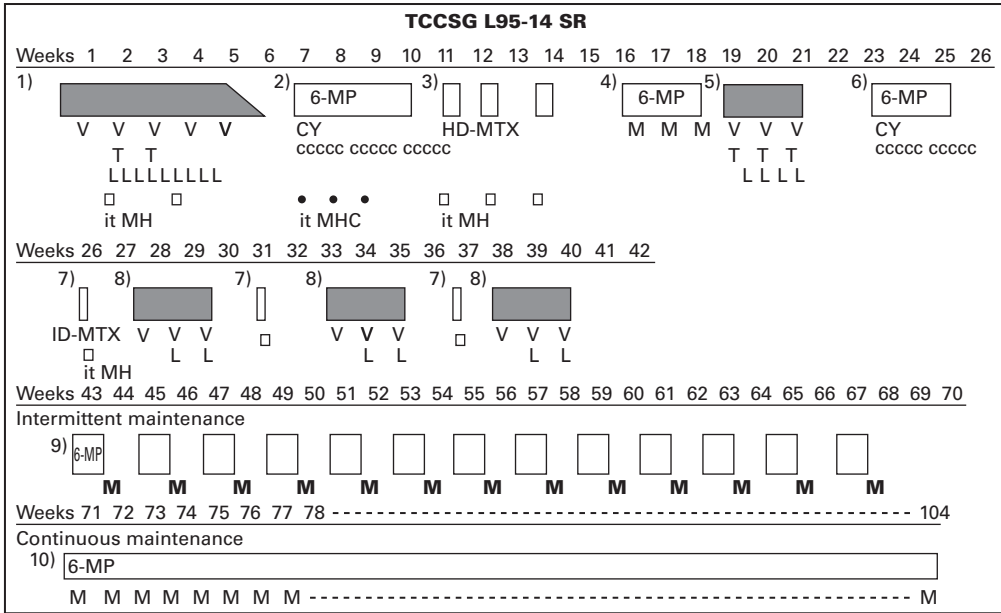
<sup>†</sup>Adjust the dosage for WBC between  $2.5$  and  $3.5 \times 10^9/L$ .

<sup>‡</sup>From the end of the intermittent maintenance therapy to 2 years after the start of treatment, for about 34 weeks.

differences in either in the relapse sites or relapse rates in the DEX and PDN arms patients who received cranial radiotherapy.

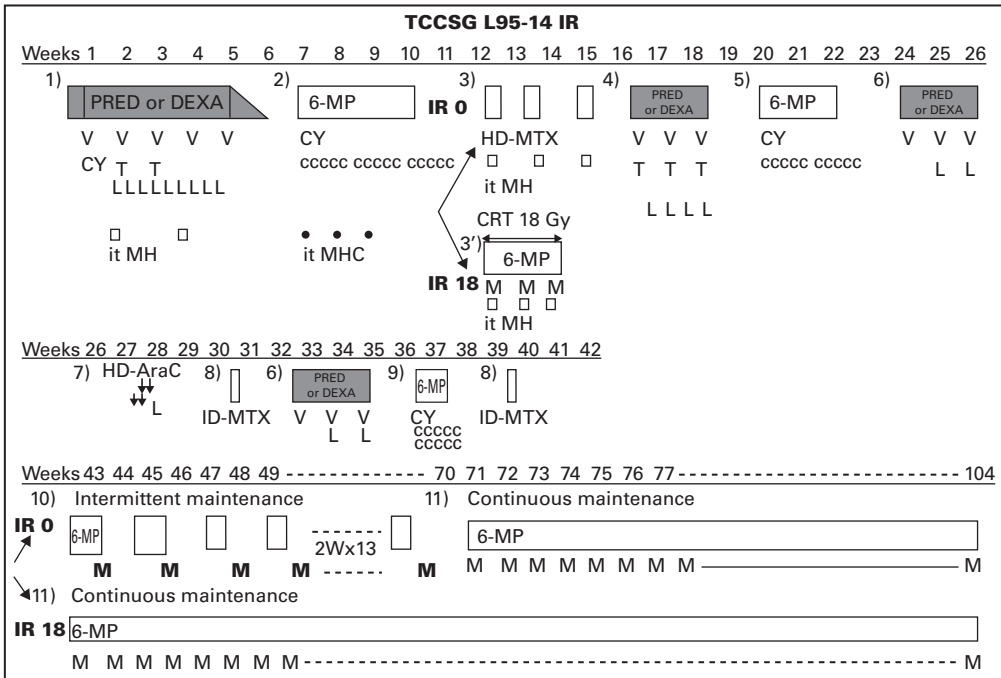
The 8-year EFS (mean  $\pm$  SE) for all patients in the SR group ( $n = 231$ ) was  $82.8 \pm 3.2\%$  while it was

$82.6 \pm 3.5\%$  for the IR group patients ( $n = 128$ ). There were no significant differences in the EFS between the PDN and DEX arms in both the SR and IR group of patients, respectively (Figures 14.14 and 14.15).



**Figure 14.12** Treatment schema for the TCCSG L95-14 SR group. 6MP: 6-mercaptopurine; C: cytarabine; CY: cyclophosphamide; DEXA: dexamethasone; HD MTX: high dose methotrexate; ID MTX: intermediate dose methotrexate; it MH: age-adjusted intrathecal

methotrexate and hydrocortisone; it MHC: age-adjusted intrathecal methotrexate, hydrocortisone and cytarabine; L: L-asparaginase; M: methotrexate; PRED: prednisolone; T: doxorubicin and V: vincristine. © American Society of Clinical Oncology (full reference on p. 302).



**Figure 14.13** Treatment schema for the TCCSG L95-14 IR group. CRT: cranial radiotherapy; HD-AraC: high dose cytarabine; IR18: patients who received 18 Gy of CRT and IRO: patients who received no CRT; for other abbreviations see Figure 14.12. © American Society of Clinical Oncology (full reference on p. 302).

**Table 14.18** Patient characteristics.

Characteristic	SR Group (n = 231)		IR Group (n = 128)	
	PDN (No.)	DEX (No.)	PDN (No.)	DEX (No.)
Sex	114	117	66 <sup>a</sup>	62 <sup>b</sup>
Male	64	68	38	32
Female	50	49	28	30
WBC count				
<10 × 10 <sup>9</sup> /l	86	97	21	26
10–50 × 10 <sup>9</sup> /l	28	20	33	25
≥50 × 10 <sup>9</sup> /l	0	0	12	11
Immunophenotype <sup>c</sup>				
Pro-B cell	5	5	2	2
Common	88	90	48	45
Pre-B cell	3	3	2	1
T cell	0	0	1	2
Others	18	19	13	12
DNA index				
≥1.16	42	47	15	9
<1.16	45	43	38	38
ND	27	27	13	15

Note: Presenting characteristics were not significantly different between the DEXA arm and the PRED arm.

Ig: immunoglobulin and ND: not done.

<sup>a</sup>Twelve of these patients received 18 Gy of cranial irradiation.

<sup>b</sup>Eleven of the patients received 18 Gy of cranial irradiation.

<sup>c</sup>Immunophenotype; pro-B cell ALL: CD19<sup>+</sup>, CD10<sup>-</sup>, cyIgM<sup>-</sup>, sIg<sup>-</sup>; common ALL: CD19<sup>+</sup>, CD10<sup>+</sup>, cyIgM<sup>-</sup>, sIg<sup>-</sup>; pre-B ALL: CD19<sup>+</sup>, CD10<sup>±</sup>, cyIgM<sup>±</sup>, sIg<sup>-</sup>; T cell: CD3<sup>+</sup>, CD7<sup>+</sup>; others: biphenotypic ALL, ALL type not determined, and soon.

The 8-year EFS was 81.1 ± 3.9% in the SR DEX arm (n = 117) versus 84.4 ± 5.2% in the SR PDN arm (n = 114) (p = 0.217) and 84.9 ± 4.6% in the IR DEX arm (n = 62) versus 80.4 ± 5.1% in the IR PDN arm (n = 62) (p = 0.625).

The 8-year EFS for IR patients who did not receive cranial radiotherapy was 85.7 ± 5% in the DEX arm (n = 51) compared to 81.6 ± 5.6% for PDN arm (n = 54) (p = 0.68). In contrast, the EFS rate for patients who received CR radiotherapy was 81.8 ± 11.6% (n = 11) and 75 ± 12.5% (n = 12) in the DEX and PDN arms, respectively (p = 0.787).

### Toxicity

Pancreatitis, osteonecrosis and neuropsychiatric complications were exclusively seen in patients randomized

to DEX. Bacterial sepsis was seen in 11 patients randomized to PDN compared to 19 assigned to DEX; 1 patient each in the SR Pred arm & IR Dex arm developed a fungal infection; 7 patients died as a direct consequence of their infection: 2 in the PDN arm and 5 in the DEX arm; 2 patients in the IR PDN arm died due to unidentified encephalopathy. Table 14.20 shows the toxicities encountered by the patients in the two randomized groups.

### Conclusion

It was concluded that DEX did not offer any advantage over PDN in the treatment of SR and IR patients with childhood ALL.

**Table 14.19** Treatment outcome.

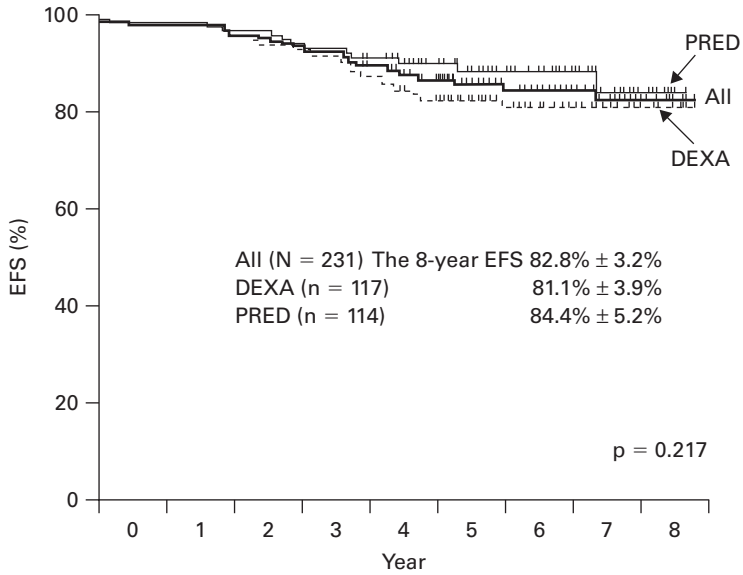
Outcome	SR Group (n = 231)				IR Group (n = 128)							
	PDN (n = 114)		DEX (n = 117)		PDN (n = 66)				DEX (n = 62)			
					IRO (n = 54)		IR18 (n = 12)		IRO (n = 51)		IR18 (n = 11)	
	No.	%	No.	%	No.	%	No.	%	No.	%	No.	%
Death before remission <sup>a</sup>	1	–	2	–	0	–	1	–	1	–	2	–
CR achieved	113	99.1	115	98.3	54	65	11	98.5	50	59	9	95.2
Dead in first CR	0	0	0	0	0	0	2 <sup>b</sup>	–	0	0	0	0
Relapse						8		12.3		6		10.2
All	12	10.5	18	15.7	7	13.0	1	9.1	5	10.0	1	11.1
BM	6	5.3	18	15.7	6	11.1	1	9.1	3	6.0	1	11.1
CNS	2	1.8	0	0	0	0	0	0	1	2.0	0	0
Testicle	3	2.6	0	0	0	0	0	0	0	0	0	0
Combined CNS/BM	0	0	0	0	1	1.9	0	0	1	2.0	0	0
Combined testicle/BM	1	0.9	0	0	0	0	0	0	0	0	0	0
Second malignancy	0	0	0	0	0	0	1 <sup>c</sup>	9.1	0	0	0	0
						81.6		75.0		85.7		81.8
						5.6		12.5		5.0		11.6
8-Year EFS (%)												
Mean	84.4		81.1				80.4				84.9	
SE	5.2		3.9				5.1				4.6	
		82.8							82.6			
		3.2							3.5			

BM: bone marrow; IR18: intermediate risk patients receiving 18 Gy of cranial radiotherapy and IRO: intermediate risk patients not receiving cranial radiotherapy.

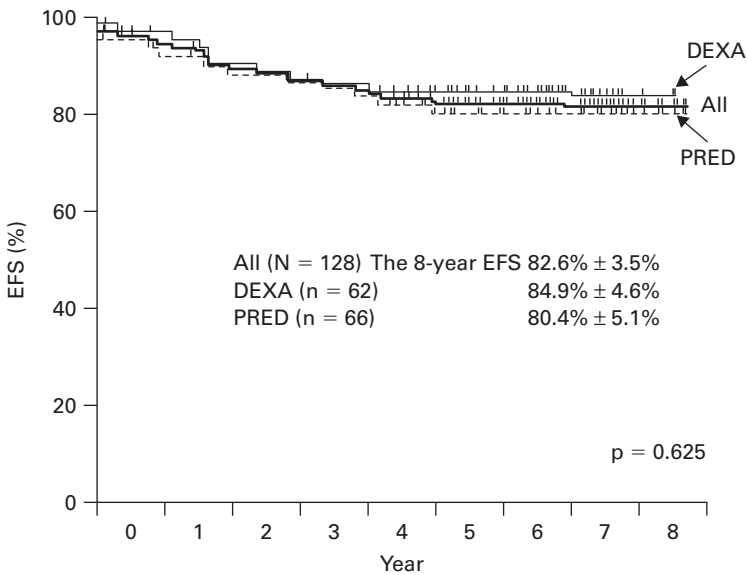
<sup>a</sup>Died from infectious complication.

<sup>b</sup>Died from unidentified encephalopathy.

<sup>c</sup>Myelodysplastic syndrome.



**Figure 14.14** Kaplan–Meier estimate of EFS in the TCCSG L95-14 SR group. © American Society of Clinical Oncology (full reference on p. 302).



**Figure 14.15** Kaplan–Meier estimate of EFS in the TCCSG L95-14 IR group. © American Society of Clinical Oncology (full reference on p. 302).

**Table 14.20** Toxicities.

Toxicity	PDN Patients (n = 180)						DEX Patients (n = 179)						p
	SR (n = 114)		IR (n = 66)		Total		SR (n = 117)		SR (n = 62)		Total		
	No.	%	No.	%	No.	%	No.	%	No.	%	No.	%	
Infectious complications <sup>a</sup>													
During induction	8	7.0	4 <sup>b</sup>	6.1	12	6.7	12 <sup>c</sup>	10.3	8 <sup>d</sup>	12.9	20	11.1	.18
After induction	6	5.3	3	4.5	9	5.0	6	5.1	5	8.1	11	6.1	
Coagulopathy	1	0.8	1	1.5	2	1.1	2	1.7	2	3.2	4	2.2	0.67
Pancreatitis	0	0	0	0	0	0	2	1.7	0	0	2	1.1	0.47
Osteonecrosis	0	0	0	0	0	0	2	1.7	1	1.6	3	1.7	0.24
Neuropsychiatric effects	0	0	0	0	0	0	2	1.7	1	1.6	3	1.7	0.24
Other toxicity <sup>e</sup>	0	0	2 <sup>c,f</sup>	3.0	2	1.1	1	0.9	1	1.6	2	1.1	

Note: The incidence of complications was not significantly different between the DEX arm and the PDN arm.

<sup>a</sup>Sepsis, fungal infections, other serious infectious complications, CNS hemorrhage and thrombotic stroke.

<sup>b</sup>One patient died from complications.

<sup>c</sup>Two patients died from complications.

<sup>d</sup>Three patients died from complications.

<sup>e</sup>One SR DEX patient had virus-associated hemophagocytosis; two IR PDN patients had encephalopathy and one IR DEX patient who received 18 Gy of cranial radiotherapy had Moyamoya disease. Other toxicities, such as steroid myopathy, hepatic transaminase elevations, hyperlipemia and hyperglycemia, were not prospectively collected.

<sup>f</sup>Unidentified encephalopathy.

# Types of L-Asparaginase

## Study 6

Vassilios I. Avramis, Susan Sencer, Antonia P. Periclou, Harland Sather, Bruce C. Bostrom, Lewis J. Cohen, Alice G. Ettinger, Lawrence J. Ettinger, Janet Franklin, Paul S. Gaynon, Joanne M. Hilden, Beverly Lange, Fataneh Majlessipour, Pracad Mathew, Michael Needle, Joseph Neglia, Gregory Reaman, John S. Holcenberg. A randomized comparison of native *Escherichia coli* asparaginase and polyethylene glycol conjugated asparaginase for treatment of children with newly diagnosed standard-risk acute lymphoblastic leukemia: a Children's Cancer Group study. *Blood* 2002;99: 1986–94.

### Objectives

The aim of this study was:

- To determine the safety, efficacy and pharmacokinetics of a single intramuscular dose of polyethylene glycol conjugated asparaginase (pegaspargase) against multiple doses native *E. coli* asparaginase during the induction, consolidation and delayed intensification (DI) phases of ALL therapy.

### Study design

This was a prospective randomized study that was conducted during the period between May 1997 and November 1998 and included all children with standard risk acute lymphoblastic leukemia (ALL) eligible for enrollment on the Children's Cancer Group (CCG)-1962 study. Data analysis was based on intention to treat.

### Details of the study

Children between the ages of 1 and 9 years of age with childhood ALL and with white blood cell counts up to

50,000/ $\mu$ l were included in the study. Massive lymphadenopathy, splenomegaly, bulky mediastinal disease, central nervous system (CNS) leukemia or testicular infiltration did not preclude them from entry onto the trial. All patients were randomized at the start of induction of remission.

### Treatment

Treatment consisted of 4 weeks each of an induction and consolidation blocks, two 8-week interim maintenance phases, two 8-week DI blocks and a maintenance phase. The total duration of treatment was 2 and 3 years for girls and boys, respectively, and this was from the first interim maintenance phase. All patients were randomized at induction to receive either 2500 IU/m<sup>2</sup> of pegaspargase during induction and each of the two DI blocks or 6000 IU/m<sup>2</sup> of native *E. coli* asparaginase (ASNase), 3 times per week for nine doses during induction and six doses in each DI block. Treatment schema of the CCG-1962 protocol is shown in Table 14.21.

### Asparaginase, antibody and amino acid analyses

Blood samples were collected on days 0, 7, 14, 21 and 28 of induction and at each of the DI phases of therapy. Cerebrospinal fluid (CSF) samples were collected on days 0, 7 and 28 of the induction phase alone. All samples were placed immediately on collection in an ice water bath. Some serum and CSF were collected within 2 days each of the specified induction days. However, the actual day of sample collection was used for all calculations.

ASNase activity was measured by the ammonia produced from asparagine with a Nessler reaction. ASNase protein and anti-ASNase antibody were measured by a modified indirect solid phase enzyme linked

**Table 14.21** Treatment schema for CCG-1962 protocol.

<b>Induction</b>	
Vincristine IV	1.5 mg/m <sup>2</sup> days 0.7, 14, 21
Prednisone PO	40 mg/m <sup>2</sup> days 0-28 then 10-day taper
Pegaspargase IM or native asparaginase IM	2500 IU/m <sup>2</sup> day 3 6000 IU/m <sup>2</sup> days 3, 5, 8, 10, 12, 15, 17, 19, 22
Cytarabine IT	30, 50 or 70 mg day 0*
Methotrexate IT	8, 10 or 12 mg days 7, 28*
<b>Consolidation</b>	
Vincristine IV	1.5 mg/m <sup>2</sup> days 0, 28, 56
6-Mercaptopurine PO	75 mg/m <sup>2</sup> days 1-28
Methotrexate IT	8, 10 or 12 mg days 7, 14, 21*
<b>Interim maintenance no. 1 and no. 2</b>	
Vincristine IV	1.5 mg/m <sup>2</sup> days 0, 28
Prednisone PO	40 mg/m <sup>2</sup> days 0-4, 28-32
Methotrexate PO	20 mg/m <sup>2</sup> weekly
6-Mercaptopurine PO	75 mg/m <sup>2</sup> daily
<b>Delayed intensification no. 1 and no. 2</b>	
Vincristine IV	1.5 mg/m <sup>2</sup> days 0, 7, 14
Dexamethasone PO	10 mg/m <sup>2</sup> days 0-6, 14-20
Pegaspargase IM or Native asparaginase IM	2500 IU/m <sup>2</sup> day 3 6000 IU/m <sup>2</sup> days 3, 5, 8, 10, 12, 15
Doxorubicin IV	25 mg/m <sup>2</sup> days 0, 7, 14
Methotrexate IT	8, 10 or 12 mg days 0, 28, 35*
Cyclophosphamide IV	1000 mg/m <sup>2</sup> day 28
Cytarabine IV or SC	75 mg/m <sup>2</sup> days 29-39, 36-39
Thioguanine PO	60 mg/m <sup>2</sup> days 28-41
<b>Maintenance</b>	
Vincristine IV	1.5 mg/m <sup>2</sup> every 4 weeks
Prednisone PO	40 mg/m <sup>2</sup> days 0-4 every 4 weeks
Methotrexate PO	20 mg/m <sup>2</sup> weekly
6-Mercaptopurine PO	75 mg/m <sup>2</sup> daily
Methotrexate IT	8, 10 or 12 mg every 3 months*

IM: intramuscularly; IT: intrathecal; IV: intravenously; PO: oral and SC: subcutaneous.

\*The dose of IT medications was based on age.

immunosorbent assay (ELISA). An antibody against native *E. coli* ASNase was used initially to create a titration curve for both native *E. coli* ASNase and pegaspargase. Later serum from patients who had high titer antibodies to pegaspargase was used for the enzyme preparation. The titers were compared with the patient's own pre-treatment control serum and a negative control serum from a healthy volunteer. High titer antibody was defined as a ratio of serum antibody to the average control value of  $\geq 2.5$ . For the purpose of analyses, the highest ratio of four post-treatment

samples collected from each patient was used during each of the asparaginase containing blocks of therapy.

Asparagine, aspartic acid, glutamic acid and glutamine were assayed a modified high performance liquid chromatography (HPLC) method.

### Pharmacokinetic and pharmacodynamic studies

Pegaspargase levels were performed by one compartment and non-compartmental pharmacokinetic analyses. A one compartment open model was used for serum



concentrations of ASNase enzymatic activity. Non-compartmental pharmacokinetic model analyses were also done using the method based on the statistical moment theory.

### Outcome end points

The primary end point was to determine the incidence of high titer ASNase antibodies during DI no. 1. Secondary end points included incidence of antibodies in the second DI, asparagine levels, ASNase activity and ASNase protein in serum during the induction and DI phases, and in the CSF during induction, in the 2 treatment groups.

### Statistics

The study was designed to detect a change from 50% to 25% or less in the incidence of antibodies with a power of 80% for one-sided hypothesis test (based on the assumption that 50% of all patients treated with native ASNase would have developed antibodies at the commencement of the first DI block). Kaplan–Meier estimates were used for life table estimation and the log rank test was used to compare EFS outcomes. Comparisons of induction response rates and some categorical analyses of antibody ratio levels and ASNase activity groupings were done by exact  $\chi^2$  while comparisons of actual values for ASNase

**Table 14.22** Distribution of patient characteristics by treatment assignment.

Patient Characteristic	Native ASNase (%)	Pegaspargase (%)
Total	59 (100)	59 (100)
Age		
1–2 years	20 (34)	11 (19)
3–5 years	18 (30)	26 (44)
6–9 years	21 (36)	22 (37)
Sex		
Male	33 (56)	31 (53)
Female	26 (44)	28 (47)
Race		
White	39 (66)	38 (64)
Non-white	20 (34)	21 (36)
WBC count at diagnosis		
<20,000	46 (78)	47 (80)
>20,000	13 (22)	12 (20)
CALLA-positive	53 (90)	50 (85)
Platelet count at diagnosis		
<50,000	30 (51)	20 (34)
50,000–149,000	19 (32)	21 (36)
>150,000	10 (17)	18 (30)
Hemoglobin level		
<8	24(41)	30 (52)
8–11	29 (49)	22 (38)
>11	6(10)	6 (10)
CNS disease		
>5 cells/ $\mu$ l, positive cytology	0 (0)	0 (0)
<5 cells/ $\mu$ l, positive cytology	9 (15)	4 (7)
<5 cells/ $\mu$ l, negative cytology	46 (78)	52 (88)
Mediastinal mass >½ thoracic diameter	6 (10)	4 (7)
Hepatomegaly, edge below the umbilicus	2 (3)	4 (7)
Splenomegaly, edge below the umbilicus	3 (5)	3 (5)
Lymphadenopathy, massive	1 (2)	1 (2)

CALLA-positive: reactive to common ALL antigen and WBC: white blood cell; CNS: central nervous system.

antibodies and antibody ratio were performed by the Wilcoxon nonparametric rank test.

### Outcome

One hundred and eighteen children were entered on study and 59 were randomized to native ASNase and pegaspargase, respectively. Patient characteristics are shown in Table 14.22. Of the 3 children with Down's syndrome, 2 were treated with pegaspargase. Two children were excluded from pharmacokinetic and pharmacodynamic analysis: 1 had Philadelphia positive ALL and was taken off the study after induction while the second child was inadvertently given both forms of asparaginase. On day 14 of induction therapy, 4 treated with native ASNase had M3 marrow status (>25% blasts); on day 28, 1 child treated with pegaspargase had M3 marrow and these children were taken off study for treatment on a more intensive program.

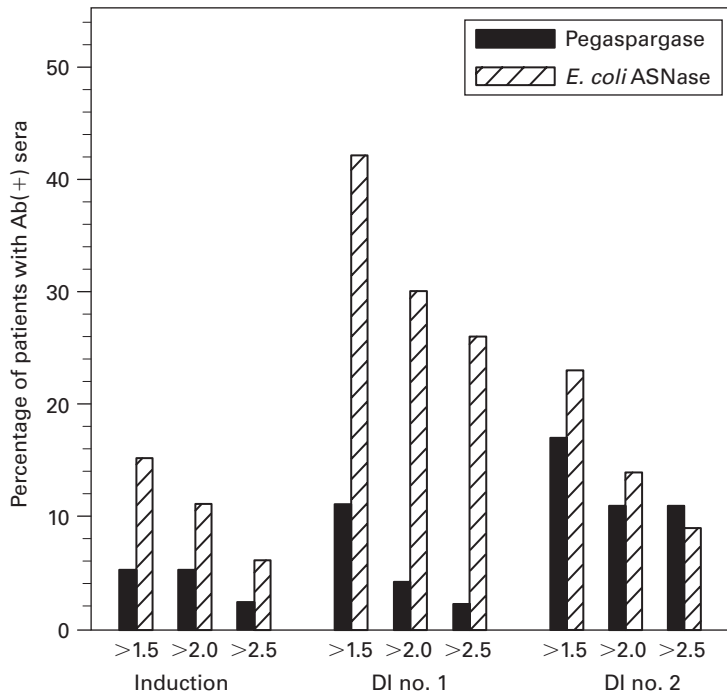
Ten children did not receive all the prescribed doses of asparaginase (pegaspargase 8, native ASNase 2) due to toxicity, protocol violations or parental choice.

### ASNase antibodies

The ASNase antibody ratio (mean  $\pm$  SEM) in DI no. 1 was significantly lower in children treated with pegaspargase ( $n = 47$ ) when compared with children treated with native ASNase ( $n = 43$ ) ( $1.9 \pm 0.8$  versus  $3.0 \pm 0.7$ ;  $p = 0.001$ ). The respective ratios for pegaspargase ( $n = 41$ ) and native ASNase ( $n = 47$ ) were  $1.3 \pm 0.2$  versus  $2.3 \pm 0.9$  during induction and  $2.1 \pm 0.8$  ( $n = 45$ ) versus  $2.1 \pm 0.6$  ( $n = 45$ ), respectively during DI no. 2. Figure 14.16 shows the percent of children in induction, DI no. 1 and DI no. 2 with maximal ratio of antibody to negative control. The difference in high antibody titers (>2.5) was most evident during DI no. 1–11/43 treated with native ASNase compared with 1/47 in the pegaspargase arm ( $p = 0.001$ , Wilcoxon test). These were less apparent and not significant in induction or DI no. 2.

Comparison of the maximum antibody ratio of each patient irrespective of the treatment phase showed higher titers in native ASNase patients ( $p = 0.0009$ , Wilcoxon test).

Table 14.23 shows fraction of samples with ASNase activity >0.1 IU/ml (level considered adequate to

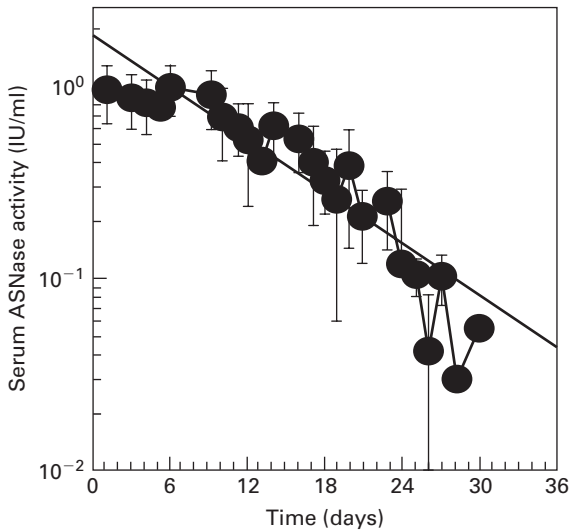


**Figure 14.16** Percentage of patients with anti-asparaginase antibody ratio over negative control >1.5, 2.0 and 2.5 in CCG-1962 study. Reproduced with permission of the American Society of Hematology (full reference on p. 312).

**Table 14.23** Fraction of samples with ASNase activity >0.1 IU/ml.

Antibody Ratio	Induction	DI No. 1	DI No. 2
Native ASNase			
<1.5	79/89 (89%)	54/58 (93%)	55/59 (93%)
1.5–2.0	3/3 (100%)	4/8 (50%)	6/7 (86%)
>2.0	5/8 (63%)	10/20 (50%)	7/11 (64%)
Pegaspargase			
<1.5	95/98 (97%)	67/69 (97%)	63/65 (95%)
1.5–2.0	0/0	5/5 (100%)	5/5 (100%)
>2.0	3/3 (100%)	2/2 (100%)	9/9 (100%)

Native ASNase serum samples obtained days 3–14 after the first native ASNase treatment. Pegaspargase serum samples obtained days 3–14 after the first native ASNase treatment.



**Figure 14.17** Pharmacokinetic profile of pegaspargase enzymatic activity in sera of pediatric patients with SR-ALL at induction. Multiple specimens were obtained during the induction phase from 57 patients (symbols: mean  $\pm$  SD of  $n = 45$ – $52$ ). Reproduced with permission of the American Society of Hematology (full reference on p. 312).

deplete asparagine). Patients treated with pegaspargase had fewer samples with elevated antibody ratios and all pegaspargase samples with an antibody ratio  $\geq 1.5$  had adequate ASNase activity (>0.1 IU/ml).

### Pharmacokinetics of pegaspargase

The mean pegaspargase activity peaked on day 5 and values of ASNase activity were greater for pegaspargase patients than those who received native ASNase (Figure 14.17). A higher proportion of children who received pegaspargase had ASNase activity >0.03 or 0.1 IU/ml on day 21 of DI no. 1 and DI no.2 (Table 14.24), respectively. A similar trend was also seen on day 28 of induction therapy (ASNase activity >0.03 IU/ml; 48% pegaspargase versus 15% native ASNase).

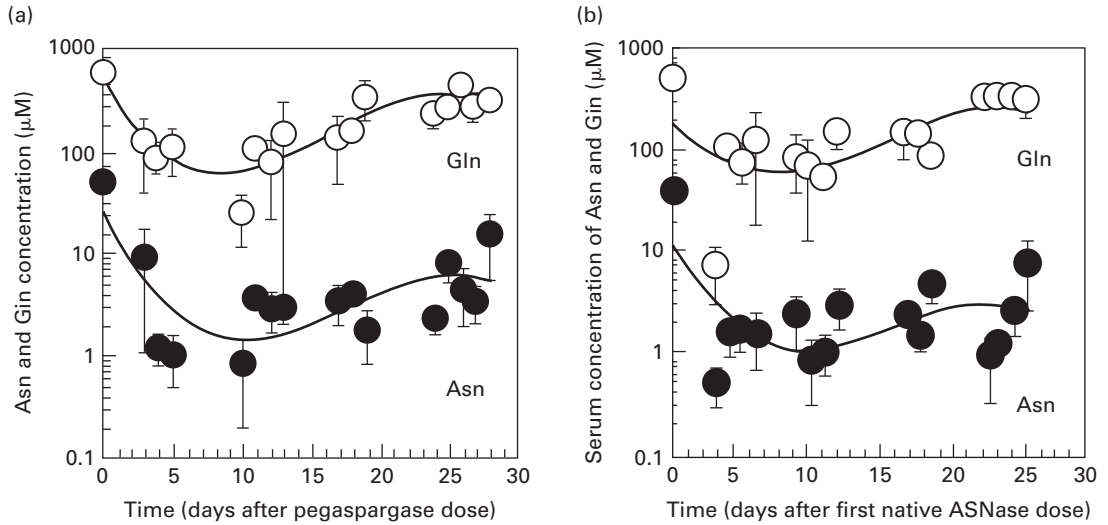
**Table 14.24** Percentage of samples with adequate ASNase activity.

ASNase activity	Day 21 DI No. 1		Day 21 DI No. 2	
	PEG (%)	Native (%)	PEG (%)	Native (%)
>0.03 IU/ml	95	31	91	39
>0.1 IU/ml	95	19	91	22

PEG: pegaspargase.

### Asparagine, glutamine, aspartic acid and glutamic acid concentrations

Asparagine levels fell rapidly within 4 days of the first ASNase dose and remained low for 3 weeks. The mean



**Figure 14.18** Asparagine and glutamine in serum after, pegaspargase or native asparaginase treatment during induction. Specimens were collected during the induction phase from 57 and 45 patients in (a) the pegaspargase and (b) native ASNase arms, respectively. Specimens were collected from 45 and 45, and 41 and 45 for the DI no. 1

and DI no. 2 phases in those arms (symbols: mean  $\pm$  SEM,  $n = 21\text{--}50$  for the pegaspargase and  $18\text{--}45$  for the native ASNase arms, respectively. ASN: asparagines and Gln: glutamine). Reproduced with permission of the American Society of Hematology (full reference on p. 312).

**Table 14.25** Bone marrow status on days 7 and 14.

Bone Marrow Status	Pegaspargase		Native ASNase	
	Day 7	Day 14	Day 7	Day 14
M1	36 (63)	52 <sup>a</sup> (96)	26 (47)	43 <sup>b</sup> (83)
M2	13 (23)	2 (4)	13 (24)	5 (10)
M3	8 (14)	0	16 (29)	4 (8)
Total patients	57 (100)	54 (100)	55 (100)	52 (100)

Entries are numbers of patients; parentheticals are percentages. Two patients were excluded from analysis: one had Philadelphia chromosome and one received both asparaginase preparations.

<sup>a</sup>This number includes 34 patients with M1 bone marrow on days 7 and 28 who did not have a bone marrow aspirate on day 14.

<sup>b</sup>This number includes 24 patients with M1 bone marrow on days 7 and 28 who did not have a bone marrow aspirate on day 14.

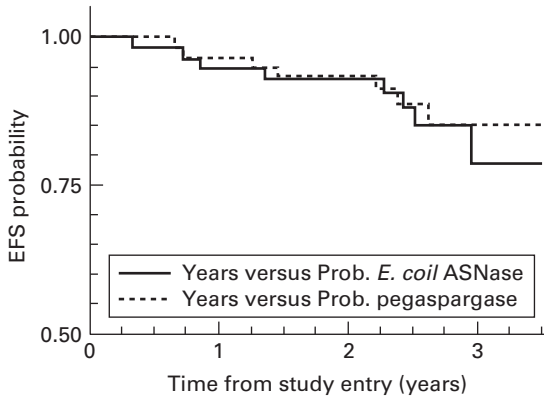
levels during induction were slightly higher for pegaspargase patients than for native ASNase patients (Figure 14.18). Values of asparagine concentration during DI no. 1 and DI no. 2 were very similar. Similarly, at each level of ASNase activity, asparagine levels were lower with native ASNase than with pegaspargase.

CSF asparagine fell from a pre-treatment level of 2.3 and 2.8  $\mu\text{M}$  for pegaspargase and native ASNase patients, respectively, to 1.1 and 1.3  $\mu\text{M}$  on day 7 and

0.6 and 0.3  $\mu\text{M}$  on day 28 in pegaspargase and native ASNase patients, respectively, and were not considered significant.

### Survival outcome

Bone marrow blast clearance at days 7 and 14 was more rapid in children who received pegaspargase compared to native ASNase (Table 14.25).



**Figure 14.19** Kaplan-Meier plot of EFS for all randomly assigned patients. Solid line (black) shows data for 59 native ASNase patients and gray line for 59 pegaspargase patients,  $p = 0.773$  log rank. Reproduced with permission of the American Society of Hematology (full reference on p. 312).

**Table 14.26** Grades 3 and 4 toxicity during asparaginase-containing courses.

Event Type	Pegaspargase			Native		
	IND	DI no. 1	DI no. 2	IND	DI no. 1	DI no. 2
CNS thrombosis	1	1	–	2	–	–
Other CNS complications <sup>a</sup>	–	3	3	–	2	2
Life-threatening infections <sup>b</sup>	–	1	1	–	–	1
Bacteremia	1	6	10	6	2	9
Hyperglycemia	3	–	–	1	1	1
Coagulopathy <sup>c</sup>	1	–	–	3	–	–
Nausea/vomiting	–	–	–	2	1	–
Abdominal pain	–	–	3	–	–	1
Abnormal LFT <sup>d</sup>	–	–	–	–	2	2
Pancreatitis	1	–	2	1	–	–
Mucositis	–	–	1	–	–	–
Gastric ulcer	–	–	1	–	–	–
Hemorrhagic cystitis	–	–	–	–	1	–
Constipation	–	–	1	–	–	–
Diarrhea	–	–	1	–	–	–
Allergy to asparaginase	–	1	–	–	–	–
Assessable patients	59	54	48	59	53	53

IND: induction and LFT: liver function tests.

<sup>a</sup>Including seizures, tremors, facial palsy, hemiparesis, peripheral neuropathy and motor weakness.

<sup>b</sup>Septic shock including hypotension and/or requiring intubation.

<sup>c</sup>Prolonged partial thromboplastin time or hypofibrinogenemia.

<sup>d</sup>Aspartate aminotransferase, alanine aminotransferase, or alkaline phosphatase >1.5 times the normal value, or total bilirubin >1.5 times the normal value.

The 3-year EFS rates for pegaspargase and native ASNase patients were 85% and 78%, respectively (NS) (Figure 14.19).

### Safety

There were no differences in the incidence or the types of toxicities in between the two groups of patients (Table 14.26). No toxicity-related deaths were seen in either group.

### Conclusion

It was concluded that patients treated with pegaspargase had more rapid clearance of lymphoblasts from the bone marrow on days 7 and 14 and more prolonged asparaginase activity than those treated with native asparaginase.

## Study 7

Michel Duval, Stefan Suciu, Alina Ferster, Xavier Rialland, Brigitte Nelken, Patrick Lutz, Yves Benoit, Alain Robert, Anne-Marie Manel, Etienne Vilmer, Jacques Otten, Noël Philippe for the European Organisation for Research and Treatment of Cancer – Children’s Leukemia Group. Comparison of *Escherichia coli* asparaginase with *Erwinia* asparaginase in the treatment of childhood lymphoid malignancies: results of a randomized European Organization for Research and Treatment of Cancer – Children’s Leukemia Group phase 3 trial. *Blood* 2002;99:2734–9.

### Study design

This was a multi-center randomized trial that was conducted between November 1990 and October 1993 and included all patients eligible for entry to the European Organization for Research and Treatment of Cancer – Children’s Leukemia Group (EORTC-CLG) trial 58881. Written informed consent was obtained for all patients included in the study. Data analysis was based on the principle of intention to treat. Randomization was done centrally (EORTC data center, Brussels) and was stratified according to center, disease (leukemia versus lymphoma), risk factor (<0.8, 0.8–1.19 and >1.2) and immunophenotype (B versus T lineage for leukemia patients) and Murphy stage (I and II versus III and IV) for lymphoma patients. However, randomization was not stratified according to the presence of t(9; 22).

### Objective

The objective was:

- To compare the efficacy and toxicities of *Escherichia coli* asparaginase (*E. coli asp*) with *Erwinia* asparaginase (*Erw asp*) during remission induction therapy in children with newly diagnosed acute lymphoblastic leukemia (ALL).

### Details of study

All children below the age of 18 years of age with previously untreated acute lymphoblastic leukemia (ALL) were eligible to be enrolled in the study. Children who were previously treated with corticosteroids for more than 7 days were excluded. Patients were stratified into low and high risk categories according to their risk factor which was a function of the blood blast count and

sizes of their liver and spleen. A further category included the “very high risk” group and included all patients with any of the following features: >1000 blasts/ $\mu$ l in peripheral blood after 7 days of prednisolone and intrathecal methotrexate (IT MTX) on day 1, t (4; 11) or t (9; 22) chromosomal translocations, near haploidy, undifferentiated immunophenotype or no complete remission (CR) after completion of protocol IA for patients with leukemia or protocol IB for patients with lymphoma. Patient characteristics are shown in Table 14.27.

### Treatment program

The treatment protocol was similar to the BFM-90 protocol (Table 14.28). Chemotherapy treatment consisted of induction – consolidation; pre-symptomatic central nervous system (CNS) directed therapy with high dose intravenous (IV HD MTX) and 10 doses of IT MTX, re-induction and maintenance therapy. Patients with CNS involvement received an additional 10 doses of IT MTX and 5 doses of high dose IV HD MTX during maintenance. Total duration of treatment was for 2 years.

Patients were randomized to either *Erwinia* asparaginase (*Erw asp*) or *Escherichia coli* asparaginase (*E. coli asp*) at diagnosis. Asparaginase was administered intravenously twice a week (10,000 IU/m<sup>2</sup>) for a total of 12 doses; 8 during protocol I and 4 during protocol II. The trial had two other randomizations: (1) additional monthly intravenous mercaptopurine (IV 6-MP) during maintenance therapy and (2) high dose cytarabine (ARA-C) for high risk patients during interval therapy.

Very high risk patients underwent rotating chemotherapy courses followed by allogeneic bone marrow transplantation where a matched sibling donor was available. Median follow up was 6.9 years [range, 4.8–9.0 years].

### Definitions

CR was defined as cellular bone marrow with <5% leukemic blasts with no evidence of leukemia or lymphoma at any site.

Remission failure was defined as failure to attain CR at the end of protocol I.

Coagulation abnormalities were defined as any clinical and or biological (hypofibrinogenemia <0.5 g/l) abnormality that required a modification in chemotherapy or supportive care.

**Table 14.27** Patient characteristics by arm.

	<i>E. coli asp</i> number (%) of patients N = 354 (100%)	<i>Erw asp</i> number (%) of patients N = 346 (100%)
Sex		
Male	206 (58)	202 (58)
Female	148 (42)	144 (42)
Age (year)		
<1	10 (3)	11 (3)
1–9	282 (80)	275 (80)
10–17	62 (17)	60 (17)
ALL	334 (94)	319 (92)
WBC count ( $10^9/l$ )		
<25	215 (64)	201 (63)
20–100	66 (20)	69 (22)
$\geq 100$	53 (16)	49 (15)
CNS involvement	17 (5)	15 (5)
Immunophenotype		
B lineage	289 (87)	267 (84)
T lineage	45 (13)	52 (16)
Karyotype		
Successful examinations	261 (78)	235 (74)
Hyperdiploidy	70 [27]*	52 [22]*
t (9; 22)	3 [1]*	11 [5]*
t (4; 11)	5 [2]*	6 [3]*
Near haploidy	1 [ $<1$ ]*	1 [ $<1$ ]*
Normal and others	182 [70]*	165 [70]*
Response to prephase: blasts ( $\mu l$ ) on D8		
<1000	292 (87)	278 (87)
1000	42 (13)	41 (13)
Initial very high risk features	47 (14)	54 (17)
NCI risk groups		
NCI standard risk	212 (63)	203 (64)
NCI high risk	122 (36)	116 (36)
Lymphoblastic lymphoma	20 (6)	27 (8)
Murphy stage III or IV	20 (100)	23 (85)
T lineage	19 (95)	22 (81)

\*Percentages were computed on successful cytogenetic examinations. NCI risk groups were as defined by the consensus conference.

National Cancer Institute (NCI) risk group definitions for leukemia were used to ensure comparability with other studies. NCI standard risk – 1–9 years of age with a diagnostic white blood cell (WBC) of  $<50 \times 10^9/l$ . All other patients were considered as NCI high risk.

### Outcome end points

The end points were event-free survival (EFS), CR rate after induction–consolidation, disease-free survival (DFS) and overall survival (OS).

### Statistics

The study was designed to detect a significant difference of 10% in EFS at 5 years (65% to 70%) with a statistical power of 85%. The Peto stopping rule was followed; a comparison that yielded a log rank  $p = 0.001$  was considered sufficient to cease enrollment. Actuarial survival was estimated by the Kaplan–Meier method and SEs (standard errors) was obtained by the Greenwood formula. The hazard ratio for an event in the *Erw asp* versus one in the *E. coli asp* arm and its 95% confidence

**Table 14.28** EORTC-CLCG 58881: treatment protocols for low and high risk patients.

Drug	Dose	Days of Administration <sup>a</sup>
Induction: protocol IA		
Prednisolone (PO)	60 mg/m <sup>2</sup>	1–28
Vincristine (IV)	1.5 mg/m <sup>2</sup> (maximum 2.5 mg)	8, 15, 22, 29
Daunorubicin (IV)	30 mg/m <sup>2</sup>	8, 15, 22, 29
Methotrexate (IT)	12 mg <sup>b</sup>	1, 8, 22, 38, 52
According to randomization		
<i>E. coli asp</i> (IV) or <i>Erw asp</i> (IV)	10,000 IU/m <sup>2</sup>	12, 15, 18, 22, 25, 29, 32, 35
Consolidation: protocol IB		
Cyclophosphamide (IV)	1,000 mg/m <sup>2</sup>	36, 63
Cytarabine (IV)	75 mg/m <sup>2</sup>	38–41, 45–48, 52–55, 59–62
6-Mercaptopurine (PO)	60 mg/m <sup>2</sup>	36–63
Interval therapy		
6-Mercaptopurine (PO)	25 mg/m <sup>2</sup>	1–56
Methotrexate (24-hour IV infusion with leukovorin rescue)	5,000 mg/m <sup>2</sup>	8, 22, 36, 50
Methotrexate (IT)	12 mg <sup>b</sup>	9, 23, 37, 51
According to randomization for high risk patients		
Cytarabine (IV)	1,000 mg/m <sup>2</sup>	9, 10, 23, 24, 37, 38, 51, 52
Re-induction: protocol II		
Dexamethasone (PO)	10 mg/m <sup>2</sup>	1–21
Vincristine (IV)	1.5 mg/m <sup>2</sup> (maximum 2.5 mg)	8, 15, 22, 29
Doxorubicin (IV)	30 mg/m <sup>2</sup>	8, 15, 22, 29
Methotrexate (IT)	12 mg <sup>b</sup>	38
Cyclophosphamide (IV)	1,000 mg/m <sup>2</sup>	36
Cytarabine (IV)	75 mg/m <sup>2</sup>	38–41, 45–48
6-Thioguanine (PO)	60 mg/m <sup>2</sup>	36–49
According to randomization		
<i>E. coli asp</i> (IV) or <i>Erw asp</i> (IV)	10,000 IU/m <sup>2</sup>	8, 11, 15, 18
<i>E. coli asp</i> (IV) or <i>Erw asp</i> (IV)	10,000 IU/m <sup>2</sup>	8, 11, 15, 18

Maintenance therapy was a combination of daily oral mercaptopurine adjusted to maintain leukocytes between 2000 and 3000/ $\mu$ l and methotrexate 20 mg/m<sup>2</sup> once a week. According to randomization, some patients received intravenous mercaptopurine 1000 mg/m<sup>2</sup> every 4 weeks.

<sup>a</sup>Adjustments were made for clinical condition and marrow recovery.

<sup>b</sup>Doses were adjusted for children under age of 3 years.

interval (CI) was estimated by the Cox proportional hazard method. The Fisher's exact two tailed test was used to compare the rates of remission after induction/consolidation and the odds ratio estimates and their 95% CI were used to express the results.

## Outcome

Of the 702 patients enrolled onto the 58881 trial, 700 were considered eligible for entry to study (*E. coli asp* arm, 354 and *Erw asp* arm, 346). Two patients with Burkitt lymphoma were excluded from analysis.

Enrollment was stopped early because the treatment difference in terms of EFS showed a  $p < 0.001$ . 653 patients had ALL and 47 had lymphoblastic lymphoma. The two arms were comparable except for a slight increase in t(9;22) translocations in the *Erw asp* arm.

## Protocol compliance and toxicity

During protocol IA, 81% of patients in the *Erw asp* arm and 88% in the *E. coli asp* arm received the eight doses of asparaginase and a similar proportion received the planned asparaginase treatment during protocol IIA



**Table 14.29** Evaluation of compliance with allocated asparaginase.

	<i>E. coli asp</i> no. (%) of patients	<i>Erw asp</i> no. (%) of patients
During protocol IA	354 (100)	346 (100)
Patients received all planned doses	287 (81)	303 (88)
Patients switched to other asparaginase*	39 (11)	24 (7)
During protocol IIA	300 (100)	277 (100)
Patients received all planned doses	198 (66)	190 (69)
Patients switched to other asparaginase*	86 (29)	80 (29)

\*Switch denotes a patient who received at least one injection of asparaginase he/she was not randomized to receive. Some patients did not receive all planned doses but were not switched to the other asparaginase.

**Table 14.30** Toxicity during induction (protocol IA).

	<i>E. coli asp</i> No. (%) of Patients N = 354 (100%)	<i>Erw asp</i> No. (%) of Patients N = 346 (100%)
Allergy (WHO 3-4)	9 (2.5)	9 (2.6)
Coagulation abnormalities	107 (30.2)	41 (11.8)
Neurotoxicity (WHO 3-4)	9 (2.5)	5 (1.4)
Convulsions	6 (1.7)	1 (0.3)
Pancreatitis	1 (0.3)	3 (0.9)
Diabetes requiring insulin	5 (1.4)	2 (0.6)
Liver toxicity (WHO 3-4)	16 (4.5)	13 (3.8)
Infection (WHO 3-4)	18 (5.1)	16 (4.6)
Death	1 (0.3)	2 (0.6)

(66% versus 69%), respectively (Table 14.29). Twenty-nine percent of patients in each arm received at least one dose of the non-randomized asparaginase during protocol II.

Coagulation abnormalities were more common with *E. coli asp* (30.2% versus 11.8%; odds ratio 3.20;  $p < 0.0001$ ). The incidences of other grade 3/4 toxicities were similar during protocol IA (Table 14.30).

### Efficacy

335 (94.5%) patients in the *E. coli asp* arm compared to 315 patients in the *Erw asp* arm (91%) achieved CR at the end of induction (Table 14.31). All patients who received *Erw asp* had a 1.5 times higher rate of relapse than those who received *E. coli asp* (Table 14.32).

The 6-year EFS of patients in the *Erw asp* arm was 59.8% (SE 2.6%) compared to 73.4% (SE 2.4%) in the *E. coli asp* arm ( $p = 0.0004$ ) (Figure 14.20a). The estimated hazards ratio for remission failure, relapse or death for leukemia patients in *Erw asp* arm (after

adjustment for NCI risk group, very high risk features and sex) was 1.60 (95% CI, 1.22–2.09).

The 6-year OS was 75.1% (SE 2.3%) in the *Erw asp* arm compared to 83.9% (SE 2.0%) in the *E. coli asp* arm ( $p = 0.002$ ) (Figure 14.20b). The estimated hazard ratio for death was 1.66 (95% CI, 1.20–2.23).

### High dose ARA-C and IV 6-MP

High dose ARA-C for high risk patients had no effect on DFS and did not have an effect on the outcome between the two asparaginase arms.

Patients randomized to receive IV 6-MP during maintenance had a worse DFS but again, this did not have an effect on the outcome between the asparaginase arms.

### Conclusion

It was concluded that *E. coli* asparaginase was superior to *Erwinia* asparaginase in the treatment of childhood leukemia and lymphoma.

**Table 14.31** ALL and lymphoblastic lymphoma patients: short-term outcome by arm.

	<i>E. coli asp</i> N = 354 (100%)	<i>Erw asp</i> N = 346 (100%)	Odd ratio (95% CI) (p)*
CR not reached after induction	19 (5.4)	31 (9.0)	1.74 (0.93, 3.32) (0.078)
Remission failure	7 (2.0)	17 (4.9)	2.56 (0.99, 7.39) (0.038)

Remission failure means patient never achieved CR at the end of induction-consolidation.

\*Fisher's exact test.

**Table 14.32** ALL patients: outcome by arm.

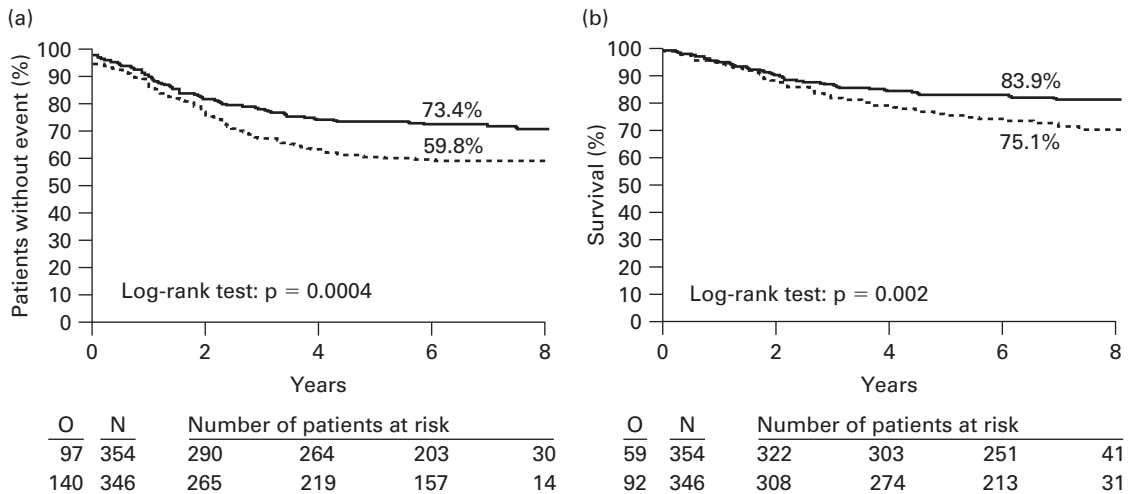
	<i>E. coli asp</i> N = 334 (100%)	<i>Erw asp</i> N = 319 (100%)	Odds ratio (95% CI) (p)*
CR not reached after induction	12 (3.6)	21 (6.6)	1.89 (0.87, 4.29) (0.107)
Remission failure	4 (1.2)	12 (3.8)	3.23 (0.96, 13.84) (0.042)
CR reached	330 (98.8)	307 (96.2)	
Continuous CR	242 [73]	190 [62]	
Death in CR	11 [3]	7 [2]	
Relapses	77 [23]	110 [36]	
Bone marrow	45 [14]	64 [21]	
CNS (isolated)	12 [4]	18 [6]	
CNS (combined)	13 [4]	15 [5]	
Other isolated	3 [1]	5 [2]	
Other combinations	4 [1]	8 [3]	

Remission failure means patient never achieved CR at the end of induction-consolidation.

Parentheses for columns 2 and 3: percentages were computed on all patients included.

Brackets for columns 2 and 3: percentages were computed on patients having reached CR.

\*Fisher's exact test.



**Figure 14.20** EFS and OS for the patient cohort. (a) EFS for patients randomized to *E. coli asp* (solid line) or *Erwinia asp* (broken line). O indicates observed number of events (remission failure, relapse or death in CR); N: total number of patients randomized. (b) OS for patients randomized to *E. coli asp* (solid line) or *Erwinia asp* (broken line). O indicates observed number of deaths and N, total number of patients randomized. Reproduced with permission of the American Society of Hematology (full reference on p. 319).

## Study 8

Risseuw-Appel IM, Dekker I, Hop WC, Hahlen K. Minimal effects of *E. coli* and *Erwinia* asparaginase on the coagulation system in childhood acute lymphoblastic leukemia: a randomized study. *Med Pediatr Oncol* 1994;23:335–43.

### Study design

This was a single center prospective randomized study and was conducted between June 1989 and December 1990. Details of the randomization methodology were not specified in the report. The study had the approval of the local ethical committee.

### Objectives

The primary aim of the study was:

- To determine whether there were any differences in the incidence of coagulation disorders in patients treated with either *Erwinia* asparaginase or *E. coli* asparaginase when administered in conjunction with other chemotherapy drugs during the treatment of childhood acute lymphoblastic leukemia (ALL).

### Study details

#### Patient population

All children were treated according to the acute lymphoblastic leukemia (ALL) VII protocol of the Dutch Leukaemia Study Group (DLSG). Figure 14.21 shows the ALL VII treatment schema. The induction phase was divided into two phases: phase A, days 1–18 and phase B, days 19–40. L-asparaginase therapy (10,000 U/m<sup>2</sup>) started from the beginning from phase B for a total of eight doses.

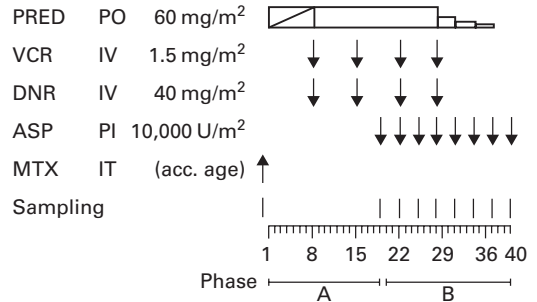
#### Randomization

Patients were randomized just prior to start of phase B (day 18) to receive either *Erwinia* L-asparaginase or the *E. coli* L-asparaginase.

#### Laboratory investigations

The tests for coagulation dysfunction included:

- Activated partial thromboplastin time (APTT).
- The normotest (NT).
- Fibrinogen (F1).
- Anti-thrombin III levels (ATIII).
- Protein C.



**Figure 14.21** Treatment schedule of the study period, protocol I, phase I according to the DCLSG-ALL VII/ALL-BFM-86 study. ASP: asparaginase; DNR: daunorubicin; MTX: methotrexate; PRED: prednisolone and VCR: vincristine. Reprinted from Risseuw-Appel *et al.* (full reference left) with permission from Wiley-Liss, Inc., a subsidiary of John Wiley & Sons Inc.

All blood samples for coagulation studies were collected into citrated tubes and chilled immediately prior to being centrifuged at 20,000 rpm at +4°C.

### Statistics

All results were expressed as percentages, means and standard error of mean (SEM). Percentages were compared using Fisher's exact test and changes during time in the various parameters were evaluated using Repeated measurements Analysis of Variance (RmANOVA). When the profiles of means were not parallel, t tests of the various time points were performed to evaluate the differences. For these tests, p value of <0.01 was considered significant instead of the conventional significance level of <0.05, to allow for multiplicity of testing.

### Outcome

Twenty eligible patients were registered on the study. Patient characteristics are shown in Table 14.33.

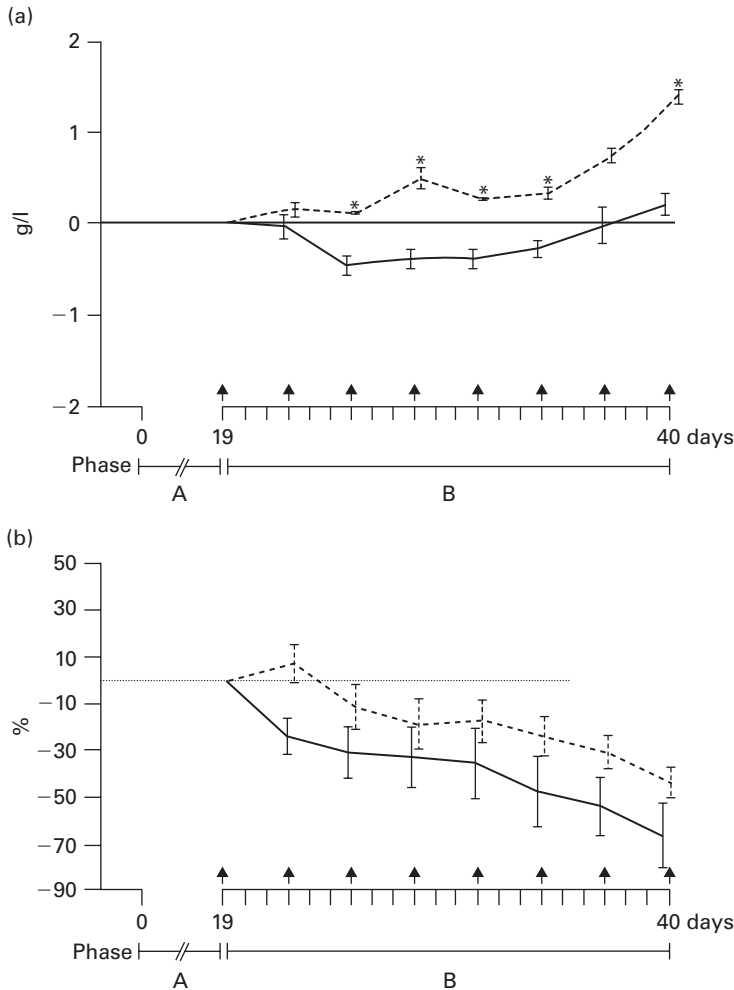
### Coagulation profile

The mean APTT level in all children demonstrated a significant fall ( $p < 0.001$ ) from 28.25 seconds at diagnosis (*E. coli* group  $-28 \pm 1.5$  seconds; range 23–27 seconds and *Erwinia* group  $-28.5 \pm 0.7$  seconds; range 24–32 seconds) to 23.0 seconds (*E. coli* group  $-22 \pm 0.6$  seconds and *Erwinia* group  $-23.9 \pm 0.7$  seconds) at the start of asparaginase treatment. By the end of phase B, APTT values improved slightly ( $27.8 \pm 0.9$  seconds and  $26.3 \pm 0.6$  seconds for the *E. coli* and *Erwinia* groups, respectively). RmANOVA showed no significant differences in the APTT profiles between the two groups.

**Table 14.33** Characteristics of 20 patients\*.

	Ten Patients Treated with <i>E. coli</i> Asparaginase	Ten Patients Treated with <i>Erwinia</i> Asparaginase
Sex (F/M)	5/5	5/5
Age (years)	2–9 (5)	1–12 (5)
Hb (mmol/l)	4.3–7.5 (5.4)	2.6–9.1 (4.3)
WBC (10 <sup>9</sup> /l)	3.4–38.7 (10.8)	4.6–585 (62.8)
Thr (10 <sup>9</sup> /l)	16–310 (81)	<10–141 (37)
Immunological typing	T-NHL 1 c-ALL 7 Pre-B ALL 2	T-ALL 4 c-ALL 5 Null ALL 1
RF	0.46–1.38 (0.93)	0.66–2.10 (1.22)

\*The range of the hemoglobin (Hb), white blood count (WBC), thrombocytes (Thr) and risk factors (RF) is given; median is between brackets. The RF is calculated from the amount of blasts (BL) at diagnosis in the peripheral blood, liver enlargement (L) in cm, spleen enlargement (S) in cm (RF = 0.2 log (BL + 1) + 6.06L + 0.04S).



**Figure 14.22** (a) Fibrinogen, expressed as mean ( $\pm$ SEM) change from baseline (day 19) according to treatment. Solid line, *E. coli*-treated patients. Dotted line, *Erwinia*-treated patients. \* $p \leq 0.01$ . (b) Protein C, expressed as mean ( $\pm$ SEM) change from baseline (day 19) according to treatment. Solid line: *E. coli*-treated patients and dotted line: *Erwinia*-treated patients. Reprinted from Risseuw-Appel *et al.* (full reference on p. 324) with permission from Wiley-Liss, Inc., a subsidiary of John Wiley & Sons, Inc.

Mean fibrinogen levels declined significantly from 3 g/l at diagnosis (*E. coli* group  $-3.2 \pm 0.26$  g/l and *Erwinia* group  $-2.8 \pm 0.3$  g/l) to 1.2 g/l at the start of asparaginase therapy (*E. coli* group  $-1.4 \pm 0.23$  g/l and *Erwinia* group  $-1.0 \pm 0.1$  g/l;  $p < 0.001$ ). Fibrinogen levels recovered gradually during phase B but the recovery was more rapid in the *Erwinia* group (Figure 14.22a). The difference in the change from the baseline value was statistically significant at day 25 and at most time points thereafter.

During the entire induction phase, while ATIII activity remained above normal in both groups, protein C values demonstrated a steady fall from 140% at the start of asparaginase treatment ( $147 \pm 18.8\%$  and  $137.5 \pm 8.2\%$  for the *E. coli* and *Erwinia* groups,

respectively) to a mean of 81% and 93% by the end of asparaginase treatment for the *E. coli* and *Erwinia* groups, respectively. The mean decrease was slightly greater than the *E. coli* group compared to the *Erwinia* group (2.8% versus 2.1%;  $p = 0.08$ ). Five children who received *E. coli* asparaginase had protein C values  $<70\%$  of normal (critical risk of thrombosis) but there were none in the *Erwinia* group (Figure 14.22b).

### Conclusion

It was concluded that *Erwinia* asparaginase had less pronounced effect on coagulation system with a smaller decline in protein C levels and a rather more rapid recovery in plasma fibrinogen levels.

## CHAPTER 15

# CNS prophylaxis in childhood lymphoblastic leukemia

## Studies: Radiotherapy as CNS directed treatment in childhood lymphoblastic leukemia

### Study 1

Nesbit MEJ, Robinson LL, Littman PS, Sather HN, Ortega J, D'Angio GJ, Denman Hammond G. Presymptomatic central nervous system therapy in previously untreated childhood acute lymphoblastic leukaemia: comparison of 1800rad and 2400rad. A report for the Children's Cancer Study Group. *Lancet* 1981;i: 461–6.

### Study design

These were prospective randomized multicenter trials that extended from June 1972 to February 1975 (CCG-101 from 1972 to 1974 and CCG-143 from 1974 till 1975). This report focuses only on the patients randomized to either craniospinal radiotherapy (24 or 18 Gy) or to cranial radiotherapy (24 or 18 Gy) plus intrathecal methotrexate (IT MTX).

### Objectives

The aims of the study were:

- To evaluate the efficacy of two differing doses of cranial irradiation (RT) with intrathecal methotrexate (IT MTX) in the treatment of childhood acute lymphoblastic leukemia.

- To compare craniospinal radiotherapy (CS-RT) with cranial radiotherapy (C-RT) plus IT MTX in the prevention of CNS leukemic relapse.

### Details of the study

Previously untreated children and adolescents below the age of 18 years were registered on the trials. Patients who did not achieve remission (<5% blasts in bone marrow) by day 42 were excluded, as were children who were less than 18 months of age, who were electively allocated IT MTX alone.

All patients received identical induction and maintenance treatment consisting of vincristine, L-asparaginase, prednisolone, 6-mercaptopurine and oral (PO) methotrexate. The first trial (CCG-101) used an irradiation dose of 24 Gy, while in the subsequent trial (CCG-143), it was 18 Gy.

CNS prophylaxis in CCG-101 had four arms: craniospinal RT 24 + 12 Gy to gonads; craniospinal RT 24 Gy; cranial RT 24 Gy + IT MTX; and IT MTX alone. In trial CCG-143, there were two arms: craniospinal RT 18 Gy and cranial RT 18 Gy + IT MTX.

The number of children randomized in the four treatment groups was as follows:

- 1 Craniospinal RT 24 Gy = 152 (CCG-101).
- 2 Craniospinal RT 18 Gy = 86 (CCG-143).

3 Cranial RT 24 Gy + IT MTX = 159 (CCG-101).

4 Cranial RT 18 Gy + IT MTX = 81 (CCG-143).

The randomization methodology is not specified in the report.

All patients were stratified into three prognostic groups:

1 *Poor prognosis*: WBC  $<10 \times 10^9/l$ ; age 3–6 years (n = 155).

2 *Intermediate prognosis*: any age and WBC count  $10\text{--}50 \times 10^9/l$  or WBC count  $<10 \times 10^9/l$  and less than 3 years or more than 6 years of age (n = 252).

3 *Poor prognosis*: WBC count  $>50 \times 10^9/l$  and any age (n = 71).

There were no significant differences between the two study populations (CCG-101 and CCG-143) with respect to initial WBC count, age at diagnosis and sex.

Main outcome measures were as follows:

1 CNS relapse rate as the first event in each treatment group.

2 Bone marrow relapse rate as the first event in each treatment group.

3 Event-free survival (EFS) in each treatment group stratified according to prognosis.

## Outcome

Analyses of results were performed on the basis of intention to treat. Of the 757 patients who achieved remission in the two trials and who were randomized for CNS prophylaxis, the results of the 478 patients who had either craniospinal RT or cranial RT plus IT MTX are reported in this chapter.

Thirteen patients who were randomized to receive 18 Gy actually received 24 Gy (6 craniospinal irradiation and 7 cranial RT + IT MTX) and their analysis was on the basis of actual treatment received.

## CNS relapse

At 2 years after randomization, the proportion of patients who experienced CNS relapses was as follows: craniospinal RT 18 Gy 0.05; 24 Gy 0.07; cranial RT + IT MTX, 1800 Gy 0.08; 24 Gy 0.06.

The proportion experiencing CNS relapse in the poor prognostic group at 48 months after randomization was

as follows: craniospinal RT, 24 Gy 0.35; 18 Gy 0.41 (p = 0.84), cranial RT + IT MTX, 24 Gy 0.12; 18 Gy 0.32 (p = 0.45).

Patients in the poor prognostic group who were treated with 18 Gy appeared to have a higher incidence of CNS relapse compared to those treated with 24 Gy, although not statistically significant.

Patients treated with cranial RT + IT MTX had a two fold higher incidence of CNS relapse than those who received craniospinal RT with either 18 and 24 Gy (p = 0.14 and p = 0.20 respectively).

## Bone marrow relapse

Patients who received 18 Gy + IT MTX had fewer marrow relapses or deaths than the group treated with 24 Gy + IT MTX. At 2 and 4 years from randomization the proportion of patients experiencing marrow relapse or death was as follows:

*Marrow relapse*: 24 Gy + IT MTX 0.18; 18 Gy + IT MTX 0.12 (2 years).

*Marrow relapse*: 24 Gy + IT MTX 0.30; 18 Gy + IT MTX 0.21 (4 years).

*Death*: 24 Gy + IT MTX 0.18; 18 Gy + IT MTX 0.11 (2 years).

*Death*: 24 Gy + IT MTX 0.29; 18 Gy + IT MTX 0.20 (4 years).

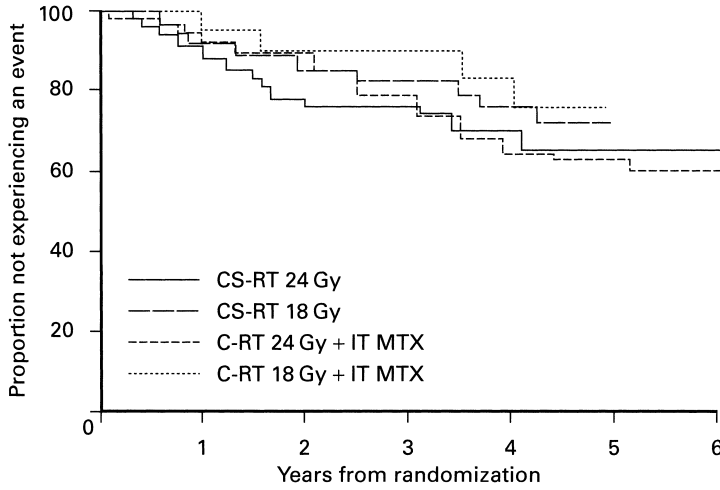
There were no significant differences between the 18 and 24 Gy craniospinal RT groups, neither were there any significant differences between the 24 Gy craniospinal RT and 24 Gy cranial RT + IT MTX groups.

Patients treated with 18 Gy cranial RT + IT MTX appeared to have fewer events than any other combination of therapy.

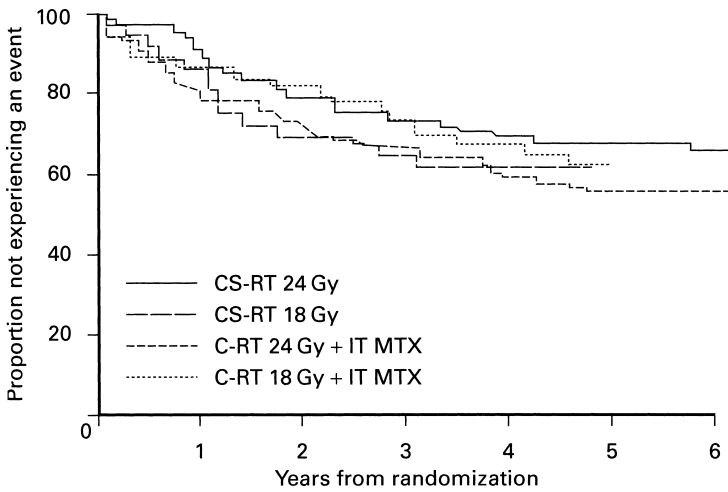
There were no differences in outcome among the three prognostic groups of patients treated with 18 or 24 Gy for CNS prophylaxis (Figures 15.1–15.3).

## Conclusion

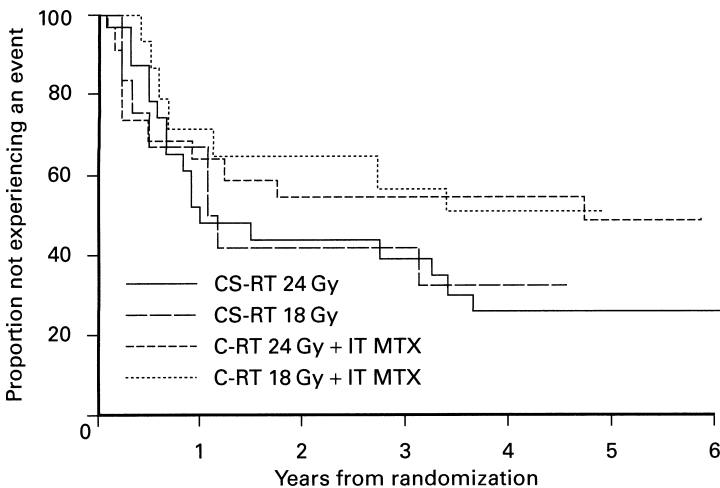
The reduction of the dose of CNS irradiation to 18 Gy did not result in any significant increase in the frequency of CNS relapse, bone marrow relapse or death among any prognostic group of patients.



**Figure 15.1** Time to first occurrence of relapse in any site or death for patients with good prognosis ALL. Reprinted from Nesbit *et al.* (full reference on p. 327) with permission from Elsevier.



**Figure 15.2** Time to first occurrence of relapse in any site or death for patients with intermediate prognosis ALL. Reprinted from Nesbit *et al.* (full reference on p. 327) with permission from Elsevier.



**Figure 15.3** Time to first occurrence of relapse in any site or death for patients with poor prognosis ALL. Reprinted from Nesbit *et al.* (full reference on p. 327) with permission from Elsevier.



## Study 2

Lilleyman JS, Richards S, Rankin A on behalf of the Medical Research Council's Working Party on Childhood Leukaemia. Medical Research Council Leukaemia trial, UKALL-VII: a report to the Council by the Working Party on Leukaemia in Childhood. *Arch Dis Childh* 1985;60:1050-4.

### Study design

UKALL-VII was a prospective randomized multicenter trial with enrolment open from April 1979 to March 1980.

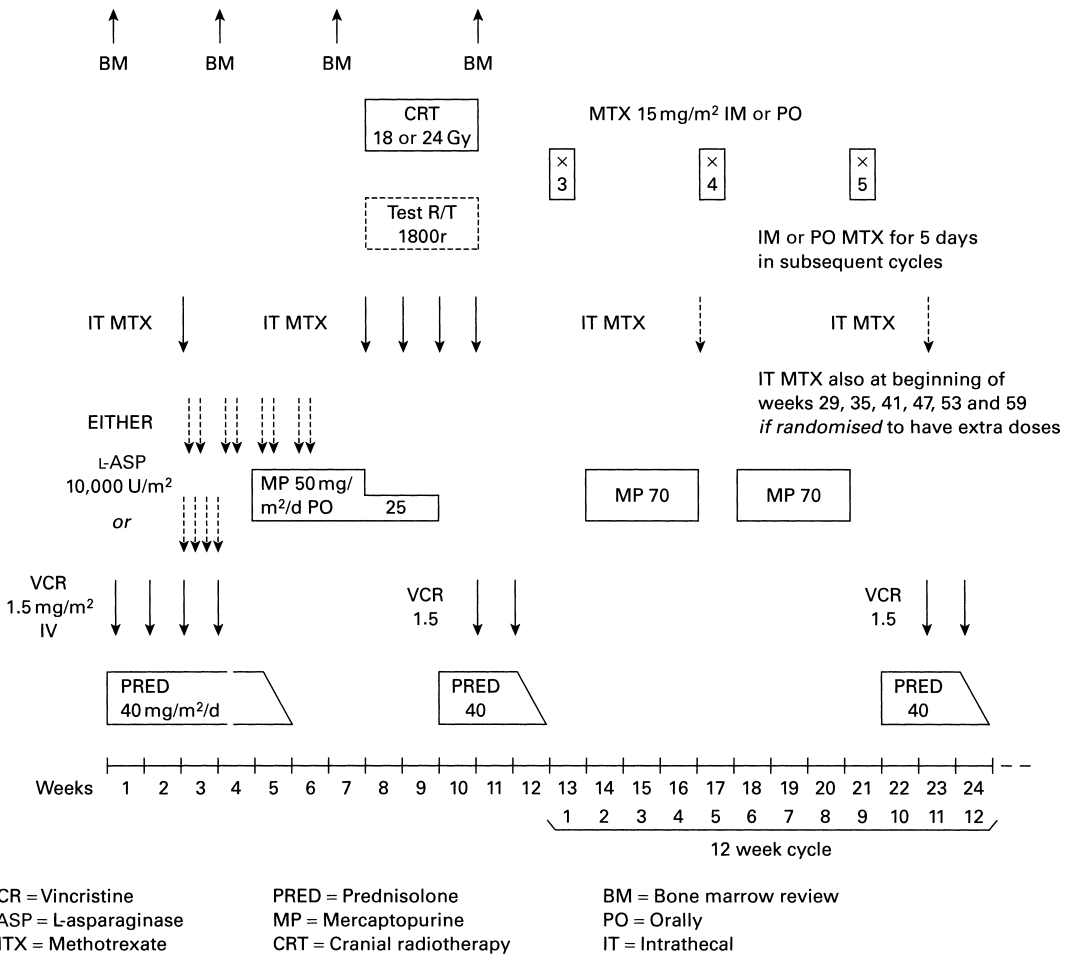
This review focuses on the CNS prophylaxis treatment alone.

### Objectives

The study aimed to evaluate the efficacy of a reduction in the dose of cranial irradiation and its impact on the treatment outcome in children with acute lymphoblastic leukemia. The study also had other objectives, which included evaluation of the need for prophylactic testicular irradiation, the number of doses of asparaginase during induction, the need for additional intrathecal methotrexate (IT MTX) during maintenance and the use of oral versus intramuscular methotrexate during maintenance.

### Design of the study details

Previously untreated children less than 14 years of age and with the diagnostic white blood cell count  $<20 \times$



**Figure 15.4** UKALL-VII intervention details: treatment time 2 years. Broken lines indicate randomized or allocated variables. Reproduced with permission of the BMJ Publishing Group (full reference above).

$10^9/l$  were enrolled on the trial. Black children as well as those with T-ALL or B-ALL were excluded from the study.

Remission induction consisted of vincristine, prednisolone and L-asparaginase with intrathecal methotrexate (IT MTX). Drugs, doses, routes of administration and the various randomized treatments are shown in Figure 15.4.

There were two randomizations for presymptomatic CNS treatment and both randomizations were independent of each other:

1 Cranial irradiation dose either at 18 Gy in 9 fractions or 24 Gy in 12 fractions.

2 Six additional doses of IT MTX at 6-weekly intervals during the first year of maintenance treatment or not. The methodology of randomization is not specified in the report.

Outcome measures were:

- 1 Relapse-free survival.
- 2 Incidence of CNS relapse according to cranial irradiation dose.
- 3 Incidence of relapse at other sites other than the CNS according to cranial irradiation dose.

## Outcome

Of the 87 patients registered in the trial, only 79 patients were considered eligible for evaluation and subsequent randomization for CNS prophylaxis (five were ineligible, three failed to remit). Analysis was performed on the basis of intention to treat as well as on the basis of treatment actually received (Table 15.1).

There was no difference in the CNS relapse rate in the children from the two cranial radiotherapy schedules

**Table 15.1** UKALL-VII: randomized variables.

Variable		Allocated	Received
Asparaginase	4 doses	40	38
	8 doses	39	41
CNS irradiation	9 fractions	40	41
	12 fractions	39	38
Extra IT MTX	Given	36	34
	Not given	43	43
Methotrexate	IM	40	36
Methotrexate	Oral	39	41
Testicular RT	Given	22	23
	Not given	21	20

IM: intramuscular and RT: radiotherapy.

as well as from the differing IT MTX schedules when analyzed on the basis of intention to treat or by actual treatment received. Six patients had CNS recurrence of disease – one patient each in the 18 Gy and extra methotrexate arm as well as 24 Gy and extra methotrexate arm, two had 18 Gy and no extra methotrexate, and two had 24 Gy and no extra methotrexate. No differences were also evident in the marrow or testicular relapse rates due to the different cranial radiotherapy and IT MTX schedules.

## Conclusion

A reduction in the cranial irradiation dose from 24 to 18 Gy did not increase relapse rates within the CNS. Similarly, additional intrathecal methotrexate during maintenance did not have any significant effect on CNS relapse.

## Study 3

Brandalise S, Odone V, Pereira W, Andrea M, Zanichelli M, Aranega V for ALL Brazilian Group, State University of Campinas, Sao Paulo, Brazil. Treatment results of three consecutive Brazilian co-operative childhood ALL protocols: GBTLI-80, -82 and -85. *Leukaemia* 1993;7:S142–5.

## Study design

GBTLI-80 was a prospective randomized multicenter of the All Brazilian Group study that ran from July 1980 till July 1982.

## Objectives

The objectives of the trial were to compare and evaluate the efficacy of 18 Gy cranial irradiation against 24 Gy cranial irradiation in the prevention of CNS relapse of leukemia in children with good risk ALL.

## Details of the study

All children with untreated ALL who were less than 18 years of age and with no previous malignancies were included in the study. All patients with FAB L3 morphology were excluded from the study.

Patients were classified into two prognostic risk groups according to clinical and hematological factors. Good prognosis included patients with WBC count  $<100 \times 10^9/l$ , with no mediastinal mass or CNS disease. All others were categorized into the poor prognostic group.

Induction therapy consisted of vincristine  $1.5 \text{ mg/m}^2/\text{week} \times 4$ , daunorubicin  $25 \text{ mg/m}^2/\text{week} \times 4$  and prednisone  $40 \text{ mg/m}^2/\text{day} \times 28$  days. High risk patients (poor prognosis) also received cyclophosphamide  $1200 \text{ mg/m}^2$  IV on day 1. Good risk patients who achieved remission underwent randomization between 24 and 18 Gy cranial irradiation for CNS prophylaxis. All high risk patients received 24 Gy cranial irradiation at week 72. Maintenance therapy consisted of daily oral 6-mercaptopurine  $50 \text{ mg/m}^2$  and weekly oral methotrexate  $15 \text{ mg/m}^2$ .

Four pulses of cyclophosphamide  $150 \text{ mg/m}^2/\text{day} \times 7$  and doxorubicin  $35 \text{ mg/m}^2$  on day 8 were also given during the first year of maintenance therapy. Treatment was continued for 120 weeks for all children.

Details of the randomization method are not given in the study.

Outcome measures were: CNS relapse rate and event-free survival (EFS).

### Outcome

Of the 203 patients enrolled on study GBTLI-80, only 185 were eligible for analysis. Exact reasons as to why 18 were excluded from analysis are not stated in the report. It is not clear whether analysis was on the basis of intention to treat.

Of 185 patients analyzed, 167 (90%) achieved remission. At the time of analysis (July 1992) 67 patients had relapsed. The incidence of isolated CNS and combined CNS relapse was 6.7%. There was no statistically significant difference in CNS relapse rates between the patients who received 18 and 24 Gy cranial irradiation ( $p = 0.61$ ).

The 12-year EFS for both the good and high risk groups was 50% (SD5%).

### Conclusion

It was concluded that 18 Gy cranial irradiation was adequate in not only preventing CNS relapse of leukemia but also had no adverse outcome on EFS in children with good risk ALL.

## Study 4

Schrappé M, Reiter A, Zimmermann M, Harbott J, Ludwig W-D, Henze G, Gadner H, Odenwald E, Riehm H. Long-term results of four consecutive trials in childhood ALL performed by the ALL-BFM study group from 1981 to 1995. *Leukaemia* 2000;14:2205–22.

### Study design

ALL-BFM 83 was a multicenter prospective randomized study with treatment stratified according to the BFM (Berlin–Frankfurt–Münster) risk criteria. ALL-BFM 83 began in October 1983 and was closed in September 1986.

### Objectives

The study compared the efficacy of two different doses of presymptomatic cranial irradiation – 12 Gy versus 18 Gy – in the prevention of CNS relapse of leukemia in children with high standard risk ALL.

### Details of the study

The study was open to all patients less than 18 years of age with previously untreated leukemia. Children with Down's syndrome who had severe cardiac defects were excluded, as were children who developed ALL as a second malignancy.

Patients were categorized as standard risk (SR: RF  $< 1.2$ ), medium risk (MR: RF  $1.2 < 1.7$ ) or high risk (HR: RF  $\geq 1.7$ ) according to the leukaemic cell mass or BFM risk factor at diagnosis. SR patients were further subdivided in ALL-BFM 83 into low-SR (RF 0.8) and high SR (RF 0.8–1.2) groups.

The duration of induction therapy was 11 weeks. ALL-BFM 83 induction therapy commenced with a 1 week prednisone (PDN) window with a stepwise increase to full dose of  $60 \text{ mg/m}^2/\text{day}$ . The other drugs used during induction therapy (Protocol I) consisted of vincristine (VCR)  $1.5 \text{ mg/m}^2/\text{week} \times 4$  PDN  $60 \text{ mg/m}^2/\text{day}$ , daunorubicin  $30 \text{ mg/m}^2/\text{week} \times 4$  (DNR), L-asparaginase  $10,000 \text{ U/m}^2/\text{dose} \times 8$  (ASP), cyclophosphamide (CPM)  $1 \text{ g/m}^2/\text{dose} \times 2$ , cytosine arabinoside

(ARA-C) 75 mg/m<sup>2</sup>/dose × 16, 6-mercaptopurine (6-MP) 60 mg/m<sup>2</sup>/day × 28 days and intrathecal methotrexate (IT MTX).

All SR patients of ALL-BFM 83 received 6-MP 25 mg/m<sup>2</sup>/day and IV MTX 0.5 g/m<sup>2</sup>/dose × 4 during the consolidation phase.

Re-intensification also consisted of two phases: Phase A – dexamethasone (DEX)/VCR/doxorubicin (DOX)/ASP; Phase B – ARA-C/6-thioguanine (6-TG)/IT MTX (Protocol III, 4 weeks). Low-SR patients were randomized to receive or not the re-intensification block and furthermore did not receive cranial irradiation. High SR patients were randomized to either 12 or 18 Gy cranial radiotherapy at the end of this block of treatment as part of CNS prophylaxis.

Maintenance phase consisted of daily oral 6-MP and weekly oral MTX for 18 months. Patients in continuous clinical remission were randomized either to stop therapy (18 months) or to continue maintenance treatment for a further 6 months and stop (24 months).

Intrathecal chemotherapy – eight courses of IT MTX – was given to patients in the ALL-BFM 83 study.

The median follow-up of patients in continuous complete remission was 11.06 years (8.0–16.1 years).

Randomization details were not specified in the report. Comparisons between the treatment groups were made using the log-rank test.

Outcome measures were CNS relapse rate, disease-free survival (DFS) and event-free survival (EFS).

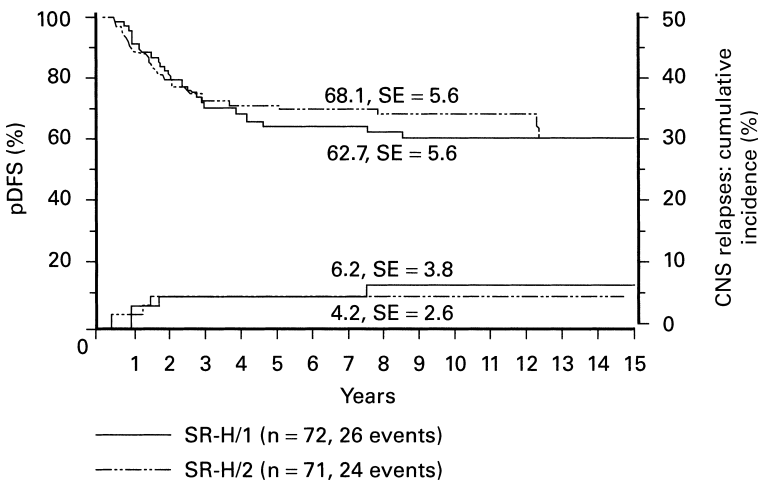
## Outcome

All analyses were based on the principle of intention to treat. The trial registered 653 patients. Of the 397 patients considered as SR (60.8%), 197 (30.2%) were categorized as high SR and 200 as low-SR. Two hundred and eight (31.9%) were categorized as MR and 47 (7.2%) as HR. Of the high SR patients, 143 were randomized to either 18 Gy (n = 71) (SR-H/2) or 12 Gy (n = 72) (SR-H/1) cranial irradiation for CNS prophylaxis. Reasons for exclusion of the 54 high SR patients from randomization are not specified in the report.

Eight-year EFS for high SR patients was 63.8 ± 3.5%. The probability of DFS (pDFS) at 8 years for high SR patients who received 12 Gy cranial irradiation (SR-H/1) was 62.7 ± 5.6% as compared to 68.1 ± 5.6% for those who received 18 Gy (SR-H/2) (p = 0.68). The cumulative incidence of CNS relapse was also not significant between the two groups of patients (Figure 15.5).

## Conclusion

CNS prophylaxis with 12 Gy of cranial irradiation was as effective as 18 Gy in the prevention of CNS relapse of leukemia and did not have any adverse impact on DFS in high SR patients.



**Figure 15.5** DFS and cumulative CNS relapse incident in relation to radiation dose (H/1 = 12 Gy, H/2 = 18 Gy). Adapted and reprinted from Schrappe *et al*, *Leukaemia* with permission from Nature, Macmillan Publishers Ltd (full reference on p. 332).

## Study 5

Tsuchida M, Ikuta K, Hanada R, Saito T, Isoyama K, Sugita K, Toyoda Y, Manabe A, Koike K, Kinoshita A, Maeda M, Ishimoto K, Sato T, Okimoto Y, Kaneko T, Kajiwara M, Sotomatsu M, Hayashi Y, Yabe H, Hosoya R, Hoshi Y, Ohira M, Bessho F, Tsunematsu Y, Tsukimoto I, Nakazawa S for the Tokyo Children's Cancer Study Group.

Long-term follow-up of childhood acute lymphoblastic leukaemia in Tokyo Children's Cancer Study Group 1981–1995. *Leukaemia* 2000;14:2295–306.

### Study design

Trial L81-10 was a study run by the Tokyo Children's Cancer Group between 1981 and 1984, and was a prospective multicenter randomized trial.

#### Objectives

The objectives were to compare two differing doses of cranial irradiation (18 Gy versus 24 Gy) as CNS prophylactic regimens in the treatment of children with standard risk ALL.

### Details of the study

Previously untreated children of between 1 and 15 years of age were entered into the study. Children with B-ALL or T-ALL were excluded from the trial. Children were categorized as standard risk (SR) if they were between 1 and 6 years of age with WBC count at diagnosis  $<20 \times 10^9/l$ . All others were treated as high risk (HR).

Induction therapy consisted of 5 weeks of vincristine  $1.5 \text{ mg/m}^2/\text{week}$ , prednisolone  $60 \text{ mg/m}^2/\text{day}$  and L-asparaginase  $6000 \text{ U/m}^2 \times 8$  for all patients. This was followed by presymptomatic CNS treatment that consisted of cranial irradiation plus intrathecal methotrexate  $15 \text{ mg/m}^2$  and hydrocortisone  $15 \text{ mg/m}^2 \times 5$  (IT MH). SR patients were randomized to either 18 or 24 Gy prophylactic cranial irradiation while HR patients received 24 Gy cranial irradiation.

No details of the randomization methodology are specified in the report.

Maintenance therapy consisted of daily oral 6-mercaptopurine and weekly oral methotrexate. SR children had mini-intensifications every 16 weeks during maintenance with dexamethasone (DEX)  $10 \text{ mg/m}^2 \times 7$  days and cyclophosphamide (CPM)  $150 \text{ mg/m}^2 \times 5$  days. In HR patients, the mini intensifications were at 12-weekly intervals during maintenance and they were randomized to either DEX + daunorubicin  $30 \text{ mg/m}^2$  (DNR) + CPM, or DEX + DNR alone.

Outcome measures were EFS and probability rate of cumulative isolated CNS relapse and any other CNS relapse.

### Outcome

All analyses were performed on the basis of intention to treat. Of the 195 patients enrolled on the study, 86 and 109 patients were classified as SR and HR respectively. Six were excluded from analysis either due to lack of information or incorrect risk classification. Thus 189 were considered evaluable.

Forty-six SR patients received 18 Gy while 40 received 24 Gy cranial irradiation.

The median follow-up duration for patients who were free of failure was 15.3 years (8.9–17.7 years).

A total of 183 (96.8%) patients achieved complete remission. The overall EFS at 5 years was  $.5 \pm 3.8\%$ . The 5-year EFS in the 18 Gy SR group was  $81.7 \pm 5.8\%$  compared to  $62.3 \pm 8\%$  in the 24 Gy SR group ( $p = 0.1419$ ). At 15 years, the EFS was  $67.2 \pm 7.2\%$  and  $53.3 \pm 8.4\%$  respectively. There were three CNS relapses in each arm. No significant differences in EFS were observed in the two HR groups.

### Conclusion

In standard risk children with ALL, CNS prophylaxis with 18 Gy cranial irradiation was adequate in preventing CNS relapse of leukemia with no adverse impact on EFS.

## Study 6

Deborah P. Waber, Lewis B. Silverman, Lori Catania, William Mautz, Montse Rue, Richard D. Gelber, Donna E. Levy, Meredith A. Goldwasser, Heather Adams, Annie Dufresne, Victoria Metzger, Ivonne Romero, Nancy J. Tarbell, Virginia Kimball Dalton, Stephen E. Sallan. *J Clin Oncol* 2004;22:2701–7.

Outcomes of a randomized trial of hyperfractionated cranial radiation therapy for treatment of high risk acute lymphoblastic leukemia (ALL): Therapeutic efficacy and neurotoxicity.

### Study design

This study was a prospective randomized multicenter trial that was conducted between November 1987 and December 1995. Details of the randomization methodology were not specified in the chapter. Written informed consent was obtained for all patients registered on this study and all analysis of results was on the premise of intention to treat.

### Objectives

The study evaluated the efficacy and neurotoxicity of hyperfractionated cranial radiotherapy as presymptomatic CNS treatment in children with high risk acute lymphoblastic leukemia (ALL).

### Details of the study

#### Treatment protocol

All patients were treated on the two previously published Dana Farber Cancer Institute (DFCI) 87-01 and 91-01 protocols (references). Children were considered high risk if they had any of the following features – age <2 years or >9 years; presenting white blood count  $>20 \times 10^9/l$ ; T cell-ALL; anterior mediastinal mass or central nervous system (CNS) leukemia. Both protocols included a six drug induction regimen comprising doxorubicin, vincristine, prednisolone, L-asparaginase, methotrexate and intrathecal cytarabine. Post remission consolidation chemotherapy consisted of weekly high dose asparaginase and doxorubicin.

High risk patients were randomized to either conventionally fractionated radiotherapy (CF-RT) or hyperfractionated radiotherapy (HF-RT). Patients randomized to CF-RT received 18 Gy; in 10 fractions of 1.8 Gy/fraction; one fraction/day over a period of 12–14 days while those

randomized to HF-RT received the same total dose in 20 fractions of 900 cGy; 2 fractions/day at least 6 hours apart over a period of 12–14 days. High risk infants with ALL had cranial radiotherapy (CR RT) delayed until they were 1 year old. Both groups of patients also received intrathecal cytarabine (IT ARA-C) and methotrexate (IT MTX) along with their cranial radiotherapy. IT ARA-C and IT MTX doses were based on age (<1 year; MTX-6 mg and ARA-C-15 mg, 1–2 years; MTX-8 mg and ARA-C-20 mg, 2–3 years; MTX-10 mg and ARA-C-30 mg and >3 years; MTX-12 mg and ARA-C-40 mg) and was administered four times during the 2-week period of CR RT and thereafter at 18-weeks interval. High risk patients with CNS leukaemia at diagnosis were excluded from randomization.

Table 15.2 lists the battery of tests used for neuropsychological testing. Testing was performed at a median of 7.6 years after the diagnosis of ALL (6.5–10.4 years). For children whose primary language was Spanish or French, the most recent edition of the Wechsler in that language was used. The median follow-up for the 369 high risk patients in the study was 8.2 years which was based on a reverse censoring method.

### Statistical methods

Two tailed *t* tests and Fischer's exact tests were used to compare children on the two arms of the protocol in terms of the various characteristics that might have affected their cognitive performances and also to evaluate the differences in the test scores between the two groups. There were no corrections for multiple comparisons. The study was powered to detect an effect size of 0.51 using a two sided *t* test at 5% significance level. Overall Survival (OS) and event free survival (EFS) were estimated by the Kaplan Meier life table method and the standard errors (SEs) for the 8 year estimates were calculated using Greenwood's formula.

### Outcome end points

The main end points were overall survival OS and late neuropsychologic toxicity.

### Outcome

#### Study population

Of the 467 eligible patients with high risk ALL, only 369 were randomized to either CF-RT ( $n = 180$ ) or HF-RT ( $n = 189$ ). Evaluation of treatment efficacy was

**Table 15.2** Neuropsychologic test battery.

---

Wechsler intelligence scales (Information, vocabulary, digit span, picture arrangement, block design) <sup>1-2</sup>
Rey-Osterrieth complex figure-copy, immediate recall <sup>3</sup>
Wide range assessment of memory and learning-verbal learning, visual learning <sup>4</sup>
Woodcock-Johnson psychoeducational battery-revised, letter-word ID, passage comprehension, calculation. <sup>5</sup>

---

based on the 369 patients who took part in the radiotherapy randomization.

However, only 125 patients met the eligibility criteria for neuropsychological testing. Eighty two patients were deemed ineligible for neuropsychological testing due to early death ( $n = 58$ ), relapse ( $n = 20$ ), cerebrovascular events ( $n = 3$ ) and unspecified reason ( $n = 1$ ). A further 152 patients were not tested for the following reasons: refused to participate/respond to invitation ( $n = 77$ ), lost to follow-up ( $n = 11$ ), lived far away ( $n = 19$ ), could not be contacted ( $n = 34$ ) and miscellaneous causes ( $n = 11$ ). Of the 135 who were tested, 10 were excluded because of pre-existing neurological problems prior to the diagnosis of ALL. Comparison of eligible children who underwent neuropsychological testing against those who were not tested revealed no differences in sex, C-RT randomization, MTX dose or native language. Children who were not tested were older and were more likely to have been treated on the DFCI 87-01 protocol. Of the 125 eligible patients evaluated for neuropsychological outcomes, 10 did not receive the intended therapy. Only 92% of patients tested for neuropsychologic outcomes received the intended therapy but those who did not were more likely to have been randomized to the HF-RT arm of the study.

## OS and EFS

The 8-year event-free survival (EFS) and OS for patients randomized to CF-RT was  $80 \pm 3\%$  (SE) and  $85 \pm 3\%$  respectively compared to  $72 \pm 3\%$  and  $78 \pm 3\%$  respectively for the HF-RT randomized patients ( $p = 0.058$  and  $0.069$ ) (Figures 15.6 and 15.7).

For patients treated on protocol 87-01, the 8-year EFS was  $78 \pm 4\%$  for patients randomized to CF-RT compared to  $72 \pm 5\%$  for patients randomized to HF-RT ( $p = 0.31$ ). The 8-year OS was  $83 \pm 4\%$  for CF-RT

patients compared with  $79 \pm 4\%$  for patients randomized to HF-RT ( $p = 0.34$ ).

The 8-year EFS for patients randomized to CF-RT on the 91-01 protocol was  $83 \pm 4\%$  compared to  $71 \pm 6\%$  for the HF-RT ( $p = 0.09$ ) while the 8-year OS was  $89 \pm 3\%$  for the CF-RT group compared to  $76 \pm 5\%$  for the HF-RT randomized patients ( $p = 0.08$ ).

CNS relapses occurred in five patients each in both CF-RT and HF-RT arms ( $p = 0.99$ ). The remission death rates was equivalent in the two groups with five such deaths in each arm ( $p = 0.99$ ). The observed difference in the EFS rates between the two groups was primarily due to fewer bone marrow relapses on the CF-RT arm (16; 8.9%) compared with 32 (17%) in the HF-RT arm.

## Neuropsychologic function

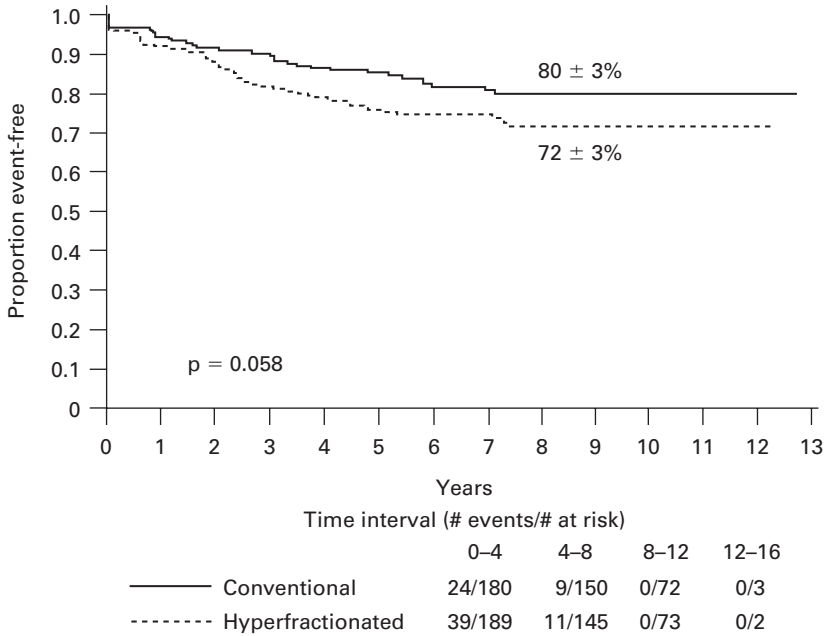
Table 15.3 shows the patient characteristics according to CR RT randomization. The median elapsed time from diagnosis to neuropsychologic evaluation for all children was 7.6 years (range, 6.5–10.4 years).

Children randomized to HF-RT achieved higher scores than those randomized to CF-RT for visual learning ( $p = 0.03$ ), the Rey-Osterrieth Complex Figure Organisation Recall ( $p = 0.04$ ) and structural accuracy ( $p = 0.06$ ). There were no significant differences for any of the other variables (Table 15.4). Scores were generally close to the expected means for the population at large, 100 for standard scores and 10 for scaled scores. Repeating the analyses for children who were below 3 years of age at diagnosis, showed that there was no difference in the cognitive late sequel for children randomized to either arm.

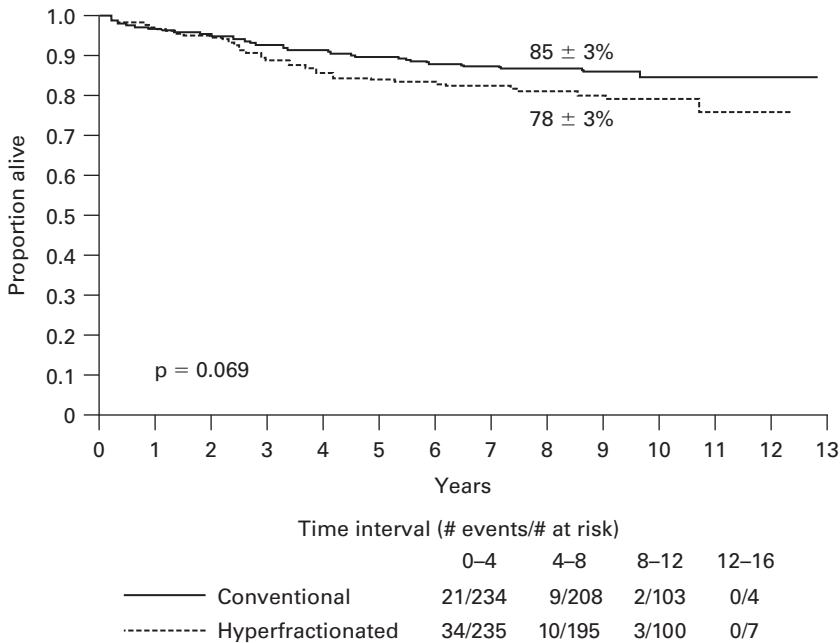
Achievement testing scores were similar between the two arms for English speaking children and very close to the expected means for the general population (Table 15.5).

## Conclusion

It was concluded that hyperfractionated cranial radiotherapy provided no benefit in terms of cognitive late effects and compromised overall clinical outcome. Hyperfractionated cranial irradiation should not be substituted for conventional radiotherapy in children who require cranial irradiation for ALL.



**Figure 15.6** EFS for all patients randomly assigned to conventional versus hyperfractionated cranial radiation therapy. EFS rates ( $\pm$ SE) are at 8 years. © American Society of Clinical Oncology (full reference on p. 335).



**Figure 15.7** OS for all patients randomly assigned to conventional versus hyperfractionated cranial radiation therapy. OS rates ( $\pm$ SE) are at 8 years. © American Society of Clinical Oncology (full reference on p. 335).



**Table 15.3** Characteristics of patients who received neuropsychologic testing according to CRT random assignment.

Patient Characteristic	Conventional Fractions (n = 71)		Hyperfractionated Fractions (n = 54)		Total (N = 125)	
	Number of Patients	(%)	Number of Patients	(%)	Number of Patients	(%)
Age at diagnosis years						
Median		3.9		5.0		4.4
Range		0.7–17.0		0.3–17.4		0.3–17.4
Age <36 months at diagnosis	23	32.4	18	33.3	41	32.8
Age at evaluation years						
Median		12.0		13.1		12.4
Range		7.5–24.4		8.1–25.5		7.5–25.5
Male sex	39	54.9	25	46.3	64	51.2
Protocol						
87–01	28	39.4	23	42.6	51	40.8
91–01	43	60.6	31	57.4	74	59.2
Randomly assigned to receive						
High dose methotrexate	14	19.7	13	24.1	27	21.6
Standard-dose methotrexate	14	19.7	10	18.5	24	19.2
Received high dose methotrexate as per protocol 91–01	43	60.6	31	57.4	74	59.2
Native language*						
English	49	69.0	31	57.4	80	64.0
Spanish	11	15.5	5	9.3	16	12.8
French	11	15.5	18	33.3	29	23.2
Parent education						
Less than high school	8	11.3	9	16.7	17	13.6
High school graduate	20	28.2	16	29.6	36	28.8
Some college/associate degree	21	29.6	11	20.4	32	25.6
College graduate	16	22.5	13	24.1	29	23.2
Postgraduate education	5	7.0	5		9.310	8.0
Unknown	1	1.4		–	1	0.8

\*Fisher's exact test p= 0.06.

**Table 15.4** Neuropsychologic outcomes according to CRT random assignment.

Neuropsychologic Measure	Conventional Fractions (n = 71)		Hyperfractionated Fractions (n = 54)		Total (N = 125)	
	Mean	SD	Mean	SD	Mean	SD
Wechsler intelligence scale for children-III*						
Estimated full scale IQ	101.0	14.3	101.3	17.2	101.1	15.6
Information <sup>†</sup>	10.1	2.8	9.2	3.4	9.7	3.1
Vocabulary	9.9	2.7	10.6	3.2	10.2	2.9
Digit span	9.0	2.9	8.7	3.0	8.9	3.0
Picture arrangement	9.2	3.0	9.2	3.1	9.2	3.0
Block design	10.4	3.6	9.8	3.5	10.2	3.6
Wide range assessment of memory and learning <sup>‡</sup>						
Verbal learning	11.2	2.7	11.0	2.7	11.1	2.7
Visual learning <sup>§</sup>	9.9	2.9	11.1	3.1	10.4	3.0
Rey-Osterrieth complex figure <sup>  </sup>						
Organization copy	8.1	3.5	8.2	3.5	8.1	3.5
Organization recall <sup>§</sup>	6.6	4.2	8.1	4.1	7.3	4.2
Style copy	2.3	1.2	2.3	1.2	2.3	1.2
Style recall	2.3	1.2	2.3	1.1	2.3	1.2
Structural accuracy copy	23.8	2.7	23.8	2.7	23.8	2.7
Structural accuracy recall	18.4	6.9	20.5	5.1	19.3	6.2
Incidental accuracy copy	37.2	4.1	37.4	2.7	37.3	3.5
Incidental accuracy recall	24.9	8.1	26.6	7.6	25.7	7.9
Errors copy	1.7	2.0	1.5	2.2	1.6	2.1
Errors recall	2.7	1.7	2.6	2.2	2.6	1.9

CRT: cranial radiation therapy; CFX: conventionally fractionated CRT; HFX: hyperfractionated CRT; IQ: Intelligence quotient; SD: standard deviation.

\*HFX, n = 52

<sup>†</sup> p < 0.1 by t test

<sup>‡</sup> Verbal learning CFX, n = 69; HFX, n = 53, Visual learning CFX, n = 67; HFX, n = 53.

<sup>§</sup> p < 0.05 by t test.

<sup>||</sup> CFX, n = 70.

**Table 15.5** Academic achievement scores for English-speaking children according to CRT random assignment.

Achievement Measure	Conventional Fractions (n = 48)		Hyperfractionated Fractions (n = 30)		Total (N = 78)	
	Mean	SD	Mean	SD	Mean	SD
WRAT, spelling	97.8	16.0	97.3	16.0	97.6	15.9
WJ, letter-word identification*	104.3	16.8	108.1	15.9	105.8	16.5
WJ, passage comprehension	103.0	15.9	106.1	15.3	104.2	15.6
WJ, Calculation <sup>†</sup>	98.2	16.2	101.1	18.5	99.3	17.0

CRT: cranial radiation therapy; CFX: conventionally fractionated CRT; HFX: hyperfractionated CRT; SD: standard deviation; WRAT: wide range assessment test; WJ: Woodcock–Johnson psychoeducational Battery-Revised.

\*CFX, n = 47

<sup>†</sup> CFX, n = 47; HFX, n = 28.

# CNS prophylaxis in acute lymphoblastic leukemia – comparisons of methods of CNS directed therapy

## Studies: Radiation and chemotherapy

### Study 7

Komp DM, Fernandez CH, Falletta JM, Ragab AH, Bennett Humphrey G, Pullen J, Moon T, Shuster J. CNS prophylaxis in acute lymphoblastic leukaemia: comparison of two methods – a Southwest Oncology Group study. *Cancer* 1982;**50**:1031–6.

#### Study design

This was part of the AlinC–9 trial (July 1971–March 1973), which was a prospective randomized multicenter study.

#### Objectives

The primary aim of the study was to evaluate whether cranial irradiation plus triple intrathecal chemotherapy was superior to triple intrathecal chemotherapy alone as CNS prophylaxis therapy.

#### Details of the study

All children younger than 15 years of age with leukemia were enrolled on the trial. This report focuses exclusively on children with acute lymphoblastic leukemia.

Remission induction therapy consisted of vincristine (VCR) plus prednisone (PDN) or VCR plus PDN along with cyclophosphamide and asparaginase.

Maintenance therapy consisted of 6-mercaptopurine plus regular pulses of PDN. One group of patients also received monthly daunorubicin. Details of the dosing schedules are not specified in the report.

Details of the randomization methodology are not given. Randomization of treatment groups was done at the time of initial diagnosis.

Presymptomatic CNS treatment was commenced during maintenance therapy and consisted of intrathecal methotrexate 15 mg/m<sup>2</sup> (maximum 15 mg), intrathecal hydrocortisone (15 mg/m<sup>2</sup>) and intrathecal cytosine arabinoside (30 mg/m<sup>2</sup>). During the first month of maintenance, triple intrathecal therapy was given weekly and thereafter once every 2 months up to a year or till bone marrow or CNS relapse. In addition, one half of the patients were randomized to receive 24 Gy cranial irradiation, which was given at the beginning of maintenance therapy.

Outcome measures were CNS relapse rate, disease-free survival (DFS) and overall survival.

#### Outcome

Of the 194 patients who achieved remission, 102 were randomized to triple intrathecal chemotherapy alone while 92 patients received cranial irradiation plus triple intrathecal chemotherapy. Minimum follow-up for surviving patients was 8 years.

Major violations of CNS prophylaxis protocol occurred in 14 patients.

Eleven patients developed CNS relapses during remission; isolated CNS relapse 6; concurrent with bone marrow or testicular relapse 2; following an earlier testicular relapse 3. Seven occurred in non-irradiated patients (n = 102) while four had been radiated (n = 92).

No significant difference was noted in the duration of CNS remission or in the CNS relapse rate between the two groups of patients (p = 0.44) irrespective of the initial WBC count (Table 15.6).

There was no difference in the duration of disease-free remission (p = 0.84) or overall survival (p = 0.85)

**Table 15.6** CNS relapses versus WBC count at diagnosis.

WBC Count at Diagnosis	Treatment	Number of Patients	Number of CNS Relapses	p Value
<20 × 10 <sup>9</sup> /l	No RT	67	4	0.87
	RT	53	3	
>20 × 10 <sup>9</sup> /l	NO RT	35	3	0.35
	RT	39	1	
All patients	No RT	102	7	0.44
	RT	92	4	

RT: radiotherapy.

between the two groups of patients. Only two of the six patients (one patient in each group) who developed isolated CNS relapse remained in hematological remission.

**Toxicity**

Hematological toxicity was greater in the group that received cranial irradiation (p = 0.05). There were no differences in the occurrence of severe neurotoxicity or infections between the two groups of patients.

**Conclusion**

It was concluded that triple intrathecal chemotherapy was a satisfactory form of CNS prophylaxis for children with ALL and had no adverse impact on CNS relapse rate, length of hematological remission or overall survival.

**Study 8**

Sullivan MP, Chen T, Dymont PG, Hvizdala E, Steuber CP. Equivalence of intrathecal chemotherapy and radiotherapy as central nervous system prophylaxis in children with acute lymphatic leukaemia: a Pediatric Oncology Study Group. *Blood* 1982;60:948–58.

**Study design**

South West Oncology Group Study 7420 (AlinC-11) was a prospective multicenter randomized study and ran from September 1974 to October 1976.

Patients were randomized at diagnosis to one of the four treatment regimens shown in Figure 15.8. Randomization was according to prognostic groups based on age and WBC count at diagnosis (Table 15.7). Allocation to regimens 1 and 4 (conventional CNS regimen) was weighted 2:1 with the other two regimens. With each regimen, induction was continued for a total of 6 weeks if remission was not achieved in 4 weeks. Maintenance therapy consisted of daily 6-mercaptopurine and weekly methotrexate and was discontinued after 3 years’ continuous remission in all regimens.

**Table 15.7** Staging of acute lymphoblastic leukemia by age and WBC count at diagnosis.

WBC × 10 <sup>9</sup> /l	Age (Years)				
	1	1–2	3–5	6–10	10
<10	III	I	I	I	II
10–99	III	II	II	II	III
≥100	III	III	II	III	III

Stage I good prognosis.  
 Stage II average prognosis.  
 Stage III poor prognosis.

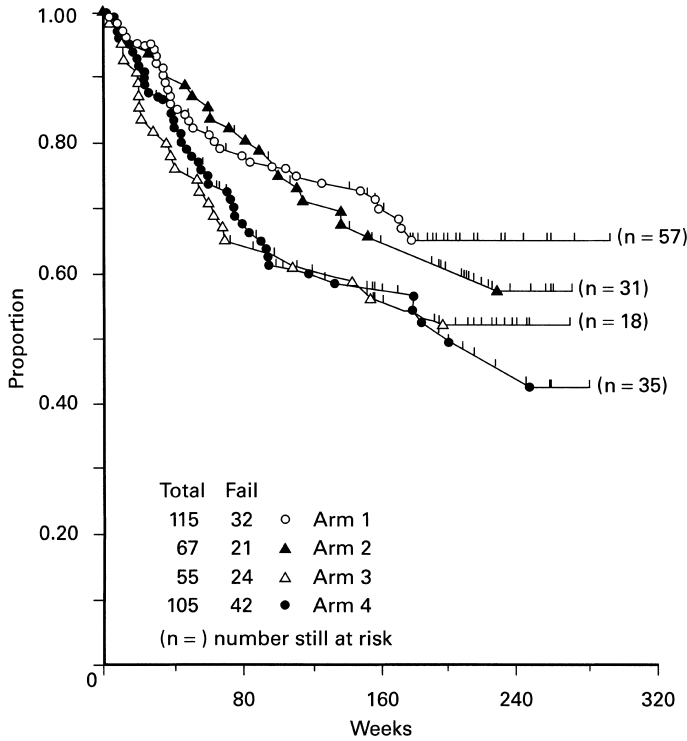
**Objectives**

The study compared the efficacy of intrathecal chemotherapy (IT CT) alone against 24 Gy cranial radiotherapy (CRT) plus intrathecal methotrexate (IT MTX) as CNS prophylaxis regimens.

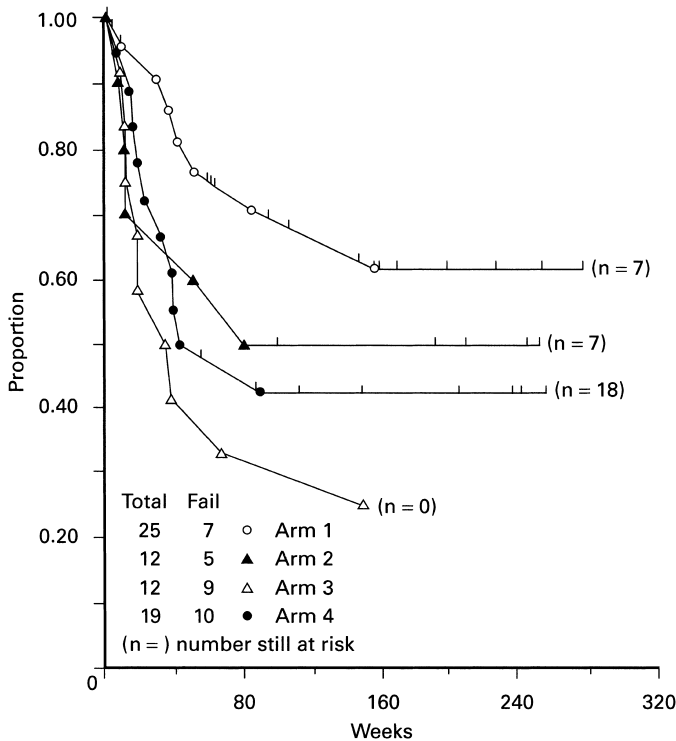
**Details of the study**

Previously untreated children and adolescents below 18 years of age were enrolled on the study.





**Figure 15.9** Duration of bone marrow remission: all prognostic groups. Reproduced with permission of the American Society of Hematology (full reference on p. 341).



**Figure 15.10** Duration of bone marrow remission in poor prognostic group. © American Society of Clinical Oncology (full reference on p. 340). Reproduced with permission of the American Society of Hematology (full reference on p. 341).

early death (16), inadequate trial (3), lost for follow-up (34), refused treatment (3), other reasons (59).

The number of CNS relapses, including those combined with marrow relapse in the IT regimens (regimens 1, 2 and 3) was 10/234 (4.3%) compared with 7/105 (6.1%) in the CRT plus IT regimen (regimen 4).

Figure 15.9 shows the duration of bone marrow remission for each treatment arm. Length of bone marrow remission in the poor prognostic group was better for arm 1 compared to arm 3 ( $p = 0.04$ ) as well as arm 4 ( $p = 0.01$ ) (Figure 15.10).

There were no significant differences in the number of patients with severe toxicity in any of the four regimens.

### Conclusion

It was concluded that IT chemotherapy was as effective as cranial radiotherapy plus IT methotrexate in preventing CNS relapse of leukemia.

## Study 9

Bleyer WA, Coccia PF, Sather HN, Level C, Lukens J, Niebrugge DJ, Siegel S, Littman PS, Leikin SS, Miller DR, Chard Jr RL, Denman Hammond G and the Children's Cancer Study Group. Reduction in central nervous system leukaemia with a pharmacokinetically derived intrathecal methotrexate dosage regimen. *J Clin Oncol* 1983;1:317–25.

### Study design

The chapter was a retrospective analysis of three major Children's Cancer Study Group studies: CCG-141, 141-A and 160 series. Each study had a different method of CNS prophylaxis and this varied from 24 Gy cranial irradiation plus intrathecal methotrexate (IT MTX) during consolidation (CCG-141), 24 Gy cranial irradiation plus IT MTX initiated during induction (CCG 141-A) or 18 Gy cranial irradiation plus IT MTX with or without IT MTX (randomized) during maintenance therapy but with dosage of IT MTX based on CNS volume rather than on body surface area (CCG-160 series). In the CCG-160 series, average risk patients were randomized to maintenance IT MTX (m-IT), low-risk patients were randomized to cranial irradiation or m-IT while high risk patients were administered m-IT (Table 15.8).

This review will focus on CCG study 160 (1978 till 1981), which evaluated the influence of maintenance IT MTX on CNS relapse, complete remission duration,

hematological remission duration and survival in average risk patients with ALL.

### Details of the study

Previously untreated children and adolescents under 18 years of age with ALL were registered on the trial. All children who had CNS leukemia at diagnosis were kept on the regimen to which they were randomized.

Details of randomization method are not specified.

Patients were stratified for risk as follows:

*Low risk:* 3–6 years of age, WBC at diagnosis  $<10 \times 10^9/l$  FAB L1 morphology.

*Average risk:*  $<3$  or  $>6$  years of age with WBC count  $<50 \times 10^9/l$  or 3–6 years of age and WBC count of  $10\text{--}50 \times 10^9/l$  or low-risk patients with FAB L2 morphology.

*High risk:* any age or FAB morphology with WBC count  $>50 \times 10^9/l$ .

Remission induction therapy consisted of vincristine (VCR), prednisone (PDN) and L-asparaginase (ASP). Consolidation therapy differed in the form of CNS treatment. Maintenance therapy (standard maintenance therapy consisted of VCR + PDN + MTX + 6-MP) depended on the randomization and risk group. Low-risk patients were randomized to a reduction in therapy with VCR and PDN deleted. A third of the average risk patients had standard maintenance therapy similar to that in the earlier trials, a third received periodic pulses of VCR, PDN and ASP added to the standard maintenance therapy every 6 months and a third

**Table 15.8** Children's Cancer Study Group (CCSG) studies of childhood acute lymphoblastic leukemia from 1976 to 1981.

Study	Years Patients Entered	Number of Patients Entered	Number of Patients Evaluable (%)	Preventive CNS Therapies <sup>a</sup>
CCG-141	1976-1977	877	818 (93)	Cr + IT
CCG-141A	1977-1978	421	387 (92)	Cr + IT
CCG 160 series Low risk CCG-161	1978-1981	1943 <sup>b</sup> 405 <sup>b</sup>	1797 (93)	IT → Cr IT → m-IT
Average risk CCG-162		1123 <sup>b</sup>		Cr + IT → m-IT Cr + IT → No IT
High risk CCG-163		415 <sup>b</sup>		Cr + IT + m-IT

<sup>a</sup>Arrows denote randomizations. Cr: cranial irradiation; IT: intrathecal MTX; m-IT: maintenance IT MTX therapy.

<sup>b</sup>As of 29 March 1982.

received pulses of cytosine arabinoside, doxorubicin or cyclophosphamide added at monthly intervals to the standard maintenance therapy. Children who were randomized to receive maintenance IT, were given IT MTX every 12 weeks during maintenance therapy.

Neither drug dosages nor the chemotherapy schedule are specified in the chapter.

IT MTX doses were age adjusted: 6 mg, 8 mg, 10 mg and 12 mg for ages <1, 1, 2 and 3 years or greater respectively.

Outcome measures were CNS relapse rate and duration of hematological remission.

## Outcome

CCG-160 enrolled 1943 patients, of whom 1123 were categorized as average risk. However, only 1024 patients were randomized to receive maintenance IT MTX or not. The actual number of patients randomized to each

arm is not specified. Details regarding the number of patients who were excluded, who failed remission induction therapy, who relapsed prior to commencement of maintenance therapy or who died in remission etc, are not available.

Patients who were randomized to receive maintenance IT MTX had a lower CNS relapse rate but the difference was only marginal ( $p = 0.06$ ). This was most evident in children over 10 years of age.

The incidence of bone marrow relapses, remission deaths and deaths after relapse were higher in the maintenance IT MTX group.

## Conclusion

It was concluded that maintenance intrathecal methotrexate did not significantly reduce CNS relapse rate in children with average risk ALL.

## Study 10

Ortega JA, Nesbit ME, Sather HN, Robinson LL, D'Angio GJ, Denman Hammond G. Long term evaluation of a CNS prophylaxis trial – treatment comparisons and outcome after CNS relapse in childhood ALL: a report from the Children's

Cancer Study Group. *J Clin Oncol* 1987;5: 1646-54.

## Study design

This was a Children's Cancer Study Group (CCG-101) prospective randomized multicenter study that extended from June 1972 to July 1974.



## Objectives

The study aimed to determine the effectiveness of four different CNS prophylaxis regimens and also their relationship to bone marrow relapse and survival.

## Details of the study

Previously untreated children and adolescents with ALL below the age of 18 years were included in the trial. Children less than 18 months of age were not randomized but allocated to regimen 4 – intrathecal methotrexate (IT MTX) alone. Protocol violations or marrow relapse on treatment were criteria for exclusion from the study.

No details regarding randomization are specified in the report.

Induction therapy consisted of vincristine, prednisone and L-asparaginase. Those who achieved complete remission were randomized to any one of four CNS prophylaxis regimens:

Regimen 1: 24 Gy craniospinal irradiation plus extended field radiation (12 Gy) to include liver, spleen, kidneys and gonads.

Regimen 2: 24 Gy craniospinal irradiation only.

Regimen 3: 24 Gy cranial irradiation + IT MTX 12 mg/m<sup>2</sup> twice a week × 6 doses.

Regimen 4: IT MTX 12 mg/m<sup>2</sup> twice a week × 6 doses.

Maintenance therapy consisted of daily 6-mercaptopurine (6-MP), weekly oral MTX and monthly pulses of vincristine and prednisone. Lumbar punctures were performed at bone marrow relapse and prior to discontinuation of maintenance therapy. Patients with CNS disease at diagnosis were given IT MTX 12 mg/m<sup>2</sup> twice a week (minimum two doses) until the CSF was clear.

Interim analysis showed that children on regimen 4 had a high incidence of CNS relapse and hence 93 regimen four patients, who had not developed CNS disease, were recalled for additional CNS prophylaxis. Those with WBC count  $\geq 20 \times 10^9/l$  were treated with regimen 2 while all others were treated with regimen 3. Twelve children chose not to have additional CNS prophylaxis.

Outcome measures were CNS relapse rate, disease-free survival (DFS) and overall survival.

## Outcome

Analysis of results was on an intention to treat basis. The median follow-up was 132 months (maximum of 161 months). Of the 736 patients enrolled on the study, only 675 patients completed induction and achieved remission. Five hundred and ninety were subsequently randomized to one of the four CNS prophylaxis regimens:

Regimen 1: 135

Regimen 2: 152

Regimen 3: 159

Regimen 4: 144

Regimen 4: 34 (Non-random allocation because of age).

For outcome analysis, patients were categorized into two groups. The first group included all patients who had IT MTX alone (regimen 4) and the second group comprised all patients who had cranial irradiation (regimens 1, 2 and 3).

Isolated CNS relapse as the first event was higher in regimen four patients compared to patients who had cranial irradiation (55 versus 29 ( $p < 0.0001$ , Figure 15.11). Isolated bone marrow relapses as the first event were higher in the radiotherapy group (Table 15.9).

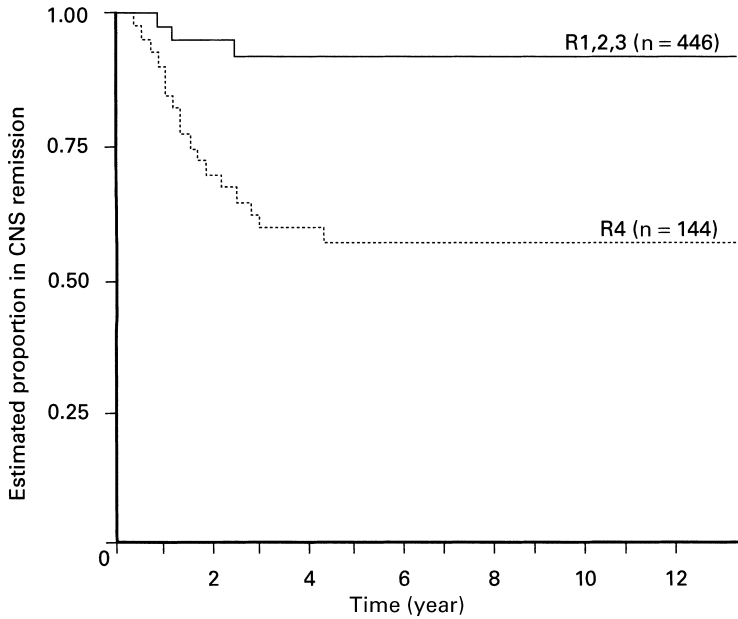
Figure 15.12 shows the difference in DFS for the two groups, again indicating a large difference ( $p < 0.001$ ).

The overall survival between the two groups was not significantly different ( $p = 0.16$ , Figure 15.13).

Of the 26 patients in regimen 4 who developed one isolated CNS relapse with no subsequent CNS relapses, 14 died and 12 remained alive (11 with no further relapses) (survival rate 46%). This compared to four in the irradiation group who remained alive (three with no further relapses of any type) of the 17 who developed one isolated CNS relapse (survival rate 24%).

## Conclusion

It was concluded that although short treatment with intrathecal methotrexate alone as CNS prophylaxis was unsatisfactory in preventing CNS relapse of leukemia, this did not impact significantly on overall survival due to a higher incidence of marrow relapses in the radiotherapy group.



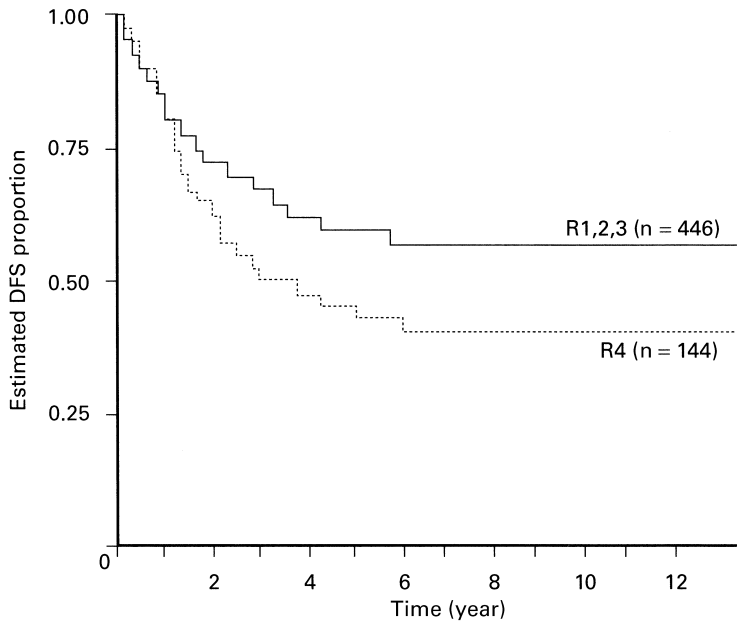
**Figure 15.11** Time to isolated CNS relapse (as an initial event) from randomization. © American Society of Clinical Oncology (full reference on p. 345).

**Table 15.9** Comparison of relapse/death rates in the CNS prophylaxis groups.

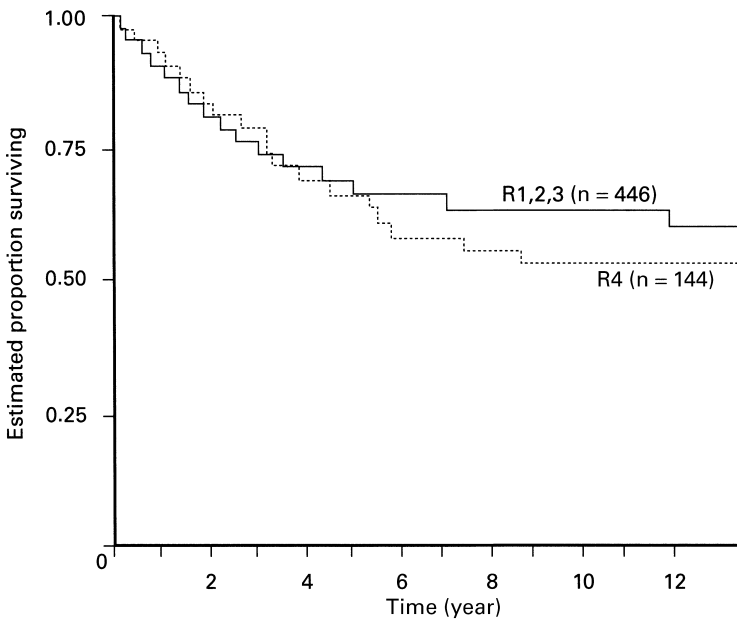
Type of Event	Regimen 4 (IT MTX)		Regimens 1, 2 and 3 (Radiotherapy)		
	Observed Events ( $O_1$ )	Expected Number ( $E_1$ ) <sup>a</sup>	Observed Events ( $O_2$ )	Expected Number ( $E_2$ ) <sup>a</sup>	Adjusted Difference <sup>b</sup>
Isolated CNS relapse as initial event	55	19.4	29	64.6	71.2
Isolated marrow relapse as initial event	18	24.4	88	81.6	-12.8
Other initial events	10	16.7	65	58.3	-13.4
Any first relapse or death in remission	83	60.5	182	204.5	45.0
Marrow relapse at any time	54	47.0	133	140.0	14.0
Death	67	57.7	168	177.3	18.6

<sup>a</sup>“Expected” number of events (calculated by life table methods) if both groups actually had the same risk of the event.

<sup>b</sup>Calculated by  $(O_1 - E_1) - (O_2 - E_2)$ ; this adjusts for the discrepancy in the size of the two groups and provides an estimate of the excess number of events between the two groups. A positive value indicates an excess for the IT MTX regimen; a negative value, an excess for the radiotherapy regimens.



**Figure 15.12** DFS from randomization. © American Society of Clinical Oncology (full reference on p. 345).



**Figure 15.13** Overall survival from randomization. © American Society of Clinical Oncology (full reference on p. 345).

**Study 11**

Littman P, Coccia P, Bleyer WA, Lukens J, Siegel S, Miller D, Sather H, Denman Hammond G. Central nervous system (CNS) prophylaxis in children with low risk acute lymphoblastic

leukaemia (ALL). *Int J Rad Oncol Biol Phys* 1987; 13: 1443–9.

**Study design**

Trial CCSG-161 of the Children’s Cancer Study Group was a prospective randomized study for

children with low risk ALL that ran from April 1978 to May 1983.

## Objectives

The study addressed whether maintenance intrathecal methotrexate (IT MTX) can be substituted for cranial irradiation (CR RT) as CNS prophylaxis treatment.

## Details of the study

Only previously untreated children aged between 3 and 6 years inclusive, with a total WBC count  $<10 \times 10^9/l$  at diagnosis and with less than 25% FAB L2 cells (low-risk group) in the bone marrow were enrolled on the study.

Median follow-up for surviving patients at the time of data analysis was 54 months from randomization – start of CNS intensification.

Details of the randomization method used are not reported.

All patients were treated on a standard induction regimen that consisted of vincristine (VCR), L-Asparaginase (ASP) and prednisone (PDN) for a 4-week period. In addition, two doses of IT MTX were given to all patients on day 0 and day 14 of induction therapy. At the end of induction therapy (day 28), patients who attained remission or M2 marrow ( $<25\%$  blasts) were randomized to one of four treatment groups with regard to intensification and maintenance:

Regimen 1: CR RT CNS prophylaxis plus maintenance chemotherapy of oral 6-mercaptopurine (6-MP) and MTX.

Regimen 2: CR RT CNS prophylaxis plus maintenance chemotherapy of oral 6-MP, MTX with additional pulses of VCR and PDN every 12 weeks.

Regimen 3: IT MTX CNS prophylaxis plus maintenance chemotherapy of oral 6-MP, MTX and IT MTX during maintenance at 12-week intervals.

Regimen 4: IT MTX CNS prophylaxis plus maintenance chemotherapy of oral 6-MP, MTX with additional VCR and PDN and IT MTX during maintenance therapy at 12 week intervals.

Patients randomized to CR RT received 18 Gy in 10 fractions with four doses of IT MTX on days 0, 7, 14 and 21 of the intensification block, and those randomized to IT MTX received four doses of IT MTX (on the

same days) and then every 84 days (8 or 12 doses, depending on the duration of maintenance) during maintenance therapy.

Patients who proceeded to maintenance therapy either had M1 or M2 marrow at the end of the intensification block. Those who were in continuous remission for 2 years were randomized either to continue maintenance therapy for an additional year (four additional maintenance cycles) or to stop therapy.

Outcome measures were disease-free survival (DFS), CNS relapse (isolated or concurrent) as a first disease recurrence, and bone marrow relapse.

## Outcome

Analyses of outcome were on the basis of intention to treat. The exact details regarding the number of patients enrolled on the study, induction failures, protocol violations, toxic deaths during induction therapy, relapse prior to randomization etc. are not specified in the report.

Of the 504 patients who were randomized to the two different CNS prophylaxis regimens, 250 patients were randomized to CR RT and 254 to IT MTX.

The last CNS relapse occurred at 41 months post CNS randomization and 76.1% of all disease-free patients were beyond that point.

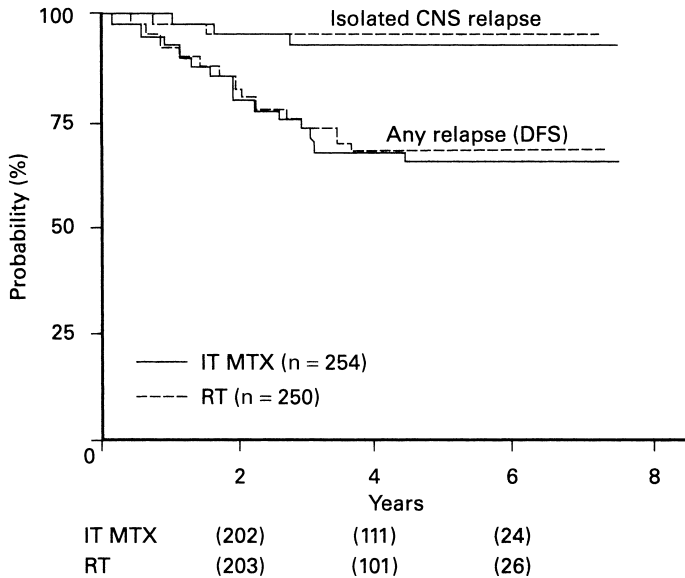
CNS relapse rate (isolated or concurrent) was 6% in the CR RT group compared to 8% in the IT MTX group ( $p = 0.48$ ) while the isolated CNS relapse rate from randomization was 5% and 7% respectively ( $p = 0.44$ ). The eventual cumulative incidence of CNS relapse as a first event was estimated to be 6.1% and 8.4% with CR RT and IT MTX respectively.

Bone marrow relapse rate was 21% and 22% in the CRT RT and IT MTX groups respectively ( $p = 0.88$ ).

The DFS at 54 months was 67.4% and 66.5% for CR RT and IT MTX groups respectively ( $p = 0.82$ ) (Figure 15.14).

## Conclusion

It was concluded that as both modalities of CNS prophylaxis had similar CNS relapse rates and DFS, intrathecal methotrexate could be substituted for cranial radiotherapy.



**Figure 15.14** Isolated CNS relapse and any relapse (disease-free survival) from the time of randomization. Comparison of CNS prophylaxis groups. Numbers in parentheses indicate the number of patients disease free that have reached various follow-up times. Reprinted from Littman *et al.*, *Int J Rad Oncol Biol Phys* (full reference on p. 349) with permission from Elsevier.

## Study 12

Ortega JJ, Javier G, Olive T. Treatment of standard- and high-risk childhood acute lymphoblastic leukemia with two CNS prophylaxis regimens. *Haematol Blood Transfus* 1987;30:483–91.

### Study design

This was a prospective randomized study – both pilot and a parallel multicenter (11 hospitals) trial – and is reported to have run from April 1978 to December 1983. Minimum follow-up was 25 months with a median of 62 months.

### Objectives

The study aimed to compare the efficacy of intrathecal chemotherapy (IT CT) alone versus cranial irradiation (CRT) plus intrathecal methotrexate (IT MTX) in the prevention of CNS relapse of leukemia in children. The other objectives were to improve outcome in patients with high risk acute lymphoblastic leukemia and to detect occult testicular disease in boys who were in continuous complete remission at 2 years.

This review focuses on the comparative efficacy of the two forms of CNS prophylactic regimens alone.

### Details of the study

All children with ALL (B-ALL excluded) below 15 years of age were enrolled on the study.

Patients were classified as standard risk (SR) and high risk (HR) according to a risk index that was based on clinical and hematological factors.

CNS prophylaxis regimens were as follows:

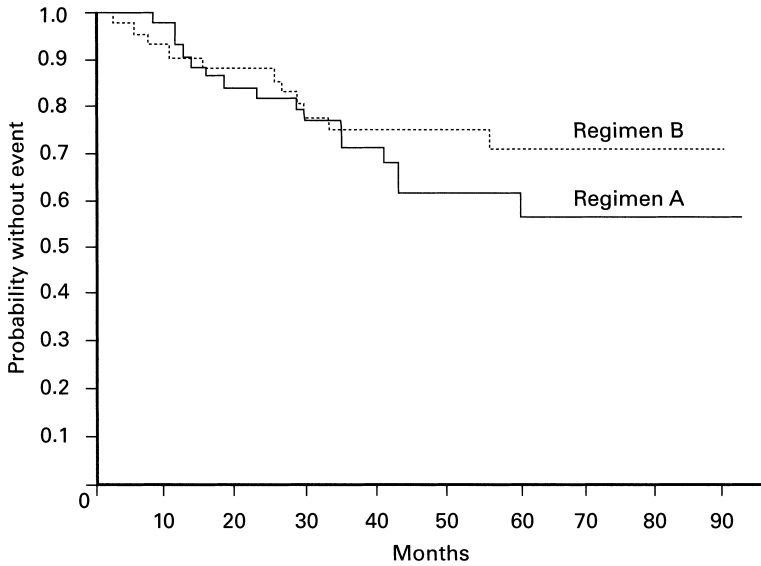
Regimen A: cranial irradiation (24 Gy/12 fractions) plus six doses of IT MTX.

Regimen B: Six doses of IT MTX and cytosine arabinoside (ARA-C) plus four additional monthly doses during the first year of maintenance.

All children received induction therapy that consisted of vincristine (VCR) 1.5 mg/m<sup>2</sup>/week × 4, prednisolone (PDN) 40 mg/m<sup>2</sup>/day × 4 weeks and L-asparaginase (ASP) 10,000 U/m<sup>2</sup> × 6 doses for the SR group and the same plus daunorubicin (DNR) 30 mg/m<sup>2</sup>/week × 2 for the HR group.

Presymptomatic CNS treatment consisted of CRT plus IT MTX (regimen A) or IT MTX 10 mg/m<sup>2</sup> (maximum dose 10 mg) and ARA-C 30 mg/m<sup>2</sup> (maximum dose 30 mg) (regimen B) along with 6-mercaptopurine (6-MP) 40 mg/m<sup>2</sup>/day in both regimens.

Maintenance treatment consisted of oral 6-MP 60 mg/m<sup>2</sup>/day and IM MTX 15 mg/m<sup>2</sup>/week. HR patients also received 2 week intensification blocks of PDN, VCR



**Figure 15.15** DFS with two regimens of CNS prophylaxis. Reprinted from Ortega *et al.* (full reference on p. 350) with permission Springer Science and Business Media.

(two doses) and DNR (one dose) every 12 weeks for 3 years. Duration of maintenance therapy was 3 years for girls and 5 years for boys.

Testicular biopsies were performed in all boys in CR at 2 years and those who had disease had testicular irradiation and 4 weeks of re-induction with VCR and PDN.

Outcome measures were disease-free survival (DFS) and CNS relapse rate.

## Outcome

### Pilot study (Hospital Infantil Vall d'Hebrón)

The number registered on the study was 87 (SR 65, HR 22). One HR patient was excluded who died in remission due to cranial trauma. There were 86 evaluable patients, comprising 34 SR and 10 HR patients in regimen A ( $n = 44$ ) and 31 SR and 11 HR patients in regimen B ( $n = 42$ ).

Five-year DFS for all patients was 65% (SD 6%). For SR patients the probability of continuous complete remission (CCR) was 67% and for HR patients it was 58%.

Five-year DFS in regimen A patients was 56.4% versus 71.4% in regimen B patients. This was not statistically significant (Figure 15.15).

Regimen A patients had more relapses ( $n = 16$ ) than those in regimen B ( $n = 10$ ), but this was not statistically significant. The proportion that relapsed within the

CNS was low: regimen A-2 (4.5%) versus regimen B-1 (2.4%). The bone marrow was the predominant site of relapse.

## Toxicity

Two patients treated on regimen A developed encephalopathy while a third developed akinetic seizures. One patient on regimen B developed transient paraparesis after the sixth IT treatment. Psychomotor evaluation showed a lower mean IQ in the irradiated group.

## Multicenter trial

Of 256 evaluable patients, 95% attained CR (243). Of these 114 (86 SR; 28 HR) patients had regimen A CNS prophylaxis while 129 (97 SR; 32 HR) were treated on regimen B. There were 108 relapses, of which 19 were CNS relapses. No significant differences according to CNS prophylaxis regimen were found. No further details are given in the report.

## Conclusion

It was concluded that CNS prophylaxis with intrathecal chemotherapy (methotrexate and cytosine arabinoside) was effective in preventing CNS relapse of leukemia.

## Study 13

Van Eys J, Berry D, Crist W, Doering E, Fernbach D, Pullen J, Shuster J, Wharam M. A comparison of two regimens for high-risk acute lymphocytic leukaemia in childhood. *Cancer* 1989;63:23–9.

### Study design

This was a Paediatric Oncology Group trial (AlinC-12) and was a prospective randomized study. Enrolment was from 1976 to 1979.

### Objectives

The study compared the efficacy of triple drug intrathecal chemotherapy (IT CT) against cranial irradiation plus IT methotrexate (IT MTX) as prophylaxis against CNS relapse of leukemia in children with high risk acute lymphoblastic leukemia.

### Details of the study

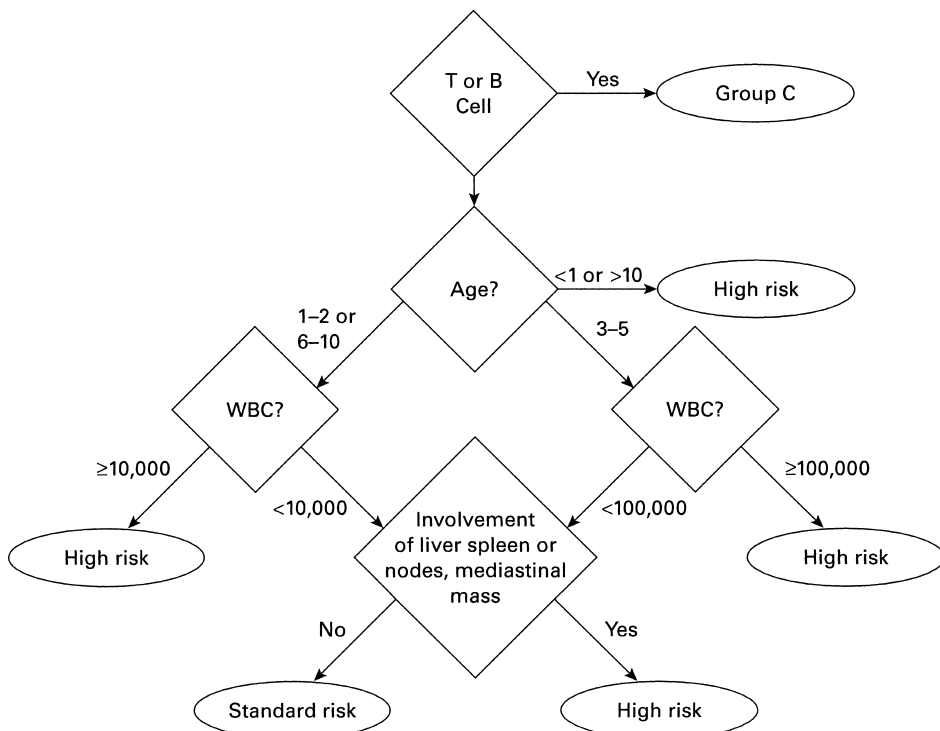
Previously untreated children and adolescents aged below 21 years with high risk ALL according to the POG criteria (Figure 15.16) were enrolled on the study. Excluded from the trial were patients with T-ALL, B-ALL (Sig<sup>+</sup>) or with CNS disease at diagnosis.

Details of the randomization methodology are not given in the report.

All patients were randomized at diagnosis to receive either arm 1 or arm 3. For arm 1 patients, induction therapy consisted of IV vincristine 2 mg/m<sup>2</sup>/week (maximum dose 2 mg), oral prednisone 60 mg/m<sup>2</sup>/day and IV L-asparaginase 10,000 IU/m<sup>2</sup> weekly × 2. If remission was not achieved after 4 weeks, two additional weeks of vincristine and prednisone were given.

In arm 3, induction was similar to arm 1 except that L-asparaginase 6000 IU/m<sup>2</sup> daily for 14 days was given during consolidation along with cyclophosphamide 1 g/m<sup>2</sup> on days 30 and 43.

CNS prophylaxis was as follows. In arm 1 the dose of cranial irradiation (CRT) was age dependent: >2

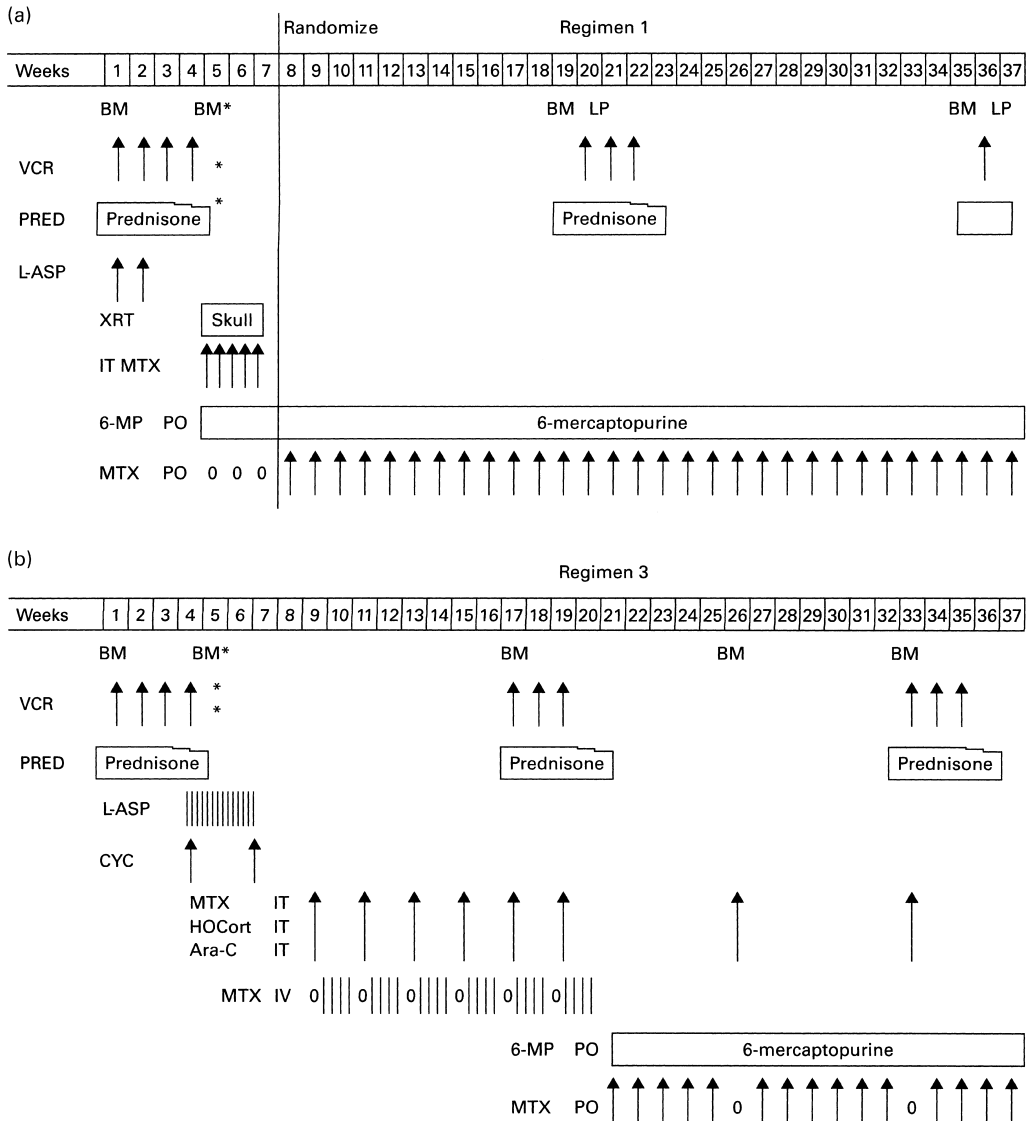


**Figure 15.16** Decision tree for risk classification. © 1989, American Cancer Society. Adapted and reprinted from Van Eys *et al.* (full reference above) by permission of Wiley-Liss, Inc., a subsidiary of John Wiley & Sons, Inc.

year 24Gy, 1–2 year 20Gy and <1 year 15Gy. Five doses of IT MTX were given during CRT. Treatment was given in daily fractions of 180–200 cGy, five fractions per week. CNS prophylaxis in arm 3 consisted of triple IT CT given on the day preceding each 4 day intravenous MTX every 2 weeks for six courses, and also during the entire maintenance phase of treatment

at 8 weekly cycles. Doses of intrathecal drugs were methotrexate 15 mg/m<sup>2</sup> (maximum 15 mg), cytosine arabinoside 30 mg/m<sup>2</sup> (maximum 30 mg) and hydrocortisone 15 mg/m<sup>2</sup> (maximum 15 mg).

Maintenance therapy consisted of oral 6-mercaptopurine 50 mg/m<sup>2</sup>, weekly oral methotrexate 15 mg/m<sup>2</sup> with pulses of prednisone and vincristine



VCR, vincristine; PRED, prednisone; L-ASP, L-asparaginase; IT MTX, intrathecal methotrexate; 6-MP, 6-mercaptopurine; CYC, cyclophosphamide; HOCort, hydro + cortisone; Ara-C, cytosine arabinoside; PO, orally; XRT, radiotherapy

**Figure 15.17** Schema for (a) treatment arm 1 and (b) treatment arm 3. (\*If not M-1 marrow then V + P is continued for an additional 2 weeks; if still not in remission, the patient is off the study). Copyright © 1989 American Cancer Society (as with Figure 15.16).



every fourth month during the maintenance phase. Treatment was stopped at 3 years from date of remission. Figures 15.17a and 15.17b show the scheme of the two regimens.

For an expected 5-year actuarial disease-free survival, a sample size of 290 patients was required to detect a relative risk (RR) of below two-thirds or above 1.5 with 80% power ( $p < 0.05$  two-sided by Cox regression).

RR = Instantaneous failure rate of Group 3

Instantaneous failure rate of Group 1

Outcome measures were CNS relapse, bone marrow relapse and other extramedullary relapse (EMD).

## Outcome

Two hundred and seven eligible patients were randomized for arm 1 treatment and 223 for arm 3 treatment. Of those, 10 children were ineligible and a further 29 partially evaluable in arm 1 while 7 were ineligible and 38 children were considered partially evaluable in arm 3.

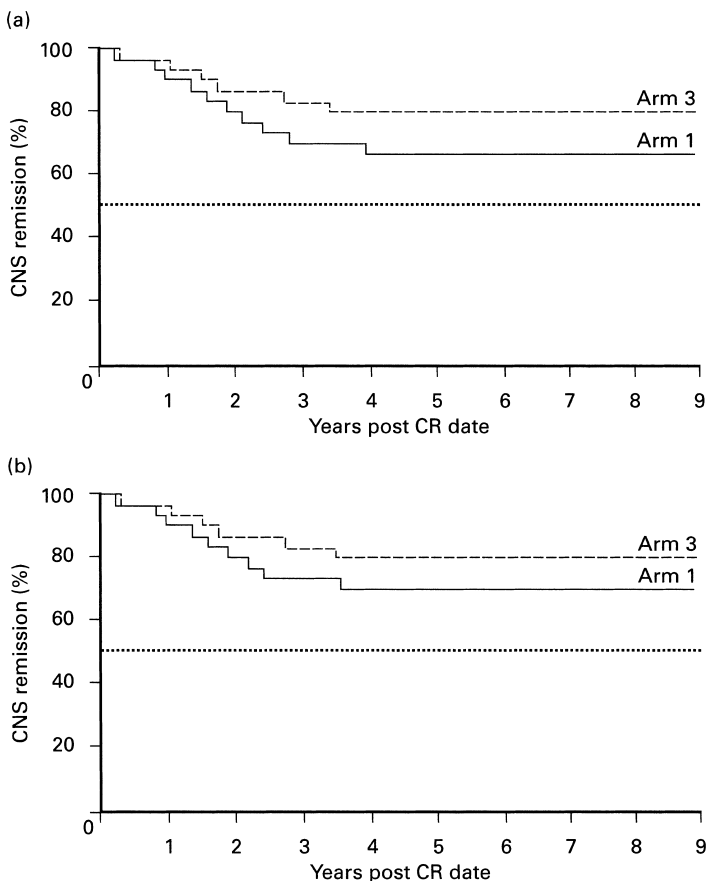
Reasons for partial evaluability were early death (arm 1 = 5, arm 3 = 3), toxicity (arm 1 = 2, arm 3 = 7), lost for follow-up (arm 1 = 10, arm 3 = 20), inadequate data (arm 1 = 6, arm 3 = 3), refusal of chemotherapy (arm 1 = 3, arm 3 = 4) and other non-specified reasons (arm 1 = 3, arm 3 = 1).

Analysis was based on all eligible patients irrespective of evaluability.

A total of 167 randomized patients treated on arm 1 ( $n = 197$ ) achieved CR against 175 ( $n = 216$ ) patients in arm 3. Complete remission rate for arm 1 was 85% versus 81% for arm 3.

There were 37 CNS relapses in arm 1 patients against 26 in arm 3 (RR 0.59; 95% CI 0.36–0.98,  $p = 0.04$ ). Triple intrathecal chemotherapy was better than cranial irradiation plus intrathecal methotrexate as prophylaxis against CNS relapse of leukemia (Figure 15.18).

There were 54 relapses at other EMD sites in arm 1 patients versus 39 in arm 3 (RR 0.60; 95% CI 0.39–0.90,



**Figure 15.18** (a) Comparison of overall duration of central nervous system remission between arm 1 and arm 3. (b) Comparison of the incidence of isolated CNS relapse between treatment 1 and arm 3. Copyright © 1989 American Cancer Society (as with Figure 15.16).

$p = 0.013$ ). This reflected a higher incidence of testicular relapses in arm 1 ( $n = 12$ ) compared to arm 3 ( $n = 5$ ) ( $p = 0.01$ ).

There were no significant differences in bone marrow relapses between the two arms ( $p = 0.13$ ).

### Toxicity

Toxicity during induction was greater in arm 3 (34/216) with one fatality than in arm 1 (6/197). The incidence

of life threatening toxicity was also greater in arm 3 patients (12/216 versus 1/197). During maintenance therapy, toxicities were similar in both arms.

### Conclusion

It was concluded that triple intrathecal chemotherapy provided adequate protection against CNS relapse of leukemia in children with high risk leukemia.

## Study 14

Zintl F, Malke H, Reimann M, Dörffel W, Domula M, Eggers G, Exadaktylos P, Kotte W, Krause I, Kunert W, Mittler U, Möbius D, Reddemann H, Weinmann G, Weissbach G. Results of acute lymphoblastic leukaemia therapy in childhood: GDR experiences 1981–1987. *Haematol Blood Transfus* 1990;33:478–82.

### Study design

The GDR Hematology and Oncology Working Group conducted this prospective multicenter randomized trial using a modified BFM (Berlin–Frankfurt–Munster) protocol. This study (ALL-VII 81) ran from September 1981 till December 1987.

### Objectives

The study compared the efficacy of moderate dose intravenous methotrexate (MDMTX) plus intrathecal methotrexate (IT MTX) against cranial irradiation (CRT) plus IT MTX in the prevention of CNS relapse of leukemia in standard risk patients.

### Details of the study

Children with previously untreated ALL (excluding B-ALL) were enrolled on the study. All patients were divided into three risk groups: standard risk (SR), medium risk (MR) and high risk (HR) according to the BFM risk criteria (see Study 17).

Chemotherapy treatment details are not been specified in the report.

SR patients were randomized to either 18 Gy CRT/IT MTX (SR-A) or MDMTX (500 mg/m<sup>2</sup>) + IT MTX (SR-B) as CNS prophylaxis. Randomization was stopped in 1986 due to high CNS failure rate in the MDMTX group. Seventy patients received an additional 18 Gy CCRT

after MDMTX (SR-C). During maintenance therapy, patients were once again randomized (after 78 weeks) either to receive MTX and 6-mercaptopurine (6-MP) for another 6 months or a late intensification protocol.

No details are given of the randomization method used.

### Outcome

Of the 524 children registered on the study, 342 (65%) were classified as SR according to the BFM risk criteria. One hundred and eighty-seven children were randomized to 18 Gy CRT + IT MTX (SR-A) and only 43 to MDMTX (SR-B). The reduced number of patients in SR-B was due to stopping randomization in 1986 and 70 children had MDMTX and 18 Gy CRT (SR-C).

Of the 524 registered patients, 503 achieved remission (96%). Among the SR group, 330 out of 342 achieved remission (96%).

CNS relapse rate is shown in Figure 15.19. Twenty-three patients in the SR group relapsed within the CNS, of whom 11 had isolated CNS relapse while the remaining 12 also had bone marrow relapse. Only 6 of 187 SR-A patients had CNS relapse (3%).

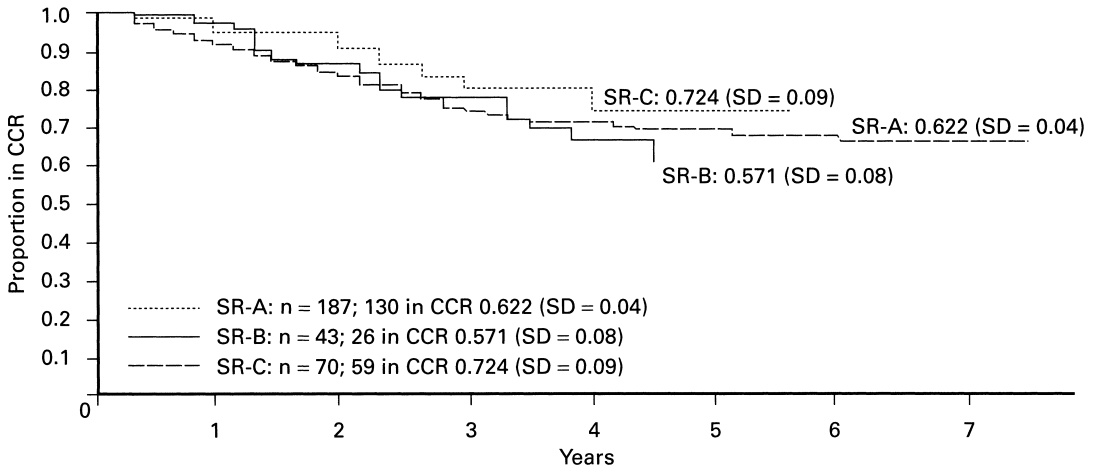
The 5-year event-free interval with regard to CNS prophylaxis regimens in the SR group was SR-A 62%, SR-B 57% and SR-C 72%.

Nine patients in the SR group developed testicular relapse. There were no testicular relapses in the MDMTX group.

No toxic effects were reported.

### Conclusion

It was concluded that moderate dose intravenous methotrexate was less effective than cranial irradiation in preventing CNS relapse of leukemia in standard risk patients.



**Figure 15.19** Probability of event-free interval for standard risk patients with different CNS prophylaxis. Reprinted from Zintl *et al.* (full reference on p. 355) with permission from Springer Science and Business Media.

## Study 15

Jones B, Freeman AI, Shuster JJ, Jacquillat C, Weil M, Pochedly C, Sinks L, Chevalier L, Maurer HM, Koch K, Falkson G, Patterson R, Seligman B, Sartorius J, Kung F, Haurani F, Stuart M, Burgert EO, Ruymann F, Sawitsky A, Forman E, Pluess H, Truman J, Hakami N, Glidewell O, Glicksman AS, Holland JF. Lower incidence of meningeal leukaemia when prednisone is replaced by dexamethasone in the treatment of acute lymphocytic leukaemia. *Med Paediatr Oncol* 1991;19:269–75.

## Study design

CALGB trial 7111 was a prospective multicenter randomized trial and enrolled patients from February 1971 to March 1974.

### Objectives

The study objectives were:

- To compare the efficacy of dexamethasone against prednisone in improving outcome in children with acute lymphocytic leukemia (ALL).
- To compare the efficacy of intrathecal methotrexate (IT MTX) alone versus cranial irradiation (CRT) plus IT MTX in the prevention of CNS relapse of leukemia in children.
- To assess the efficacy of asparaginase during induction therapy.

## Details of the study

All patients with previously untreated ALL up to the age of 20 years were eligible for entry. Lumbar punctures were not routinely performed at diagnosis nor were they were performed at the time of any hematological relapse.

Treatment details were as follows:

**Induction:** At diagnosis, all patients were randomized to receive vincristine (VCR) 2 mg/m<sup>2</sup>/week IV and either prednisone (PDN) 40 mg/m<sup>2</sup>/day or dexamethasone (DEX) 6 mg/m<sup>2</sup>/day with or without L-asparaginase (ASP) (prior to, simultaneously or subsequent to a 3-week course of VCR and steroids). Patients who did not receive ASP received 4 weeks of VCR and steroids.

**Interim maintenance:** Prior to July 1971, patients who achieved remission received two courses of methotrexate (MTX) 15 mg/m<sup>2</sup>/day IM × 5 days, with 9 days of rest between each course. After another 9 day rest they then received two courses of 6-mercaptopurine (6-MP) – 600 mg/m<sup>2</sup>/IV × 5 days with a similar period of rest between each course. From July 1971, patients were randomized either to the parenteral regimen of 6-MP and MTX or to daily oral (PO) 6-MP 90 mg/m<sup>2</sup> and weekly PO MTX 15 mg/m<sup>2</sup> with a monthly pulse of VCR and 7 day pulse of steroids.

**CNS prophylaxis:** Patients in remission were randomized to either IT MTX 12 mg/m<sup>2</sup> weekly for 3 weeks alone or with 24 Gy given in 12 fractions of cranial irradiation.

**Maintenance phase:** Three doses of IT MTX was given every 2 weeks at the beginning of maintenance therapy. Patients who were randomized to parenteral 6-MP and MTX were switched to PO 6-MP and PO MTX after 1 year of therapy. Additionally, pulses of VCR and steroids were given at 3-monthly intervals. All patients who remained in CR continued anti-leukemia treatment for 5 years, at which time they were randomized to continue treatment for a further 2 years or discontinue treatment. The treatment schema is shown in Figure 15.20.

This review focuses on the randomized arms of the CNS prophylaxis regimens alone as well as on the comparative efficacy of DEX against PDN.

No details of the randomization method used are given in the study.

Outcome measures were CNS relapse rate and complete remission duration.

## Outcome

Of 673 patients enrolled on the trial, 27 were excluded (ineligible 7, protocol violation 8, early loss 2, inadequate records 7 and non-random entry 3). Of the remaining 646, 554 (85.7%) achieved remission.

Sixty one were excluded from analysis of the CNS prophylaxis therapy (49 relapsed prior to CNS prophylaxis; 12 were disqualified during maintenance due to inadequate data). Thus 493 patients were ran-

domized for CNS therapy: 255 were randomized to IT MTX alone and 238 to CRT plus IT MTX.

Evaluation of CNS relapse revealed the following outcome. With the CNS prophylaxis regimens, CNS relapse occurred in 30 of 238 (12.6%) patients who received CRT plus IT MTX compared to 70 of the 255 (27.5%) patients who received IT MTX alone ( $p < 0.001$ ). Patients who were treated with CRT plus IT MTX also had a longer duration of complete remission ( $p = 0.037$ ).

In those given steroids (DEX versus PDN), use of DEX also decreased the incidence of CNS relapse – 33 of 231 (14.3%) patients in the DEX arm versus 67 of 262 (27.5%) patients in the PDN arm ( $p < 0.017$ ). Asparaginase had no effect on the incidence of CNS relapse.

## Conclusion

It was concluded that cranial irradiation plus intrathecal methotrexate offered greater protection against CNS relapse of leukemia compared to intrathecal methotrexate alone. Dexamethasone also offered increased protection against CNS relapse as first site of failure compared to prednisone.

## Study 16

Niemeyer CM, Reiter A, Riehm H, Donnelly M, Gelber RD, Sallan SE. Comparative results of two intensive treatment programs for childhood acute lymphoblastic leukaemia: the Berlin–Frankfurt–Munster (BFM) and Dana-Farber Cancer Institute (DFCI) protocols. *Ann Oncol* 1991;2:745–9.

## Study design

This was a comparative study of the ALL-BFM 81 and the DFCI 81–01 treatment protocols for childhood acute lymphoblastic leukemia (ALL). The BFM 81 trial ran from 1981 to 1983 in 37 centers in West Germany and Austria. The DFCI trial 81–01 was conducted in seven centers within the USA between 1981 and 1985.

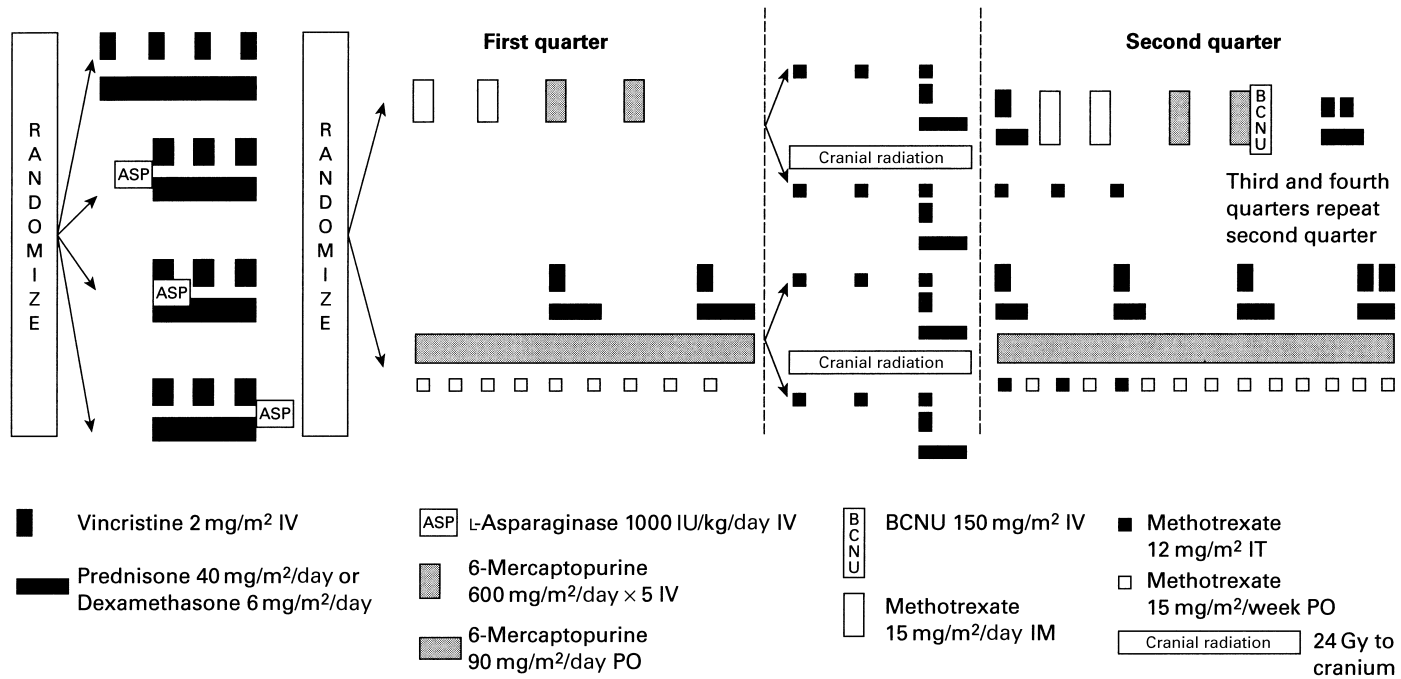
## Objectives

The study objectives were:

- The BFM 81 trial compared the efficacy of intermediate dose intravenous methotrexate (IDMTX) against cranial irradiation (CRT) in the prevention of CNS relapse of leukemia in standard risk patients.
- The studies compared the efficacy of the two CNS prophylaxis regimens.

## Details of the study

Only children and adolescents with ALL (excluding B-ALL) below 18 years of age enrolled in both the trials were included in the analysis.



**Figure 15.20** Treatment schema. The top arm is arm A (parenteral course) and the lower arm is arm B (daily oral therapy). IV, intravenous; PO, orally; IM, intramuscular; IT, intrathecal. Reprinted and adapted from Niemeyer *et al.* (full reference on p. 357) with permission from Oxford Journals.

No details of the BFM randomization method are specified in this report.

Risk criteria used to assign treatment were different in the two protocols. Standard risk (SR) patients in the DFCI group were between 2 and 9 years of age, with  $WBC < 20 \times 10^9/l$ , no CNS disease, no mediastinal mass or T cell disease. All others were categorized as high risk (HR). The BFM risk classification was based on the BFM risk factor assessment. To compare outcome, BFM patients were categorized to the same risk groups according to the DFCI criteria. Study populations in the two groups were comparable and there were equal percentages of SR and HR patients in both groups of patients.

The other main differences between the two protocols were:

- 1 All DFCI patients received CRT for CNS prophylaxis.
- 2 SR patients in the BFM protocol were randomized between IDMTX and CRT for CNS prophylaxis.
- 3 The total duration of treatment was 24 months for the DFCI patients whereas BFM children were randomized to either 18 or 24 months of treatment.

Outcome measures were CNS relapse rates in the SR BFM patients.

Outcome measures were CNS relapse rates in the SR BFM patients.

## Outcome

A total of 611 patients enrolled in the BFM study and 286 patients (three excluded as they were over 18 years

of age) in the DFCI trial were considered evaluable. In the BFM SR treatment group, 177 were randomized to IDMTX arm and 180 to the CRT arm.

Overall event-free survival at 6 years was 69% ( $\pm 2\%$ ) for BFM and 70% ( $\pm 3\%$ ) for the DFCI patients. Comparing the IDMTX and CRT arms in the BFM group, isolated CNS relapses in the IDMTX arm ( $n = 177$ ) were higher than in the CRT arm ( $n = 180$ ): 6.8% ( $n = 12$ ) versus 2.2% ( $n = 4$ ). Combined CNS relapses were similarly high in the IDMTX arm compared to the CRT arm: 7.3% ( $n = 13$ ) versus 1.7% ( $n = 3$ ).

Comparison of the incidence of CNS relapses between the BFM and DFCI groups showed there was a higher incidence of CNS relapses in the BFM group ( $n = 57, 9.5\%$ ) compared to the DFCI ( $n = 19, 6.9\%$ ) group ( $p = 0.004$ ).

No toxicity details are specified in the report.

## Conclusion

Intermediate dose methotrexate was not an adequate substitute in preventing CNS relapse of leukemia compared to cranial irradiation in patients with standard risk ALL.

## Study 17

Tubergen DG, Gilchrist GS, O'Brien RT, Coccia PF, Sather HN, Waskerwitz MJ, Denman Hammond G. Prevention of CNS disease in intermediate risk acute lymphoblastic leukemia: comparison of cranial irradiation and intrathecal methotrexate and the importance of systemic therapy: a Children's Cancer Group Report. *J Clin Oncol* 1993;11:520–6.

## Study design

This was a Children's Cancer Group Study (CCG-105) and was a prospective randomised trial that ran from May 1983 to April 1989. The trial was based on a  $2 \times 4$  factorial design in which the first factor refers to the two types of CNS prophylaxis and the second factor refers to the four systemic regimens.

In this report we will focus on the comparative merits of the two forms of CNS prophylaxis regimens alone.

## Objectives

The study objectives were:

- To compare the efficacy of 18 Gy cranial radiotherapy (CRT) + intrathecal methotrexate (IT MTX) during the first 6 months of treatment versus IT MTX alone throughout the duration of treatment as CNS prophylaxis regimens.
- To compare the efficacy of the standard CCG regimen with the BFM regimen or modified BFM regimens.

## Details of the study

Previously untreated children and adolescents with intermediate risk ALL aged between 1 and 21 years were enrolled on the CCG-105 study. Children with

lymphomatous features or with greater than 10% lymphoblasts of FAB L2 morphology were excluded. (See Table 15.10)

Randomization to one of four systemic treatment arms and to the two CNS prophylactic regimens was as shown in Figures 15.21 and 15.22. Regimen A was the most intense arm and regimen D the least. CRT 18 Gy in 10 fractions commenced on day 28 (regimens B and D) or Day 35 (regimens A and C). IT MTX was given on days 1, 14, 28, 35, 42 and 49 and every 12 weeks during maintenance for patients randomized to IT MTX. Patients randomized to regimen A or C received additional IT MTX on day 56 of the consolidation block. The duration of maintenance therapy was 3 years for boys and 2 years for girls.

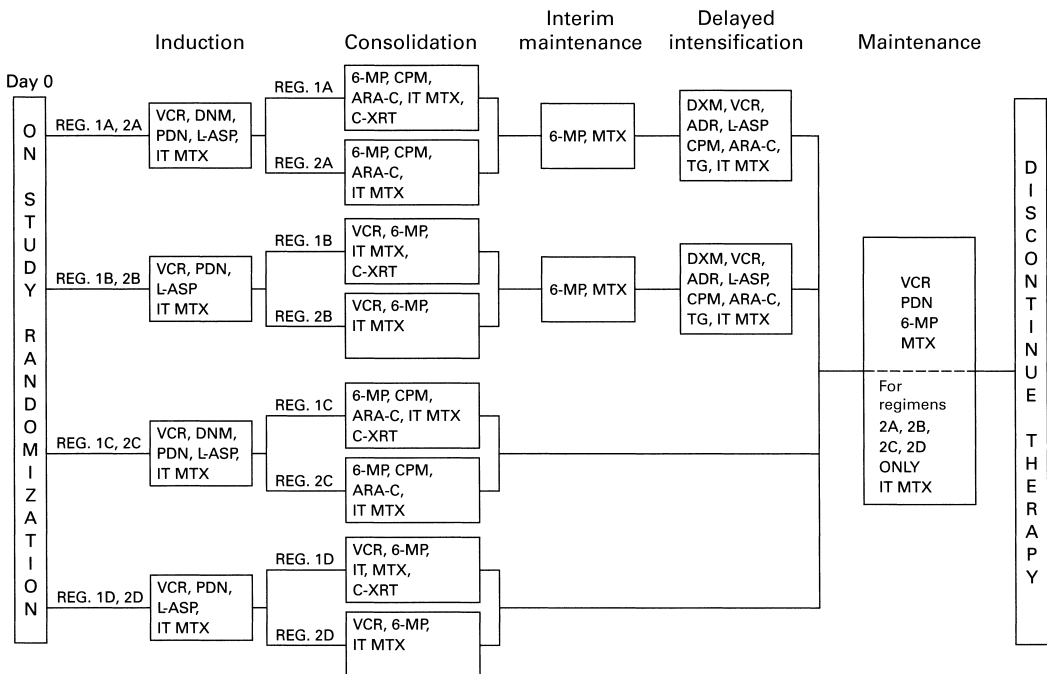
The median follow-up was 74 months after completion of induction therapy (range 4 months to 9 years). CNS randomization was stopped for children between 1 and 9 years in November 1987 as sufficient numbers had been randomized. Analysis was performed on the basis of intention to treat.

**Table 15.10** Eligibility criteria for CCG-105.

Age (Months)	WBC Count ( $\times 10^9/l$ )	FAB (% L2 Cells)	Percent of Study Population
12–23	<50	$\leq 10$	10
24–119	<10	$> 10^a$	29
24–119	10–49.9	$\leq 10$	39
120–251	<50	$\leq 10$	22

FAB: French–American–British.

<sup>a</sup>Also eligible were boys in this age and WBC count group who had <10% FAB L2 cells, but who had platelet counts of  $< 100 \times 10^9/l$ . Patients were excluded from CCG-105 if they had a lymphomatous presentation.



**Figure 15.21** Schematic diagrams of the therapy in CCG-105. The  $2 \times 4$  design tests two forms of CNS prophylaxis and four systematic regimens. VCR, vincristine; DNM, daunorubicin; PDN, prednisone; L-ASP, asparaginase; 6-MP, 6-mercaptopurine; CPM, cyclophosphamide; ARA-C, cytosine arabinoside; DXM, dexamethasone; TG, thioguanine. © American Society of Clinical Oncology (full reference on p. 359).

Outcome measures were relapse-free survival (RFS), disease-free survival (DFS) and event-free survival (EFS).

**Outcome**

The total number of patients registered on the trial was not specified, however 2.4% were considered ineligible, 1.7% were not randomized for reasons unspecified and 2% were excluded because they had CNS leukemia at diagnosis and were not randomized for CNS treatment. A total of 1388 patients were randomized to the two CNS regimens: 697 in the CRT arm and 691 in the IT MTX arm.

Seven-year survival estimates for all randomized patients were:  
 CRT arm (n = 697): CNS RFS 93%, DFS 69%; EFS 68%.

IT MTX arm (n = 691): CNS RFS 91%, DFS 67%, EFS 64%.

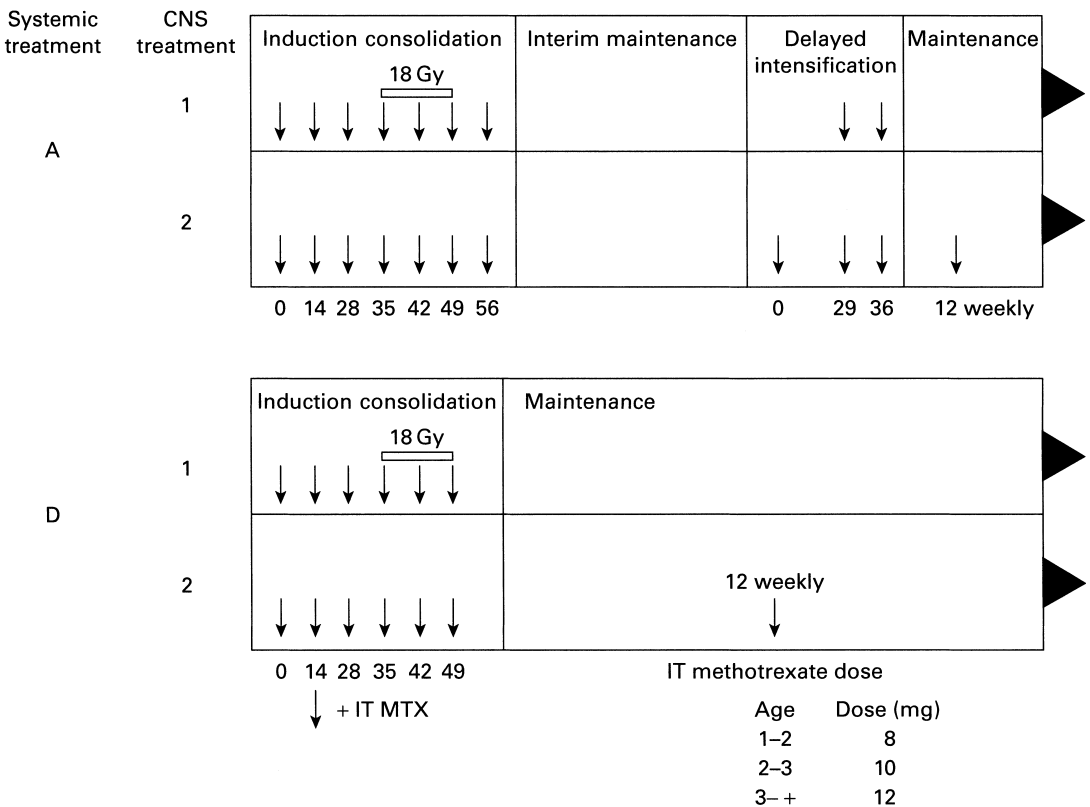
Seven-year survival by age groups was as follows:  
 CRT arm (1–9 years): CNS RFS (n = 515) 94%, DFS (n = 515) 72%, EFS (n = 526) 70%.

IT MTX (1–9 years): CNS RFS (n = 507) 91%, DFS (n = 507) 71%, EFS (n = 518) 68%.

CRT (10–21 years): CNS RFS (n = 169) 91%, DFS (n = 169) 61%, EFS (n = 171) 60%.

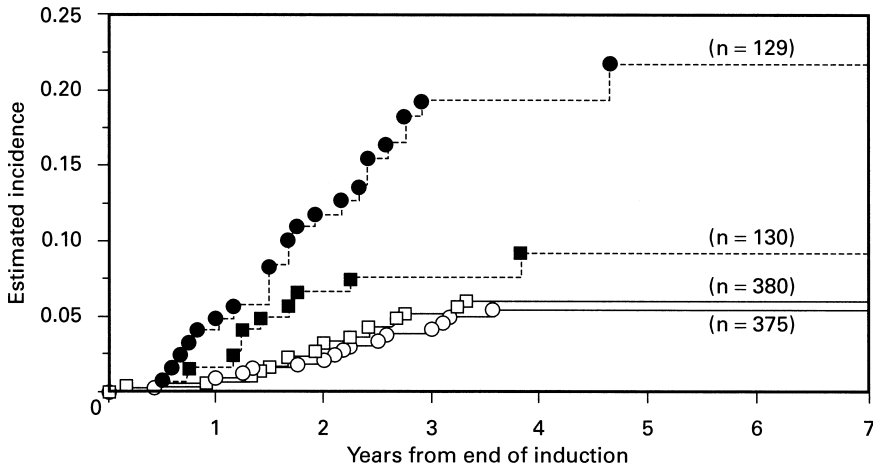
IT MTX (10–21 years): CNS RFS (n = 169) 90%, DFS (n = 169) 54%, EFS (n = 173) 53%.

There was no significant difference in outcome for the two CNS regimens when the entire population was considered. In children 10 years or older, however, the CRT treatment group had a better 7-year EFS (60% versus 53%; p = 0.04). This difference was due to



**Figure 15.22** Timing and dose of CNS therapy for the most intensive systemic arm (regimen A) and the least intensive systemic arm (regimen D). CNS treatment 1 is cranial radiotherapy; CNS treatment 2 provides IT MTX during all phases of treatment. © American Society of Clinical Oncology (full reference on p. 359).





**Figure 15.23** Cumulative incidence life-table curves for isolated CNS relapse as an initial event by type of CNS and systemic therapy. ● IT MTX plus standard chemotherapy; ■ cranial radiotherapy plus standard chemotherapy; ○ IT MTX plus intensive chemotherapy; □ cranial radiotherapy plus intensive chemotherapy. © American Society of Clinical Oncology (full reference on p. 359).

fewer bone marrow and testicular relapses in the CRT treatment group.

The CNS relapse rate was also directly related to the intensity of the systemic therapy as higher CNS relapse rates were observed in those who received standard systemic therapy in both the CNS regimens, especially so in the IT MTX arm ( $p < 0.001$ ) (Figure 15.23).

No toxicity was reported.

### Conclusions

- IT MTX alone given during the entire duration of therapy affords protection from CNS relapse equivalent to CRT plus IT MTX.
- In children aged over 10 years, CRT reduced the incidence of systemic relapse.
- CNS relapse rate was also dependent on the intensity of systemic therapy.

## Study 18

Freeman AI, Boyett JM, Glicksman AS, Brecher ML, Leventhal BG, Sinks LF, Holland JF. Intermediate-dose methotrexate versus cranial irradiation in childhood acute lymphoblastic leukaemia: a ten-year follow-up. *Med Pediat Oncol* 1997;28:98–107.

### Study design

This was a prospective randomized multicenter trial (CALGB 7611) which enrolled patients from November 1976 until July 1979.

### Objectives

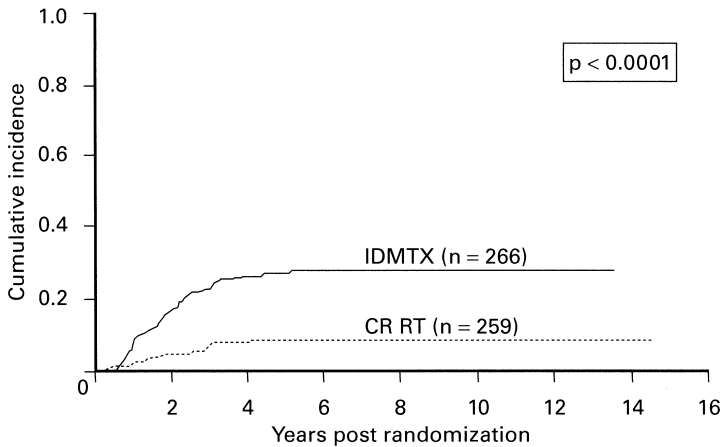
The aim of the study was to evaluate whether intermediate dose methotrexate IV could substitute cranial irradiation (CRT) as CNS prophylaxis therapy.

### Details of the study

Previously untreated children and adolescents less than 20 years of age with ALL were enrolled on the study. All patients with hepatic or renal dysfunction, CNS disease at diagnosis or hyperuricaemia were excluded from entry until these abnormalities normalized. Patients were stratified as standard or high risk according to age and diagnostic white cell count. Standard risk (SR) children were between 2 and 8 years of age and had a diagnostic white cell count of  $<30 \times 10^9/l$ . All others were categorized as high risk (HR).

A sample size of 300 patients was chosen to provide 95% power ( $\alpha = 0.05$ ) to detect a 15% difference in the relapse rates of the observation and end intensification arms.

Remission induction therapy was identical for all and consisted of IV vincristine  $2 \text{ mg/m}^2/\text{dose/week}$  (VCR)  $\times 4$  weeks (maximum dose  $2 \text{ mg}$ ) oral



**Figure 15.24** Cumulative incidence functions of CNS relapse as a first event for the IDMTX and CR RT arms. Reprinted from Freeman *et al.* (full reference p. 362) with permission of Wiley-Liss, Inc., a subsidiary of John Wiley & Sons, Inc.

prednisone 40 mg/m<sup>2</sup>/day × 4 weeks (PDN), IV asparaginase 1000 IU/kg/day × 10 doses (ASP) and intrathecal methotrexate (IT MTX) 12 mg/m<sup>2</sup>/dose × 3 doses (maximum dose 15 mg). All patients who did not achieve remission within 4 weeks (<5% blasts) had treatment continued for a further 2 weeks (VCR, PDN and ASP). Patients not in remission at 6 weeks were taken off the trial.

Complete responders were randomized for CNS prophylaxis to either cranial irradiation (CR RT) plus IT MTX or intermediate dose intravenous methotrexate (IDMTX) plus IT MTX. The dose of IDMTX was 500 mg/m<sup>2</sup>/dose at 3-weekly intervals × 3. A third was given as IV bolus and the remaining two-thirds was given as 24-hour intravenous infusion. IT MTX was given concurrently with IDMTX on all three occasions. Folinic acid was given 24 hours after completion of IDMTX (single dose of 1–2 mg/m<sup>2</sup>; maximum dose 15 mg).

CR RT was given as 24Gy in 12 fractions over a period of 16 days with concurrent administration of 3 doses of IT MTX (12 mg/m<sup>2</sup>). All patients also had reinforcement with VCR and PDN at weeks 6, 12, 16, 20 and 24 after commencement of CNS prophylaxis.

Maintenance therapy consisted of oral mercaptopurine (90 mg/m<sup>2</sup>/day) plus oral methotrexate (15 mg/m<sup>2</sup>/week). Two-weekly doses of vincristine and 2 weeks of oral prednisolone were also given (from week 28) every 12 weeks for the duration of maintenance

treatment. At the end of 3 years of maintenance therapy, patients were randomized to stop treatment or receive a late intensification similar to the initial induction plus three doses of IT MTX.

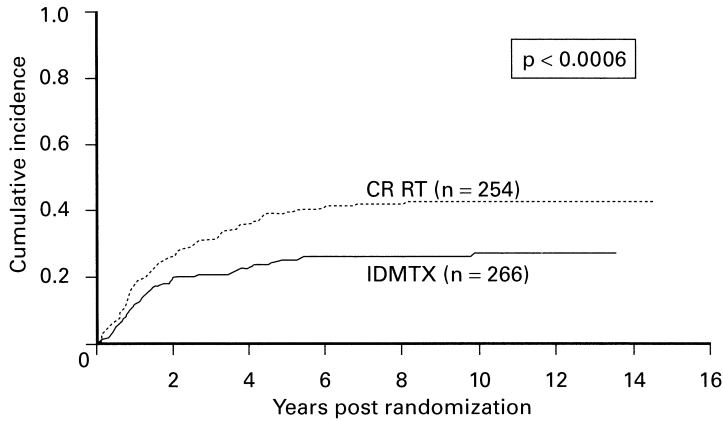
Outcome measures were continuous clinical remission, CNS relapse rates, bone marrow relapse rates and survival. Median follow-up of patients at risk for failure was 8 years.

## Outcome

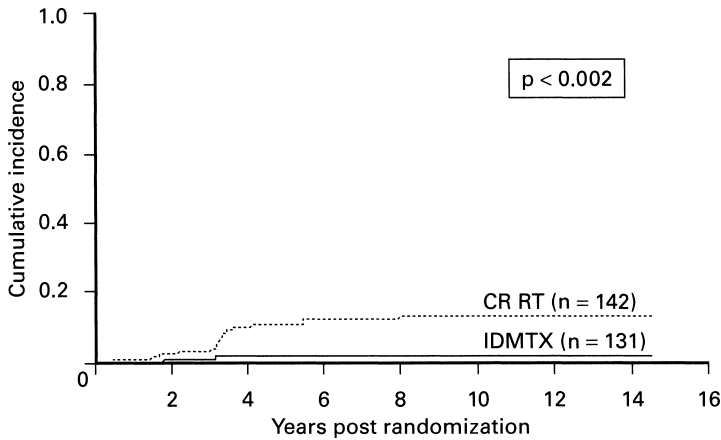
Of the 634 patients enrolled on the trial, only 596 were evaluable for response to induction therapy. Of the 546 patients who achieved remission, only 525 patients were randomized to either CR RT (259) or IDMTX (266). (Eleven patients were never randomized, 6 were lost before CNS prophylaxis, two patients refused randomization and two patients had inadequate records.) Patient characteristics in both arms were similar except that twice as many children were under 2 years old in the IDMTX arm. All analyses were performed on the basis of intention to treat.

Patients in the CR RT arm had a lower incidence of CNS relapse compared to the IDMTX arm ( $p < 0.0001$ ). The 12-year CNS relapse rate for the IDMTX and CR RT arms were  $28 \pm 3\%$  and  $8 \pm 2\%$  respectively (Figure 15.24). There were no differences in CNS relapse rates between the sexes ( $p > 0.2$ ).

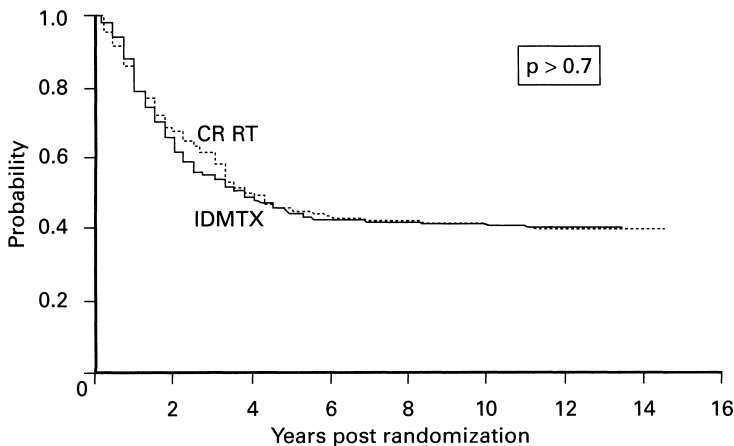
IDMTX regimen afforded greater protection against marrow relapse compared to CR RT ( $p < 0.0006$ ). This was most evident in the SR



**Figure 15.25** Cumulative incidence functions of hematologic relapse as a first event in the IDMTX and CR RT arms. Reprinted from Freeman *et al.* (full reference p. 362) with permission of Wiley-Liss, Inc., a subsidiary of John Wiley & Sons, Inc.



**Figure 15.26** Cumulative incidence functions of testicular relapse as a first event in male children with ALL treated with the IDMTX and CR RT arms. Reprinted from Freeman *et al.* (full reference p. 362) with permission of Wiley-Liss, Inc., a subsidiary of John Wiley & Sons, Inc.



**Figure 15.27** Duration of continuous clinical remission in the IDMTX and CR RT arms. Reprinted from Freeman *et al.* (full reference p. 362) with permission of Wiley-Liss, Inc., a subsidiary of John Wiley & Sons, Inc.

patients. The 12-year incidence rates were  $27 \pm 3\%$  and  $43 \pm 3\%$  for the IDMTX and CR RT arms respectively (Figure 15.25).

Boys randomized to IDMTX had a lower incidence of testicular relapse ( $p = 0.002$ ) (Figure 15.26).

There were no differences in survival after relapse in both treatment arms. The 12-year continuous clinical remission rates for the IDMTX and CR RT arms were  $40 \pm 5.4\%$  and  $40 \pm 5.9\%$  respectively ( $p > 0.7$ ) (Figure 15.27).

## Toxicity

No significant toxicity was reported. Two patients developed second malignancy after salvage treatment. Survivors who received CR RT had a lower IQ and also performed poorly on the wide range achievement test.

## Conclusion

It was concluded that IDMTX offered superior protection against testicular relapse and bone marrow relapse but offered less protection against CNS relapses than cranial irradiation.

## Study 19

Steinherz PG, Ganyon PS, Breneman JC, Cherlow JM, Grossman NJ, Kersey JH, Johnstone HS, Sather HN, Trigg ME, Uckun FM, Bleyer WA. Treatment of patients with acute lymphoblastic leukaemia with bulky extramedullary disease and T-cell phenotype or other poor prognostic features. *Cancer* 1998;**82**:600–12.

## Study design

Trial CCG-123 was a randomized prospective multicenter trial of the Children's Cancer Group that commenced in April 1983 and closed to patient recruitment in April 1989.

## Objectives

The primary objective of this randomized trial was to evaluate the effectiveness of three different chemotherapy regimens so as to improve the event-free survival in children with high risk acute lymphoblastic leukemia. The secondary objective was to evaluate the need for cranial radiotherapy as CNS prophylaxis in the treatment of high risk ALL. This review examines the latter objective alone.

## Details of the study

All patients entered into the study were between 1 and 20 years of age and had at least one site of bulky disease (mediastinal mass >33% of transthoracic diameter, splenomegaly or lymphadenopathy >3 cm) and either also had T cell disease and/or WBC > 50 × 10<sup>9</sup>/l or Hb > 10 g/dl. All aged less than 1 year of age and those with FAB L3 leukemia were excluded from the study.

The study was conducted in two periods, each involving randomization among three regimens: (1) randomization to regimens A, B or C until regimen C was dropped from the study (disproportionately high CNS recurrences in patients on regimen C) in October

1985 and a later period of randomization (December 1985) to regimens A, B and D (regimen B was closed to patient entry before closure of trial in April 1987). Details of randomization are not specified in the report.

Children with CNS disease at diagnosis were not eligible for regimen C treatment.

Regimen A: (CCG modified Berlin–Frankfurt–Munster regimen) consisted of five phases of treatment and included: (1) induction; (2) consolidation including 18 Gy cranial irradiation plus intrathecal methotrexate; (3) interim maintenance; (4) re-induction/re-intensification and (5) the maintenance phase. No irradiation was given to sites of bulky disease.

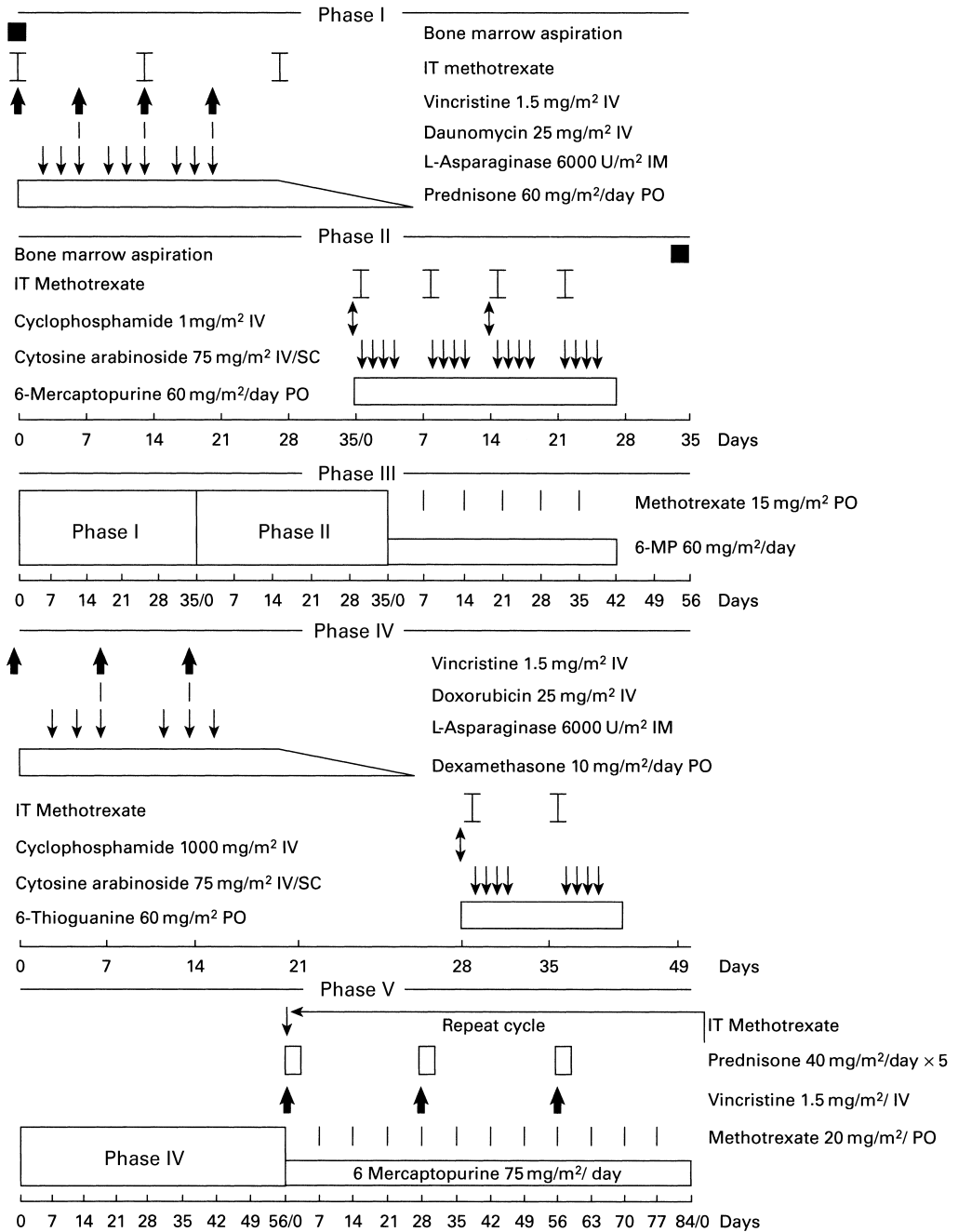
Regimen B: (LSA2-L2 with cranial irradiation) consisted of intensive induction with irradiation (15 Gy) to sites of bulky disease and also 18 Gy cranial irradiation plus IT MTX as CNS prophylaxis at the end of induction therapy.

Regimen C: (LSA2-L2 without cranial irradiation) was similar to regimen B except that no cranial irradiation was given for CNS prophylaxis.

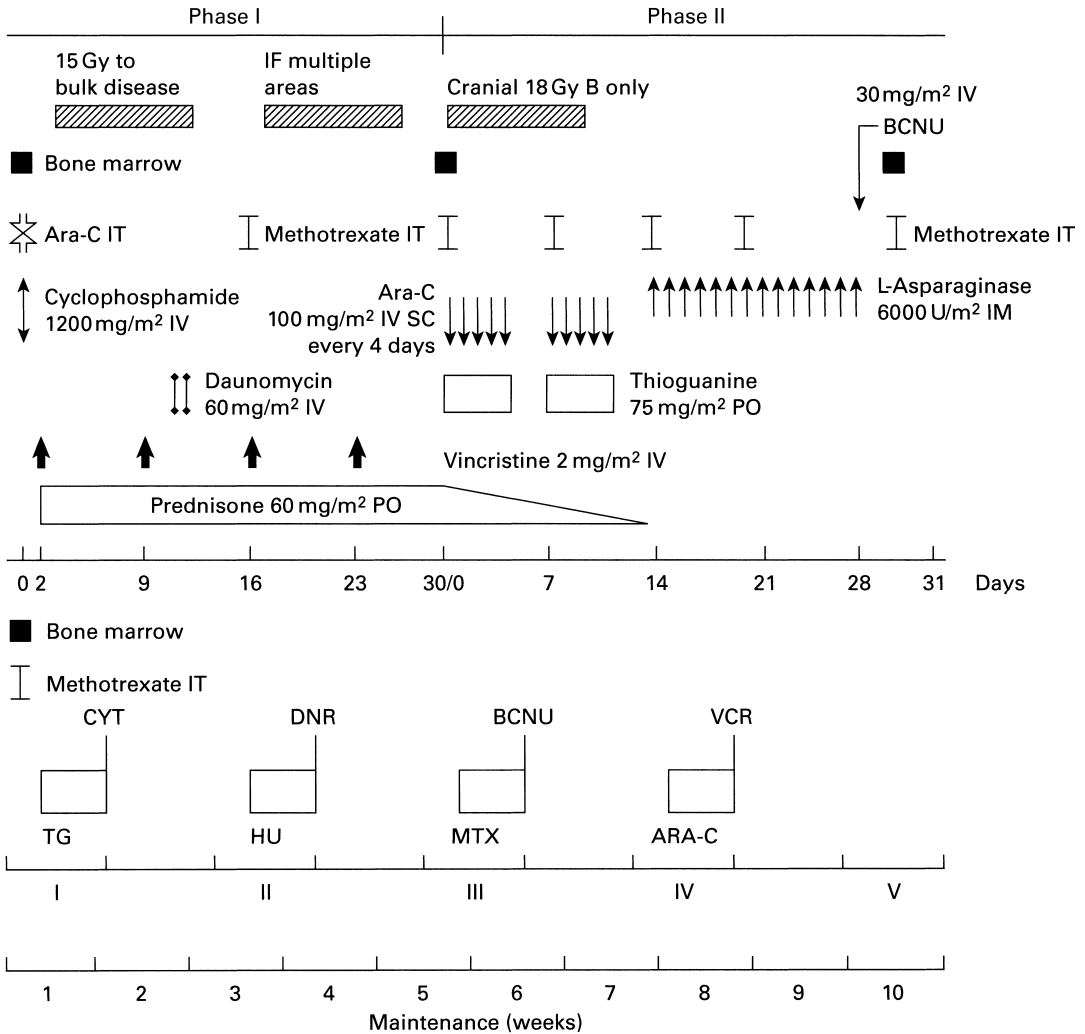
Regimen D: (the New York regimen) was based on a five drug induction therapy combined with 15 Gy irradiation to bulky extra-abdominal sites, and 18 Gy cranial irradiation plus IT MTX was given during the consolidation phase of therapy. IT MTX was given on the first day of each new maintenance cycle during the maintenance phase of treatment (Figures 15.28–15.30).

Outcome measures were event-free survival (EFS), overall survival (OS) and relapse-free survival (RFS).

All analyses were based on intention to treat. Seven hundred and eight patients were entered into the trial, of whom only 694 were considered eligible for analysis. Of the 694 eligible patients, 678 (16 refused randomization) were randomized to one of the four chemotherapy regimens. From April 1983 to October 1985, 260 patients were randomized – 88 to regimen A, 89 to regimen B, 83 to regimen C. Final randomization tally when the study closed was regimen A 261, B 163, C 84, D 170. The patient characteristics of the four



**Figure 15.28** Overview of regimen A: CCG modified BFM 76/79. The dose of IT MTX is not given. IV: intravenously; IM: intramuscularly; PO: orally; SC: subcutaneously.

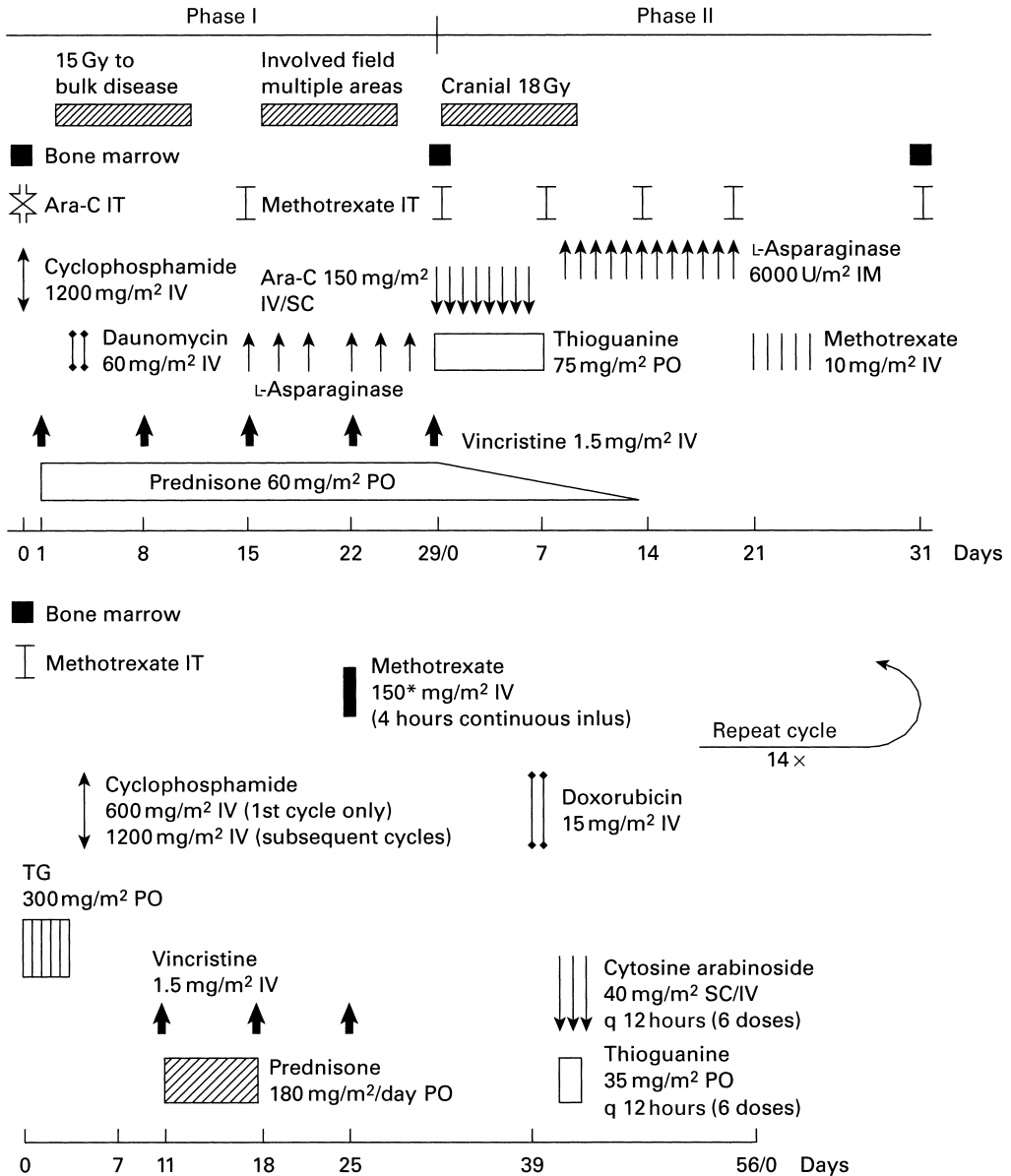


IT, intrathecal; SC, subcutaneously; IM, intramuscularly; PO, orally  
 BCNU, carmustine 30 mg/m<sup>2</sup> IV  
 ARA-C, cytosine arabinoside 150 mg/m<sup>2</sup>/day every 4 days  
 CYT, cyclophosphamide 600 mg/m<sup>2</sup> IV  
 DNR, daunorubicin 30 mg/m<sup>2</sup> IV  
 VCR, vincristine 2.0 mg/m<sup>2</sup> IV  
 TG, thioguanine 300 mg/m<sup>2</sup>/day orally every 4 days  
 HU, hydroxyurea 2400 mg/m<sup>2</sup>/day orally every 4 days  
 MTX, methotrexate 10 mg/m<sup>2</sup>/day orally every 4 days  
 (Dose of IT MTX and IT ARA-C not given)

**Figure 15.29** Overview of regimens B and C: the Children’s Cancer Group modified LSA2-L2 Protocol.

regimen groups were similar. T cell phenotype comprised 65% of the total patients, 20% had WBC count >200 × 10<sup>9</sup>/l and 59% had Hb >10 g/dl at diagnosis. There was non-compliance in 5 of 678, who switched

to another treatment arm in the study (2 in regimen B2 and 1 each in regimens A, C and D). Outcome measures were bone marrow relapse rate, EFS, CNS RFS and OS.

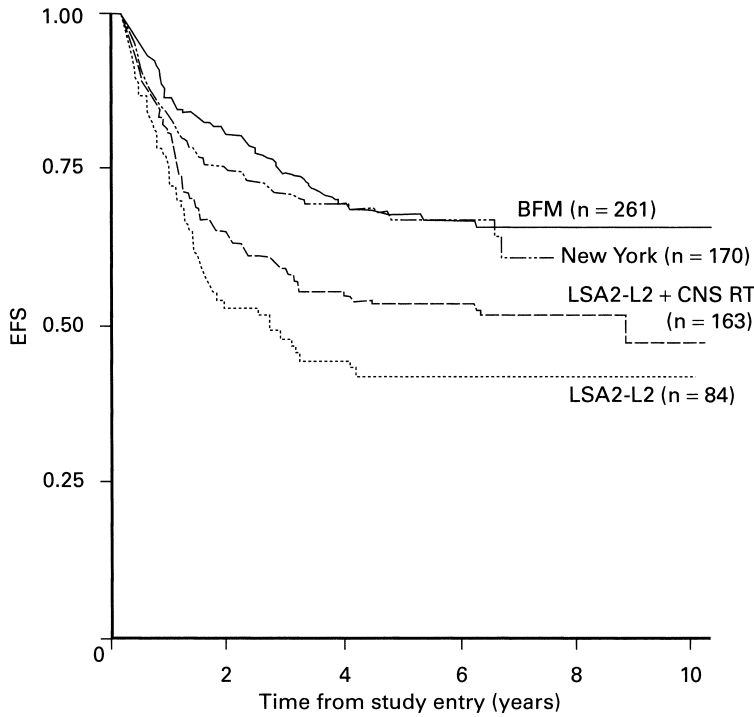


**Figure 15.30** Overview of regimen D: the New York protocol. The lower half of the figure depicts the repeating 56 day maintenance cycles. Doxorubicin (Adriamycin) was discontinued after the first 10 maintenance cycles for a maximum total anthracycline dose of 300 mg/m<sup>2</sup> of doxorubicin and 120 mg/m<sup>2</sup> of daunomycin. The dose of IT MTX and IT ARA-C is not given

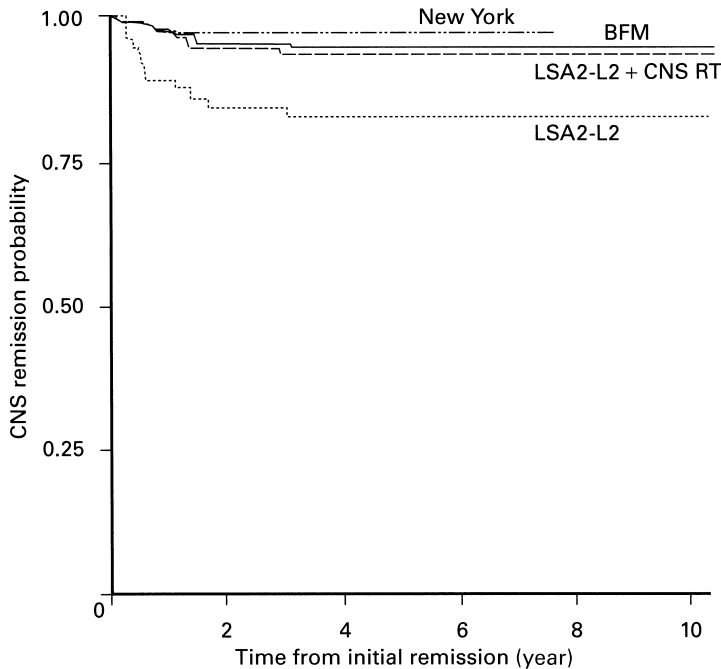
**Outcome**

EFS at 6 years from diagnosis for the entire cohort was 60 ± 4% and OS was 67 ± 4%. EFS was similar for both the modified BFM (A) and New York regimens (D) (67 ± 6% and 67 ± 7% respectively, and was significantly better than either of the two LSA2-L2 regimens (B 53 ± 8% and C 42 ± 0%).

Comparing regimens B and C only, the difference in EFS was small (p = 0.34, Figure 15.31). The 6-year CNS RFS was 94% for regimen B patients compared to 84% for regimen C patients (p = 0.02, Figure 15.32).



**Figure 15.31** EFS of each treatment regimen. A, Berlin–Frankfurt–Munster; B, LSA2-L2 with cranial RT; C, LSA2-L2 without cranial RT; D, New York. p values: A versus B, 0.004; A versus C, 0.0001; A versus D, 0.97; B versus C, 0.34; B versus D, 0.01; D versus C, 0.001.



**Figure 15.32** Freedom from isolated CNS recurrence on the four therapeutic regimens. CNS control on the three regimens containing 18 Gy cranial irradiation was significantly better than on LSA2-L2 without cranial irradiation. p values: A versus B, 0.69; A versus C, 0.0007; A versus D, 0.3; B versus C, 0.01; B versus D, 0.2; and D versus C, 0.0002.



Bone marrow relapse rate for regimen B patients was  $32 \pm 8\%$  versus  $39 \pm 12\%$  for regimen C patients at 6 years from diagnosis. OS for regimen B patients was  $59 \pm 8\%$  compared to  $53 \pm 11\%$  for regimen C patients.

### Toxicity

Toxicity was similar in all four regimens. No significant difference in toxicity was observed between regimens B and C.

### Acknowledgments

Figures 15.28–15.32 are Copyright © 1998 American Cancer Society. Adapted and reprinted from Steinherz

PG. *et al* (full reference on p. 365) by permission of Wiley-Liss, Inc., a subsidiary of John Wiley & Sons, Inc.

### Conclusions

It was concluded that LSA2-L2 chemotherapy with cranial irradiation as CNS prophylaxis resulted in lower CNS relapse rates compared to the same regimen without cranial radiotherapy. However, this did not translate into better OS.

## Study 20

Nachman J, Sather HN, Cherlow JM, Sensel MG, Gaynon PS, Lukens JN, Wolff L, Trigg ME. Response of children with high risk acute lymphoblastic leukaemia treated with and without cranial irradiation: A report of the Children's Cancer Study Group. *J Clin Oncol* 1998;16:920–30.

### Study design

This Children's Cancer Group Study (CCG-1882) was a prospective randomized multicenter study which ran from May 1989 to June 1995.

### Objectives

The study aimed to determine whether cranial irradiation could be omitted for presymptomatic CNS therapy in a select subgroup of children with high risk acute lymphoblastic leukemia without compromising survival.

### Details of the study

Eligible patients were:

- 1 Aged 1–9 years and WBC  $50 \times 10^9/l$  or aged 10 years.
- 2 Patients who achieved rapid early response (RER), i.e.  $<25\%$  blasts in bone marrow on day 7 and bone marrow remission by day 28.

Patients with lymphomatous features or CNS disease at diagnosis were excluded.

Results were monitored at 6 monthly intervals after patients reached 18 months of follow-up and continued for a maximum of 10 analyses. At the fifth interim analysis in July 1993, as the outcome difference favored regimen A, randomization was discontinued and the study committee recommended that all patients (except those less than 10 years of age and with a WBC count  $<100 \times 10^9/l$ ) who were 6 months or less on the study be recalled for cranial irradiation as for regimen A.

Details of the methodology of randomization are not specified.

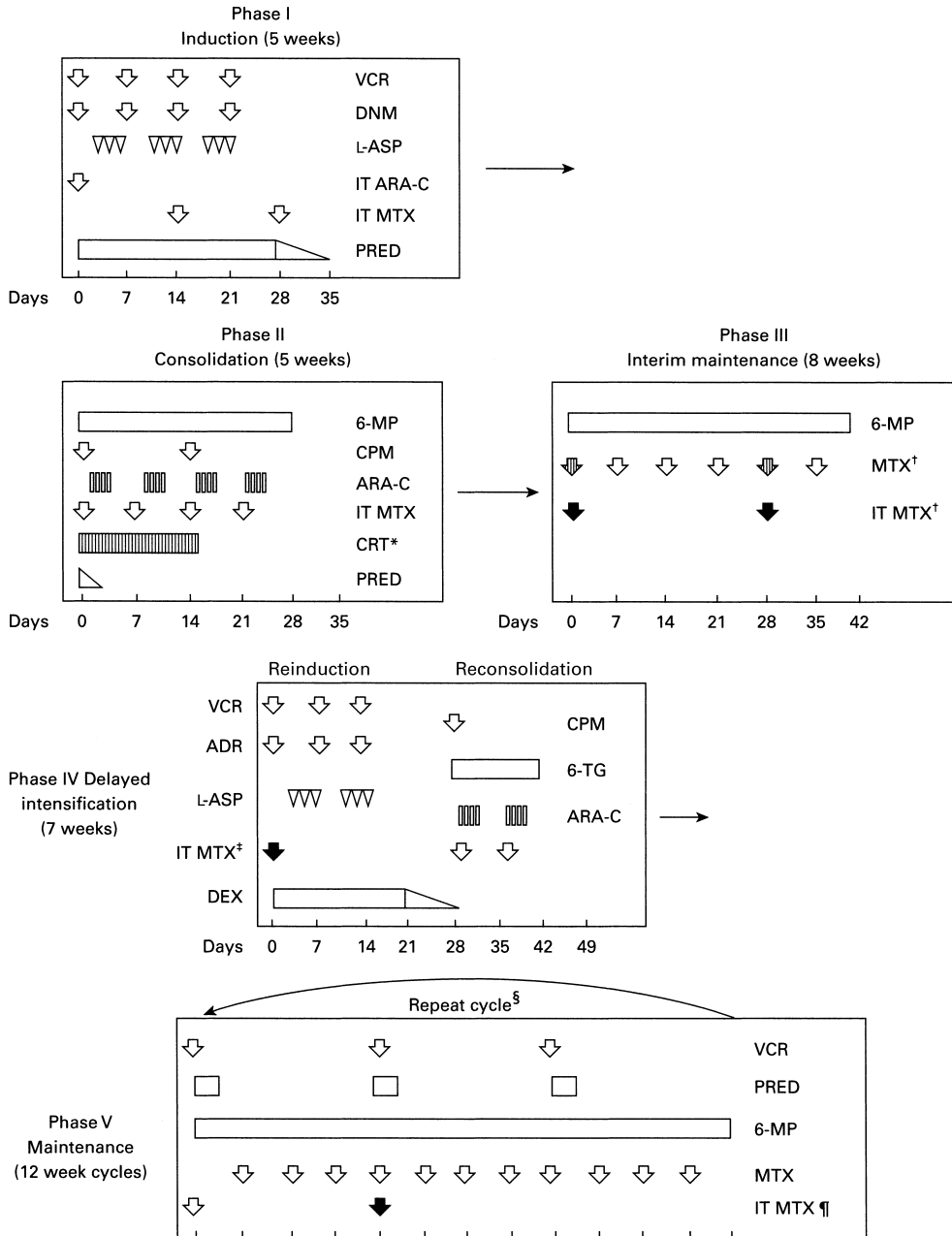
Randomization for presymptomatic CNS therapy was at the end of induction therapy.

Treatment consisted of five phases (Figure 15.33): induction (5 weeks), consolidation (5 weeks), interim maintenance (8 weeks), delayed intensification (7 weeks) and maintenance (multiple 12 week courses). Maintenance therapy cycles continued for 2 and 3 calendar years for girls and boys respectively.

Induction therapy consisted of vincristine (VCR)  $1.5 \text{ mg/m}^2$  IV, prednisone (PRED)  $60 \text{ mg/m}^2$  orally, daunomycin (DNM)  $25 \text{ mg/m}^2$  IV and L-asparaginase (ASP)  $6000 \text{ U/m}^2$  IM. Intrathecal cytosine arabinoside (IT ARA-C) was administered on day 0 and IT methotrexate (MTX) on days 14 and 28.

Consolidation consisted of cyclophosphamide  $1000 \text{ mg/m}^2$  (CPM), 6-mercaptopurine  $60 \text{ mg/m}^2$  (6-MP) and ARA-C  $75 \text{ mg/m}^2$  IV/SC. All patients also had weekly doses of IT MTX  $\times 4$  while regimen A patients also received 18 Gy CRT in 10 fractions.

Presymptomatic CNS therapy consisted of IT MTX given during induction and consolidation, delayed



**Figure 15.33** Schematic diagram of therapy for CCG 1882. White, both regimens; stripes, regimen A; black, regimen B. \*Regimen A only. †Regimen B, IT MTX on days 0 and 28. ‡Regimen B, IT MTX on day 0. §Cycles continued for 2 years (girls) or 3 years (boys). ¶Regimen B, IT MTX on days 0 and 28, courses 1–4. © American Society of Clinical Oncology (full reference on p. 370).

**Table 15.11** Presymptomatic treatment for prevention of CNS disease according to regimen.

Phase	Regimen A (CRT+)	Regimen B (CRT <sup>-</sup> )
Induction	IT ARA-C × 1 IT MTX × 2	IT ARA-C × 1 IT MTX × 2
Consolidation	IT MTX × 4 CRT 1.8 Gy × 10	IT MTX × 4
Interim maintenance	None	IT MTX × 2
Delayed intensification		
Re-induction	None	IT MTX × 1
Re-consolidation	IT MTX × 2	IT MTX × 2
Maintenance		
Courses 1–4	IT MTX × 1	IT MTX × 2
Courses 5–end	IT MTX × 1	IT MTX × 1

intensification and maintenance with 18 Gy CRT during consolidation (regimen A), or regimen A IT MTX (without CRT) plus additional doses of IT MTX given during interim maintenance, delayed intensification and the first four cycles of maintenance therapy (regimen B) (Table 15.11).

Interim maintenance therapy consisted of oral 6-MP 60 mg/m<sup>2</sup> (daily) and MTX 15 mg/m<sup>2</sup> (weekly) for regimen A patients, while regimen B patients also had two additional doses of IT MTX.

Delayed intensification therapy consisted of dexamethasone 10 mg/m<sup>2</sup> orally (DEX), VCR 1.5 mg/m<sup>2</sup> IV, doxorubicin 25 mg/m<sup>2</sup> IV (ADR), L-ASP 6000 U/m<sup>2</sup> IM, CPM 1000 mg/m<sup>2</sup> IV, 6-thioguanine 60 mg/m<sup>2</sup> (6-TG) and ARA-C 75 mg/m<sup>2</sup> IV/SC. Regimen A patients received two doses of IT MTX while regimen B patients had three doses of IT MTX (three doses).

Maintenance therapy was with monthly pulses of VCR and PRED with weekly oral MTX and daily 6-MP with IT MTX given on the first day of each 12-week cycle (regimen A).

Patients on regimen B received the same regimen of oral MTX except that IT MTX was substituted for oral MTX on day 28 of courses 1 to 4. Regimen B patients also received IT MTX on day 0 of each cycle.

Intrathecal chemotherapy doses were age adjusted: ARA-C 30 mg, 50 mg, 70 mg and MTX 8 mg, 10 mg, 12 mg for ages 1, 2 and 3 years or greater respectively.

Outcome measures were CNS relapse rate, and event-free survival (EFS).

## Outcome

The number of patients entered on the trial was 1021. There were 702 RER patients (day 7 marrow), of whom 5 patients died before day 28 and 1 had M3 marrow on day 28 while 29 had CNS disease at diagnosis and were non-randomly assigned to CRT. This left 667 RER patients eligible for randomization. Thirty-one patients were not randomized (no reasons are given), leaving a total number randomized of 636. Three hundred and seventeen were randomized to regimen A and 319 to regimen B.

At the time of the fifth interim analysis in July 1993, the number of events were as follows: regimen A 28, regimen B 48, relative hazard rate (RHR) = 1.85 for B compared with A,  $p = 0.004$ . Three-year EFS was  $82.1 \pm 4.0\%$  for regimen A and  $70.4 \pm 4.2\%$  for regimen B.

At the time of the tenth analysis in January 1996, the number of events were as follows: regimen A 76, regimen B 72; RHR = 0.5 for B compared with A (where follow-up was >2 years) (Table 15.12).

Five-year EFS was  $69.1 \pm 3.4\%$  and  $75.0 \pm 2.7\%$  for regimens A and B respectively ( $p = 0.5$ ) (Figure 15.34).

The most frequent event in either group was bone marrow relapse – 57 (54 isolated) in regimen A and 43 (41 isolated) in regimen B. CNS relapses were more frequent in regimen B, 11 (isolated 10) compared to 8 in regimen A (isolated 5). The temporal sequence of the events differed in both groups of patients. During the first 2 years of follow-up the number of bone marrow relapses for patients on both regimens A and B were similar (31 versus 33) but between 2 and 6 years of follow-up regimen A patients had more bone marrow relapses (26 versus 10). Eight of the 10 CNS relapses in regimen B patients occurred within the first 2 years of follow-up.

Analysis on intent to treat showed that by 5 years of follow-up probability of isolated CNS relapse was  $2.3 \pm 1.1\%$  and  $3.6 \pm 1.1\%$  ( $p = 0.72$ ) for regimens A and B respectively (Figure 15.35).

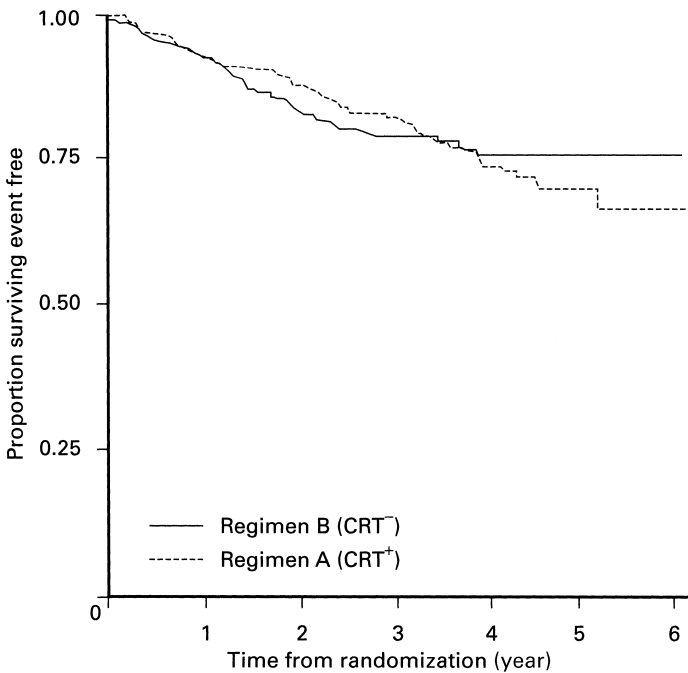
By intention to treat analysis, survival after isolated CNS relapse was better in patients on regimen B ( $p = 0.009$ ). All 10 patients who had an isolated CNS relapse on regimen B were alive compared to only two out of five patients on regimen A.

**Table 15.12** Trends in occurrence of events during late follow-up.

Analysis Period	Number of Events		RHR <sup>a</sup>	
	Regimen A (CRT <sup>+</sup> )	Regimen B (CRT <sup>-</sup> )	≤2 Years Follow-up	>2 Years Follow-up
January 1994	33	54	1.97	0.86
September 1994	47	57	1.54	0.53
January 1995	62	62	1.41	0.47
September 1995	68	66	1.44	0.41
January 1996 <sup>b</sup>	76	72	1.38	0.50

<sup>a</sup>RHR for regimen B versus regimen A for patients in follow-up ≤2 years or >2 years.

<sup>b</sup>Kaplan–Meier estimates at 5 years of follow-up were 69.1% and 75.0% for regimens A and B, respectively (p = 0.50, using a two-sided test).



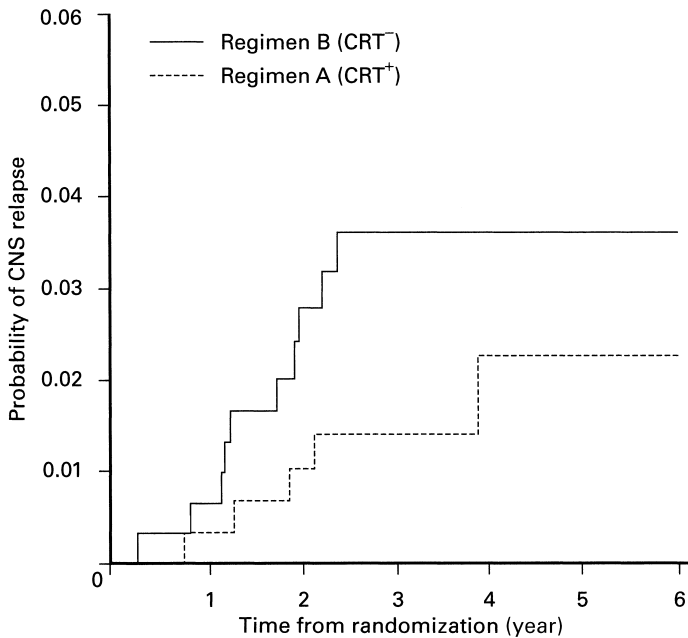
**Figure 15.34** EFS of children with high risk ALL treated with regimens A and B for presymptomatic treatment of the CNS. © American Society of Clinical Oncology (full reference on p. 370).

**Toxicity**

There were 18 seizures during post induction therapy – 7 in regimen A and 11 in regimen B. Two patients treated on each regimen developed leukoencephalopathy. There were 23 deaths in remission – 9 in regimen A and 14 in regimen B.

**Conclusion**

It was concluded that (1) Presymptomatic CNS therapy with intensified IT MTX is a satisfactory form of CNS prophylaxis in children with high risk acute lymphoblastic leukemia if they have a rapid early response to induction chemotherapy. (2) Intensified IT MTX afforded protection against late bone marrow relapse.



**Figure 15.35** Probability of isolated CNS relapse in children with high risk ALL treated with regimens A and B for presymptomatic treatment of the CNS. © American Society of Clinical Oncology (full reference on p. 370).

## Study 21

Vilmer E, Suciu S, Ferster A, Bertrand Y, Cave H, Thyss A, Benoit Y, Dastugue N, Fournier M, Souillet G, Manel AM, Robert A, Nelken B, Millot F, Lutz P, Rialland X, Mechinaud F, Boutard P, Behar C, Chantraine JM, Plouvier E, Laureys G, Brock P, Uyttebroeck A, Margueritte G, Plantaz D, Norton L, Francotte N, Gyselinck J, Waterkeyn C, Solbu G, Philippe N, Otten J. Long term results of three randomized trials (58831, 58832, 58881) in childhood acute lymphoblastic leukaemia: a CLCG-EORTC report. *Leukaemia* 2000;14:2257–66.

### Study design

Trial 58832 was a prospective randomized trial carried out from 1983 to 1989.

### Objectives

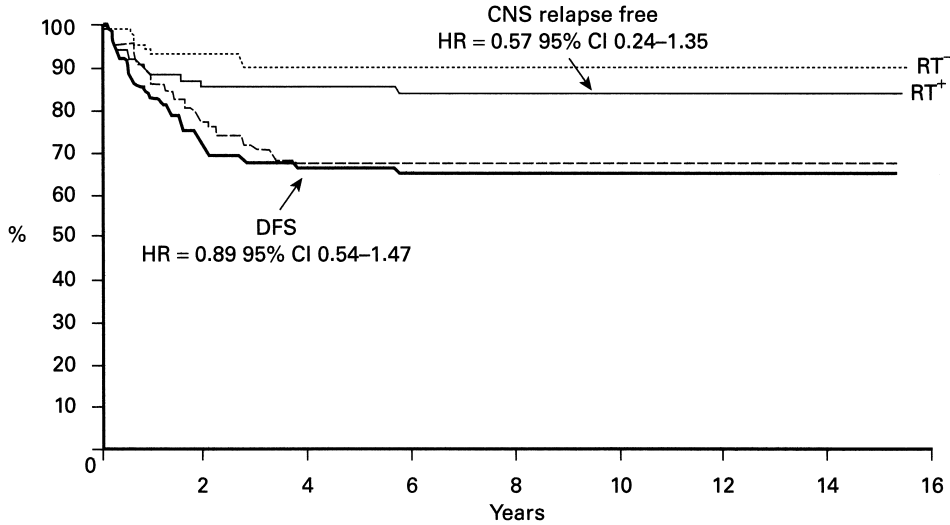
The aim of the trial was to determine whether omission of cranial irradiation in children with medium or high risk acute lymphoblastic leukemia treated with high dose intravenous methotrexate plus intrathecal methotrexate adversely influenced CNS relapse rate or treatment outcome.

### Details of the study

Only medium and high risk patients below 18 years of age were eligible to be registered on this study. Patients with CNS disease at diagnosis were not eligible for the trial. Risk factor (RF) calculation was according to the BFM (Berlin–Frankfurt–Munster) criteria based on three initial factors: circulating peripheral blasts, size of liver and spleen.  $RF = 0.2 \times \log_{10}(\text{blasts}/\text{mm}^3 + 1)$ ,  $+0.06 \times \text{cm hepatomegaly} + 0.04 \times \text{splenomegaly}$ . Standard risk patients had a RF score  $<1.2$ , in medium risk patients it was between 1.2 and 1.69, and high risk patients had a score  $\geq 1.7$ .

No details of randomization method are given in the study.

Treatment commenced with a pre-phase of 7 days of prednisone/prednisolone and one dose of intrathecal methotrexate (IT MTX), followed by induction therapy that consisted of vincristine (VCR)  $1.5 \text{ mg}/\text{m}^2/\text{week} \times 4$ , daunorubicin  $30 \text{ mg}/\text{m}^2/\text{week} \times 4$  weeks, daily prednisolone  $60 \text{ mg}/\text{m}^2/\text{day} \times 4$  weeks and daily IV L-asparaginase (ASP)  $5000 \text{ U}/\text{m}^2/\text{day} \times 21$  days. Four weeks of consolidation followed and included 6-mercaptopurine (6-MP)  $60 \text{ mg}/\text{m}^2/\text{day} \times 28$  days, cytosine arabinoside (ARA-C)  $75 \text{ mg}/\text{m}^2/\text{day}$  for 4 days of each week and cyclophosphamide (CPM)  $1 \text{ g}/\text{m}^2$  on days 1 and 29. All patients also received five



**Figure 15.36** Comparison of DFS and CNS relapse-free interval in medium and high risk patients randomly assigned to receive or not receive cranial radiotherapy (RT). Adapted and reprinted from Vilmer *et al.*, *Leukaemia* (full reference p. 374) with permission from Nature, Macmillan Publishers Ltd.

doses of IT MTX during the first 8 weeks of induction/consolidation treatment. Interim maintenance consisted of an 8 week course of oral (PO) 6-MP 25 mg/m<sup>2</sup>/day, high dose (HD) IV MTX 2.5 g/m<sup>2</sup>/dose × 4 plus IT MTX × 4. Re-induction therapy consisted of dexamethasone 10 mg/m<sup>2</sup>/day × 21 days, VCR 1.5 mg/m<sup>2</sup>/week and doxorubicin 30 mg/m<sup>2</sup>/week × 4, ASP 10,000 U/m<sup>2</sup> × 4 doses, two cycles of ARA-C 75 mg/m<sup>2</sup>/dose, CPM 1 gm/m<sup>2</sup>, 2 weeks of daily PO thioguanine (6-TG) 60 mg/m<sup>2</sup>/day and IT MTX × 1. After completion of re-induction all patients were randomized to receive 24 Gy prophylactic cranial irradiation or not. Children between the ages of 1 and 2 years received 20 Gy. Maintenance therapy consisted of daily PO 6-MP 50 mg/m<sup>2</sup> and weekly PO MTX 20 mg/m<sup>2</sup>. The total duration of treatment for all patients was 2 years.

### Outcome

All analyses were performed on the basis of intention to treat. Only patients who remained failure free were censored on the date of last contact.

A total of 267 medium and high risk patients were registered on the study. Details regarding the number of patients who achieved remission by the end of induction-consolidation, number of patients who

had CNS disease at diagnosis, number of induction failures or of toxic deaths etc. are not available. Of the 183 patients who underwent randomization for cranial irradiation, 90 patients were treated with HDMTX and prophylactic cranial irradiation while 93 received HDMTX alone.

Outcome measures were CNS relapse rate and disease-free survival (DFS).

The CNS relapse rates in patients randomized to cranial irradiation plus HDMTX were 15 ± 4% compared to 9 ± 3.2% in patients without cranial irradiation. The hazard ratio [HR] (no radiotherapy versus radiotherapy) was 0.57, 95% CI 0.24–1.35. The isolated CNS relapse rates for patients treated with HDMTX alone was 7 ± 2.8% compared to 7 ± 2.9% for those who had cranial irradiation plus HDMTX.

Six-year DFS was 66 ± 5% and 68 ± 4.8% for patients with and without cranial irradiation respectively (Figure 15.36).

### Conclusion

It was concluded that the omission of cranial irradiation in medium or high risk children did not increase the risk of CNS relapse and had no significant impact on DFS.

## Study 22

Koizumi S, Fujimoto T. Improvement in treatment of childhood acute lymphoblastic leukaemia: a 10-year study by the Children's Cancer and Leukaemia Study Group. *Int J Hematol* 1994;59:99–112.

### Study design

Protocol 874 of the Children's Cancer and Leukemia Study Group was a prospective randomized trial carried out between 1987 and 1990.

### Objectives

The aim of this trial was to determine whether the omission of presymptomatic cranial irradiation (CRT) in children with either low risk or intermediate risk acute lymphoblastic leukemia, adversely influenced CNS relapse rate or treatment outcome.

### Details of study

Previously untreated children with ALL were registered in the trial. Children with low or intermediate risk ALL were randomized to either CRT with intrathecal chemotherapy (IT CT) or high dose IV methotrexate (HDMTX) plus IT CT. All eligible patients were randomized by a block random method that balanced assignment within and across institutions. All children with high risk ALL received cranial irradiation. Risk factor calculation was based on age and WBC count at diagnosis (Table 15.13).

**Table 15.13** Stage of acute lymphoblastic leukemia according to age and WBC count at diagnosis.

WBC Count ( $\times 10^9/l$ )	Age (Years)				
	<1	1–<4	4–<6	6–<10	$\geq 10$
$\leq 50$	IV (II)	I	I	II	III
$50 \leq 10$	IV (II)	I	II	III	III
$10 \leq 50$	IV (III)	II	II	III	III
$> 50$	IV (III)	III	III	III	III

I, low risk group; II, intermediate risk group; III, high risk group; IV, infant group; I + II standard risk group. Parentheses indicate the staging system for the 811 protocol.

Remission induction therapy consisted of IV vincristine (VCR) 2.0 mg/m<sup>2</sup>/week, oral prednisone (PDN) 60 mg/m<sup>2</sup>/day and L-asparaginase 2000 U/m<sup>2</sup>/dose IV. The duration of the remission induction phase is not unavailable from the report.

For CNS prophylaxis patients who attained complete remission were randomly assigned to 18 Gy CRT plus IT CT (regimen A) or HDMTX (2–4.5 g/m<sup>2</sup>) plus IT CT (regimen B). IT CT comprised of methotrexate 12 mg/m<sup>2</sup> and hydrocortisone 50 mg/m<sup>2</sup>. The total number of doses of IT CT is not specified in both risk groups of patients.

Maintenance chemotherapy consisted of intermittent cyclic administration of IV intermediate dose methotrexate 225 mg/m<sup>2</sup> and alternating biweekly oral 6-mercaptopurine (6-MP) 175 mg/m<sup>2</sup>  $\times$  5 days. All patients also received VCR/PDN pulses including late intensification with HDMTX. Patients with intermediate risk ALL also received Doxorubicin, VCR and L-asparaginase during maintenance.

### Outcome

Of the 370 eligible patients enrolled in the trial, 80 were considered to have low risk ALL and 109, intermediate risk. Ninety-seven patients (42 low risk and 55 intermediate risk) were randomized to receive CRT plus IT CT while the remaining 92 patients (38 low risk and 54 intermediate risk) received HDMTX plus IT CT.

Outcome measures were CNS relapse rate and event-free survival (EFS).

The CNS relapse rates were lower in patients randomized to CRT (3/97, 3%) compared to patients who did not receive CRT (9/92, 9.7%).

Five-year EFS rate was 75.6  $\pm$  5.7% and 70.5  $\pm$  6.1% for low and intermediate risk patients who received CRT compared to 69.2  $\pm$  5.5% and 67.5  $\pm$  5.9% for the same risk groups of patients respectively who did not receive CRT. This was not statistically significant.

### Conclusion

It was concluded that the omission of cranial irradiation in low or intermediate risk children with ALL had no significant impact on EFS despite a slightly higher rate of CNS relapse.

## Study 23

Schrappé M, Reiter A, Henze G, Niemeyer Ch, Bode U, KÝhl J, Gadner H, Havers W, PLYss H, Kornhuber B, Zintl F, Ritter J, Urban Ch, Niethammer D, Riehm H for the ALL-BFM study group. Prevention of CNS recurrence in childhood ALL: results with reduced radiotherapy combined with CNS-directed chemotherapy in four consecutive ALL-BFM trials. *Klin Padiatr* 1998;210:192–9.

### Study design

ALL-BFM trials 81, 83, 86 and 90 were prospective randomized multicenter trials that were conducted between 1981 and 1995 in Austria, Switzerland and Germany. Data was collected and updated on a regular basis in Hannover and Vienna.

### Objectives

The study aims were:

- To determine whether cranial irradiation could be omitted for presymptomatic CNS therapy in standard risk children with acute lymphoblastic leukemia (ALL) without adversely affecting the CNS relapse rate (ALL-BFM 81 study).
- To evaluate the efficacy of a reduction in the dose of cranial irradiation and its impact on the treatment outcome in children with high standard risk ALL (ALL-BFM 83 study).

This review focuses on the BFM 81 and 83 trials alone.

### Details of the study

Children and adolescents up to the age of 18 were enrolled in the four ALL-BFM trials. Patients were stratified into risk groups according to the BFM risk factor (BFM-RF), which was based on the diagnostic peripheral blood blast count and hepato-splenic enlargement. Those patients with Philadelphia chromosome positive ALL were categorized as high risk. In study ALL-BFM 81, patients were categorized into three risk groups according to the BFM-RF: standard risk (RF < 1.2), medium risk (RF 1.2–<1.7) and high risk (rf  $\geq$  1.7). In BFM ALL 83 study, standard risk group patients were further subdivided into low-standard risk (RF < 0.8) and high standard risk (RF 0.8–<1.2). Medium and high risk groups were as defined in the earlier BFM-ALL 81 study.

Chemotherapy details regarding induction, consolidation, intensification and maintenance blocks have not been specified in this report.

CNS prophylaxis treatment for ALL-BFM 81 was as follows. Standard risk patients (BFM-RF score 0.8–1.2) were randomized to 18 Gy cranial irradiation plus oral methotrexate ( $0.02 \text{ g/m}^2 \times 8$ ) and intrathecal methotrexate (IT MTX)  $\times 6$  (SR-A), or to IDMTX ( $0.5 \text{ g/m}^2 \times 4$ ) and IT MTX  $\times 6$  alone (SR-B).

In ALL-BFM 83, in patients with high standard risk ALL (BFM-RF  $0.8 < 1.2$ ) were randomized to 18 Gy cranial irradiation plus IDMTX ( $0.5 \text{ g/m}^2$ )  $\times 4$  and IT MTX  $\times 8$  or 12 Gy cranial irradiation plus IDMTX ( $0.5 \text{ g/m}^2$ )  $\times 4$  and IT MTX  $\times 8$ .

The outcome measure was CNS relapse rate.

In the ALL-BFM 81 trial (BFM-RF  $0.8 < 1.2$ ) 142 patients were randomized to cranial irradiation plus oral MTX and IT MTX while 137 received IDMTX and IT MTX alone.

In the ALL-BFM 83 trial, of the 143 high standard risk patients (BFM-RF  $0.8 < 1.2$ ), 72 patients were randomized to 12 Gy cranial irradiation (SR-H/1) and 71 patients to 18 Gy cranial irradiation (SR-H/2).

### Outcome

#### BFM-81 trial

The incidence of CNS relapses was higher in SR-B group patients (Tables 15.14 and 15.15). Again, though the incidence of CNS relapse was small in low standard risk ALL patients (BFM-RF < 0.8) treated with IDMTX without cranial irradiation (SR-B 1.6% isolated and 3.2% combined CNS relapses), nevertheless, the incidence of all relapses was lower in the irradiated group (SR-A) of low standard risk ALL patients compared to the unirradiated group (all relapses 12.9% versus 22.2% in SR-B).

#### BFM-83 trial

Both cranial irradiation regimens were equally effective in the prevention of CNS relapses. There was a slightly increased rate of systemic relapses in the group who received 12 Gy cranial irradiation but the difference was not statistically significant (Table 15.14).

Comparing the results of the patients in the BFM 83 study (SR-H/1 and SR-H/2) with the matching subset of patients in the BFM 81 study (SR-A), the addition of IDMTX and two additional doses of IT MTX did not improve overall outcome or reduce the incidence of CNS relapse.



**Table 15.14** Relapse according to the BFM (81 and 83) CNS prophylaxis regimens.

	BFM 81		BFM 83	
	SR-A (Patients with RF 0.8–<1.2 Only)	SR-B (Patients with RF 0.8–<1.2 Only)	SR-H/1 RF 0.8–<1.2	SR-H/2 RF 0.8–<1.2
Treatment				
CRT (Gy)	18	–	12	18
MTX (g/m <sup>2</sup> )	8 × 0.02 PO	4 × 0.5 IV	4 × 0.5 IV	4 × 0.5 IV
IT MTX (number of injection)	6	6	8	8
Patients randomized	80	74	72	71
Patients (%)				
All relapses	28.8	37.8	34.7	28.2
Isolated CNS	1.3	10.8	2.8	2.8
Combined CNS/BM	1.3	10.8	2.8	1.4

**Table 15.15** Trial ALL-BFM 81: randomized comparison for preventive cranial irradiation versus intermediate dose methotrexate in standard risk ALL patients (BFM-RF < 1.2).

	SR-A	SR-B
Treatment		
CRT (Gy)	18 Gy	–
MTX (g/m <sup>2</sup> )	8 × 0.02 (PO)	4 × 0.5 (IV)
IT MTX (number of injection)	6	6
Patients randomized	142	137
Relapses (%)		
All relapses	21.8	30.6
Isolated CNS	0.7	6.6
Combined CNS/BM	1.4	7.3

Standard risk (SR) = BFM-RF 0.8–1.2.

CRT, cranial radiotherapy; BM, bone marrow; PO, orally; IV, intravenous.

## Conclusion

### BFM-ALL 81 trial

It was concluded that intermediate dose intravenous methotrexate plus intrathecal methotrexate without cranial irradiation in high standard risk (BFM-RF 0.8–1.2) ALL patients was unsafe as it resulted in a significantly increased rate of CNS relapse. However, in low standard risk patients (BFM-RF < 0.8), cranial irradiation could be omitted without any increased incidence of CNS relapse.

### BFM-ALL 83 trial

The dose of CNS irradiation can be reduced to 12 Gy in high standard risk ALL patients (BFM-RF 0.8–<1.2) without an increased frequency of CNS relapses when combined with intermediate dose methotrexate and intrathecal methotrexate.

## Study 24

Clarke M, Gaynon P, Hann I, Harrison G, Masera G, Peto R, Richards S. From the Clinical Trial Service Unit, Oxford, and Great Ormond Street Hospital, London, United Kingdom; Children's Center for Cancer and Blood Disease, Los Angeles, CA; Clinica Pediatrica dell'Università di Milano-Bicocca, Monza, Italy. CNS-Directed Therapy for Childhood Acute Lymphoblastic Leukemia: Childhood ALL Collaborative Group Overview of 43 Randomised Trials. *J Clin Oncol* 2003; 21:1798–809.

This report is a meta-analysis 43 randomised trials in childhood acute lymphoblastic leukemia (ALL) that was performed worldwide before or during 1993.

## Objectives/methodology

Individual patient data of more than 9000 children were retrieved for analysis and were compared according to the type of central nervous system (CNS) directed therapy. The various CNS directed therapies were categorized into (1) intrathecal chemotherapy (IT CT), (2) intravenous methotrexate (IV MTX), (3)

intravenous mercaptopurine (IV 6MP) at a dose of at least 500 mg/m<sup>2</sup> or more (4) cranial irradiation (CRT) and (5) craniospinal irradiation (CSRT). IT CT was further subdivided into short IT CT (2–8 doses) given early in treatment and long IT CT (10–26 doses). Variables included for subgroup analysis included sex, age (<10 years and ≥10 years), white blood count (WBC) (<50 × 10<sup>9</sup>/l and ≥50 × 10<sup>9</sup>/l) and ALL immunophenotype (B cell or T cell lineage).

The primary outcome measures were event-free survival (EFS) and overall survival (OS) from randomization date. Secondary end points included CNS relapse (any relapse with CNS involvement), non-CNS relapse, isolated CNS relapse and death in remission. Since all data were censored after first relapse, thus analyses of a particular type of relapse were censored at relapse of any other type.

## Statistics

The observed minus the expected (O–E) number of events in one treatment group and its variance (V) were calculated for each trial by means of a log-rank survival analyses using the exact date of events. Information from different trials was then combined by summing up the separate (O–E) to calculate the odds ratios (ORs) for annual event rates, their confidence intervals (CIs) and descriptive survival curves. The descriptive curves and the EFS and survival values at 10 years showed the treatment effects in the trials in terms of absolute differences.  $\chi^2$  tests of heterogeneity and trend were used to determine the differences in treatment effect both between trials and between different subgroups of patients.

## Results and outcome

Table 15.16 shows the 43 trials of CNS directed therapy while Table 15.17 shows the patient numbers by age, sex, immunophenotype and median length of follow up within each trial. Figure 15.37 shows the annual event rates over the first 11 years or more of follow up of all the trials in the main treatment comparisons.

### 1 Radiotherapy [RT] plus IT CT versus Extra IT CT

Of the eight trials that compared CRT plus IT CT with IT CT alone, data was unavailable in one trial that

included about 350 children. In the remaining seven trials, 2848 children were randomized either to CRT plus IT CT or IT CT alone. The overall event rate was similar in both groups (CRT, 34.3% versus IT CT, 36%).

Isolated CNS relapses were lower with CRT (4.9%) compared to IT CT (7.1%) ( $p = 0.03$ ). However, the 22% proportional reduction (non-significant) in the annual rate of any CNS relapse with CRT was counterbalanced by a 5% increase (non-significant) in the annual non-CNS relapse rate (Table 15.18). There was no difference in the 10-year OS (CRT, 73.5% versus IT CT, 75.3%) or EFS (CRT, 64% versus IT CT, 62.8%) in the two groups (Figure 15.38).

### 2 Addition of IV methotrexate to long-term IT CT or RT with IT CT

Eight trials, which randomized the addition of IV MTX were included in this comparison and included 3189 children. All treatment arms included RT plus and 9 or more IT CT doses or at least 12 IT CT doses. The dose of IV MTX ranged from 0.5 to 8 gm/m<sup>2</sup>.

Patients who received IV MTX had a lower incidence of non-CNS relapses and CNS relapses. Non-CNS relapse and CNS relapse rates were reduced by 17% ( $p = 0.02$ ) and 19% ( $p = 0.08$ ) respectively. The reduction in isolated CNS relapses was also non-significant ( $p = 0.1$ ). However, there was a significant reduction in the annual overall event rate (17%;  $p = 0.03$ ) and this was reflected by a 6.2% improvement in the 10-year EFS (Figure 15.39). There was however, no significant difference in OS.

### 3 RT plus short IT CT versus IV MTX plus short IT CT term

Three trials that randomized children ( $n = 958$ ) to RT or IV MTX are included in this meta-analysis. All children received some IT CT.

Although RT reduced CNS relapse rate by 62% ( $p < 0.00001$ ), this was counterbalanced by a 67% increase in the non-CNS relapse rate ( $p = 0.00005$ ). There was a 37% statistically non-significant reduction in deaths in first remission for children randomized to RT. No differences were observed in the 10-year OS (RT: 65% versus IV MTX: 64.2%) or EFS (RT: 53% versus 50.6%: IV MTX) in both groups of children.

**Table 15.16** Trails analyzed.

Trial Name	Year Started	CNS-Directed Therapy
<b>A. Radiotherapy plus IT therapy versus extra IT therapy</b>		
SWOG7623/AlinC12	1976	Rand 24 Gy XRT IT + IT MTX × 5 versus TIT × 22
CCG-161	1978	IT MTX × 6 Rand 18 Gy XRT versus IT MTX × 8
LAL 7/78	1978	Rand 24 Gy XRT + IT MTX × 6 versus DIT × 10
CCG-105	1983	IT MTX × 6 Rand 18 Gy XRT versus IT MTX × 8 (F) or 14 (M)
INEN-P83	1983	IT MTX × 5 Rand 18 Gy XRT versus IT MTX × 12
INS 84	1984	TIT × 6 (SR) or nil (HR) Rand 18 Gy XRT versus TIT × 12
INEN-P85	1985	Rand 18 Gy XRT + IT MTX × 5 versus TIT × 17
CCG-1882	1989	IT MTX × 14(F) or 18(M) + IT Ac × 1 Rand 18 Gy XRT versus IT MTX × 7
<b>B. Addition of IV methotrexate to long-term IT therapy or radiotherapy with IT therapy</b>		
CCG-163d	1978	18 Gy XRT + IT MTX × 14 Rand ± 0.69 g/m <sup>2</sup> IV MTX × 8
DFCI 81001	1981	18 or 28 Gy CS XRT + IT Ac × 1 + IT MTX × 8 Rand ± 4 g/m <sup>2</sup> IV MTX × 1
CCG-139	1984	IT MTX × 15 (F) or 20 (M) Rand ± 0.5 g/m <sup>2</sup> IV MTX × 24 (F) or 33 (B)
DFCI 87001	1987	IT Ac × 2 + IT MTX × 10 (HR: + 18 Gy XRT) Rand ± 4 g/m <sup>2</sup> IV MTX × 1
UKALL XI LWCC	1990	IT MTX × 16 Rand ± 6–8 g/m <sup>2</sup> IV MTX × 3
SJCRH Total XIII A	1991	TIT × 13 or 17 + 2 g/m <sup>2</sup> IV MTX × 9 or 10 Rand ± 1 g/m <sup>2</sup> IV MTX × 1
FRALLE 93 LR	1993	TITC × 16 Rand ± 1.5 g/m <sup>2</sup> IV MTX × 6
FRALLE 93 IR	1993	TITC × 18 Rand ± 8 g/m <sup>2</sup> IV MTX × 4
<b>C. Radiotherapy plus short-term IT therapy versus IV methotrexate plus short-term TFT therapy</b>		
CLB 7611	1976	IT MTX × 6 Rand 24 Gy XRT versus 0.5 g/m <sup>2</sup> IV MTX × 3
ALL-BFM-81	1981	IT MTX × 6 Rand 12–18 Gy XRT versus 0.5 g/m <sup>2</sup> IV MTX × 4
ALL VII 81	1981	IT MTX × 2–8 Rand 1 8 Gy XRT versus 0.5 g/m <sup>2</sup> IV MTX × 4
<b>D. Higher doses of radiotherapy</b>		
UKALL V	1976	IT MTX × 5 Rand 24 Gy versus 21 Gy XRT
UKALL VI(i)	1978	IT MTX × 8 IT Ac × 2 + 0.5 g/m <sup>2</sup> IV MTX × 3 Rand 24 Gy versus 21 Gy XRT
UKALL VI(ii)	1978	IT MTX × 8 + IT Ac × 2 + 0.5 g/m <sup>2</sup> IV MTX × 3 Rand 24 Gy versus 18 Gy XRT
UKALL VII	1979	IT MTX × 5 Rand 24 Gy versus 18 Gy XRT
GBTLI-80	1980	IT MTX × 13 Rand 24 Gy versus 18 Gy XRT
TCLSG L81-10	1981	DIT × 5 Rand 24 Gy versus 18 Gy XRT
ALL-BFM-83	1983	IT MTX × 8 + 0.5 g/m <sup>2</sup> IV MTX × 4 Rand 18 Gy versus 12 Gy XRT
<b>E. Radiotherapy plus short-term IT therapy versus IV methotrexate plus long-term IT therapy</b>		
JCCLSG L-874	1987	DITB × 3 Rand 18 Gy XRT versus 2 g/m <sup>2</sup> IV MTX × 3 + DITB × 10
GCMTLA	1988	TITB × 6 Rand 12–18 Gy XRT versus 0.5 g/m <sup>2</sup> IV MTX × 4 + TITB × 6
UKALL XI HWCC	1990	IT MTX × 7 Rand 24 Gy XRT versus 6–8 g/m <sup>2</sup> IV MTX × 3 + IT MTX × 9
<b>F. Addition of IV methotrexate plus IT therapy to radiotherapy plus IT therapy and/or IV methotrexate</b>		
ALL VII 81	1981	12 or 18 Gy XRT + IT MTX × 8 Rand ± 0.5 g/m <sup>2</sup> IV MTX × 4 + IT MTX × 4
TCCSG L84-11 SR	1984	18 Gy XRT + TIT × 5 + 0.5 g/m <sup>2</sup> IV MTX × 4 IT MTX × 4 Rand ± 0.5 g/m <sup>2</sup> IV MTX × 3 + DITB × 6

(Continued)

**Table 15.16** (Continued)

Trial Name	Year Started	CNS-Directed Therapy
TCCSG L84-11 HR	1984	24 Gy XRT + TIT × 5 + 0.5 g/m <sup>2</sup> IV MTX × 12 + DITB × 12 Rand ± 0.5 g/m <sup>2</sup> IV MTX × 3 + TIT × 6
G. Other comparisons, with data		
St. Jude VI	1968	± 1 g/m <sup>2</sup> IV MTX × 3 Rand ± 15–24 CS XRT
St. Jude VII	1970	Rand 15–24 Gy CS XRT versus 15–24 Gy XRT + IT MTX × 5
CCG-101-a	1972	IT MTX × 6 Rand ± 24 Gy XRT
CCG-101-b	1972	Rand 24 Gy CS XRT ( + 12 Gy extended field) versus IT MTX × 6
CCG-143	1974	Rand 18 Gy CS XRT versus 18 Gy XRT + IT MTX × 6
CCG-162	1978	18 Gy XRT + IT MTX × 6 Rand ± IT MTX × 8
UKALL VII	1979	18 or 24 Gy XRT + IT MTX × 5 Rand ± IT MTX × 8
EORTC 58832	1983	2.5 g/m <sup>2</sup> IV MTX × 4 + IT MTX × 7 Rand ± 16–20 Gy XRT
ALL-REZ-BFM-85	1985	IT MTX × 9 Rand 12 g/m <sup>2</sup> IV MTX × 9 versus 1 g/m <sup>2</sup> IV MTX × 9
FRALLE 87	1987	DITC × 5 Rand 8 g/m <sup>2</sup> IV MTX × 4 versus 3 g/m <sup>2</sup> IV MTX × 4 + DITC × 5
JCCLSG 1-874	1987	(2.0 g/m <sup>2</sup> × 1 + 4.5 g/m <sup>2</sup> × 20) IV MTX + DITB × 1 Rand 18 Gy XRT + DITB × 2 versus 4.5 g/m <sup>2</sup> IV MTX × 3
EORTC 58881	1989	5 g/m <sup>2</sup> IV MTX × 4 + IT MTX × 8 Rand ± 1 g/m <sup>2</sup> IV MP × 18
FRALLE 89	1989	IT MTX × 5 Rand 8 g/m <sup>2</sup> IV MTX × 4 versus 3 g/m <sup>2</sup> IV MTX × 4 + IT MTX × 5
ALL-REZ-BFM-90	1990	TITC × 9 Rand 5 g/m <sup>2</sup> IV MTX × 6 versus 1 g/m <sup>2</sup> IV MTX × 6
Other comparisons, without data		
ALGB 6801	1968	Rand ± IT MTX × 15
POG CNS 2	1970	IT MTX × 20 Rand ± 24 Gy XRT
GATLH70a	1970	Rand ± XRT + IT MTX × 5
CLB 7111	1971	IT MTX × 6 Rand ± 24 Gy XRT
CALGB-7113	1971	24 Gy + IT MTX × 12 Rand ± IT MTX × 3
NCI 72-1	1971	24 Gy XRT Rand IT Ac × 38 versus IT MTX × 35
SWOG 690/691/AlinC9	1971	TIT × 15 Rand ± 18–24 Gy XRT
DFCI-SFCC	1972	IT MTX × 9 Rand ± 24 Gy XRT
UKALL II	1972	24 Gy XRT Rand 24 Gy Sxrt versus 10 Gy Sxrt + IT MTX × 4
CLB 7411	1974	IT MTX × 6 Rand ± 24 Gy XRT
POG 7712	1977	TIT × 6 + 24 Gy XRT Rand 14 Gy Sxrt versus TIT × 13
NCI 77-02	1980	Rand 18–24 Gy XRT + IT MTX × 5 versus 33.6 g/m <sup>2</sup> IV MTX × 10
POG8035/8036/AlinC13	1981	TIT × 6 Rand 1 g/m <sup>2</sup> IV MTX × 17 + IT MTX × 4 versus TIT × 17
NCI-84-C-153A	1984	Rand 33.6 Gy/m <sup>2</sup> IV MTX × 10 + IT MTX × 8
JALSG ALL-87	1987	Rand ± IT ? × 1
DFCI ALL91-001	1991	4 g/m <sup>2</sup> IV MTX × 1 + IT Ac × 9 + IT MTX × 9 Rand ± 1 g/m <sup>2</sup> IV MP × 32
POG9005/AlinC15-b	1991	TIT × 16 Rand 1 g/m <sup>2</sup> IV MP × 12 versus 1 g/m <sup>2</sup> IV MTX × 12
POG9005/AlinC15-c	1991	1 g/m <sup>2</sup> IV MTX × 12 + TIT × 16 Rand ± 1 g/m <sup>2</sup> IV MP × 12
POG9005/AlinC15-a	1991	TIT × 15 or 16 + 1 g/m <sup>2</sup> IV MP × 12 Rand oral MTX versus 1 g/m <sup>2</sup> IV MTX × 12

Ac: cytosine arabinoside; CSxrt: craniospinal irradiation; DITC: IT MTX + IT P; DIT: IT MTX + IT Ac; DITB: IT MTX + ITT; Dx: dexamethasone; F: girls; Hc: hydrocortisone; HR: high risk; IT: intrathecal; M: boys; MP: methylprednisolone; MTX: methotrexate; P: prednisolone; Rand: randomized; SR: standard risk; Sxrt: spinal irradiation; TIT: IT MTX + IT Ac + IT Hc; TITB: IT MTX + IT Ac + IT Dx; TITC: IT MTX + IT Ac + IT P; XRT: cranial irradiation.

**Table 15.17** Patient characteristics by trial.

	Number of Patients	Age (Years)			WCC			Immuno- phenotype		Median follow-up (years)
		0–9	≥10	(%)*	<50	≥50	(%)†	C/pre-B	T	
A. Radiotherapy plus IT therapy versus extra IT therapy										
CCG-161	530	530	0	0	530	0	0	403	26	7
LAL 7/78	87	82	5	6	70	17	20	–	–	11
CCG-105	1389	1045	344	25	1389	0	0	557	29	11
INEN-P83	59	45	14	24	55	4	7	–	–	8
INS 84	74	64	10	14	74	0	0	69	1	12
INEN-P85	73	62	11	15	65	8	11	–	–	5
CCG-1882	636	251	385	61	335	300	47	394	47	6
B. Addition of IV methotrexate to long-term IT therapy or radiotherapy with IT therapy										
CG-163d	321	228	93	29	0	321	100	227	52	8
DFCI 81001	77	61	16	21	58	19	25	–	–	15
CCG-139	148	112	36	24	148	0	0	78	2	11
DFCI 87001	353	285	68	19	281	72	20	319	34	8
UKALL XI LWCC	1513	1313	200	13	1513	0	0	1300	54	6
SJCRH Total XIII	162	119	43	27	0	162	100	140	22	6
FRALLE 93 LR	134	134	0	0	133	0	0	133	0	3
FRALLE 93 IR	481	432	49	10	449	32	5	479	0	3
C. Radiotherapy plus short-term IT therapy versus IV methotrexate plus short-term IT therapy										
CLB 7611	525	404	121	23	452	73	14	5	18	11
ALL-BFM-81	279	215	64	23	273	6	2	76	10	12
ALL VII 81	154	132	22	14	148	6	4	31	9	13
D. Higher doses of radiotherapy										
UKALL V	368	321	47	13	368	0	0	–	–	20
UKALL VI(i)	87	45	42	48	55	32	2	–	–	19
UKALL VI(ii)	43	17	25	60	26	17	40	–	–	18
UKALL VII	82	74	8	10	82	0	0	–	–	18
TCLSG L81-10	86	84	2	2	86	0	0	–	–	15
ALL-BFM-83	143	119	24	17	132	11	8	125	10	12
E. Radiotherapy plus short-term IT therapy versus IV methotrexate plus long-term IT therapy										
JCCLSG L-874	87	85	0	0	87	0	0	58	1	9
GCMTLA	112	94	18	16	71	41	37	–	–	8
UKALL XI HWCC	313	258	55	18	0	313	100	198	94	6
F. Addition of IV methotrexate plus IT therapy to radiotherapy plus IT therapy and/of IV methotrexate										
ALL VII 81	88	79	9	10	87	1	1	29	2	11
TCCSG L84-11 SR	187	186	0	0	187	0	0	–	–	11
TCCSG L84-11 HR	236	164	72	31	207	29	12	–	–	11

C/pre-B: B cell lineage; IIT: intrathecal; IV: intravenous; T: T cell lineage; WCC, white cell count.

\* Percentage ages ≥10 years.

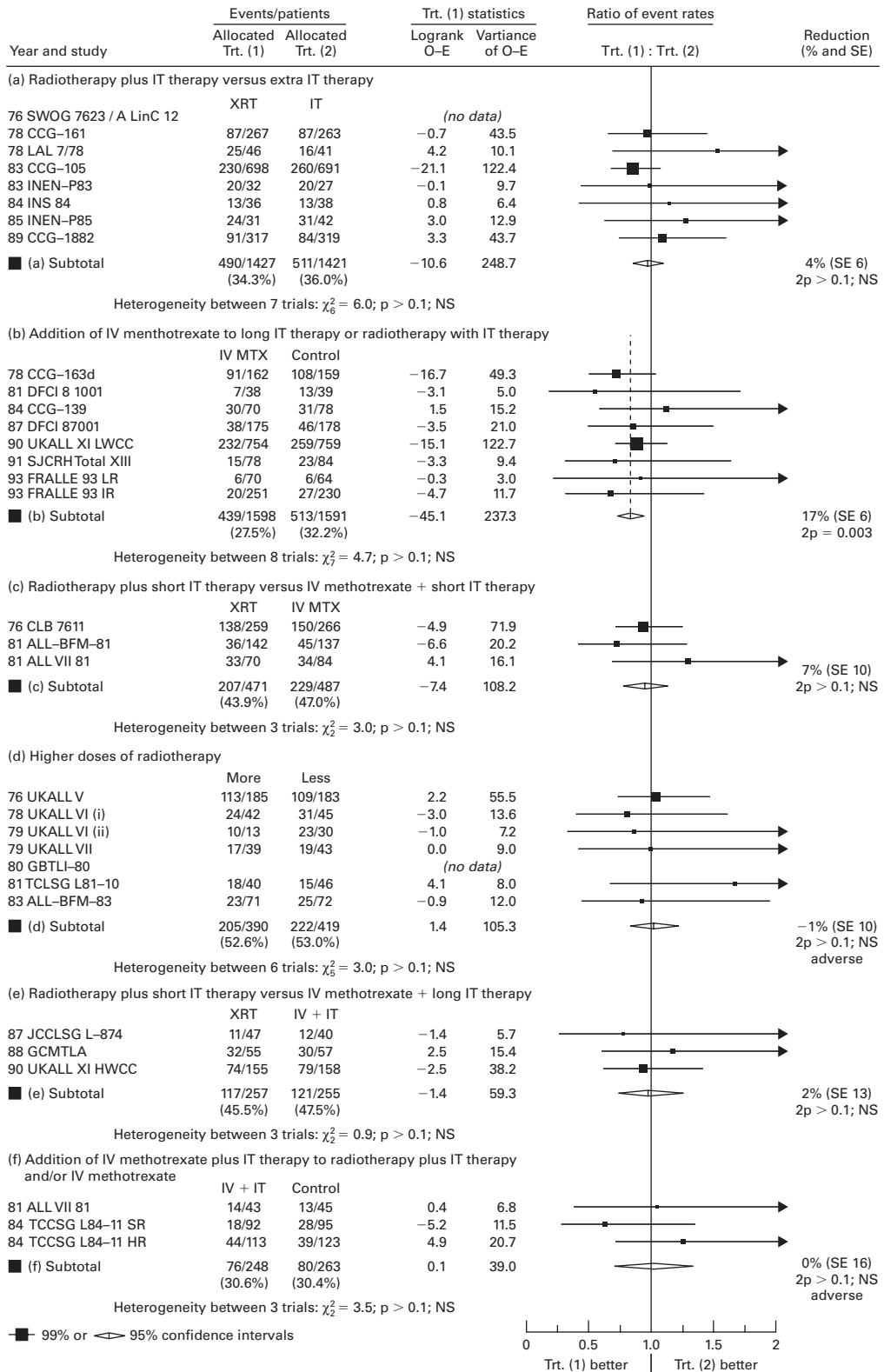
† Percentage with WCC ≥50.

#### 4 Higher doses of RT

Seven trials compared different doses of RT for presymptomatic CNS therapy. All used short term IT CT in all the treatment arms. Data was available for 809 children from 6 of the trials. The excluded trial randomized less

than 200 children. Figure 15.37 shows the EFS for each of the six trials.

As shown in Table 15.18, there was no significant difference between the various RT doses with respect to the rate of CNS relapses (isolated or combined),



**Figure 15.37** Effects on EFS for main comparisons. Ratios of annual event rates with each trial result represented by a square; larger squares indicate trials that provide more information. The over-all result for each type of comparison is represented by a diamond. © American Society of Clinical Oncology (full reference on p. 378).

**Table 15.18** Treatment effects on different sites of relapse and deaths in first remission.

	Numbers with Event, by Randomized Treatment		Log-Rank Odds Ratio	95% CI	<i>p</i>
A. Radiotherapy plus IT therapy versus extra IT therapy					
	<u>XRT (n = 1427)</u>	<u>IT therapy (n = 1421)</u>			
Any CNS relapse	90	117	0.78	0.59–1.03	0.08
Non-CNS relapse	351	333	1.05	0.90–1.22	0.52
Death in first remission	41	50	0.81	0.54–1.22	0.31
Any event	490	511	0.96	0.85–1.08	0.50
B. Addition of IV methotrexate to long-term IT therapy or radiotherapy with IT therapy					
	<u>IV MTX (n = 1598)</u>	<u>Control (n = 1591)</u>			
Any CNS relapse	118	145	0.81	0.63–1.03	0.08
Non-CNS relapse	287	328	0.83	0.71–0.97	0.02
Death in first remission	24	25	0.91	0.52–1.60	0.76
Any event	439	513	0.83	0.73–0.94	0.003
C. Radiotherapy plus short-term IT therapy versus IV methotrexate plus short-term IT therapy					
	<u>XRT (n = 471)</u>	<u>IV MTX (n = 487)</u>			
Any CNS relapse	37	109	0.38	0.28–0.53	<0.00001
Non-CNS relapse	155	96	1.67	1.30–2.14	0.00005
Death in first remission	14	23	0.63	0.33–1.20	0.16
Any event	207	229	0.93	0.77–1.13	0.48
D. Higher doses of radiotherapy					
	<u>More (n = 390)</u>	<u>Less (n = 419)</u>			
Any CNS relapse	30	27	1.22	0.72–2.06	0.45
Non-CNS relapse	140	168	0.89	0.71–1.12	0.32
Death in first remission	31	22	1.68	0.97–2.90	0.06
Any event	205	222	1.01	0.84–1.23	0.89
E. Radiotherapy plus short-term IT therapy versus IV methotrexate plus long-term IT therapy					
	<u>XRT (n = 257)</u>	<u>IV MTX + IT (n = 255)</u>			
Any CNS relapse	29	45	0.65	0.41–1.02	0.06
Non-CNS relapse	79	64	1.26	0.91–1.75	0.17
Death in first remission	7	10	0.71	0.27–1.83	0.48
Any event	117	121	0.98	0.76–1.26	0.86
F. Addition of IV methotrexate plus IT therapy to radiotherapy plus IT therapy and/or IV methotrexate					
	<u>Addition (n = 248)</u>	<u>Control (n = 263)</u>			
Any CNS relapse	7	13	0.59	0.24–1.42	0.23
Non-CNS relapse	48	55	0.92	0.62–1.35	0.67
Death in first remission	21	11	1.95	0.97–3.90	0.06
Any event	76	80	1.00	0.73–1.37	0.99

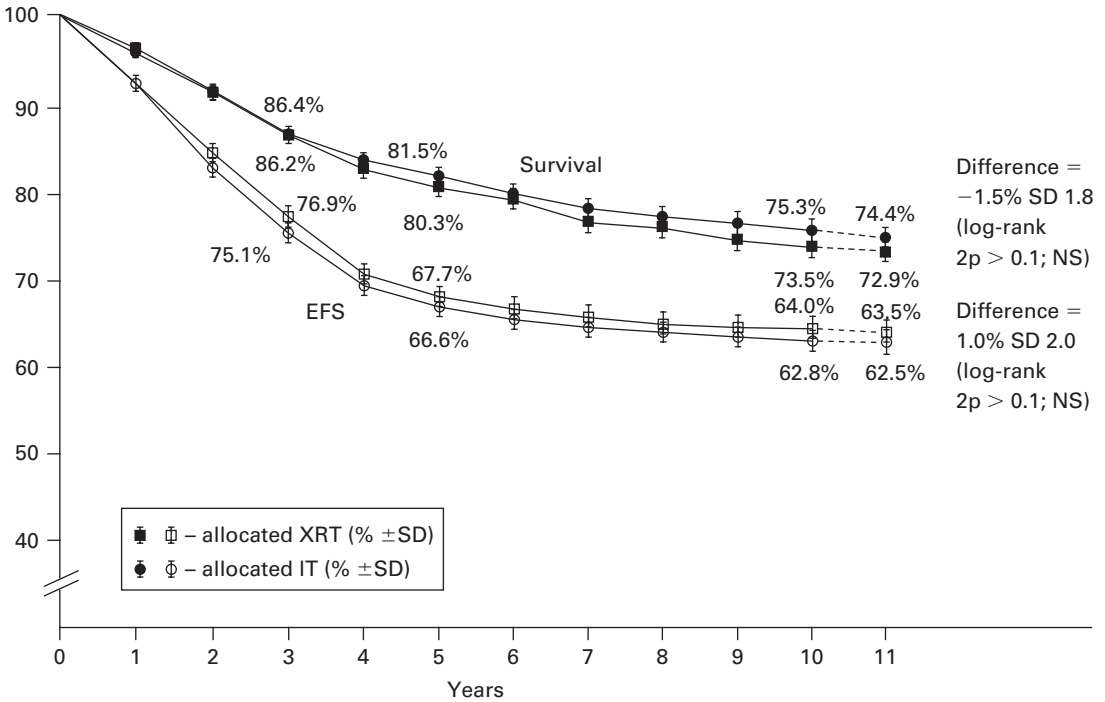
Total events are not always the sum of the numbers above because of a small number of non-remitters. These are excluded from analyses of CNS relapse, non-CNS relapse, and death in first remission, but counted as having an event on day 1 in analyses of any event.

CI: confidence interval and XRT: cranial irradiation.

non-CNS relapses or death in remission. The 10-year OS was non-significantly higher (59.1%) with lower doses than with higher doses (55.9%) and the difference in 10-year EFS was <1%.

### 5 RT plus short-term IT CT versus IV MTX plus long-term IT CT

Three trials that randomized children (n = 512) to either RT or IV MTX are included in this analysis.



Difference = -1.5% SD 1.8 (log-rank 2p > 0.1; NS)  
 Difference = 1.0% SD 2.0 (log-rank 2p > 0.1; NS)

Deaths/person-years:

XRT	51/1400	73/1328	65/1250	54/1162	28/1085	17/985	27/825	6/674	10/538	5/438	7/937
IT	60/1384	65/1321	72/1241	42/1152	23/1091	25/983	18/821	8/674	5/544	5/448	11/939

Events/person-years:

XRT	111/1372	110/1251	102/1133	90/1015	35/918	15/823	11/684	7/557	3/440	1/365	5/786
IT	110/1359	140/1227	104/1095	82/989	34/904	16/808	9/671	5/548	4/441	3/363	4/751

**Figure 15.38** Comparison A: Radiotherapy plus intrathecal (IT) therapy versus extra IT therapy – effects on survival and EFS. Descriptive curves of survival and EFS rates by treatment. Annual numbers of deaths, events, and person-years at risk are given beneath the graph. © American Society of Clinical Oncology (full reference on p. 378).

10-year EFS (RT: 51.2% versus IV MTX+IT CT: 49.6%) and OS (RT: 66.7% versus IV MTX+IT CT 64.7%) were similar with both treatments. There were no significant differences in CNS relapses, non-CNS relapses or deaths in remission between the two treatments (Table 15.18).

**6 Addition of IV MTX plus IT CT to RT plus IT CT and/or IV MTX**

Three trials are included in this meta-analysis. All three trials used RT in both the randomized arms of therapy. There was no reduction in the annual event rate with additional therapy.

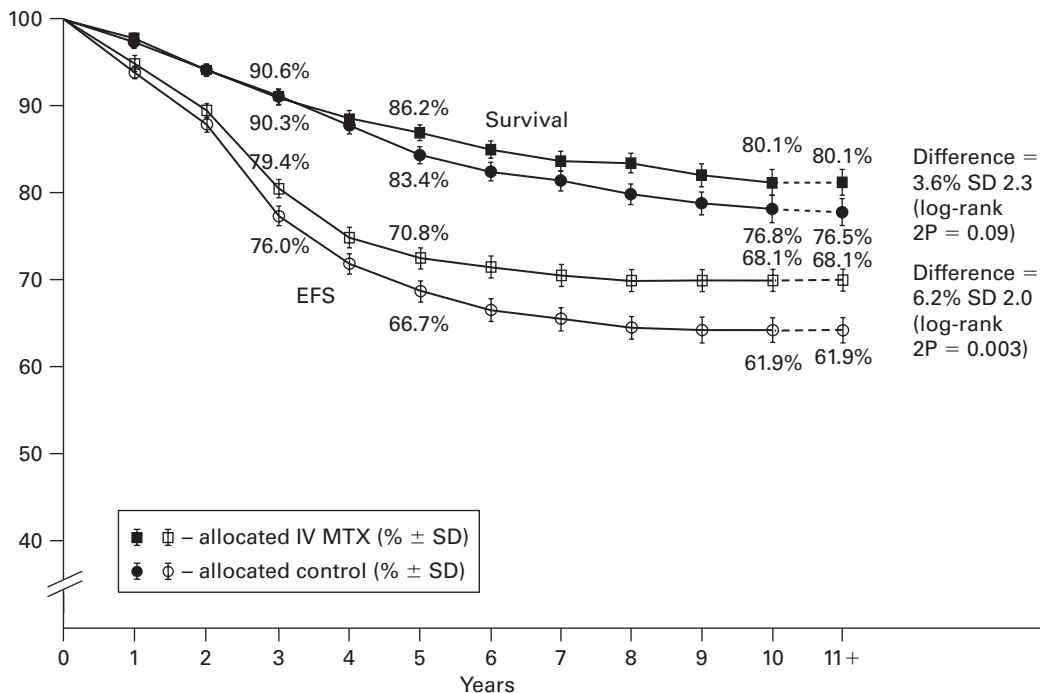
No differences were observed in non-CNS relapses, CNS relapses, deaths in remissions or OS with the additional therapy (Table 15.18).

**7 Other comparisons**

Another 29 trials were identified which addressed treatment questions not addressed in any of the above 6 comparisons. Data were available from only 14 trials and the EFS for each is shown in Figure 15.40.

The St. Jude VI trial showed a significant benefit when craniospinal RT (CSRT) was added a treatment regimen without IT CT.





## Deaths/person-years:

IV MTX	38/1566	61/1465	49/1342	32/1171	19/963	18/749	10/566	1/387	4/210	1/101	0/203
Control	46/1562	50/1465	46/1354	46/1175	41/966	18/753	8/579	8/395	3/211	1/99	1/219

## Events/person-years:

IV MTX	88/1547	89/1402	138/1224	77/994	28/796	9/608	7/461	3/312	0/167	0/85	0/190
Control	101/1532	97/1391	163/1187	78/961	39/773	21/598	8/455	5/305	1/161	0/78	0/187

**Figure 15.39** Comparison B: Addition of intravenous IV MTX to long-term intrathecal (IT) therapy or radiotherapy with IT therapy – effects on survival and EFS. Descriptive curves of survival and EFS rates by treatment. Annual numbers of deaths, events, and person-years at risk are given beneath the graph. © American Society of Clinical Oncology (full reference on p. 378).

The CCG 101 trial showed that CR RT and CSRT were more effective than short-term IT CT alone.

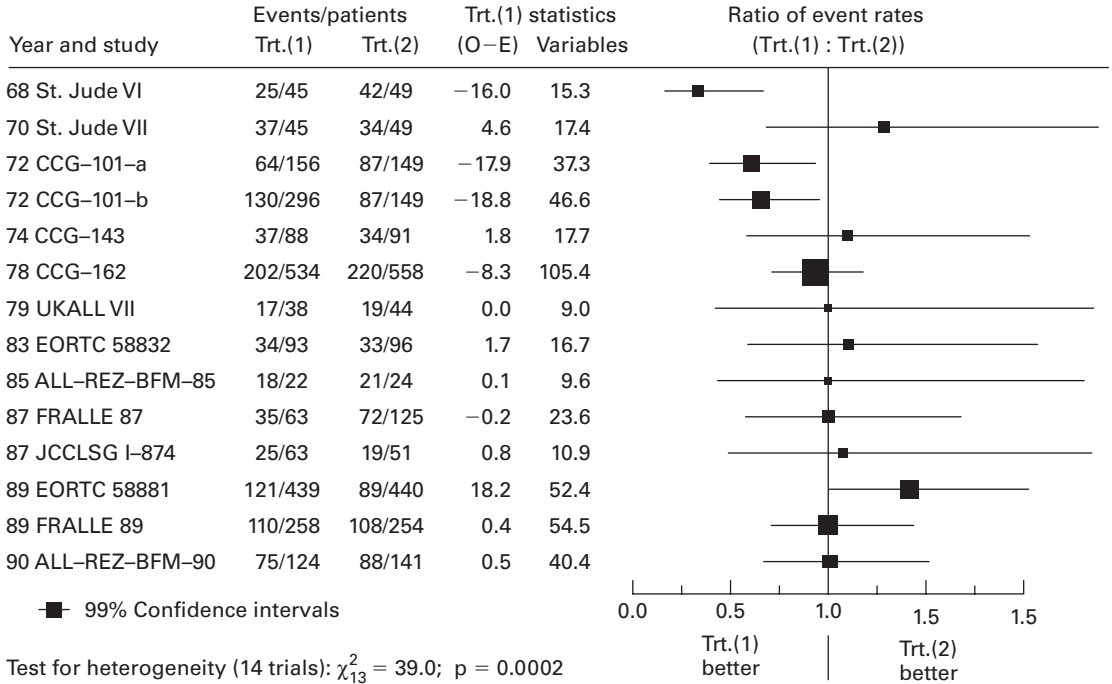
Both the CCG 162 trial and the UK MRC trial VI that the addition of extra IT CT to RT plus short-term IT CT, had no significant effect on overall outcome.

The European Organisation for Research and Treatment of Cancer (EORTC) trial 58881 suggested that addition of IV mercaptopurine (IV 6 MP) to a regimen of IV MTX plus IT CT had an adverse effect on outcome.

Four trials also examined the efficacy of higher doses of IV MTX (2 in relapsed patients and 2 that included extra IT CT in the arm with lower dose of IV MTX) and found no benefit with higher doses.

### Conclusions

- 18 or 21 Gy of radiotherapy was as effective as 24 Gy in preventing CNS relapses
- Addition of IV MTX to either RT plus short-term IT CT or long-term IT CT improved EFS by reducing non-CNS relapses
- Though RT reduced the incidence of CNS relapses when compared to long-term IT CT, there was no difference in OS or EFS as this reduction in CNS relapses was counter-balanced by a slight increase in the incidence of non-CNS relapses. It was concluded that radiotherapy can be replaced by long-term IT CT.



**Figure 15.40** Effects on EFS in other trials. Format as in Figure 15.37. Trt. (1) and Trt. (2) refer to either the first and second randomized treatments, respectively, as specified in Table 15.16, or to treatment without and with the additional component indicated by ± in Table 15.16. © American Society of Clinical Oncology (full reference on p. 378).

### Study 25

Millot F, Suciú S, Philippe N, Benoit Y, Mazingue F, Uyttbroeck A, Lutz P, Mechinaud F, Robert A, Boutard P, Marguerite G, Ferster A, Plouvier E, Rialland X, Behard C, Plantaz D, Dresse MF, Philippet P, Norton L, Thyss A, Dastugue N, Waterkeyn C, Vilmer E, Otten J. Children’s Leukemia Cooperative Group of the European Organization for Research and Treatment of Cancer.

Value of high-dose cytarabine during interval therapy of a Berlin—Frankfurt—Munster-based protocol in increased-risk children with acute lymphoblastic leukemia and lymphoblastic lymphoma: results of the European Organization for Research and Treatment of Cancer 58881 randomized phase III trial. *J Clin Oncol* 2001;**19**:1935–42.

#### Study design

The European Organisation for Research and Treatment of Cancer (EORTC) Children’s Leukaemia Cooperative Group (CLCG) 58881 trial was a

randomized prospective multicenter study that ran from January 1990 till January 1996.

#### Objectives

The study aimed to assess the efficacy of the addition of high dose (HD) intravenous (IV) cytarabine (ARA-C) to HD IV methotrexate (MTX) in reducing the incidence of central nervous system (CNS) and systemic relapses in children with intermediate risk acute lymphoblastic leukemia (ALL).

#### Details of study

Children and adolescents below the age of 18 with previously untreated ALL or lymphoma were eligible for inclusion in this study. Patients were stratified into 3 risk groups – Low-risk (LR; ALL with BFM risk factor <0.8 and stage II or II lymphoblastic lymphoma), intermediate or increased risk (IR; ALL with BFM risk factor ≥0.8, T cell ALL or stage III or IV lymphoblastic

lymphoma) and very high risk (VHR;  $>1 \times 10^9/l$  blasts in peripheral blood after 1 week of prednisolone and intrathecal (IT) MTX, undifferentiated leukemia, chromosomal translocations t (4; 11) or t (9; 22), ALL patients with incomplete remission or less than good

partial response for lymphoblastic lymphoma patients. All patients with mature B cell ALL or B cell lymphoma were ineligible.

Patients were considered to have CNS leukemia if they had neurological symptoms secondary to

**Table 15.19** Treatment schedule for increased-risk patients according to EORTC 58881 protocol.

Drug	Dose*	Applied on Days
<b>Induction</b>		
Prednisolone (orally)	60	1–7 (prephase)
Prednisolone (orally)	60	8–28, then tapered over 9 days
Vincristine (IV)	1.5 (maximum 2.5 mg)	8,15,22,29
Daunorubicin (IV)	30	8,15,22,29
L-asparaginase (IV) ( <i>E. coli</i> or <i>Erwinia</i> according to randomization)	10,000 U/m <sup>2</sup>	12,15,18,22,25,29,32,35
Methotrexate (IT)	According to age <sup>†</sup>	1,8,22
<b>Consolidation</b>		
Cyclophosphamide (IV)	1 g/m <sup>2</sup>	36 and 63
Cytarabine (IV)	75	38–41, 45–48, 52–55, 59–62
Methotrexate (IT)	According to age <sup>†</sup>	38 and 52
6-Mercaptopurine (orally)	60	36–63
<b>Interval therapy</b>		
<b>Arm A</b>		
6-Mercaptopurine (orally)	25	1–56
Methotrexate (24-hour infusion)	5 g/m <sup>2</sup>	8,22,36,50
Methotrexate (IT)	According to age <sup>†</sup>	9,23,37,51
<b>Arm B</b>		
6-Mercaptopurine (orally)	25	1–56
Methotrexate (24-hour infusion)	5 g/m <sup>2</sup>	8,22,36,50
Methotrexate (IT)	According to age <sup>†</sup>	9,23,37,51
Cytarabine (IV)	1 g/m <sup>2</sup> × 2	8,22,36,50
<b>Intensification</b>		
Dexamethasone (orally)	10	1–21 then tapered over 11 days
Vincristine (IV)	1.5 (maximum 2.5 mg)	8,15,22,29
Doxorubicin (IV)	30	8,15,22,29
L-Asparaginase (IV) ( <i>E. coli</i> or <i>Erwinia</i> according to the first randomization)	10,000 IU/m <sup>2</sup>	8,11,15,18
Cyclophosphamide (IV)	1 g/m <sup>2</sup>	36
6-Thioguanine (orally)	60	36–49
Cytarabine (IV)	75	38–41, 45–48
Methotrexate (IT)	According to age <sup>†</sup>	38
<b>Maintenance (up to 2 years after day 1 of induction)</b>		
<b>Arm M1: 6-Mercaptopurine (orally)</b>		
Methotrexate (orally)	20	Once a week
<b>Arm M2: 6-Mercaptopurine</b>		
Methotrexate (orally)	20	Once a week
6-Mercaptopurine (IV)	1 g/m <sup>2</sup>	Every 4 weeks

\* Unless otherwise indicated, doses are given in milligrams per meters squared.

† Less than 1 year: 6 mg; 1 year; 8 mg; 2 years: 10 mg; 3 years and more: 12 mg.

leukaemic infiltration of the CNS and or when lymphoblasts were identified in a centrifuged sample of cerebrospinal fluid (CSF) in which white blood cell count was >5 cells/ $\mu$ l.

The treatment schedule for IR patients is shown in Table 15.19. Patients in complete remission (CR) after consolidation therapy were randomized to IV HDMTX alone (arm A) or IV HD MTX plus IV HD ARA-C (arm B) for presymptomatic CNS therapy. The total duration of treatment was 2 years.

Outcome measures were disease-free survival (DFS), overall survival (OS) and CNS relapse rate. Analyses were performed on the principle of intention to treat. The median follow-up was 6.5 years.

**Statistics**

Randomization was performed centrally (EORTC data center, Brussels, Belgium) and was stratified according to centre. OS and DFS were calculated according to the Kaplan Meier life table method and SEs of the estimates were obtained by the Greenwood formula. The differences between the curves were tested for statistical significance using the two tailed log rank test or log rank test stratified by a categorical factor. To summarize the overall treatment difference, the hazards ratio [HR] of having an event in the 2 groups was estimated by the Cox's proportional hazards model. The Wilcoxon rank test was used for the treatment comparison regarding the duration of interval therapy.

**Outcome**

Of the 656 patients randomized for presymptomatic CNS therapy, 323 were randomized to arm A (IV HD MTX) and 330 to arm B (IV HD MTX plus IV HD ARA-C). Three patients were excluded from analyses (ineligible-2 and inadequate records - 1). Patient characteristics according to the treatment arm are shown in Table 15.20. Six patients (2%) randomized to arm A, received IV HD ARA-C while 11 patients (3%) randomized to arm B did not receive IV ARA-C. The administered dose of ARA-C could not be verified in nine arm B patients, due to misplaced records.

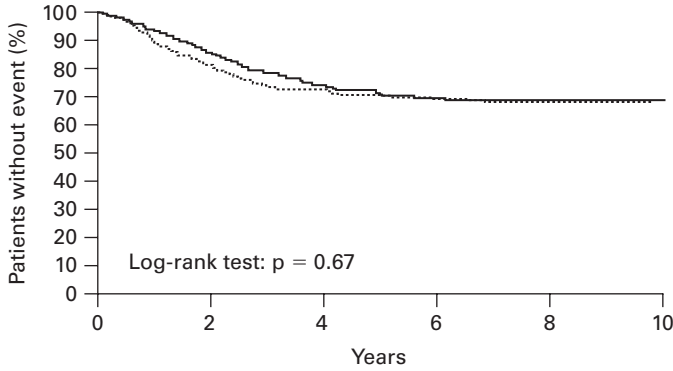
Isolated and combined CNS relapse rates for patients randomized to IV HD MTX (arm A) were 5.6% and 5.3% compared to 3.3% and 4.6% respectively in patients randomized to IV HD MTX plus IV

HD ARA-C [Arm B]. The actuarial 6-year cumulative CNS relapse rate was 12% (SE 1.9%) for patients randomized to arm A and 8.6% (SE 1.6%) for arm B patients (Figure 15.41) while the overall 6-year CNS

**Table 15.20** Patient characteristics according to the randomized arm.

	Arm A (without Ara-C) (n = 323)		Arm B (with Ara-C) (n = 330)	
	Number of Patients	(%)	Number of Patients	(%)
Sex				
Male	190	59	202	58
Female	133	41	144	42
Age				
<1 years	7	2	1	<1
1-9 years	266	82	280	85
10-18 years	50	15	49	15
Disease				
LL	31	10	29	9
ALL	292	90	301	91
All patients only				
WBC				
<25 × 10 <sup>9</sup> /l	160	55	182	61
25-100 × 10 <sup>9</sup> /l	97	33	91	30
≥100 × 10 <sup>9</sup> /l	35	12	28	9
RF				
< 0.8	7	2	12	4
0.8-1.19	157	54	158	52
≥1.2	128	44	131	44
CNS involvement	1	<1	0	0
Immunophenotype				
B lineage	258	88	255	85
T lineage	34	12	46	15
Chromosome findings				
Successful examination*	206	64	219	66
Diploid	69	34	77	36
Pseudodiploid	34	17	57	26
Hypodiploid	8	4	14	7
Hyperdiploid	26	13	19	9
47-50				
Hyperdiploid	65	32	49	23
51-66				
Other	4	2	3	1

\*Percentages were computed for those with a successful cytogenetic examination.

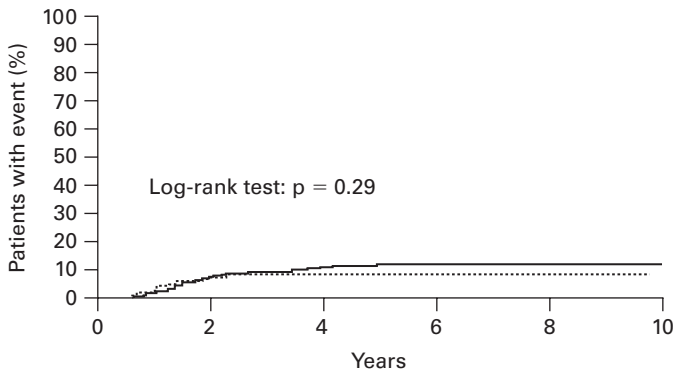


**Figure 15.41** DFS according to arm A or arm B. N: number of patients at risk and O: observed number of events (relapses or deaths in CR). © American Society of Clinical Oncology (full reference on p. 387).

O	N	Number of patients at risk					
93	323	278	233	131	46	—	Arm A
97	330	269	237	137	48	.....	Arm B

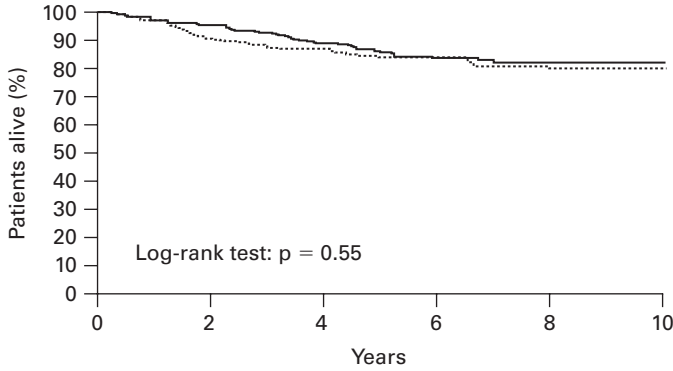
**Table 15.21** Outcome according to the randomized arm.

	Arm A (without Ara-C) (n = 323)		Arm B (with Ara-C) (n = 330)	
	Number of Patients	(%)	Number of Patients	(%)
Continuous CR	230	71.2	233	70.6
Death in CR	3	0.9	10	3.0
Relapse	90	27.9	87	26.4
Bone marrow, isolated	40	12.4	47	14.3
CNS, isolated	18	5.6	11	3.3
CNS, combined	17	5.3	15	4.6
Other isolated	10	3.1	7	2.1
Other combined	5	2.0	7	2.1



**Figure 15.42** Cumulative risk of CNS relapse according to arms A and B. N: number of patients at risk and O: observed number of events (CNS relapse, either isolated or combined with other sites). © American Society of Clinical Oncology (full reference on p. 387).

O	N	Number of patients at risk					
35	323	278	233	131	46	—	Arm A
26	330	269	237	137	48	.....	Arm B



**Figure 15.43** Survival according to arm A or arm B. N: number of patients at risk and O: observed number of deaths, whatever the cause. © American Society of Clinical Oncology (full reference on p. 387).

O	N	Number of patients at risk					
52	323	306	278	160	60	—	Arm A
58	330	298	280	167	60	.....	Arm B

**Table 15.22** Toxic side effects (WHO grading) reported during the interval therapy\* according to the randomized arm.

	Arm A (without Ara-C) (n = 311)		Arm B (with Ara-C) (n = 315)	
	Number of Patients	(%)	Number of Patients	(%)
<b>Infection</b>				
Grade 1–2	72	23	87	28
Grade 3–4	8	3	14	4
<b>Increase of transaminases</b>				
Grade 1–2	95	30	105	37
Grade 3–4	6	2	12	4
<b>Neurotoxicity</b>				
Grade 1–2	17	5	18	6
Grade 3–4	3	1	0	0
<b>Increase of creatinine</b>				
Grade 1–2	55	18	63	20
Grade 3–4	4	1	3	1

\* Patients with the documented forms received were included in this analysis.

relapse rates were 10.8% (SE 1.3%) and 5.6% (2.8%) respectively.

Isolated bone marrow relapses were similar in both arms (12.4% arm A versus 14.3% arm B) (Table 15.21)

Six-year DFS was 70.4% (SE 2.6%) and 71% (SE 2.5%) for patients randomized to arm A and arm B respectively (Figure 15.42) (log-rank test,  $p = 0.67$ ). The estimated hazards ratio was 1.06 (95% CI,

0.8–1.41). The 6-year OS was almost identical in both arms (Figure 15.43).

**Toxicity**

The toxic adverse effects in the two treatment arms are shown in Table 15.22. The dose of ARA-C was reduced in 28 courses (16 patients) due to hematological toxicity. The duration of the CNS prophylactic phase

(interval therapy) was statistically longer for patients randomized to arm B compared to arm A (Wilcoxon test,  $p = 0.0001$ ).

There were six deaths in arm A (three due to treatment related toxicity and infections, one each during CNS prophylaxis, intensification and maintenance phases) compared to 20 in arm B (10 due to treatment related toxicity and infections, 3 during intensification and 7 during maintenance therapy).

## Conclusion

It was concluded that the addition of IV HD ARA-C to IV HD MTX did not significantly reduce the incidence of CNS relapse or improve DFS in patients with intermediate/increased risk ALL.

## Study 26

Yousif Matloub, Susan Lindemulder, Paul S. Gaynon, Harland Sather, Mei La, Emmett Broxson, Rochelle Yanofsky, Raymond Hutchinson, Nyla A. Heerema, James Nachman, Marilyn Blake, Linda M. Wells, April D. Sorrell, Margaret Masterson, John F. Kelleher, and Linda C. Stork. Intrathecal triple therapy decreases central nervous system relapse but fails to improve event-free survival when compared with intrathecal methotrexate: results of the Children's Cancer Group (CCG) 1952 study for standard-risk acute lymphoblastic leukemia, reported by the Children's Oncology Group. *Blood* 2006; **108**:1165–73.

### Study details

The Children's Cancer Group (CCG) 1952 trial was a randomized prospective multi-center study that ran from May 1996 till February 2000.

### Objectives

The study had two aims:

- To compare the efficacy of presymptomatic triple drug intrathecal (ITT) chemotherapy (cytarabine (ARA-C), methotrexate (MTX) and hydrocortisone sodium succinate (HSS)) against IT MTX alone in reducing the incidence of central nervous system (CNS) relapses in children with standard risk acute lymphoblastic leukemia (SR-ALL).
- To determine whether the 6-thioguanine was more efficacious than 6-mercaptopurine during ALL maintenance therapy.

This report focuses on the IT comparison alone.

### Study details

Children with previously untreated SR-ALL were eligible for inclusion in this study. Patients were considered to have SR-ALL if they were between the ages of 1 and 10 years and had a presenting white blood cell (WBC) count below  $50 \times 10^9/l$  (National Institute of Cancer SR-ALL criteria). All patients with L3 morphology or with t (8; 14), t (2; 8) or t (8; 22) were ineligible for study entry. Additionally, patients who received treatment with corticosteroids for more than 48 hours during the previous month were also ineligible for the study.

### Treatment schedule

SR-ALL patients received a remission induction therapy with one dose of IT ARA-C, intravenous vincristine (IV VCR), oral prednisolone (PDN), intramuscular native *E. coli* asparaginase (*E. coli* ASPN) and two doses of IT MTX as shown in Table 15.23. Patients with CNS-1 (CSF WBC count  $<5$  cells/ $\mu$ l without lymphoblasts) or CNS-2 (CSF WBC count  $<5$  cells/ $\mu$ l with lymphoblasts on a centrifuge preparation) or traumatic taps received identical systemic and IT therapy. Patients were considered to have CNS leukemia (CNS-3) if they had neurological symptoms such as facial nerve palsy or hypothalamic syndrome secondary to leukemic infiltration of the CNS or when lymphoblasts were identified in a centrifuged sample of cerebrospinal fluid (CSF) in which WBC count were  $>5$  cells. If the patient had circulating lymphoblasts in the peripheral blood and also had a traumatic spinal tap that contained a least 5 white cells/ $\mu$ l with lymphoblasts, then the patient was considered to have CNS infiltrative disease if the CSF WBC/RBC ratio was greater than the peripheral blood WBC/RBC ratio (CNS-3). The spinal tap was defined as traumatic if the CSF had a red blood cell (RBC) count of at least 10/ $\mu$ l with lymphoblasts but not meeting

**Table 15.23** Details of treatment for the randomized regimens.

Phase and drug	Dose	Schedule
Induction, 4 weeks		
IT cytarabine	Age-adjusted <sup>†</sup>	Day 0
Vincristine	1.5 mg/m <sup>2</sup> (2 mg maximum)	Days 0, 7, 14, 21
Asparaginase <sup>‡</sup>	6000 U/m <sup>2</sup>	M, W, F × 9 doses
Prednisone	40 mg/m <sup>2</sup> /day	Days 0–27
IT MTX	Age-adjusted <sup>†</sup>	Days 7, 28
Consolidation, 4 week		
Vincristine	1.5 mg/m <sup>2</sup> (2 mg maximum)	Day 0
Prednisone	Taper	Days 0–10
Mercaptopurine or Thioguanine <sup>§</sup>	75 mg/m <sup>2</sup> /day 50 or 60 mg/m <sup>2</sup> /day	Days 1–27
IT MTX or ITT	Age-adjusted <sup>†</sup> Age-adjusted <sup>†</sup>	Days 7, 14, 21 Days 7, 14, 21
IM no. 1, 8 week		
Vincristine	1.5 mg/m <sup>2</sup> (2 mg maximum)	Days 0, 28
Prednisone	40 mg/m <sup>2</sup> /day	Days 0–4, 28–32
Mercaptopurine or Thioguanine <sup>§</sup>	75 mg/m <sup>2</sup> /day 50 or 60 mg/m <sup>2</sup> /day	Days 0–49
MTX	20 mg/m <sup>2</sup> /day	Weekly × 8 doses
DI no. 1, 8 week		
Vincristine	1.5 mg/m <sup>2</sup> (2 mg maximum)	Days 0, 7, 14
Asparaginase <sup>‡</sup>	6000 U/m <sup>2</sup>	M, W, F × 6 doses
Dexamethasone	10 mg/m <sup>2</sup> /day	Days 0–6, 14–20
Doxorubicin	25 mg/m <sup>2</sup> /day	Days 0, 7, 14
Cytarabine	75 mg/m <sup>2</sup> /day	Days 28–31, 35–38
Cyclophosphamide	1000 mg/m <sup>2</sup>	Day 28
Thioguanine	60 mg/m <sup>2</sup> /day	Days 28–41
IT MTX or ITT	Age-adjusted <sup>†</sup> Age-adjusted <sup>†</sup>	Days 0, 28, 35 Days 0, 28, 35
IM no. 2, 8 week		
As in “IM no. 1”	–	–
DI no. 2, 8 week		
As in “DI no. 1”	–	–
Maintenance,*		
12-week cycles		
Vincristine	1.5 mg/m <sup>2</sup> (2 mg maximum)	Days 0, 28, 56
Prednisone	40 mg/m <sup>2</sup> /day	Days 0–4, 28–32, 56–60
Mercaptopurine or Thioguanine <sup>§</sup>	75 mg/m <sup>2</sup> /day 50 or 60 mg/m <sup>2</sup> /day	Daily
MTX (oral)	20 mg/m <sup>2</sup> /dose	Weekly
IT MTX or ITT	Age-adjusted <sup>†</sup> Age-adjusted <sup>†</sup>	Day 0 Day 0

\* Total duration of treatment for boys was 38 months, for girls, 26 months.

<sup>†</sup> Intrathecal; see Table 15.24 for dosing.

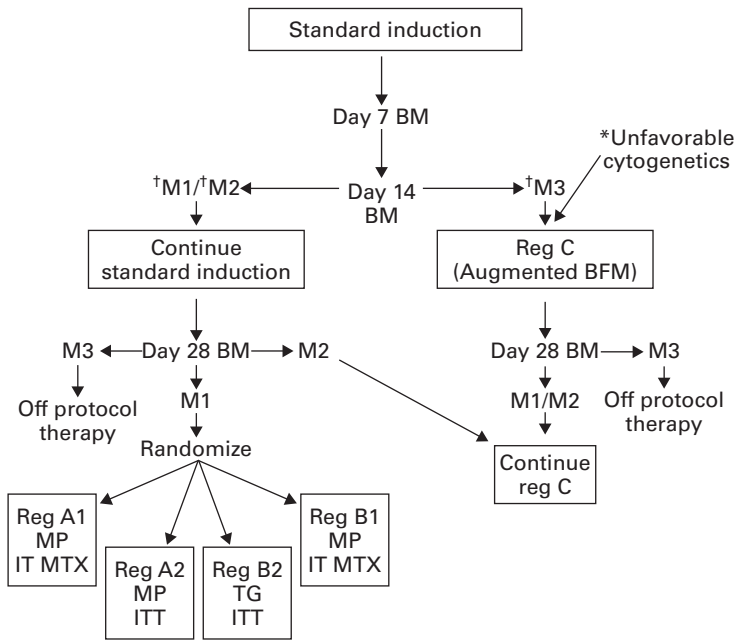
<sup>‡</sup> Asparaginase preparation: *E. coli* (Elspar; Merck, Whitehouse Station, NJ); Erwinia asparaginase replaced Elspar following severe allergic reactions.

<sup>§</sup> The 100% targeted dose of thioguanine was changed from 60 to 50 mg/m<sup>2</sup>/day in February 1998.

IM: Interim maintenance

DI: delayed intensification





**Figure 15.44** CCG 1952 treatment schema.\*t (9; 22) (q34; q11), t (4;11) (q21; q23) or hypodiploidy with fewer than 45 chromosomes. †See “treatment protocol” for definitions. Reproduced with permission of the American Society of Hematology (full reference on p. 392).

the CNS-3 criteria. Children with overt CNS disease received 24 Gy cranial [CRT] and 6 Gy spinal irradiation (SRT) during the consolidation phase of treatment while patients with testicular disease received 24 Gy testicular RT. All patients received two blocks of delayed intensification. Details of each phase of treatment are shown in Table 15.23.

Only patients who achieved M1 (<5% blasts) or M2 (5–25% blasts) bone marrow (BM) status by day 14, complete remission (CR) at the end of induction on day 28, and had no unfavourable cytogenetics such as hypodiploidy (<45 chromosomes), t (9; 22) or t (4; 11) were eligible for randomization. Randomization was performed centrally at the CCG statistical office in 2 × 2 factorial design to one of four treatment regimens (regimen A1: oral 6-mercaptopurine (6-MP) and IT MTX; regimen A2: oral 6-MP and ITT regimen B1: oral 6-thioguanine (6-TG) and IT MTX and regimen B2: oral 6-TG and ITT) as shown in Figure 15.44. Intrathecal chemotherapy (IT CT) dosing was according to age as shown in Table 15.24. The total duration of treatment for girls and boys was 2 and 3 years respectively from the start of interim maintenance.

**Statistics**

Sample size and power calculations for this study were based on expected long-term EFS plateau of 80% and

**Table 15.24** Intrathecal therapy.

	Age			
	Less Than 2 Years	2 Years	3–8 Years	More Than 8 Years
IT MTX (mg)	8	10	12	12
ITT				
MTX (mg)	8	10	12	15
Cytarabine (mg)	16	20	24	30
HSS (mg)	8	10	12	15

a freedom of CNS relapse rate of 94% in the control regimens of the 2 × 2 factorial design. Initial accrual was planned for 3 years with approximately 564 patients randomized each year. An accrual of 1692 patients was intended to have a power in excess of 80% (two sided log-rank test) to detect an improvement to 87.5% EFS (relative hazard risk, RHR = 0.5984) in half of the patients and an 86% power to detect an improvement of 97% freedom from CNS relapse (RHR = 0.4923) in half of the patients. The analysis of treatment effects of the main factors (IT MTX versus ITT) employed a stratified life table analysis giving a type of pooled

results across the strata. Additionally statistical tests of the interaction of the IT regimens with systemic chemotherapy were performed using a Cox regression test.<sup>1,2</sup> As fewer events occurred than expected on the control regimens by the middle of 1999, the data monitoring committee (DMC) extended the accrual for 6 additional months and 300 patients to ensure at least 80% power for the EFS comparisons.

Analysis of isolated CNS (iCNS) relapse rate was performed using a cumulative incidence function.<sup>3</sup> Event-free survival (EFS) and overall survival (OS) were estimated by the Kaplan and Meier (KM) life table method. EFS and OS comparisons began at the time of randomization when patients were in CR1. Patients who were lost for follow-up were censored at the date of their last contact. The standard deviation of the KM estimates was calculated according to the Peto variance formula.<sup>4</sup> Relative hazard risks (RHRs) were estimated by the log-rank method of observed divided by expected (O/E) events.  $\chi^2$  tests for homogeneity of distributions were used in some comparisons and multivariate analysis of prognostic factors was performed with the Cox proportional hazards model.<sup>5</sup> Once the study was opened to accrual, regular interim analyses were performed by the independent Children's Cancer Group Data Monitoring Committee using a Lan DeMets spending function approach.<sup>6</sup> In the present report, iCNS relapse; EFS and OS are presented as percent  $\pm$  standard error (SE).

### Outcome end points

Outcome measures included iCNS relapse rate, EFS and OS. All analyses were performed on the principle of intention to treat. The median follow-up from randomization was 6 years for patients alive in continuous remission.

### Results

Of the 2185 patients enrolled on the study CCG 1952, only 2027 were considered eligible for IT CT randomization. Ten patients were ineligible prior to randomization (misdiagnosis-5, inadequate institutional review-3, prolonged steroid exposure-1 and late registration-1) and a further 145 were excluded from randomization due to induction deaths, M3 BM on day 14, unfavourable cytogenetics or refused further study participation. In addition three further patients were excluded after

randomization due to improper consent, omission of day 14 BM assessment and inaccurate day 14 BM assessment. One thousand and eighteen patients were randomized to receive IT MTX and the remaining 1009 were randomized to ITT; 91% of the randomized

**Table 15.25** Presenting features and blast characteristics.

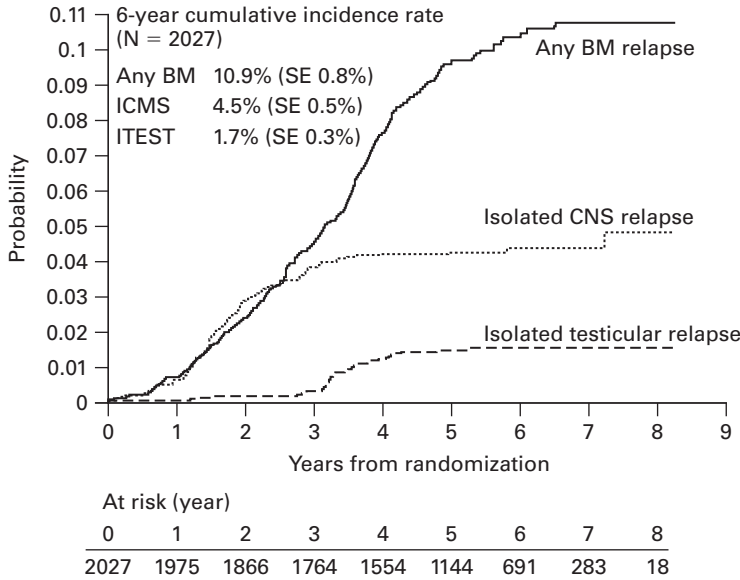
	IT MTX, (%)	ITT, (%)	Total, (%)	p
Age				0.69
Less than 2 years	9	8	8	
2–5 years	69	69	69	
6–9 years	22	23	23	
Sex				0.86
Female	44	44	44	
Male	56	56	56	
Ethnicity				0.66
White	68.6	67.2	67.9	
Black	3.9	3.2	3.6	
Hispanic	20.8	23	21.9	
Asian	1.6	1.3	1.4	
Other	5.1	5.4	5.2	
Down syndrome	3.2	2.4	2.8	0.24
CNS status				0.64
CNS-1	93.2	92.1	92.6	
CNS-2	5.4	6.1	5.7	
CNS-3	1.4	1.8	1.6	
TLP+	2	2.5	2.3	
WBC count		82		
Less than $20 \times 10^9/l$	83	81	18	
$20 \times 10^9/l$ or above	17	19		
Immunophenotype			94.7	0.63
B lineage	94.5	95	5.3	
T lineage	5.5	5		
Triple trisomies*				0.66
Yes	14.2	13.2	13.7	
No	85.6	86.8	86.3	
TEL/AML1†				0.47
Yes	19.2	21.1	20.1	
No	80.8	78.9	79.9	
BM day 7				0.07
M1	49.4	46.7	48	
M2	28.2	26.4	27.3	
M3	22.4	26.9	24.7	
BM day 14				0.09
M1‡	92.1	90	91.1	
M2	7.9	10	8.9	

For IT MTX, n = 1018; for ITT, n = 1009; and for total, n = 2027, TLP: traumatic lumbar puncture

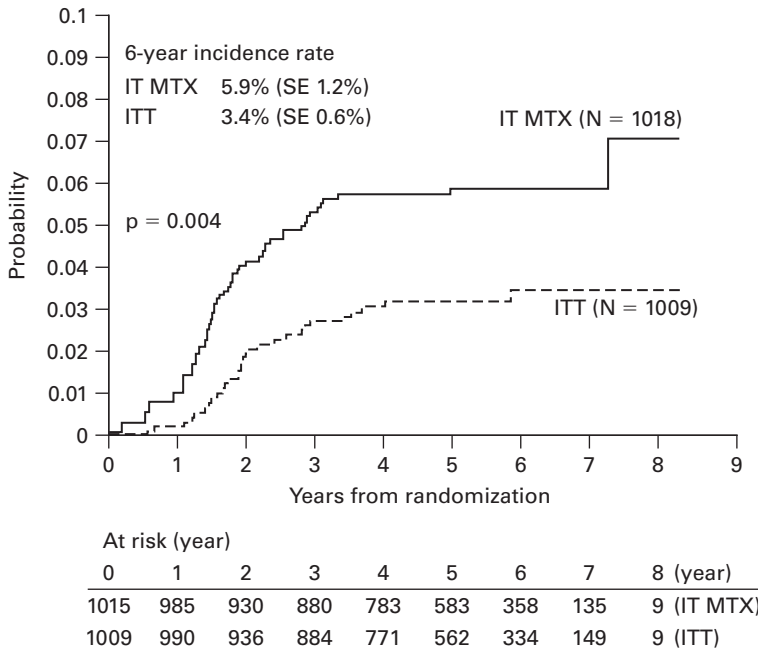
\* 881 cases with centrally approved cytogenetics.

† 940 cases analyzed for TEL/AML1.

‡ Includes day 7 M1.



**Figure 15.45** Incidence of marrow and extramedullary relapses. Reproduced with permission of the American Society of Hematology (full reference on p. 392).

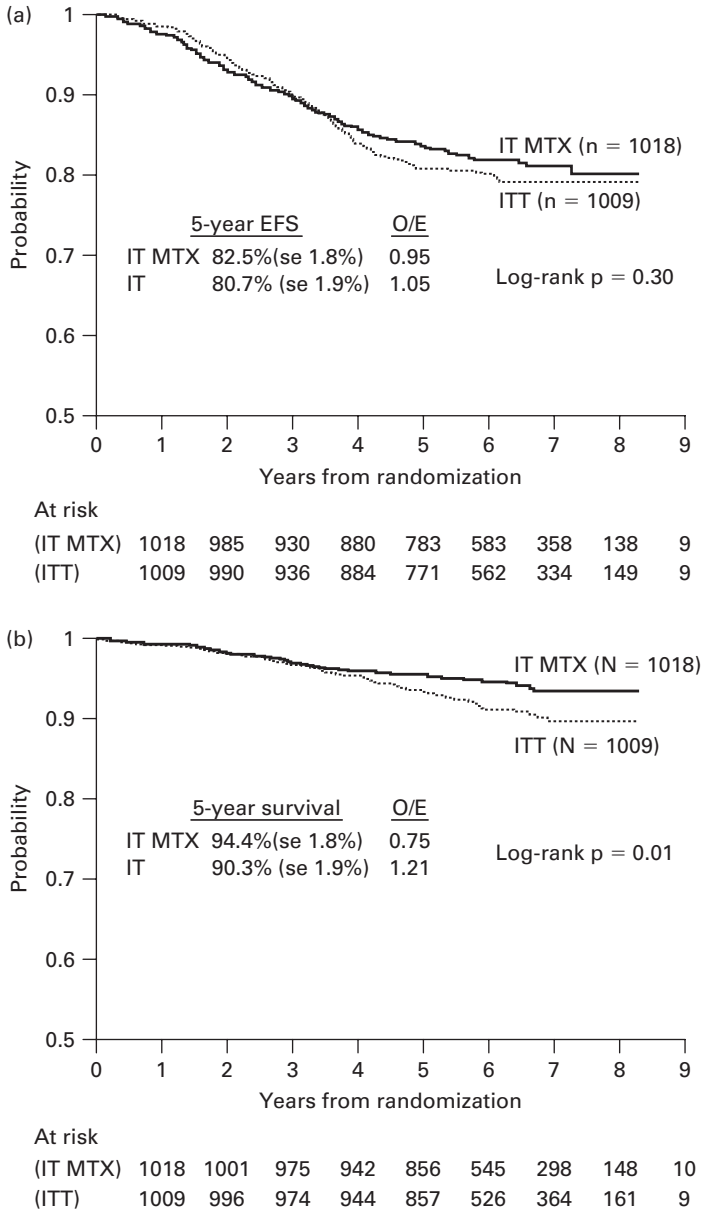


**Figure 15.46** Cumulative incidence estimates of iCNS relapse. Reproduced with permission of the American Society of Hematology (full reference on p. 392).

patients achieved M1 BM status at day 14 and the rest were M2. Patient characteristics including clonal molecular genetics are shown in Table 15.25. As seen in Table 15.25, more slow responders received IT TCT; 82 randomized patients have been lost for follow-up (IT MTX-40 and IT-TCT-42).

**Outcome**

The 6-year EFS for the entire cohort of 1027 patients was  $81.6 \pm 1.3\%$  while the OS was  $92.3 \pm 0.9\%$ . The 6-year overall iCNS relapse rate and BM relapse rates (including combined relapses) were  $4.9 \pm 0.8\%$  and  $7.7 \pm 1.1\%$  respectively. Most of the iCNS relapses

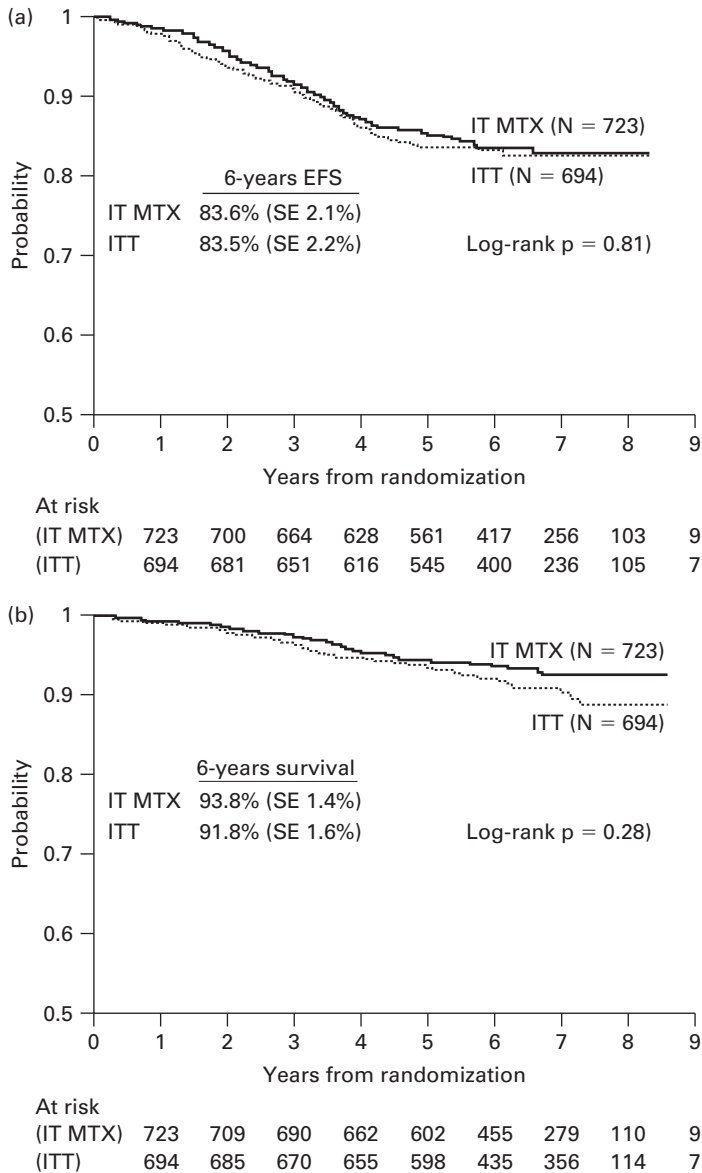


**Figure 15.47** Survival. (a) EFS and (b) OS. Reproduced with permission of the American Society of Hematology (full reference on p. 392).

occurred within the first 3 years from diagnosis (Figure 15.45). The 6-year isolated testicular relapse rate for the entire cohort was 3.4%.

Isolated CNS relapses were significantly higher in the IT MTX group (n = 58) than in the ITT (n = 31) group (p = 0.004; RHR = 0.53). The 6-year cumulative estimate of iCNS relapses were 5.9 ± 1.2% and 3.4 ± 1.0% in the IT MTX and ITT groups respectively (Figure 15.46); 40.4% of all iCNS relapses

occurred within 18 months of achieving remission. In fact, more early iCNS relapses were seen in the IT MTX group than in the ITT group (46.6% versus 29%; p = 0.083,  $\chi^2$ ). In contrast, patients who were randomized to receive ITT had a higher BM relapse rate (n = 117; 22 BM + CNS, 7 BM + other extramedullary sites and 88 BM only) than those randomized to receive IT MTX (n = 79; 21 BM + CNS, 4 BM + other extramedullary sites, 54 BM only).



**Figure 15.48** Survival of redefined SR-ALL subset. (a) EFS and (b) OS. See “outcome analyses among subsets” for definitions. Reproduced with permission of the American Society of Hematology (full reference on p. 392).

Moreover, the number of non-CNS extramedullary relapses was nearly double in the ITT group than in the IT MTX group (20 versus 11). In total, the number of all relapses was higher in the group randomized to receive ITT than in the IT MTX group (174 versus 151).

The 6-year EFS for the ITT and IT MTX groups were  $80.7 \pm 1.9\%$  and  $82.5 \pm 1.8\%$  ( $p = 0.3$ , log rank, Figure 15.47a) respectively while the 6-year OS was  $90.3 \pm 1.5\%$  and  $94.4 \pm 1.1\%$  ( $p = 0.01$ , log rank,

Figure 15.47b) respectively. The relative death rate was 1.5 times higher in the group randomized to receive ITT. As randomization resulted in a higher proportion of patients with slow early response randomized to receive an adjusted (adjustment for day 7 and day 14 BM status) analyses for OS was performed for the two groups of patients. This adjusted OS was no different from the unadjusted analyses (day 7 BM: adjusted  $p = 0.03$ , RHR = 0.68 and day 14 BM: adjusted  $p = 0.02$ , RHR = 0.67). Similarly, adjusted analyses for the BM

**Table 15.26** Episodes of grade 3–4 CNS toxicity.

Phase	IT MTX, (%)	ITT, (%)
Consolidation/IM no. 1	1.0	0.9
DI no. 1	1.9	1.6
IM no. 2	0.2	0.3
DI no. 2*	0.9	2.1
Maintenance		
Course 1	0.5	0.4
Courses 2–10†	1.3	1.4
Total	5.8	6.7

The total number of patients per phase ranged from 973 to 1018 for IT MTX and 969 to 1009 for ITT.

\* $p = 0.025$ ,  $\chi^2$ ; all other comparisons are non-significant.

†No girls after course 6.

relapses showed a significant excess of BM relapses in the group randomized to receive ITT.

ITT significantly reduced the cumulative incidence of iCNS relapses in the CNS-2 cohort ( $n = 113$ ) than in the CNS-1 cohort ( $n = 1827$ ) when compared with IT MTX. The 6-year cumulative iCNS relapse rate in CNS-2 patients was  $7.7 \pm 5.3\%$  versus  $23.0 \pm 9.5\%$  (RHR = 0.2,  $p = 0.004$ , log rank) while the iCNS relapse rate in CNS-1 patients was  $3.1 \pm 1.0\%$  versus  $5.1 \pm 1.2\%$  (RHR = 0.59,  $p = 0.03$ , log rank) respectively. However, this reduction in iCNS relapses with ITT in the CNS-2 cohort was not reflected as either a significantly improved EFS or OS. The 6-year EFS was 76% versus 66% ( $p = 0.12$ ) and OS was 89% versus 92% ( $p = 0.3$ ) for the ITT and IT MTX arms respectively.

Though iCNS relapses were not significantly different between patients with day 14 M2 BM in the two IT groups ( $p = 0.12$ , log rank), the 6-year EFS was worse in the ITT group than the IT MTX group ( $58.9 \pm 8.4\%$  versus  $75.4 \pm 8.6\%$ ;  $p = 0.05$ ) because of an excess of BM relapses in the ITT group (28 versus 8). The 6-year OS was also worse in the ITT group with M2 BM ( $76.7 \pm 7.6\%$  versus  $97.4 \pm 3.0\%$ ;  $p = 0.002$ , RHR = 5.3).

Figure 15.48 shows the EFS and OS in the currently defined group of pre-cursor B SR-ALL patients (excluding patients with T cell disease, day 14 M2 BM, CNS-3 and testicular disease) with rapid early BM response ( $n = 1417$ ). The iCNS relapse rate was  $4.8 \pm 1.3\%$  in

the IT MTX group ( $n = 723$ ) compared to  $3.3 \pm 1.1\%$  in the ITT group ( $n = 694$ ). The estimated 6-year EFS and OS in the redefined SR-ALL patients randomized to receive IT MTX or ITT groups was  $83.6 \pm 2.1\%$  versus  $83.5 \pm 2.2\%$  ( $p = 0.81$ , log rank; RHR = 0.96) and  $93.8 \pm 1.4\%$  versus  $91.7 \pm 1.6\%$  ( $p = 0.28$ , log rank; RHR = 0.8) respectively.

## Toxicity

Table 15.26 shows the episodes of grades 3 and 4 within each phase of treatment in the two groups. Grade 3 or 4 CNS toxicity occurred in 5.8% of patients randomized to IT MTX compared to 6.7% for ITT group. There were in total 64 toxic CNS events and included seizures-23, hemiplegias-19, severe ataxias-9, facial nerve palsy-4, Guillain Barre like weakness-3 and other neurotoxicities-6. All patients survived the toxic event although a few had residual impairments. Ten patients received no further IT CT after the adverse event. The incidences of non-CNS grade 3 or 4 toxicities were also similar in the two IT regimens.

## Conclusion

It was concluded that although presymptomatic treatment with ITT significantly reduced the incidence of isolated CNS relapses, it did not improve overall survival outcome due to a higher incidence of bone marrow relapses in this group.

## References

- 1 Simon R. Patient subsets and variation in therapeutic efficacy. *Br J Clin Pharmacol* 1982;14:473–82.
- 2 Xiang AH, Sather HN, Azen SP. Power considerations for testing an interaction in a  $2 \times k$  factorial design with a failure time outcome. *Control Clin Trials* 1994;15:489–502.
- 3 Kalbfleisch JD, Prentice RL. *The Statistical Analysis of Failure Time Data*. New York, NY, John Wiley and Sons, 1980.
- 4 Peto R, Pike MC, Armitage P, Breslow NE, Cox DR, Howard SV, Mantel N, McPherson K, Peto J, Smith PG. Design and analysis of randomized clinical trials requiring prolonged observation of each patient. II. Analysis and examples. *Br J Cancer* 1977;35:1–39.
- 5 Cox DR. Regression models and life tables. *J R Stat Soc B* 1972;34:187–220.
- 6 DeMets D, Lan G. Interim analysis; the alpha spending function approach. *Stat Med* 1994;13:1341–52.

## CHAPTER 16

# Continuing therapy in childhood lymphoblastic leukemia – duration of continuing therapy

### Study 1

The Medical Research Council's Working Party on Leukaemia in Childhood. Duration of chemotherapy in childhood acute lymphoblastic leukaemia. *Med Paediatr Oncol* 1982; 10:511–20.

### Study design

This report analyzes the results of the first three multi-center UKALL (I, II and III) randomized trials and describes the differences in remission duration and survival in the three trials. Details regarding the exact period when each trial was conducted are not mentioned.

### Objectives

The primary objective of this analysis was:

- To determine the minimal effective length of maintenance therapy for children with acute lymphoblastic leukemia.

### Details of the study

Criteria for enrollment onto the three UKALL trials were not specified. In UKALL-III patients were categorized into standard risk (age 1–13 years, WBC  $<20 \times 10^9/l$ ) or high risk ( $>14$  years or WBC  $>20 \times 10^9/l$ ) according to age and WBC count at diagnosis.

Chemotherapy protocol details for any of the three trials are not given in the report (detailed reports *Br Med J* 1977;2:495 and *Br Med J* 1978;2:787). The only substantial difference between these trials during

the first 12 weeks of therapy was in the dosage and timing of asparaginase, which was given for 4 weeks daily from weeks 7 until 11 at  $6000 \text{ U/m}^2$  IV in UKALL-I, and at  $10,000 \text{ U/m}^2$  for four doses over 8 days during weeks 1, 4 or 5 in the subsequent trials. However, in all three of the trials, patients who completed the shorter period of treatment (84 weeks in UKALL-I, 108 weeks in UKALL-II and -III) and were still in first remission were then randomized either to stop or continue treatment up to a total of 156 weeks.

Analyses of allocated duration of therapy were restricted to patients who were in first remission and on chemotherapy at 80 weeks (UKALL-I) or 104 weeks (UKALL-II and -III). These cut off points (4 weeks before the randomization) were chosen because randomizations were performed in advance and a few patients stopped treatment early.

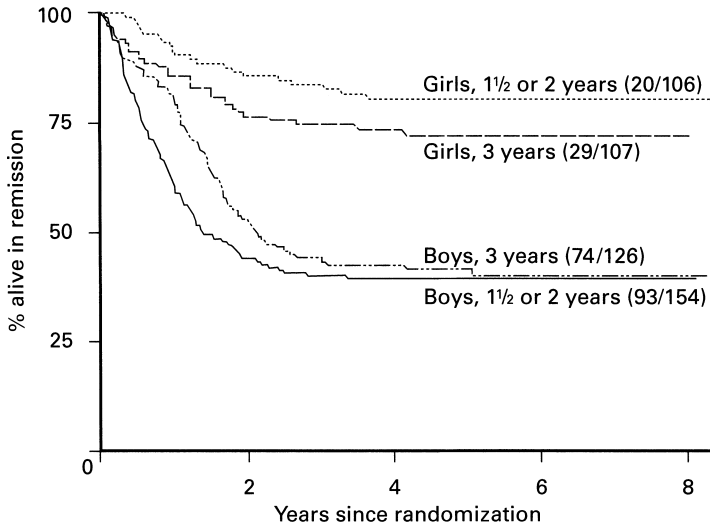
Outcome measures were disease-free survival (DFS), testicular relapse rate and non-testicular relapse rate.

Methodology of randomization is not detailed in the report for any of the three trials.

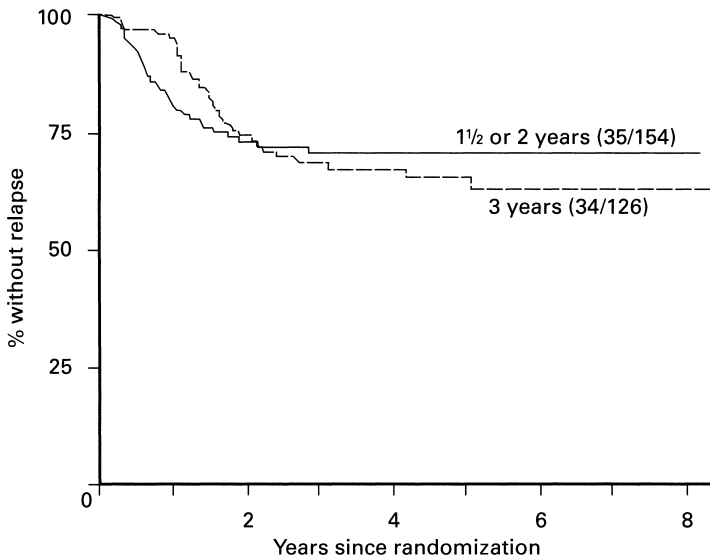
### Outcome

The numbers of patients enrolled in each of the three trials is not specified nor are details of actual numbers of patients in each trial who were randomized to stop or continue treatment specified.

For boys, the relapse rate increased with stopping treatment ( $p < 0.001$ ) whereas in girls it was non-significantly lower when treatment was discontinued. The 5-year DFS after randomization to stop or continue



**Figure 16.1** DFS according to sex and allocation to stop or continue treatment, from the time of randomization to stop or continue. Reprinted with permission of Wiley-Liss, Inc., a subsidiary of John Wiley & Sons, Inc. (full reference on p. 400).



**Figure 16.2** Testicular relapse as a first event, according to allocation to stop or continue treatment. Reprinted with permission of Wiley-Liss, Inc., a subsidiary of John Wiley & Sons, Inc. (full reference on p. 400).

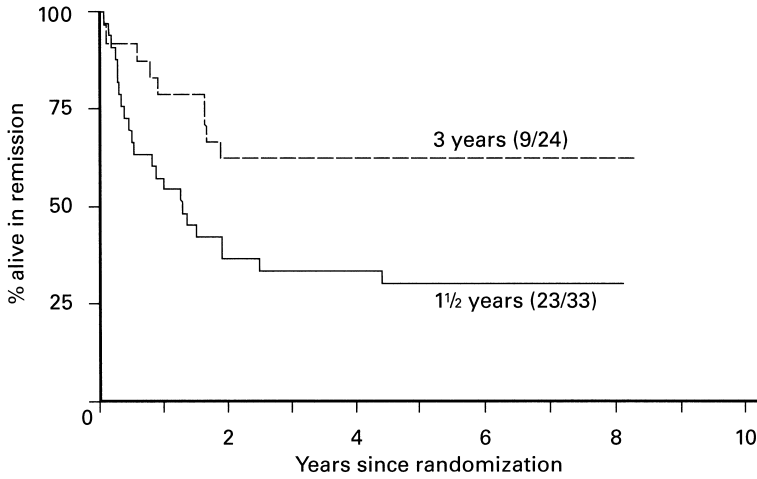
treatment was 76% for girls compared with 40% in boys (Figure 16.1). This difference appeared only after stopping treatment. The DFS rate 2 years after the start of treatment for patients in remission at 12 weeks was 64% for boys versus 70% for girls (UKALL-I patients censored at 84 weeks).

Testicular relapse was initially significantly higher in those allocated to stop treatment ( $p < 0.001$ ) but a similar incidence occurred among those who stopped treatment after 3 years (Figure 16.2). Eventual cumulative incidence was slightly higher in the longer treatment group.

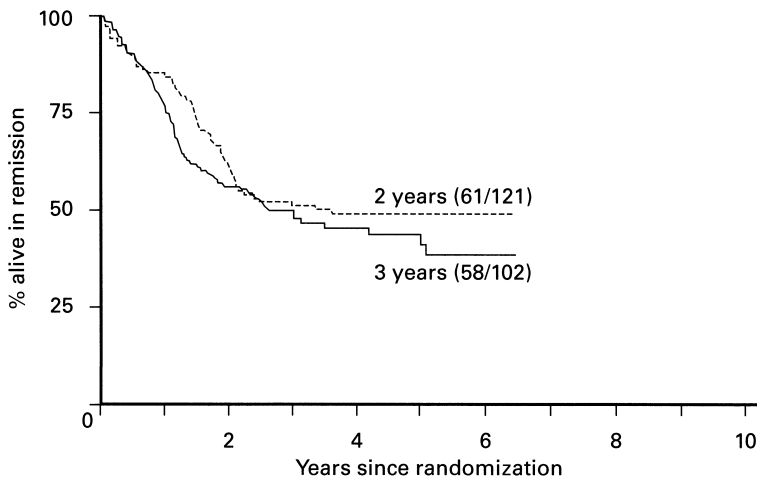
Non-testicular relapse was higher in boys in UKALL-I who were randomized to stop treatment at 84 weeks compared to those who continued treatment ( $p = 0.02$ ) (Figure 16.3). DFS 5 years after randomization was 31% and 63%, respectively. No significant differences in non-testicular recurrences in relation to duration of treatment were observed in either the UKALL-II or -III trial (Figure 16.4).

The relapse rate for boys in UKALL-II and -III intensive was lower in those randomized to the shorter maintenance arm (Figure 16.5;  $p = 0.02$ ) and additionally relapse rate beyond 2 years after diagnosis was unrelated

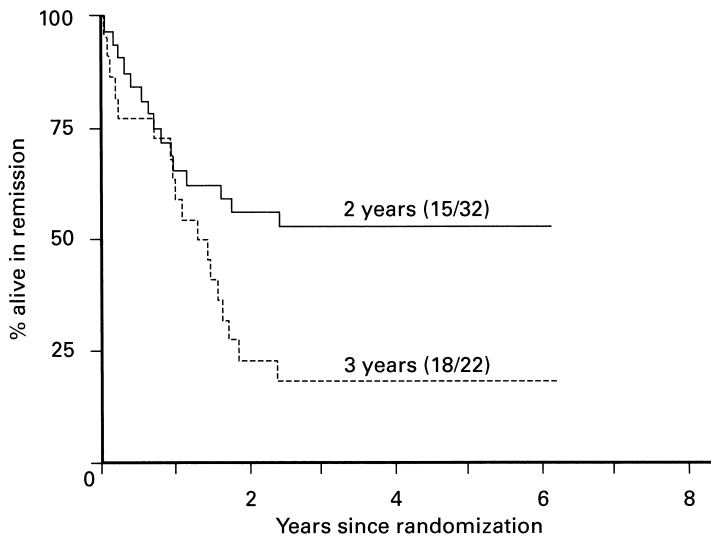




**Figure 16.3** DFS for UKALL-I males, ignoring testicular recurrence, according to allocation to stop or continue maintenance. Reprinted with permission of Wiley-Liss, Inc., a subsidiary of John Wiley & Sons, Inc. (full reference on p. 400).



**Figure 16.4** DFS for males in UKALL-II and -III combined, ignoring testicular recurrence, according to allocation to stop or continue maintenance. Reprinted with permission of Wiley-Liss, Inc., a subsidiary of John Wiley & Sons, Inc. (full reference on p. 400).



**Figure 16.5** DFS according to allocated treatment duration (including testicular relapse) among poor prognosis males, UKALL-II and -III intensive. Reprinted with permission of Wiley-Liss, Inc., a subsidiary of John Wiley & Sons, Inc. (full reference on p. 400).

**Table 16.1** Site of first relapse following treatment allocation to stop at 1½ or 2 years (S) or continue to 3 years (C)<sup>a</sup>.

Trial	Sex	S/C	Site of First Relapse			Death in Remission	No. of Patients Randomised to S/C
			Marrow	CNS not Marrow	Isolated Testicular		
No CNS prophylaxis	M	S	7	4 (4)	0	0	13
	M	C	3	4 (0)	0	0	12
UKALL-I only	F	S	2	0 (0)	–	0	8
	F	C	1	6 (1)	–	0	14
CNS Prophylaxis	M	S	46	4 (2)	31 (18)	0	141
UKALL-I, -II, and -III	M	C	35	7 (4)	22 (11)	2	113
	F	S	17	1 (0)	–	0	97
	F	C	19	1 (1)	–	3	95

<sup>a</sup>First relapses in bone marrow are listed as such, irrespective of involvement of other sites, and coincident CNS and testicular relapses are listed as CNS. The numbers of patients who suffered CNS or testicular relapse without marrow involvement but suffered a later marrow relapse are shown in parentheses.

to the prognostic category in both sexes (O/E, standard risk; high risk was 120/125.9: 40/34.1 for boys and 43/43.7: 9/8.3 for girls; combined  $p = 0.26$ ).

Relapses and deaths that occurred after randomization to stop or continue treatment are shown in Table 16.1.

Among girls, there was no significant difference in relation to duration of treatment within any trial or in any comparison of overall results between trials.

### Conclusion

It was concluded that 18 months or 2 years of maintenance treatment was as effective as 3 years of treatment for girls, but for boys 18 months was inferior to 3 years of treatment, although there was no significant difference between 2 or 3 years of treatment.

### Comment

See also Chapter 16, Study 11 (Henze *et al.*) which demonstrates the equivalence of 2 years versus 2.5 years of therapy.

## Study 2

Nesbitt Jr ME, Sather HN, Robison LL, Ortega JA, Denman Hammond G and the Children's Cancer Study Group. Randomised study of 3 years versus 5 years of chemotherapy in childhood acute lymphoblastic leukaemia. *J Clin Oncol* 1983;1:308–16.

### Study design

CCG-101 and CCG-143 were prospective randomized multicenter trials that were conducted between June 1972 and February 1975.

### Objectives

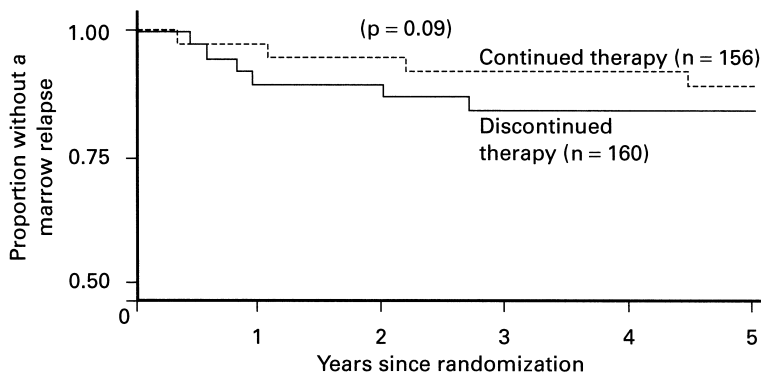
The objective of the trial was:

- To determine the optimum duration of maintenance chemotherapy in children with acute lymphoblastic leukemia (3 versus 5 years of therapy).

### Details of the study

Previously untreated patients with acute lymphoblastic leukemia (ALL) <18 years who were in continuous complete remission (CCR) for 3 years after start of maintenance therapy were eligible for randomization to stop or continue treatment.

Induction chemotherapy consisted of vincristine (VCR), prednisone (PDN) and L-asparaginase (ASP). All who achieved remission were randomized to one of six central nervous system (CNS) prophylaxis regimens and were maintained on 6-mercaptopurine (6-MP), methotrexate (MTX), VCR and PDN. Those remaining in CCR for 3 years were eligible for randomization either to stop or continue treatment for a further 2 years. Examination of bone marrow and CSF were mandatory prior to randomization. Testicular biopsies were not required prior to randomization.



**Figure 16.6** Time to bone marrow relapse from randomization.  
© American Society of Clinical Oncology (full reference on p. 403).

Outcome measures were bone marrow relapse rate, testicular relapse rate, overall survival and relapse-free survival (RFS).

### Outcome

Analysis was on intention to treat (except in the seven non-compliant patients). A total of 486 were eligible for randomization (after 3 years of CCR), of whom 170 were excluded (non-randomly continued or stopped), 316 (65%) were randomized with the result that 156 continued treatment (5 years) and 160 stopped treatment (3 years).

Seven randomized patients were non-compliant: 5 who were randomized to continue treatment stopped, and 2 who were to stop continued treatment.

There were 22 bone marrow relapses in patients who had 3 years of treatment ( $n = 160$ ) versus 12 bone marrow relapses in the 5-year group ( $n = 156$ ) ( $p = 0.09$ ). Median time to relapse was 323 days in the 3-year group, with only one patient relapsing after stopping treatment in the 5-year group. Probability of bone marrow remission at 60 months after randomization was 86% in the 3-year group versus 91% in the 5-year group (Figure 16.6).

Eleven isolated testicular relapses occurred in the group that discontinued therapy at 3 years and 5 testicular relapses (2 relapsed after therapy had been discontinued) in the group randomized to 5 years of therapy ( $p = 0.13$ ). Of the 13 who relapsed after discontinuing treatment (3-year group 11; 5-year group 2), only 8 remained free of disease at a median

follow-up of 31 months, while the other 5 died of leukemia.

Results for isolated CNS relapse were that 4 of 6 patients who relapsed on treatment (5-year group) later relapsed in the marrow and died, while one of the 2 patients who relapsed off treatment (3-year group) died after a subsequent marrow relapse.

At 5 years after randomization no significant difference was seen in survival between patients who received 3 years of therapy and those treated for 5 years (93% versus 89%, respectively,  $p = 0.27$ ).

No statistically significant differences in RFS were observed between patients treated for 3 years and those treated for 5 years ( $p = 0.24$ ), neither were any differences seen in RFS according to sex in patients treated for 3 years compared to those treated for 5 years, respectively (males: 81% versus 75%,  $p = 0.14$ ; females: 89% versus 89%,  $p = 0.95$ ).

Both sexes in the 3-year group had a risk of marrow relapse 1.7 times that of patients who discontinued therapy at 5 years but this was not statistically significant. The survival of females in the 5-year group was poorer but not statistically significant (relative risk of death 3.6;  $p = 0.08$ ).

### Conclusion

It was concluded that no demonstrable difference was evident in survival or relapse-free survival between 3 or 5 years of total ALL treatment.

### Study 3

Chessells JM, Durrant J, Hardy RM and Richards S. Report to the Council by the Working Party on Leukaemia in Childhood. Medical Research Council Leukaemia Trial UKALL-V: an attempt to reduce the immunosuppressive effects of therapy in childhood acute lymphoblastic leukaemia. *J Clin Oncol* 1986; 4:1758–64.

#### Study design

UKALL-V was a prospective randomized multicenter trial with three built-in randomizations. It ran from January 1976 to March 1979.

#### Objectives

The objective of the study was:

- To compare and evaluate 2 years versus 3 years of maintenance chemotherapy in children with acute lymphoblastic leukemia.

#### Details of the study

All children with previously untreated acute lymphoblastic leukemia (ALL) between the ages of 1 and 14 and with a diagnostic WBC count  $<20 \times 10^9/l$  were enrolled in the trial. Patients with central nervous system (CNS) involvement or mediastinal enlargement at diagnosis were excluded from the trial.

Remission induction consisted of vincristine (VCR)  $1.5 \text{ mg/m}^2/\text{week} \times 4$ , prednisolone (PDN)  $40 \text{ mg/m}^2/\text{day} \times 4$  weeks and L-asparaginase (L-ASP)  $10,000 \text{ U/m}^2/\text{dose} \times 4$  doses in 1 week. 6-Mercaptopurine (6-MP) was administered throughout the phase of cranial irradiation and this was followed by a 2-week course of VCR and PDN.

Randomization for CNS irradiation (CRT) was between 24 Gy in 12 fractions and 21 Gy in 7 fractions. Five intrathecal (IT) doses of methotrexate (MTX) were given during CRT.

Patients were randomized to one of three maintenance regimens given below:

Regimen I:  $210 \text{ mg/m}^2/\text{day} \times 5$  days of 6-MP and MTX  $10 \text{ mg}$  alternating with  $12.5 \text{ mg}$  over 3 days every 3 weeks. The doses were increased over the next two cycles to a maximum dose of  $300 \text{ mg/day}$  of 6-MP and to 5 days of MTX as permitted by blood counts or presence of oral ulceration.

Regimen C: 6-MP  $50 \text{ mg/day}$  and MTX  $20 \text{ mg/week}$ . 6-MP was increased as tolerated to  $70 \text{ mg/day}$ .

Regimen G: MTX similar to regimen C, but 6-MP started at a higher dose of  $70 \text{ mg/day}$  and increased to  $100 \text{ mg/day}$  if tolerated.

All three regimens delivered the same total dose of 6-MP and MTX per meter body surface area over a 12-week cycle.

At the end of 96 weeks of treatment, patients were randomized either to stop treatment or continue till week 144, if bone marrow and CSF were normal and in boys if testicular biopsy was normal. The schema of treatment shown in Figure 16.7.

Analysis were done by log-rank method and only first relapses were counted. All analysis was based on intention to treat.

Outcome measures were disease-free survival (DFS), bone marrow relapse rate and CNS relapse rate.

#### Outcome

A total of 550 patients were registered on the trial, of whom 22 were excluded (previous chemotherapy, diagnostic error). Of the 528 who were evaluable, 496 were in remission after induction chemotherapy and 348 were in remission at 2 years; 292 patients were randomized to stop or continue treatment for a further four cycles (144 weeks).

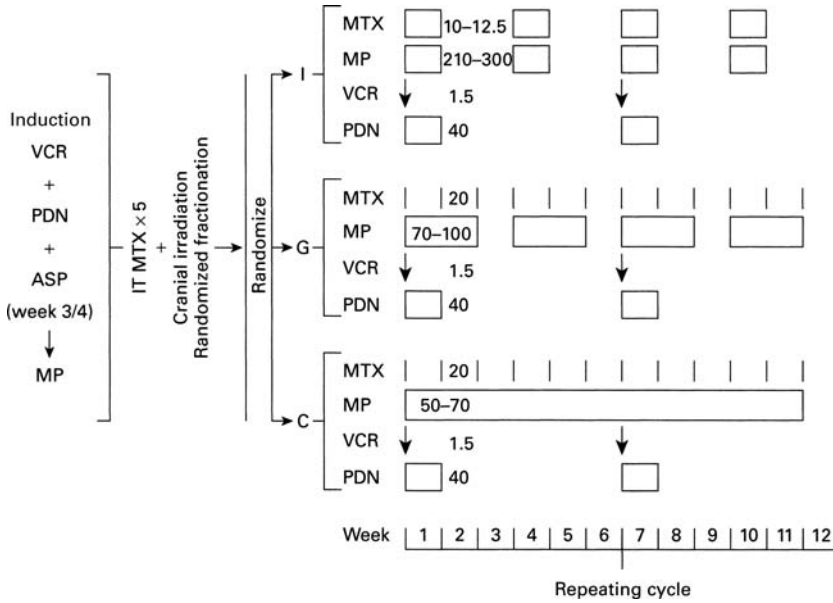
There was a statistically significant higher hematological relapse rate in girls who received only 2 years of treatment (28 versus 17;  $p = 0.01$ ).

There was a slightly increased rate of testicular and bone marrow relapse in boys who received only 2 years of maintenance treatment but this did not reach statistical significance. Though bone marrow relapses were higher in patients receiving 2 years of therapy in groups C and G, there was no significant difference in DFS between patients receiving 2 or 3 years of maintenance treatment in either groups C and G. This was due to three remission deaths in group C during the 3rd year of treatment.

Overall, there was an apparent benefit for patients who received 3 years of maintenance treatment (Table 16.2).

#### Conclusion

It was concluded that 3 years of maintenance chemotherapy was superior to 2 years.



**Figure 16.7** Design of the UKALL-V trial. The drug doses are in mg/m<sup>2</sup> surface area. Details of the maintenance schedules are described in the text. © American Society of Clinical Oncology (full reference on p. 405).

**Table 16.2** Two years versus 3 years of chemotherapy.

Event	Relapse and/or Death in Remission <sup>a</sup>			Marrow Relapse as First Event <sup>b</sup>			CNS Relapse as First Event <sup>c</sup>			Testicular Relapse as First Event		
	Obs.	Exp.	p	Obs.	Exp.	p	Obs.	Exp.	p	Obs.	Exp.	p
Duration of therapy												
2 year	62	48.6		47	35.4		7	5.5		10	8.1	
3 year	47	60.4	0.005	33	44.6	0.005	5	6.5	0.2	9	10.9	0.2
Sex												
M (2 year)	28	22.8		19	15.0		2	1.8		10	8.1	
M (3 year)	25	30.2	0.08	16	20.0	0.09	2	2.2	0.4	9	10.9	0.2
F (2 year)	34	25.6		28	20.4		5	3.8				
F (3 year)	22	30.4	0.01	17	24.6	0.01	3	4.2	0.2			
Chemotherapy												
C (2 year)	14	10.6		11	6.7		2	1.4		2	1.8	
C (3 year)	11	14.4	0.1	5	9.3	0.02	1	1.6	0.2	2	2.2	0.4
G (2 year)	23	18.5		18	13.7		0	0.5		4	3.7	
G (3 year)	15	19.5	0.07	10	14.3	0.05	1	0.5	0.5	6	6.3	0.4
I (2 year)	25	19.4		18	15.1		5	3.5		4	2.4	
I (3 year)	21	26.6	0.05	18	20.9	0.2	3	4.5	0.1	1	2.6	0.1
C and G (2 year)	37	28.8		29	20.1		2	1.9		6	5.6	
C and G (3 year)	26	34.2	0.02	15	23.9	0.003	2	2.1	0.5	8	8.4	0.4
Total number of events		107			80			12			19	

Obs.: observed event; Exp.: expected event.

<sup>a</sup>Four deaths in remission.

<sup>b</sup>One combined bone marrow and CNS relapse, five bone marrow and testis.

<sup>c</sup>Two combined CNS and testis relapses.

## Study 4

Bleyer WA. Remaining problems in the staging and treatment of childhood lymphoblastic leukaemia. *Am J Pediatr Hematol/Oncol* 1989;11: 371–9.

### Study Design

CCG-161, -162 and -163 were prospective multicenter randomized trials of the Children’s Cancer Study Group. No details regarding the period of the study are given in the report.

#### Objectives

The objective of the study was:

- To ascertain the optimal duration of treatment in children with ALL: 2 years versus 3 years of therapy.

### Details of the study

According to risk status, children with low risk acute lymphoblastic leukemia (ALL) were assigned to CCG study 161, those with intermediate risk to CCG study 162, and high risk children to CCG study 163.

Treatment details are not available in the report. Children, who were in continuous clinical remission 2 years after diagnosis, were randomized either to stop treatment or to continue maintenance therapy for an additional year. Boys underwent bilateral testicular

biopsies prior to randomization and were randomized only if they had no evidence of occult disease.

Outcome measures were relapse-free survival (RFS) and overall survival (OS).

No details of randomization methodology are given in the report.

### Outcome

The 2- versus 3-year randomization was conducted in 1082 children, of whom 539 were randomized to stop treatment (2 years) and 545 to 3 years of treatment.

Figure 16.8 shows the outcome of only 543 of the 1082 randomized children.

Girls had no benefit in extending treatment beyond 2 years. There were decreased bone marrow and testicular relapses in boys who had 3 years of therapy.

### Toxicity

There were no increased deaths in remission in either sex in the 3-year treatment arm.

#### Conclusion

It was concluded that, in boys, the disease-free survival was superior in the group given 3 years of treatment. This benefit was not evident in girls.

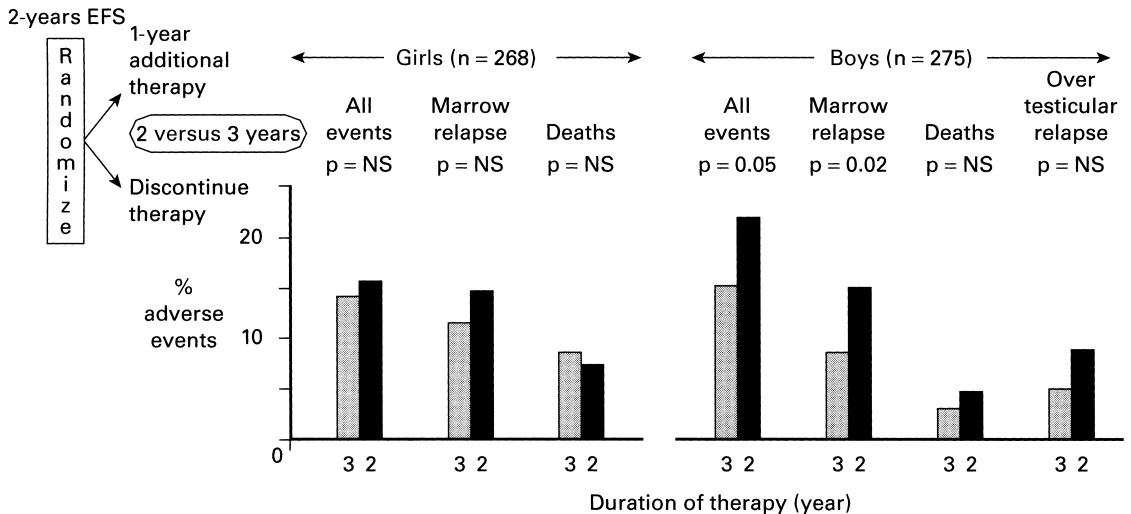


Figure 16.8 Comparison of adverse events after randomization to 2 years versus 3 years of maintenance chemotherapy of all for ALL. Reproduced with permission of Lippincott, Williams & Wilkins (full reference above).

## Study 5

Miller DR, Leikin SL, Albo VC, Sather H, Denman Hammond G. Three versus five years of maintenance therapy are equivalent in childhood acute lymphoblastic leukaemia: a report from the Children's Cancer Study Group. *J Clin Oncol* 1989;7:316–25.

### Study design

The Children's Cancer Study Group conducted the CCG-141 trial from February 1975 to February 1977. It was a prospective multicenter randomized trial.

### Objectives

The aim of the study was:

- To determine whether 3 and 5 years of maintenance therapy in childhood ALL were equivalent.

### Details of the study

All children and adolescents with acute lymphoblastic leukemia (ALL) <18 years of age, who were in 3 years of continuous complete remission (CCR) from initial central nervous system (CNS) prophylaxis therapy ("primary maintenance") or in CCR 3 years after having had an isolated extramedullary relapse with negative testicular biopsy ("secondary maintenance") were eligible for randomization.

Boys with occult testicular leukemia after 3 years of CCR were ineligible for randomization.

In those with a WBC count  $<20 \times 10^9/l$  with no mediastinal mass the induction treatment consisted of vincristine (VCR), prednisone (PDN) and asparaginase (standard regimen). CNS prophylaxis consisted of 24 Gy cranial irradiation plus 6 weekly intrathecal injections of methotrexate (MTX). Maintenance treatment during the 1st year consisted of 6-mercaptopurine (6-MP), oral MTX and monthly pulses of PDN and VCR. During the 2nd and 3rd years of maintenance, the pulses of VCR and PDN were omitted.

Children with a WBC count  $>20 \times 10^9/l$  and no mediastinal mass were randomized to either the standard induction regimen or to an intensive regimen in which oral cyclophosphamide was also added to the standard regimen. During CNS prophylaxis, the dose of 6-MP was increased while during the 1st year of maintenance treatment; alternating cycles of VCR, PDN, 6-MP and MTX or PDN, VCR, cytosine arabinoside and doxorubicin were administered. The 2nd

and 3rd year of maintenance were identical to the standard treatment patients.

After 3 years of CCR patients were randomized:

Regimen A: stop treatment.

Regimen B: 4 weeks of re-induction with VCR, PDN and asparaginase, and stop.

Regimen C: continue maintenance for 2 more years and stop.

No details of the randomization methodology are given in the report. Analysis was on the basis of intention to treat.

### Outcome

CCG-141 registered 880 children, of whom 827 (94%) achieved CR; 507 patients completed 3 years of primary or secondary maintenance; 26 boys had occult testicular disease on biopsy at the end of 3 years of CCR and were excluded. A total of 481 patients were eligible for randomization (boys 229; girls 252); 310 patients were randomized while 171 non-randomly continued or stopped treatment. Details of the randomization methodology are not given in the report, neither are reasons for non-randomization specified.

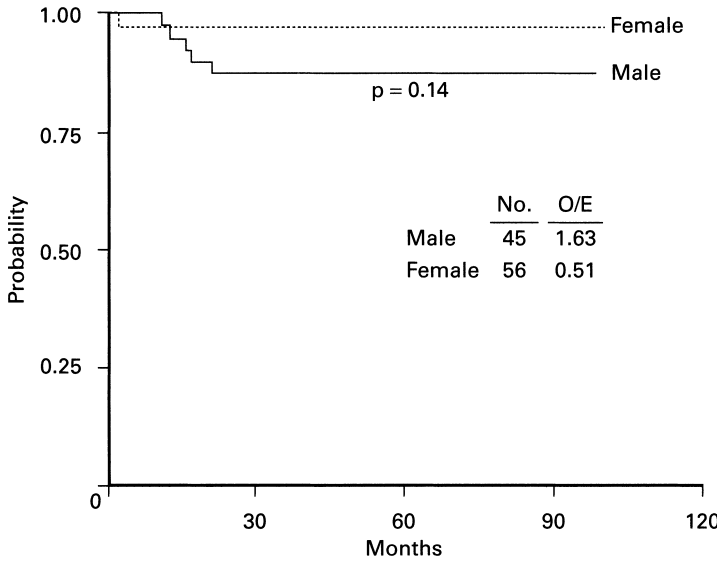
Randomization distribution was as follows: regimen A 101; regimen B 105; regimen C 104.

Patient characteristics in the three regimens were similar with respect to age, sex, WBC count, day 14 bone marrow status and maintenance treatment as well as prior extramedullary relapses; 70% had WBC count  $<20 \times 10^9/l$  (low count group). Of the high WBC count group (30%), 54% had standard treatment while 46% had intensive treatment. The median follow-up was 72 months from randomization.

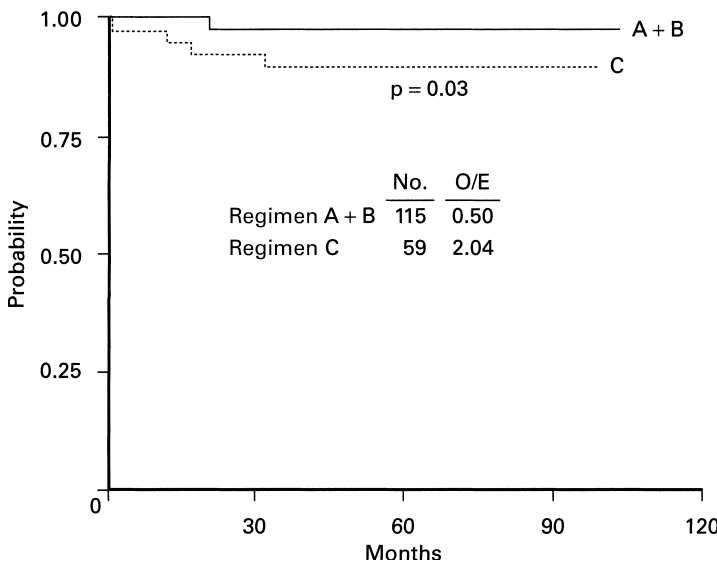
Outcome measures were disease-free survival (DFS) and non-leukemia related deaths.

No significant differences were seen in either the duration of hematological remission, recurrent disease, overall survival (OS), CNS relapse or isolated testicular relapse. There were five isolated CNS relapses with an overall incidence of 3.1% and there were two isolated testicular relapses among the 137 boys (1.5%).

DFS ( $p = 0.10$ ) and OS ( $p = 0.83$ ) were not significantly different in boys and girls. Though the relative event rate in boys randomized to regimen A was 3.2 times that in girls, this was not statistically different ( $p = 0.14$ ) (Figure 16.9). Girls randomized to regimen C had a significantly worse survival than those randomized to the combined regimens A and B



**Figure 16.9** DFS in males and females randomly assigned to regimen A (discontinue therapy after 3 years continuous clinical remission). © American Society of Clinical Oncology (full reference on p. 408).



**Figure 16.10** Survival in females randomly assigned to discontinue (regimens A and B) or continue chemotherapy (regimen C). © American Society of Clinical Oncology (full reference on p. 408).

( $p = 0.03$ ); their relative death rate was 3.9 times higher (Figure 16.10).

DFS at 6 years from randomization (Figure 16.11) was as follows:

Regimen A: 93%;

Regimen B: 89.2%;

Regimen C: 89.1% ( $p = 0.60$ ).

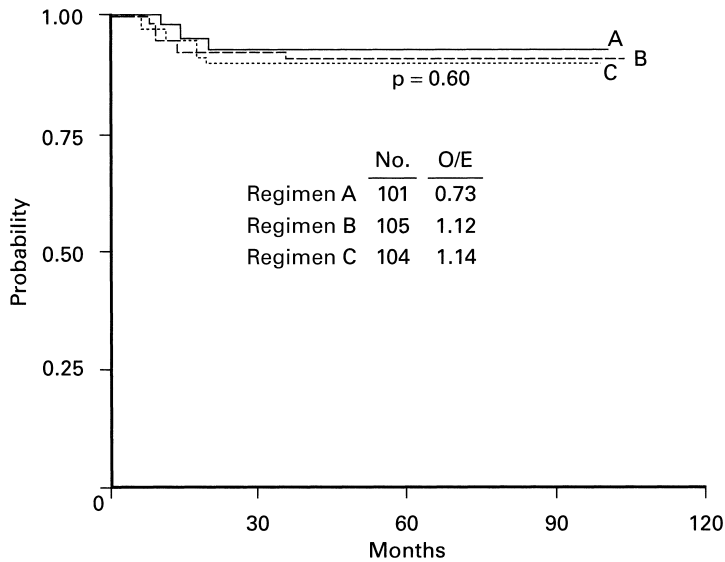
Of the 10 deaths in CCR, 5 occurred off therapy (regimen A 2; regimen B 1; regimen C 2) and 5 occurred on therapy: 3 children in regimen C died

while on maintenance treatment due to disseminated varicella pneumonia while 2 children on regimen B died due to pneumonia and second malignant tumor, respectively.

### Conclusion

It was concluded that prolongation of maintenance therapy beyond 3 years does not improve survival or decrease risk of relapse.





**Figure 16.11** DFS of patients randomly assigned to regimens A, B and C. © American Society of Clinical Oncology (full reference on p. 408).

## Study 6

ALL steering committee of the Associazione Italiana Ematologia Oncologica Paediatrica (AIEOP): Paolucci G, Massera G, Vecchi V, Marsoni S, Pession A, Zurlo MG. Treating childhood acute lymphoblastic leukaemia (ALL): summary of 10 years' experience in Italy. *Med Paediatr Oncol* 1989;17:83–91.

### Study design

This report summarizes the results of three AIEOP multicenter trials that were conducted between 1976 and 1986. Trial 79–01/02 had two randomized components; low and average risk patients were randomized to a total length of 2 years versus 3 years of treatment while high risk patients were randomly assigned two different chemotherapy regimens.

### Objectives

The objective was:

To determine whether 2 years versus 3 years of maintenance therapy in low risk/average ALL patients was equivalent.

### Details of the study

All children with previously untreated acute lymphoblastic leukemia (ALL) aged between 1 and 14 years (inclusive), were included in the three studies. Though

children with central nervous system (CNS) disease at diagnosis or B-ALL were eligible for enrollment in the early trials, they were excluded from analysis. Patients were categorized into three prognostic groups; low (LR), average (AR) and high (HR) risk and treatment was stratified according to risk groups:

LR: Non-T, Non-L3 ALL, WBC  $<10 \times 10^9/l$ , age 3–6 years, FAB  $\leq 25\%$  L2 blasts.

AR: Non-T, Non-L3 ALL, WBC  $<10 \times 10^9/l$ , age 3–6 years, FAB  $>25\%$  L2 blasts or WBC  $10\text{--}50 \times 10^9/l$ , age 3–6 years or WBC  $<50 \times 10^9/l$ , age  $<3$  or  $\geq 7$  years.

HR: T-ALL and or FAB L3 and or WBC  $>50 \times 10^9/l$ .

The AIEOP treatment protocols are outlined in Table 16.3. To summarize briefly, all studies consisted of an induction, intensification and maintenance phase. A second re-intensification was introduced in the 82 Trial. CNS prophylaxis was mainly with cranial irradiation and intrathecal methotrexate. In the 79 Trial, LR and AR patients were randomized to a total duration either 2 or 3 years of treatment.

The log-rank test was used to compare disease-free survival (DFS) rates. Significance level of 5% was adopted in all the two-tailed tests. The median follow-up was 61 months at the time of the analysis.

Details of randomization methodology are not specified in the report.

Outcome measure was DFS.

**Table 16.3** AIEOP ALL protocol.

Protocol	Induction	Intensification	CNS prophylaxis	Maintenance	Duration
1979 LR	V, P, MTX IT	L-ASP	18 Gy	6-MP, MTX+V/P pulses	(2 years)
1979 SR	V, P, MTX IT	L-ASP, 6-TG, AC, A	18 Gy	6-MP, MTX+V/P pulses	(3 years)

V: vincristine; P: prednisolone; MTX: methotrexate; L-ASP: L-asparaginase; 6-TG: 6-thioguanine; AC: cytosine arabinoside; A: doxorubicin; R: randomize.

## Outcome

Of the 815 patients who were enrolled on the AIEOP 79 trial, 545 patients were categorized as either low or average risk. Only 540 were eligible for analysis. Of the 540 eligible patients, 464 were assigned to correct risk groups and analyses refer to this latter group. A total of 177 patients were randomized to either 2 or 3 years of total treatment.

Five-year DFS for patients randomized to 3 years of treatment was 70% versus 68.3% for the 2-year group,

$\chi^2_1 = 0.55$ . The duration of total treatment (2 or 3 years) did not affect final outcome.

## Conclusion

Two years of total treatment was concluded to be adequate in children with low or average risk ALL.

## Study 7

Eden OB, Lilleyman JS, Richards S, Shaw MP, Peto J. Results of Medical Research Council Childhood Leukaemia Trial UKALL-VIII (Report to the Medical Research Council on behalf of the Working Party on Leukaemia in Childhood). *Br J Haematol* 1991;**78**: 187–96.

## Study design

UKALL-VIII was a prospective multicenter randomized trial and ran from September 1980 to December 1984.

### Objectives

The study addressed:

- The question of whether an additional year (3rd year) of maintenance treatment improves survival outcome in children with acute lymphoblastic leukemia.

### Details of the study

All children aged 0–14 years inclusive, irrespective of initial presenting features, were eligible for enrollment on the study.

All patients received a three-drug induction regimen of weekly vincristine (VCR) ( $1.5 \text{ mg/m}^2/\text{dose}$ )  $\times$  5, 28 days of oral prednisone ( $40 \text{ mg/m}^2/\text{day}$ ) and nine intramuscular injections of L-asparaginase ( $6000 \text{ U/m}^2/\text{dose}$ ). From September 1981, all children were randomized to receive two doses of daunorubicin ( $45 \text{ mg/m}^2/\text{dose}$ ) during induction or not. Cranial prophylaxis consisted of intrathecal methotrexate ( $n = 4$ ) and cranial irradiation (18 Gy) given immediately after achieving remission. Those not in remission by 4 weeks were given a further 2 weeks of VCR and oral prednisone, but were taken off protocol if they failed to achieve remission. Maintenance therapy consisted of oral methotrexate ( $20 \text{ mg/m}^2$  weekly) and 6-mercaptopurine ( $75 \text{ mg/m}^2/\text{day}$ ) with monthly pulses of VCR ( $1.5 \text{ mg/m}^2/\text{dose}$ ) and 5 days of oral prednisone ( $40 \text{ mg/m}^2/\text{day}$ ). From January 1983 to the close of the trial in December 1984, there was a further randomization for those still in remission at 2 years, between 2 or 3 years of maintenance therapy (Figure 16.12).

Outcome measures were disease-free survival (DFS) and overall survival (OS) in the two groups of randomized patients according to duration of maintenance therapy.

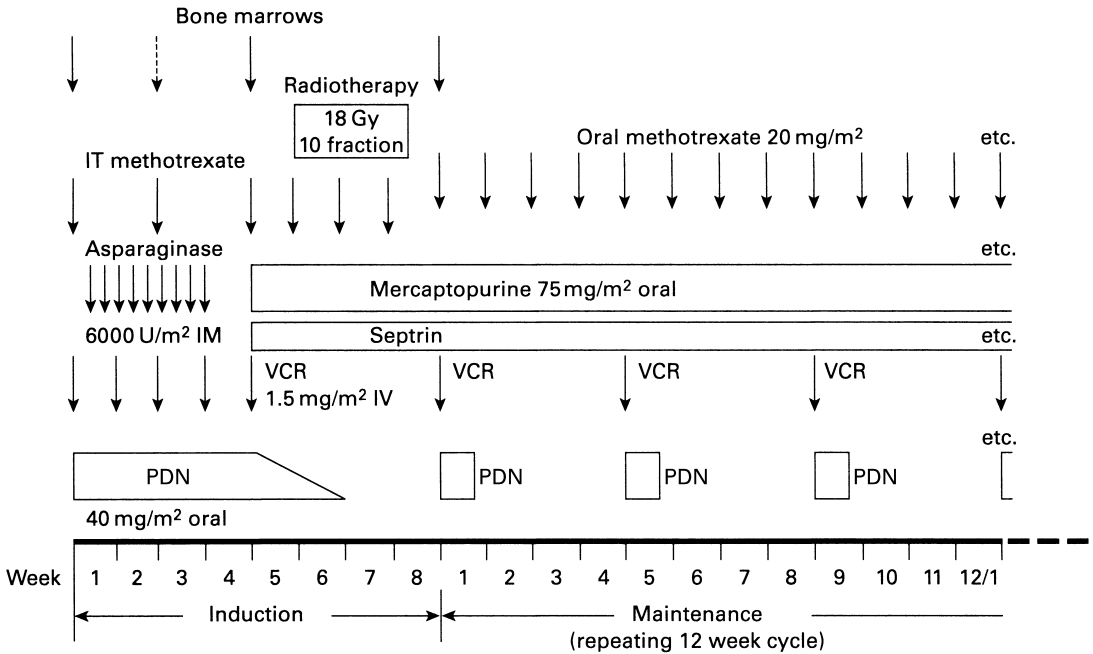
Details of the randomization method were not specified in the report.

**Outcome**

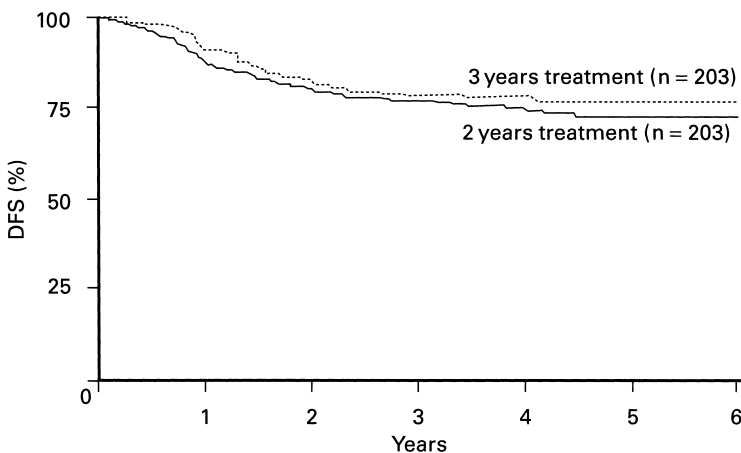
Of the 829 patients registered in the trial, only 826 were available for analysis (3 did not have acute lymphoblastic leukemia, ALL).

Four hundred and six patients were randomized with regard to the duration of maintenance treatment (2 years n = 203 versus 3 years n = 203).

Five-year DFS for the entire cohort was 55%. There was no difference between 2 and 3 years of maintenance therapy for the whole group and also irrespective of sex. Five-year DFS for 3 years of treatment was 77% versus 73% for 2-year treatment (Figure 16.13).



**Figure 16.12** Details of treatment in UKALL-VIII. Reprinted from Eden *et al.* (full reference p. 411) with permission from Blackwell Publishing Ltd.



**Figure 16.13** DFS from the time of second randomisation: 3 years, DFS = 77%; 2 years, DFS = 73%. Reprinted from Eden *et al.* (full reference on p. 411) with permission from Blackwell Publishing Ltd.

More relapses were seen after stopping treatment at 2 than 3 years (17% versus 25%;  $p$  for relapse-free survival,  $RFS = 0.04$ ), however, there was 4% increased remission deaths in the 3-year arm.

### Conclusion

It was concluded that there was no significant survival benefit for those receiving 3 years of maintenance therapy.

## Study 8

Childhood ALL Collaborative Group. Duration and intensity of maintenance chemotherapy in acute lymphoblastic leukaemia: overview of 42 trials involving 12,000 randomized children. *Lancet* 1996;347:1783–8.

### Study design

This report is a meta-analysis of 42 randomized trials in childhood acute lymphoblastic leukemia (ALL) that were performed worldwide before 1987.

#### Objective

The main aim of this study was:

- To estimate the duration of maintenance therapy, the efficacy of re-induction therapy during maintenance, effectiveness of regular pulses of vincristine and prednisone during maintenance.

### Methodology

Individual patient data of approximately 3900, 3700, 1300 and 3150 patients were retrieved and analyzed with regard to the duration of maintenance therapy, the efficacy of re-induction therapy during maintenance, effectiveness of regular pulses of vincristine and prednisone during maintenance and various other questions.

Analyses were of survival in first remission, overall survival and cause specific mortality.

Only randomized trials (prior to 1987 only) were evaluated. All the trials were identified by Medline and clinical trials database search, hand searching of meeting abstracts, reference lists of trials, review articles or by personal communication. Analysis was on an intention to treat basis. Trials were excluded only if randomization was deemed unsatisfactory.

The main analysis was survival and survival in first remission from date of randomization. An event was

defined as relapse death in remission or death without remission. In some analyses, mortality was subdivided into death in first remission and death after relapse.

### Statistics

The statistical methods involved comparison of the observed number of patients in one treatment group (O) who suffered a particular event with the log-rank expected number (E), which was based on the average experience of both treatment groups. From the log-rank (O–E), its variance was calculated (odds ratio), including 99% confidence interval. Information from different trials is then combined by summing the separate O–E values, one per trial.

### Outcome

Table 16.4 shows the 42 trials of maintenance therapy. Information from seven trials was not available.

### Duration of maintenance therapy

Of the 17 trials that compared the duration of maintenance therapy (commonest being 2 years versus 3 years), data was not available in one trial (BFM). All trials were between 1970 and 1983, with the last patients randomized in 1990. In the 16 trials together, 3861 patients were randomized either to the shorter or longer maintenance arm. The median follow-up was >5 years for all but one trial.

The risk of relapse or death was 27.6% ( $n = 538/1946$ ) for patients who had a shorter duration of maintenance (usually 2 years) compared to 23.3% ( $n = 446/1915$ ) with longer maintenance. The overall odds reduction was 21% with standard deviation (SD 6) ( $2p = 0.0003$ ) (Figure 16.14). Longer maintenance halved the relapse rate but did not translate into improved long-term survival (Figure 16.15). Deaths

**Table 16.4** Randomized comparisons with outcome data available that began before 1987 of the duration or intensity of maintenance chemotherapy in childhood ALL.

Treatment comparison	Trials	Patients	Relapse or Death
Longer versus shorter maintenance	16	3861	984
Addition of pulses of vincristine and prednisolone during maintenance	5	1251	447
Addition of intensive re-induction treatment during maintenance	6	3696	1246
<i>Other drug additions during maintenance</i>			
Higher versus lower dose	2	476	276
Cytosine arabinoside + cyclophosphamide + doxorubicin	1	711	263
Cytosine arabinoside + cyclophosphamide	2	365	284
Cyclophosphamide	4	990	446
L-asparaginase + cytosine arabinoside	1	191	131
Cytosine arabinoside	2	296	182
Prednisolone	1	33	29
Vincristine	1	31	26
6-Mercaptopurine	1	40	22
All studies with data available	42	11941	4336

during first remission were increased by longer maintenance (2.7% versus 1.2%).

Reinforcement with vincristine and prednisone (VP) during seven maintenance trials compared maintenance therapy with and without pulses of VP. A total of 1251 patients were randomized to receive or not VP pulse (patient data available from five trials). Overall, VP pulses during maintenance reduced the absolute risk of relapse or death by 9.2%. Deaths in remission were slightly higher (4.0% versus 3.2%) while deaths after relapse were lower (both non-significant) among patients allocated reinforcement VP pulses. Overall survival was better in patients who were randomized to receive VP pulse therapy but this was not statistically significant (Figure 16.16).

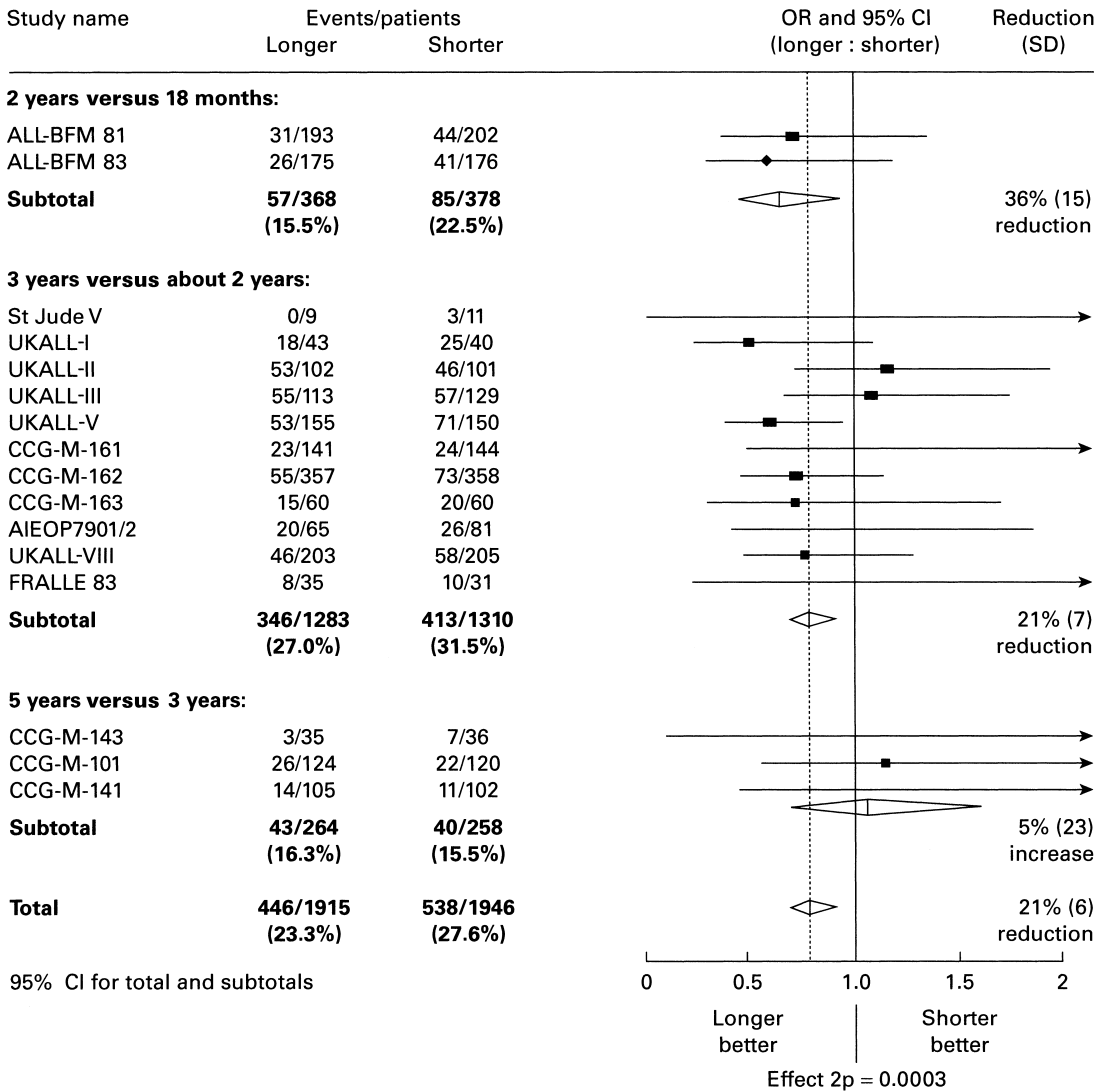
### Additional re-induction therapy during maintenance therapy

Of the seven trials that addressed this issue, data were available from only six. Of the 3696 patients randomized, individual patient data was available from all except 254 patients. The median follow up (where patient data were available) was at least 5 years.

Patients who were randomized to receive the additional intensification block had highly significant difference in relapse rate that resulted in improved survival in first remission – absolute difference in survival in first remission by the 5th year was 7.6% (71.1% versus 63.5%). There was a significant reduction of relapses at all sites and a non-significant increase in deaths in remission (4.8% versus 3.3%) in this group of patients.

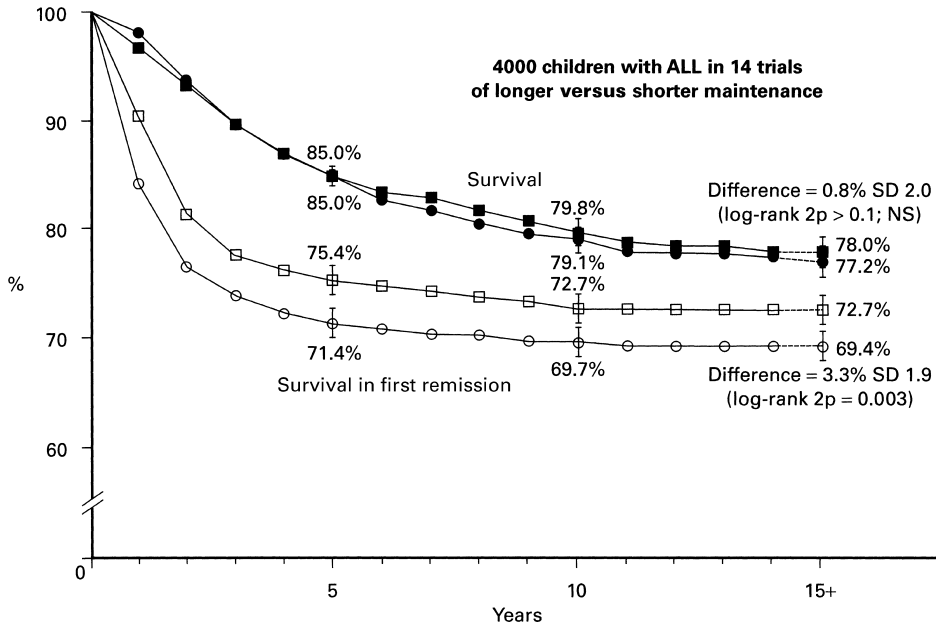
### Conclusion

- Longer maintenance reduced the risk of hematological and testicular relapse during the 3rd year, however, this did not translate into improved overall survival due to a slight increase in deaths during first remission.
- Intensive re-induction therapy improved overall survival as well as survival in first remission due to reduction in leukemia relapses and leukemia related deaths.
- Reinforcement VP pulse therapy reduced relapses but did not result in any significant improvement in overall survival.

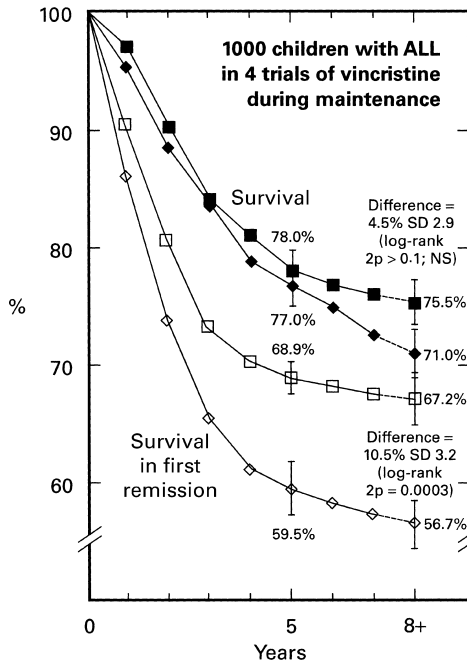


**Figure 16.14** Duration of maintenance chemotherapy in childhood ALL; effects on survival in first remission. Larger squares indicate more informative trials and hence shorter CIs. If square is to the left of solid line, survival in first remission is better in group allocated longer maintenance treatment, but if CI crosses this line,

this result is not of extreme statistical significance ( $2p > 0.01$ ). Subtotals and overall total are represented as diamonds centred on OR (odds ratio) estimate, with 95% CI shown by width of diamond and with odds reduction also given as percentage along with its SD. Reprinted with permission from Elsevier.



**Figure 16.15** Duration of maintenance chemotherapy in childhood ALL: effects on survival and on survival in first remission. Upper pair of lines describes survival and lower pair (open symbols) survival in first remission from time of randomization: both pairs derive from stratified analyses. Squares and circles denote active and control, respectively. Reprinted with permission from Elsevier.



**Figure 16.16** Addition of pulses of vincristine plus prednisolone during maintenance chemotherapy in childhood ALL: effects on survival, and on survival in first remission. Reprinted with permission from Elsevier.

## Study 9

Schrapppe M, Reiter A, Zimmermann M, Harbott J, Ludwig WD, Henze G, Gadner H, Odenwald E, Riehm H. Long-term results of four consecutive trials in childhood ALL performed by the ALL-BFM study group from 1981 to 1985. *Leukaemia* 2000;14:2205–22.

### Study design

ALL-BFM 81 and 83 were multicenter prospective randomized studies with treatment stratified according to the BFM risk criteria. ALL-BFM 81 began in April 1981 and was closed in September 1983 and ALL-BFM 83, which commenced in October 1983 and closed in September 1986, followed this.

### Objective

The study objective was:

- To determine whether the total duration of ALL treatment could be shortened from 24 months to 18 months in all risk groups of patients.

### Details of the study

The study was open to all patients below 18 years of age with previously untreated leukemia. Children with Down's syndrome who had severe cardiac defects were excluded, as were children who developed acute lymphoblastic leukemia (ALL) as a second malignancy.

Patients were categorized as standard risk (SR: RF < 1.2), medium risk (MR: RF 1.2–1.7) or high risk (HR: RF ≥ 1.7) according to the leukemic cell mass (BFM risk factor: RF) at diagnosis. SR patients were further subdivided in ALL-BFM 83 into low SR (RF < 0.8 and no central nervous system (CNS) disease or mediastinal mass) and high SR (RF 0.8–<1.2) groups.

The duration of induction therapy ranged from 8 (BFM 81) to 11 (BFM 83) weeks. ALL-BFM 83 induction therapy commenced with a 1 week prednisone (PDN) window with a stepwise increase to full dose of 60 mg/m<sup>2</sup>/day. The other drugs used during induction therapy consisted of vincristine (VCR), prednisone (PDN), daunorubicin (DNR) and L-asparaginase (ASP): phase A and phase B included cyclophosphamide (CPM), cytosine arabinoside (ARA-C), 6-mercaptopurine (6-MP) and intrathecal methotrexate (IT MTX). For BFM 83 HR patients, two blocks of dexamethasone (DEX), IV MTX, teniposide (VM-26), ARA-C and CPM – 'Element B', followed the PDN prophase.

All patients (except SR patients not randomized to cranial RT) in BFM 81 had cranial irradiation after induction therapy – 18 or 24 Gy.

Consolidation therapy in BFM 81 consisted of 6-MP and oral MTX alone except in SR patients who did not receive cranial irradiation (SR-B). SR-B of BFM81 and all patients of BFM 83 received 6-MP and IV MTX during the consolidation phase.

Re-intensification consisted of two phases: phase A – DEX/VCR/DOX/ASP – and phase B – ARA-C/6-TG/IT MTX (Protocol III, 4 weeks) with CPM for the MR group (Protocol II, 6 weeks) only and was similar in both the trials. Low SR patients in BFM 83 were either to receive Protocol III or not. HR patients in BFM 81 received the same drugs as in Protocol II plus VM-26 and additional ARA-C (Protocol IV, 8 weeks) (BFM 83) while HR patients in BFM 83 received Protocol II chemotherapy. High SR patients were randomized to either 18 or 12 Gy cranial irradiation while MR (18 Gy) and HR (24 Gy) patients in BFM 83 had cranial irradiation during this phase.

Maintenance phase consisted of daily oral 6-MP and weekly oral MTX in both trials for 18 months.

IT chemotherapy comprised seven courses in BFM 81 and eight courses in BFM 83.

Patients in continuous clinical remission were randomized either to stop therapy (18 months) or to continue maintenance treatment for a further 6 months and stop (24 months).

Outcome measures were CNS relapse rate, disease-free survival (DFS) and overall survival.

Randomization details are not specified in the report. Comparisons between the treatment groups were made using the log-rank test.

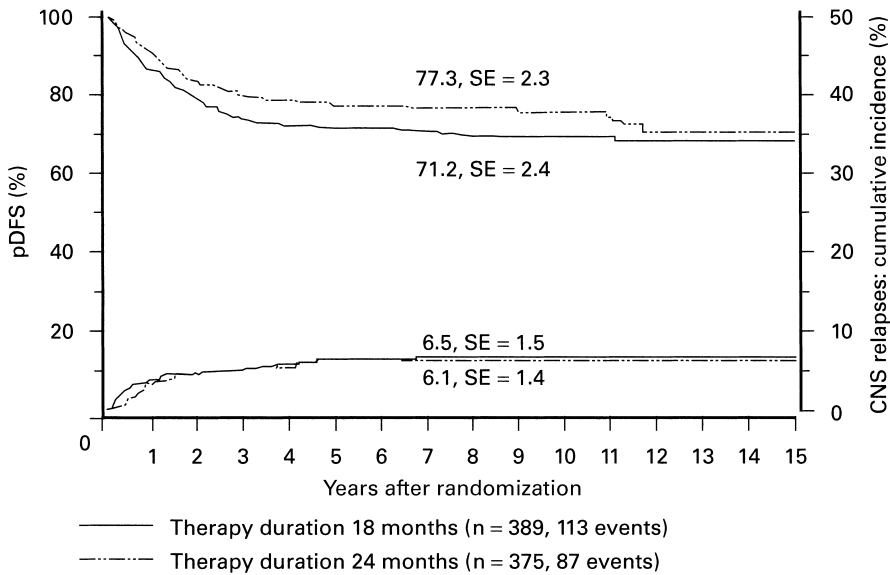
All analyses were performed on the basis on intention to treat.

### Outcome

Of the 1264 patients enrolled on both studies together, 764 patients were randomized to evaluate the impact of duration of treatment (18 months versus 24 months) on DFS. The report does not give the exact numbers of registered patients who were excluded from analysis, remission deaths, toxic deaths, non-compliant patients, numbers of patients who relapsed prior to randomization, etc.

The 8-year DFS for patients randomized (n = 375) for 24 months and 18 months (n = 389) of therapy





**Figure 16.17** Evaluation of treatment duration in studies ALL-BFM 81 and 83. Adapted and reprinted from Schrappe *et al.* (full reference on p. 417) with permission from Nature, Macmillan Publishers, Ltd.

were  $77.3 \pm 2.3\%$  and  $71.2 \pm 2.4\%$ , respectively. Log-rank test ( $p = 0.11$ ) did not show any significant difference because of late events occurring 10 years from diagnosis (Figure 16.17).

The cumulative incidence of CNS relapses at 10 years from randomization was similar, however, there was a trend for lesser relapses at other sites in the group that received 24 months of therapy ( $p = 0.07$ ).

There was also a significant difference in overall survival at 10 years for patients who had 24 months of treatment ( $p = 0.025$ ).

No details of toxicity have been specified.

### Conclusion

It was concluded that 2 years of treatment was superior to 18 months of therapy.

# Modification of continuing therapy – pulsed vincristine and prednisolone

## Study 10

Bleyer WA, Sather HN, Nickerson HJ, Coccia PF, Finklestein JZ, Miller DR, Littman PS, Lukens JN, Siegel SE, Denman Hammond G. Monthly pulses of vincristine and prednisone prevent bone marrow and testicular relapse in low-risk childhood acute lymphoblastic leukaemia: a report of the CCG-161 study by the Children's Cancer Study Group. *J Clin Oncol* 1991;9:1012–21.

### Study design

Trial CCG-161 by the Children's Cancer Study Group extended from April 1978 till May 1983. It was a prospective randomized multicenter study. In October 1982, regimens containing cranial radiotherapy (CRT) were closed to patient accrual.

A single randomization was performed with a two by two multifactorial design (four treatment arms). One factor was the use of CRT or intrathecal methotrexate (IT MTX) and the second factor was the use of monthly vincristine (VCR) and prednisolone (prednisone) pulses or not during maintenance treatment.

### Objectives

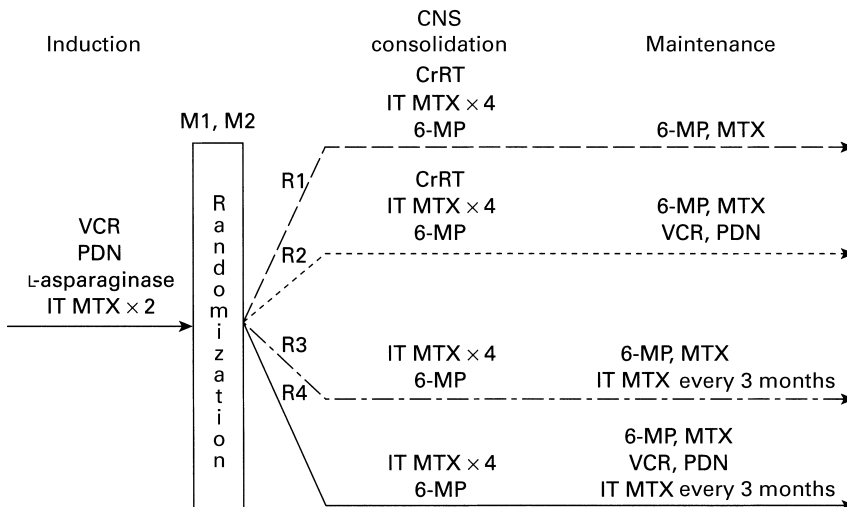
The objectives of the study were:

- To determine whether the addition of monthly pulses of vincristine and prednisone to methotrexate (MTX) and 6-mercaptopurine (6-MP) during the maintenance phase of treatment, improves overall and disease-free survival.

### Details of the study

Children between 3 and 6 years of age and WBC count at diagnosis of  $<10 \times 10^9/l$  with  $<25\%$  L2 morphology cells in bone marrow (BM) were enrolled on the study.

All patients received vincristine (VCR)  $1.5 \text{ mg/m}^2/\text{week IV} \times 5$ , prednisone (PDN)  $40 \text{ mg/m}^2/\text{day orally} \times 28$  days and tapered thereafter, L-asparaginase  $6000 \text{ U/m}^2/\text{dose IM}$  3 times per week  $\times 9$  doses, and IT MTX on days 0, 14, 28, 35, 42, 49. IT MTX doses were age adjusted –6, 8, 10 and 12 mg for ages  $<1$ , 1, 2 and 3 years or greater, respectively (Figure 16.18). At the end



**Figure 16.18** Study design of CCG-161. CrRT: Cranial radiotherapy. © American Society of Clinical Oncology (full reference on p. 418).

of induction, patients were randomized to either cranial irradiation 18 Gy given over 10 fractions or IT MTX and maintenance IT MTX.

Maintenance treatment was MTX 20 mg/m<sup>2</sup>/week and 6-MP 75 mg/m<sup>2</sup>/day, given to all patients and modified according to absolute neutrophil and platelet counts. In addition, one half also received monthly pulses of VCR 1.5 mg/m<sup>2</sup> and PDN 40 mg/m<sup>2</sup> × 5 days. Children randomized to IT MTX also received additional IT treatment during the maintenance phase.

No details are given in the report of the randomization method used.

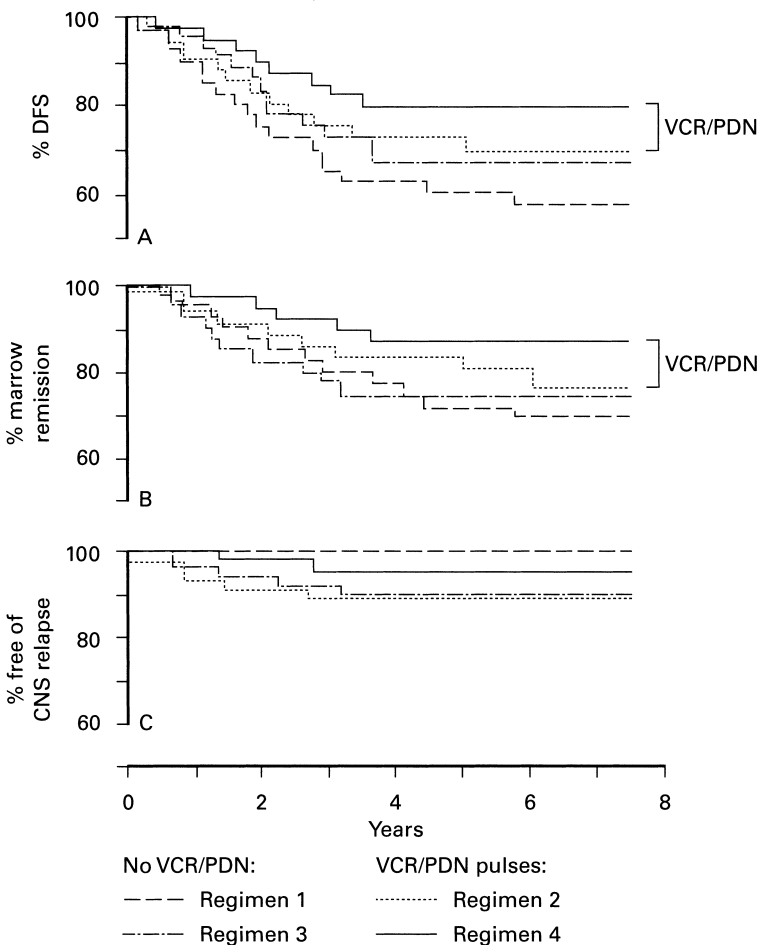
Outcome measures for analysis were disease-free survival (DFS), overall survival, hematological remission, central nervous system (CNS) remission and testicular remission. Analysis was based on actual treatment received.

## Outcome

The number of patients registered on the trial was 698, of whom 679 reached consolidation; 48 refused randomization and the number randomized to maintenance was 631. There were 26 protocol violations, leaving 605 correctly randomized. The number receiving 6-MP/MTX plus VCR and PDN was 302; 303 received 6-MP/MTX alone. There were 163 boys randomized to VCR/PDN/6-MP/MTX and 166 to 6-MP/MTX alone.

Five-year DFS in the 6-MP/MTX/VCR/PDN arm was 76.7% versus 63.9% ( $p = 0.003$ ) in the 6-MP/MTX alone arm, regardless of CNS therapy. This difference was due to increased BM – 38 (12.6%) versus 69 (22.7%) – and testicular relapses (in boys).

The difference between VCR/PDN pulses and no pulses was most pronounced in the group who received IT MTX rather than CRT.



**Figure 16.19** (A) DFS ( $p = 0.032$ ); (B) haematologic remission ( $p = 0.034$ ) and (C) CNS remission ( $p = 0.035$ ) from randomization in patients on CCG-161 who were randomized to receive or not to receive VCR-PDN pulses during maintenance therapy. For details of regimens, see Figure 16.18. © American Society of Clinical Oncology (full reference on p. 418).

Five-year continuous hematological remission in the VCR/PDN arm was 86.3% versus 74.5% in the 6-MP/MTX alone arm ( $p = 0.0008$ ) (Figure 16.19).

Both irradiated boys and girls had a higher CNS relapse rate with VCR/PDN pulses than without them (10.2% versus 0% in girls; 5.6% versus 0% in boys). However, in both sexes who received IT MTX there were lower CNS relapses in those treated with VCR/PDN pulses than in those who were not (2.5% versus 9.2% in girls; 5.6% versus 6.3% in boys,  $p = 0.11$ ).

Five-year DFS for boys randomized to VCR/PDN was 74.7% versus 55.1% for those who were not ( $p = 0.001$ ). BM and testicular relapses were significantly lower in boys randomized to VCR/PDN: BM 23/163, testicular 10/163 compared to 44/166 and 30/166, respectively, in the boys who did not receive it ( $p = 0.0006$  and  $p = 0.003$ , respectively). The effect of VCR/PDN was stronger in the non-irradiated boys: 2.59 times higher risk of BM relapse in the 6-MP/

MTX alone group as compared to 1.59 times higher in the irradiated boys.

Five-year DFS for girls randomized to VCR/PDN was 78.9% compared to 74.9% for the girls who did not receive VCR/PDN pulses.

The effect of VCR/PDN pulses was more evident in the non-irradiated group.

Survival was not significantly different for VCR/PDN or CNS therapy at the time of analysis.

### Toxicity

There were 10 excess deaths in remission in the VCR/PDN arm, which were equally distributed between the cranial irradiation and IT MTX regimens. These were mostly due to viral or *Pneumocystis carinii* infections.

### Conclusion

Monthly pulses of vincristine and prednisone decreased the incidence of testicular and bone marrow relapses and improved DFS. This was most evident in the non-irradiated group of patients.

## Study 11

Henze G, Langermann HJ, Fengler R, Brandeis M, Evers KG, Gadner H, Hinderfeld L, Jobke J, Kornhuber B, Lampert F, Lasson U, Ludwig R, Müller-Wehrich S, Neidhardt M, Nessler G, Niethammer D, Rister M, Ritter J, Schaaff A, Schellong G, Stollmann B, Treuner J, Wahlen M, Weinel P, Wehinger H, Riehm H. Therapiestudie BFM 79/81 zur Behandlung der akuten lymphoblastischen Leukämie bei Kindern und Jugendlichen: intensivierte Reinduktionstherapie für Patientengruppen mit unterschiedlichem Rezidivrisiko. *Klin Pädiatr* 1982;194:195–203.

### Study design

The BFM 79/81 study ran from April 1979 to March 1981. It was a multicenter prospective randomized study.

#### Objectives

The aims of this trial were:

- To determine whether treatment outcome for non-high risk ALL patients could be improved by the

introduction of an intensive re-induction block early in remission.

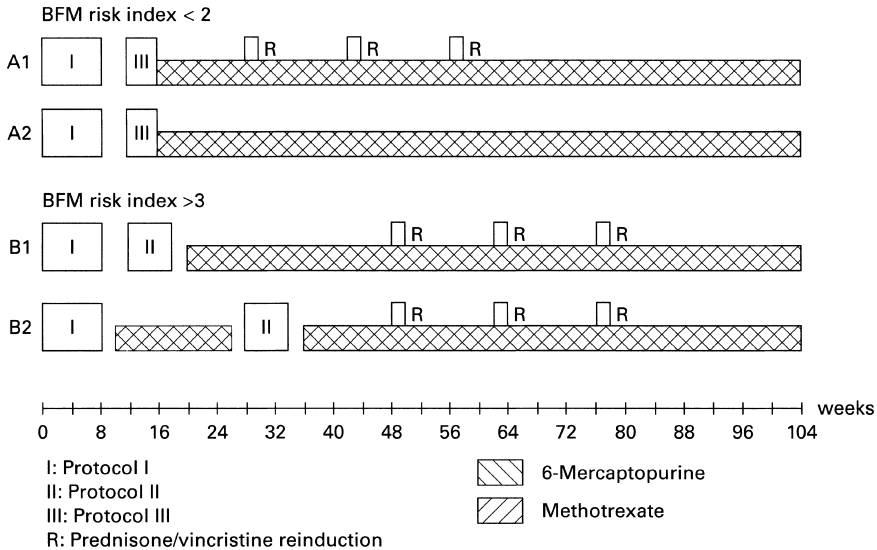
- To evaluate the efficacy of regular pulses of vincristine and prednisone during maintenance therapy in improving disease-free survival in standard risk ALL patients.
- To compare and evaluate 2.5 years with 2 years of treatment in children with high risk ALL.

Here we focus primarily on the duration of treatment for high risk ALL and efficacy of regular pulses of vincristine and prednisone in improving disease-free survival (DFS) in standard risk patients.

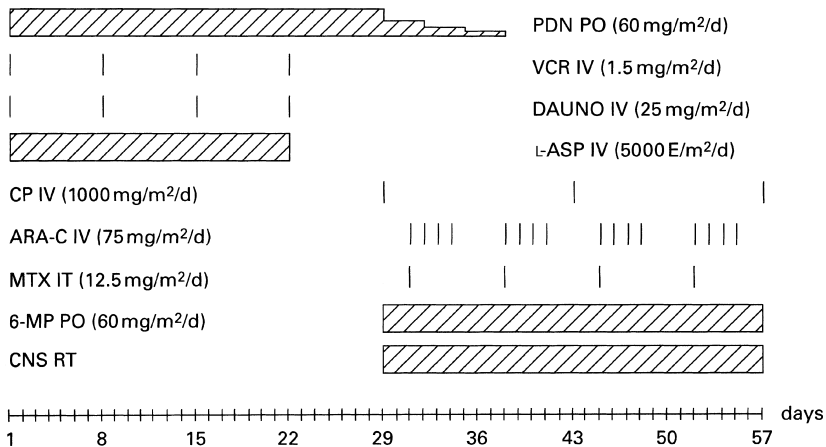
### Details of the study

Patients were categorized into standard and high risk groups as per the BFM (Berlin–Frankfurt–Munster) risk index and treatment was stratified according to risk status as shown in Figures 16.20 and 16.21.

Details regarding randomization are not reported. Outcome measures were relapse-free survival (RFS).



**Figure 16.20** Treatment plan of study BFM 79/81.



**Figure 16.21** Protocol I for study BFM 79/81. PDN: prednisone; VCR: vincristine; DAUNO: daunorubicin; L-ASP: asparaginase; CP: cyclophosphamide; ARA-C: cytosine arabinoside; MTX: methotrexate; 6-MP: 6-mercaptopurine; PO: orally; IV: intravenous; IT: intrathecal; RT: radiotherapy.

## Outcome

There were no differences in the outcome in children treated with regular pulses of vincristine and prednisone compared to those who were not: RFS 0.83 (SD = 0.06) versus 0.83 (SD = 0.05), respectively.

Reducing the duration of treatment from 2.5 to 2 years in children with high risk acute lymphoblastic leukemia (ALL) did not adversely affect outcome.

## Conclusions

- Regular pulses of vincristine and prednisone during maintenance therapy were unnecessary in patients with standard risk ALL.
- In children with high risk ALL, a total of 2 years' treatment was satisfactory.

See also Study 8, Chapter 16: meta-analysis by Richards *et al.*

# Modification of continuing therapy – dose and route of methotrexate

## Study 12

Lange BJ, Blatt J, Sather HN, Meadows AT. Randomised comparison of moderate dose methotrexate infusions to oral methotrexate in children with intermediate risk acute lymphoblastic leukaemia: a Children's Group study. *Med Paediatr Oncol* 1996;27:15–20.

### Study design

CCG-139, which ran from November 1984 till January 1989, was a prospective randomized limited institution study.

#### Objective

The aim of the study was:

- To compare the efficacy of moderate dose intravenous methotrexate against oral methotrexate in improving overall and disease-free survival in children with intermediate risk acute lymphoblastic leukemia.

### Details of the study

Children and adolescents between 1 and 19 years of age who had no bulky lymphomatous disease and with a WBC count  $10 < 50 \times 10^9/l$  or  $WBC < 10- \times 10^9/l$  but with  $>10\%$  blasts with L2 morphology were categorized as intermediate risk and were enrolled on the study.

All patients were randomized prior to commencement of induction therapy. Details of the randomization method are not specified.

Induction and central nervous system (CNS) prophylaxis were identical for both the randomized regimens and comprised vincristine (VCR)  $1.5 \text{ mg/m}^2/\text{week} \times 5$ , prednisone (PDN)  $40 \text{ mg/m}^2/\text{day} \times 28$  days and tapered to stop over a week, L-asparaginase  $6000 \text{ U/m}^2 \times 9$  doses and intrathecal methotrexate (IT MTX) on days 1, 15 and 28. IT MTX doses were age adjusted –8, 10 and 12 mg for ages 1, 2 and 3 years or greater, respectively.

Consolidation and maintenance for regimen 1 included infusions of MTX at  $500 \text{ mg/m}^2$ . A third of the total dose was given as a bolus and the remainder as a 24 hour infusion. This was given three times during consolidation and 6 weekly during maintenance. Folinic acid rescue was at 48 and 72 hours. Maintenance therapy consisted of oral 6-mercaptopurine (6-MP)  $75 \text{ mg/m}^2/\text{day}$  and oral MTX  $20 \text{ mg/m}^2/\text{week}$  (during the 5 weeks when there was no IV MTX). VCR and PDN pulses were given 6 weekly during maintenance therapy.

Patients on regimen 2 received standard oral MTX  $20 \text{ mg/m}^2/\text{week}$ , oral 6-MP  $75 \text{ mg/m}^2/\text{day}$  with pulses of VCR and PDN given every 4 weeks during maintenance.

Duration of maintenance therapy lasted for 2 years (114 weeks) for girls and 3 years (166 weeks) for boys. The total cumulative dose of MTX in regimen 1 was  $16240 \text{ mg/m}^2$  and  $11749 \text{ mg/m}^2$  while in regimen 2 it was  $3120 \text{ mg/m}^2$  and  $2080 \text{ mg/m}^2$  in regimen 2 for boys and girls, respectively.

Median follow-up was 75 months.

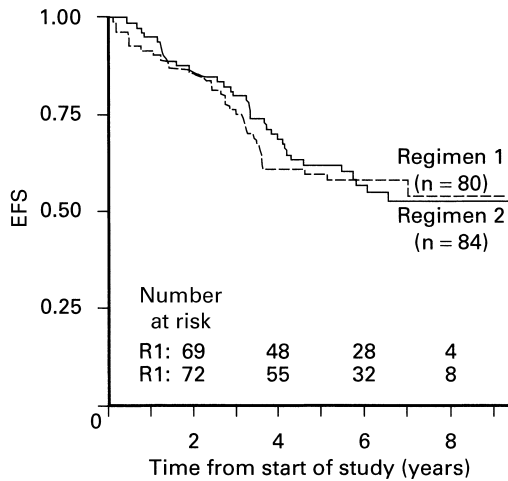
Outcome measures were event-free survival (EFS) and overall survival.

### Outcome

Though analysis was on the basis of intention to treat, the first 16 patients were non-randomly assigned to either regimen 1 ( $n = 10$ ) or 2 ( $n = 6$ ). The number of patients registered on the study was 168. Three patients in regimen 1 were removed from the study because of parent or physician preference and one because of CNS toxicity.

Of the 164 eligible patients, 80 were randomized to regimen 1 and 84 to regimen 2. A higher proportion of patients in regimen 1 were above 10 years of age.

There were 34 events among 80 regimen 1 patients (IV MTX arm): 33 relapses and 1 early death. Relapse sites were: 12 bone marrow, 14 CNS, 2 testicular, 4 combined bone marrow and CNS, and 1 CNS and testis.



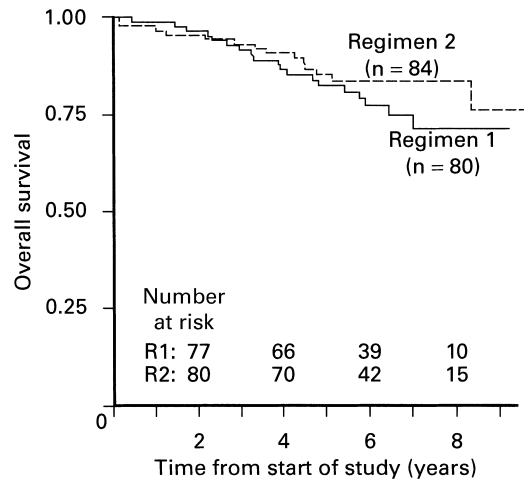
**Figure 16.22** Event free survival in CCG-139.

Reprinted from Lange *et al.* (full reference on p. 423) with permission of Wiley-Liss, Inc., a subsidiary of John Wiley & Sons, Inc.

In regimen 2 (standard arm) patients 36 events occurred: 33 relapses, 1 induction failure and 2 early deaths. Sites of relapses were similar, with 14 bone marrow, 10 CNS relapses, and 5 combined bone marrow and CNS relapse, 2 testicular, 1 combined bone marrow and testis, and in 1 patient site of relapse was not specified.

Six-year EFS for regimen 1 was 58.4% ( $\pm 5.6$ ); regimen 2, 57.4% ( $\pm 5.6$ ) ( $p = 0.92$ ) (Figure 16.22).

Relative event rate is 1.02 for regimen 1 compared to regimen 2. The frequency and distribution of relapses did not differ between the two regimens.



**Figure 16.23** Overall survival in CCG-139.

Six-year overall survival for regimen 1 was 76.9% ( $\pm 5.0$ ); regimen 2 83.1% ( $\pm 4.3$ ) ( $p = 0.31$ ) (Figure 16.23). Relative death rate was 1.43 for regimen 1 compared to regimen 2.

There were no significant differences in toxicity in the two arms.

### Conclusion

It was concluded that use of IV methotrexate in this dose and schedule did not confer any advantage over standard therapy.

## Study 13

Lilleyman JS, Richards S, Rankin A, on behalf of the Medical Research Council's Working Party on Childhood Leukaemia. Medical Research Council leukaemia trial, UKALL-VII: a report to the Council by the Working Party on Leukaemia in Childhood. *Arch Dis Childhood* 1985;**60**:1050–54.

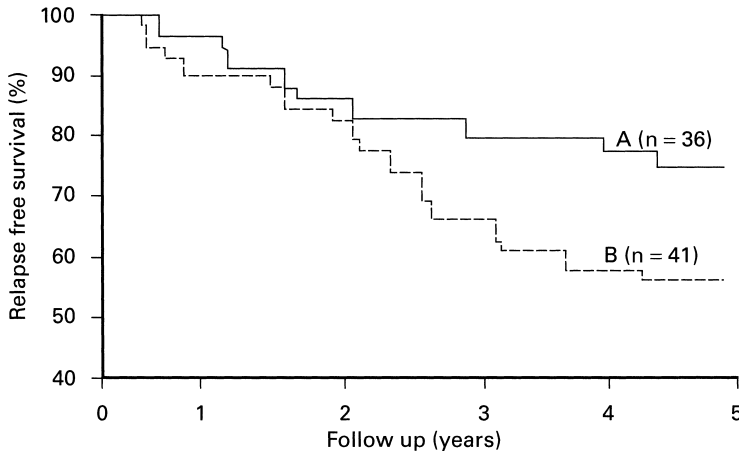
### Study design

UKALL-VII was a prospective randomised multicenter trial with enrollment open from April 1979 to March 1980.

### Objective

The aim of the study was:

- To evaluate the efficacy of a reduction in the dose of cranial irradiation and its impact on the treatment outcome in children with acute lymphoblastic leukemia. The study also had other objectives, which included the need for prophylactic testicular irradiation, the number of doses asparaginase during induction, need for extra intrathecal methotrexate (IT MTX) during maintenance and the use of oral versus intramuscular methotrexate during maintenance.



**Figure 16.24** RFS for UKALL-VII.

A: intramuscular maintenance methotrexate (relapses = 5; deaths in remission = 4). B: oral maintenance methotrexate (relapses = 17, deaths in remission = 1). Difference:  $p < 0.05$  (log-rank). Reproduced with permission of BMJ Publishing Group (full reference on p. 424).

This review focuses on the comparative efficacy of oral (OP MTX) versus intramuscular methotrexate (IM MTX) during maintenance therapy.

### Details of the study

Eligibility criteria are detailed in Chapter 15, Study 2.

There were two randomizations during maintenance therapy and both were independent of each other. Specifically, these were:

- 1 The giving of extra doses of intrathecal methotrexate (IT MTX) at 6 weekly intervals during maintenance treatment or not.
- 2 Maintenance systemic methotrexate given intramuscularly or orally.

The treatment schema is shown in Chapter 15, Figure 15.4.

The method of randomization is not specified in the report.

The outcome measure was relapse-free survival (RFS).

### Results

Of the 87 patients enrolled on the study, 8 were excluded due either to ineligibility ( $n = 5$ ) or failure to remit ( $n = 3$ ). Analysis was performed on the basis of

intention to treat as well on the basis of treatment actually received (see Table 15.1).

Forty children were randomized to IM MTX and 39 to PO MTX. As shown in Table 15.1, only 36 patients received IM MTX while 41 received PO MTX.

When the analysis was performed by the actual treatment received by the patient groups, then patients in the IM MTX group ( $n = 36$ ) had fewer relapses ( $n = 5$ ) compared to 17 in the PO MTX ( $n = 41$ ) group. In contrast, deaths in remission were lower in the PO MTX group ( $n = 1$ ) compared to 4 in the IM MTX group (Figure 16.24). This difference was statistically significant (log-rank  $p < 0.05$ ). This difference was lost when the analysis was based on the allocated treatment ( $p = 0.11$ ) as 3 of the 4 patients who should have received IM MTX subsequently relapsed.

Of 36 patients given IM MTX, 27 (75%) were alive compared with 23 of 41 (56%) given PO MTX.

### Conclusion

It was concluded (analyzed according to actual treatment received) that IM MTX was more effective than PO MTX during maintenance treatment.



# Modification of continuing therapy – schedule of therapy

## Study 14

Koizumi S, Fujimoto T, Takeda T, Yatabe M, Utsumi J, Mimaya J, Ninomiya T, Yanai M, and the Japanese Children's Cancer and Leukaemia Study Group. Comparison of intermittent or continuous methotrexate plus 6-mercaptopurine in regimens for standard risk acute lymphoblastic leukaemia in childhood (JCCLSG-S811). *Cancer* 1988;**61**:1292–1300.

### Study design

Study JCCLSG-S811 ran between (January 1981 and December 1983). It was a prospective randomized study conducted by the Japanese Children's Cancer and Leukaemia Study Group for children with standard risk acute lymphoblastic leukemia (ALL).

### Objective

The aim of the study was:

- To compare and evaluate the efficacy of intermittent cycles of 6-mercaptopurine (6-MP) and methotrexate (MTX) combined with pulses of vincristine (VCR) and prednisone (PDN) against the continuous administration of 6-MP and MTX during the maintenance phase of ALL treatment in children.

### Details of the study

Previously untreated children with standard risk ALL were enrolled on the study. Patients were stratified into prognostic risk groups according to the initial WBC count and age at diagnosis (Table 16.5).

Remission induction therapy consisted of either vincristine (VCR) 2 mg/m<sup>2</sup>/week (maximum 2 mg) × 4, or vindesine (VDS) 3 mg/m<sup>2</sup>/week (maximum 3 mg) × 4 plus prednisone (PDN) 60 mg/m<sup>2</sup>/day (maximum 60 mg) × 4 weeks. Patients not in remission at 4 weeks were given an additional 2 weeks of treatment and were withdrawn from the study if remission was not achieved at 6 weeks.

**Table 16.5** Stage of acute lymphoblastic leukaemia according to age and WBC count at diagnosis.

WBC count (×10 <sup>9</sup> /l)	Age (Years)				
	<1	1–<4	4–<6	6–<10	≥10
≤5	II	I	I	II	I + II
5–≤10	II	I	II	I + II	III
10–≤50	I + II	II	II	I + II	III
50+	III	III	III	III	III

I plus II: standard risk group; I: low risk group; II: intermediate risk group; III: high risk group.

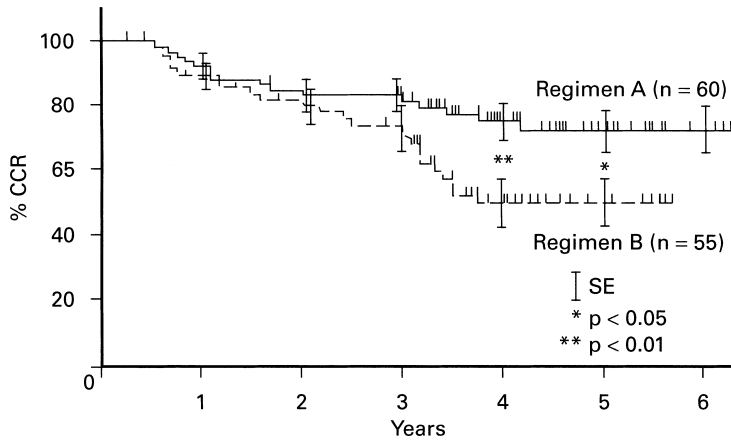
Central nervous system (CNS) prophylaxis consisted of 18 Gy cranial irradiation (15 Gy for children aged <1 year) plus three doses of intrathecal MTX 12 mg/m<sup>2</sup> (maximum 15 mg) and hydrocortisone 50 mg/m<sup>2</sup> during cranial irradiation.

On completion of CNS prophylaxis, all patients in remission were randomized to maintenance therapy of either oral 6-MP 175 mg/m<sup>2</sup>/day × 5 days alternating with MTX 225 mg/m<sup>2</sup> IV at 2 weekly intervals and combined with pulses of VCR 2 mg/m<sup>2</sup> and PDN 120 mg/m<sup>2</sup>/day × 5 days (intermittent cycle: regimen A) or oral 6-MP 50 mg/m<sup>2</sup>/day plus oral MTX 20 mg/m<sup>2</sup>/week combined with VCR and PDN every 4 weeks at the same dosage as regimen A. (continuous cycle: regimen B).

Details of the method of randomization are not given in the report.

Patients who remained in clinical remission for 2 years were given five courses of high dose MTX with folinic acid rescue (late intensification therapy).

Treatment was complete after 3 years of maintenance therapy. Boys also had testicular biopsies prior to discontinuation of treatment.



**Figure 16.25** Kaplan–Meier analysis of duration of initial continuous complete remission (CCR). The CCR was significantly longer among patients on regimen A ( $Z = 2.0983$ ;  $p < 0.05$  by the generalised Wilcoxon test). Reprinted from Koizumi *et al.* (full reference on p. 426) with permission of Wiley-Liss Inc., a subsidiary of John Wiley & Sons, Inc.

The outcome measure was continuous clinical remission (CCR).

### Outcome

Of the 131 patients enrolled on the study, 119 patients were considered eligible for analysis (12 were excluded due to incorrect diagnosis, wrong treatment stratification, major protocol violations, early death or due to refusal of treatment). A total of 115 patients achieved clinical remission and completed CNS prophylaxis treatment. Sixty patients were randomized to regimen A maintenance therapy and 55 patients to regimen B.

The median duration of initial CCR for patients in regimens A and B was 46 (5–75) and 39 (2–68) months, respectively.

The CCR rate for patients in regimens A and B was  $75.1 \pm 5.8\%$  (mean  $\pm 1$  SE) and  $49.7 \pm 7.3\%$  at 4 years ( $p = 0.001$ ) and  $72.1 \pm 6.3\%$  and  $49.7 \pm 7.3\%$  at 5 years ( $p < 0.05$ ), respectively (Figure 16.25).

There was an increased incidence of bone marrow, CNS and testicular relapses in regimen B patients especially, after 3 years of CCR.

### Toxicity

Patients treated on regimen B had a higher incidence of infective episodes compared to regimen A patients. Two regimen B patients died of viral encephalitis during CR and 17 patients developed varicella zoster infections compared to none in regimen A.

### Conclusion

It was concluded that intermittent administration of 6-MP and MTX was superior to the continuous administration of both drugs during maintenance therapy in children with standard risk ALL.

## Study 15

Chessells JM, Durrant J, Hardy RM, Richards S. Report to the Council by the Working Party on Leukaemia in Childhood. Medical Research Council Leukaemia Trial UKALL-V: an attempt to reduce the immunosuppressive effects of therapy in childhood acute lymphoblastic leukaemia. *J Clin Oncol* 1986;4:1758–64.

### Study design

UKALL-V ran from January 1976 to March 1979 and was a prospective randomized multicenter trial with three built-in randomizations.

### Objectives

The study aimed:

- To compare the relative efficacy of maintenance treatment with oral 6-mercaptopurine and methotrexate given as:
  - A continuous regimen.
  - A semi-continuous regimen.
  - A 5-day pulse every 3 weeks.

**Table 16.6** Prognostic variables and maintenance chemotherapy.

Event	Relapse and/or Death in Remission <sup>a</sup>			Marrow Relapse as First Event <sup>b</sup>			CNS Relapse as First Event <sup>c</sup>			Testicular Relapse as First Event		
	Obs.	Exp.	p	Obs.	Exp.	p	Obs.	Exp.	p	Obs.	Exp.	p
Sex												
M	165	140.1		107	98.9		16	16.0				
F	118	142.9	0.001	93	101.1	0.1	16	16.0	0.5			
Age												
<3	57	57.2		42	40.4		6	6.4		7	8.6	
≥3	226	225.8	0.5	158	159.6	0.4	26	25.6	0.4	30	28.4	0.3
WBC(10 <sup>9</sup> /l)												
<10	196	217.6		137	153.8		22	24.5		27	28.2	
≥10	87	65.4	0.002	63	46.2	0.003	10	7.5	0.2	10	8.8	0.3
Chemotherapy												
C	84	93.5		53	66.2		10	10.5		11	11.4	
G	89	96.8	0.02	61	68.5	0.002	9	10.9	0.3	14	13.3	0.5
I	110	92.7		86	65.3		13	10.6		12	12.3	
Chemotherapy												
C and G	173	190.3		114	134.7		19	21.4		25	24.7	
I	110	92.7	0.02	86	65.3	0.001	13	10.6	0.2	12	12.3	0.5
Total number of events		283			200			32			37	

Obs.: observed event; Exp.: expected event.

<sup>a</sup>Twenty-three deaths in remission, 3 relapses of other type.

<sup>b</sup>Four combined bone marrow and CNS relapses, 5 bone marrow and testicular relapses.

<sup>c</sup>Three combined CNS and testicular relapses.

## Details of the study

For details of patient eligibility criteria, treatment and statistical analysis, refer to Study 3 in Chapter 16.

The outcome measure was disease-free survival (DFS). All analysis was based on intention to treat.

## Outcome

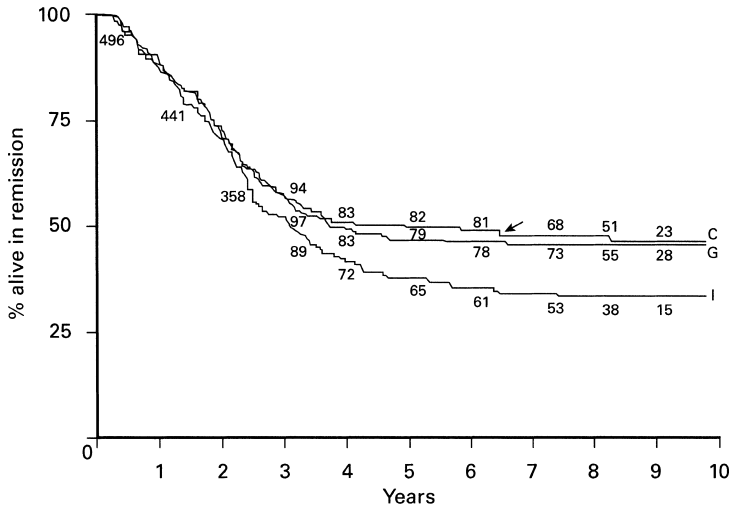
Of the 550 patients registered on the trial, 22 were excluded (previous chemotherapy, diagnostic error). All 496 patients who achieved remission after induction chemotherapy were randomized to one of three maintenance regimens: regimen C (continuous)  $n = 161$ , regimen G (semi-continuous)  $n = 166$  and regimen I (intermittent) = 169.

Patients randomized to either to regimen C or G had significantly lower bone relapses and superior DFS compared to the patients randomized to regimen I (Table 16.6). The 7-year DFS was (95% CI)  $48.4 \pm 7.64\%$  in group C  $46.4 \pm 7.64\%$  in group G and  $35.1 \pm 7.25\%$  in group I (Figure 16.26).

Remission deaths were more common in regimen C and G patients compared to regimen I patients ( $p < 0.025$ ).

## Conclusion

It was concluded that intermittent continuing (maintenance) therapy was less effective than conventional continuing therapy in the treatment of childhood ALL.



**Figure 16.26** DFS in patients receiving continuous (C), intermediate (G) or intermittent (I) chemo therapy. The arrow represents the child with a brain tumour. The numbers refer to patients at risk at the start of each year. Up to 2 years, the numbers represent all patients; thereafter, those in the individual groups. At 7 and 8 years SE  $\pm$  3.9 for groups C and G,  $\pm$ 3.7 for group I. At 9 years, SE  $\pm$  4.0 for group C,  $\pm$ 3.9 for group G and  $\pm$ 3.7 for group I. © American Society of Clinical Oncology (full reference on p. 428).

## Study 16

Vilmer E, Suci S, Ferster A, Bertrand Y, Cave H, Thyss A, Benoit Y, Dastugue N, Fournier M, Souiller G, Manel A-M, Robert A, Nelken B, Millot F, Lutz P, Rialland X, Mechinaud F, Boutard P, Behar C, Chantraine J-M, Plouvier E, Laureys G, Brock P, Uyttebroeck A, Margueritte G, Plantaz D, Norton L, Francotte N, Gyselinck JL, Waterkeyn C, Solbu G, Philippe N, Otten J. Long term results of three randomised trials (58831, 58832, 58881) in childhood acute lymphoblastic leukaemia: a CLCG-EORTC report. *Leukaemia* 2000; **14**:2257–66.

### Study design

Trial 58881 was a prospective randomized trial carried out from 1989 to 1998.

### Objectives

The aim of the trial was to determine:

- The toxicity and efficacy of two types of L-asparaginase, *E. coli* (standard arm) and *Erwinia* (experimental arm) when administered at equal dosage.
- Whether high dose cytosine arabinoside (1 g/m<sup>2</sup> 12 hourly  $\times$  2) combined with high dose methotrexate during interval therapy reduced the incidence of CNS relapse and improved outcome.
- Whether the addition of monthly intravenous (IV) 6-mercaptopurine (1 g/m<sup>2</sup>) during maintenance therapy to conventional maintenance improved disease-free survival.

Here we focus primarily on the use of intravenous (IV) 6-mercaptopurine during acute lymphoblastic leukemia maintenance therapy and its effect in improving disease-free survival (DFS).

### Details of the study

All patients below 18 years of age were eligible to be registered on this study. Patients were categorized into two risk groups: standard risk (SR) and very high risk (VHR). VHR patients were those who had  $>1000$  blasts/mm<sup>3</sup> in the peripheral blood at the end of 7 days of prednisone monotherapy and one intrathecal dose of methotrexate, those who die not achieve complete remission or those with a t(4; 11) or t(9; 22) translocation present in the leukemic clone. All others were considered SR.

All patients received the same induction regimen. Tables 16.7 and 16.8 show the treatment schema for SR and VHR patients, respectively. For SR patients a total of 10 intrathecal methotrexate (IT MTX) injections were scheduled during the intensive phases of treatment but none planned during maintenance.

VHR patients received an intensified treatment for 1 year followed by two series of three Berlin–Frankfurt–Murster (BFM) type chemotherapy regimens (R1, R2 and R3). Central nervous system (CNS) prophylaxis consisted of ten injections of IT MTX and six injections of triple IT chemotherapy (MTX, cytosine arabinoside and steroids), including ten courses of high dose MTX during the 1st year of treatment.

**Table 16.7** EORTC-CLCG 58881: treatment protocols for standard risk patients.

Treatment phase/drug	Dose	Days given
Induction – consolidation:		
Protocol IA		
Prednisolone	60 mg/m <sup>2</sup>	1–28
Vincristine	1.5 mg/m <sup>2</sup>	8, 15, 22, 29
Daunorubicin	30 mg/m <sup>2</sup>	8, 15, 22, 29
Methotrexate (IT)	12 mg (age dependent)	1, 8, 22, 38, 52
L-Asparaginase <sup>a</sup>	10,000 IU/m <sup>2</sup>	12, 15, 18, 22, 25, 29, 35, 38
Protocol IB		
Cyclophosphamide	1 mg/m <sup>2</sup>	36, 63
Cytosine arabinoside	75 mg/m <sup>2</sup>	38–41, 45–48, 52–55, 59–62
6-Mercaptopurine	60 mg/m <sup>2</sup>	36–63
Interval therapy		
6-Mercaptopurine	25 mg/m <sup>2</sup>	1–56
Methotrexate (24 hours infusion)	5 g/m <sup>2</sup>	8, 22, 36, 50
Methotrexate (IT)	12 mg (age dependent)	9, 23, 37, 51
According to randomisation <sup>b</sup>		
Cytosine arabinoside	1 g/m <sup>2</sup> (twice 12 hours interval)	9, 23, 37, 51
Reinduction: protocol II		
Dexamethasone	10 mg/m <sup>2</sup>	1–21
Vincristine	1.5 mg/m <sup>2</sup>	8, 15, 22, 29
Doxorubicin	30 mg/m <sup>2</sup>	8, 15, 22, 29
L-Asparaginase <sup>a</sup>	10,000 IU/m <sup>2</sup>	8, 11, 15, 18
Methotrexate (IT)	12 mg (age dependent)	38
Cyclophosphamide (IV)	1 mg/m <sup>2</sup>	36
Cytosine arabinoside	75 mg/m <sup>2</sup>	36–41, 45–48
6-Thioguanine	60 mg/m <sup>2</sup>	36–49

<sup>a</sup>Patients, regardless of their risk group, were randomly assigned to receive *E. coli* asparaginase or *Erwinia* asparaginase at equal dosages.

<sup>b</sup>Patients in complete remission, with an initial RF > 0.8 or with a T-lineage ALL and without VHR features, were eligible for this randomization.

Maintenance therapy commenced 2 weeks after Protocol II or after the last R3 block and consisted of daily oral mercaptopurine (initial dose 50 mg/m<sup>2</sup>) and MTX (20 mg/m<sup>2</sup> weekly). For all patients the total duration of treatment was 2 years.

The outcome measure was DFS.

No details of the randomization method are given in the report.

## Outcome

Of the 2078 patients registered on the trial, only 2065 were evaluable, of whom 2019 patients (97.8%) achieved complete remission; 820 patients were randomized to either to the conventional maintenance therapy (without IV mercaptopurine) or to the experimental arm with monthly IV mercaptopurine added to conventional maintenance treatment. There were no differences on

either the prognostic factors or the in type of asparaginase received by both groups of patients.

The 5-year DFS in the group that received IV mercaptopurine was 71.2 ± 2.3% compared to 78.6 ± 2.1% of the conventional maintenance group (log-rank  $p < 0.027$ ). The difference was more marked in those who were also randomized to the less potent *Erwinia* asparaginase (59.2 ± 4.8% versus 74.5 ± 4.3%; hazard ratio (HR) 1.71) compared to the group randomised to *E. coli* asparaginase (78.2 ± 3.9% versus 78.4 ± 3.9%; HR 1.08).

## Conclusion

The addition of IV 6-mercaptopurine to conventional maintenance during maintenance therapy was deleterious and increased the risk of late relapse.

**Table 16.8** EORTC-CLCG 58881: treatment protocol for VHR patients.

Treatment element/drug	Dose	Days given
<b>Protocol IB</b>		
Cyclophosphamide	1 g/m <sup>2</sup>	43 and 85
Methotrexate (24 hours infusion)	5 g/m <sup>2</sup>	43, 57, 71
Cytosine arabinoside	1 g/m <sup>2</sup>	50, 51, 64, 65, 78, 79
L-Asparaginase	25,000 IU/m <sup>2</sup>	44, 51, 58, 65, 72, 79
6-Mercaptopurine (PO)	25 mg/m <sup>2</sup>	43–84
Methotrexate (IT)	12 mg (age dependent)	44, 58, 72
<b>VANDA</b>		
Dexamethasone	20 mg/m <sup>2</sup>	1–5
Cytosine arabinoside	2 g/m <sup>2</sup> (twice, 12 hours interval)	1, 2
Mitoxantrone	8 mg/m <sup>2</sup>	3, 4
Etoposide	150 mg/m <sup>2</sup>	3, 4, 5
L-Asparaginase	10,000 IU/m <sup>2</sup>	7, 9, 11, 13
Methotrexate (IT)	12 mg (age dependent)	5
<b>Interval therapy</b>		
6-Mercaptopurine (PO)	25 mg/m <sup>2</sup>	1–42
Methotrexate (24 hours infusion)	5 g/m <sup>2</sup>	8, 22, 36
Cytarabine (10 min infusion)	1 g/m <sup>2</sup> (twice, 12 hours interval)	9, 23, 37
Methotrexate (IT)	12 mg (age dependent)	9, 23, 37
<b>Bloc R1</b>		
Dexamethasone	20 mg/m <sup>2</sup>	1–5
6-Mercaptopurine	100 mg/m <sup>2</sup>	1–5
Vincristine	1.5 mg/m <sup>2</sup>	1,6
Methotrexate (24 hours infusion)	5 g/m <sup>2</sup>	1
Cytosine arabinoside	2 g/m <sup>2</sup> (twice 12 hours interval)	5
L-Asparaginase	25,000 IU/m <sup>2</sup>	6
Methotrexate/cytosine arabinoside/prednisone (IT)	12 mg/30 mg/10 mg	1
<b>Bloc R2</b>		
Dexamethasone	20 mg/m <sup>2</sup>	1–5
6-Thioguanine	100 mg/m <sup>2</sup>	1–5
Vincristine	3 mg/m <sup>2</sup>	1
Methotrexate (24 hours infusion)	5 g/m <sup>2</sup>	1
Ifosfamide	400 mg/m <sup>2</sup>	1–5
Daunorubicin	50 mg/m <sup>2</sup>	5
L-Asparaginase	25,000 IU/m <sup>2</sup>	6
Methotrexate/cytosine arabinoside/prednisone (IT)	12 mg/30 mg/10 mg	1
<b>Bloc R3</b>		
Dexamethasone	20 mg/m <sup>2</sup>	1–5
Cytosine arabinoside	2 g/m <sup>2</sup> (twice, 12 hours interval)	1, 2
Etoposide	150 mg/m <sup>2</sup>	3, 4, 5
L-Asparaginase	25,000 IU/m <sup>2</sup>	6
Methotrexate/cytosine arabinoside/prednisone (IT)	12 mg/30 mg/10 mg	5

## Study 17

Kjeld Schmiegelow, Olle Björk, Anders Glomstein, Göran Gustafsson, Niels Keiding, Jon Kristinsson, Anne Mäkiperna, Susanne Rosthøj, Carol Szumlanski, Tine M Sørensen, and Richard Weinshilboum. Intensification of Mercaptopurine/Methotrexate maintenance chemotherapy may increase the risk of relapse for some children with acute lymphoblastic leukemia. *J. Clin Oncol* 2003;21:1332–1339.

### Study design

The Nordic Society of Paediatric Haematology and Oncology (NOPHO) ALL-92 was a multicenter prospective randomized trial that ran from January 1992 till December 1996.

### Objectives

The study aimed:

- To explore whether dose adjustment of 6-mercaptopurine (6-MP) and methotrexate (MTX) by erythrocyte (E) levels of thioguanine nucleotides (TGN) and MTX including MTX polyglutamates could improve outcome in children with childhood acute lymphoblastic leukemia (ALL)

### Details of study

Nordic children between the ages of 1 and 14.9 years of age with precursor B childhood acute lymphoblastic leukemia (ALL) were included in this study. All Finnish high risk (HR) and all very high risk (VHR) patients were excluded from the trial. Patient characteristics including criteria for risk stratification are shown in Table 16.9.

All patients were randomized within 2 weeks of the start of maintenance therapy (MT). Patients were randomly assigned to have their doses of 6-MP and methotrexate (MTX) adjusted by blood counts (control group) or by a combination of blood counts and E-TGN  $\times$  MTX (the product of E-TGN and E-MTX; pharmacology group). They were then stratified by risk groups (3 divisions) and by country of origin (5 divisions) within blocks of 6 patients. Thus there were 15 subgroups defined by risk category and country, with 3 patients each assigned to either the control group or pharmacology group for every 6 randomized patients. Patients who relapsed or underwent bone marrow transplantation prior to commencement of MT were ineligible for the study.

Induction therapy consisted of prednisolone (PDN) 60 mg/m<sup>2</sup>/day on days 1–36 and tapered thereafter, weekly vincristine (VCR) 2 mg/m<sup>2</sup>  $\times$  6, doxorubicin (DNR) 40 mg/m<sup>2</sup> ( $\times$ 3 non-HR) and ( $\times$ 4 HR), *Erwinia* asparaginase (EASP) (30,000 U/m<sup>2</sup>  $\times$  10) and intrathecal (IT) MTX  $\times$  4.

Consolidation therapy consisted of high dose MTX (HDMTX) 5 g/m<sup>2</sup>  $\times$  3 for standard risk (SR-ALL) patients. Intermediate risk (IR) and high risk (HR) patients received cyclophosphamide (total cumulative dose 3 g/m<sup>2</sup>), low dose cytarabine (ARA-C) and either 6-mercaptopurine (6-MP) or 6-thioguanine (6-TG) alternating with HDMTX (5 g/m<sup>2</sup>  $\times$  4 with oral 6-MP) for IR patients and HDMTX 8 g/m<sup>2</sup> plus high dose ARA-C (12 g/m<sup>2</sup>)  $\times$  4 for HR patients. All IR and HR patients also received 4 months of weekly oral MTX plus daily 6-MP, VCR and PDN.

Following consolidation therapy, all patients underwent re-induction with weekly DNR (30 mg/m<sup>2</sup>)  $\times$  3 for IR and  $\times$ 4 for HR, 3 weeks of oral dexamethasone (10 mg/m<sup>2</sup>), weekly VCR  $\times$  4 and EASP (30,000 u/m<sup>2</sup>)  $\times$  4.

MT consisted of daily oral 6-MP (75 mg/m<sup>2</sup>) and weekly oral MTX (20 mg/m<sup>2</sup>) and commenced on week 13 for SR patients, at week 32 for IR or at week 63 for HR patients. Total duration of therapy was 2 years for SR and IR patients and 2.5 years for HR patients. During the 1st year of MT, SR and IR patients also received alternate pulses of VCR (2 mg/m<sup>2</sup>/dose) and PDN (60 mg/m<sup>2</sup>/day  $\times$  1 week) or HDMTX (5 g/m<sup>2</sup>) at 4 weekly intervals until 5 doses of IV HDMTX were administered. HR patients received regular reinforcements with weekly VCR (1.5 mg/m<sup>2</sup>) and oral PDN (40 mg/m<sup>2</sup>  $\times$  1 week) with IT MTX at 8 weekly intervals throughout MT.

### 6-MP and MTX dose adjustments: control group

6-MP and MTX doses were titrated so as to maintain white blood counts (WBC) between 1.5 to 3.5  $\times$  10<sup>9</sup>/l. Doses were reduced by 50% when WBC was  $<$ 1.5  $\times$  10<sup>9</sup>/l. Treatment was interrupted when WBC was  $<$ 1.0  $\times$  10<sup>9</sup>/l and or platelets  $<$ 100  $\times$  10<sup>9</sup>/l. If the WBC was  $>$ 3.5  $\times$  10<sup>9</sup>/l, the doses of 6-MP and MTX were escalated as per protocol recommendations until WBC was within the target range. Blood counts were measured at 1–2 weekly intervals.

**Table 16.9** Characteristics.

Risk Criteria	SR-ALL <sup>a</sup>	IR-ALL <sup>b</sup>	HR-ALL <sup>c</sup>
Eligible at diagnosis <sup>d</sup>	263	264	114
Induction death	2	2	7
Relapse prior to MT	1		17
Death in CCR prior to MT	3	2	4
Bone marrow transplantation prior to MT			3
Not treated according to NOPHO protocol and risk group	12	16	19
Eligible but not randomly assigned	2	9	4
Total number randomly assigned	243	235	60
Pharmacology/control	122/121	116/119	31/29
DK/I/SF/N/S	46/4/50/50/93	54/4/51/40/86	14/0/0/15/31
Male/female	129/114	123/112	36/24
Age, years <sup>e</sup>	4.1	4.0	3.6
Range	2.6–7.1	1.9–12.5	2.2–6.7
WBC <sup>e</sup>	4.2	14.7	64
Death in CCR	1	1	1
Second cancer	3	2	1
Relapse	20	35	11
Bone marrow	15	32	11

CCR: complete continuous remission; DK/I/SF/N/S: Denmark, Iceland, Finland, Norway, Sweden.

<sup>a</sup>Age: 2.0–9.9 years and WBC  $<10 \times 10^9/l$ ; no HR criteria.

<sup>b</sup>Age: 1.0–1.9 years or  $>10.0$  years and/or WBC  $10\text{--}49 \times 10^9/l$ ; no HR criteria.

<sup>c</sup>WBC  $\geq 50 \times 10^9/l$ ; T-cell, mediastinal; CNS, testicular, or lymphomatous disease, f(4;11), f(9;22), or 22q, and MC M3 D14 or M2/3 d 29 BM.

<sup>d</sup>Age: 1.0–14.9 years, diagnosed in 1992–1996 with non-B non-VHR ALL (and not finish HR-ALL), and starting maintenance therapy before January 1, 1997. VHR status is assigned if age  $\geq 5$  years and, in addition, T-cell disease is present with one or more additional HR features, CNS leukemia, or HR-ALL criteria at diagnosis, and a day 29 M2/3 bone marrow.

<sup>e</sup>Median age or WBC at diagnosis (75% range).

### 6-MP and MTX dose adjustments: pharmacology group

The doses of 6-MP and MTX were adjusted according to WBC and platelet counts similar to the control group. In addition and unless the WBC was  $<1.5 \times 10^9/l$ , the doses of both drugs were adjusted upwards in steps of 20% when the E-TGN  $\times$  MTX was  $<1350$  nmol/mmol Hb and the treating physician felt that such dose escalations were tolerable. This E-TGN  $\times$  MTX value represented 225 nmol/mmol Hb for E-TGN and 6 nmol/mmol Hb for E-MTX and both were 25% above the median levels that discriminated between

good and poor risk patients in the earlier NOPHO ALL-88 study. Dose adjustments for 6-MP were made prior to MTX until E-TGN was  $>225$  nmol/mmol Hb. However if this E-TGN value was not achieved within 8 weeks, patients had upward adjustments of 6-MP and/or MTX at the discretion of the treating physician. From July 1998, dose adjustments based on E-TGN  $\times$  MTX value was discontinued and 6-MP and MTX dose adjustments were based on blood counts alone.

Outcome measures included relapse rates, event-free survival (EFS) and overall survival (OS).



**Table 16.10** Distribution of events by sex, risk group and randomization group.

Gender	Risk Group	Stratification	CCR <sup>a</sup>	Relapse	Death in CCR	Second Cancer <sup>b</sup>
Male	Standard risk	Pharmacology group	49	11		
		Control group	58	10		1
	Intermediate risk	Pharmacology group	49	9		
		Control group	50	15		
	High risk	Pharmacology group	14	2		1
		Control group	14	4	1	
Female	Standard risk	Pharmacology group	53	7		2
		Control group	50	0	1	1
	Intermediate risk	Pharmacology group	44	12	1	1
		Control group	49	4		1
	High risk	Pharmacology group	10	4		
		Control group	9	1		

CCR: complete continuous remission.

<sup>a</sup>Patients in first remission December 31, 2002.

<sup>b</sup>Second cancers include 1 malignant brain tumor and 6 myelodysplasias or acute myeloid leukemias.

## Outcome

Of the 641 eligible patients enrolled in the trial, 538 were randomized to have their doses of 6-MP and MTX adjusted by blood counts alone ( $n =$  or by a combination of blood counts and E-TGN  $\times$  MTX levels. Reasons for exclusion included an event prior to randomization ( $n = 38$ ), bone marrow transplantation during remission ( $n = 3$ ), protocol violations ( $n = 47$ ) and non-randomization ( $n = 15$ ).

The median follow up of all patients who remained in remission was 93 months. The 9-year EFS for the 538 children who entered the study was  $0.83 \pm 0.02$  (SR,  $0.85 \pm 0.03$ ; IR,  $0.81 \pm 0.03$ , HR,  $0.79 \pm 0.07$ ).

The number of relapses in the control group was 34/269 (13%) compared to 45/269 (17%) in the pharmacology group with the majority ( $n = 66$ ) occurring after completion of therapy (Table 16.10). The risk of relapse was 6.6 fold higher for girls in the pharmacology group compared with those in the control group (9-year cumulative risk of relapse:  $19 \pm 5\%$  versus  $5 \pm 2\%$ ;  $p = 0.001$ , Table 16.11; Figure 16.27). No significant differences in the relapse rates were observed between the 2 groups for boys.

## Dose of 6-MP and MTX

Boys received significantly higher doses of both 6-MP (median 61.3 mg versus 57.2 mg;  $p = 0.01$ ) and MTX (median 16.2 mg versus 14.6 mg;  $p = 0.0007$ ) than did girls. Significantly, girls in the pharmacology group had greater cumulative 6-MP treatment interruptions

compared with those in the control group (median for girls 8% versus 5% of the total duration of MT;  $p = 0.01$  compared with the median for boys 6% versus 5%;  $p = 0.29$ ). Though there were no differences in the average dose of 6-MP or MTX, for those who relapsed or remained in remission, however, 13 patients who relapsed on treatment (10 were boys) received lower doses of 6-MP (12.6 mg versus 15.2 mg;  $p = 0.01$ ) and MTX (49 mg versus 59.3 mg;  $p = 0.06$ ).

## Thiopurine methyl transferase

Thiopurine methyl transferase (TPMT) enzyme activity was similar in both the control and pharmacology groups. TPMT levels were higher in the 62 patients who relapsed off therapy compared with those patients who remained in remission (median for girls 19.5 versus 17.4 U/ml;  $p = 0.03$  and median for boys 19.3 versus 18 U/ml;  $p = 0.04$ ). Conversely, TPMT levels were not significantly different between the 12 patients who relapsed on therapy compared with those who remained in remission ( $p = 0.61$ ).

## E-TGN, E-MTX and blood counts

Though mE-TGN (mean erythrocyte thioguanine nucleotide) levels were similar in both girls and boys who remained in remission (169 versus 169 nmol/mmol Hb;  $p = 0.31$ ). However, mE-TGN levels were significantly lower in patients who relapsed while on therapy compared with those who stayed in remission (104 versus 179 nmol/mmol Hb;  $p = 0.005$ ). In

**Table 16.11** Coefficients in the Cox Hazard Models: relapses only<sup>a</sup>.

Parameter	Beta	SE, $\beta$	Relapse hazard	p
Sex <sup>b</sup>	1.99	0.61	7.3	0.00003
WBC at diagnosis	$5.61 \times 10^{-3}$	$2.26 \times 10^{-3}$	1.01	0.03
Randomization group <sup>c</sup>	1.89	0.620	6.6	0.0003
Randomization group $\times$ sex <sup>d</sup>	-2.02	0.684	0.13	0.0007
mANC <sup>e</sup>	0.609	0.175	1.83	0.0009
TPMT activity	0.101	0.033	1.1	0.002

mANC: absolute neutrophil count; TPMT: thiopurine methyltransferase.

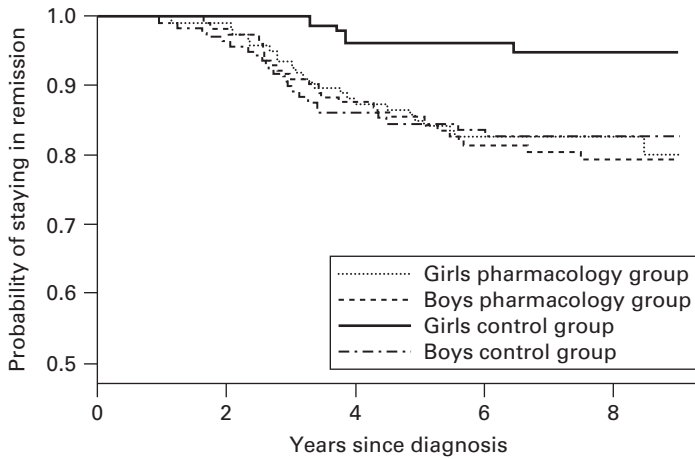
<sup>a</sup>Death in remission and second cancers were counted as censoring events.

<sup>b</sup>0 for girls, 1 for boys.

<sup>c</sup>0 for control, 1 for pharmacology.

<sup>d</sup>The interaction between sex and randomization group, 1 for boys in pharmacology group, 0 for all other.

<sup>e</sup>Mean absolute neutrophil count during maintenance therapy was analyzed as a time-dependent continuous variable. Overall p value of the Cox model <0.0001.



**Figure 16.27** Kaplan–Meier curves for risk of relapse for boys and girls with respect to randomization group. © American Society of Clinical Oncology (full reference on p. 434).

Patients at risk by year from diagnosis	0	1	2	3	4	5	6	7	8	9
Girls control group	116	116	115	114	109	109	97	71	52	23
Girls pharmacology group	134	134	132	123	116	112	97	76	47	19
Boys pharmacology group	153	152	148	139	133	130	110	84	51	28
Boys pharmacology group	135	135	131	119	115	113	98	70	48	25

contrast, there was no difference in mE-TGN levels in patients who relapsed off therapy compared with those who remained in remission.

Mean absolute neutrophil counts (m-ANC) were significantly higher in patients who relapsed when compared with patients who remained in remission ( $2.2$  versus  $1.9 \times 10^9/l$ ;  $p = 0.0008$ ) but did not differ significantly in their average lymphocyte counts. For both sexes, patients with m-ANC  $< 2.0 \times 10^9/l$  had an

improved outcome compared with patients with higher m-ANC (boys;  $0.87$  versus  $0.75$ ;  $p = 0.02$  and girls;  $0.94$  versus  $0.83$ ;  $p = 0.01$ )

### Conclusion

It was concluded that pharmacologically guided dose escalations of 6-MP and MTX significantly increased the risk of relapse for in girls.

# Modification of continuing therapy – type of thiopurine

## Study 18

Harms DO, Janka-Schaub GE, “On behalf of the COALL Study Group. Co-operative Study Group for childhood acute lymphoblastic leukaemia (COALL): long-term follow up of trials of 82, 85, 89 and 92. *Leukaemia* 2000;14:2234–8.

### Study design

COALL-92 trial was a prospective randomized multi-center study that ran from February 1992 to July 1997.

### Objectives

The aim of the study was:

- To determine whether the use 6-thioguanine (6-TG) during maintenance therapy offered a therapeutic advantage over 6-mercaptopurine (6-MP).

### Details of the study

Children and adolescents between the ages of 1 and 18 with previously untreated acute lymphoblastic leukemia (ALL) were enrolled on the study.

Table 16.12 summarizes the COALL-92 treatment schedule. Detailed information of the chemotherapy schedule has been previously published.<sup>1–5</sup> Cranial irradiation was given to high risk patients only. Patients were randomized to either 6-MP or 6-TG during the maintenance phase of treatment.

Log-rank tests were used to evaluate the differences in the event-free survival (EFS) between the patient groups.

Outcome measures were event free survival (EFS) and overall survival (OS).

All analyses were performed on an intention to treat basis.

### Outcome

Randomization details were not given in the report. A total of 578 patients were enrolled on the study;

**Table 16.12** Protocols COALL-92.

	High Risk	Low Risk
Prephase induction	VD × 4 +P PO × 28	VD × 4 +P PO × 28
Intensification	CYC × 2 +ID MTX × 2 +ASP × 4 +MP PO IDMTX × 2 +VM-26 × 2 +AC × 2 +TG PO HDAC 2 × 4 +ASP × 4	IDMTX +ASP × 2 +MP PO IDMTX +VM-26 + AC +TG PO HDAC × 4 +ASP × 2 IDMTX +ASP × 2 +MP PO
CNS prophylaxis	C-/Pre-B-ALL + WBC <25/50 × 10 <sup>9</sup> /l ITMX + MP PO all others +CRT 12–18 Gy	ITMX + MP PO
Reinduction	VA × 4 +ASP × 4 +DEX PO × 28 CYC × 2 +AC 4 × 4 +TG PO	VA × 2 + ASP × 2 +DEX PO × 14 CYC + AC × 4 +TG PO
Maintenance	MP or TG + MTX	MP or TG + MTX PO

V: vincristine; D: daunorubicin; P: prednisone; ASP: L-asparaginase; CYC: cyclophosphamide; HDMTX: high dose methotrexate; AC: cytosine arabinoside; MP: mercaptopurine; ITMX: intrathecal methotrexate; CR: cranial irradiation; VA: doxorubicin; VM-26: teniposide; TG: thioguanine; IDMTX: intermediate dose methotrexate; HDAC: high dose cytosine arabinoside; DEX: dexamethasone; PO: orally.

40 were excluded because of previous treatment elsewhere. Of the 538 eligible patients, 474 (88%) were randomized between 6-TG (n = 236) and 6-MP (n = 238) during maintenance therapy.

Five-year EFS for the entire cohort was  $76.9 \pm 1.9\%$ . The 5-year EFS for patients on 6-TG was  $80.1 \pm 2.9\%$  versus  $82.8 \pm 2.6\%$  for patients on 6-MP. Analysis according to risk status (LR and HR) showed no significant differences. The use of 6-TG during maintenance was not significantly superior to 6-MP.

### **Toxicity**

Hematological toxicity, especially thrombocytopenia, was greater with 6-TG. Non-hematological toxicity was similar for both drugs.

### **Conclusion**

It was concluded that maintenance treatment with 6-TG had no impact on outcome, whether stratified for risk status or lineage.

# Modification of continuing therapy – addition of other drugs

## Study 19

Kamps WA, Bokkerink JP, Hakvoort-Cammel FG, Veerman AJ, Weening RS, van Wering ER, van Weerden JF, Hermans J, Slater R, van den Berg E, Kroes WG, van der Does-van den Berg A. BFM-oriented treatment for children with acute lymphoblastic leukemia without cranial irradiation and treatment reduction for standard risk patients: results of DCLSG protocol ALL-8 (1991–1996). *Leukaemia* 2002;**16**:1099–111.

### Study design

The Dutch Childhood Leukaemia Study Group (DCLSG) ALL-8 was a multicenter prospective randomized trial that ran from October 1991 to December 1996.

### Objectives

The study aims were:

- To determine whether the use of high dose intramuscular L-asparaginase (IM HD L-ASP) during the maintenance phase of treatment could improve outcome in children and adolescents with standard risk childhood lymphoblastic leukemia (SRG ALL)
- To evaluate the efficacy of high dose intravenous mercaptopurine (IV 6-MP) during the interim maintenance (Protocol M) phase of therapy on the treatment outcome of children and adolescents with medium risk ALL (MRG ALL)
- This review only focuses on the efficacy of HD L-ASP during maintenance in SRG ALL.

### Details of study

The DCLSG ALL-8 trial was open to all children and adolescents up to the age of 18 years with *de novo* standard risk acute lymphoblastic leukemia (ALL). Patients with mature B cell ALL or patients who received corticosteroids and or other chemotherapy drugs within

the 4 weeks of diagnosis were excluded from the study. Patients were stratified into 3 risk groups: standard risk (SRG ALL), medium risk (MRG ALL) and high risk (HRG ALL) according to the BFM ALL 90 trial (Table 16.13). The Berlin–Frankfurt–Munster (BFM) risk factor was calculated according to the 3 initial factors: circulating peripheral blasts, liver and spleen size (BFM RF =  $0.2 \times \log(\text{number of circulating blasts in peripheral blood}/\text{mm}^3 + 1) + (0.06 \times \text{liver cm below the costal margin}) + (0.04 \times \text{spleen cm below costal margin})$ ).

SRG patients who were in continuous clinical remission after re-induction were randomized to receive or not to receive 25,000 IU HD L-ASP (*Erwinia* L-asparaginase) during the first 20 weeks of maintenance therapy. The total duration of treatment was 2 years.

Randomization methodology was not specified in this report.

Outcome measure was event-free survival (EFS).

### Outcome

All analyses were on the basis of “intention to treat”. 509 patients were enrolled in the DCLSG ALL-8 trial but only 467 were eligible for analysis. 42 were excluded because of institutional choice ( $n = 24$ ), missing data ( $n = 14$ ), patient refusal ( $n = 1$ ) or incorrect laboratory results ( $n = 3$ ); 170 patients were categorized as SR ALL, 241 as MR ALL and 56 as HR ALL. Patient characteristics are shown in Table 16.14.

One hundred and sixty-nine (99%) SR ALL patients achieved complete remission after induction therapy.

165 of the 169 patients were eligible for the HD L-ASP randomization, 80 patients refused randomization (refusal by patient/parent = 47, clinical decision = 20 and other = 13). The majority ( $n = 79$ ) of the non-randomized patients received maintenance therapy without HD L-ASP. Modification of continuing therapy – addition of other drugs.

**Table 16.13** DCLSG protocol ALL 8: treatment by risk group.

Risk group <sup>a</sup>	Induction	Consolidation	Reinduction	Maintenance Treatment
SRG	1.1	M(2 g/m <sup>2</sup> MTX)		Maintenance treatment
MRG	1.1, 2	M(5 g/m <sup>2</sup> MTX)	+ CRT <sup>b</sup>	Maintenance treatment
HRG	1.1	HR1, HR2, HR3, (3X) Allogeneic BMT optional after one course	+ CRT <sup>b</sup>	Maintenance treatment

Details of the chemotherapy are given in the Appendix.

<sup>a</sup>SRG (standard risk group): RF <0.8, without mediastinal mass, CNS involvement or HRG characteristics, no pre-T or T-ALL. MRG HRG (medium risk group, high risk group): RF ≥0.8 or presence of mediastinal mass or CNS involvement, without HRG characteristics. HRG (high risk group): independent of RF immunophenotypically acute undifferentiated leukemia, (CD10 and TdT negative), and/or leukaemic blasts with karyotype t(9:22) or BCR-MTX or BCR-ABL rearrangement or t(4;11), >1000/mm<sup>3</sup> blood blasts on day 8 after 7 days of monotherapy with prednisone and one dose of intrathecal MTX ("poor steroid response"), and/or no remission after (the first part of) Protocol 1 (day 33).

<sup>b</sup>CRT: cranial radiotherapy: if initial CNS involvement: 18 Gy in 15 days (only patients ≥1 year of age).

RF: risk factor; CR: complete remission; BMT: bone marrow transplantation; MD-MTX: MTX 2000 mg/m<sup>2</sup>, 4 × IV; HD-MTX: MTX 5000 mg/m<sup>2</sup>, 4 × IV.

**Table 16.14** DCLSG protocol ALL8: characteristics of eligible patients.

	Protocol Patients		SRG		MRG		HRG	
	n = 467	(% <sup>a</sup> )	n = 170	(% <sup>a</sup> )	n = 241	(% <sup>a</sup> )	n = 56	(% <sup>a</sup> )
Sex								
Boys	255	(55)	91	(54)	133	(55)	31	(55)
Girls	212	(45)	79	(46)	108	(45)	25	(45)
Age (years)								
<1	13	(3)	1	(1)	5	(2)	7	(13)
1–9	373	(80)	132	(78)	201	(83)	40	(71)
≥10	81	(17)	37	(21)	35	(15)	9	(16)
Hb (mmol/l)								
<5	272	(58)	98	(58)	148	(61)	26	(46)
≥5	194	(42)	71	(42)	93	(39)	30	(54)
Unknown	1		1		0		0	
WBC (×10 <sup>9</sup> /l)								
<10	228	(49)	147	(87)	66	(27)	15	(27)
10–<50	158	(34)	22	(13)	120	(50)	16	(29)
≥50–<100	32	(7)	–		26	(11)	6	(11)
≥100	48	(10)	–		29	(12)	19	(34)
Unknown	1		–	0		0		
Median	10.4		4.2		17.6		43.3	
Range	0.5–998		0.5–22.9		0.5–800		1–998	
Platelets (×10 <sup>9</sup> /l)								
<50	234	(20)	57	(34)	144	(60)	33	(60)
50–<100	100	(21)	38	(22)	2	(22)	10	(19)
≥100	131	(28)	73	(44)	43	(18)	12	(21)
Unknown	2		2		2		1	

(Continued)

**Table 16.14** (Continued)

	Protocol Patients		SRG		MRG		HRG	
	n = 467	(% <sup>a</sup> )	n = 170	(% <sup>a</sup> )	n = 241	(% <sup>a</sup> )	n = 56	(% <sup>a</sup> )
<b>FAB</b>								
L1	406	(87)	145	(85)	218	(90)	43	(77)
L2	55	(12)	24	(14)	22	(9)	9	(16)
AUL	5	(1)						
Unknown	1							
<b>Immunophenotype</b>								
AUL	2	(0)	0		0		2	(4)
Pro-B-ALL	16	(4)	5	(3)	3	(1)	8	(15)
C-ALL	263	(58)	114	(70)	129	(55)	20	(36)
Pre-B-ALL	114	(25)	42	(26)	63	(27)	9	(16)
T-ALL	56	(12)	0	(0)	40	(17)	16	(29)
Precursor B (cIgM unknown)	3	(1)	2	(1)	1	(0)	0	(0)
Not determined	13		7		5		1	
<b>DNA-index</b>								
<1.16	283	(78)	77	(68)	167	(81)	39	(91)
≥1.16	79	(22)	37	(31)	38	(19)	4	(9)
Not determined	105		56		36		13	
<b>Cellploidy</b>								
Diploid	76	(22)	21	(17)	44	(24)	11	(26)
Hypodiploid <46	22	(6)	10	(8)	10	(5)	2	(5)
Hyperdiploid 47–50	38	(11)	14	(11)	20	(11)	4	(10)
Hyperdiploid >50 chr	107	(30)	52	(43)	48	(26)	7	(17)
Pseudodiploid	98	(28)	23	(19)	58	(31)	17	(40)
Other	10	(3)	2	(2)	7	(4)	1	(2)
Not evaluable	86		30		46		10	
Not determined	30		18		8		4	
<b>Chromosome structural anomalies</b>								
Absent	145	(44)	50	(44)	79	(45)	16	(38)
Present	186	(56)	64	(56)	96	(55)	26 <sup>b</sup>	(62) <sup>b</sup>
Unknown	136		56		66		14	
Down's syndrome	9	(2)	3	(2)	6	(2)	0	(0)
<b>Stratification criteria</b>								
<b>Risk factor</b>								
<0.80	192	(41)	170	(100)	11	(5)	11	(20)
0.8–1.19	156	(33)	0	(0)	138	(58)	18	(32)
1.2–1.69	94	(20)	0	(0)	79	(32)	15	(27)
≥1.70	24	(5)	0	(0)	12	(5)	12	(21)
Unknown	1				1			
CNS disease	12	(3)	0	(0)	9	(4)	3	(5)
Mediastinal mass	37	(8)	0	(0)	29	(12)	8	(14)
<b>Prednisone response on day 8</b>								
<1000 blasts/mm <sup>3</sup>	413	(93)	160	(100)	241	(100)	22	(42)
≥1000 blasts/mm <sup>3</sup>	30	(7)	0	(0)	0	(0)	30	(58)
Unknown	24		10		0		4	
Day 33 BM >5% blasts	18	(4)	0	(0)	0	(0)	18	(32)

<sup>a</sup>Percentage of patients with available information.

<sup>b</sup>t(9;22) or BCR-ARL rearrangements: 7 patients; t(4;11), 11q23 abnormality: 9 patients; other abnormalities: 10 patients.

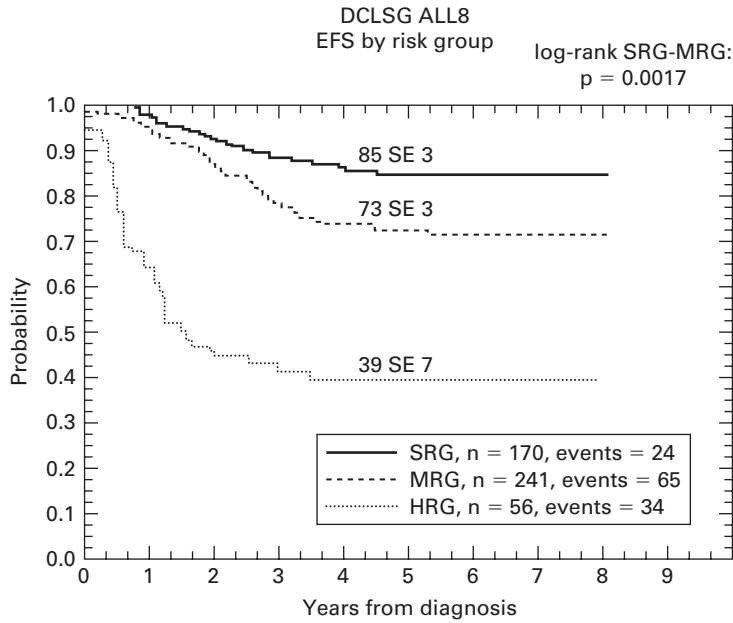
Of the remaining 85 patients, 43 were randomized to receive HD L-ASP (SRG 2) and 42 were randomized not to receive HD L-ASP (SRG 1). The 5-year EFS was 88% (SE 5%) in the HD L-ASP group compared to 82% (SE 6%) in non-HD L-ASP group ( $p = 0.58$ ). The overall 5-year EFS for the SR patients was 85% (SE 3%) (Figure 16.28).

Of the 23 relapses in the SR ALL group, 12 occurred during therapy. Sites of relapse are shown in Table 16.15.

All 3 CNS relapses occurred in patients who did not receive HD L-ASP.

### Conclusion

It was concluded that the addition of high dose L-asparaginase during the maintenance phase of therapy did not improve outcome in children and adolescents with standard risk ALL.



**Figure 16.28** EFS according to risk group. Stratification after treatment with DCLSG Protocol ALL-8. Reprinted from Kamps *et al.* (full reference on p. 438) with permission from Nature, Macmillan Publishers, Ltd.

**Table 16.15** DCLSG protocol ALL8: treatment results.

	SRG	MRG	HRG	All patients
Number of patients	170	241	56	467
Death before treatment	0	2	0	2
No CR	0	1	3	4
Early death	0	1	1	2
No response	0	0	2	2
Withdrawn	1	1	1	3
CR achieved	169 (99%)	237 (98%)	52 (93%)	458 (99%)
Death in CR	0	2	5	7

(Continued)



**Table 16.15** (Continued)

	SRG	MRG	HRG	All patients
Relapses	23	58	25	106
During treatment	12	26	18	56
After treatment	11	32	7	50
Site of relapse				
BM/Blood	18	44	21	83
CNS	3	9	2	14
BM/CNS	0	2	2	4
BM/CNS/testis	0	0	0	0
BM/testis	0	2	0	2
Testis	2	0	0	2
Lymph node	0	1	0	1
Second malignancy	0	2	0	2
In continuous CR	146	175	22	343
For patients event free alive:				
Median (follow-up)	60	60	53	60
Range (months)	35–97	36–98	37–96	35–98
EFS % (SE %)				
At 2 years	92 (2)	87 (2)	45 (7)	84 (2)
At 5 years	85 (3)	73 (3)	39 (7)	73 (2)
Number event-free alive at 5 years	72	80	7	159
Survival				
At 2 years	98 (1)	94 (2)	50 (7)	90 (1)
At 5 years	93 (2)	85 (2)	40 (8)	83 (2)
Number alive at 5 years	77	96	9	182

## Study 20

C. Rizzari, M.G. Valsecchi, M. Aricò, V. Conter, A. Testi, E. Barisone, F. Casale, L. Lo Nigro, R. Rondelli, G. Basso, N. Santoro, and G. Masera. Effect of Protracted High-Dose L-Asparaginase Given as a Second Exposure in a Berlin–Frankfurt–Münster–Based Treatment: Results of the Randomized 9102 Intermediate-Risk Childhood Acute Lymphoblastic Leukemia Study—A Report from the Associazione Italiana Ematologia Oncologia Pediatrica *J Clin Oncol* 19:2001:1297–303.

### Objectives

The primary objective was:

- To determine whether the addition of high dose *Erwinia Chrysanthemi* asparaginase (HD ASP) during the re-induction and early maintenance phase improved survival outcome in children with IR ALL.

### Study design

This Associazione Italiana Ematologia Oncologia Pediatrica (AIEOP) (March 1991 and April 1995, 1997) ALL-91 study was a prospective randomized multicenter trial and included all children with newly diagnosed intermediate risk acute lymphoblastic leukemia (IR ALL). Written informed consent was obtained for all patients registered on the study. Randomization was according to a minimization approach<sup>1</sup>.

Previously untreated children and adolescents below the age of 15 with (IR ALL) according to the Berlin-Frankfurt-Munster (BFM) criteria were enrolled on the study. Inclusion criteria for IR ALL were BFM risk factor<sup>1</sup> (calculated as  $0.2 \times \log_{10}(\text{blast count} + 1) + 0.06 \times \text{cm of palpable liver} + 0.04 \times \text{cm of palpable spleen}$ )  $0.8 < 1.7$ , risk factor  $< 0.8$  with either age  $< 1$  year or T cell disease, no CNS leukaemia at diagnosis and no t(4;11) or t(9;22) translocation. IR ALL patients had a risk factor

**Table 16.16** Treatment schedule for intermediate-risk patients.

Variable	mg/m <sup>2</sup>	Day
<b>Induction</b>		
Vincristine	1.5	8, 15, 22, 29
Prednisone	60	1–28 <sup>a</sup>
Daunorubicine	30	8, 15, 22, 2 <sup>a</sup> , 29
L-Asparaginase	10,000 <sup>b</sup>	19, 22, 25, 28, 31, 34, 37, 40
Cyclophosphamide	1,000	43, 71
Mercaptopurine	60	43–70
Cytarabine	75	45–48, 52–55, 59–62, 66–69
Methotrexate intrathecal	By age <sup>c</sup>	1
Triple intrathecal therapy	By age <sup>c</sup>	15, 29, 45, 59
<b>Consolidation</b>		
Methotrexate IV	5,000	8, 22, 36, 50
Citrovorum factor	7.5	36, 42, 48, 54, 60 <sup>d</sup>
Triple intrathecal therapy	By age <sup>c</sup>	8, 22, 36, 50
Mercaptopurine	25	1–56
<b>Reinduction</b>		
Dexamethasone	10	1–21
Vincristine	1.5	8, 15, 22, 29
Doxorubicin	30	8, 15, 22, 29
L-Asparaginase	Random <sup>e</sup>	
6-Thioguanine	60	36–49
Cyclophosphamide	1,000	36
Cytarabine	75	38–41, 45–47
Triple intrathecal therapy	By age <sup>c</sup>	38, 45
<b>Maintenance</b>		
L-Asparaginase	Random	
Mercaptopurine	50	Daily
Methotrexate IM	20	Weekly
Triple intrathecal therapy	By age <sup>c</sup>	Every 8 weeks

IM: intramuscular.

<sup>a</sup>Then tapered.

<sup>b</sup>IU/m<sup>2</sup>.

<sup>c</sup>Age-adjusted doses of triple intrathecal therapy were for methotrexate, cytarabine, and prednisolone, respectively, as follows: <1 year, 6, 16, and 4 mg; ≥1 < 2 years, 8, 20, and 6 mg; ≥2 < 3 years, 10, 26, and 8 mg; and ≥3 years, 12, 30, and 10 mg.

<sup>d</sup>Hours after high-dose methotrexate infusion start.

<sup>e</sup>L-Asparaginase 25,000 IU/m<sup>2</sup> IM weekly for 20 doses starting from reinduction week 1 and compared with 4 standard doses (10,000 IU/m<sup>2</sup> IM days, 8, 11, 15, and 18 of the re-induction phase).

score of 0.8–1.7. IR ALL patients had a risk factor score of 0.8–1.69 or RF <0.8 with age <1 year or T cell disease.

Excluded from the study were patients with Down's syndrome, acute undifferentiated leukemia, age >15 years, previous anti-leukemia treatment, t(4;11) or t(9;22) and central nervous system (CNS) leukemia at diagnosis. IR ALL patients who had a poor prednisolone response (i.e. >1000 blasts in peripheral blood after 7

days of corticosteroids and one dose of intrathecal methotrexate or did not achieve complete remission (CR) after 6 weeks of induction therapy were shifted to the high risk group.

The treatment schedule for IR ALL is shown in Table 16.16. Briefly, all patients received a pre-phase of 7 days of prednisolone followed by 10 weeks of remission induction therapy. Consolidation therapy

**Table 16.17** Characteristics of the 610 Intermediate-risk acute lymphoblastic Leukemia patients by randomized arm.

Variable	SD ASP		HD ASP	
	Number	%	Number	%
Total number of patients	322		288	
Sex				
Male	174	54	154	53
Female	148	45	134	47
Age (years)				
<1	6	2	4	1
1–10	264	82	254	88
≥10	52	16	30	11
Leukocyte count (per mm <sup>3</sup> )				
<10,000	126	39	101	35
10,000–50,000	154	48	135	47
50,000–100,000	22	7	30	10
≥100,000	20	6	22	8
Liver size <sup>a</sup> (cm)				
<2	71	22	57	20
2–3	97	30	86	30
≥4	152	47	142	49
Not known	2	1	3	1
Spleen size <sup>a</sup> (cm)				
<2	87	27	69	24
2–3	79	24	77	27
≥4	153	48	135	47
Not known	3	1	7	2
Immunophenotype				
Common	200	62	164	57
Pre-B	59	19	60	21
T	32	10	25	9
Acute hybrid leukemia	17	5	26	9
Pre-pre-B	14	4	12	4
Acute undifferentiated leukemia	0	0	1	0

<sup>a</sup>Below the costal margin.

consisted of intravenous high dose methotrexate, triple intrathecal chemotherapy and oral 6 mercaptopurine. The total duration of therapy was for 2 years. Shortly after commencement of the study, *E. coli* asparaginase became unavailable and this was substituted with *Erwinia* asparaginase.

### Randomization

All patients in CR at the commencement of re-induction therapy (week 23), were randomized either to the standard asparaginase arm (STD ASP) or

to the experimental high dose asparaginase arm (HD ASP). Patients randomized to the STD ASP arm received 4 doses of intramuscular asparaginase (10,000 IU/m<sup>2</sup>) on days 8, 11, 15 and 18 of the re-induction phase while those randomized to the HD ASP arm (25,000 IU/m<sup>2</sup>) received it both in the re-induction and early continuation phases (total of 20 doses). Due to a technical hitch in the computer software, an imbalance in the randomization occurred with a slightly higher number being allocated to receive STD ASP.

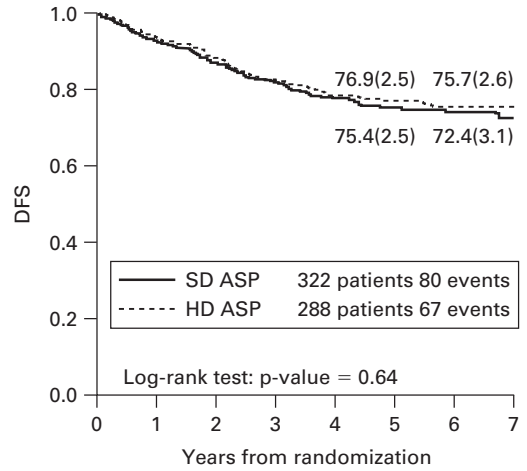
In a subset of patients, pharmacological assay of serum asparaginase activity as well as cerebrospinal fluid asparagine depletion were documented.

### Statistics

Analysis was on an intention-to-treat basis. The study was provided with an 80% power to detect a 10% difference in DFS, on the presumption that the baseline 4-year DFS was 70%. Event-free survival (EFS), overall survival (OS) and disease-free survival (DFS) were estimated according to the Kaplan Meier method. The log-rank test was used to compare the outcome between the randomized groups. The Cox regression model was used to estimate treatment effect adjusted for known prognostic variables (white blood count  $<10,000$ ;  $10,000$ – $50,000$  and  $>50,000 \times 10^3/l$ , age  $<1$ ; 1–9 and  $\geq 10$  years, sex and immunophenotype). The estimated hazard ratio was reported as relative risk (RR). The Wald test was used to assess the role of co-variables.

### Outcome

Of the 705 patients were enrolled onto the AIEOP ALL 91 study, only 610 were randomized to either the STD ASP arm ( $n = 322$ ) or to the HD ASP arm ( $n = 288$ ). 36 patients were excluded because of steroid pre-treatment ( $n = 21$ ) or erroneous risk stratification



SD ASP	322	297	279	263	225	154	87	30
HD ASP	288	269	253	236	201	138	82	28

**Figure 16.29** Kaplan–Meier estimates of disease-free survival (SE) according to the randomized treatment arm. © American Society of Clinical Oncology (full reference on p. 442).

( $n = 15$ ). A further 19 did not reach the point for randomization due to early relapse ( $n = 11$ ), death in induction ( $n = 2$ ), died in CR ( $n = 3$ ) or lost for follow up ( $n = 3$ ). 40 patients were not randomized due

**Table 16.18** Treatment results of the 610 intermediate-risk childhood ALL patients by randomized arm.

Variable	SD ASP		HD ASP	
	Number	%	Number	%
On study	322		288	
Relapses	76	23.6	64	22.2
Bone marrow <sup>a</sup>	52	16.1	48	16.7
Bone marrow + other	13	4.0	8	2.8
CNS <sup>a</sup>	6	1.9	6	2.1
Testis <sup>a</sup>	4	1.2	1	0.3
Other	1	0.3	1	0.3
Second malignant neoplasm	1 <sup>b</sup>	0.3	0	0.0
Deaths in CCR	3	0.9	3	1.0
Alive in CCR	243	75.5	221	76.7

CCR: continuous complete remission.

<sup>a</sup>Isolated.

<sup>b</sup>Non-Hodgkin's lymphoma.

**Table 16.19** Toxicity observed during re-induction therapy in 245 intermediate-risk childhood ALL patients<sup>a</sup> randomized to receive the SD ASP or HD ASP.

Variable	SD ASP (n = 119)	HD ASP (n = 126)	p <sup>c</sup>
Duration of reinduction therapy, <sup>b</sup> day			
Median	77	83	
Range	61–150	65–142	
Mean	76	82	NS
Neutropenia (PMN < 500/mm <sup>3</sup> )			
Number of patients	72	102	<.001
% of patients	60.5	81.0	
Episodes	122	218	
Thrombocytopenia (PLT < 50,000/mm <sup>3</sup> )			
Number of patients	26	51	.002
% of patients	21.8	40.4	
Episodes	31	67	
AT III <50%			
Number of patients	0	3	NS
% of patients	0	2.5	
Episodes	0	6	
AT III 50%–70%			
Number of patients	2	13	.005
% of patients	1.7	10.3	
Episodes	2	25	
Fibrinogen <100 mg/dl			
Number of patients	10	13	NS
% of patients	8.4	10.3	
Episodes	11	15	
Severe allergic reactions			
Number of patients	3	10	NS
% of patients	2.5	7.9	
Systemic	1	5	
Local	2	5	
Transient hyperglycemia requiring insulin therapy			
Number of patients	0	2	NS
% of patients	0	1.6	
Diabetes	0	0	
Thrombosis	0	0	
Pancreatitis	0	0	

NS: not significant; PMN: polymorphonuclear leukocytes; PLT: platelets.

<sup>a</sup>These data were obtained from the subset of patients treated in a limited number of AIEOP centers who agreed to participate in this ancillary study.

<sup>b</sup>Expected duration of reinduction therapy: 63 days.

<sup>c</sup>According to the *t*-test or  $\chi^2$ -test for comparison of means of proportions.

to parental refusal (n = 4), physician's choice (n = 29) or other unknown cause (n = 7). The median follow up time from randomization was 66 months; 17 patients assigned to the HD ASP arm received STD ASP while 1 patient who was randomized to STD ASP received HS ASP. Patient characteristics are shown in Table 16.17.

### Disease-free survival

DFS was similar in the two treatment arms (Figure 16.29) with projected 7-year DFS from randomization of 72.4% (SE 3.1%) and 75.7% (SE 2.6%) in the STD and HD ASP arms, respectively (p = 0.64).

76 patients (24%) relapsed in the STD ASP arm compared to 64 patients (22%) in the HD ASP arm at a median interval of 2 years after randomization (range, 0–80 months). Sites of relapse are shown in Table 16.18.

### Toxicity

Table 16.19 shows the toxicity data in the 2 randomized groups of patients. Neutropenic episodes

(218 versus 122; p < 0.001) and thrombocytopenia episodes (67 versus 31; p = 0.002) were significantly higher in the HD ASP group. Treatment was stopped in 9 patients in the HD ASP arm due to allergic reactions (n = 5), severe myelosuppression (n = 2), seizures (n = 1) and liver dysfunction (n = 1) compared to 1 in the STD ASP arm (p = 0.01).

### Conclusion

It was concluded that HD ASP during re-induction and early maintenance did not improve overall survival outcome in children with IR ALL. Additionally, HD ASP therapy appeared to be more toxic.

### Reference

- 1 Pocock SJ. *Clinical Trials: A Practical Approach*. Chichester, United Kingdom, John Wiley & Sons, 1983.

## Study 21

Andrea Pession, Maria Grazia Valsecchi, Giuseppe Masera, Willem A. Kamps, Edina Magyarosy, Carmelo Rizzari, Elisabeth R. van Wering, Luca Lo Nigro, Anna van der Does, Franco Locatelli, Giuseppe Basso, and Maurizio Aricò. Long-term results of a randomized trial on extended use of high dose L-asparaginase for standard risk childhood acute lymphoblastic leukemia. *J Clin Oncol* 23;2005:7161–7.

### Objective

The primary objective was:

- To determine whether the addition of high dose L-asparaginase (HD ASP) during the early maintenance phase improved survival outcome in children with SR-ALL.

### Study design

The IDH-ALL 91 trial was a prospective inter-group multicenter randomized study and included the Italian,

Hungarian and Dutch groups. This study was conducted between March 1991 and December 1996 and included all children with newly diagnosed standard risk acute lymphoblastic leukemia (SR-ALL). Randomization was performed centrally in each of the 3 national data centers and was stratified by country according random permuted blocks.

Previously untreated children and adolescents between the ages of 1–15 years with SR-ALL according to the Berlin-Frankfurt-Munster (BFM) criteria were enrolled on the study. Inclusion criteria for SR-ALL were (a) BFM risk factor<sup>1</sup> < 0.8 (calculated as  $0.2 \times \log_{10}(\text{blast count} + 1) + 0.06 \times \text{cm of palpable liver} + 0.04 \times \text{cm of palpable spleen}$ ); (b) non-T cell ALL and (c) prednisolone (PDN) good response (PGR;  $< 1 \times 10^9/l$  blasts in peripheral blood after 7 days of (PDN) and 1 injection of intrathecal methotrexate (IT MTX). Excluded from the study were patients with high risk clonal chromosomal translocations such as t (4; 11) or t (9; 22), central nervous system (CNS) leukemia at diagnosis or failure to achieve complete remission (CR) by day 42 after start of treatment. The

**Table 16.20** Treatment schedule.

Protocol Phases and Drugs	Dosage	Day
<b>Induction</b>		
Vincristine	1.5 mg/m <sup>2</sup>	8, 15, 22, 29
Prednisone	60 mg/m <sup>2</sup>	1–28 <sup>c</sup>
D Daunorubicin	30 mg/m <sup>2</sup>	8, 15, 22, 29
L-Asparaginase	10,000 IU/m <sup>2</sup>	19, 22, 25, 28, 31, 34, 37, 40
Methotrexate IT	By age <sup>a</sup>	1
Triple IT <sup>a</sup>	By age <sup>a</sup>	15, 29
<b>Consolidation</b>		
Methotrexate IV	2000 mg/m <sup>2</sup>	8, 22, 36, 50
Leucovorin	7.5 mg/m <sup>2</sup>	36, 42, 48 <sup>b</sup>
Triple IT <sup>a</sup>	By age <sup>a</sup>	8, 22, 36, 50
6-mercaptopurine	25 mg/m <sup>2</sup>	1–56
<b>Reinduction</b>		
Dexamethasone	10 mg/m <sup>2</sup>	1–21 <sup>c</sup>
Vincristine	1.5 mg/m <sup>2</sup>	8, 15, 22, 29
Doxorubicin	30 mg/m <sup>2</sup>	8, 15
L-Asparaginase	10,000 IU/m <sup>2</sup>	8, 11, 15, 18
6-thioguanine	60 mg/m <sup>2</sup>	36–49
Cyclophosphamide	1000 mg/m <sup>2</sup>	36
Cytarabine	75 mg/m <sup>2</sup>	38–41, 45–48
Triple IT <sup>a</sup>	By age <sup>a</sup>	38, 45
<b>Continuation</b>		
Asparaginase	25,000 IU/m <sup>2</sup> (if R = YES)	Weekly (if R = YES)
6-mercaptopurine	50 mg/m <sup>2</sup>	Daily
Methotrexate IM	20 mg/m <sup>2</sup>	Weekly
Triple IT <sup>a</sup>	By age <sup>a</sup>	q 8 week

IT: intrathecal; IV: intravenous; IM: intramuscular; R: random (high-dose L-Asparaginase: 25,000 IU/m<sup>2</sup> weekly for 20 doses, starting from the beginning of continuation therapy, versus no L-Asparaginase).

<sup>a</sup>Age-adjusted doses of triple IT therapy were for methotrexate, cytarabine and prednisolone, respectively as follows: <1 year 6/16/4 mg; >1 <2 years 8/20/6 mg; >2 <3 years 10/26/8 mg, >3 years 12/30/10 mg.

<sup>b</sup>Hours after methotrexate infusion starts.

<sup>c</sup>Then tapered.

study was approved by the local ethical boards of each of the participating centers and written informed consent was obtained from parents or guardians for all patients registered on the study.

## Treatment

The treatment schedule is shown in Table 16.20. All patients received a pre-phase of 7 days of PDN and one injection of IT MTX that was followed by a 4-drug modified BFM remission induction regimen. Bone marrow status was assessed at day 42 to ascertain remission (CR) status. Consolidation comprised of 4 courses of IV HD MTX along with triple IT chemotherapy. As

shown in Table 20, re-induction consisted of only 2 doses of doxorubicin instead of the usual 4 used in standard BFM protocols. Maintenance therapy consisted of daily oral 6-mercaptopurine (50 mg/m<sup>2</sup>), weekly IM MTX (20 mg/m<sup>2</sup>) and regular triple IT therapy. The total duration of therapy was for 2 years. At the start of maintenance, patients were randomized to either receive 20 weekly HD ASP (YES ASP) or not to receive HD ASP (NO ASP). Shortly after commencement of the study, *E. coli* ASP became unavailable and this was substituted with *Erwinia* asparaginase. The few patients who received *E. coli* ASP were evenly distributed in both the randomized groups.

**Table 16.21** Clinical characteristics of the patients according to the study arms.

Characteristic	YES HD-L-ASP (n = 178)		NO HD-L-ASP (n = 177)		Total (n = 355)	
	Number	%	Number	%	Number	%
Sex						
Male	96	53.9	102	57.6	198	55.8
Female	82	46.1	75	42.4	157	44.4
Age (years)						
1–9	152	85.4	150	84.7	302	85.1
10–15	26	14.6	27	15.3	53	14.9
Leukocyte count ( $\mu$ l)						
<10,000	162	91.0	165	93.2	327	92.1
10,000–100,000	16	9.0	12	6.8	28	7.9
Immunophenotype						
Common	119	66.9	116	65.5	235	66.2
Pre-B	36	20.2	28	15.8	64	18.0
Pre-pre-B	6	3.4	6	3.4	12	3.4
Other	15	8.4	20	11.3	35	9.9
Not known	2	1.1	7	4.0	9	2.5

YES HD-L-ASP: receiving high-dose L-asparaginase; NO HD-L-ASP: not receiving high-dose L-Asparaginase.

## Statistics

The study was planned to have an 80% power to detect a 10% improvement in the experimental arm (HD ASP arm), assuming an 80% disease-free probability (DFS) for the control arm,  $\alpha = 0.05$  (one sided). The calculated target number of patients in each arm was 164, with an accrual time of 4 years and overall study period of 9 years. Event-free survival (EFS), DFS and overall survival (OS) were calculated according to the Kaplan Meier method. The starting point was the date of randomization for all randomized patients. For calculation of EFS, induction failure, deaths in continuous remission, relapse or deaths due to second malignancy were counted as events while for estimation of DFS, deaths in continuous remission, relapse or occurrence of second malignancies were counted as events. Five patients were lost for follow up while in continuous clinical remission. The log-rank test was used for comparing the outcome between the randomized groups and this was a one-sided test. All other tests were 2 sided. The Cox regression model was used to estimate the treatment effect adjusting for known treatment variables (white blood count, age and sex). All of these analyses were stratified according to the participating group. The estimated hazard ratio was reported as

relative risk in the results. The Wald test was used to assess the role of the co-variables. The presence of major deviations from the proportional hazards assumptions were excluded by graphical checks. All analyses were performed on an intention to treat principle.

## Outcome end points

The primary end points were OS, EFS and DFS.

## Outcome

Of the 494 children enrolled in the trial (Italian group 290, Dutch group 170 and Hungarian group 34), 178 patients were randomized to the YES ASP arm and 177 to the NO ASP arm. 135 patients were not randomized for the following reasons: parental refusal (n = 56), physician decision (n = 51) and unspecified reasons (n = 28). Of the remaining 4 patients, 2 died during induction, 1 patient relapsed prior to start of maintenance and 1 was lost to follow up within a few months of start of treatment. The clinical characteristics of the randomized patients are shown in Table 16.21.

Fifty-eight events were observed after randomization; 57 relapses and 1 second malignancy. There were 22 relapses in the YES ASP arm compared to 35 in the



**Table 16.22** Status of the patients by study arm.

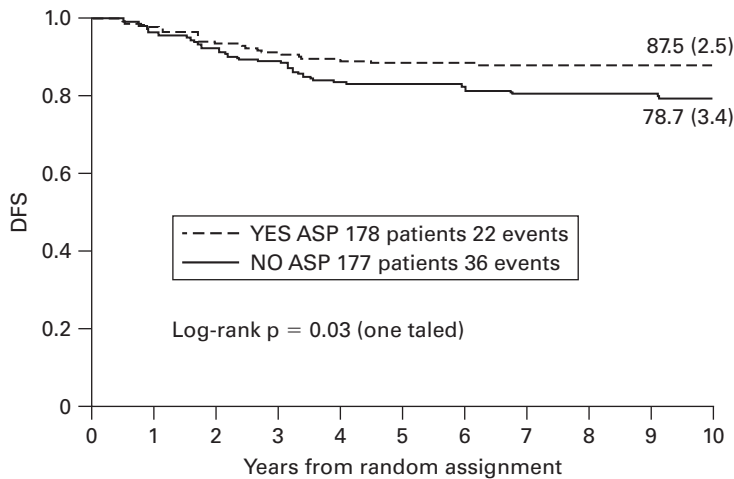
	YES-HD-L-ASP (n = 178)		No-HD-L-ASP (n = 177)		Total (n = 355)	
	Number	%	Number	%	Number	%
Relapse	22	12.3	35	19.8	57	16.1
Bone marrow	17		25		42	
Central nervous system	1		1		2	
Testis/ovary	2		4		6	
Bone marrow and testis	1		4		5	
Other	1 <sup>a</sup>		1 <sup>b</sup>		2	
Second malignant neoplasm	0		1 <sup>c</sup>		1	
Continuous complete remission	156	87.6	146	82.4	302	85.0

Abbreviations: YES HD-L-ASP, receiving high-dose L-Asparaginase; NO HD-L-ASP, not receiving high-dose L-Asparaginase.

<sup>a</sup>Eye and skin relapse.

<sup>b</sup>Ovary and lymph node relapse.

<sup>c</sup>Rhabdomyosarcoma at 45 months from diagnosis.



**Figure 16.30** DFS calculated according to the intention-to-treat analysis, of 355 children with SR-ALL, treated in the IDH-ALL 91 study, randomly assigned to receive (YES ASP) or not receive (NO ASP) high-dose L-asparaginase. © American Society of Clinical Oncology (full reference on p. 447).

NO ASP arm (Table 16.22). As seen in Table 16.22, most of the relapses occurred in the bone marrow. Overall, the hazard ratio of the YES ASP versus NO ASP arm was 0.6 (90% CI, 0.38 to 0.93) which indicated a 40% reduction in the risk of failure in patients randomized to received HD ASP. When treatment comparison was adjusted according to prognostic factors in a Cox regression model, NO ASP arm ( $p = 0.028$ , one sided), male sex ( $p = 0.004$ ) and age  $>10$  years

( $p = 0.0003$ ) had significantly negative impact on survival outcome.

The 5- and 10-year EFS for the entire cohort of 494 children enrolled on the study was 84.6% (SE, 1.6) and 82.5% (SE, 1.8) while the 5- and 10-year OS were 91.3% (SE, 1.3) and 90.3% (SE, 1.3), respectively. Additionally, the 5- and 10-year EFS for the 135 non-randomized patients were similar to the 355 randomized patients (84.4% (SE, 3.1) and 83% (SE, 12.1)

versus 85.3% (SE, 1.9) and 83% (SE, 2.1), respectively;  $p = 0.83$ ).

The 5- and 10-year DFS for patients randomized to receive HD ASP was 88.1% (SE, 2.4) and 87.5% (SE, 2.5), respectively compared to 82.5% (SE, 2.9) and 78.7% (SE, 3.3), respectively for patients in the NO ASP arm ( $p = 0.03$ , Figure 16.30). Similarly the OS at 5 and 10 years was 94.4% (SE, 1.7) and 93.7% (SE, 1.9), respectively in the YES ASP arm compared to 89.8% (SE, 2.3) and 88.6% (SE, 2.4), respectively in the NO ASP arm (one sided  $p = 0.05$ ).

### **Toxicity**

10% of patients randomized to receive HD ASP experienced allergic reactions and in approximately a third of these patients, the drug was discontinued completely.

### **Conclusion**

It was concluded that the use of high dose asparaginase during early maintenance phase in SR-ALL patients treated on a reduced intensity BFM chemotherapy protocol, improved DFS and OS.

*This page intentionally left blank*

**PART 3**

Supportive Care in Pediatric  
Oncology

*Katherine Matthay and AG Shankar*

*This page intentionally left blank*

## CHAPTER 17

### Growth factors

Children, in comparison with adults with cancer, receive more intensive and myelosuppressive treatment. Febrile neutropenic episodes respond well to empirical therapy, are better tolerated and associated with a lower mortality contributing to the better outcome to treatment in the younger age group.<sup>1</sup> Thus although the growth factors granulocyte colony stimulating factor (GCSF), granulocyte macrophage colony stimulating factor (GM-CSF) and erythropoietin (EPO) have been introduced into the clinical management of patients with cancer over the last two decades, there are no large randomized studies of the effect of these agents in childhood cancer.

The initial hope of routine colony stimulating factor (CSF) therapy was that it would allow more rapid scheduling of drugs and an increase in dose intensity. This in turn would lead to better response rates and survival. Though several adult studies have demonstrated a modest increase in dose intensity using CSFs, this has generally been associated with increased toxicity and no survival benefit.<sup>2</sup> As exemplified by the studies reported here, of the few studies carried out in children almost all are underpowered to conclude that CSFs are effective. In a randomized crossover study in high risk acute lymphoblastic leukemia (ALL) conducted by the Children's Cancer Group (Study 1), those who received GCSF had a faster neutrophil recovery time, but there was no difference in the incidence of febrile neutropenia, positive blood cultures, duration hospitalization, time between courses of therapy or survival when compared to those who did not.<sup>3</sup> Similar observations have been made by other adult<sup>2</sup> and pediatric studies.<sup>4,5</sup>

A number of adult and pediatric studies (including a meta-analysis;<sup>6</sup> (Study 3) show that the routine use of CSFs decreases the incidence of febrile neutropenia (Studies 4, 14 and 15), duration of hospitalization (Studies 7, 8 and 14) and decreases delays in subsequent chemotherapy (Studies 2, 6 and 9). It does not, however, reduce the incidence of infection related morbidity or mortality (Studies 5, 10, 11 and 16). While CSFs hasten the recovery of neutrophil counts, they also delay platelet recovery (Studies 12, 13, 17 and 18). Given the rarity of death due to infection and the overall good outcome

of childhood cancer, it is unlikely that a randomized controlled trial of CSFs will show any significant benefit in outcome. Consequently, the decisions to use CSFs are likely to be based on cost of hospitalization and the perceived quality of life for a child who is managed as an outpatient. Cost-benefit analyses of the routine use of prophylactic CSFs are therefore variable in their interpretation and overall the benefit in children appears to be minimal. The American Society of Clinical Oncology guidelines suggest that CSFs should only be used in context of a clinical trial.<sup>2</sup>

The one setting that CSFs are recommended is the mobilization of peripheral blood cells, particularly for autologous rescue.<sup>7,8</sup> This has to be balanced with the knowledge that we do not know precisely the long-term effect of CSFs. For example, their routine use in children with ALL has been reported to be associated with an increase in secondary acute myeloid leukemia.<sup>9</sup>

The use of recombinant EPO has been recommended for adults receiving chemotherapy for a solid tumor whose hemoglobin concentration is  $\leq 10$  g/dl.<sup>10</sup> Although no corresponding guidelines exist for children, several small, uncontrolled studies of heterogeneous groups of children receiving less intensive chemotherapy have suggested EPO is beneficial in reducing transfusion requirements<sup>11-13</sup> (Studies 2, 3 and 4). In addition, there has been particular interest in using EPO in patients receiving platinum-based regimens where red cell recovery is often delayed.<sup>14</sup> However in one recent randomized study in children during induction therapy for high risk neuroblastoma, the use of EPO was paradoxically associated with increased blood transfusion requirement<sup>15</sup> (Study 1). Furthermore there is evidence that pediatric tumors express EPO and its receptor, and thus the use of EPO may contribute to tumor growth.<sup>16,17</sup> As with the other growth factors, the use of EPO should only be in the context of a clinical trial where its benefit can be assessed properly.

## CHAPTER 18

### Protecting against anthracycline induced cardiac damage

Anthracyclines are widely used in childhood cancer and have significantly contributed to the increased

survival rates. However, their use is limited by a dose-dependent toxicity.<sup>18</sup> The mechanism for this toxicity is not clear. Among possible mechanisms are the formation of toxic free radicals through mitochondrial pathways<sup>19</sup> and direct damage to cardiac myocytes.<sup>20</sup> Clinically, anthracycline induced cardiac toxicity is either acute, early- or late-onset. Acute toxicity, occurring immediately or during an infusion of anthracycline, is rare (<1%) in children. Early-onset chronic progressive anthracycline induced cardiotoxicity is seen within the first year after treatment and can occur in about 2% of children who have received anthracyclines.<sup>21,22</sup> Late-onset toxicity occurs within 1 year of completion of therapy. At 6 years after anthracycline therapy, 65% of children have been reported to have altered cardiac function.<sup>23</sup> The risk of heart failure in these patients, 15–20 years after the start of the therapy is estimated to be 4–5%.<sup>22,24</sup> The risk of death due to cardiac related events is eight times higher for long-term survivors than for the normal population.<sup>24,25</sup>

In both adults and children, the risk of clinical cardiotoxicity increases with the cumulative dose. In children the cumulative toxic dose is around 250–300 mg/m<sup>2</sup>.<sup>26</sup> Most treatment protocols in children limit the maximum cumulative dose of anthracyclines. However, there is no absolute safe dose below which cardiotoxicity does not occur.<sup>23</sup> Continuous infusion of anthracyclines reduces peak levels, but also prolongs exposure and as reported in Study 3, there is no evidence to suggest that this decreases the incidence of cardiac toxicity.<sup>27,28</sup> At the moment, therefore, we have no evidence that prolonging the duration of infusion decreases cardiotoxicity and the current Medical Research Council trials in childhood leukemia have reduced the duration of infusion of anthracyclines from 6 to 1 hour.

A number of agents have been used to protect the heart from anthracycline induced damage. They include, probucol,<sup>29</sup> amifostine,<sup>30</sup> carvedilol<sup>31</sup> and sildenafil.<sup>32</sup> However none of these have been evaluated in context of a randomized trial and it is unclear as to whether they interfere with the anti-tumor activity of anthracyclines. The most studied agent is dexrazoxane or ICRF-187.<sup>33</sup> A number of randomized controlled trials have reported on the cardioprotectant effect of dexrazoxane. One study, in adults with breast cancer, suggested that the concomitant use of dexrazoxane though cardioprotective, diminished the tumoricidal activity of doxorubicin.<sup>34</sup> Study 1 reports that in

children with ALL, randomized to receive or not dexrazoxane, cardioprotection is achieved without compromising the anti-tumor effect of doxorubicin.<sup>35</sup> Similarly Study 2 suggests that dexrazoxane may be beneficial in decreasing anthracycline induced cardiotoxicity without compromising outcome in childhood sarcoma. It should now be used in the setting of research protocols to evaluate the balance of cardioprotection and possible reduction of anthracycline induced tumoricidal activity.

## References

- Hann I, Viscoli C, Paesmans M, Gaya H, Glauser M. A comparison of outcome from febrile neutropenic episodes in children compared with adults: results from four EORTC studies. International Antimicrobial Therapy Cooperative Group (IATCG) of the European Organization for Research and Treatment of Cancer (EORTC). *Br J Haematol* 1997;**99**(3):580–8.
- Ozer H, Armitage JO, Bennett CL, Crawford J, Demetri GD, Pizzo PA, Schiffer CA, Smith TJ, Somlo G, Wade JC, Wade III JL, Winn RJ, Wozniak AJ, Somerfield MR. 2000 update of recommendations for the use of hematopoietic colony-stimulating factors: evidence-based, clinical practice guidelines. American Society of Clinical Oncology Growth Factors Expert Panel. *J Clin Oncol* 2000;**18**(20):3558–85.
- Heath JA, Steinherz PG, Altman A, Sather H, Jhanwar S, Halpern S, Pieters R, Shah N, Steinherz L, Tannous R, Terry W, Trigg ME. Human granulocyte colony-stimulating factor in children with high-risk acute lymphoblastic leukemia: a Children's Cancer Group Study. *J Clin Oncol* 2003; **21**(8):1612–17.
- Delorme J, Badin S, Le Corroller AG, Auvrignon AA, Auclerc MF, Gandemer V, Bordigoni P, Lamagnere JP, Demeocq F, Perel Y, Berthou C, Bauduer F, Pautard B, Vannier JP, Braguer D, Leblanc T, Leverger G, Baruchel A, Michel G. Economic evaluation of recombinant human granulocyte colony-stimulating factor in very high-risk childhood acute lymphoblastic leukemia. *J Pediatr Hematol Oncol* 2003;**25**(6):441–7.
- Luksch R, Massimino M, Cefalo G, Lombardi F, Ferrari A, Casanova M, Gandola L, Terenziani M, Spreafico F, Fossati-Bellani F. Effects of recombinant human granulocyte-macrophage colony-stimulating factor in an intensive treatment program for children with Ewing's sarcoma. *Haematologica* 2001;**86**(7):753–60.
- Sung L, Nathan PC, Lange B, Beyene J, Buchanan GR. Prophylactic granulocyte colony-stimulating factor and granulocyte-macrophage colony-stimulating factor decrease febrile neutropenia after chemotherapy in children with cancer: a meta-analysis of randomized controlled trials. *J Clin Oncol* 2004;**22**(16):3350–6.
- Schmitz N, Linch DC, Dreger P, Goldstone AH, Boogaerts MA, Ferrant A, Demuyneck HM, Link H, Zander A, Barge A.

- Randomised trial of filgrastim-mobilised peripheral blood progenitor cell transplantation versus autologous bone-marrow transplantation in lymphoma patients. *Lancet* 1996;**347**(8998):353–7.
- 8 Klumpp TR, Goldberg SI, Magdalinski AJ, Mangan KF. Effect of hematopoietic growth factors on the rate of neutrophil recovery following peripheral blood stem cell transplantation. *Biol Blood Marrow Transplant* 1996;**2**(1):1–2.
  - 9 Relling MV, Boyett JM, Blanco JG, Raimondi S, Behm FG, Sandlund JT, Rivera GK, Kun LE, Evans WE, Pui CH. Granulocyte colony-stimulating factor and the risk of secondary myeloid malignancy after etoposide treatment. *Blood* 2003;**101**(10):3862–7.
  - 10 Rizzo JD, Lichtin AE, Woolf SH, Seidenfeld J, Bennett CL, Cella D, Djulbegovic B, Goode MJ, Jakubowski AA, Lee SJ, Miller CB, Rarick MU, Regan DH, Browman GP, Gordon MS. Use of epoetin in patients with cancer: evidence-based clinical practice guidelines of the American Society of Clinical Oncology and the American Society of Hematology. *J Clin Oncol* 2002;**20**(19):4083–107.
  - 11 Buyukpamuku M, Varan A, Kutluk T, Akyuz C. Is epoetin alfa a treatment option for chemotherapy-related anemia in children? *Med Pediatr Oncol* 2002;**39**(4):455–8.
  - 12 Zoubek A, Kronberger M. Early epoetin alfa treatment in children with solid tumors. *Med Pediatr Oncol* 2002;**39**(4):459–62.
  - 13 Feusner J, Hastings C. Recombinant human erythropoietin in pediatric oncology: a review. *Med Pediatr Oncol* 2002;**39**(4):463–8.
  - 14 Thatcher N, De Campos ES, Bell DR, Steward WP, Varghese G, Morant R, Vansteenkiste JF, Rosso R, Ewers SB, Sundal E, Schatzmann E, Stocker H. Epoetin alpha prevents anaemia and reduces transfusion requirements in patients undergoing primarily platinum-based chemotherapy for small cell lung cancer. *Br J Cancer* 1999;**80**(3–4):396–402.
  - 15 Wagner LM, Billups CA, Furman WL, Rao BN, Santana VM. Combined use of erythropoietin and granulocyte colony-stimulating factor does not decrease blood transfusion requirements during induction therapy for high-risk neuroblastoma: a randomized controlled trial. *J Clin Oncol* 2004;**22**(10):1886–93.
  - 16 Batra S, Perelman N, Luck LR, Shimada H, Malik P. Pediatric tumor cells express erythropoietin and a functional erythropoietin receptor that promotes angiogenesis and tumor cell survival. *Lab Invest* 2003;**83**(10):1477–87.
  - 17 van Delft FW, Bellotti T, Luo Z, Jones LK, Patel N, Yiannikouris O, Hill AS, Hubank M, Kempshi H, Fletcher D, Chaplin T, Foot N, Young BD, Hann IM, Gammerman A, Saha V. Prospective gene expression analysis accurately subtypes acute leukaemia in children and establishes a commonality between hyperdiploidy and t(12;21) in acute lymphoblastic leukaemia. *Br J Haematol* 2005;**130**(1):26–35.
  - 18 Lefrak EA, Pitha J, Rosenheim S, Gottlieb JA. A clinicopathologic analysis of adriamycin cardiotoxicity. *Cancer* 1973;**32**(2):302–14.
  - 19 Lebrecht D, Setzer B, Ketelsen UP, Haberstroh J, Walker UA. Time-dependent and tissue-specific accumulation of mtDNA and respiratory chain defects in chronic doxorubicin cardiomyopathy. *Circulation* 2003;**108**(19):2423–9.
  - 20 Arola OJ, Saraste A, Pulkki K, Kallajoki M, Parvinen M, Voipio-Pulkki LM. Acute doxorubicin cardiotoxicity involves cardiomyocyte apoptosis. *Cancer Res* 2000;**60**(7):1789–92.
  - 21 Krischer JP, Epstein S, Cuthbertson DD, Goorin AM, Epstein ML, Lipshultz SE. Clinical cardiotoxicity following anthracycline treatment for childhood cancer: the Pediatric Oncology Group experience. *J Clin Oncol* 1997;**15**(4):1544–52.
  - 22 Kremer LC, van Dalen EC, Offringa M, Ottenkamp J, Voute PA. Anthracycline-induced clinical heart failure in a cohort of 607 children: long-term follow-up study. *J Clin Oncol* 2001;**19**(1):191–6.
  - 23 Lipshultz SE, Lipsitz SR, Sallan SE, Dalton VM, Mone SM, Gelber RD, Colan SD. Chronic progressive cardiac dysfunction years after doxorubicin therapy for childhood acute lymphoblastic leukemia. *J Clin Oncol* 2005;**23**(12):2629–36.
  - 24 Green DM, Grigoriev YA, Nan B, Takashima JR, Norkool PA, D'Angio GJ, Breslow NE. Congestive heart failure after treatment for Wilms' tumor: a report from the National Wilms' Tumor Study group. *J Clin Oncol* 2001;**19**(7):1926–34.
  - 25 Mertens AC, Yasui Y, Neglia JP, Potter JD, Nesbit Jr. ME, Ruccione K, Smithson WA, Robison LL. Late mortality experience in five-year survivors of childhood and adolescent cancer: the Childhood Cancer Survivor Study. *J Clin Oncol* 2001;**19**(13):3163–72.
  - 26 Sorensen K, Levitt GA, Bull C, Dorup I, Sullivan ID. Late anthracycline cardiotoxicity after childhood cancer: a prospective longitudinal study. *Cancer* 2003;**97**(8):1991–8.
  - 27 Levitt GA, Dorup I, Sorensen K, Sullivan I. Does anthracycline administration by infusion in children affect late cardiotoxicity? *Br J Haematol* 2004;**124**(4):463–8.
  - 28 Lipshultz SE, Giantris AL, Lipsitz SR, Kimball Dalton V, Asselin BL, Barr RD, Clavell LA, Hurwitz CA, Moghrabi A, Samson Y, Schorin MA, Gelber RD, Sallan SE, Colan SD. Doxorubicin administration by continuous infusion is not cardioprotective: the Dana-Farber 91-01 acute lymphoblastic leukemia protocol. *J Clin Oncol* 2002;**20**(6):1677–82.
  - 29 Li T, Danelisen I, Bello-Klein A, Singal PK. Effects of probucol on changes of antioxidant enzymes in adriamycin-induced cardiomyopathy in rats. *Cardiovasc Res* 2000;**46**(3):523–30.
  - 30 Dragojevic-Simic VM, Dobric SL, Bokonic DR, Vucinic ZM, Sinovec SM, Jacevic VM, Dogovic NP. Amifostine protection against doxorubicin cardiotoxicity in rats. *Anticancer Drug* 2004;**15**(2):169–78.
  - 31 Spallarossa P, Garibaldi S, Altieri P, Fabbi P, Manca V, Nasti S, Rossettin P, Ghigliotti G, Ballestrero A, Patrone F, Barsotti A, Brunelli C. Carvedilol prevents doxorubicin-induced free radical release and apoptosis in cardiomyocytes in vitro. *J Mol Cell Cardiol* 2004;**37**(4):837–46.
  - 32 Fisher PW, Salloum F, Das A, Hyder H, Kukreja RC. Phosphodiesterase-5 inhibition with sildenafil attenuates cardiomyocyte apoptosis and left ventricular dysfunction in a chronic model of doxorubicin cardiotoxicity. *Circulation* 2005;**111**(13):1601–10.



- 33 Herman EH, Ferrans VJ, Jordan W, Ardalan B. Reduction of chronic daunorubicin cardiotoxicity by ICRF-187 in rabbits. *Res Commun Chem Pathol Pharmacol* 1981;**31**(1): 85–97.
- 34 Swain SM, Whaley FS, Gerber MC, Weisberg S, York M, Spicer D, Jones SE, Wadler S, Desai A, Vogel C, Speyer J, Mittelman A, Reddy S, Pendergrass K, Velez-Garcia E, Ewer MS, Bianchine JR, Gams RA. Cardioprotection with dexrazoxane for doxorubicin-containing therapy in advanced breast cancer. *J Clin Oncol* 1997;**15**(4):1318–32.
- 35 Lipshultz SE, Rifai N, Dalton VM, Levy DE, Silverman LB, Lipsitz SR, Colan SD, Asselin BL, Barr RD, Clavell LA, Hurwitz CA, Moghrabi A, Samson Y, Schorin MA, Gelber RD, Sallan SE. The effect of dexrazoxane on myocardial injury in doxorubicin-treated children with acute lymphoblastic leukemia. *New Engl J Med* 2004;**351**(2):145–53.

## CHAPTER 17

# Use of hemopoietic colony stimulating factors (G-CSF, G-MCSF and erythropoietin)

## Studies: GCSF

### Study 1

John A. Heath, Peter G. Steinherz, Arnold Altman, Harland Sather, Suresh Jhanwar, Steven Halpern, Richard Pieters, Narayan Shah, Laurel Steinherz, Raymond Tannous, William Terry, Michael E. Trigg. Human granulocyte colony stimulating factor in children with high risk acute lymphoblastic leukaemia: A Children's Cancer Group Study. *J Clin Oncol* 2003;21(8): 1612–17.

### Study design

This was a prospective open label multi-center randomized crossover trial that ran from January 1991 till September 1994 and included all patients newly diagnosed with childhood acute lymphoblastic leukaemia (ALL) on the Children's Cancer Group (CCG) 1901 study. At diagnosis, patients were randomly assigned to either NY I or NY II chemotherapy regimen and also simultaneously randomized to receive granulocyte colony stimulating factor (GCSF) during either the remission induction (RI) phase or consolidation (CD) block. A schematic outline of the crossover study design is shown in Figure 17.1. Written informed consent was obtained for all patients registered on the study. All analyses were conducted on an intention to treat basis with inclusion of all randomized patients regardless of actual treatment received or eligibility status.

### Objectives

The main objective of this study was to evaluate the efficacy of GCSF to:

- Reduce the incidence and duration of neutropenia.
- Decrease the incidence of infectious complications.
- Shorten the duration of hospital stay.
- Improve chemotherapy dose intensity.
- Improve event-free survival (EFS) and overall survival (OS).

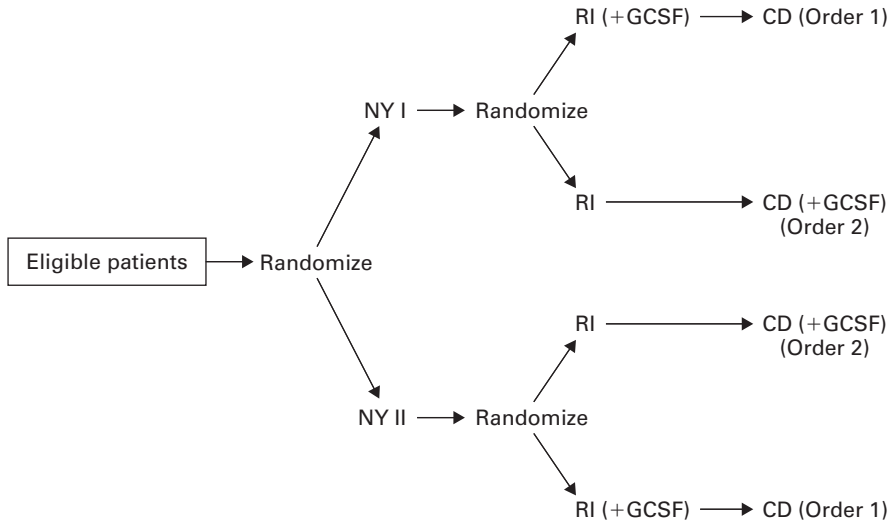
### Details of study

#### Patients

Previously untreated patients between the ages of 1 and 21 were included in this study. Patients were considered high risk if they had any or all of the following features – presenting white blood cell count (WBC) was  $\geq 50 \times 10^9/l$ ; hemoglobin  $\geq 10g\%$ ; T cell acute lymphoblastic leukemia (ALL) and massive lymphadenopathy ( $>3$  cm); splenomegaly extending below the level of the umbilicus or a large mediastinal mass (more than third of the maximal transthoracic diameter). Patients who had FAB (French American British) L3 ALL were excluded.

#### Treatment protocol

The treatment schedules and chemotherapy doses for both NY I and NY II regimens are shown in Figure 17.2. Both regimens consisted of a five-drug induction phase



**Figure 17.1** A schematic outline of the study design. Abbreviations: RI: remission induction, CD: consolidation block. © American Society of Clinical Oncology (full reference on p. 459).

with intrathecal cytarabine (IT ARA-C) and methotrexate (IT MTX). The consolidation block comprised a five-drug regimen of oral prednisolone (PDN), intramuscular L-asparaginase (L-ASP), intravenous ARA-C, 6 thioguanine, intravenous MTX and IT MTX. Patients randomized to the NY I regimen received 18 Gy cranial irradiation at the commencement of consolidation while NY II patients received it at a later phase of consolidation cycle.

GCSF commenced 24 hours after completion of intravenous chemotherapy and continued until the neutrophil count (ANC) exceeded  $2.5 \times 10^9/l$  for two consecutive days. Subsequent chemotherapy commenced 48 hours after stopping GCSF and only if the ANC and platelet counts were  $\geq 0.5 \times 10^9/l$  and  $100 \times 10^9/l$  respectively. The dose of GCSF was  $5 \mu\text{g/kg}$  subcutaneously and was administered daily. For those randomized not to receive GCSF, chemotherapy recommenced when the ANC was  $\geq 0.5 \times 10^9/l$  and platelets  $>100 \times 10^9/l$ . Blood counts were monitored twice weekly during the study.

### Supportive care

Patients were considered to have neutropenic fever if the recorded body temperature was  $\geq 38^\circ\text{C}$  for 4 hours or if they had a single recorded temperature  $\geq 38.5^\circ\text{C}$  and the ANC was  $<0.5 \times 10^9/l$ . All patients with neutropenic fever were hospitalized and treated with broad-spectrum intravenous antibiotics after appropriate culture of body fluids. In patients with no documented source of

infection, antibiotics were continued till they remained afebrile  $>24$  hours and with an ANC  $>0.5 \times 10^9/l$ . If fever persisted beyond 7 days after commencement of intravenous antibiotics in patients with negative blood cultures, amphotericin B was added to the treatment regime. Children with positive blood cultures received a 10-day course of appropriate antibiotics. Patients were only discharged when they were clinically well and remained afebrile  $>48$  hours with the ANC  $0.5 \times 10^9/l$ . A serious infection was defined as any proven systemic bacterial or fungal infection or any infective episode associated with hypotension or that that required admission to an intensive care unit.

### Outcome endpoints

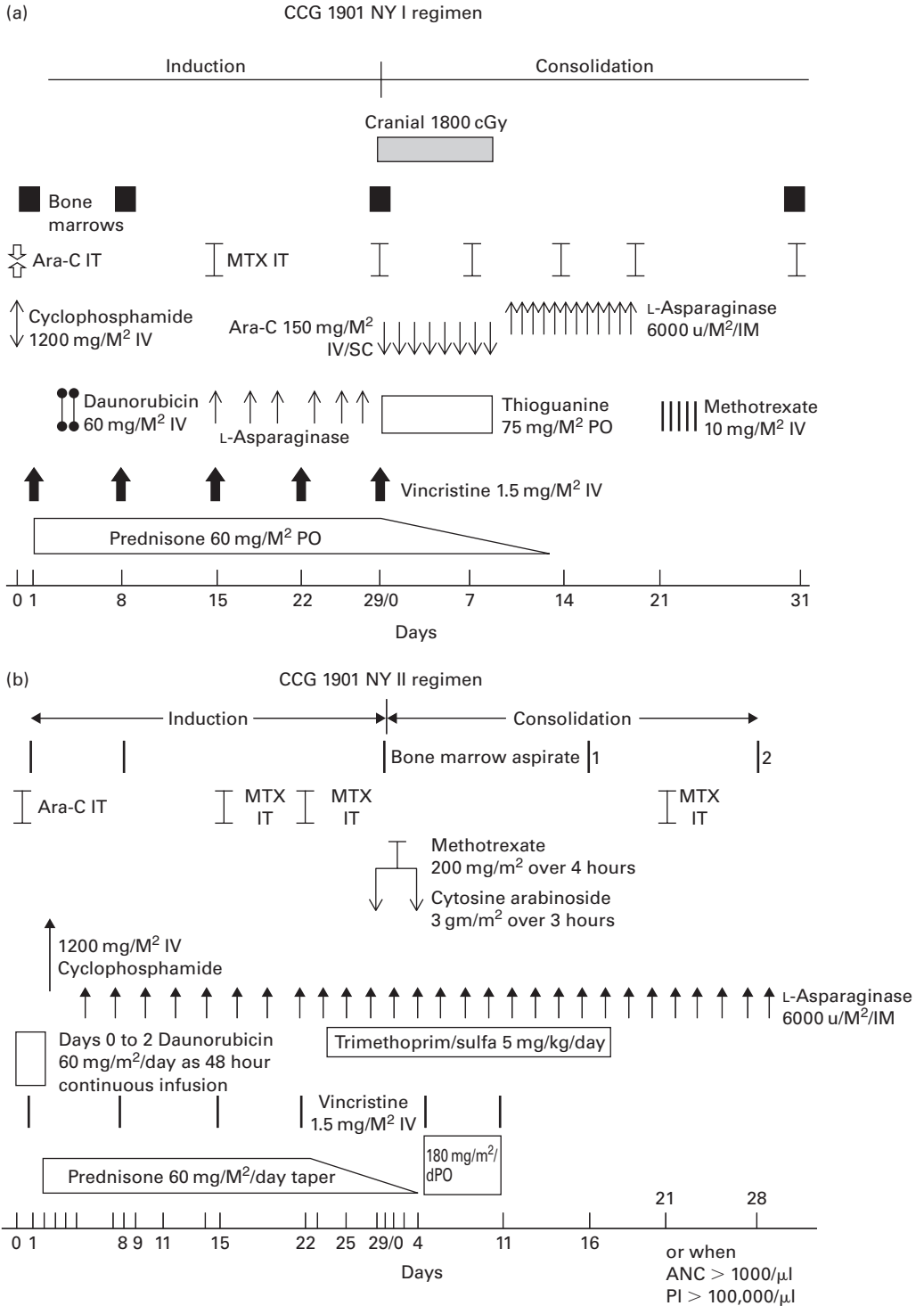
Primary end point was the time taken for ANC recovery to  $\geq 0.5 \times 10^9/l$  for 2 consecutive days.

Secondary end points included:

- 1 Time taken for platelet recovery to  $\geq 50 \times 10^9/l$ .
- 2 Number of days of neutropenic fever.
- 3 Number and types of documented infections.
- 4 Incidence of positive of blood cultures.
- 5 Time taken to complete scheduled blocks of chemotherapy treatment.
- 6 Event-free survival (EFS) and overall survival (OS).

### Statistics

Analysis of non-categorical data such as time to ANC recovery, platelet recovery, number of days of



**Figure 17.2** A schematic representation of CCG-1901 RI and CD. (a) NY I regimen and (b) NY II regimen. © American Society of Clinical Oncology (full reference on p. 459).

hospitalization and duration of treatment phases were according to standard analysis of variance (ANOVA) methods for analysis of crossover design data. The secondary end points were converted to binary form (patient experienced the event or not). A stratified crossover analysis accounting for chemotherapy regimen, treatment phase and use of GCSF was then employed. Comparisons of times to complete each of the phases of therapy were made using a *t* statistic. Comparisons with control groups consisting of 44 (NY I) and 46 (NY II) patients who completed both phases of treatment and did not receive GCSF were made using the log rank test. EFS and OS were estimated using the Kaplan Meier life table method and compared using the log rank test.

### Outcome

A total of 287 eligible patients registered on the study; 143 (*n* = 71 NY I and *n* = 72 NY II) were randomized to receive GCSF during induction while 144 (*n* = 71 NY I and *n* = 73 NY II) were randomly assigned GCSF during the first consolidation block. All four groups were evenly matched for clinical and biological features as shown in Table 17.1. Two hundred and fifty-nine patients who completed both remission induction and consolidation blocks were included for the stratified two treatment parametric crossover analysis. Of these, 130 received GCSF during remission induction (*n* = 70 NY I and *n* = 60 NY II) and 129 received GCSF during consolidation (*n* = 62 NY I and *n* = 67 NY II). There were no detectable differences between the randomized patients including those who did or did not complete remission induction and consolidation.

### ANC recovery

The mean ANC recovery time for patients randomized to receive GCSF during remission induction were 14.2 and 16.8 days (NY I and NY II) respectively compared to 18.5 (*p* = 0.03) and 18.8 days (*p* = 0.16) respectively for the control group of patients. For patients randomized to receive GCSF during consolidation, the mean ANC recovery times were 20.8 and 13.7 days (NY I and NY II) respectively compared to 22 (*p* = 0.62) and 17.6 (*p* = 0.03) days for the control group of patients. Overall, the mean ANC recovery time was significantly shorter for those who received GCSF compared with the control groups (16.3 versus 19.2 days; *p* = 0.0003). There was no evidence of carryover effect in the crossover analysis (*p* = 0.99).

The ANC did not fall below  $0.5 \times 10^9/l$  for 3 patients randomized to receive GCSF during remission induction compared with 9 in the control group. Again, the ANC did not drop below  $0.5 \times 10^9/l$  for 13 patients randomized to receive GCSF during first consolidation versus 14 in the respective control groups.

### Platelet recovery

The mean times for platelet recovery were 13.8 and 15.1 days (NY I and NY II) respectively for those who were randomized to GCSF during the remission induction phase compared to 14.8 (*p* = 0.44) and 12.5 (*p* = 0.1) days respectively in the control group of patients. The mean platelet recovery times for those randomized to receive GCSF during consolidation were 16.7 and 13.2 days (NY I and NY II) respectively compared to 17 (*p* = 0.88) and 13.5 (*p* = 0.84) days for the respective control groups. Overall the mean platelet recovery time was not significantly different (14.8 versus 14.5; *p* = 0.7) for those randomized to GCSF compared to the control group of patients. Once again, there was no evidence of a carryover effect in the crossover analysis (*p* = 0.48).

In 5 patients who were randomized to receive GCSF during induction remission, the platelet count did not drop below  $50 \times 10^9/l$  compared with 11 in the respective control groups. Similarly, the platelet counts of 13 patients randomized to receive GCSF during consolidation and 13 respective control group patients did not fall below  $50 \times 10^9/l$ .

### Infections

The number of episodes of neutropenic fever among those who randomized to receive GCSF were not statistically different from that of the control group of patients (149 versus 164; *p* = 0.41). There were again no significant reduction in number of serious infections (75 versus 79; *p* = 0.66), number of days of antibiotic usage (169 versus 175; *p* = 0.30), positive blood cultures (57 versus 61; *p* = 0.66), incidence of pneumonias (12 versus 12; *p* = 0.14) or abscesses (9 versus 9; *p* = 0.97) with prophylactic GCSF.

### Hospital days

The mean duration of hospital stay for patients randomized to receive GCSF during the remission induction phase were 16.7 and 22.4 days (NY I and NY II) respectively compared to 20.7 (*p* = 0.04) and 20 (*p* = 0.18) days for the respective control groups. The period of hospitalization for patients randomized to receive

**Table 17.1** Clinical and biological characteristics of 287 patients enrolled on CCG-1901 and randomly assigned to receive GCSF in remission induction (Order 1) or consolidation (Order 2).

Patient Characteristics	Total		NY I Order 1		NY I Order 2		NY II Order 1		NY II Order 2	
	Number of Patients	%	Number of Patients	%	Number of Patients	%	Number of Patients	%	Number of Patients	%
Total number of patients	287	100	73	26	71	24	70	24	73	26
Age, years										
1-9	207	72	52	71	49	69	55	79	51	70
10-21	80	28	21	29	22	31	15	21	22	30
Sex										
Male	190	66	48	66	51	72	43	61	48	66
Female	97	34	25	34	20	28	27	39	25	34
Race										
White	225	79	57	79	55	77	54	77	59	82
Non-white	62	21	16	21	16	21	16	23	14	18
Lymphadenopathy										
Absent	42	15	15	21	11	15	8	12	8	11
Moderate	93	32	26	36	24	34	24	34	19	26
Significant	152	53	32	44	36	51	38	54	46	63
Splenomegaly										
Absent	65	23	18	25	17	24	14	20	16	22
Moderate	115	40	29	40	28	39	23	33	35	48
Significant	107	37	26	35	26	37	33	47	22	30
Mediastinal mass										
Absent	145	50	39	53	30	42	38	54	38	52
Moderate	31	11	7	10	7	10	9	13	8	11
Significant	111	39	27	37	34	48	23	33	27	37
CNS disease <sup>a</sup>										
Present	106	49	28	48	27	51	26	50	25	47
Absent	111	51	31	52	26	49	26	50	28	53

(Continued)

**Table 17.1** (Continued)

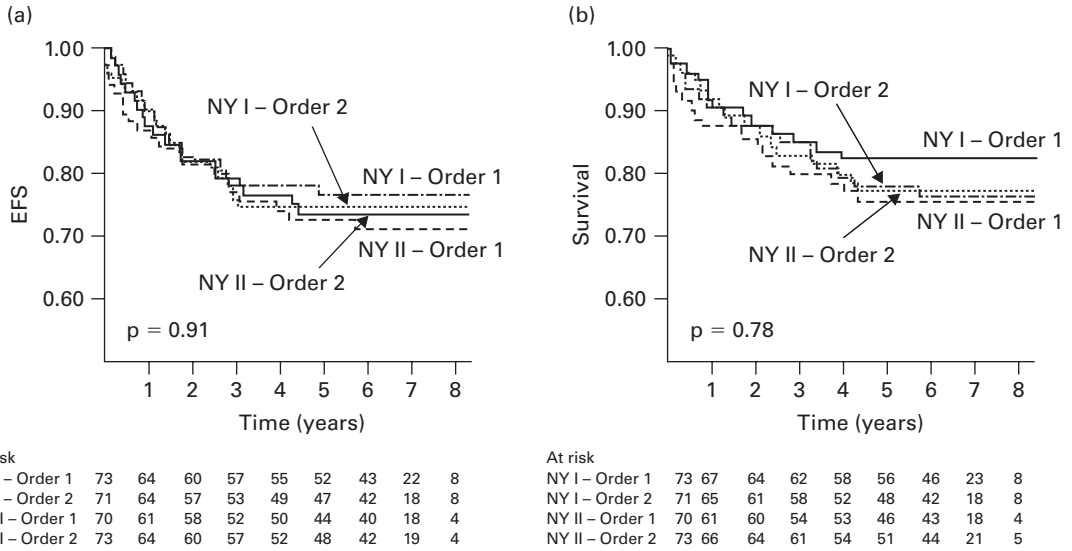
Patient Characteristics	Total		NY I Order 1		NY I Order 2		NY II Order 1		NY II Order 2	
	Number of Patients	%	Number of Patients	%	Number of Patients	%	Number of Patients	%	Number of Patients	%
Leukocytes										
<50,000/mm <sup>3</sup>	112	39	27	37	31	44	24	34	30	41
>50,000/mm <sup>3</sup>	175	61	46	63	40	56	46	66	43	59
Platelets										
<50,000/mm <sup>3</sup>	121	42	33	45	20	28	35	50	33	45
>50,000/mm <sup>3</sup>	166	58	40	55	51	72	35	50	40	55
Hemoglobin										
<80 g/l	84	29	26	36	17	24	22	31	19	26
>80 g/l	203	71	47	64	54	76	48	69	54	74
CALLA <sup>a</sup>										
Positive	106	49	28	48	27	51	26	50	25	47
Negative	111	51	31	52	26	49	26	50	28	53
Lineage <sup>b</sup>										
(Pre) B cell	66	33	22	41	12	24	16	33	16	33
T cell	135	67	32	59	39	76	32	67	32	67
Cytogenetics <sup>c</sup>										
Normal	36	29	9	28	10	30	8	24	9	33
Hypodiploid	6	5	1	3	0	0	2	6	3	11
Pseudodiploid	48	38	13	41	13	40	14	43	8	29
Hyperdiploid (47–50)	18	14	4	12	7	21	3	9	4	15
Hyperdiploid (51+)	17	14	5	16	3	9	6	18	38	52

CCG: Children's Cancer Group; GCSF: granulocyte colony stimulating factor and CALLA: reactive to common ALL antigen.

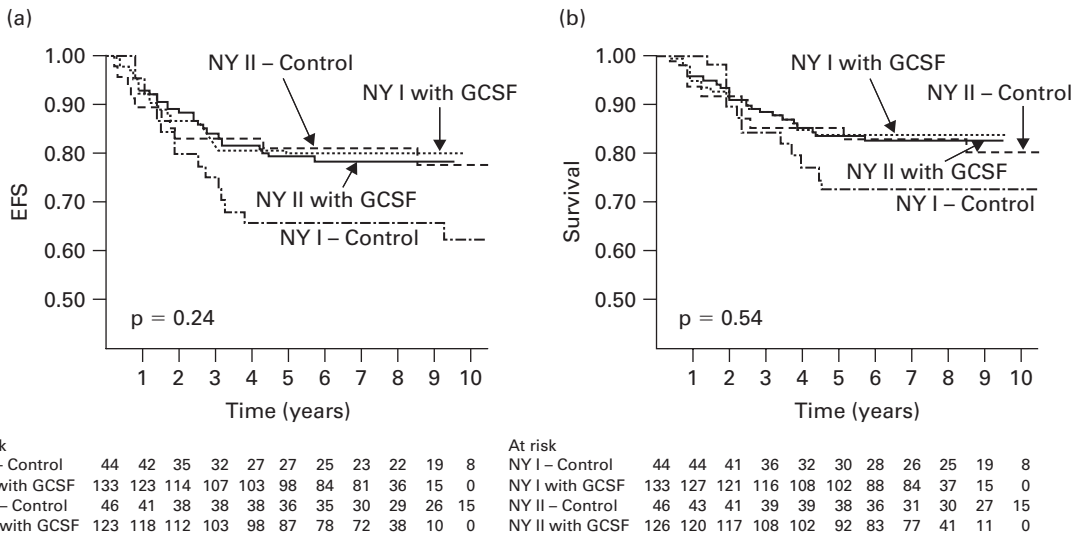
<sup>a</sup>Information on 217 patients.

<sup>b</sup>Information on 201 patients.

<sup>c</sup>Information on 125 patients.



**Figure 17.3** Kaplan–Meier estimates for the survival of patients on NY I and NY II regimens receiving granulocyte colony stimulating factor during either RI (Order 1) or initial CD (Order 2). (a) EFS and (b) OS. © American Society of Clinical Oncology (full reference on p. 459).



**Figure 17.4** Kaplan–Meier estimates for survival of patients on NY I and NY II regimen receiving and not receiving GCSF. (a) EFS and (b) OS. © American Society of Clinical Oncology (full reference on p. 459).

GCSF during the first consolidation phase were 6.9 and 8.2 days (NY I and NY II) respectively compared with 6.8 ( $p = 0.16$ ) and 9.3 ( $p = 0.35$ ) days respectively for the control groups. Overall, the mean duration of hospitalization was not significantly reduced with prophylactic GCSF (14 versus 13.9;  $p = 0.87$ ).

**Treatment duration**

The time taken to complete the remission induction phase of therapy (GCSF versus controls) was 30.3 days compared to 31.3 days on the NY I regimen ( $p = 0.11$ ) and 33.4 versus 32.3 days ( $p = 0.4$ ) on the NY II regimen. The mean time to complete consolidation was (GCSF



versus control) 41.3 days versus 42.6 days ( $p = 0.49$ ) on the NY I regimen and 31.2 days versus 30.8 days ( $p = 0.88$ ) on the NY II regimen.

### OS and EFS

The median EFS for the eligible patients ( $n = 132$  NY I and  $n = 127$  NY II) was 68 and 69 months respectively.

The 6-year EFS (NY I,  $p = 0.77$ ; NY II,  $p = 0.83$ ; overall  $p = 0.91$ ) and OS (NY I,  $p = 0.48$ ; NY II,  $p = 0.83$ ; overall  $p = 0.78$ ) were not statistically different among the four treatment group of patients (Figure 17.3a and

b). In addition, no differences in EFS or OS were seen between those who were randomized to GCSF on the NY I and NY II regimens and those enrolled on the study but not assigned to receive GCSF (Figure 17.4a and b).

### Conclusion

It was concluded that children with high risk ALL did not benefit with the use of prophylactic GCSF during either remission induction or consolidation blocks of treatment.

## Study 2

Michel G, Landman-Parker J, Auclerc MF, Mathey C, Leblanc T, Legall E, Bordigoni P, Lamagnere JP, Demeocq F, Perel Y, Auvrignon A, Berthou C, Bauduer F, Pautard B, Schneider P, Schaison G, Leverger G, Baruchel A. Use of recombinant human granulocyte colony-stimulating factor to increase chemotherapy dose-intensity: a randomized trial in very high-risk childhood acute lymphoblastic leukemia. *J Clin Oncol* 2000;**18**:1517–24.

### Study design

All patients enrolled on FRALLE 93 trial were eligible for inclusion in this prospective randomized study. Details of the randomization methodology were not specified. It is not known whether the data analysis was based on the principle of intention to treat.

### Objectives

The objective of this study were twofold:

- Evaluate the efficacy of GCSF in improving chemotherapy dose intensity (CDI).
- Whether higher CDI improved leukemia control.

### Details of study

#### Patient population

All patients with high risk acute lymphoblastic leukemia (ALL) were eligible for inclusion in the study. Eligibility criteria for the granulocyte colony stimulating factor (GCSF) study were:

- 1 Patients must be eligible for inclusion in the high risk arm of the FRALLE 93 trial.

- 2 Achieved complete remission after 4 weeks of induction treatment.

- 3 Non availability of human leukocyte antigen (HLA) identical sibling donor.

- 4 Slow early response (SER) to prednisolone or chemotherapy.

- 5 Presence of chromosomal translocations – t(4; 11) or t(9; 22).

SER to prednisolone was defined as peripheral blast  $>1 \times 10^9/l$  at day 7 of induction therapy after 7 days of prednisolone (60 mg/m<sup>2</sup>/day) treatment and triple intrathecal therapy comprising methotrexate (MTX), cytarabine (ARA-C) and corticosteroids (HC) administered on day 0. Slowly early response to chemotherapy was defined as  $>25\%$  blasts in the bone marrow at day 21 after 7 days of prednisolone prephase and 2 weeks of induction therapy consisting of weekly vincristine and daunorubicin and 14 days of oral prednisolone. Table 17.2 outlines the FRALLE 93 treatment program.

All eligible patients fulfilling the GCSF study inclusion criteria were then randomized to receive GCSF during the consolidation block of therapy.

### Chemotherapy schedule

As shown in Table 17.2, post-induction chemotherapy consisted of six consolidation courses; the first, third and fifth were a combination of high dose ARA-C, etoposide and dexamethasone while the second, fourth and sixth course consisted of vincristine, cyclophosphamide, doxorubicin and methotrexate (COPADM). A 14-day minimum interval between two consolidation blocks was an absolute necessity. After completing the six consolidation blocks all patients except those with t(4;11) and t(9;22) (this two groups were eligible for HLA matched unrelated allogeneic stem cell transplantation)

**Table 17.2** FRALLE 93 treatment program.

Phase	Treatment	Dose
Induction	Prednisone Vincristine Daunorubicin Asparaginase Triple intrathecal therapy	60 mg/m <sup>2</sup> /day PO days 1–7, 40 mg/m <sup>2</sup> /day PO days 8–28 1.5 mg/m <sup>2</sup> (max, 2 mg) IV days 8, 15, 22, 29 40 mg/m <sup>2</sup> days 8, 15, 22 10,000 U/m <sup>2</sup> IM or IV days 22, 24, 26, 29, 31, 33 Days 1, 8, 15
Consolidation course no. 1, first R3 course	Cytarabine Etoposide Dexamethasone Triple intrathecal therapy	2 g/m <sup>2</sup> IV twice daily days 1–2 150 mg/m <sup>2</sup> IV days 3, 4, 5 20 mg/m <sup>2</sup> PO days 2–5 Day 5
Consolidation course no. 2, first COPADM course	Vincristine Methotrexate Cyclophosphamide Doxorubicin Prednisone Triple intrathecal therapy	1.5 mg/m <sup>2</sup> (max, 2 mg) IV day 1 8000 mg/m <sup>2</sup> (24-hour IV infusion with leukoverin rescue) 375 mg/m <sup>2</sup> twice daily days 2–3 60 mg/m <sup>2</sup> IV day 2 60 mg/m <sup>2</sup> PO days 1–5 Day 2
Consolidation course no. 3, second R3 course	Same as consolidation course no. 1	
Consolidation course no. 4, second COPADM course	Same as consolidation course no. 2	
Consolidation course no. 5, third R3 course	Same as consolidation course no. 1	
Consolidation course no. 6, COPADM course	Same as consolidation course no. 2	
Autologous stem-cell transplantation	Patients more than 4 years old: total body irradiation Patients less than 4 years old: busulfan All patients: cytarabine Melphalan Autologous stem cell	2 Gy twice daily days –9 to –7. 30 mg/m <sup>2</sup> (max, 1.25 mg/kg) PO every 6 hours days –10 to –7 3 g/m <sup>2</sup> IV twice daily days –5 to –4 140 mg/m <sup>2</sup> IV day –2 IV day 0
Maintenance	6-Mercaptopurine Vincristine	75 mg/m <sup>2</sup> /day until 2 years after complete remission 1.5 mg/m <sup>2</sup> monthly for 12 months

PO: orally; IM: intramuscular; max: maximum and IV: intravenous.

underwent autologous hemopoietic stem cell transplantation (AHSCT) followed by maintenance therapy. Stem cell harvest AHSCT for was performed between the fifth and sixth consolidation blocks.

### GCSF

All patients were randomized to receive or not to receive recombinant GCSF after each consolidation block. GCSF was administered daily subcutaneously (5 µg/kg) and commenced 24 hours after chemotherapy and continued until the absolute neutrophil count (ANC) was  $>1 \times 10^9/l$ . The next scheduled chemotherapy was commenced 24 hours after GCSF was discontinued and only if the ANC was  $>1 \times 10^9/l$ .

All patients in the non-GCSF group commenced chemotherapy when the ANC was  $>1 \times 10^9/l$ . Children not randomized to receive GCSF did not receive placebo therapy. For both groups of patients, a platelet count  $>100 \times 10^9/l$  and absence of major non-hematological toxicity was required before chemotherapy could be commenced.

### Definitions

- 1 Neutropenia was defined as an ANC  $<0.5 \times 10^9/l$ .
- 2 Fever was defined as recorded oral temperature  $\geq 38.5^\circ\text{C}$  on a single occasion or if the temperature was  $>38^\circ\text{C}$  on three occasions over a 24-hour period.
- 3 Chemotherapy dose intensity (CDI) was defined as an interval equal to 105 days, and for each patient CDI was calculated using the formula  $105/\text{interval} \times 100$ .

### CDI

CDI was calculated using the interval from day 1 of the first consolidation course to hematological recovery after the fifth consolidation block.

CDI was  $>100\%$  if the interval was  $<105$  days and it was  $<100\%$  if the interval was  $>105$  days.

### Supportive care

Patients with neutropenic fever were hospitalized and treated with broad-spectrum intravenous antibiotics after appropriate cultures of blood and urine were obtained.

Complete blood counts were performed at least once a day and all patients received oral co-trimoxazole prophylaxis against *Pneumocystis carinii* (PCP) infection.

### Outcome end points

The primary end point of this study was CDI during the consolidation courses.

Secondary end points included:

- 1 Number of days of neutropenic fever.
- 2 Number of days of intravenous antibiotic treatment.
- 3 Number of days of hospitalization.
- 4 Number of days of bone marrow aplasia.
- 5 Number of transfusions.
- 6 Mucosal toxicity.
- 7 Disease-free survival (DFS).

### Statistics

Analysis comparing quantitative variables was performed using the Student's t-test. Mean values of these variables were given with their 95% confidence interval (CI). The distribution of the qualitative variables was compared with the two-sided Fisher's exact test. The Kaplan–Meier method was used to evaluate DFS probabilities and risk of relapse.

### Outcome

#### Patient characteristics

Of the 67 randomized patients (n = 34 GCSF and n = 33 no GCSF), 55 were included because of SER to treatment (SER to prednisolone, 36; SER to chemotherapy, 10 and SER to prednisolone and chemotherapy, 9). The remaining 12 were included because of high risk cytogenetic features (t(4; 11) = 7 and t(9; 22) = 5). The number of children with t(4; 11) were higher in the non-GCSF group compared to the GCSF group (6 versus 1; p = 0.05). Patient characteristics of those included in the study are shown in Table 17.3.

#### CDI

The CDI was higher in the GCSF group than in the non-GCSF group (mean  $\pm$  95% CI,  $105 \pm 5\%$  versus  $91 \pm 4\%$ ; p < 0.001). The duration of intervals after course 1, 3 and 5 (R3 regimen) were significantly shortened in the GCSF group compared to the non-GCSF group (Table 17.4). The mean interval was shorter by 4.1 days after course 1, 2.6 days shorter after course 3 and 3.8 days shorter after course 5. Though the observed interval was shorter after courses 2 and 4 in the GCSF group it did not reach statistical significance.

Due to the imbalance in the distribution of t(4; 11) between the two groups of patients, CDI and interval duration between each consolidation course was recalculated after excluding patients with t(4; 11). Once again, CDI was higher in the GCSF group (mean  $\pm$  95% CI,  $106 \pm 5\%$  versus  $92 \pm 4\%$ ; p < 0.001). Post-R3 intervals were significantly shortened in the

**Table 17.3** Characteristics of children assigned to receive or not to receive GCSF.

Characteristics	GCSF Patients (n = 34)		Non-GCSF Patients (n = 33)		p
	Number	%	Number	%	
At diagnosis					
Age					
Mean (95% CI, years)		8.5 ± 1.5		6.8 ± 1.8	
<1 year old	1	3	6	18	.05 <sup>b</sup>
Male sex	21	62	19	58	NS <sup>b</sup>
T cell lineage	17	50	10	30	NS <sup>b</sup>
Leukocyte count, mean ± 95% CI, × 10 <sup>9</sup> /l		136 ± 58		223 ± 84	<0.05 <sup>c</sup>
Meningeal involvement	3	9	5	15	NS <sup>b</sup>
Translocations					
t(4;11)	1	3	6	18	0.05 <sup>b</sup>
t(9;22)	3	9	2	6	NS <sup>b</sup>
Criteria for slow early response to therapy <sup>a</sup>					
Slow response to prednisone only	19	56	17	52	NS <sup>b</sup>
Slow response to chemotherapy only	6	18	4	12	NS <sup>b</sup>
Slow response to both	5	15	4	12	NS <sup>b</sup>

NS: not significant.

<sup>a</sup>Patients with t(4;11) or t(9;22) not included.<sup>b</sup>Two-tailed Fisher's exact test.<sup>c</sup>Student's t-test.**Table 17.4** Interval between chemotherapy courses.

	Number of Days (Mean Value ± 95% CI)		p <sup>*</sup>
	GCSF	Non-GCSF	
Interval 1, after first R3	19.1 ± 1.1	23.2 ± 1.0	<0.001
Interval 2, after first COPADM	21.4 ± 1.7	23.4 ± 2.7	NS
Interval 3, after second R3	20.6 ± 1.3	23.2 ± 1.8	0.02
Interval 4, after second COPADM	22.2 ± 2.4	23.5 ± 1.7	NS
Interval 5, after third R3	19.0 ± 2.0	22.8 ± 3.7	0.01

NS: not significant.

<sup>\*</sup>Student's t-test.

GCSF group while the shortening was not statistically significant after COPADM.

### Chemotherapy related toxicity

Duration of neutropenia was reduced in the GCSF group when compared to the non-GCSF group. Though this was significant after both COPADM and after R3 regimens, it was less pronounced after COPADM than after R3 (Table 17.5). Though the number of days of hospitalization, days of intravenous antibiotics and

days with neutropenic fever was reduced in the GCSF group, the difference was evident only after the R3 regimens (Table 17.5).

The risk of septicemia per patient per course was 4% in the GCSF group compared to 11% in the non-GCSF group (p = 0.075).

The duration of thrombocytopenia was significantly longer in the GCSF group, particularly after the COPADM regimens. This translated to higher number of platelet transfusions in the GCSF group (Table 17.6).

**Table 17.5** Neutropenia, fever and hospitalization.

	Number of Days Per Patient and Per Course (Mean ± 95% CI)		
	GCSF	Non-GCSF	p*
Days with ANC < 0.5 × 10 <sup>9</sup> /l			
After R3	4.1 ± 0.4	9.7 ± 1	<0.001
After COPADM	4.7 ± 1.1	7.6 ± 1.1	<0.001
Overall	4.4 ± 0.5	8.8 ± 0.8	<0.001
Days with ANC < 1 × 10 <sup>9</sup> /l			
After R3	5.1 ± 0.6	12.2 ± 1.3	<0.001
After COPADM	5.7 ± 1.2	10.2 ± 1.8	<0.001
Overall	5.4 ± 0.6	11.4 ± 1.1	<0.001
Days with fever			
After R3	1.1 ± 0.3	2 ± 0.5	0.005
After COPADM	2.9 ± 0.8	2.6 ± 0.7	NS
Overall	1.8 ± 0.4	2.2 ± 0.4	0.05 < p < 0.1
Days with IV antibiotics			
After R3	2.7 ± 0.7	4.6 ± 1.1	0.005
After COPADM	5 ± 1.3	5.8 ± 1.4	NS
Overall	3.6 ± 0.7	5.1 ± 0.9	0.005
Hospitalization days			
After R3	4.5 ± 0.8	7.3 ± 1.1	<0.001
After COPADM	7.7 ± 1.6	8.3 ± 1.6	NS
Overall	5.8 ± 0.8	7.7 ± 0.9	0.002

IV: intravenous and NS: not significant.

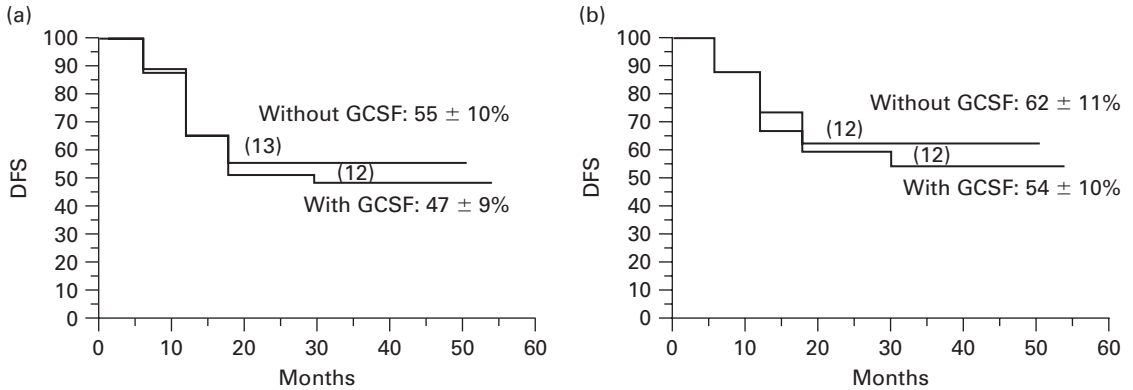
\*Student's t-test.

**Table 17.6** Thrombocytopenia and transfusion requirements.

	Number of Days Per Patient and Per Course (Mean ± 95% CI)		
	GCSF	Non-GCSF	p*
Number of days with platelets < 50 × 10 <sup>9</sup> /l			
After R3	4.4 ± 0.6	3.2 ± 0.5	0.002
After COPADM	2.8 ± 0.8	0.8 ± 0.4	<0.001
Overall	3.8 ± 0.5	2.3 ± 0.4	<0.001
Number of platelet transfusions			
After R3	1.1 ± 0.1	0.8 ± 0.1	0.03
After COPADM	0.7 ± 0.3	0.4 ± 0.2	0.07
Overall	0.9 ± 0.2	0.6 ± 0.1	0.008
Number of RBC transfusions			
After R3	0.9 ± 0.2	1 ± 0.2	NS
After COPADM	0.8 ± 0.2	0.8 ± 0.2	NS
Overall	0.9 ± 0.1	0.9 ± 0.1	NS

NS: not significant.

\* Student's t-test.



**Figure 17.5** (a) Probability of DFS according to GCSF randomization (t(4;11) and t(9;22) included) and (b) probability of DFS according to GCSF randomization (t(4;11) and t(9;22) not included). The numbers in parentheses indicate the number of patients at risk at a given time interval. © American Society of Clinical Oncology (full reference on p. 466).

Use of GCSF slightly decreased the incidence of oral mucositis after the R3 regimens but when restricted to severe mucositis that required opioid analgesics, this difference was not statistically significant. GCSF did not influence the frequency of mucositis after the COPADM regimens.

### DFS and relapse rates

The DFS (mean  $\pm$  95% CI) at 3 years in the GCSF group was  $47 \pm 9\%$  versus  $55 \pm 10\%$  in the non-GCSF group (Figure 17.5a). This was not statistically significant.

Even after excluding patients with t(4;11) and t(9;22), the 3-year DFS was not significantly different between the two groups of patients ( $54 \pm 10\%$ ; GCSF group versus  $62 \pm 11\%$ ; non-GCSF group) (Figure 17.5b).

Thirty-eight children (17 in the GCSF group and 21 in the non-GCSF group) were reported to be alive in first remission at a median follow-up of 27 months.

The 3-year relapse rate (mean  $\pm$  95% CI) in the GCSF group was  $49 \pm 9\%$  versus  $41 \pm 9\%$  in the non-GCSF group.

Of the 26 children who relapsed, 15 were in the GCSF group. 3 patients in each group relapsed prior to AHSCT.

### Toxicity and death

Three children died due to treatment related toxicity. One child in the GCSF group died from septic shock and one each in both groups died due to transplant complications following unrelated allogeneic bone marrow transplantation.

### Conclusion

It was concluded that though prophylactic GCSF during consolidation was associated with improved and higher CDI, this did not translate to an improved DFS.

## Study 3

Lillian Sung, Paul C. Nathan, Beverly Lange, Joseph Beyene, George R. Buchanan. Prophylactic granulocyte colony-stimulating factor and granulocyte-macrophage colony-stimulating factor decrease febrile neutropenia after chemotherapy in children with cancer. A meta-analysis of randomized controlled trials. *J Clin Oncol* 2004;22: 3350–6.

## Methodology

This report is a meta-analysis of 16 randomized trials in childhood cancer performed worldwide. Only randomized trials that included children  $\leq 18$  years of age were included. All trials were identified by Ovid Medline (1966 to July 2003) and Embase (1980 to July 2003) database search. Two reviewers independently evaluated titles and abstracts of publications identified

by the search strategy and potentially relevant publication was retrieved in full. Agreement between the reviewers was evaluated using a  $k$  statistic and strength of agreement as evaluated by the  $k$  statistic was defined as slight (0–0.2), fair (0.21–0.4), moderate (0.41–0.6), substantial (0.61–0.8) and almost perfect (0.81–1.0).

Criteria for including trials for meta-analysis were:

- 1 The study population consisted of children (age defined by the individual study) or if the data were extractable for those  $\leq 18$  years old in studies that included adults and children.
- 2 There was randomization between colony stimulating factors (CSFs) and placebo or no therapy.
- 3 CSFs were given after initiation of chemotherapy, prophylactically before development of neutropenia or febrile neutropenia (FBN).
- 4 Identical chemotherapy preceded CSFs and placebo administration or no therapy.

Reasons for exclusion of trials from this meta-analysis were based on a hierarchical system and the reasons were ranked in the following order: study population consisting of adults, non-randomized trials and different chemotherapy regimens preceded CSFs and placebo or no therapy, absence of placebo or no therapy and duplicate publications.

### Outcome end points

Outcome measures were: (a) occurrence of FBN, (b) duration of neutropenia, (c) duration of hospitalization, (d) rate of documented infections, (e) duration of parenteral antibiotic usage, (f) length of chemotherapy delay, (g) amphotericin B usage, (h) infection related mortality and (i) cost effectiveness.

### Statistical methods

The meta-analysis combined data at the study level and not at the individual patient level. Some assumptions were made to facilitate data synthesis – the mean could be approximated by the median, range contained 6 standard deviations (SDs), the 95% CI contained 4 SDs and the interquartile range contained 1.35 SDs.

For studies in which data were presented separately for different cycles (acute lymphoblastic leukemia [ALL]), only the data from the first cycle was included. For studies in which data from all cycles were presented in an aggregate manner, events were assumed to follow a Poisson distribution, and were presented

for each cycle. The outcome then was expressed as a natural logarithm of the rate ratio with the variance of the rate ratio determined using the Delta method.<sup>1</sup> Continuous outcomes were presented as average effect per cycle. Therefore, in general, each study contributed one effect estimate for each outcome with available data.

Synthesized continuous data were expressed as the weighted mean difference (WMD), which represented the overall difference between CSF and placebo or no therapy. Categorical data were expressed as rate ratios, analogous to a relative risk. A rate ratio of  $< 1$  with a 95% CI that does not include 1 suggested that CSFs were associated with reduction in outcome. When there were outcomes with no events, 0.5 was added to each cell to allow for calculable values. Effect sizes were weighted by the inverse variance.

To correct for heterogeneity between studies, a random effects model was used for all analysis.<sup>2</sup> In the stratified analysis, only outcomes with at least two studies per group were examined.

Publication bias was examined using a funnel plot, which was a graph with the effect size (WMD or rate ratio) on the x-axis, and the inverse of variance of the effect on the y-axis. In the event of a possible publication bias, the “trim and fill” technique was used to determine the impact of such a bias (outlying studies are deleted and hypothetical studies with equal weight are created to determine the robustness of the conclusions).

The meta-analysis was performed using Review Manager (Rev Man; version 4.2; The Cochrane Collaboration, Oxford, England).

### Assessment of study quality

Study quality was examined using a published 11-point scale that examines threats to validity of randomized controlled trials<sup>3</sup> (RCTs). Agreement in study quality determination as extracted by the two reviewers was rated using the quadratic weighted  $k$  statistic. The reviewers had almost perfect agreement for publications for inclusions with a  $k$  of 0.92 (95% CI 0.81–0.99).

### Outcome

Sixteen RCTs were included for this meta-analysis. Demographics of the 16 included studies are shown in Table 17.7. The 16 studies included in total 1183 children, of 592 were randomly assigned to CSF and 591 to control arms. One study reported two effects for the

**Table 17.7** Demographics of prophylactic GCSF or GMCSF trails.

Study (Reference)	Year of Publication	CSF	Study Population	Number of Subjects Randomly Assigned (CSF–Control Ratio)
Burdach <i>et al.</i>	1995	GMCSF	Soft tissue sarcoma, Ewing's sarcoma, neuroblastoma	12:12
Calderwood <i>et al.</i>	1994	GMCSF	HR ALL	20:20
Channa <i>et al.</i>	2002	GMCSF	AML	4:2
Clarke <i>et al.</i>	1999	GCSF	ALL or NHL	17:17
Dibenedetto <i>et al.</i>	1995	GCSF	IR ALL	14:18
Heath <i>et al.</i>	2003	GCSF	HR ALL	143:144
Laver <i>et al.</i>	1998	GCSF	ALL, lymphoblastic lymphoma	46:43
Little <i>et al.</i>	2002	GCSF	ALL or NHL	48:48
Michel <i>et al.</i>	2000	GCSF	HR ALL	34:33
Michon <i>et al.</i>	1998	GCSF	Neuroblastoma	31:28
Patte <i>et al.</i>	2002	GCSF	NHL	75:74
Pui <i>et al.</i>	1997	GCSF	ALL	80:84
Riikonen <i>et al.</i>	1995	GCSF	Diverse	20:20
Van Pelt <i>et al.</i>	1997	GMCSF	Osteosarcoma, Ewing's sarcoma, sarcoma of mesenchymal origin	14:14
Welte <i>et al.</i>	1996	GCSF	HR ALL	17:17
Wexler <i>et al.</i>	1996	GMCSF	Ewing's sarcoma, soft tissue sarcoma	19:18

HR: high risk; AML: acute myelogenous leukemia and IR: intermediate risk.

reported outcomes because results were stratified by two different chemotherapy regimens. Five of the studies evaluated granulocyte macrophage colony stimulating factor (GMCSF) while eleven evaluated granulocyte colony stimulating factor (GCSF). The primary diagnosis was acute leukemia or non-Hodgkin's lymphoma (NHL) in eleven studies, solid tumors in four studies and solid tumor and acute leukemia in one study. Of the ten studies that included children with ALL or NHL, CSFs were administered after induction in three studies, after intensification or consolidation blocks in five studies and after induction and consolidation chemotherapy in two studies. Pharmaceutical companies supported four of the sixteen studies included in this report.

There was substantial inter-rater agreement in the assessment scale of study quality with a quadratic weighted  $k$  of 0.69 (95% CI 0.35–0.99). The median study quality score was 8 (7–11) out of a possible score of 11, in which a higher score is associated with a better quality.

When the data from all 16 studies were analyzed and synthesized (Table 17.8 and Figure 17.6), CSFs reduced the rate of FBN with a rate ratio of 0.8 (95% CI 0.67–0.95;  $p = 0.01$ ). The mean rate of FBN in the control arms was 57% (range 39–100%). CSFs decreased the duration of neutropenia by approximately 4 days, reduced the duration of hospitalization by approximately 2 days. There was also a reduction in the usage of amphotericin B and a reduction in documented

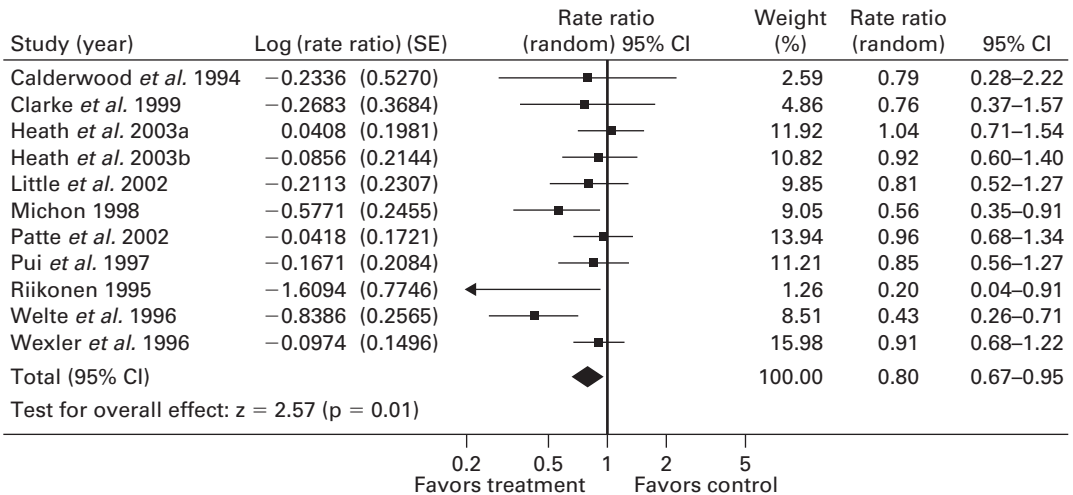


**Table 17.8** Summary of outcomes in GCSF/GMCSF compared with placebo/no-therapy groups.

Outcome	Number of Studies	Effect	95% CI*	p
Rate of febrile neutropenia	11	RR, 0.80	0.67 to 0.95	0.01
Duration of neutropenia, days	11	WMD, -3.9	-5.2 to -2.6	<0.00001
Duration of hospitalization, days	8	WMD, -1.9	-2.7 to -1.1	<0.00001
Rate of documented infections	11	RR, 0.78	0.62 to 0.97	0.02
Duration of parenteral antibiotics, days	6	WMD, -0.8	-2.3 to 0.7	0.3
Rate of amphotericin B use	2	RR, 0.50	0.28-0.87	0.02
Duration of chemotherapy delay, days	4	WMD, -4.3	-10.60 to 2.02	0.2
Infection related mortality	9	RR, 1.02	0.34 to 3.06	0.97

RR: rate ratio; WMD: weighted mean difference.

\* All analyses used a random effect model. A rate ratio <1 and a weighted mean difference <0 with 95% CIs that do not include 1 or 0, respectively, suggest that colony stimulating factors are better than placebo/no therapy.



**Figure 17.6** Forest plot of the rate of febrile neutropenia with colony stimulating factors. Squares (■) to the left of the vertical line indicate that the intervention reduces febrile neutropenia. Horizontal lines through the squares represent 95% CIs. The size of the squares reflects each study's relative weight, and the diamond (◆) represents the aggregate rate ratio and 95% CI. © American Society of Clinical Oncology (full reference on p. 471).

infections in children who received CSFs. However, no difference was noted with regard to infection related mortality with a rate ratio of 1.02 (95% CI 0.34-3.06;  $p = 0.97$ ).

Similar results were seen when the data was stratified by GCSF and GMCSF. Although there was a qualitative difference in infection related mortality, the rate ratios were not significantly different (Table 17.9).

When tumor types were evaluated for efficacy of CSFs, no differences in effectiveness were noted (Table 17.10).

Though three studies presented data from two cycles of chemotherapy separately, only data from the first cycle was included in the meta-analysis. However, when data analysis was repeated including data from the second cycle alone (excluding the first cycle), results were qualitatively unchanged.

Publication bias was suggested in one outcome, i.e. rate of FBN (one study was an asymmetric outlier). However, after exclusion or trimming of that study with the addition of a hypothetical study with equal weight but a negative effect, it was concluded that the possible

**Table 17.9** Subgroup analysis by GCSF or GMCSF.

Outcome	GCSF				GMCSF			
	Number of Studies	Effect*	95% CI	p	Number of Studies	Effect*	95% CI	p
Rate of febrile neutropenia	9	RR, 0.77	0.62 to 0.95	0.02	2	RR, 0.90	0.68 to 1.19	0.5
Duration of neutropenia, days	7	WMD, -4.2	-5.8 to -2.6	<0.00001	4	WMD, -3.5	-4.5 to -2.4	<0.00001
Rate of documented infections	7	RR, 0.67	0.50 to 0.89	0.007	4	RR, 0.94	0.68 to 1.31	0.7
Duration of parenteral antibiotics, days	4	WMD, -1.3	-3.2 to 0.7	0.2	2	WMD, 0.2	-1.3 to 1.6	0.8
Infection related mortality	6	RR, 1.60	0.40 to 6.33	0.5	3	RR, 0.47	0.08 to 2.88	0.4

RR: rate ratio.

\*All analyses used a random effect model. A rate ratio <1 and a weighted mean difference <0 with 95% CIs that do not include 1 or 0, respectively, suggest that colony stimulating factor is better than placebo/no therapy.

**Table 17.10** Subgroup analysis by underlying cancer.

Outcome	Acute Leukemia/NHL				Solid Tumors			
	Number of Studies	Effect*	95% CI	p	Number of Studies	Effect*	95% CI	p
Rate of febrile neutropenia	8	RR, 0.83	0.69 to 1.00	0.05	2	RR, 0.74	0.47 to 1.18	0.2
Duration of neutropenia, days	7	WMD, -3.2	-4.6 to -1.8	<0.00001	3	WMD, -3.6	-4.6 to -2.5	<0.00001
Rate of documented infections	7	RR, 0.71	0.54 to 0.95	0.02	3	RR, 0.91	0.64 to 1.28	0.6
Duration of parenteral antibiotics, days	3	WMD, -0.3	-2.6 to 2.0	0.8	2	WMD, 0.2	-1.3 to 1.6	0.8
Infection related mortality	7	RR, 1.05	0.30 to 3.69	0.9	2	RR, 0.93	0.10 to 8.92	>0.9

RR: rate ratio.

\*A rate ratio <1 and a weighted mean difference <0 with 95% CIs that do not include 1 or 0, respectively, suggest that colony stimulating factor is better than placebo/no therapy.

publication bias would have had a minimal impact on the analysis.

When costs of CSF treatment were qualitatively examined, three studies reported CSFs were associated with higher costs whereas three others found that CSFs were associated with lower costs.

QOL was not reported in any of the 16 studies.

## Study 4

Pui CH, Boyett JM, Hughes WT, Rivera GK, Hancock ML, Sandlund JT, Synold T, Relling MV, Ribeiro RC, Crist WM, Evans WE. Human granulocyte colony-stimulating factor after induction chemotherapy in children with acute lymphoblastic leukemia. *New Engl J Med* 1997;336:1781–7.

### Study design

This prospective randomized double blind, placebo controlled trial was conducted in St. Jude Hospital between December 1991 and August 1994 and included all patients with newly diagnosed acute lymphoblastic leukaemia (ALL) eligible for enrollment to Total Therapy Study XIII. The study was approved the institutional ethical board with written informed consent obtained for all patients. Randomization methodology was not specified in the report.

### Objectives

The primary objective of this study was:

- To determine the efficacy of prophylactic GCSF in preventing febrile neutropenia and consequent hospitalization among children with childhood lymphoblastic leukemia (ALL).

### Details of study

#### Study population

Previously untreated children with acute lymphoblastic leukemia (ALL) between the ages of 2 months and 17 years were included in the study. Three patients were deemed ineligible and were excluded (incorrect diagnosis in one and abnormal renal function in two).

### Conclusion

It was concluded that though the prophylactic use of CSFs in children with cancer reduced the rate of FBN (20%) documented infection rate (22%) and the duration of hospitalization, their use was not associated with a reduction in infection related mortality.

### Treatment schedule

One hundred and sixty-four eligible patients were stratified according to age, white blood cell count and DNA index, and were then randomly assigned to receive either high or low dose methotrexate (MTX) as initial therapy. Ninety-six hours after starting MTX, all patients commenced induction chemotherapy comprising prednisone (40 mg/m<sup>2</sup>/day × 4 weeks), vincristine (1.5 mg/m<sup>2</sup>/week × 4), asparaginase (10,000 units/m<sup>2</sup>/thrice weekly × 3 weeks), daunorubicin (25 mg/m<sup>2</sup> on days 1 and 8), etoposide (300 mg/m<sup>2</sup> on days 22, 25 and 29) and cytarabine (300 mg/m<sup>2</sup> on days 22, 25 and 29). One day after completion of induction (day 30), patients were randomized to receive either granulocyte colony stimulating factor (GCSF) or (n = 80) or placebo (n = 84). GCSF (10 µg/kg/day) was administered for 15 days or till the post-nadir neutrophil count (ANC) was 1000/mm<sup>3</sup> or higher for 2 consecutive days. Normal saline administered in an equal volume in identical syringes was used as placebo. No details of the subsequent consolidation and continuing treatments were described in the report. Blood counts were performed at least once every other day.

### Definitions

Fever was defined as an oral temperature of 38.3°C or higher on any occasion or a temperature of 38–38.2°C on two or more occasions within 12 hours.

Neutropenia was defined as ANC <0.5 × 10<sup>9</sup>/l.

### Supportive care

Children with neutropenic fever were hospitalized and commenced on broad-spectrum antibiotics (amikacin, vancomycin and ticarcillin) after obtaining appropriate blood and body fluid cultures. Antibiotics were discontinued after 7 days or when ANC was ≥0.5 × 10<sup>9</sup>/l, if the patient became afebrile within 96 hours of commencement of intravenous antibiotics. Patients, who

**Table 17.11** Clinical characteristics of 148 patients with ALL assigned to receive GCSF or placebo.<sup>a</sup>

Characteristics	GCSF Group (n = 73)	Placebo Group (n = 75)
<i>At diagnosis</i>		
Age		
Median (year)	5.8	5.7
Range (year)	0.2–17.9	1.0–16.9
1–10 year (number of patients)	52	52
Male sex (number of patients)	40	42
White race (number of patients)	61	66
Leukocyte count		
Median ( $\times 10^{-3}/\text{mm}^3$ )	17	11.6
Range ( $\times 10^{-3}/\text{mm}^3$ )	0.8–1512	0.7–581
$<25,000/\text{mm}^3$ (number of patients)	43	49
Neutrophil count		
Median ( $\times 10^{-3}/\text{mm}^3$ )	0.777	0.864
Range ( $\times 10^{-3}/\text{mm}^3$ )	0–18.18	0–74
$<100/\text{mm}^3$ (number of patients)	13	10
$<500/\text{mm}^3$ (number of patients)	30	29
Platelet count ( $\times 10^{-3}/\text{mm}^3$ )		
Median	60	59
Range	9–511	4–703
Immunophenotype (number of patients) <sup>b</sup>		
T lineage	11	11
B lineage	59	62
<i>At start of GCSF or placebo regimen</i>		
Leukocyte count ( $\times 10^{-3}/\text{mm}^3$ )		
Median	2.3	2.0
Range	0.7–11.9	0.5–6.9
Neutrophil count		
Median ( $\times 10^{-3}/\text{mm}^3$ )	0.528	0.442
Range ( $\times 10^{-3}/\text{mm}^3$ )	0–5.016	0–5.589
Mean ( $\pm$ SE)	0.818 $\pm$ 0.106	0.809 $\pm$ 0.124
$<100/\text{mm}^3$ (number of patients)	15	14
$<500/\text{mm}^3$ (number of patients)	35	40
Platelet count ( $\times 10^{-3}/\text{mm}^3$ )		
Median	110	124
Range	7–424	27–401
Previous hospitalization for fever (number of patients)	50	43

<sup>a</sup>p > 0.05 for all comparisons.<sup>b</sup>Data were unavailable for five patients.

remained febrile, were switched to ceftazidime with the addition of other appropriate antibiotics which depended on the sensitivity on the isolated microorganism. Amphotericin B was commenced if fever persisted beyond 7 days after commencement of intravenous antibiotics. Prophylaxis against *Pneumocystis carinii* infection was with trimethoprim–sulfamethoxazole combination and this was commenced on day 15 of remission induction therapy.

### Pharmacokinetics

Blood samples (on days 1 and 7) were collected prior to and at 0.25, 0.5, 1, 2, 4, 8, 12 and 24 hours after GCSF or placebo administration for colony stimulating activity. Samples were centrifuged within 3 hours of collection and stored at  $-20^{\circ}\text{C}$ . A one compartment pharmacokinetic model with zero order absorption of the drug and first order elimination constants was fit to the GCSF concentration – time data for each patient using the Bayesian algorithm and ADPT II software. The area under the plasma – GCSF concentration time curve was calculated according to the standard formulae<sup>2</sup>.

### Cost analysis

The supportive care costs (median total cost) per patient for both groups was calculated and this included the cost of intravenous antibiotics, transfusions, hospitalization and adding the median cost of GCSF for the GCSF group. The analysis was based on daily costs (40 kg and 1.3 m<sup>2</sup> body surface area) of \$205 for GCSF, \$118.5 for antibiotics, \$10.11 for amphotericin B, \$1574.73/day for hospital room (average cost at children's hospitals in the USA), \$150 for transfusion of leukocyte depleted packed red cells and \$550 for one transfusion of leukocyte depleted pheresed platelets.

### Statistics

A group sequential design (based on experience from 2 previous trials) with 80% power to detect a reduction in the rate of hospitalization from 40% to 20% at a significance level of 0.5 with two interim analyses and one final analysis was used. Differences in the distribution of baseline characteristics between the groups were assessed by the Fisher's exact test and differences in the frequency of complications were determined with an exact stratified Mantel–Haenszel test. A Wilcoxon rank sum test was used to compare the

duration of hospitalization for febrile neutropenia, the time from start of GCSF or placebo to the initiation of consolidation treatment and the costs of supportive care. Differences in ANC and area under the curve for GCSF on days 1 and 7 were analyzed by either the Wilcoxon rank sum test (for comparisons between two groups) or the Wilcoxon signed rank test (for comparison within a group). Probabilities of event-free survival was estimated by the Kaplan–Meier method and compared using the stratified Mantel–Haenszel test. Cumulative risks of secondary acute myeloid leukemia (AML) were compared by the Gray's test. Only two-sided p-values were reported.

### Outcome end points

The primary end points included rate of hospitalization, overall survival and cost of supportive care.

### Outcome

Of the 164 randomized patients, 16 (GCSF group 7; placebo group 9) were excluded as they were hospitalized for intravenous antibiotic therapy at the time when they were scheduled to commence growth factor treatment. The clinical characteristics of the two groups were similar and this is shown in Table 17.11.

### Neutrophil and platelet recovery

The GCSF group demonstrated a more rapid recovery from neutropenia than the placebo group ( $p = 0.007$ ). The period of neutropenia when ANC was  $<0.5 \times 10^9/\text{l}$  and  $<1 \times 10^9/\text{l}$  were 5.3 days and 6.1 days respectively in the GCSF group compared to 12.7 and 14 days respectively in the placebo group (Table 17.12). GCSF did not hamper platelet recovery.

### Hospitalization for febrile neutropenia

Hospitalization rates were similar in both groups of patients – 58% for the GCSF group and 68% for the placebo group (relative risk for the GCSF group – 0.85%; 95% CI 0.59–1.16,  $p = 0.23$ ). Though, fever persisted for a median of 2 days in both groups of patients, the median hospital stay was significantly shorter in the GCSF group (6 versus 10 days;  $p = 0.011$ ); 11% of patient in the GCSF group spent  $>9$  days in hospital compared to 37% in the placebo group (Figure 17.7). The GCSF group had fewer documented infections (12 versus 27;  $p = 0.009$ ) but the difference in the number

**Table 17.12** Hematologic toxic effects, hospitalization for febrile neutropenia and supportive care in the GCSF and placebo groups.

Variable	GCSF Group (n = 73)	Placebo Group (n = 75)
<b>Hematologic toxic effects</b>		
Neutrophil count: nadir ( $\times 10^{-3}/\text{mm}^3$ )		
Median	0	0
Range	0–3.6	0–0.93
$<1000/\text{mm}^3$ (number of days)	6.1	$>14^a$
$<500/\text{mm}^3$ (number of days)	5.3	$12.7^a$
Platelet count: nadir ( $\times 10^{-3}/\text{mm}^3$ )		
Median	14	18
Range	2–330	3–120
$<75,000/\text{mm}^3$ (number of days)	8.9	8.3
<b>Hospitalization for febrile neutropenia</b>		
Number of patients (%)	42 (58)	51 (68)
Number of days		
Median	6	$10^b$
Range	1–37	1–30
Number of days with fever		
Median	2	2
Range	0–36	0–27
Number of documented infections	12	$27^c$
Number of grade 3 or 4 infections	5	6
<b>Supportive care</b>		
Intravenous antibiotics		
Number of patients	42	51
Number of days		
Median	6	9
Range	2–36	2–30
Amphotericin B		
Number of patients	6	12
Number of days		
Median	7	6
Range	4–8	1–28
Platelet transfusions		
Number of patients	40	34
Number of transfusions		
Median	1	1
Range	1–26	1–7
Packed red cell transfusions		
Number of patients	68	71
Number of transfusions		
Median	2	2
Range	1–7	1–6

<sup>a</sup>p = 0.007 in a longitudinal model.<sup>b</sup>p = 0.011.<sup>c</sup>p = 0.009.

**Table 17.13** Documented infections.<sup>a</sup>

Type or Site of Infection	Number of Patients	
	GCSF Group (n = 73)	Placebo Group (n = 75)
Severe infection (grade 3 or 4)		
Pneumonia	3	2
Bacteremia <sup>b</sup>	1	3
Disseminated fungal infection <sup>c</sup>	0	1
Typhlitis	1	0
Mild to moderate infection (grade 1 or 2)		
Cellulitis	0	5
Urinary tract infection	1	1
Infection at exit site or within tunnel track of central venous catheter	0	4
Otitis media	1	3
Herpes simplex	3	3
<i>Clostridium difficile</i> enterocolitis	0	3
Sinusitis	1	1
Lymphadenitis	0	1
Conjunctivitis	1	0

<sup>a</sup>Infections were documented according to the following criteria: pneumonia, pulmonary infiltrates on radiography plus compatible clinical signs and symptoms; bacteremia, blood-culture isolate of any bacterium; disseminated fungal infection, isolation of a fungal organism from an otherwise sterile specimen of tissue or fluid (e.g., blood or cerebrospinal fluid) plus a clinically compatible illness or histologic demonstration of yeast, pseudohyphae or hyphae in biopsy specimens, with isolation of a corresponding fungal species in culture from the same tissue; typhlitis and sinusitis, typical radiographic findings with compatible symptoms; cellulitis and catheter-site infections, as described by Hughes *et al*<sup>3</sup> urinary tract infection, bacterial count (for a single organism) of at least 100,000/ml of urine plus compatible symptoms; herpes simplex infection, typical lesions and a viral isolate by cell culture; and *Clostridium difficile* infection, diarrhea with toxin in fecal sample. Otitis media was documented on the basis of an otoscopic evaluation by the patient's physician. Gastroenteritis, upper respiratory tract infections, mucositis and oral thrush were not included because of variable diagnostic criteria.

<sup>b</sup>The infecting organism was *Streptococcus sanguis*, *Staph. Epidermidis*, *Klebsiella pneumoniae* or *Acinetobacter calcoaceticus*.

<sup>c</sup>The infecting organism was *Histoplasma capsulatum*.

of severe infections were not different (5 versus 6) (Table 17.13). No patient had a fatal complication.

The use of parenteral antibiotics and transfusions were similar in both groups.

### Relation between systemic exposure to GCSF and response

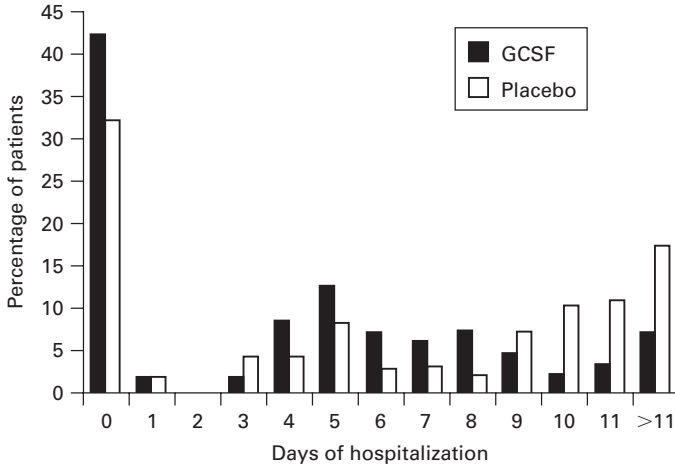
Though the area under the curve did not change significantly from days 1 to 7 for the GCSF group ( $362 \pm 54.6$  ng/ml hour on day 1 and  $366 \pm 58.0$  ng/ml hour on day 7), it did increase significantly for the placebo group ( $6.8 \pm 2.7$  ng to  $23 \pm 8.2$  ng/ml hour,  $p < 0.001$ ), reflecting the endogenous response to decreased ANC in the patients receiving the placebo.

Systemic exposure to GCSF on day 1 was not significantly related to the probability of hospitalization on

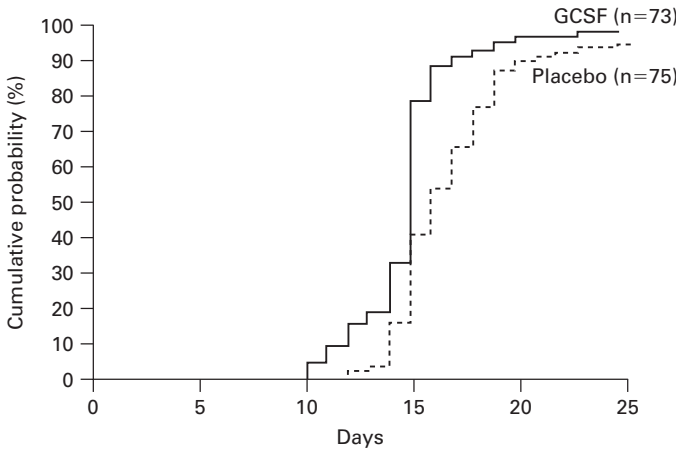
days 1–7 but higher values on day 7 were related to a lower probability of hospitalization from days 8–21 for the 61 patients who were not hospitalized between days 1–7 ( $p = 0.049$ ).

### Outcome of anti-leukemia therapy

The time to commence consolidation therapy was significantly shorter in the GCSF group ( $p < 0.001$ ) (Figure 17.8) but the 3-year event-free survival was similar in both groups (83%; 95% CI 71–95% in the GCSF group versus 95% CI 72–94% in the placebo group). There was no significant difference in the 3-year cumulative incidence of AML between the two groups of patients (5.1%; 95% CI 0.1–10 in the GCSF group versus 3.9%; 95% CI 0–8.4% in the placebo group,  $p = 0.36$ ).



**Figure 17.7** Distribution of total days of hospitalization in 148 patients with ALL assigned to receive GCSF or placebo. Reprinted from Pui *et al.* (full reference on p. 476). © 1997 Massachusetts Medical Society.



**Figure 17.8** Cumulative probability of starting consolidation therapy at specific times after the start of the GCSF or placebo regimen. The time to the start of consolidation therapy was significantly shorter in the GCSF group ( $p < 0.001$ ). Reprinted from Pui *et al.* (full reference on p. 476). © 1997 Massachusetts Medical Society.

### Cost analysis

The median estimated cost of all supportive care was \$8768 (range \$1435–79,674) per patient in the GCSF group and \$8616 (range \$0–55,830) in the placebo control group ( $p = 0.83$ ). A separate analysis based on a hypothetical lower dose of GCSF ( $5 \mu\text{g}/\text{kg}$ ) also showed no significant reduction in supportive care costs in the GCSF group ( $p = 0.67$ ).

### Conclusion

The report concluded that though GCSF was associated with a faster neutrophil recovery and fewer documented infections and was of some clinical benefit for children with ALL after induction therapy, but it did not reduce the rate of hospitalization, prolong survival or reduce the cost of supportive care.



## Study 5

Laver J, Amylon M, Desai S, Link M, Schwenn M, Mahmoud H, Shuster J. Randomized trial of r-metHu granulocyte colony-stimulating factor in an intensive treatment for T-cell leukemia and advanced-stage lymphoblastic lymphoma of childhood: a Pediatric Oncology Group pilot study. *J Clin Oncol* 1998;1:522–6.

### Study design

This single center prospective open label randomized trial was performed during the period April 1994 to December 1995. The study was approved by the institutional ethical board with informed consent obtained for all patients. Randomization methodology was not specified in the report.

#### Objectives

The study aimed to determine whether prophylactic recombinant granulocyte colony stimulating factor (GCSF):

- Reduced the duration of neutropenia.
- Shortened the duration of hospitalization.
- Reduced the delay in the administration of subsequent chemotherapy.

### Study details

#### Study population

Previously untreated children and adolescents between 1 and 22 years of age with T acute lymphoblastic leukemia (T-ALL) or advanced stage lymphoblastic lymphoma (ASLL) (stage III/IV) were included in the study. Patient characteristics are shown in Table 17.14.

**Table 17.14** Patient characteristics.

Patients	Number on Non-GCSF Arm	Number on GCSF Arm
Entered	43	46
Eligible	43	45
Male/female	30/13	30/15
T-ALL/ASLL	26/17	29/16
Median age, years	9	9

### Treatment program

The treatment strategy including chemotherapy doses are shown in Table 17.15. Briefly, the treatment comprised of remission induction and consolidation blocks that was followed by 10 cycles of continuing therapy. Patients were randomized to receive r-metHuGCSF or no r-metHuGCSF during the remission induction phase and two cycles of continuing therapy. However, during the continuing phase of treatment, patients randomized to receive r-metHuGCSF did not receive it after methotrexate/6 mercaptopurine combination as this combination was felt not to result in severe neutropenia. r-metHuGCSF (10 µg/kg/day) was administered subcutaneously 24 hours after completion of chemotherapy and was continued till the neutrophil count (ANC) was >10,000/µl. The next cycle of chemotherapy was commenced 48 hours after discontinuing r-metHuGCSF provided the ANC was >500/µl. For the control group of patients, chemotherapy was commenced when the ANC was >500/µl. Platelet count had to be >100,000/µl for both groups of patients for commencement of chemotherapy.

### Supportive care

Patients with febrile neutropenia were hospitalized and treated with broad-spectrum parenteral antibiotics after obtaining appropriate cultures. Amphotericin B was started if fever persisted beyond 6 days after commencement of parenteral antibiotics.

### Statistics

The study intended to randomize approximately 80 patients of whom, 72 were expected to complete induction and 60 to complete two cycles of the continuing therapy. It was assumed that the correlation between two continuing cycles was 0.5 or less and the data would follow an approximate log normal distribution. The Wilcoxon test was applied to detect a difference of 0.55 SDs and 0.64 SDs in a single course scale for induction and continuing therapy, respectively, at  $p < 0.05$  two sided and with 80% minimum power.

### Outcome end points

The primary end point was the number of days of neutropenia during the induction phase and two consecutive cycles of continuing therapy. Secondary end points were the duration of hospitalization during

**Table 17.15** Pediatric oncology group study No. 9398 treatment program.**Induction**

## Day 1

Vincristine 1.5 mg/m<sup>2</sup> IVP × 5 weekly  
 Prednisone 40 mg/m<sup>2</sup>/day orally for 28 days  
 Cyclophosphamide 1000 mg/m<sup>2</sup> IV  
 Doxorubicin 50 mg/m<sup>2</sup> IV

## Day 22

Cytarabine 500 mg/m<sup>2</sup> IVP followed by 80 mg/m<sup>2</sup>/hour continuous infusion for 48 hours  
 L-asparaginase 10,000 mg/m<sup>2</sup> IM every other day for 3 doses starting on day 25  
 r-metHuGCSF 10 µg/kg SC starting on day 2 and day 26 (for patients randomized to the GCSF arm)  
 TIT on days 1, 15 and 29 and day 8 for patients with CNS involvement

**Consolidation**

## Days 43 and 64

Methotrexate 200 mg/m<sup>2</sup> IVP followed by 800 mg/m<sup>2</sup> IV (IDM) over 24 hours and then: Mercaptopurine (MP) 200 mg/m<sup>2</sup> IVP followed by 800 mg/m<sup>2</sup> over 6 hours with Leucovorin rescue. TIT days 43 and 64

## Days 50, 57, 71, 78

Methotrexate 20 mg/m<sup>2</sup> IM  
 MP 50 mg/m<sup>2</sup>/day for 14 days (days 50–63 and 71–84)

**Continuation therapy**

Starts day 85 and includes a 9-week cycle repeated 10 times (study evaluated r-metHuGCSF only in two cycles)

## Day 1

Vincristine 2.0 mg/m<sup>2</sup> IVP  
 Doxorubicin 30 mg/m<sup>2</sup> IV  
 Prednisone 120 mg/m<sup>2</sup>/day orally for 5 days  
 MP 225 mg/m<sup>2</sup>/day orally for 5 days  
 L-asparaginase 25,000 IU/m<sup>2</sup> weekly for 20 doses  
 TIT

## Day 22

Cytarabine 500 mg/m<sup>2</sup> IVP followed by 80 mg/m<sup>2</sup>/hour continuous infusion for 48 hours r-metHuGCSF started days 2 and 26 on each of the two cycles (patients randomized to the GCSF arm)

## Day 43

IDM followed by MP  
 TIT

## Days 50, 57

Methotrexate 20 mg/m<sup>2</sup> IM (days 50 and 57) and MP for 14 days

IVP: IV push; IV: intravenously; IM: intramuscularly; SC: subcutaneously; TIT: triple intrathecal therapy with methotrexate, hydrocortisone and cytarabine and IDM: intermediate dose methotrexate.

induction and continuing therapy and the delay in recommencement of chemotherapy due to neutropenia.

**Outcome**

Of the 89 patients entered on the study, 88 were considered eligible for analysis. The reason for the single exclusion was not specified.

**Duration of neutropenia, hospitalization and chemotherapy delays**

The median number of days of neutropenia during induction (<500/µl) was 4.5 days with or without

r-metHuGCSF ( $p = 0.35$ ). Similarly there was no significant difference in the median duration of hospitalization during induction which was 9 days in both groups of patients ( $p = 0.79$ ) or in the number of days of chemotherapy delay ( $p = 0.11$ ) following the induction phase of therapy (Table 17.16).

During continuing therapy, median number of days with ANC <500/µl, delays in chemotherapy and the number of hospitalized days were 11, 7 and 10.5 days respectively for the no r-metHuGCSF group while it was 6, 5.5 and 8.5 days respectively for the r-metHuGCSF group (Table 17.17). Though there was no significant

**Table 17.16** Induction phase results for first, median and third quartile.

	Non-GCSF	GCSF	p <sup>a</sup>
ANC <500/ $\mu$ l, days <sup>b</sup>	1.5, 4.5, 9	2.5, 4.5, 7	0.35
Delays in therapy, days <sup>b</sup>	0, 0, 4	0, 0, 1.5	0.11 <sup>c</sup>
Hospitalization, days <sup>b</sup>	6, 9, 15	6.5, 9, 13.5	0.96

<sup>a</sup>Two-sided Wilcoxon test.<sup>b</sup>Patient average number of days per cycle.<sup>c</sup>Favors GCSF.**Table 17.17** Continuation therapy phase results for first, median and third quartile.

	Non-GCSF	GCSF	p Values <sup>a</sup>
ANC <500/ $\mu$ l, days <sup>b</sup>	7.5, 11, 13.5	4, 6, 10.5	0.017
Delays in therapy, days <sup>b</sup>	3, 7, 15	0, 5.5, 10.5	0.16
Hospitalization, days <sup>b</sup>	6.5, 10.5, 15.5	5.5, 8.5, 12	0.22

<sup>a</sup>Two-sided Wilcoxon test.<sup>b</sup>Patient average number of days per cycle.

difference between the two groups of patients with regard to delay in chemotherapy ( $p = 0.16$ ) or duration of hospitalization ( $p = 0.22$ ), there was statistically significant difference in the number days of ANC < 500/ $\mu$ l favoring the r-metHuGCSF group ( $p = 0.017$ ).

### Event-free survival

There was no difference in the 2-year event-free survival (EFS) rates (71%) between the r-metHuGCSF and non-r-metHuGCSF groups (log rank p-value, 0.52).

### Conclusion

It was concluded that prophylactic granulocyte colony stimulating factor (GCSF) did not shorten the duration of neutropenia or reduce the duration of hospitalization and chemotherapy delays during the induction phase but significantly shortened the duration of neutropenia when administered during the continuing phase of treatment. It was also concluded that prophylactic GCSF did not improve the EFS.

## Study 6

Clarke V, Dunstan FD, Webb DK. Granulocyte colony-stimulating factor ameliorates toxicity of intensification chemotherapy for acute lymphoblastic leukemia. *Med Pediatr Oncol* 1999;32:331–5.

### Study design

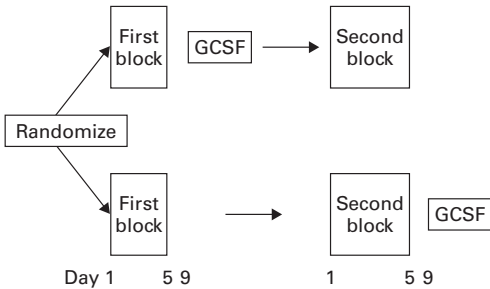
This was a single center randomized crossover study that ran from January 1995 till April 1996 and included all patients eligible for enrollment on the Medical Research Council (MRC) UKALL XI trial.

The study had approval from the local research and ethics committee and informed consent was obtained for all patients included in the study. Randomization methodology was not specified in the report.

### Objectives

The main objective of the study was:

- To evaluate the benefit of prophylactic granulocyte colony stimulating factor (GCSF) in reducing toxicity after intensification chemotherapy in children with acute lymphoblastic leukemia (ALL).



**Figure 17.9** Outline of study design. Reprinted from Clarke *et al.* (full reference on p. 484) with permission of Wiley-Liss, Inc., a subsidiary of John Wiley & Sons, Inc.

### Study details

All previously untreated patients with acute lymphoblastic leukemia (ALL) and T-NHL were eligible for inclusion in the study. No exclusion criteria details were provided in the report.

### Treatment program

Induction of remission was accomplished with a three-drug regimen (vincristine, prednisolone and asparaginase) and this was followed by two 5-day intensification blocks. Intensification chemotherapy was given at weeks 5 and 20. Central nervous system prophylaxis was randomly assigned and stratified by the presenting white blood cell count (WBC): children with a WBC count  $<50 \times 10^9/l$  were randomized to receive either intrathecal methotrexate (IT MTX) alone or IT MTX plus high dose intravenous MTX (IV HD MTX), children with a presenting WBC count  $>50 \times 10^9/l$  were randomized to receive either IT MTX plus 24 Gy cranial irradiation or IV HD MTX plus IT MTX.

Continuing therapy commenced after recovery from the second intensification block and required the neutrophil count (ANC) to be  $\geq 1 \times 10^9/l$  and platelets to be  $\geq 100 \times 10^9/l$ . Blood counts were performed at weekly intervals and decisions taken with regard to continuing phase of treatment were based on these counts.

Children were randomized to receive granulocyte colony stimulating factor (GCSF) as a daily subcutaneously ( $5 \mu\text{g}/\text{kg}$ ), and commenced 4 days after either the first or second intensification, resulting in the crossover design (Figure 17.9). GCSF was continued until the ANC was  $\geq 0.5 \times 10^9/l$  for 3 consecutive days.

### Supportive care

Febrile neutropenia (FBN) was defined as fever unrelated to a blood transfusion and  $>38^\circ\text{C}$  for 4 hours or

a single recorded temperature  $>39^\circ\text{C}$  with the ANC  $<0.5 \times 10^9/l$ . All children with FBN were hospitalized for broad-spectrum parenteral antibiotic treatment. If fever persisted beyond 96 hours after commencement of antibiotics and blood cultures were negative, amphotericin was started empirically. Children with an indwelling central venous catheter and with positive blood cultures received 10 days of intravenous antibiotics. All children were given regular co-trimoxazole as prophylaxis against *Pneumocystis carinii* infection.

### Outcome end points

The primary end points were (1) duration of neutropenia (ANC  $<1 \times 10^9/l$ ) and (2) the severity of neutropenia (ANC  $<0.5 \times 10^9/l$ ), (3) duration of hospitalization and (4) duration of antibiotic treatment.

### Statistics

Analysis of data was based on an intention to treat by analysis of variance. Normality of residuals was tested using the Shapiro–Wilkes test and where appropriate logarithmic transformation was applied to the data.

### Outcome

#### Study population

Of the 19 children (ALL, 18; T-NHL, 1) eligible for inclusion in the study, only 17 were randomized (two families refused consent). One child was not given GCSF after the second intensification block due to serious illness that developed immediately after the second intensification block and prior to commencement of GCSF. The median age was 4.5 years (range 1–15 years). All children with ALL had a presenting WBC count  $<50 \times 10^9/l$ . Eight children were randomized to receive GCSF after the first intensification block and nine after the second intensification block.

#### Duration of neutropenia

The use of GCSF resulted in a significant reduction in the number of days of neutropenia ( $p = 0.0001$ ) and severe neutropenia ( $p = 0.002$ ) with a 95% confidence interval (CI) for reduction in neutropenia of 3.8–8 days and in severe neutropenia of 1.8–7.4 days (Table 17.18). A significant period effect was reported with longer period of neutropenia after the second intensification block ( $p = 0.0003$ , 95% CI 2.2–6.4 days). Children who received GCSF after the second intensification block

**Table 17.18** Comparison for main study end points.\*

	With GCSF	Without GCSF
Days of neutropenia <sup>a</sup>	7.9 (3.9–14.3)	13.8 (7.9–23.0)
Days of severe neutropenia <sup>b</sup>	6.5 (2.0–12.8)	10.4 (6.3–20.3)
Days in hospital <sup>c</sup>	5.5 (0–16)	9 (6–15)
Days on antibiotics	7 (0–15)	9 (5–17)
Days of fever	3 (0–9)	3 (1–11)

\*The table shows the median (range) for each of the five variables in the 2 treatment groups.

<sup>a</sup>p = 0.0001.

<sup>b</sup>p = 0.003.

<sup>c</sup>p = 0.01.

were significantly more likely to commence continuing therapy on schedule (Mann–Whitney test,  $p = 0.05$ ) (Table 17.19).

### Duration of hospitalization

Children spent fewer days in hospital when they were receiving GCSF ( $p = 0.01$ , 95% CI 0.9–6.3 days).

### Duration of antibiotics and fever

There were no significant reductions in the number of days of antibiotic treatment ( $p = 0.1$ ) or number of

**Table 17.19** Adherence to chemotherapy schedule: number of children resuming maintenance on time following second intensification.\*

Maintenance Resumed	With GCSF (n = 9)	Without (n = 8)
On time	6	2
1 week late	3	2
2 weeks late	0	4

\*Mann–Whitney test,  $p = 0.05$ .

days of fever ( $p = 0.3$ ). All fevers settled prior to discontinuation of GCSF. Similarly, there were no significant differences in the use of amphotericin, incidence of positive blood cultures or transfusion requirements.

### Conclusion

It was concluded that GCSF reduced hematological toxicity of intensification chemotherapy and improved compliance with chemotherapy scheduling especially when it was given after the second intensification block.

## Study 7

Little MA, Morland B, Chisholm J, Hole A, Shankar A, Devine T, Easlea D, Meyer LC, Pinkerton CR. A randomized study of prophylactic G-CSF following MRC UKALL XI intensification regimen in childhood ALL and T-NHL. *Med Pediatr Oncol* 2002;**38**:98–103.

### Study design

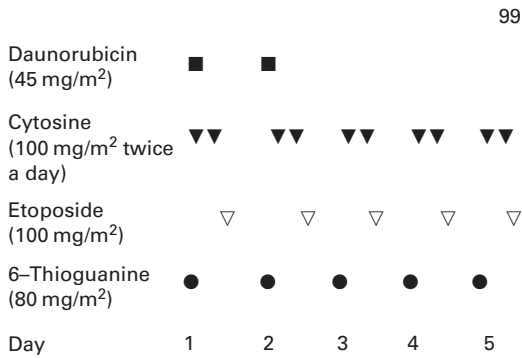
This was a two center prospective randomized crossover study that was conducted between June 1996 and December 1997. The study had local research committee approval of both participating centers and written informed consent was obtained for all patients included in the study. Patients were randomized via a computer generated system to receive granulocyte colony stimulating factor (GCSF) prophylaxis after one of two

intensification blocks. A crossover design was used such that patients who received no GCSF (control) following the first intensification block would receive prophylactic GCSF after the second block and vice versa.

### Objectives

The main objectives of this study were:

- To determine if prophylactic administration of granulocyte colony stimulating factor (GCSF) after intensification blocks reduced subsequent readmission rates with febrile neutropenia, influenced the duration of hospitalization or the amount of supportive care.
- To evaluate the tolerability of prophylactic GCSF in this clinical setting.



**Figure 17.10** Intensification chemotherapy used in study patients. Reprinted from Little *et al.* (full reference on p. 486) with permission of Wiley-Liss, Inc., a subsidiary of John Wiley & Sons, Inc.

### Study details

All previously untreated children below the age of 17 years with either acute lymphoblastic leukemia (ALL) or T-NHL were eligible for the study. All patients were treated according on one of the following protocols: MRC ALL 97, or UKALL XI or the UKCCSG 9504 NHL.

### Treatment program

All three protocols had two identical courses of intensification blocks at weeks 5 and 20. The intensification block consisted of daunorubicin 45 mg/m<sup>2</sup> on days 1 and 2, cytarabine 100 mg/m<sup>2</sup> 12 hourly on days 1–5, thioguanine 80 mg/m<sup>2</sup>/day on days 1–5 and etoposide 100 mg/m<sup>2</sup>/day on days 1–5 (Figure 17.10). All patients were in complete remission prior to randomization on the study.

### Supportive care

Febriile neutropenia (FBN) was defined as a documented fever of 38.5°C on one occasion or 38°C on two occasions; or a clinical evidence of infection such as rigors or septic shock when the neutrophil count (ANC) was  $<0.5 \times 10^9/l$ .

Prophylaxis for *Pneumocystis carinii* infection was with oral trimethoprim–sulfamethoxazole that which commenced with the first intensification block at week 5.

On admission to hospital for treatment of FBN, all patients had blood counts and blood cultures performed prior to commencement of broad-spectrum antibiotic treatment. Antibiotic therapy for FBN was according to the local institutional policy and the duration of hospital admission was also determined by the local departmental policy.

For patients randomized to receive GCSF (5 µg/kg/day; subcutaneously), this commenced within 24 hours of completion of the last dose of chemotherapy and continued for a total of 10 days or until the ANC reached  $>10 \times 10^9/l$ , whichever occurred sooner.

GCSF was given electively (5 µg/kg/d) intravenously to all patients admitted to hospital with FBN (or continued if the patient was previously randomized to GCSF prophylaxis) and was continued either until discharge or until the ANC was  $>10 \times 10^9/l$ ; whichever occurred earlier. The decision to administer GCSF to all patients admitted for FBN was based on a previous study by the same institutions which showed that those patients who received GCSF for FBN had a shorter hospital stay and a more rapid ANC recovery.

### Outcome end points

The primary end point was the rate of readmission to hospital for the management of FBN within 28 days of commencing either week 5 or 20 of the intensification cycle.

Secondary end points were (1) duration of hospital stay, (2) duration of antibiotic usage, (3) duration of anti-fungal usage, (4) blood product support, (5) time to ANC recovery and (6) tolerability of GCSF.

### Outcome

Of the 48 patients were randomized on the study from the two centers, two withdrew from the study for the following reasons – one patient underwent bone marrow transplantation prior to week 20 intensification block and the other was because of parental request. Patient characteristics are shown in Table 17.20.

### Hospitalization for FBN

Readmission rate with FBN was significantly reduced in the group that received prophylactic GCSF (34 of 46 patients (74%) compared to 42 of 46 patients (91%) in the control arm;  $p = 0.0386$ ).

Fever resolution was more rapid in the GCSF group compared with the control group, though this was not statistically significant [27% versus 9%;  $p = 0.0768$  (two tailed)].

There were no significant differences in the ANC on readmission to hospital between the two groups and, no evidence of any period effect. Similarly, there were no significant differences in the duration of hospital

**Table 17.20** Patient characteristics.

		Control → GCSF	GCSF → Control	Total (n = 48)
Diagnosis	ALL	23	22	45
	T-NHL	1	2	3
Gender	Male	14	17	31
	Female	10	7	17
Age (years)	<2	1	1	2
	2 ≤ 5	15	10	25
	5 ≤ 10	7	10	17
	>10	1	3	4

admission between the two groups of patients (6 days for each group).

No evidence of differential carryover effect (period effect) was seen and results remain unchanged when these were checked using non-parametric methods of analysis.

### Hematological toxicity

No differences were seen between the two groups of patients with regard to speed of recovery of ANC  $>0.5 \times 10^9/l$ . Transfusion requirements were also similar in both groups of patients.

### Duration of supportive care and GCSF tolerability

No significant differences were seen with regard to the use of antibiotics, anti-fungals or anti-viral therapy between the two groups of patients. The incidence of mucositis was 16% in either group.

Prophylactic GCSF that was administered subcutaneously was well tolerated with no reported adverse events during the study.

### Cost analysis

The total cost incurred by the control group was £138,246 (US \$221,194) while the costs for the GCSF group were £150,048 (US \$240,077). Despite the lower rate of hospital admission in the GCSF group, there appeared to be no demonstrable cost benefit for the use of prophylactic GCSF.

### Conclusion

The study concluded that prophylactic GCSF administered after intensification therapy significantly reduced the rate of hospital readmissions for the management of FBN. However, there was no cost benefit for the use of prophylactic GCSF.

## Study 8

Delorme J, Badin S, Le Corroller AG, Auvrignon AA, Auclerc MF, Gandemer V, Bordigoni P, Lamagnere JP, Demeocq F, Perel Y, Berthou C, Bauduer F, Pautard B, Vannier JP, Braguer D, Leblanc T, Leverger G, Baruchel A, Michel G. Economic evaluation of recombinant human granulocyte colony-stimulating factor in very high-risk childhood acute lymphoblastic leukemia. *J Pediatr Hematol Oncol* 2003;25:441–7.

### Study design

This multi-center open label trial was carried out in 12 public hospitals in France and was conducted during

the period from June 1993 to January 1998 and included all children with high risk acute lymphoblastic leukemia (ALL) eligible for enrollment on the FRALLE 93 trial. See Study 2 for inclusion details.

### Objectives

The aim of this report was:

- To perform an economic evaluation of the use of prophylactic GCSF in children with high risk ALL.

### Study details

Refer to Study 2, Chapter 17.

**Table 17.21** Mean costs per patient.

Costs	GCSF Group* (US\$)	Non-GCSF Group* (US\$)	p
Hospitalization			
For chemotherapy	10,149.8 ± 0	10,149.8 ± 0	–
For toxicity	11,733.2 ± 1328	15,630.7 ± 1588	0.025
Total hospitalization	21,883 ± 1328	25,780.5 ± 1588	0.025
Platelets	2876.1 ± 298	1958.1 ± 221	0.01
Red blood cell	679.4 ± 85	645.5 ± 74	0.898
Anti-cancer drugs	1263.8 ± 32	1183.3 ± 86	0.528
Anti-infectious IV	1584.6 ± 307	1740.2 ± 374	0.877
GCSF	4022.4 ± 382	261.8 ± 101	–
Total costs	32,309.3 ± 1594	31,569.4 ± 1762	0.838

\*Data = mean ± SE.

**Table 17.22** Physical units.

	GCSF Group*	Non-GCSF Group*	p
Hospitalization (days)	53.9 ± 3.3	63.5 ± 4.0	0.025
Platelet transfusions (units)	4.7 ± 0.5	3.2 ± 0.4	0.01
Red blood cell transfusions (units)	6.0 ± 0.7	5.7 ± 0.7	0.898

\*Data = mean ± SE.

## Costing

The study was restricted to direct medical costs. The following cost factors were measured in physical units for each of the patients included in the trial: (1) hospital stay, (2) units of blood products used by category (e.g. red cell transfusions, platelet transfusions, single donor platelet unit etc.) and (3) number of days and prescribed dose per day of granulocyte colony stimulating factor (GCSF), antibiotics, anti-fungals and chemotherapy (see Table 17.21). Hospitalization unit cost was calculated as per diem cost for a pediatric hospital including overhead costs (office and equipments), salaries and medical tests.

## Statistics

Comparisons in cost per patient and differences in cost per patient per course were performed using the non-parametric Mann–Whitney test. Hospital stay was compared using the one tailed Student's t-test (normal distribution). Costs of hospitalization were selected as the most relevant cost that could change in different

hospitals. Hospitalization unit costs ranged from –25% to +50% with respect to baseline unit costs.

## Results: economic assessment

Hospital stay was significantly shorter in the GCSF group compared to control group (53.9 days versus 63.5 days;  $p = 0.025$ ), while the number of platelet units transfused were significantly higher in the GCSF group (4.7 versus 3.2;  $p = 0.01$ ). Red cell transfusions were similar in both groups (6 versus 5.7;  $p = 0.898$ ). Costing according to the resource category indicated that for the GCSF group, hospitalization cost was significantly reduced (US \$21,883 versus US \$25,780) while the costs of platelet transfusions were significantly increased (US \$2876 versus US \$1958). Mean costs are per patient are shown in Table 17.21 and cost factors per patient are shown in Table 17.22.

Table 17.23 shows the sensitivity analysis when costs of hospitalization varied from –25% to +50% from the basal cost.



**Table 17.23** Sensitivity analysis: variation in cost of hospitalization.

Cost of Hospitalization	GCSF Group Total Costs (US\$)	Non-GCSF Group Total Costs (US\$)
-25% (US \$304.5/day)	26,838	25,124
Basal (US \$405.99/day)	32,309	31,569
+25% (US \$507/day)	37,779	38,014
+50% (US \$608/day)	43,250	44,460

**Table 17.24** Mean costs per R3 course.

Total R3	GCSF Group (US\$)/Course*	Non-GCSF Group (US\$)/Course*	p
Hospitalization cost	3857 ± 172	4993.8 ± 240	<0.001
Platelet transfusions	673.2 ± 53	489.5 ± 45	0.03
Red blood cell transfusions	140.8 ± 17	121.8 ± 13	0.786
Anti-cancer drugs	224.7 ± 9	214.5 ± 10	0.542
Anti-infectious IV	171.4 ± 25	306.2 ± 49	0.029
GCSF	781.7 ± 45	55.2 ± 20	-
Total costs	5848.8 ± 217	6181 ± 279	0.589

\*Data = mean ± SE.

**Table 17.25** Mean costs per COPADM course.

COPADM	GCSF Group (US\$)/Course*	Non-GCSF Group (US\$)/Course*	p
Hospitalization cost	5156.1 ± 338	5399.7 ± 330	0.42
Platelet transfusions	428.3 ± 106	244.8 ± 73	0.07
Red blood cell transfusions	135.1 ± 21	102.5 ± 12	0.971
Anti-cancer drugs	294.7 ± 15	269.8 ± 16	0.307
Anti-infectious IV	535.3 ± 137	410.8 ± 62	0.589
GCSF	838.6 ± 73	48.1 ± 31	-
Total costs	7388.1 ± 511	6475.7 ± 411	0.244

\*Data = mean ± SE.

### Costing according to chemotherapy regimen

After the R3 regimen, mean costs of hospitalization (US \$3857 versus US \$4993.80;  $p < 0.001$ ) and antibiotics (US \$171.40 versus US \$306.20;  $p = 0.029$ ) were significantly lower in the GCSF group but the cost of platelet transfusions were higher (US \$673.20 versus US \$489.50;  $p = 0.03$ ). After COPADM, costs per resource category were similar for both groups. Other costs did not vary significantly with either R3 or COPADM.

The total cost per patient per course was not significantly different between the two groups (Tables 17.24 and 17.25).

### Conclusion

It was concluded that prophylactic GCSF did not increase the overall costs of treatment in children with high risk ALL.

## Study 9

Welte K, Reiter A, Mempel K, Pfetsch M, Schwab G, Schrappe M, Riehm H. A randomized phase-III study of the efficacy of granulocyte colony-stimulating factor in children with high-risk acute lymphoblastic leukemia. Berlin–Frankfurt–Munster Study Group. *Blood* 1996;**87**:3143–50.

### Study design

This was a prospective randomized open label multi-center phase III study that was conducted by the Berlin Frankfurt Munster (BFM) between January 1991 and December 1992. The study had the approval of the local ethics committee and informed consent was obtained for all patients entered on the study. Randomization methodology was not specified in the report. Analysis of all data was based on intention to treat.

### Objectives

The objective of the study was:

- To determine the efficacy of recombinant methionyl human granulocyte colony stimulating factor GCSF (r-GCSF) in ameliorating myelosuppression and improving chemotherapy response rate in children with high risk acute lymphoblastic leukemia (ALL).

### Study details

#### Study population

Of the 87 patients were enrolled on the high risk (HR) arm of ALL-BFM 90 trial, only 34 were randomized for granulocyte colony stimulating factor (GCSF) study. Only patients with a Karnofsky performance score  $\geq 50$  and with no renal, liver or cardiac dysfunction were eligible for inclusion on the study. Patient characteristics are shown in Table 17.26.

Patients were randomized (after completing remission induction therapy) to receive either nine cycles of chemotherapy followed by r-GCSF or 9 cycles of chemotherapy without GCSF (control group).

Eleven ( $n = 22$ ) patients in each group completed nine cycles of chemotherapy while the remaining twelve could not complete the nine cycles of chemotherapy because of disease progression or chemotherapy related toxicity.

**Table 17.26** Patient characteristics.

	GCSF	Control
Number of patients	17	17
Age (year)		
Mean	9.6	8.3
Standard deviation	4.0	4.6
Median	9.2	7.6
Range	2.7–15.9	2.2–16.0
Sex		
Female	3	4
Male	14	13
WBC at diagnosis		
Median	41,000 <sup>a</sup>	87,000 <sup>a</sup>
Range	800–922,000	11,800–270,000
Mean	173,741 <sup>a</sup>	102,624 <sup>a</sup>
Standard deviation	$\pm 247,078$	$\pm 78,832$
Immunophenotype <sup>b</sup>		
T-ALL		
Early T-ALL	2	4
Intermediate T-ALL	4	3
Mature T-ALL	1	2
Common-ALL	8	7
Pre/pre-pre-B-cell-ALL	0	0
Phenotype not determined	2	1
t(9;22)	1	1
Karnofsky performance status		
<60%	0	0
60–70%	3	1
80–100%	14	16

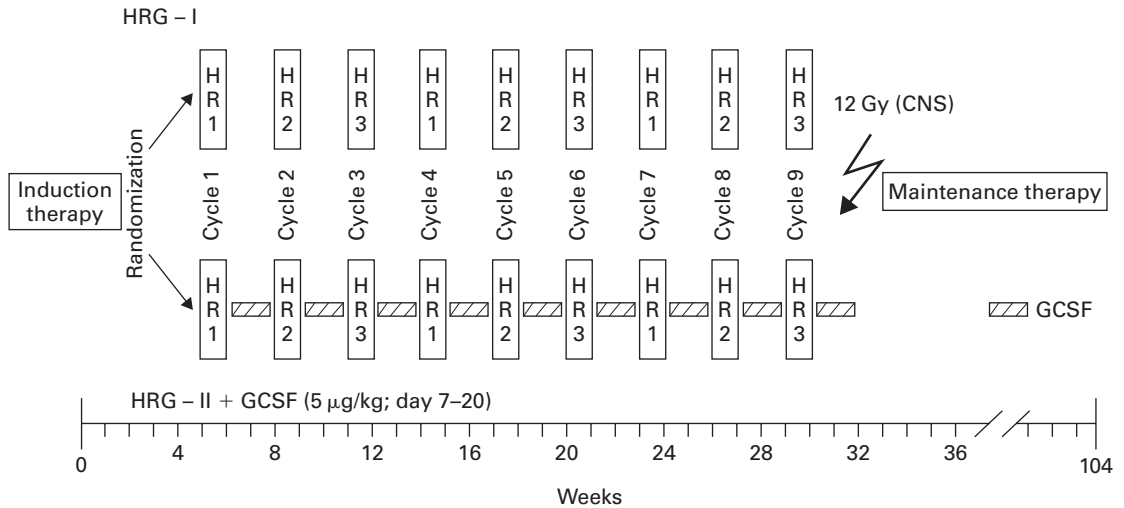
<sup>a</sup>No statistical difference ( $p > 0.5$ ; U-test).

<sup>b</sup>Immunophenotyping was described in detail in Reiter *et al.*<sup>1</sup>

### Treatment program

All high risk patients were treated with nine alternating courses (days 1–6) of according to the ALL-BFM 90 regimen (Figure 17.11) at 3 weekly intervals. Criteria to commence chemotherapy included (1) neutrophil count (ANC)  $\geq 0.2 \times 10^9/l$ , (2) platelet count  $\geq 50 \times 10^9/l$  and (3) oral temperature  $< 38.5^\circ C$  for at least 3 days.

Children randomized to r-GCSF received 5  $\mu g/kg/day$  subcutaneously from day 7 of each cycle and continued till day 20. If ANC on day 20 was  $< 0.2 \times 10^9/l$ , GCSF was continued until this ANC value was reached or for maximum of 28 days; whichever was earlier.



**Figure 17.11** Treatment plan for high risk ALL according to the German ALL-BFM 90 study protocol. Reproduced with permission of the American Society of Hematology (full reference on p. 491).

GCSF was stopped if  $ANC > 30 \times 10^9/l$  was recorded prior to the expected nadir of white blood cell count but this was recommenced when  $ANC < 10 \times 10^9/l$ .

### Supportive care

All patients received oral trimethoprim-sulphamethoxazole and oral nystatin/amphotericin B as prophylaxis against *Pneumocystis carinii* and fungal infections respectively. Blood counts were performed three times a week.

An infectious episode was defined as any infection that was recorded during the treatment period excluding mucositis.

A cultured confirmed infection was defined as an infectious episode with a positive bacterial culture of either blood, urine and wound or throat swabs.

### Outcome end points

The primary end point was the reduction in the incidence of febrile neutropenia with prophylactic GCSF.

Secondary end points included incidence and duration of neutropenia, mucositis, duration of hospitalization, use of intravenous antibiotics, chemotherapy response rate and the overall chemotherapy dose intensity.

### Statistics

The study design estimated that a sample of 31 patients in each group was required for a 90% two tailed power of showing a reduction in the incidence of febrile

neutropenia from 70% to 30%. Tests of significance were two tailed with a significance level of 5%. Summary measures (average incidence, estimate of total duration) were based on 9 cycle means.

The Kaplan–Meier method was used to estimate survival rates.

### Outcome

#### Study population

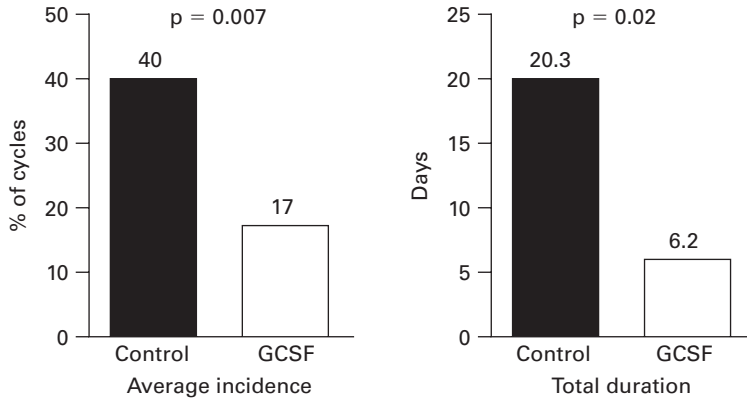
Patients in both groups were evenly matched for sex, age, white blood cell count at diagnosis, Karnofsky performance score and immunophenotype.

#### Febrile neutropenia

The average incidence per cycle of febrile neutropenia was significantly reduced in the r-GCSF group compared to the control group (17% versus 40%;  $p = 0.007$ ) while the median total duration of febrile neutropenia over the entire treatment period was 6.2 days/patient in the GCSF group as against 20.3 days/patient in the control group ( $p = 0.02$ ) (Figure 17.12).

#### Neutropenia

Additionally, the average incidence of neutropenia/cycle and the number of days of neutropenia/patient were also significantly reduced in the r-GCSF group –48% versus 87%; ( $p = 0.002$ ) and 17.4 days versus 61.6 days; ( $p < 0.01$ ) respectively.



**Figure 17.12** Incidence and duration of febrile neutropenic episodes (ANC  $< 0.5 \times 10^9/l$  and oral temperature  $(38.5^\circ\text{C})$ ) during the study period in the control group and r-metHuGCSF group. Reproduced with permission of the American Society of Hematology (full reference on p. 491).

**Table 17.27** Average cycle incidence of infectious episodes and mucositis and total duration of intravenous antibiotic use.

	GCSF	Control	p-value*
Number of cycles	121	137	NA
Average incidence per cycle			
All infections (including FUO)	30%	44%	0.18
Culture confirmed infections	8%	15%	0.04
Mucositis (all grades)	18%	19%	
Severe mucositis (WHO grades 3 and 4)	2%	8%	0.07
Median total duration (days/patient)			
Intravenous antibiotic use ( $>7$ days)	12.5	20.9	0.02
Overall intravenous antibiotic use	18.2	32.2	0.02

\*All p-values were determined by the Median test.

The ANC recovery time ( $>0.5 \times 10^9/l$ ) over all cycles for the r-GCSF group ranged from 1.4–13.7 days compared to 15–23 days in the control group.

### Chemotherapy delays

The average cycle incidence of treatment delays was significantly lower in the r-GCSF group (29% versus 51%;  $p = 0.007$ ). However, the median reduction in total treatment time was only 10 days/patient (median treatment delay per patient was 9.7 days in the r-GCSF group versus 19.7 days in the control group).

### Fever and infections

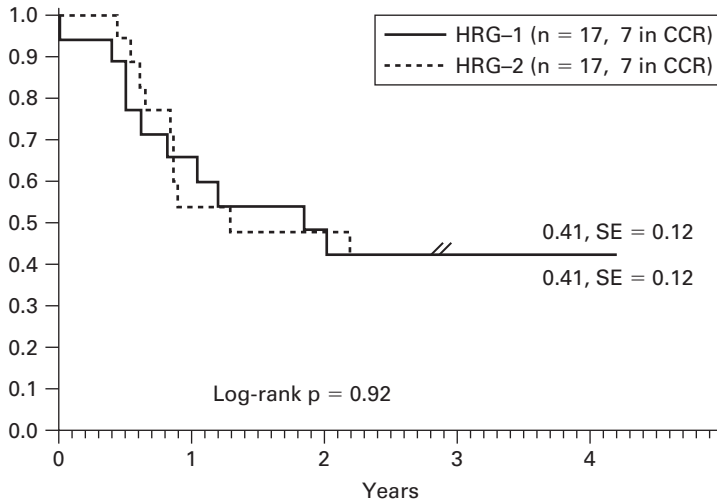
The median total duration of fever ( $>38.5^\circ\text{C}$ ) over all courses was significantly shorter in the r-GCSF group

(7.1 days/patient versus 12.6 days/patient in the control group;  $p = 0.04$ ).

Though the average incidence of infectious episodes was similar in the two groups (30% in the r-GCSF group versus 44% in the control group;  $p = 0.18$ ), the incidence of culture positive infections were significantly reduced in the r-GCSF group (8% versus 15%;  $p = 0.04$ ).

Accordingly, the median total duration of intravenous antibiotic use was only 18.2 days/patient in the r-GCSF group compared to 32.2 days/patient in the control group ( $p = 0.02$ ) (Table 17.27).

Though the average incidence of mucositis was similar in both groups the incidence of severe mucositis



**Figure 17.13** Treatment outcome. Reproduced with permission of the American Society of Hematology (full reference on p. 491).

was non-significantly reduced in the r-GCSF group (Table 17.27).

### Treatment outcome

At a median follow-up of 3.4 years of continuous clinical (range 2.6–4.6 years) remission, 17 patients relapsed (r-GCSF group – 8; control group – 9). The estimated 4-year event-free survival was  $41 \pm 12\%$  in both groups (Figure 17.13).

### Conclusion

It was concluded that the use of prophylactic GCSF significantly reduced the incidence of febrile neutropenia and culture positive infections and thereby improved chemotherapy dose intensity.

## Study 10

Patte C, Laplanche A, Bertozzi AI, Baruchel A, Frappaz D, Schmitt C, Mechinaud F, Nelken B, Boutard P, Michon J. Granulocyte colony-stimulating factor in induction treatment of children with non-Hodgkin's lymphoma: a randomized study of the French Society of Pediatric Oncology. *J Clin Oncol* 2002;**20**:441–8.

### Study design

This was a randomized non-blinded multi-center study conducted during the period from January 1994 to June 1996. The study had local ethical committee approval and informed consent was obtained for all patients entered on the study. All analyses were performed on the basis of an intention to treat. Details of

the randomization methodology were not given in the report.

### Objectives

The main objective of the study was:

- To determine whether prophylactic GCSF after induction chemotherapy, decreased the incidence of febrile neutropenia in children with non-Hodgkin's lymphoma (NHL).

### Study details

#### Patient population

Children with non-Hodgkin's lymphoma (NHL) who were treated on any one of the 3 protocols – LMB 89

**Table 17.28** COPAD(M) description according to protocol (LMB, LMT, HM) and group (A, B, C).

Drug	All Protocols	LMB (B)	LMB(C)	LMB(A)	LMT	HM
Cyclophosphamide IV	Days 2–4					
First course		0.5 g/m <sup>2</sup>	0.5 g/m <sup>2</sup>	0.5 g/m <sup>2</sup>	0.5 g/m <sup>2</sup>	1 g/m <sup>2</sup>
Second course		1 g/m <sup>2</sup>	1 g/m <sup>2</sup>	0.5 g/m <sup>2</sup>	0.5 g/m <sup>2</sup>	1 g/m <sup>2</sup>
Vincristine IV	2 g/m <sup>2</sup>					
First course		Day 1	Day 1	Day 1, day 6	Day 1, day 6	Day 1, day 8
Second course		Day 1, day 6	Day 1, day 6	Day 1, day 6	Day 1, day 6	Day 1, day 8
Prednisone PO or IV	60 mg/m <sup>2</sup> Days 1–6					
Doxorubicin IV	60 mg/m <sup>2</sup> Day 2					
Methotrexate IV	Day 1	3 g/m <sup>2</sup> (3 hours)	8 g/m <sup>2</sup> (4 hours)	–	3 g/m <sup>2</sup> (3 hours)	3 g/m <sup>2</sup> (3 hours)
Intrathecal injections	Dose age dependent	MTX + HC Day 2, day 6	MTX + HC + AraC Day 2, day 4, day 6	–	MTX + HC Day 2, day 6	–

IV: intravenous; PO: orally; MTX: methotrexate; HC: hydrocortisone and AraC: cytarabine.

for B NHL, LMT 89 for lymphoblastic/T cell lymphomas or HM 91 for anaplastic large cell lymphoma were eligible for inclusion on the study. Criteria for exclusion from the study were: (1) children with fever, (2) children who were on absorbable antibiotics for gut decontamination, (3) children already on granulocyte colony stimulating factor (GCSF), (4) children with immunodeficiency disorders including human immunodeficiency virus infection and (5) children with previous documented cancers.

### Treatment program

COPADM courses were similar but not identical in each of the 3 protocols. The treatment schedule is outlined in Table 17.28. Patients treated on the LMB 89 protocol were stratified into three prognostic groups – A, B and C based on the extent of tumor resection and the extent of disease spread. The first COPAD(M) course was preceded the week before by a prephase regimen comprising cyclophosphamide 300 mg/m<sup>2</sup> on day 1, vincristine 1.0 mg/m<sup>2</sup> on day 1 and prednisolone 60 mg/m<sup>2</sup> on days 1–7, except for patients in group A (localized fully resected tumor).

All patients received two courses of COPADM with the second course starting only when the neutrophil count (ANC) was  $\geq 1.5 \times 10^9/l$  and platelet count was  $\geq 100 \times 10^9/l$ . The minimum interval between the two courses was 16 days.

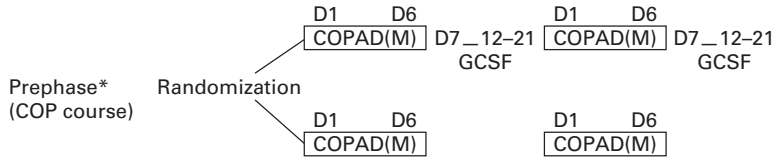
### Randomization and GCSF

Randomization to receive or not to receive GCSF was performed on the first day of the first COPAD(M) course. GCSF (5  $\mu$ g/kg/day subcutaneously) was commenced on day 7 of the first COPAD(M) and continued for a minimum of 6 days or a maximum of 15 days depending on the ANC. GCSF was stopped if the ANC was  $\geq 0.5 \times 10^9/l$  for 2 consecutive days or the total white blood cell count was  $\geq 20 \times 10^9/l$ . The second COPAD (M) commenced 48 hours after last dose of GCSF (Figure 17.14).

### Supportive care

Fever was defined as a central (or axillary) temperature  $\geq 38.5^\circ\text{C}$  ( $38^\circ\text{C}$ ) once or more than  $38^\circ\text{C}$  ( $37.5^\circ\text{C}$ ) on three occasions within a 24 hours.

Neutropenia was defined as ANC  $< 0.5 \times 10^9/l$ .



**Figure 17.14** Treatment schedule. D: day; G-CSE, 5 µg/kg/day subcutaneously over a minimum of 6 days and a maximum of 15 days, to be stopped when an ANC  $\geq$  500/ $\mu$ l was reached. \*Not done in LMB 89 group A. © American Society of Clinical Oncology (full reference on p. 493).

Children with febrile neutropenia were hospitalized and commenced on broad-spectrum antibiotics (amikacin, vancomycin and ticarcillin) after obtaining appropriate blood and body fluid cultures. If fever persisted for more than 4–7 days, depending on the center, amphotericin B was commenced empirically.

### Outcome end points

The primary end point was the incidence of febrile neutropenia.

Secondary end points included (1) incidence of severe infections (2) duration of neutropenia, hospitalization, fever and antibiotic usage, (3) incidence of grade 3 and 4 mucositis and thrombocytopenia, (4) transfusion requirements and (5) overall (OS) and event-free survival (EFS).

### Statistics

It was assumed that without GCSF, 90% of patients would develop febrile neutropenia. Based on that assumption, it was estimated that 72 patients per group would be required to demonstrate a reduction of in the incidence of febrile neutropenia from 90% to 70% ( $\alpha = 5\%$ , power = 20%, bilateral test). All results were expressed as percentages, means and the SD or medians (range). The OS and EFS were estimated by the Kaplan–Meier method and survival curves were compared using the log rank test. All tests were 2 sided.

### Outcome

Of the 149 eligible patients entered on the study, only 1 patient was excluded (major protocol violation); 75 patients were randomly assigned to receive GCSF while 73 formed the control group. Patient characteristics are shown in Table 17.29.

### GCSF and neutropenia

Though the incidence of neutropenia was not significantly different between the two groups of patients, the duration of neutropenia was significantly shorter in the GCSF group (Table 17.30).

**Table 17.29** Patient characteristics.

	GCSF (n = 75)	Control (n = 73)
Male		
No.	54	60
%	72	82
Age, years		
Mean	8	9
SD	4	4
Primary site		
Thorax	9	9
Abdomen	35	43
Head and neck	16	11
Node	6	3
L3-ALL	5	4
Other	4	3
Stage		
I	2	2
II	16	15
III	37	42
IV + ALL	20	14
Bone marrow involvement	19	11
Percent blasts in bone marrow		
Median	26	60
Range	1–99	3–99
Protocol		
LMB	61	61
Group A	5	6
Group B	45	47
Group C	11	8
LMT	8	8
HM	6	4

### Febrile neutropenia, hospitalization and supportive care

The incidence of febrile neutropenia did not differ significantly between the two groups (89% GCSF group

**Table 17.30** Clinical end points in the 148 study patients for each COPAD(M) course.

	First Course		Second Course	
	GCSF (n = 75)	Control (n = 73)	GCSF (n = 75)	Control (n = 72)
Hematologic effects				
Neutropenia <500 ANC				
%	91	99	92	99
Median number of days	3	6 <sup>a</sup>	4	7 <sup>a</sup>
Thrombocytopenia <50,000				
%	23	21	52	38
Median number of days	0	0	1	0
Clinical effects				
Febrile neutropenia				
%	89	93	88	88
Median number of days	3	4 <sup>a</sup>	4	5
Hospitalization				
Median number of days	15	16	15	16
Intravenous antibiotics				
%	89	86	87	93
Median number of days	6	7	7	8 <sup>b</sup>
Intravenous anti-fungal, %	16	33 <sup>b</sup>	24	29
Grade 3–4 infection, %	9	14	14	10
Grade 3–4 mucositis, %	53	53	63	56
Platelet transfusions, %	16	14	35	24
RBC transfusions, %	59	63	75	67

<sup>a</sup>p < 0.001.<sup>b</sup>p < 0.05.

versus 93% control group after COPAD(M) 1) and 88% in both groups after COPAD(M) 2.

Similarly, there were no significant differences in the duration of hospitalization or in the duration of intravenous antibiotic usage between the two groups of patients. The incidence of severe infections were also not different in the two groups (Table 17.31).

The use of systemic antifungal treatment was lower in the GCSF group after COPAD(M) 1 (p = 0.02) but no different after COPAD(M) 2.

### Chemotherapy delay

The median delay between the first and second courses of COPAD(M) was 19 days (range 14–31 days) in the GCSF group versus 20 days (range 14–42 days) in the control group (p = 0.01) and the median delay between the second COPAD(M) subsequent course was 21 days (range 17–60 days GCSF group) versus 22 days (range 16–40 days) respectively (p = not significant).

### Survival outcome

OS and EFS were similar in both groups of patients (Figure 17.15).

### Major protocol violations

There were five major violations – GCSF was administered only for a day in one patient in the GCSF group and four patients in the control group received GCSF because of serious infections or chemotherapy related bone marrow aplasia.

### Conclusion

It was concluded that prophylactic GCSF did not reduce the incidence of febrile neutropenia, increase chemotherapy dose intensity or decrease the treatment related morbidity in children with NHL.

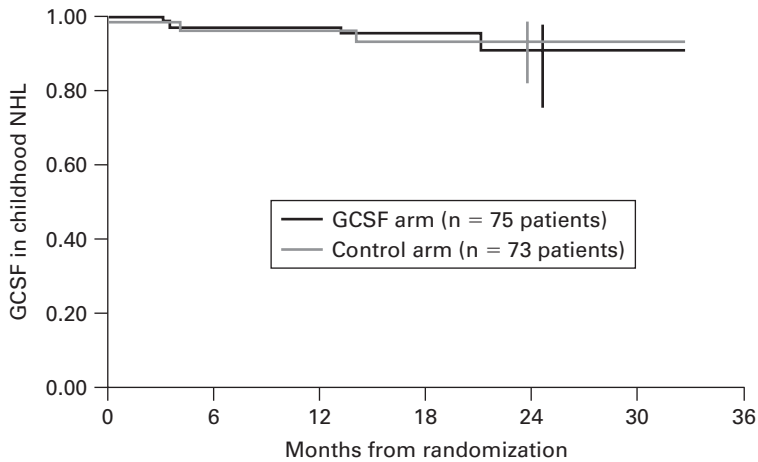


**Table 17.31** Fever and infections in the 148 study patients for each COPAD(M) course.

	First Course				Second Course			
	GCSF (n = 75)		Control (n = 73)		GCSF (n = 75)		Control (n = 72)	
	Number of Patients	%	Number of Patients	%	Number of Patients	%	Number of Patients	%
No fever	7	10	9	12	11	15	7	10
Fever of undetermined origin	52	69	45	63	49	65	50	69
<i>S epidermidis</i> bacteremia	1	1	4	5	1	1	3	4
Minor infections <sup>a</sup>	8	10	4	6	4	5	5	7
Major infections	7	10	10	14	10	14	7	10
Sepsis	4		5		2		3	
Urinary infection	–		1		3		1	
Pneumonia	1		–		1		1	
Enterocolitis	–		2		1		1	
Cutaneous infection	1		1		1		–	
Other <sup>b</sup>	1		–		1		–	
Non-bacteriologically documented sepsis	–		1		1		1	

<sup>a</sup>Majority of upper respiratory tract infections or localized cutaneous infections.

<sup>b</sup>Salmonellosis, appendicitis.

**Figure 17.15** EFS curves according to treatment arm. © American Society of Clinical Oncology (full reference on p. 493).

## Study 11

Dibenedetto SP, Ragusa R, Ippolito AM, Lo Nigro L, Di Cataldo A, D'Amico S, Miraglia V. Assessment of the value of treatment with granulocyte colony-stimulating factor in children with acute lymphoblastic leukemia: a randomized clinical trial. *Eur J Haematol* 1995; 55:93–6.

### Study design

This was a prospective randomized single center study that was conducted between March 1991 and November 1993. Randomization methodology was not specified in the report. Informed parental consent for enrolled patients was obtained according to the local institutional guidelines.

### Objectives

The primary aim of this study was:

- To determine the efficacy of the use of prophylactic granulocyte colony stimulating factor (GCSF) in ameliorating chemotherapy induced myelosuppression in children with intermediate risk acute lymphoblastic leukemia (ALL).

### Study details

#### Study population

All children between the ages of 6 months and 14 years of age with non-B ALL enrolled in the Associazione Italiana di Ematologia Oncologia Paediatrica (AIEOP) protocols for ALL were eligible for inclusion in the study. Patients were categorized into high risk (HR), intermediate risk (IR) or standard risk (SR) according to the Berlin Frankfurt Munster risk criteria classification. Only patients with IR ALL were randomized to receive or not prophylactic granulocyte colony stimulating factor (GCSF).

#### Chemotherapy treatment

The chemotherapy treatment schema is shown in Table 17.32. Following induction of remission chemotherapy, SR patients received oral 6 mercaptopurine (25 mg/m<sup>2</sup>/day) and two doses of intravenous high dose methotrexate (2 g/m<sup>2</sup>) while HR patients received nine cycles of chemotherapy as consolidation therapy.

IR patients, who achieved complete clinical remission after induction of remission therapy, proceeded to phase 2 of the treatment schedule. During this phase of treatment, IR patients were randomized to receive or not prophylactic GCSF. The phase 2 block was count dependent and chemotherapy was withheld or delayed if either the neutrophil count (ANC) and or the platelet count were  $<0.2 \times 10^9/l$  and  $50 \times 10^9/l$  respectively.

GCSF commenced (10 µg/kg/day subcutaneously) 24 hours after completion of the cytarabine cycle and continued till the ANC and platelet counts were  $0.2 \times 10^9/l$  and  $50 \times 10^9/l$  respectively.

### Supportive care

Fever was defined as a continuous body temperature of 38°C for 2 hours that was unrelated to blood product transfusions.

All patients received oral trimethoprim–sulfamethoxazole as prophylaxis against *Pneumocystis carinii* infection. Children with febrile neutropenia were hospitalized and commenced on broad-spectrum antibiotics (tobramycin and ceftazidime) after obtaining appropriate blood and body fluid cultures.

Packed red cell and platelet transfusions were given to patients if the hemoglobin and platelet counts were  $<8g\%$  and  $<10 \times 10^9/l$  respectively.

### Outcome end points

The primary end point was to determine the efficacy of GCSF in shortening duration of the phase 2 cycle of therapy.

Secondary end points included duration and severity of neutropenia, incidence of fever, duration of hospitalization, antibiotic usage and the number of red cell and platelet transfusions.

### Statistics

Student's t-test was used to compare the differences between the two treatment groups.

### Outcome

Of the 60 eligible patients registered on the study, 15 patients were excluded as their entire treatment was not at the study center; 35 were categorized as IR ALL of whom only 32, achieved CR and were eligible for the second phase of the induction therapy; 14 were randomized to receive GCSF (Group A) while the remaining 18 comprised the control group (Group B). Patient characteristics of the IR group are shown in Table 17.33.

**Table 17.32** AIEOP 9102 protocol for children with intermediate risk ALL (induction therapy).

Drug	Dose	Given on Days
<i>Phase 1</i>		
Prednisone (oral)	60 mg/m <sup>2</sup>	0–28, dose progressively reduced from 29 to 36
Vincristine (IV)	1.5 mg/m <sup>2</sup>	7, 14, 21, 28
L-asparaginase (IM)	10,000 IU/m <sup>2</sup>	18, 21, 24, 27, 30, 33, 36, 39
Daunorubicin (IV)	30 mg/m <sup>2</sup>	7, 14, 21, 28
Intrathecal therapy	according to age	0, 14, 30
<i>Phase 2</i>		
Cyclophosphamide (IV)	1 g/m <sup>2</sup>	42, 70
Cytarabine (V)	75 mg/m <sup>2</sup>	44–47, 51–54, 58–61, 65–68
6-Mercaptopurine (oral)	60 mg/m <sup>2</sup>	35–49
Intrathecal therapy	according to age	44, 58
	<i>Prednisone</i>	
	4 mg (<1 year)	
	6 mg (≥1 year to <2 years)	
	8 mg (≥2 year to <3 years)	
	10 mg (≥3 years)	
	<i>Methotrexate</i>	
	6 mg (<1 year)	
	8 mg (≥1 year to <2 years)	
	10 mg (≥2 year to <3 years)	
	12 mg (≥3 years)	
	<i>Cytarabine</i>	
	16 mg (<1 year)	
	20 mg (≥1 year to <2 years)	
	26 mg (≥2 year to <3 years)	
	30 mg (≥3 years)	

### Duration of phase 2 of induction therapy

The anticipated duration of this phase of treatment was 29 days. Only 1 patient in the GCSF group and 2 in the control group completed this phase within this planned time. The median length of phase 2 in group A patients (GCSF group) was 37 days (range 29–65 days; mean 40; SD 8.6) compared to 36 days for the control group of patients (range 29–55, mean 38; SD 7.4,  $p = \text{NS}$ ).

### Febrile episodes and duration of hospitalization

Six febrile episodes were observed in each of the two groups of patients. The duration of hospitalization was also similar for the two groups:  $5.8 \pm 4$  days for the GCSF group versus  $6.2 \pm 5$  days for the control group ( $p = \text{NS}$ ).

### Blood product support

There were no differences between the two groups of patients with regard to either to the number of packed red cell transfusions or to the number of platelet transfusions during this second phase of induction therapy.

### Toxicity

GCSF was well tolerated with almost complete absence of any significant adverse effects.

### Conclusion

It was concluded that GCSF was not beneficial in children with ALL when the duration of neutropenia was short and the risk of infection small.

**Table 17.33** Patient characteristics.

	Group A	Group B	p
Patients	14	18	NS
WBC count at diagnosis			
$\leq 10 \times 10^9$	5	7	NS
$> 10 \times 10^9 < 50 \times 10^9$	7	9	NS
$\geq 50 \times 10^9$	2	2	NS
Immunophenotype at diagnosis			
T-lineage	2	3	NS
Early pre-B	0	1	NS
Pre-B	3	3	NS
Common	11	11	NS
Males/females	8/6	11/7	NS
Days needed for completing the second phase of chemotherapy (mean $\pm$ SD)	37.0 $\pm$ 8.6	36.0 $\pm$ 7.4	NS
Febrile episodes (total)	6	6	NS
Days of hospitalization (mean $\pm$ SD)	5.8 $\pm$ 4	6.2 $\pm$ 5	NS
Documented bacterial infections (total)	2	2	NS
Documented fungal infections (total)	0	0	NS
Transfusion of packed erythrocytes (mean units)	1.8	0.8	NS
Transfusion of platelets (mean units)	0.8	0.7	NS

NS, not significant.

## Study 12

Gonzalez-Vicent M, Madero L, Sevilla J, Ramirez M, Diaz MA. A prospective randomized study of clinical and economic consequences of using G-CSF following autologous peripheral blood progenitor cell (PBPC) transplantation in children. *Bone Marrow Transplant* 2004;34:1077–81.

### Study design

This prospective randomized single center study was conducted between January 1999 and December 2003, and included all children who underwent autologous peripheral blood stem cell transplantation (PBSCT) for hematological and solid tumor malignancies. Details of the randomization methodology were not specified in the report. Informed written consent was

obtained for all patients according to the local institutional guidelines.

### Objectives

The main aim of the study was:

- To determine the clinical and economic benefits of using granulocyte colony stimulating factor (GCSF) in children following autologous PBSCT.

### Study details

#### Study population

Patient characteristics are shown in Table 17.34. There were no statistically significant differences in the demographic characteristics between the two groups of patients.

**Table 17.34** Patients and transplant characteristics.

	GCSF Group (n = 51)	Number GCSF (n = 66)	p Value
Age (years) median (range)	8 (1–18)	8 (1–18)	0.83
<i>Gender</i>			
Male	32	45	0.67
Female	19	21	
<i>Diagnosis</i>			
Acute leukemia	14	14	0.51
Lymphoma	9	5	
Solid tumor	28	47	
<i>Status at transplantation</i>			
1 CR	19	30	0.22
2 CR	8	8	
>2nd CR	24	28	
<i>Conditioning</i>			
TBI based	2	6	0.64
Busulfan based	31	40	
Others	18	20	
<i>CD34+ cells infused</i>			
Median (range)	4.1 (2.01–50)	4.9 (2.4–48.2)	0.98
$\geq 5 \times 10^6/\text{kg}$	20	32	0.27
$< 5 \times 10^6/\text{kg}$	31	34	

In general, the conditioning regimen for patients with solid tumors consisted of oral busulphan (4 mg/kg/day  $\times$  4 days) and intravenous melphalan (140 mg/m<sup>2</sup>/day  $\times$  1 day) while for patients with acute lymphoblastic leukemia (ALL) and acute myeloid leukemia (AML); it comprised total body irradiation (TBI) (4 Gy/day  $\times$  3 days) plus intravenous cyclophosphamide (60 mg/kg/day  $\times$  2 days) and oral busulphan (4 mg/kg/day  $\times$  4 days) and intravenous cyclophosphamide (60 mg/kg/day  $\times$  2 days) respectively.

Peripheral blood stem cells were mobilized with granulocyte colony stimulating factor (GCSF) support at a dose of 12  $\mu\text{g}/\text{kg}/\text{twice}$  daily subcutaneously for 4 consecutive days prior to apheresis. All patients were grafted with a minimum of  $2 \times 10^6/\text{kg}$  of CD34+ cells.

### Randomization

Randomization was carried out centrally and patients were randomly assigned into one of two groups; the treatment group who received GCSF (10  $\mu\text{g}/\text{kg}/\text{day}$ ) or the control group that did not receive any GCSF post-stem cell infusion.

### Supportive Care

All patients were cared for in high efficiency particulate air (HEPA) filtered single rooms with reverse barrier nursing. Co-trimoxazole was administered to all patients at a dose of 8 mg/kg/day as prophylaxis against *Pneumocystis Carinii* infection. Patients with febrile neutropenia received broad-spectrum antibiotic treatment. Amphotericin B was used for persistent fever unresponsive to antibiotic treatment after 3–5 days.

### Definitions

Neutrophil engraftment was defined as the first of 3 consecutive days when the absolute neutrophil count (ANC) was  $>0.5 \times 10^9/\text{l}$ .

Early platelet engraftment was defined as the time to achieve an unsupported platelet count  $>20 \times 10^9/\text{l}$  for 3 consecutive days.

Long-term platelet engraftment was defined as the time to achieve an unsupported platelet count  $>50 \times 10^9/\text{l}$  for 3 consecutive days

Duration of hospitalization was defined as the number of days from stem cell infusion to discharge from hospital.

**Table 17.35** Kinetics engraftment according to the number of CD34+ cells infused.

	<5 × 10 <sup>6</sup> /kg CD34+		p Value	≥5 × 10 <sup>6</sup> /kg CD34+		p Value
	G-CSF (n = 31)	No G-CSF (n = 34)		G-CSF (n = 20)	No G-CSF (n = 32)	
>0.5 × 10 <sup>9</sup> /l neutrophils	10 (8–14)	11 (9–21)	0.04	10 (7–11)	11 (8–16)	0.03
>20 × 10 <sup>9</sup> /l platelets	12 (8–26)	12 (6–41)	0.5	11 (8–60)	12 (8–15)	0.09
>50 × 10 <sup>9</sup> /l platelets	15 (13–60)	15 (12–71)	0.5	15 (9–90)	14 (11–29)	0.01

**Table 17.36** Resource utilization.

	G-CSF Group (n = 51)	No G-CSF Group (n = 66)	p-value
Antibiotics days: median (range)	8 (0–50)	8 (0–36)	0.32
Transfusions units: median (range)			
Red cells	2 (0–19)	2 (0–11)	0.12
Platelets	3 (0–39)	2 (0–12)	0.03
Parenteral nutrition days: median (range)	30 (19–65)	11 (0–20)	0.11
Inotropic drugs days: median (range)	9 (2–21)	1 (0–6)	0.03
Morphine days: median (range)	6 (0–20)	4 (0–6)	0.73
Stay days: median (range)	16 (10–72)	17 (6–60)	0.46
Costs (euros): median (range)	8146.82 (2595.21–52,089.67)	7873.34 (2877.53–17,893.43)	0.1

### Cost analysis

Cost analysis was performed according to a previously determined model obtained by multiple linear regression. The model obtained was:

Total costs in Euro (€) = 3046 + 5543 × TBI + 324 × ICU stay days + 288 × number of platelet transfusions + 228 × hospitalization days – 99 × number of CD34+ cells/kg infused.

### Outcome end points

The main end points were engraftment kinetics (i.e. time for neutrophil and platelet engraftment), supportive care and treatment costs.

### Statistics

Kaplan–Meier estimates were used for calculation of engraftment kinetics. Other statistical tests used included Student's test with two-sided p-values, non-parametric Mann–Whitney U-test and  $\chi^2$  continuity correction. Results were considered significant if the p-value was <0.05.

### Outcome

Of the 117 patients included in the study, 51 were randomized to receive G-CSF and the remaining 66 were the control group.

Administration of G-CSF significantly improved neutrophil recovery. The median time to achieve ANC >0.5 × 10<sup>9</sup>/l was 10 days (range 7–14 days) in the G-CSF group compared to 11 days (range 8–21 days) in the control group (p < 0.009).

ANC engraftment was quicker in the G-CSF group irrespective of the number of CD34+ cells infused in the graft (Table 17.35).

Though early platelet engraftment was similar in both groups of patients (12 days), in patients who received >5 × 10<sup>6</sup>/l of CD34+ cells, the use of G-CSF was associated with a delayed late platelet engraftment. However, early- and long-term platelet engraftment in patients who received <5 × 10<sup>6</sup>/kg CD34+ cells, were similar with or without G-CSF (Table 17.35).

Platelet transfusions were significantly lower in the control group compared to the G-CSF group (Table 17.36). No significant differences were seen with respect

to red cell transfusions, antibiotic usage, total parenteral nutrition or duration of hospitalization between the two groups of patients.

Though the total costs were similar in both groups of patients, there was a trend towards higher costs in the GCSF group (€8146.82 versus €7873.34;  $p = 0.1$ ) (Table 17.36).

## Conclusion

It was concluded that GCSF was of limited benefit in children after autologous PBSCT, and it adversely affected platelet recovery in patients who received a larger volume of CD34+ cells.

## Study 13

Yoshifumi Kawano, Yoichi Takaue, Junichi Mimaya, Yasuo Horikoshi, Tsutomu Watanabe, Takanori Abe, Yukitoshi Shimizu, Takeji Matsushita, Atsushi Kikuta, Arata Watanabe, Asayuki Iwai, Etsuro Ito, Mikiya Endo, Nobuyuki Kodani, Shigeru Ohta, Kazuo Gushi, Hiroshi Azuma, Takao Etoh, Yasuhiro Okamoto, Koji Amano, Hiroyoshi Hattori, Haruhiko Eguchi, Yasuhiro Kuroda. Marginal benefit/disadvantage of granulocyte colony-stimulating factor therapy after autologous blood stem cell transplantation in children: results of a prospective randomized trial. *Blood* 1998;**92**:4040–6.

### Study design

This single center prospective randomized study was conducted between December 1993 and December 1996. Randomization methodology was not specified in the report. Informed written consent was obtained from the patients' parents/guardians according to the local institutional guidelines.

### Objectives

The primary aim of the study was:

- To determine whether the use of granulocyte colony stimulating factor (GCSF) after peripheral stem cell transplantation (PBSCT) improved engraftment.

### Study details

#### Study population

The study population comprised mainly children with acute lymphoblastic leukemia (ALL) in complete remission (CR) or neuroblastoma (Table 17.37).

Patients with ALL had 7 months of conventional chemotherapy prior to peripheral stem cell transplantation (PBSCT). Central nervous system prophylaxis for children with ALL consisted of five courses of triple intrathecal chemotherapy given after induction therapy and immediately prior to PBSCT. Patients with neuroblastoma and other solid tumors were treated according to the chemotherapy protocols of the Japanese Cooperative Study Group and most of the regimens included cyclophosphamide, cisplatin or carboplatin, vincristine, etoposide, pirarubicin and dacarbazine. Local therapy consisted of either delayed primary surgery or second look surgery with or without intraoperative radiotherapy (10–20 Gy). Patients underwent PBSCT only if the PBSC harvest contained  $>1 \times 10^5$  colony forming granulocyte macrophage units (CFU-GM)/kg patient's weight and  $1 \times 10^6$  CD34+ cells/kg patient's weight.

### Randomization

All patients were randomized at diagnosis to either receive granulocyte colony stimulating factor (GCSF) (treatment group;  $n = 38$ ) or not (control group,  $n = 36$ ). GCSF commenced a day after PBSCT at a dose of 300 µg/kg/day, given as a short intravenous infusion.

### Cyto-reductive high dose regimens

The ALL preparatory conditioning regimen consisted of ranimustine (MCNU) 450 mg/m<sup>2</sup>, cytarabine (ARA-C) 16 g/m<sup>2</sup>, etoposide (1600 mg/m<sup>2</sup>) and cyclophosphamide 100 mg/kg while patients with solid tumors including neuroblastomas, received a combination of melphalan (180 mg/m<sup>2</sup>), etoposide (1.6 g/m<sup>2</sup>) and carboplatin (1.6 g/m<sup>2</sup>). Stem cells were re-infused 36 hours after completion of high dose therapy.

## Supportive care

All patients who developed febrile neutropenia were treated with broad-spectrum antibiotics according to their local institutional protocols. Irradiated packed red cell and platelet transfusions were given as required so as to maintain the hemoglobin and platelets above 7 g% and  $20 \times 10^9/l$  respectively. Hemopoietic recovery was defined as the first day when the neutrophil (ANC) was  $>0.5 \times 10^9/l$  and an unsupported platelet count  $>20 \times 10^9/l$  for 3 consecutive days.

## Outcome end points

The primary end point was the speed of ANC engraftment.

**Table 17.37** Diagnosis and characteristics of registered patients.

	Treated Group	Control
Diagnosis		
ALL	13	15
NHL	3	1
Neuroblastoma	12	8
Brain tumors	2	2
Wilms' tumor	0	1
Yolk sac tumor	0	1
Age		
Median	6.4	6.8
Range	2–17	1–16
Sex		
Male	15	17
Female	15	11

NHL: non-Hodgkin's lymphoma.

## Statistics

All analyses were performed on an intention to treat basis. The Mann Whitney U-test and Student's t-test were used to analyse the effect of GCSF administration. Kaplan–Meier estimates of ANC and platelet recovery were also analyzed by the log rank test.

## Outcome

Of the 74 children enrolled on the trial, 6 were excluded (3 in each group) because of disease progression prior to PBSCT. An additional 10 patients were excluded because of either a poor harvest of stem cells ( $n = 5$ ) or major protocol violations ( $n = 5$ ). Figure 17.16 shows the randomization schema. Both patient groups were comparable with respect to their clinical characteristics and transfused stem cells (Table 17.38).

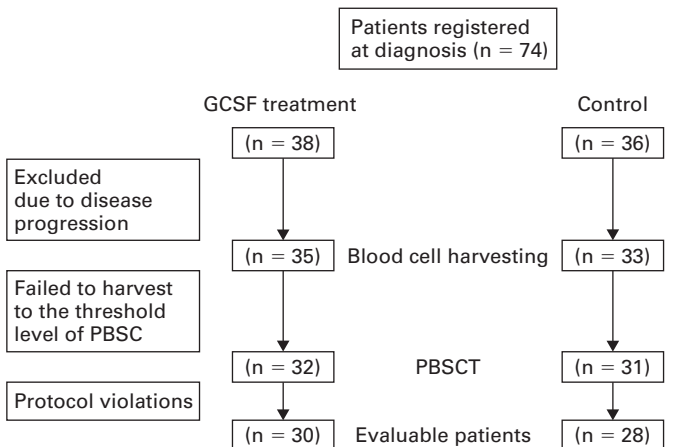
**Table 17.38** Infused number of cells.

	MNC ( $\times 10^8/kg$ )	CD34 + ( $\times 10^6/kg$ )	CFU-GM ( $\times 10^5/kg$ )
Treated group			
GCSF(+) $n = 30$	4.6 (1–19)	8.5 (1.8–64)	4.8 (1.2–23)
Control			
GCSF(-) $n = 28$	3.8 (1.1–21)	6.3 (1.1–34)	5.5 (1.3–37)
p-value			
t-test	0.706	0.571	0.311
U-test	0.643	0.423	0.247

Figures represent median value/(range).

t-test: Student's t-test; U-test: Mann–Whitney U-test;

MNC: mononuclear cells.



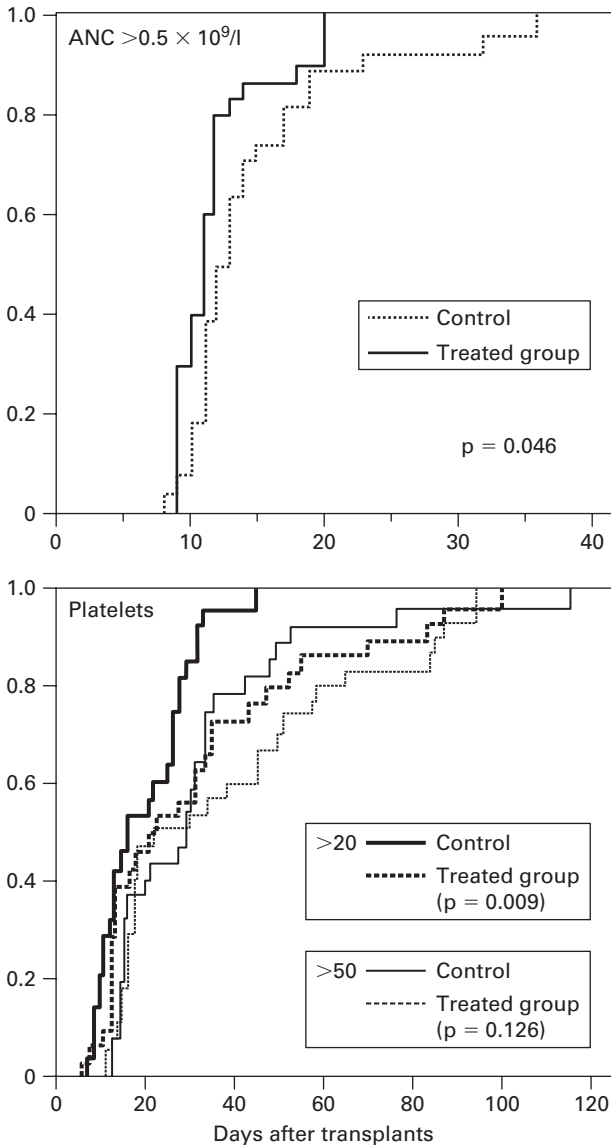
**Figure 17.16** Schema of patient registration. Reproduced with permission of the American Society of Hematology (full reference on p. 504).



**Table 17.39** Hematopoietic recovery data.

	ANC ( $>0.5 \times 10^9/l$ )	WBC ( $>1.0 \times 10^9/l$ )	Platelets		Last Day of Transfusions		Febrile Days ( $>38^\circ\text{C}$ )
			( $>20 \times 10^9/l$ )	( $>50 \times 10^9/l$ )	RBC	Platelets	
Treated group							
GCSF(+) n = 30	11 (8–20)	11 (8–20)	22 (7–101)	31 (13–123)	11 (0–81)	27 (6–91)	4 (0–15)
Control							
GCSF(–) n = 28	12 (9–49)	11 (9–29)	16 (6–45)	26 (11–100)	10 (2–69)	13 (5–82)	4 (0–11)
p-value							
t-test	0.034	0.180	0.020	0.265	0.231	0.037	0.577
U-test	0.021	0.199	0.086	0.455	0.68	0.077	0.716

Figures represent median value/(range).



**Figure 17.17** Kaplan–Meier probability of achieving  $0.5 \times 10^9/l$  of ANC (top graph,  $p = 0.046$ ), and those of  $20$  or  $50 \times 10^9/l$  of platelet counts independent of platelet transfusions (bottom graph,  $p = 0.009$  for  $20 \times 10^9/l$  or  $p = 0.126$  for  $50 \times 10^9/l$ ). Reproduced with permission of the American Society of Hematology (full reference on p. 504).

**Table 17.40** Infused number of cells and hematopoietic recovery data.

	MNC ( $\times 10^8/\text{kg}$ )	CFU-GM ( $\times 10^5/\text{kg}$ )	CD34 ( $\times 10^6/\text{kg}$ )	WBC ( $>1.0 \times 10^9/\text{l}$ )	ANC ( $>0.5 \times 10^9/\text{l}$ )	Platelets		Last Day of Transfusion		Febrile Days ( $>38^\circ\text{C}$ )
						( $>20 \times 10^9/\text{l}$ )	( $>50 \times 10^9/\text{l}$ )	RBC	Platelets	
ALL										
GCSF(+)	5.1	5.0	15	11	12	13	16	10	13	3
n = 13	(1.3–11)	(1.5–23)	(2.4–23)	(8–20)	(9–20)	(12–88)	(13–92)	(0–81)	(6–85)	(0–14)
GCSF(–)	3.3	6.9	6.3	12	12	12	16	8	12	4
n = 15	(1.1–11)	(2.2–37)	(1.1–29)	(9–25)	(9–49)	(8–45)	(11–100)	(4–41)	(5–40)	(0–10)
p-value	0.130	0.399	0.265	0.695	0.565	0.107	0.765	0.908	0.461	0.908
Solid tumors										
GCSF(+)	4.5	2.3	7.8	10	11	32	35	28	28	4
n = 15	(1.0–19)	(1.2–14)	(1.3–64)	(8–20)	(8–20)	(7–101)	(12–123)	(0–72)	(6–91)	(0–15)
GCSF(–)	6.0	3.9	3.8	11	12	16	31	11	13	4
n = 13	(2.0–21)	(1.3–14)	(1.8–34)	(9–20)	(9–36)	(6–33)	(13–81)	(2–69)	(11–82)	(0–11)
p-value	0.403	0.330	0.559	0.233	0.045	0.188	0.630	0.691	0.143	0.779

Figures represent median values/(ranges). Statistical significance was tested by the Mann–Whitney U-test.

The median time for ANC engraftment ( $>0.5 \times 10^9/l$ ) was 11 days in the treatment group (range 8–20 days) versus 12 days (range 9–49 days) in the control group ( $p = 0.03$ , t-test and  $p = 0.04$ , log rank test). However, the median time for platelet engraftment in the treatment and control groups were ( $>20 \times 10^9/l$ ) was 22 days (range 7–101 days) and 16 days respectively ( $p = 0.02$ , t-test and  $p = 0.009$ , log rank test). Table 17.39 and Figure 17.17 show the speed of hemopoietic recovery in the two groups of patients.

In the ALL group, ANC engraftment was identical in both the GCSF and non-GCSF groups, though in solid tumor patients ANC engraftment was significantly

earlier in the GCSF group (11 versus 12 days;  $p = 0.045$ ) (Table 17.40).

There was no difference in the number of febrile neutropenic episodes in both the groups (treatment group (4) versus control group (4)) of patients.

### Conclusion

It was concluded that though GCSF marginally improved neutrophil engraftment in solid tumor patients after PBSCT but this benefit, was offset by the delayed platelet recovery.

## Study 14

Ozkaynak MF, Krailo M, Chen Z, Feusner J. Randomized comparison of antibiotics with and without granulocyte colony-stimulating factor in children with chemotherapy-induced febrile neutropenia: a report from the Children's Oncology Group. *Pediatr Blood Cancer* 2005;45:242–3.

### Objectives

The study aimed:

- To determine whether GCSF administered along with empiric antibiotic therapy was beneficial in children and adolescents with febrile neutropenia (FBN).

### Study design

This prospective randomized multi-centre study was conducted between August 1999 and December 2002 and included all children and adolescents below 22 years of age with a diagnosis of cancer except acute myeloid leukemia (AML). Patients were also ineligible for study inclusion if they had myelodysplastic syndrome (MDS), septic shock, prolonged fever of unknown origin, prior treatment with hemopoietic growth factors at study entry, treatment with intravenous (IV) antibiotics 7 days prior to admission, a bone marrow or peripheral blood stem cell transplantation, abnormal serum creatinine values ( $>1.5$  times normal), craniospinal and or pelvic irradiation or solid tumor with bone marrow infiltration.

Eligible patients were randomized to receive or not granulocyte colony stimulating factor (GCSF) within 24 hours of commencing antibiotic therapy. GCSF was administered either subcutaneously (SC) or IV at the discretion of the treating physician. Antibiotic treatment was continued until the patient was afebrile for 2 consecutive days and the absolute neutrophil count (ANC) was  $\geq 500/\mu l$ . GCSF was continued until the ANC was  $\geq 1500/\mu l$  for 2 consecutive days. If the patient was still febrile when the ANC was  $>1500/\mu l$ , the decision to continue GCSF was at the discretion of the treating physician. Patients who were discharged on antibiotic treatment continued to receive SC GCSF until fever and ANC criteria were met. Body temperature was measured orally in this study. After discontinuing antibiotics, patients were monitored for 3 more days for late fever recurrence. If after 3 days of observation without fever (i.e. after stopping antibiotics) and the ANC was  $>500/\mu l$ , the patient was taken off the study. If they became febrile during the observational 3-day period, they were followed until resolution of fever. If patients became afebrile but the ANC decreased  $<500/\mu l$ , they were monitored until it exceeded  $500/\mu l$ .

### Definitions

Fever was defined as (1) single oral temperature  $\geq 38.3^\circ C$  or (2) or an oral temperature of  $38^\circ C$  sustained for at least 1 hour. If oral measurement was not possible, tympanic or axillary temperatures were recorded to confirm fever.

Late fever was defined as an oral temperature  $\geq 38.3^\circ C$  after a period of 2 consecutive days during which the maximum temperature did not exceed  $38^\circ C$ .

Time to resolution of FBN was defined as the interval between date of randomization and point at which the ANC was  $>500/\mu\text{l}$  and temperature  $<38^\circ\text{C}$ . All patients who died or were lost for follow-up prior to recovery of ANC were censored at the date of last contact.

Time to resolution of neutropenia was defined as the interval between date of randomization and point at which the patient's ANC was  $>500/\mu\text{l}$ . Patients were censored at the date of last contact if they died or were lost for follow-up prior to recovery of ANC.

Time to resolution of fever was defined as the interval between date of randomization and point at which the patient's temperature was  $<38^\circ\text{C}$ . Similarly, patients were censored at the date of last contact if they died or were lost for follow-up prior to resolution of their fever.

### Statistics

Distribution of time to recovery from FBN, neutropenia and fever were estimated by the Kaplan–Meier method.<sup>1</sup> Distributions across the groups formed by randomized treatment assignments were compared using the log rank test. Distributions of quantitative variables such as age at entry and duration of anti-microbial therapy were compared across groups defined by randomized regimen using the Wilcoxon signed rank test.<sup>2</sup> Finally distributions of qualitative variables such as gender and race were compared across groups defined by randomized regimen using the exact conditional or chi-squared test for proportions.<sup>2</sup>

It was assumed that if 200 patients were enrolled, the study would have an 80% power (using a one-sided test of size 0.05) if the difference in the average duration of neutropenia was reduced by 35% and the standard deviation in duration was approximately equal to the mean duration. Interim monitoring in the primary end point of the study took place at 6 monthly intervals. The method of Lan and DeMets<sup>3</sup> was used for adjustment of the p-value each time the study was reviewed. Enrollment was terminated earlier than planned on the directives of the Children's Cancer Group Data Monitoring Committee (CCG DMC) because of significant differences between regimens in two of the study endpoints.

### Outcome endpoints

The primary end point was the duration of FBN. Secondary endpoints included number of days of antibiotic treatment, proportion of patients who experienced septic shock, proportion of patients who received

anti-fungal therapy and the proportion of patients with documented infection after start of treatment.

### Results

Of the 67 patients enrolled on the study, 1 patient was deemed ineligible and was excluded from outcome analysis. Of the remaining 66 patients, 32 were randomized to receive GCSF along with antibiotics (G + AB) and 34 to receive antibiotic (AB) treatment alone. 59 of the 66 patients were diagnosed to have childhood lymphoblastic leukemia (ALL). Patient characteristics are shown in Table 17.41. There were no statistically significant differences in either the phase of treatment among patients with ALL who received AB alone or G + AB ( $p = 0.78$ ) or in the median days elapsed from the last day of chemotherapy to study entry when the two randomized regimens were compared (median 5.5 days for the AB group versus 5.0 days for the G + AB group) (Table 17.42).

### Outcome

Addition of GCSF to empirical antibiotic therapy significantly reduced the time to recovery from FBN (Figure 17.18). The median time (in days) to resolution of FBN was 4 days with G + AB arm compared to 13 days in the AB arm alone. This effect was attributable to reduction in time of neutropenia (Figure 17.19) rather than resolution of fever (Figure 17.20).

Time to resolution of FBN was significantly shorter for patients who had an absolute monocyte count (AMC)  $>200/\mu\text{l}$  than those who had an AMC  $<200/\mu\text{l}$  at admission ( $p = 0.009$ ) and this was attributable to more rapid resolution of neutropenia ( $p = 0.001$ ) than any reduction in the time to resolution of fever ( $p = 0.45$ ). The duration of hospitalization was shorter by a day in the G + AB group (4 versus 5 days;  $p = 0.04$ ).

However, there was no difference in the number of days of IV or oral antibiotic treatment (G + AB; median 5.9 days versus AB; median 7.2 days;  $p = 0.19$ ) addition of anti-fungal treatment or in the number of patients who went into septic shock when the two regimens were compared. Table 17.43 shows the incidence of late fever according to the randomized treatment regimen. 5/14 (36%) of patients with an ANC  $<100/\mu\text{l}$  at study entry randomized to no GCSF developed a late fever compared to 0/15 in the GCSF arm (Table 17.44).

**Table 17.41** Characteristics of 66 eligible pediatric patients with chemotherapy induced FBN who received AB alone or AB + GCSE.

	Antibiotics (n = 34)	Antibiotics + GCSF (n = 32)	p Value*
Age			0.62 <sup>a</sup>
Median	5	5.5	
Range	1–17	2–20	
Gender			0.62 <sup>b</sup>
Male	18 (53%)	15 (47%)	
Female	16 (47%)	17 (53%)	
Stratum			
Hematologic, newly diagnosed (never relapsed or progressed), no source of infection on study entry	22 (65%)	21 (66%)	
Hematologic, newly diagnosed (never relapsed or progressed), source of infection present on entry	4 (12%)	4 (13%)	
Hematologic, previously diagnosed (relapsed or progressed), no source of infection on study entry	4 (12%)	3 (9%)	
Hematologic, previously diagnosed (relapsed or progressed), source of infection present on entry	1 (3%)	0 (0%)	
Solid tumor, newly diagnosed (never relapsed or progressed), no source of infection on study entry	3 (9%)	3 (9%)	
Solid tumor, newly diagnosed (never relapsed or progressed), source of infection present on entry	0 (0%)	1 (3%)	
Race			0.11 <sup>c</sup>
White	15 (44%)	23 (72%)	0.027
Hispanic	11 (32%)	4 (12%)	0.078
Asian including Filipino	3 (9%)	1 (3%)	
Other or unknown	5 (15%)	4 (13%)	

\*p-value for the hypothesis of equivalent distribution of the characteristic across randomized regimen.

<sup>a</sup>Wilcoxon signed rank test.

<sup>b</sup>Chi-square test.

<sup>c</sup>Fisher exact test.

**Table 17.42** Comparison of outcome measures for patients according to randomized treatment assignment.

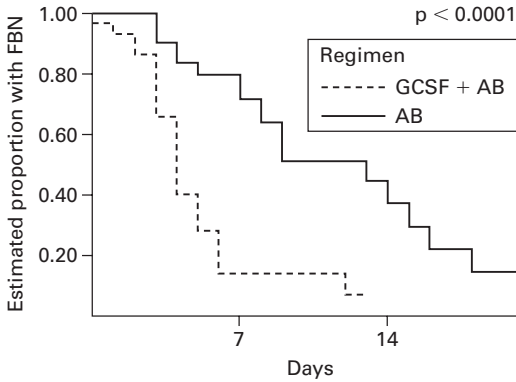
Characteristic	Antibiotics Only	Antibiotics + GCSF	p Value*
Days of hospitalization for fever and neutropenia (median, range)	5 (2–12)	4 (1–7)	0.04 <sup>a</sup>
Number of days of antimicrobial (IV + PO) therapy for febrile neutropenia (median, range)	6 (2–21)	6 (2–28)	0.31 <sup>a</sup>
Proportion of patients who experienced shock during therapy	3%	0%	1.0 <sup>b</sup>
Proportion of patients to whom antifungal therapy was administered	35%	29%	0.68 <sup>c</sup>
Proportion of patients with infection diagnosed after the start of therapy	21%	16%	0.61 <sup>c</sup>

\*p-value for the hypothesis of equivalent distribution of the characteristic across randomized regimen.

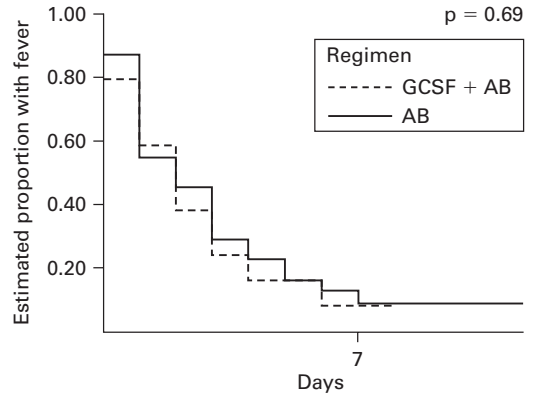
<sup>a</sup>One-sided Wilcoxon signed rank test.

<sup>b</sup>One-sided Fisher exact test.

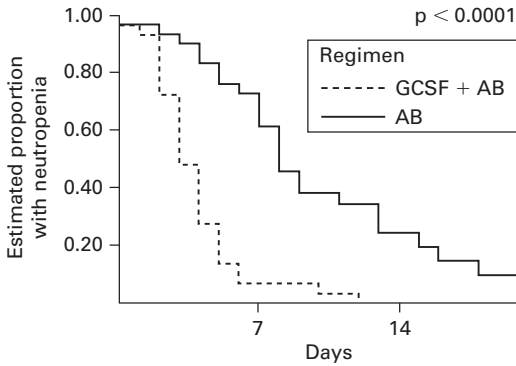
<sup>c</sup>Chi-square test of proportions.



**Figure 17.18** Time to resolution of FBN according to randomized treatment regimen. Reprinted Ozkaynak *et al.* (full reference on p. 508) with permission from Wiley-Liss, Inc., a subsidiary of John Wiley & Sons, Inc.



**Figure 17.20** Time to resolution of fever according to randomized treatment regimen. Reprinted Ozkaynak *et al.* (full reference on p. 508) with permission from Wiley-Liss, Inc., a subsidiary of John Wiley & Sons, Inc.



**Figure 17.19** Time to resolution of neutropenia according to randomized treatment regimen. Reprinted Ozkaynak *et al.* (full reference on p. 508) with permission from Wiley-Liss, Inc., a subsidiary of John Wiley & Sons, Inc.

**Table 17.43** Incidence of late fever among the two treatment arms.

Late Fever	Ab Alone (n = 34)	Ab + GCSF (n = 32)	p Value*
Have late fever	8 (23.5%)	2 (6.3%)	0.08
No late fever	22 (64.7%)	26 (81.3%)	
Unknown	4 (11.8%)	4 (12.5%)	

\* Fisher exact test and patients with unknown information are excluded from the test.

**Table 17.44** Incidence of late fever by randomized treatment assignment and ANC\* at study entry.

Had Late Fever	ANC 100/ $\mu$ l or less		ANC Greater than 100/ $\mu$ l	
	AB Alone	AB + GCSF	AB Alone	AB + GCSF
Yes	5 (36%)	0 (0%)	2 (14%)	2 (17%)
No	9 (64%)	15 (100%)	12 (86%)	10 (83%)

\*Although the initial ANC was confirmed to be less than 500/ $\mu$ l, the exact ANC was not determined for five patients.

### Conclusion

The report concluded that the addition of GCSF to empiric antibiotic treatment resulted in a faster

resolution of FBN especially, in children with ALL and was of some clinical benefit as it reduced the duration of hospitalization.

# Studies - GMCSF

## Study 15

van Pelt LJ, de Craen AJ, Langeveld NE, Weening RS. Granulocyte-macrophage colony-stimulating factor (GM-CSF) ameliorates chemotherapy-induced neutropenia in children with solid tumors. *Pediatr Hematol Oncol* 1997;14:539–45.

### Study design

This single center prospective open label randomized trial for children and adolescents with non-hematological malignancies was conducted between September 1992 and April 1995. A crossover design was used such that patients who received no granulocyte colony stimulating factor (GCSF) (control) following the first course would receive prophylactic GCSF after the second course and vice versa. Informed consent was obtained for all patients included in the trial.

### Objectives

The main aim of the study was:

- To determine whether prophylactic administration of granulocyte macrophage colony stimulating factor (GMCSF) in patients undergoing intensive chemotherapy for solid tumor malignancies reduced the duration of neutropenia.

### Study details

#### Patient population

All children between 1 and 18 years of age with previously untreated solid tumors (osteosarcoma, Ewing's sarcoma and sarcoma of mesenchymal origin) were eligible for inclusion onto the study. Patients were excluded if they had any of the following conditions:

- 1 Uncontrolled infection at study entry.
- 2 Life expectancy of <3 months.
- 3 Impaired cardiac, renal, hepatic or lung function.

- 4 Pregnancy or inability to use oral contraceptives.
- 5 Allergy to granulocyte macrophage colony stimulating factor (GMCSF).
- 6 Previous treatment with GMCSF.
- 7 WHO (World Health Organization) performance status of 4.

### Chemotherapy

Chemotherapy protocols were disease specific and consisted of multi-agent combination regimens which were myelosuppressive but not myeloablative.

### GMCSF

Patients were randomized before each pair of chemotherapy courses to receive GMCSF after the first or second course of chemotherapy. If the treatment protocol comprised alternating courses of combination chemotherapy regimens, patients were randomized to receive or not to receive GMCSF, after the first or second of each pair of identical chemotherapy courses (i.e. after the first and the third courses or after the second and fourth courses). GMCSF  $-5 \mu\text{g}/\text{kg}/\text{day}$  (non-glycosylated recombinant human Escherichia-Coli derived GMCSF administered subcutaneously) commenced 24 hours after the last dose of chemotherapy and was continued for 10 days.

### Supportive care

Full blood counts were performed thrice weekly on all patients included in the study. All children received a cocktail of colistin, co-trimoxazole and nystatin or amphotericin B as bowel decontaminants during neutropenia.

### Outcome end points

The main end points were (1) mean duration of neutropenia, (2) number of documented infections and (3) duration of febrile episodes (temperature  $>38^\circ\text{C}$ ) and number of red cell and platelet transfusions.

**Table 17.45** Characteristics of patients.<sup>a,b</sup>

Age	Gender	Diagnosis	Number of Chemotherapy Courses	Number of GMCSF Courses
12	F	Osteosarcoma	3	1
13	F	Ewing's sarcoma	8	4
12	M	Rhabdomyosarcoma	0	0
12	F	Ewing's sarcoma	6	3
7	F	Ewing's sarcoma	4	2
15	F	Osteosarcoma	1	0
6	M	Rhabdomyosarcoma	5	2
9	M	Osteosarcoma	2	2
9	M	Rhabdomyosarcoma	0	0
2	F	Rhabdomyosarcoma	2	1
5	F	Ewing's sarcoma	2	1
9	F	Ewing's sarcoma	2	1
10	M	Rhabdomyosarcoma	1	1

<sup>a</sup>Two of the 13 patients had to be excluded from the study after randomization; one withdrew consent and one was treated according to an alternative chemotherapy protocol.

<sup>b</sup>Not all of the 36 courses of chemotherapy with or without subsequent GMCSF treatment could be paired. Therefore, eight such courses (four with and four without GMCSF) were not included in the paired comparison.

## Statistics

The paired t-test was used to compare the mean duration of neutropenia/leucopenia and the mean duration of fever while the Fisher's exact test was used to compare the differences in the number of red cell or platelet transfusions and the number of infections between the two groups of patients.

## Outcome

Thirteen patients were included in the study (Table 17.45). As patients were randomized to receive GMCSF after either the first or second of each pair of identical chemotherapy courses (i.e. after the first and the third courses or after the second and fourth courses), 14 pairs were available for analysis (Table 17.46).

### Mean duration of neutropenia

Though GMCSF significantly reduced the mean duration of neutropenia (mean reduction  $2.2 \pm 0.6$  days,

**Table 17.46** Efficacy results of GMCSF treatment versus no treatment.\*

Condition	Number of Treatment Pairs	Difference between Control and GMCSF (Days $\pm$ SEM)	p Value
Neutropenia	14	$2.2 \pm 0.6$	0.003
Leukopenia	14	$1.9 \pm 1.0$	0.08
Fever	14	$-1.0 \pm 1.4$	0.49

\* Paired comparison of control and GMCSF courses. p Value is from the paired t-test.

$p = 0.003$ ; Table 17.46), it did not reduce the mean duration of leucopenia.

There was no difference between the two groups with respect to the number of days of fever or in the



incidence of episodes of high persistent fever that required intravenous antibiotics.

### Blood product support

There was no difference in the number of red cell or platelet transfusions between the GMCSF and control groups of patients ( $p = 1.0$ ).

### Conclusion

It was concluded that while prophylactic GMCSF significantly reduced the mean duration of neutropenia, it did not have any significant impact on the number of days of febrile episodes or reduce the need for transfusion support.

## Study 16

Calderwood S, Romeyer F, Blanchette V, Chan H, Doyle J, Greenberg M, Lorenzana A, Malkin D, Saunders F, Weitzman S, Zipursky A, Freedman M. Concurrent RhGM-CSF does not offset myelosuppression from intensive chemotherapy: randomized placebo-controlled study in childhood acute lymphoblastic leukemia. *Am J Hematol* 1994;**47**:27–32.

### Study design

This was a single center randomized double blind placebo controlled study, conducted between November 1989 and September 1992 in children with poor risk acute lymphoblastic leukemia (ALL). Informed consent was obtained from all patients entered onto the study. Methodology of randomization was not specified in the report.

### Objectives

The main purpose of this study was:

- To determine whether concurrent administration of prophylactic granulocyte macrophage colony stimulating factor (GMCSF) during central nervous system (CNS) intensification would reduce the incidence of chemotherapy induced neutropenia and thereby prevent the complications associated with neutropenia.

### Study details

#### Patient population

All children with newly diagnosed ALL with poor risk features were included in the study. Poor risk features included: age at diagnosis  $<2$  years or  $>10$  years; peripheral blast count  $>50 \times 10^9/l$ ; lymphomatous presentation and L2 FAB lymphoblast morphology.

Children were excluded if informed consent was not obtained at study entry or if the patients were considered to have mature B cell lymphoma/B-ALL. Patient characteristics are shown in Table 17.47.

Patients were randomized blindly to receive either GMCSF or a placebo during the central nervous system (CNS) intensification phase of ALL therapy.

### Treatment strategy

The duration of the CNS intensification phase was 4 weeks and the treatment schedule is shown in Table 17.48. Chemotherapy was temporarily suspended if the neutrophil count (ANC) fell to  $<0.5 \times 10^9/l$  during treatment. Patients randomized to the treatment arm (GMCSF arm), received GMCSF at a dose of  $5 \mu\text{g}/\text{kg}$  subcutaneously on days 5–11 and 19–25. The placebo group received a placebo injection subcutaneously on the same schedule.

**Table 17.47** Patient characteristics.

Characteristics	Treatment Group <sup>a</sup> (n = 20)	Placebo Group <sup>a</sup> (n = 20)
Male/female	9:7	7:12
Age, mean $\pm$ SE (year)	8.5 $\pm$ 1.18	6.1 $\pm$ 0.84
Age, range (year)	2–15.5	1.5–13.5
Blast count, mean $\pm$ SE	60.3 $\pm$ 38.7	50.7 $\pm$ 35.3
Blast count, range	0–550	0–675
L1:L2 <sup>b</sup>	11:5	10:9

<sup>a</sup>In the treatment group 16 of 20 patients completed the trial; in the placebo group, 19 of 20.

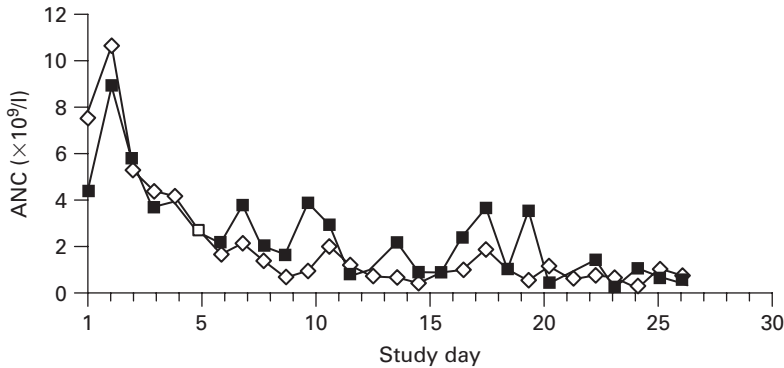
<sup>b</sup>L1:L2, morphology by French–American–British classification.

**Table 17.48** Schedule of administration of chemoradiotherapy and study drug during the 28-day CNS intensification phase.\*

Day	Chemotherapy			Study Drug	IT-MTX	CNS Prophylaxis*
	Cyclo	Ara-C	6-MP			Cranial rads
0	+		+			+
1		+	+		+	+
2		+	+			+
3		+	+			+
4		+	+			+
5			+	+		
6			+	+		
7			+	+		
8		+	+	+	+	+
9		+	+	+		+
10		+	+	+		+
11		+	+	+		+
12			+			+
13	+		+			+
14			+			
15		+	+		+	
16		+	+			
17		+	+			
18		+	+			
19			+	+		
20			+	+		
21			+	+		
22		+	+	+	+	
23		+	+	+		
24		+	+	+		
25		+	+	+		
26			+			
27			+			

\*Children younger than 3 years old received high dose methotrexate (6000 mg/m<sup>2</sup> on days 0, 14 and 27) and triple intrathecal chemotherapy (Ara-C, MTX, hydrocortisone) × 5 doses, in a separate 28-day protocol.

Cyclo: cyclophosphamide; Ara-C: cytosine arabinoside; 6-MP: 6-mercaptopurine; IT MTX: intrathecal methotrexate; rads: central nervous system irradiation and +: administration day.



**Figure 17.21** Daily ANC, ANC (mean) for the rhGMCSF-treated group (■) versus the placebo group (□) during 28-day study period. Treatment periods are indicated by solid black bars on the abscissa. The mean ANCs were marginally higher for the rhGMCSF group during the two treatment cycles.

### Supportive care

Patients who developed febrile neutropenia (fever  $>38.3^{\circ}\text{C}$  with  $\text{ANC} < 0.5 \times 10^9/\text{l}$ ) were hospitalized for empiric broad-spectrum antibiotic treatment (ticarcillin and gentamicin). Amphotericin B was added if fever was unresponsive to antibiotics.

Full blood counts were performed thrice weekly during this phase of treatment. Hemoglobin levels and platelet counts were maintained at  $>8 \text{ gm}\%$  and  $>30 \times 10^9/\text{l}$  respectively by regular transfusions.

### Outcome end points

The main outcome measures included ANC, number of days of chemotherapy treatment, time to complete the CNS intensification phase and the number of days to the commencement of the next phase of the rapy.

Secondary end points included: duration of fever, number of days of antibiotic treatment, length of hospitalization and the severity and type of infections.

### Statistics

An unpaired two-tailed t-test was used to compare the results for the two treatment groups. A p-value of  $<0.05$  was considered significant.

### Outcome

Forty patients were randomized to one of the two treatment groups: 20 to the granulocyte macrophage

colony stimulating factor (GMCSF) arm and 20 to the placebo arm. However, only 16 patients in the GMCSF group and 19 in the placebo arm completed the study. One patient was withdrawn from the GMCSF group because of a suspected allergic reaction to GMCSF. All of the other withdrawals were due to non-compliance. The two groups were similar for age, sex, leukemic blast count and FAB blast morphology.

### ANC

Figure 17.21 shows the daily ANC for the two groups of patients. The mean ANCs were slightly higher in the GMCSF group during two 7-day treatment cycles but not at any other time.

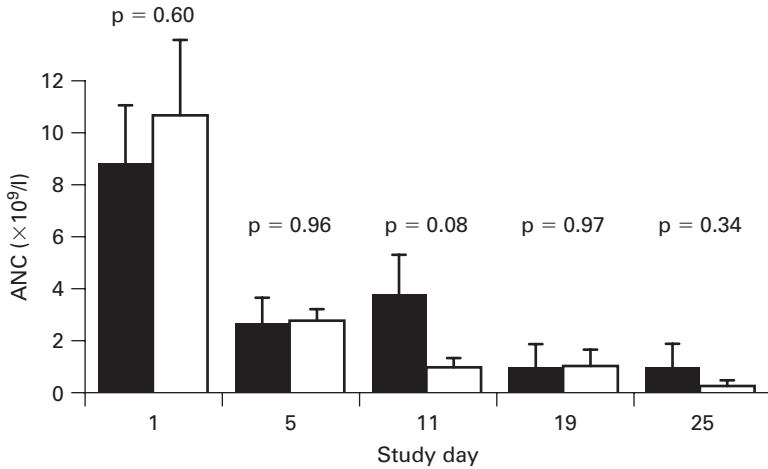
The mean ANCs similar for both groups at the beginning of each cycle but were slightly higher at the end of each treatment cycle for patients randomized to receive GMCSF (Figure 17.22). A trend towards statistical significance was seen after the first cycle alone ( $p = 0.08$ ) but not for the second cycle.

### Duration of neutropenia

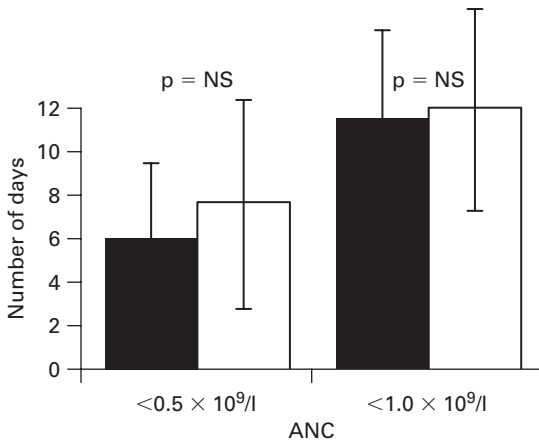
Although the GMCSF group had fewer days of neutropenia, this was not statistically significant (Figure 17.23).

### Chemotherapy days

When analysis was confined to patients who completed the trial, 7 of 16 (44%) patients in the GMCSF arm were able to receive 20 or more days of chemotherapy during the CNS intensification phase compared to 4 of



**Figure 17.22** ANC versus study day. ANC (mean  $\pm$  SE) for the rhGMCSF group (solid bars) and the placebo group (hollow bars) are shown at the beginning of the study, and at the beginning and end of each treatment cycle. ANCs for rhGMCSF group were marginally higher than for the placebo group (p-values shown) after each treatment cycle.

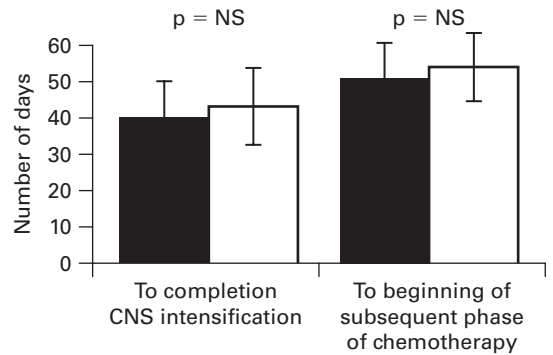


**Figure 17.23** Days of neutropenia. Number of days (mean  $\pm$  SE) with ANC  $<0.5 \times 10^9/l$  and  $<1.0 \times 10^9/l$  during the 28-day study period is shown for the rhGMCSF group (solid bars) and the placebo group (hollow bars). There was no significant difference (NS).

19 (21%) patients in the placebo arm. The mean number of chemotherapy days was also higher in the GMCSF group (18.9 versus 16.6 days) but this was not statistically different.

#### Duration of the CNS intensification phase

There was no significant difference between the two treatment groups in the number of days to complete

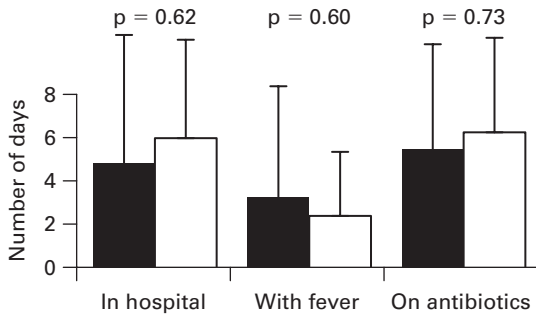


**Figure 17.24** Days to complete CNS intensification and to start subsequent phase of chemotherapy. Days (mean  $\pm$  SE) required to complete CNS intensification and to start the subsequent phase of chemotherapy are shown for rhGMCSF group (solid bars) and placebo group (hollow bars). There was no significant difference (NS).

the CNS intensification phase or to begin the next phase of treatment (Figure 17.24).

#### Other end points

There was no significant difference in the number of days of fever, length of hospital stay or duration of antibiotic usage during the study period between the two groups of patients (Figure 17.25). The two groups also did not differ in the type or severity of infections.



**Figure 17.25** Outcome measures, mean  $\pm$  SE of number of days in hospital, number of days with fever and number of days on antibiotics during the 28-day study period for the rhGMCSF group (solid bars) and placebo group (hollow bars) are shown. There was no significant difference between the two groups for any of these measures.

## Study 17

Wexler LH, Weaver-McClure L, Steinberg SM, Jacobson J, Jarosinski P, Avila N, Pizzo PA, Horowitz ME. Randomized trial of recombinant human granulocyte-macrophage colony-stimulating factor in pediatric patients receiving intensive myelosuppressive chemotherapy. *J Clin Oncol* 1996;14:901–10.

### Study design

This was a prospective randomized study of prophylactic granulocyte macrophage colony stimulating factor (GMCSF) in pediatric sarcoma patients. See Chapter 18; study 3 – cardioprotective agents (use of cardioprotective agent ICRF 187).

### Objectives

The aim of the study was:

- To evaluate whether prophylactic recombinant human GMCSF reduced the hematological toxicities and supportive care requirements in pediatric and young adult sarcoma patients undergoing intensive combination chemoradiotherapy treatment.

### Study details

#### Study population and treatment

All previously untreated patients below the age of 25 years with Ewing's sarcoma family of tumors,

### Toxicity

No significant toxicity attributable to GMCSF was reported in the study.

### Acknowledgement

All figures in this study adapted and reprinted from Calderwood *et al.* (full reference on p. 514) with permission of Wiley-Liss, Inc., a subsidiary of John Wiley & Sons, Inc.

### Conclusion

It was concluded that prophylactic GMCSF was ineffective in preventing chemotherapy induced myelosuppression or complications associated with neutropenia in children with poor risk ALL.

rhabdomyosarcomas or non-rhabdomyosarcomas were eligible for inclusion in the study. Chemotherapy treatment comprised 18 cycles of alternating vincristine, doxorubicin and cyclophosphamide with mesna (VAdriaC) and ifosfamide with mesna and etoposide (IE) (Figure 17.26). Radiotherapy (50–60 Gy) was the main form of treatment for local control and generally began at week 12 (after the fifth cycle of chemotherapy). Twenty-five percent reductions in cyclophosphamide dose (VAdriaC) or ifosfamide and etoposide doses (IE) were made for treatment delays exceeding 7 days. Cycles of chemotherapy generally commenced every 3 weeks provided blood counts were satisfactory ( $ANC \geq 0.5 \times 10^9/l$  and platelets  $\geq 50 \times 10^9/l$ ; for cycles 2–5 and  $ANC \geq 1.0 \times 10^9/l$  and platelets  $\geq 75 \times 10^9/l$ ; for cycles 6–18).

### GMCSF

The protocol incorporated a factorial design in which patients were randomized to receive GMCSF, dexrazoxane, both or neither. The GMCSF used for the study was an E Coli derived non-glycosylated preparation and commenced immediately after cycle 3. Patients randomized to GMCSF received a daily subcutaneous injection 24 to 36 hours after the final dose of chemotherapy in a given cycle and this was continued until either day 19 of the cycle or until the neutrophil count (ANC) was  $\geq 0.5 \times 10^9/l$  for 2 consecutive days. The dose of GMCSF was initially 15  $\mu\text{gm}/\text{kg}/\text{day}$  but

Week	0	1	2	3	4	5	6	9	12	15	18	21	24
R A N D O M I Z E	+DZR +GM	V	V	V	E	V	V	V	E	V	E	E	V
	+DZR -GM	A ± DZR C(m)		I(M)		A ± DZR C(m)		I(M)	A ± DZR C(m)	I(M)	I(M)	I(M)	a ± DZR c(m)
	-DZR +GM					±GM		±GM	±GM	±GM	±GM	±GM	±GM
	-DZR -GM												
		Radiotherapy for local control											
Cycle	1	2		3		4		5	6	7	8	9	
Week	27	30		33		36		39	42	45	48	51	
	E	V		E		V		E	V	E	E	E	
	I(M)	a ± DZR c(m)		I(M)		a ± DZR c(m)		I(M)	a ± DZR c(m)	I(M)	I(M)	I(M)	
	±GM	±GM		±GM		±GM		±GM	±GM	±GM	±GM	±GM	
Cycle	10	11		12		13		14	15	16	17	18	

## Abbreviations and Dosages:

V = vincristine (2.0 mg/m <sup>2</sup> IV push, max 2.0 mg)	E = etoposide (100 mg/m <sup>2</sup> /day IV over 1* × 5 days)
A = doxorubicin (35 mg/m <sup>2</sup> /day IV bolus × 2 days)	I = ifosfamide (1800 mg/m <sup>2</sup> /day IV over 1* × 5 days)
a = doxorubicin (50 mg/m <sup>2</sup> /day IV bolus × 1 days)	±DZR = With or without dexrazoxane (ICRF-187)
C = cyclophosphamide (900 mg/m <sup>2</sup> /day IV over 1* × 2 days)	(IV bolus at 20 times [mg:mg] doxorubicin dose)
c = cyclophosphamide (1200 mg/m <sup>2</sup> /day IV over 1* × 1 days)	±GM = With or without GM-CSF
(m) = mesna (2880 mg/m <sup>2</sup> in 6 equal IV doses)	(5–15 µg/kg/day subcutaneously)

**Figure 17.26** Treatment schema. © American Society of Clinical Oncology (full reference on p. 518).

after November 1990, the dose was reduced to 5 µg/m<sup>2</sup>/day based on the manufacturer's recommendations. For patients randomized to GMCSF, chemotherapy was withheld for at least 48 hours after their last injection of GMCSF.

### Supportive care

Full blood counts were performed thrice a week during each cycle of chemotherapy. Irradiated packed red cell and prophylactic platelet transfusions were given if hemoglobin levels and platelet counts were <8 g% and <20 × 10<sup>9</sup>/l respectively.

Fever was defined as any single oral temperature = 38.5°C or three oral temperatures ≥38°C within a 24-hour period. Children with febrile neutropenia (fever in a child with ANC ≤ 0.5 × 10<sup>9</sup>/l) were hospitalized and commenced on empiric intravenous antibiotic treatment. Amphotericin B was usually started on day 7 in neutropenic patients with persistent fever unresponsive to antibiotics.

### Definitions

**Successful cycle:** a patient was deemed to have had a successful cycle if the duration of grade 4 neutropenia was ≤75% of that of the average control patient for that cycle of chemotherapy.

**Successful patient:** if he/she had ≥50% successful cycles.

**Successful study:** the study was considered successful if ≥75% of patients were successful.

### Outcome end points

The major end point was the duration of severe (grade 4) neutropenia i.e. ANC ≤ 0.5 × 10<sup>9</sup>/l.

### Statistics

The study was designed to accrue a maximum of 40 assessable patients. The Wilcoxon rank sum test was used for comparisons of nadir blood counts, duration of neutropenia and thrombocytopenia, length of hospitalization, antibiotic usage, fever, units of red cell

and platelet transfusions. The  $\chi^2$  test was used to compare the distribution of reasons of fever or hospitalization between the two groups of patients. Probabilities of event-free survival (EFS) and survival was estimated by the Kaplan–Meier method and compared using the stratified Mantel–Haenszel test. All p-values were two sided.

## Outcome

Of the 46 eligible patients enrolled to the study, 8 were subsequently excluded (refused randomization, 1; systemic side effects, 7) from further analysis; 18 were randomized to receive chemotherapy alone and 20 to receive identical chemotherapy plus GMCSF. One patient who was randomized to receive GMCSF developed progressive disease after two cycles of chemotherapy and was excluded from all analyses. Patient details including baseline clinical features are shown in Table 17.49.

## Hematological toxicity

Table 17.50 shows the effect of GMCSF on the ANC nadir and ANC recovery time. As shown in Table 17.51, the median ANC nadir was significantly higher in the GMCSF group compared to the control group of patients (66/ $\mu$ l (range 0–2816) versus 45/ $\mu$ l (range 0–1406);  $p = 0.004$ ). In fact, the median ANC nadir was significantly higher for IE cycles with GMCSF compared to control (128/ $\mu$ l versus 40/ $\mu$ l;  $p < 0.0001$ ) but not from the VAdriaC cycles.

## Duration of neutropenia

The use of GMCSF resulted in a significantly shortened neutropenia. The median duration of grades 3 and 4 neutropenia were 11 and 9 days, respectively, for control cycles versus 7 and 7 days respectively for the GMCSF cycles ( $p < 0.0001$ ) (Table 17.51).

## Duration of thrombocytopenia

Use of GMCSF was associated with significantly greater thrombocytopenia (Table 17.52). The median nadir platelet count after control cycles was  $59 \times 10^9/l$  versus  $29.5 \times 10^9/l$  with GMCSF cycles ( $p < 0.0001$ ). GMCSF also prolonged platelet recovery time ( $\geq 75 \times 10^9/l$ ) (GMCSF, 16 days versus control, 14 days;  $p = 0.0001$ ) and patients randomized to receive GMCSF had a significantly greater platelet transfusion requirements ( $p < 0.0001$ ).

**Table 17.49** Comparison of baseline features according to treatment group.

Feature	Control (n = 18)	GMCSF (n = 19)
Male:female	12:6	10:9
Age on study, years		
Median	17.5	19
Range	4–24	1–24
Race		
White	14	15
Black	3	1
Hispanic	1	2
Asian	0	1
Diagnosis		
ESFT	7	12
RMS	9	3
NRSTS	2	4
Metastatic disease (any site)	8	9
Bone marrow metastases (at diagnosis)	4	2
Bone:Soft tissue primary	3:15	7:12
Primary site		
Pelvis/retroperitoneum	6	8
Chest wall/paravertebral	3	7
Proximal extremity	2	3
Distal extremity	4	0
Head and neck	3	1
Maximum primary tumor diameter (cm)		
Median	8	13
Range	3–18	4–22
Concurrent CHEMOTX/XRT <sup>a</sup>	11	9
XRT dose <sup>b</sup> (Gy)		
Median	54	54
Range	10.8–63	26.7–66
% Bone marrow irradiated		
Median	1.5	0
Range	0–20	0–20
0	7	12 <sup>c</sup>
1–9	9	2
10	2	5
ICRF-187	10	11

ESFT: Ewing's sarcoma family of tumors; RMS: rhabdomyosarcoma; NRSTS: non-rhabdo soft tissue sarcomas; CHEMOTX: chemotherapy and XRT: radiotherapy.

<sup>a</sup>Administration of XRT was based on pre-treatment planning and was not influenced by randomization outcome.

<sup>b</sup>Only for the patients who received concurrent CHEMOTX and XRT.

<sup>c</sup>Includes 2 patients who received XRT to field that does not contain blood-cell-producing bone marrow.

**Table 17.50** Comparison of baseline hematologic toxicity and supportive care requirements following cycles 1 and 2 according to treatment group.

Hematologic Toxicity and Supportive Care	Control (n = 18)		GMCSF (n = 19)	
	Median	Range	Median	Range
AGC nadir (/μl)	32.3	0–440	50.0	0–299
Duration AGC <500/μl (days)	7.5	5.0–13.0	9.0	5.5–15.5
Duration AGC <1000/μl (days)	9.0	5.5–14.0	10.0	7.0–16.5
Platelet nadir (×10 <sup>3</sup> /μl)	94.0	27.5–188.5	91.5	25.0–267.0
Duration platelets <75,000/μl (days)	0.0	0–13.5	7.0	0–16.5
Platelet transfusions (days)	0	0–0	0	0–2
PRBC transfusions (U)	1	0–3.5	1	0–2.5
Total hospital days	11	0–22	13	0–48
Total days of antibiotics	8	0–21	11	0–31
Total days of fever	3	0–13	4	0–20

**Table 17.51** Effect of GMCSF on depth and duration of granulocytopenia.

Treatment Group	AGC Nadir				Duration (Days) AGC < 500/μl				Duration (Days) AGC < 1000/μl			
	n	Median	Range	p	n	Median	Range	p	n	Median	Range	p
All cycles												
Control	225	45	0–1406	0.004	209	9.0	2–24	<0.0001	212	11.0	3–38	<0.0001
GMCSF	165	66	0–2816		137	7.0	1–21		136	7.0	1–21	
IE cycles												
Control	140	40	0–1406	<0.0001	129	9.0	2–24	<0.0001	131	11.0	3–38	<0.0001
GMCSF	105	128	0–2816		83	7.0	1–21		82	7.0	1–22	
VAdriaC cycles												
Control	85	66	0–1380	0.54	80	7.0	2–15	0.0014	81	10.0	4–18	<0.0001
GMCSF	60	16	0–2449		54	7.0	1–13		54	7.0	1–13	

### Duration of hospitalization and infectious complications

No significant differences were seen in the overall incidence of hospitalization between the two groups of patients. Interestingly, patients randomized to receive GMCSF were more likely to be admitted in hospital with non-neutropenic fever than the control group (6% versus 0.7%,  $p < 0.008$ ). Though, no differences were seen in the incidence of infectious complications between the two groups of patients, there was a higher incidence of bacteremia following cycles

given with GMCSF (10.2% versus 4.6%;  $p = 0.02$ ) (Table 17.53).

### Antibiotics, red cell transfusions and chemotherapy dose intensity

There were no significant differences in the average duration of fever, antibiotic usage or hospitalization between the two groups (Table 17.54). Patients randomized to receive GMCSF had a greater requirement for packed red cell transfusions (2 units versus 1 unit). Interval between chemotherapy cycles was similar and no differences in



**Table 17.52** Effect of GMCSF on depth and duration of thrombocytopenia.

Treatment Group	Platelet Nadir ( $\times 10^3$ )				Duration (Days) Platelets $<75,000/\mu\text{l}$				Days of Platelet Transfusions			
	n	Median	Range	p	n	Median	Range	p	n	Median	Range	p
All cycles												
Control	226	59.0	3–309	$<0.0001$	224	14.0	0–38	0.0001	226	0.0	0–6	$<0.0001$
GMCSF	166	29.5	3–288		163	16.0	0–61		162	0.0	0–13	
IE cycles												
Control	140	57.0	3–309	$<0.0001$	138	14.5	0–38	0.0013	137	0.0	0–6	$<0.0001$
GMCSF	105	25.0	5–181		103	18.0	0–38		101	0.0	0–8	
VAdriaC cycles												
Control	86	67.5	11–272	0.0004	86	11.5	0–28	0.06	89	0.0	0–2	$<0.0001$
GMCSF	61	35.0	3–288		60	13.5	0–61		61	0.0	0–13	

**Table 17.53** Effect of GMCSF on need for hospitalization and infectious complications.

Variable	GMCSF (+)		GMCSF (-)		p
	n	%	n	%	
Cycles given <sup>a</sup>	243	100.0	306	100.0	
Assessable cycles <sup>b</sup>	167	68.7	303	99.0	
Reasons for hospitalization					
Fever/granulocytopenia	67	40.1	134	44.2	
Fever/no granulocytopenia	10	6.0	2	0.7	0.008
No fever/granulocytopenia	2	1.2	6	2.0	
No fever/no granulocytopenia	0	0.0	2	0.7	
Non-infectious <sup>c</sup>	1	0.6	3	1.3	
Total	80	47.9	147	48.5	
Infectious complications					
FUO	43	25.7	75	24.8	
Bacteremia	17 <sup>d</sup>	10.2	14 <sup>e</sup>	4.6	0.02
Skin and soft tissue infection	1	0.6	21	6.9	0.002
HEENT (otolaryngologic)	2 <sup>f</sup>	1.2	13	4.3	0.07
<i>Clostridium difficile</i> colitis <sup>g</sup>	4	2.4	3	1.0	
Other <sup>h</sup>	14	8.4	20	6.6	
Total	81	48.5	146	48.2	

<sup>a</sup>Beginning with cycle 3, 243 cycles were given to patients randomized to receive GMCSF and 232 cycles were given to control patients (74 cycles were given without GMCSF in cycles 1 and 2).

<sup>b</sup>Seventy-six cycles of therapy given to patients randomized to receive GMCSF (12 no doxorubicin, 63 no or incomplete GMCSF given, 1 missing data) and 3 cycles given to patients randomized to chemotherapy alone (no doxorubicin) were not assessable.

<sup>c</sup>Non-infectious reasons for hospital admission included sigmoidoscopy to evaluate rectal bleeding (GMCSF cycle), dehydration from protracted chemotherapy induced emesis, rectal pain from external hemorrhoids and pathologic fracture at site of primary tumor.

<sup>d</sup>Twenty-one organisms isolated from 17 episodes of bacteremia.

<sup>e</sup>Sixteen organisms isolated from 14 episodes of bacteremia.

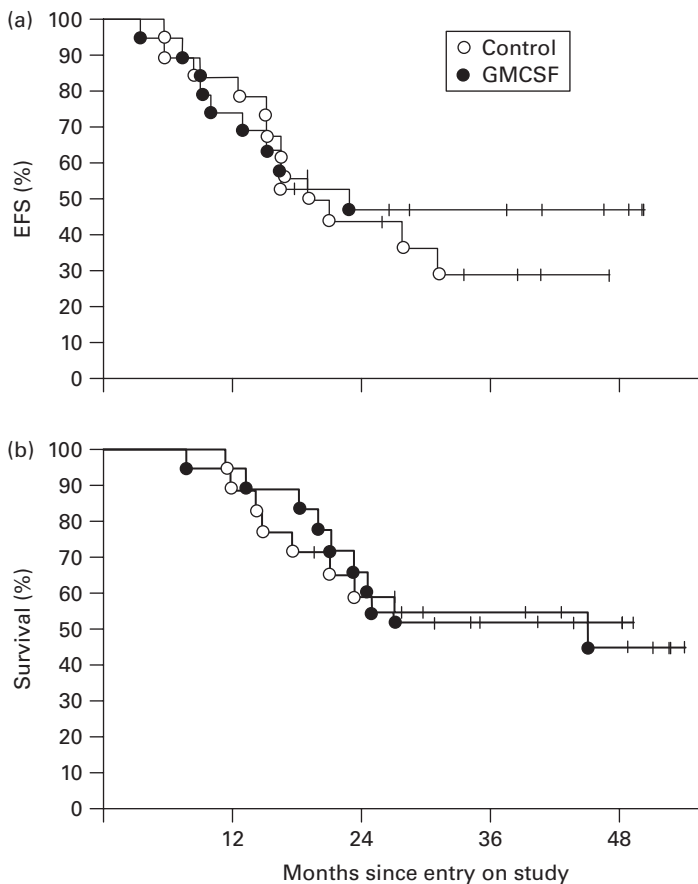
<sup>f</sup>One episode of otitis media was diagnosed and treated in the outpatient setting with oral antibiotics.

<sup>g</sup>Three episodes of *Clostridium difficile* colitis were diagnosed and treated in the outpatient setting with oral antibiotics (one GMCSF and two control cycles).

<sup>h</sup>Other includes urinary tract infection (2 GMCSF and 4 control cycles), pneumonia (1 GMCSF and 2 control cycles), catheter exit-site/tunnel infection (5 GMCSF and 3 control cycles), viral syndrome (4 GMCSF and 5 control cycles), gastrointestinal infection (2 GMCSF and 5 control cycles) and brain abscess (1 control cycle).

**Table 17.54** Effect of GMCSF on supportive care requirements and dose intensity.

Variable	GMCSF (+)			GMCSF (-)			p
	n	Median	Range	n	Median	Range	
Cycles 3–18							
Hospitalization (days)	165	0.0	0–19	226	0.0	0–22	
Antibiotic therapy (days)	75	8.0	3–20	89	7.0	2–18	
Days with fever	160	0.0	0–9	218	0.0	0–8	0.047
PRBC transfusions (U)	164	2.0	0–8	224	1.0	0–9	0.002
Interval duration (days per patient)							
Cycles 3–5	17	42	40–51	17	43	41–48	
Cycles 3–9	11	139	132–165	15	137	126–172	0.06
Cycles 3–18	5	348	325–375	9	354	321–402	
Treatment delivered (% of planned dose per patient)							
Cyclophosphamide	19	100	100–100	18	100	100–100	
Ifosfamide	19	100	85–100	18	100	92.7–100	



**Figure 17.27** Effect of GMCSF on survival. (a) EFS according to treatment group. No significant differences were seen in either the duration of EFS or actuarial EFS at 36 months. There were no toxic deaths in either group. (b) OS according to treatment group. No significant differences were seen in either the median duration of survival or probability of survival at 36 months. © American Society of Clinical Oncology (full reference on p. 518).

dose reductions of either cyclophosphamide or ifosfamide were seen between the two groups.

### Event free survival and overall survival

Three year EFS was 28.8% (95% CI 12.4–53.6%) and 46.8% (95% CI 26.7–68%) for the control and GMCSF patients respectively ( $p = 0.62$ ).

Three year overall survival (OS) was 53.5% (95% CI 31.3–71.4%) and 56.1% (95% CI 34.3–75.9%) for the

control and GMCSF patients respectively ( $p = 0.90$ ) (Figure 17.27).

### Conclusion

It was concluded that GMCSF was of minimal benefit as it did not reduce the severity or duration of neutropenia but was associated with significantly worsened thrombocytopenia.

## Study 18

Burdach SE, Muschenich M, Josephs W, Frisch J, Schulz G, Jurgens H, Gobel U. Granulocyte-macrophage-colony stimulating factor for prevention of neutropenia and infections in children and adolescents with solid tumors. Results of a prospective randomized study. *Cancer* 1995;76:510–6.

### Study design

This prospective randomized single center study took place between March 1988 and March 1990 and included all children with soft tissue sarcomas, Ewing's sarcoma or neuroblastomas. A detail of the randomization methodology was not specified in the report. Informed written consent was obtained for all patients according to the local institutional guidelines.

### Objectives

The main aim of this trial was:

- To evaluate the efficacy of prophylactic granulocyte macrophage colony stimulating factor (GMCSF) in reducing the duration of neutropenia and infections in children undergoing treatment for solid tumor malignancies.

### Study details

#### Patient population

Patients with soft tissue sarcoma, Ewing's tumor or neuroblastoma were eligible for inclusion to the study (Table 17.55). All were treated according to the German Pediatric Oncology/Hematology Group protocols.

**Table 17.55** Data of evaluated patients.

Patient	Age (years)	Sex	Primary Disease	Therapy Protocol	Randomized
1	19	M	Ewing's sarcoma	CESS 86	–GMCSF
2	7	M	Rhabdomyosarcoma	CWS 86	+GMCSF
3	20	F	Ewing's sarcoma	CESS 86	–GMCSF
4	13	M	Fibrosarcoma	CWS 86	+GMCSF
5	14	M	Ewing's sarcoma	CESS 86	+GMCSF
6	18	M	Ewing's sarcoma	CESS 88	+GMCSF
7	3	F	Rhabdomyosarcoma	CWS 86	–GMCSF
8	4	M	Neuroblastoma	NB 90 P	–GMCSF
9	4	F	Rhabdomyosarcoma	CWS 86	+GMCSF
10	14	F	MPNT	CWS 86	+GMCSF
11	17	M	Leiomyosarcoma	CWS 86	–GMCSF

CESS: Cooperative Ewing's Sarcoma Study; CWS: Cooperative Soft Tissue Sarcoma Study and NB 90P: Neuroblastoma Study 90.

The Ewing's tumor and soft tissue sarcoma protocol contained vincristine, doxorubicin, ifosfamide and actinomycin D while the neuroblastoma chemotherapy regimen contained vincristine, doxorubicin, ifosfamide, dacarbazine, cisplatin, etoposide and teniposide.

### Randomization

At diagnosis patients were randomized into two groups: group 1 received GMCSF after the first and third cycles of chemotherapy while group 2 received GMCSF after the second and fourth cycles. The study ceased with the commencement of local radiotherapy.

### GMCSF

GMCSF was administered at a dose of  $250 \mu\text{m}^2/\text{day}$  as a continuous intravenous infusion, 48 hours after the last dose of chemotherapy and continued until either the absolute neutrophil count (ANC)  $>1.0 \times 10^9/\text{l}$  for 5 consecutive days or for a maximum of 14 days.

### Definitions

The patient was considered to have an infection if the body temperature was  $>38.5^\circ\text{C}$  and C-reactive protein  $>1 \text{ mg}\%$ .

Myelopoietic function: the area under the curve of the ANC over time.

### Statistics

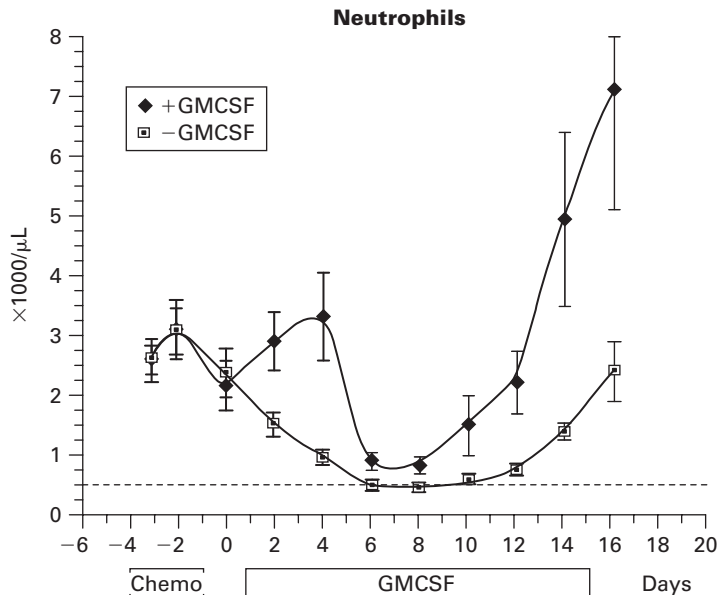
Samples were analyzed for parametric distribution by the David Pearson Stephens test. Parametric samples were analyzed by the Student's paired t-test and non-parametric samples by the paired Wilcoxon test. Results were stated as mean  $\pm$  standard error for mean and were considered significant if the p-value was  $<0.05$ . The equation for integrals to determine the area under the ANC curve was  $a(b1 + b2)/2$  with  $a = x$  and  $b = y$  ( $x = \text{day of treatment}$ ;  $y = \text{ANC}$ ).

### Outcome

#### Myelopoiesis

The ANC on day 4 was 3.4 times higher with GMCSF than without GMCSF. Similarly, the ANC with GMCSF was 3 times higher on day 16 than without GMCSF (Figure 17.28) and the area under the curve with GMCSF between day 2 and day 16 was larger than the area under the curve without GMCSF ( $31.2 \pm 1.3 \text{ ANC} \times 10^3/\mu\text{l}/14 \text{ days}$  versus  $12.7 \pm 0.4 \text{ ANC} \times 10^3/\mu\text{l}/14 \text{ days}$ ;  $p = 0.001$ ).

Duration of severe neutropenia ( $<0.5 \times 10^9/\text{l}$ ) with GMCSF was  $1.9 \pm 0.4 \text{ days}$  compared to  $5.7 \pm 0.5 \text{ days}$  without GMCSF ( $p = 0.0001$ ) per treatment cycle (Table 17.55). During the entire treatment period, the duration of neutropenia ( $<1 \times 10^9/\text{l}$ ) for each patient who received GMCSF was  $18.5 \pm 4.1 \text{ days}$  compared



**Figure 17.28** Mean ANC on each day of treatment with ( $n = 39-42$ ) and without GMCSF ( $n = 39-42$ ) during one course of chemotherapy. Reprinted from Burdach *et al.* (full reference on p. 524) with permission of Wiley-Liss, Inc., a subsidiary of John Wiley & Sons, Inc.

**Table 17.56** Effects of GMCSF on neutrophilic granulocytes.

Parameters	+GMCSF	-GMCSF	p Value
Neutrophils $\times 1000/\mu\text{l}/14$ days	$37.2 \pm 1.3$	$12.7 \pm 0.4$	0.01
Days with ANC $<500/\mu\text{l}$ (mean)	$1.9 \pm 0.4$	$5.7 \pm 0.5$	0.0001
Days with ANC $<1000/\mu\text{l}$ (mean)	$4.9 \pm 0.5$	$9.0 \pm 0.5$	0.0001
ANC $<500/\mu\text{l}$ per patient (days)	$7.5 \pm 2.0$	$21.8 \pm 2.8$	0.003
ANC $<1000/\mu\text{l}$ per patient (days)	$18.5 \pm 4.1$	$34.0 \pm 3.9$	0.005
Mean nadir of neutrophils ( $\times 1000/\mu\text{l}$ )	881	434	0.017

to  $34 \pm 3.9$  days without GMCSF ( $p = 0.005$ ) (Table 17.56).

### Erythropoiesis

Hemoglobin concentrations were higher in patients who received GMCSF compared to the non-GMCSF group. However, patients who received GMCSF had a higher starting hemoglobin values. There was no difference in the number of packed cell transfusions per patient between the two groups of patients (GMCSF,  $5.6 \pm 1.8$ /patient versus non-GMCSF,  $7.2 \pm 2.0$ /patient;  $p = \text{NS}$ ).

### Thrombopoiesis

The number of days with a platelet count  $<20 \times 10^9/\text{l}$ , was higher in patients who received GMCSF compared to the non-GMCSF group ( $2.1 \pm 0.4$  days versus  $1.2 \pm 0.3$  days;  $p = 0.047$ ).

### Infectious complications

Eight infectious episodes were seen in the GMCSF group compared to 14 episodes in the non-GMCSF group. GMCSF patients had  $1.9 \pm 0.7$  days of infection versus  $4.3 \pm 0.9$  days in the non-GMCSF group ( $p = 0.034$ ). There were no differences in the duration of an infectious episode or the number of days of antibiotic treatment.

### Conclusion

It was concluded that though prophylactic GMCSF reduced the severity and duration of neutropenia including the number of infections, it compromised platelet recovery.

# Studies – Erythropoietin (EPO)

## Study 19

Wagner LM, Billups CA, Furman WL, Rao BN, Santana VM. Combined use of erythropoietin and granulocyte colony-stimulating factor does not decrease blood transfusion requirements during induction therapy for high-risk neuroblastoma: a randomized controlled trial. *J Clin Oncol* 2004;22:1886–93.

### Study design

This was a single center prospective randomized study and was conducted during the period January 1992 to January 1997 and included all children with high risk neuroblastoma eligible for enrollment on the NB 91 protocol of the St. Jude's Children's Research Hospital. The study had the approval of the institutional review board and informed consent was obtained for all enrolled patients. All patients were randomized to receive granulocyte colony stimulating factor (GCSF) alone or GCSF plus recombinant erythropoietin (EPO) after each of the six cycles of intensive induction chemotherapy. Analysis of data was based on an intention to treat philosophy.

### Objectives

The purpose of this study was:

- To evaluate the efficacy of prophylactic EPO and GCSF in reducing blood transfusion requirements in children with high risk neuroblastoma.

### Study details

#### Patient population

Thirty-eight previously untreated children with metastatic neuroblastoma were included in the study. Patient characteristics are shown in Table 17.57. Patients were

stratified according to disease stage C or D, baseline hemoglobin (Hb) concentration (<8 g% or >8 g%) and age (<5 years or >5 years).

#### Treatment program

Induction chemotherapy consisted of three cycles of cyclophosphamide, doxorubicin and etoposide alternating with three cycles of cisplatin and etoposide (Table 17.58). Chemotherapy administration was dependent on neutrophil counts (ANC) and commenced only when the ANC was  $>0.5 \times 10^9/l$ . On completion of the sixth cycle, patients underwent resection of the residual tumor and hemopoietic stem cell harvest (bone marrow harvest). Following surgery, patients proceeded to have consolidation therapy with high dose carboplatin and etoposide and stem cell rescue (unpurged autologous bone marrow). On recovery after stem cell transplantation, all patients received 10 cycles of interferon alfa over 16 weeks.

#### Growth factors and supportive care

GCSF (10  $\mu\text{g}/\text{kg}/\text{day}$  subcutaneously) commenced 24 hours after completion of the first cycle and continued until 2 days before the start of the next cycle. On day 6 of the first cycle, patients were randomized to receive or not receive EPO 200 units/kg subcutaneously. EPO commenced on day 6 of the first cycle and this continued until 2 days before the start of cycle 2. In subsequent cycles, EPO was commenced 24 hours after completion of chemotherapy.

If Hb was <10 g%, EPO was administered daily but if the Hb concentration was >10 g%, it was given thrice a week. EPO was temporarily discontinued when Hb was >13 g% and was recommenced when it fell <13 g%. The aim was to maintain Hb levels of patients between 10 and 13 g%.

Patients with iron deficiency received oral ferrous sulfate (2 mg/kg/day). All patients received packed red blood cells (RBC) when their Hb was  $\leq 8\text{g}\%$  or if

**Table 17.57** Characteristics of patients enrolled on protocol NB91.

	All Patients (n = 38)		GCSF Only (n = 20)		GCSF + EPO (n = 18)	
	Number of Patients	%	Number of Patients	%	Number of Patients	%
Age at diagnosis, years						
Median		3.2		3.2		3.2
Range		1.1–19.4		1.1–7.3		1.2–19.4
≤5	30	79	16	80	14	78
>5	8	21	4	20	4	22
INSS stage (POG stage)						
2b (C)	1	3	0	0	1	6
3 (C)	6	16	5	25	1	6
4 (D)	31	82	15	75	16	89
Primary site						
Adrenal	27	71	15	75	12	67
Abdominal (non-adrenal)	6	16	3	15	3	17
Pelvic	2	5	1	5	1	6
Thoracic	2	5	1	5	1	6
Unknown	1	3	0	0	1	6

Note: Percentages may not add up to 100% because of rounding.

INSS: International Neuroblastoma Staging System and POG: Pediatric Oncology Group.

**Table 17.58** Chemotherapy schema.

Induction
CAE, cycles 1, 3, 5 <sup>a</sup>
Cyclophosphamide (1 g/m <sup>2</sup> /day) on days 1 and 2
Doxorubicin (35 mg/m <sup>2</sup> /day as a 1-hour IV infusion) on day 1
Etoposide (30 mg/m <sup>2</sup> as a bolus followed by 250 mg/m <sup>2</sup> /day as a continuous infusion) on days 2–5
PVP, cycles 2, 4, 6 <sup>b</sup>
Cisplatin (40 mg/m <sup>2</sup> /day) on days 1–5
Etoposide (200 mg/m <sup>2</sup> /day as a 1-hour IV infusion) on days 2–4
Consolidation
Cycle 7
Carboplatin (700 mg/m <sup>2</sup> /day) on days 1, 3 and 5
Etoposide (500 mg/m <sup>2</sup> /day as a 6-hour IV infusion) on days 2, 4 and 6
Reinfusion of autologous marrow on day 7

CAE: cyclophosphamide, doxorubicin, and etoposide; IV: intravenous and PVP: cisplatin and etoposide.

<sup>a</sup>Planned length of each cycle of CAE = 17 days.

<sup>b</sup>Planned length of each cycle of PVP = 20 days.

there was a clear medical or surgical indication. Platelet transfusions were given when the platelet count was  $<20 \times 10^9/l$  or if there was evidence of active bleeding.

### Outcome end points

The main outcome measure was the total number of packed red cell transfusions in patients randomized to receive EPO.

### Statistics

The study was aimed to detect a 25% decrease in total red cell blood transfusion requirements and used a one sided alternative with a type 1 error rate of 5% and power of 80%. Fifteen patients per arm were deemed sufficient for validation of the results.

The Kaplan–Meier method was used to estimate the progression-free survival and overall survival while the

**Table 17.59** Laboratory features at diagnosis of 38 Patients enrolled on treatment protocol NB91.

	All Patients (N = 38)		GCSF Only (N = 20)		GCSF + EPO (N = 18)		p
	Number of Patients	%	Number of Patients	%	Number of Patients	%	
Hemoglobin, g/dl							
Median	9.05		9.35		8.85		0.26
Range	6.1–15.3		7.0–15.3		6.10–11.20		
Number missing <sup>a</sup>	0	0	0	0	0	0	
Platelets, per mm <sup>3</sup>							
Median	368		375		361		0.90
Range	74–1, 160		74–1, 160		142–745		
Number missing <sup>a</sup>	6	16	5	25	1	6	
Reticulocyte count, % RBC							
Median	2.3		1.6		3.0		41
Range	0.5–5.6		0.6–5.5		0.5–5.6		
Number missing <sup>a</sup>	9	24	6	30	3	17	
Ferritin, ng/ml							
Median	197		189		242		– <sup>b</sup>
Range	26–1, 309		26–931		119–1, 309		
Number missing <sup>a</sup>	9	24	7	35	2	11	
Iron, µg/dl							
Median	41		24		51.5		– <sup>b</sup>
Range	8–184		9–184		8–165		
Number missing <sup>a</sup>	12	32	8	40	4	22	
Iron binding capacity, µg/dl							
Median	215		218		211		– <sup>b</sup>
Range	128–305		59–305		128–287		
Number missing <sup>a</sup>	16	42	10	50	6	33	

<sup>a</sup>Number of patients for whom particular data are missing.

<sup>b</sup>If more than 30% of laboratory values were missing, tests of significance were not performed.

exact log rank test was used to compare the distribution of survival probability. Fisher's exact test identified differences between groups with respect to categorical variables and the exact Wilcoxon rank sum test was used to compare continuous response variables between groups. Differences in total packed RBC transfusion requirements and the number of RBC transfusions between the two groups were estimated using a repeated measures mixed model, to account for correlation among multiple observations of the same patient.<sup>1</sup>

## Outcome

### Patient population

The treatment groups did not differ significantly in terms of age ( $p = 0.99$ ), baseline Hb concentration ( $p = 0.41$ ) or disease stage ( $p = 0.26$ ).

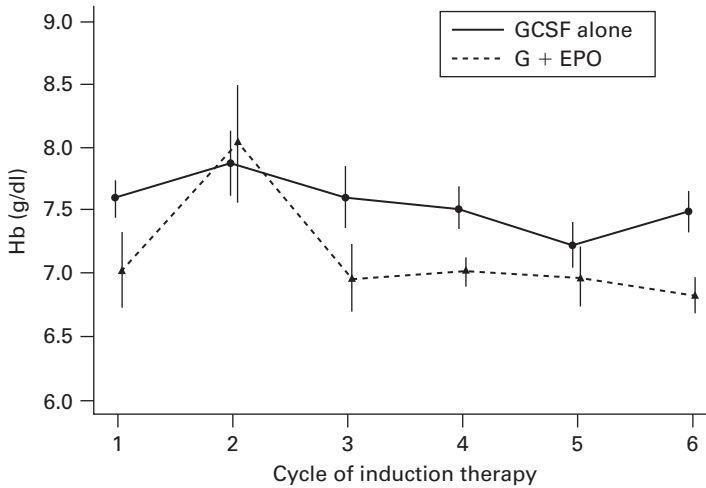
Sixty-three percent (24/38) had bone marrow infiltration at diagnosis and the bone marrow involvement was similar in both groups of patients at diagnosis (60% GCSF group versus 67% GCSF + EPO group;  $p = 0.74$ ) and after four cycles of chemotherapy ( $p = 0.70$ ). Of 38 patients who were randomized, 20 were randomized to GCSF alone while 18 were randomized to GCSF plus EPO.

Hematology laboratory results of the two groups at diagnosis are shown in Table 17.59.

### RBC transfusion requirements

The median total of packed RBC transfusion (date of enrollment to end of induction) per patient was 106.6 ml/kg (range 66.6–202.9) for the GCSF group versus 161 ml/kg (range 92–243.6) for the GCSF + EPO group ( $p = 0.005$ ).





**Figure 17.29** Average minimum Hb concentration by treatment group and cycle of induction therapy. Bars represent one standard deviation from the mean. A repeated measures analysis showed no significant difference in the minimum Hb concentrations between the two treatment group ( $p$  (r) = 0.082). GCSF: granulocyte colony-stimulating factor and G+ EPO: granulocyte colony-stimulating factor plus erythropoietin. © American Society of Clinical Oncology (full reference on p. 527).

Additionally, the GCSF + EPO group received more packed RBC transfusions compared to the GCSF alone group (258 versus 207). Similarly, the median total number of transfusions per patient over the entire induction period was higher in the GCSF + EPO group (13.5 versus 9.5). When analysis was restricted for transfusions given for Hb < 8 g%, the median number of transfusions was again higher in the GCSF + EPO group (median 10; range 2–16) compared to the GCSF alone group (median 8; range 3–16) ( $p$  = 0.044).

Patients who were given GCSF + EPO had a lower average minimum Hb concentration during five of the six cycles of induction chemotherapy (Figure 17.29).

### Iron assessment and supplementation

As shown in Table 17.59, the baseline values of iron, iron binding capacity and ferritin were similar in both groups of patients and remained similar across both groups during the study. No study patient received iron supplementation.

### Duration of neutropenia

The duration of neutropenia (neutrophil count <500/mm<sup>3</sup>) was similar in both treatment groups of patients; the median number of days of neutropenia was 22.6 days (range 5.9–39.9) for the GCSF group versus 18.8 days (range 9.3–47) for the GCSF + EPO group ( $p$  = 0.63). There were no significant differences in the total number of episodes of febrile neutropenia (50 in the GCSF group versus 42 in the GCSF + EPO group) or in the median number of episodes per

patient (2.5 GCSF group versus 2.0 GCSF + EPO group;  $p$  = 0.75).

### Platelet transfusions

The total platelet transfusion requirement of each patient in each group (44 ml/kg; GCSF group versus 65.9 ml/kg; GCSF + EPO group) and the median number of platelet transfusion per patient in each group (6 in GCSF group versus 9 in GCSF + EPO group) were similar ( $p$  = 0.19).

### Duration of induction therapy

The total duration of induction therapy was similar for both groups of patients; median duration 120.5 days for the GCSF group (range 111–144) versus 118 for the GCSF + EPO group (range 107–147) ( $p$  = 0.98).

### Patient outcome

Fourteen patients were alive at a median of 6.4 years. There were no significant differences in the 5-year probability of survival ( $40 \pm 10.3\%$ ; GCSF group versus  $44.4 \pm 11.7\%$ ; GCSF + EPO group;  $p$  = 0.71) or 5-year progression-free survival ( $25 \pm 8.8\%$ ; GCSF group versus  $38.9 \pm 11.5\%$ ; GCSF + EPO group;  $p$  = 0.72) between the two groups of patients.

### Conclusion

It was concluded that the addition of EPO to GCSF, provided no added benefit for high risk neuroblastoma patients during intensive induction chemotherapy.

## Study 20

Csaki C, Ferencz T, Schuler D, Borsi JD. Recombinant human erythropoietin in the prevention of chemotherapy-induced anaemia in children with malignant solid tumours. *Eur J Cancer* 1998;**34**:364–7.

### Study design

This was an open labeled single center prospective randomized phase II trial. The study had approval from the local ethics committee board and written informed consent was obtained for all the study patients. Children were randomized to receive or not to receive recombinant human erythropoietin (rhEPO) at diagnosis and this randomization was done centrally by an independent study committee. Methodology of randomization was not specified in the report

### Objectives

The main aim of the study was:

- To evaluate the efficacy and safety of prophylactic recombinant human erythropoietin (rhEPO) in the prevention and treatment of chemotherapy induced anemia in children with solid tumors.

### Study details

#### Patient population

Children between the ages of 4 and 18 years with biopsy proven solid tumors such as Ewing's sarcoma, neuroblastoma, osteogenic sarcoma and soft tissue sarcoma were included in the study. Other inclusion criteria for study entry were:

- 1 Life expectancy >3 months.
- 2 Performance status <3 on the WHO scale.
- 3 Hemoglobin (Hb) value <12 g% before first rhEPO administration.

Patients with resistant hypertension, severe anemia, thrombocytopenia ( $>500 \times 10^9/l$ ), renal insufficiency, metastatic brain disease, coagulation disorders including chronic bleeding or protocol non-compliance were excluded from the study. Patients undergoing cyclical chemotherapy were randomized to either a control group (no rhEPO) or to receive rhEPO at a dose of 150 U/kg subcutaneously three times a week for a minimum of 12 weeks or 3 chemotherapy cycles.

#### Treatment strategy

Due to the different types of solid tumors, three different chemotherapy protocols were used and the

chemotherapy drugs included vincristine, cisplatin, ifosfamide, doxorubicin, methotrexate, etoposide and actinomycin D. Chemotherapy cycles were administered at 3–4 weekly intervals and were blood count dependent i.e. neutrophil count  $>1 \times 10^9/l$  and platelets  $>150 \times 10^9/l$  for commencement of chemotherapy.

In patients randomized to receive rhEPO was administered concurrently with the next cycle of chemotherapy after randomization, throughout the study with the aim to maintain Hb between 11 and 13 g%. However, if the Hb value exceeded 14 g%, rhEPO was discontinued temporarily and if the Hb was <11 g%, the dose was increased by 50 U/kg/dose. All patients randomized to rhEPO also received ferrous sulfate supplementation for the duration of the study. Packed red cell transfusions were given to all patients if the Hb was <8 g% or if the patient had symptoms of anemia.

Response to rhEPO: defined as a rise in Hb level by 1 g% by week 4 and by 2 g% by week 12 unrelated to a blood transfusion in the preceding 4 weeks.

### Statistics

Dichotomous variables (e.g. number of patients who responded) were analyzed by the Fisher's exact test. Exact Wilcoxon rank sum tests were used to compare the number of transfused blood units per patient during the study. Unpaired Student's t-test was used to test the equality of mean values of continuous variables and two-sided tests were used with a comparison wise significance level of 0.05.

### Outcome end points

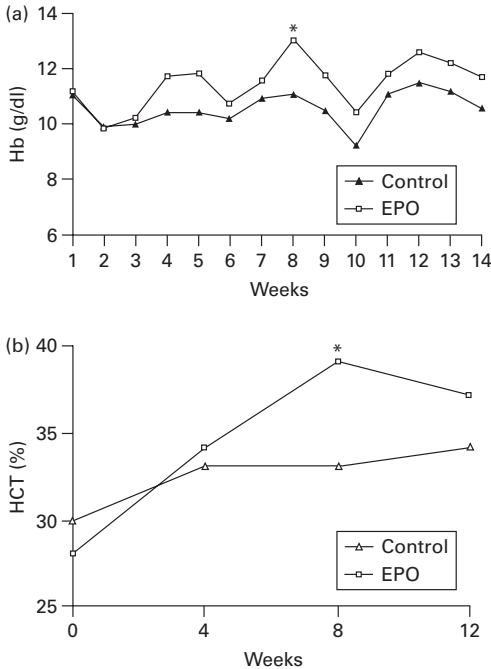
The primary outcome measure was: (1) Hb and Hct (hematocrit) levels in patients randomized to receive EPO.

Secondary measures were (1) total number of red cell transfusions in patients randomized to receive EPO and (2) safety of rhEPO.

### Outcome

#### Study population

Twenty patients were enrolled on to the study of whom, 12 were randomized to receive rhEPO. Three patients were withdrawn from the study due to patient refusal (rhEPO group, two; control group, one). Two additional patients in the rhEPO group who had completed 3 cycles of chemotherapy had to be excluded from efficacy analysis (severe bleeding due to chemotherapy related thrombocytopenia and inability



**Figure 17.30** Changes of (a) weekly mean Hb values and (b) monthly Hct values during the trial period in control and rhEPO-treated groups. \* $p < 0.05$ . Reprinted from Csaki *et al.* (full reference on p. 531) with permission from Elsevier.

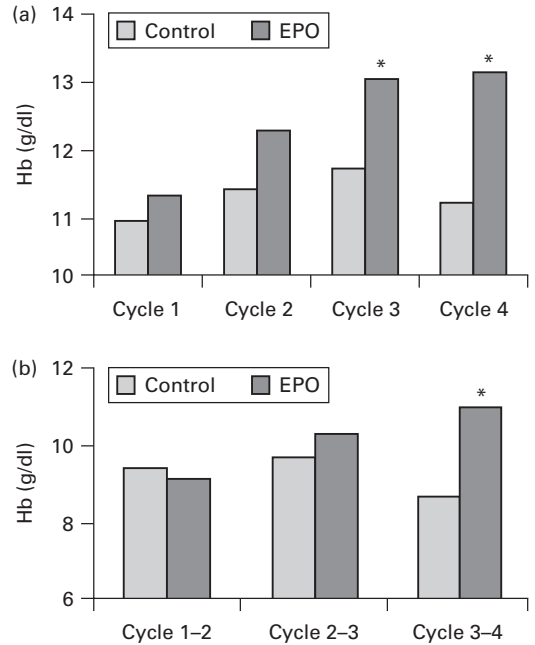
to take iron supplementation during therapy). Both were however, included for the analysis of safety.

Thus, 18 patients were included for the safety analysis (all patients except 1 rhEPO patient who withdrew prior to commencement of rhEPO treatment and the 1 withdrawn control patient) while 15 (rhEPO, 8; controls, 7) were evaluable for efficacy analysis.

Patients in the rhEPO group had received a mean of  $3.8 \pm 3.7$  (range 1–12) cycles of chemotherapy prior to the randomized study entry while it was  $3.9 \pm 1.5$  (range 1–5) cycles of chemotherapy for the control patients. With regard to blood transfusions prior to study entry, it was  $1.4 \pm 1.4$  transfusions in the rhEPO group versus  $2.7 \pm 3.0$  transfusions in the control group. These differences were not statistically significant. The mean duration of rhEPO therapy was  $12 \pm 1$  weeks.

### Hb and Hct levels

Though the mean Hb levels were higher in the rhEPO group compared to control group from the 4th week



**Figure 17.31** Comparison of (a) pre-cycle mean Hb values measured before the start of chemotherapy cycles 1–4, and (b) lowest mean mid-cycle Hb values measured as Hb nadir values between chemotherapy cycles 1 and 4, in control and rhEPO-treated groups. \* $p < 0.05$ . Reprinted from Csaki *et al.* (full reference on p. 531) with permission from Elsevier.

after study entry, they reached statistical significance only after the 8th week of therapy ( $13.11 \pm 1.13$  g% versus  $11.06 \pm 1.35$  g%,  $p < 0.05$ ). Similarly mean Hct values increased progressively in the rhEPO group and were significantly higher than in the control group ( $39.3 \pm 4.2\%$  versus  $33.2 \pm 2.1\%$ ;  $p < 0.05$ ) at week 8 (Figure 17.30).

The mean pre-cycle (prior to commencement of next cycle of chemotherapy) and mid-cycle Hb levels were also higher in the rhEPO group compared to the control group of patients (Figure 17.31).

### rhEPO response

rhEPO doses ranged between 123 and 230 U/kg (mean 161 U/kg and median 155 U/kg).

Though early response (response by 4 weeks) was muted in the rhEPO group ( $n = 8$ ), with only two children showing a response, the response rate was significantly better and higher in the rhEPO group compared to the control group ( $n = 7$ ) by week 12 (6 in the rhEPO group versus 1 in the control group;  $p < 0.05$ ).

### Blood transfusion requirements

Comparing the number of red cell transfusions over the entire study period, transfusion requirements were similar in both groups of patients – 3/7 patients in the control group received 7 transfusion units over 22 cycles of chemotherapy versus 4/8 children in the rhEPO group; 6 transfusion units over 26 chemotherapy cycles;  $p = \text{NS}$ .

However, when stratified by month of therapy, transfusion requirements in the rhEPO group were significantly lower in the 3rd month of treatment compared to Children in the control group (0 versus 4) rhEPO had no significant effect on either platelet counts or platelet recovery.

### Iron status

Serum iron and ferritin levels were significantly lower in the rhEPO group during the entire study period despite continuous iron supplementation in the rhEPO patients and no iron supplementation in the control

group ( $8.95 \pm 4.40 \mu\text{mol/l}$  versus  $20.04 \pm 11.35 \mu\text{mol/l}$ ;  $p < 0.05$ ). However, no signs of iron storage depletion was demonstrated.

### Performance status

General performance status was improved in the rhEPO group with weight loss being lower in the rhEPO group (0.7 kg (range  $-5$  to  $+1.5$  kg) in the rhEPO group versus 2.5 kg (range  $-5.8$  to  $+0.0$  kg) in the control group).

### Side effects

No significant adverse effects were reported after rhEPO administration.

### Conclusion

It was concluded that rhEPO safely and effectively ameliorated anemia and improved the performance status of children who received intensive chemotherapy.

## Study 21

Buyukpamukcu M, Varan A, Kutluk T, Akyuz C. Is epoetin alfa a treatment option for chemotherapy-related anemia in children? *Med Pediatr Oncol* 2002;**39**:455–8.

### Study design

This was a single center prospective randomized study. Neither the study period nor the methodology of randomization was specified in the report.

### Objectives

The main aim of the study was:

- To evaluate the efficacy and safety of prophylactic erythropoietin (epoetin alfa) in the prevention and treatment of chemotherapy induced anemia in children undergoing intensive chemotherapy.

### Study details

Only patients with hemoglobin (Hb) value  $>11$  g% on admission and with normal renal, hepatic and pulmonary function were eligible for inclusion on the study. Patients who received packed red cell transfusion in the 1 month prior to study entry were excluded. No other details were specified in the report.

Serum erythropoietin (EPO) levels were measured in all patients on study entry and again, at the end of the study in patients who were randomized to receive epoetin alfa. The dose of epoetin alfa was 150 U/kg three times/week subcutaneously. No patient received iron supplementation during the study. Epoetin alfa was discontinued if a study patient developed deep vein thrombosis, hypertension or an allergic reaction.

All patients received packed red cell transfusion if the Hb dropped to  $<6$  g%.

### Outcome end points

The main outcome measures were the total number of packed red cell transfusions and tolerability of epoetin alfa in patients randomized to receive EPO.

### Outcome

#### Study population

Of the 34 patients were enrolled on the study, 17 were randomized to receive epoetin alfa. Just over half of the patients received a non-platinum-based chemotherapy regimen while approximately 40% also received radiotherapy (Table 17.60). Patient characteristics are shown in Table 17.61.

**Table 17.60** On-study cancer treatments (n = 34).

Platinum-based chemotherapy, n (%)	15 (44.1)
Non-platinum-based chemotherapy, n (%)	19 (55.9)
Local regional radiotherapy, n (%)	13 (38.2) <sup>a</sup>
Cranial and/or spinal radiotherapy, n(%)	7 (20.6) <sup>b</sup>

<sup>a</sup>Patients with rhabdomyosarcoma, Wilms' tumor, Ewing's sarcoma and nasopharyngeal carcinoma.

<sup>b</sup>Patients with brain tumors.

**Table 17.61** Demographics and clinical characteristics.

Total Study Population (N = 34)		
Sex, n (%)		
Female		14 (41.2)
Male		20 (58.8)
Age (years)		
Median		5
Range		1–16
Diagnosis	Epoetin alfa group (n = 17)	Control group (n = 17)
Tumor type, n (%)		
Lymphoma	3 (17.6)	4 (23.5)
Brain tumor <sup>a</sup>	5 (29.4)	2 (11.7)
Rhabdomyosarcoma	3 (17.6)	2 (11.7)
Wilms' tumor	1 (5.9)	4 (23.5)
Neuroblastoma	1 (5.9)	1 (5.9)
Liver tumor	1 (5.9)	1 (5.9)
Ewing's sarcoma	0 (0.0)	2 (11.7)
Nasopharyngeal carcinoma	1 (5.9)	0 (0.0)
Retinoblastoma	1 (5.9)	0 (0.0)
Yolk sac tumor	1 (5.9)	1 (5.9)

\*Including astrocytoma, medulloblastoma and ependymoma.

Though there was no significant difference in the EPO levels between the two groups of patients at study entry, median EPO levels were lower at the end of the study (3.5–270 IU/l; median 22 IU/l) than at study entry (14–410 IU/l; median 80 IU/l) in the epoetin alfa group.

### Hemoglobin values

Hb levels were similar in both groups of patients at study entry (EPO group 8.5 g% versus control group 8.48 g%). However, patients randomized to receive epoetin alfa had a significant increase ( $p = 0.027$ ) in Hb level at the end of the study (Table 17.62). This increase in Hb values was evident after 4 weeks of

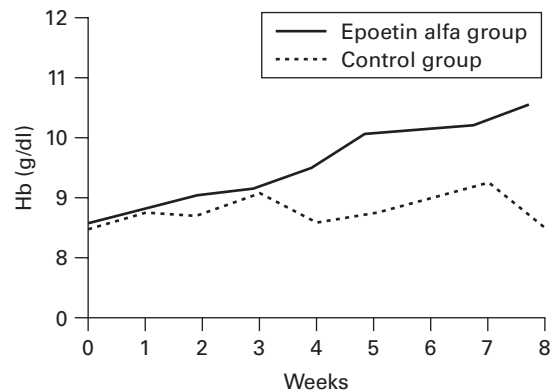
**Table 17.62** Endogenous EPO, Hb levels and transfusion requirements.

	Epoetin Alfa Group (n = 17)	Control Group (n = 17)
Median EPO levels (IU/l)		
Study start	80	62
Study end	22	Not done
Mean Hb levels (g/dl)		
Study start	8.50	8.48
Study end <sup>a</sup>	10.21	8.41
Number of transfusions required <sup>b</sup>	1	8

Adapted and reproduced with permission from Pediatrics 103:C16–C19, Table II, Copyright 1999.

<sup>a</sup> $p = 0.027$ , between-group difference.

<sup>b</sup> $p = 0.008$ , between-group difference.



**Figure 17.32** Hb levels during the course of the study. Hb levels start to increase in epoetin alfa patients after 4 weeks of therapy. Solid line: epoetin alfa group (n = 17) and dashed line: control group (n = 17). Reproduced with permission from *Pediatrics* 103:C16–C19, Figure 1, Copyright 1999.

epoetin treatment. In contrast, there was no change in Hb values in the control group (Figure 17.32).

### Transfusion requirements

Patients randomized to receive epoetin alfa had significantly lower transfusions over the course of the study when compared to the control group (1 versus 8;  $p = 0.08$ ) (Table 17.62).

## Safety

Hypertension developed in 1 patient on epoetin alfa and, epoetin was temporarily discontinued for a week. No adverse effects were reported in any of the other 16 patients.

## Conclusion

It was concluded that epoetin alfa was safe and significantly improved Hb levels and reduced transfusion requirements in children with solid tumors receiving intensive chemotherapy.

## Study 22

Porter JC, Leahey A, Polise K, Bunin G, Manno CS. Recombinant human erythropoietin reduces the need for erythrocyte and platelet transfusions in pediatric patients with sarcoma: a randomized, double-blind, placebo-controlled trial. *J Pediatr* 1996;129:656–60.

### Study design

This single center double blind placebo controlled randomized study was conducted between September 1991 and February 1994. The study was approved by the local ethics committee board and written informed consent was obtained from the parents of all the study patients. Children were randomized to receive either recombinant human erythropoietin (rhEPO) or a placebo (normal saline) for a 16-week study period. Randomization was done according to a computer generated list of random numbers.

### Objectives

The purpose of this study was:

- To evaluate the effect of rhEPO along with iron supplementation, on the transfusion requirements in children receiving intensive chemotherapy for sarcomas.

### Study details

#### Study population

All children between 6 months to 18 years of age were eligible for inclusion if they had a hemoglobin level of <10.5 g% and or anemia that was unrelated to blood loss, hemolysis or vitamin deficiency. Children were excluded if they have primary hematological disorder, previous seizures, serum creatinine >2 mg% or metastatic disease either to the bones or brain.

### Erythropoietin treatment

Children were randomly assigned to receive either rhEPO or a placebo for 16 weeks. The dose of rhEPO was 150 IU/kg three times/week subcutaneously or intravenously. If the child required a transfusion or did not maintain a hemoglobin level >11.5 g% after 4 weeks of rhEPO treatment, the rhEPO dose was increased by increments of 50 IU/kg (maximum dose 300 IU/kg/dose) every 4 weeks till the target hemoglobin value was achieved. Similarly, if the hemoglobin level was >15 g%, the dose was reduced by 50 IU/kg. However, if the hemoglobin level was >16.5 g%, rhEPO was withheld till the hemoglobin level was <11.5 g%.

All children received iron supplementation (6 mg/kg/day of ferrous sulfate) during the study period. Iron supplementation was discontinued if the serum ferritin levels were >1000 ng/ml.

At the end of the 16-week period, all patients including those randomized to receive placebo were offered rhEPO for remainder of their treatment period.

### Laboratory monitoring

Full blood counts, serum biochemistry, serum iron, serum ferritin, serum iron binding capacity were performed prior to randomization and thereafter, at monthly intervals.

### Outcome end point

The primary end point was the number of packed red cell transfusions (ml/kg) in both groups of patients during the 16-week study period.

### Statistics

The two-sided Wilcoxon rank-sum test was used to compare the packed red cell and platelet transfusions between the rhEPO and placebo groups. Additionally, packed red cell and platelet transfusions during the

**Table 17.63** Patient characteristics on day 1 of study.

Characteristic	EPO (n = 10)	Placebo (n = 10)
Sex		
Male	5	5
Female	5	5
Age (year)		
Median	14	13
Range	5–17	5–16
Diagnosis		
Ewing's sarcoma	4	3
Rhabdomyosarcoma	3	3
Osteosarcoma	3	2
Undifferentiated sarcoma	0	2
Chemotherapeutic regimens		
VAdriaC/VP-Ifos	6	6
Adria-Ifos/Mtx	3	2
VAC	1	
VAC/VP-Ifos		1
VAC/Adria-CPPD		1
GCSF use (5 µg/kg/day)	6	8
Radiation during study	4	6
Hemoglobin level (g/dl)		
Median	9.7	9.4
Range	7.7–10.8	8.2–10.1
EPO level (IU/ml)		
Median	24	21
Range	10–89	5–447

*VAdriaC/VP-Ifos*, Vincristine 2 mg/m<sup>2</sup>, doxorubicin 25 mg/m<sup>2</sup> and cyclophosphamide 1.2 g/m<sup>2</sup> × 3 days, alternating cycles with etoposide 100 mg/m<sup>2</sup> and ifosfamide 1.8 g/m<sup>2</sup> × 5 days; *Adria-Ifos/Mtx*, doxorubicin 25 mg/m<sup>2</sup> × 3 days and ifosfamide 1.8 g/m<sup>2</sup> × 5 days, alternating cycles with methotrexate 12 g/m<sup>2</sup>, and leukovorin; *VAC*, vincristine 1.5 mg/m<sup>2</sup>, actinomycin 20 µg/kg and cyclophosphamide 300 mg/m<sup>2</sup> × 3 days; *VAC/VP-Ifos*, vincristine 1.5 mg/m<sup>2</sup>, actinomycin 50 µg/kg and cyclophosphamide 1.2 g/m<sup>2</sup> × 3 days, alternating cycles with etoposide 100 mg/m<sup>2</sup>, and ifosfamide 1.8 g/m<sup>2</sup> × 5 days; *VAC/Adria-CPPD*, vincristine 2 mg/m<sup>2</sup>, actinomycin 50 µg/kg and cyclophosphamide 1.2 g/m<sup>2</sup> × 3 days, alternating cycles with doxorubicin 25 mg/m<sup>2</sup> and cisplatin 90 mg/m<sup>2</sup>.

study period was compared with the subsequent weeks of open label rhEPO dosing by using the two-sided Wilcoxon signed rank test. A p-value <0.05 was considered to be statistically significant. It was assumed that a sample size of 20 patients (10 patients in each treatment arm) had an 80% power to detect 70% reduction in the

**Table 17.64** Erythrocyte and platelet transfusion requirements during the 16-week masked study period.

	EPO (n = 10)	Placebo (n = 10)
PRBC transfusion		
Patients receiving transfusion (No.)	9	10
Units transfused (No.)		
Median <sup>a</sup>	4.5	13
Range	(0–9)	(2–22)
Amount (ml/kg) transfused		
Median <sup>b</sup>	23	80
Range	(0–118)	(18–226)
Platelet transfusion		
Patients receiving transfusion (No.)	3	9
Units SDP transfused		
Median <sup>c</sup>	0	4
Range	(0–3)	(0–17)

<sup>a</sup>p = 0.01 for EPO versus placebo groups.

<sup>b</sup>p = 0.02 for EPO versus placebo groups.

<sup>c</sup>p = 0.005 for EPO versus placebo groups.

PRBC: packed red blood cell

packed red cell transfusion requirement in the prophylactic rhEPO group of patients.

## Outcome

Of the 24 patients enrolled on the study, 4 patients were excluded as they did not complete their assigned treatment during the study period. There were no differences with regard to age, sex, diagnosis, chemotherapy regimen, use of granulocyte colony stimulating factor (GCSF) or baseline hemoglobin levels between the two groups of patients. Patient characteristics are shown in Table 17.63.

The median dose of rhEPO during the study period was 198 IU/kg/dose three times/week and most of the patients received rhEPO intravenously (7/10).

## Packed red cell and platelet transfusions

The mean hemoglobin at the time of packed red cell transfusion was identical in both groups (8.1 g%) while the platelet count at the time of transfusion was  $34 \times 10^9/l$  and  $32 \times 10^9/l$  in the rhEPO and placebo groups respectively.

Patients who were randomized to received rhEPO received significantly fewer red cell transfusions (p = 0.02) and platelet transfusions compared to the placebo

**Table 17.65** Comparison of erythrocyte transfusion requirements for patients initially treated with placebo who subsequently received epoetin alfa (EPO).

Patient No.	PRBC (ml/kg/16 week)	
	Placebo	EPO*
12	58.3	37.5
13	60.0	54.8
16	45.2	30.1
17	100.0	67.5
20	18.9	14.2
22	226.2	131.0
24	136.4	44.1

\*If administered for less than 16 weeks, requirement for the 10- to 15-week period extrapolated to 16 weeks ( $p = 0.02$ ).

group (Table 17.64). Unsurprisingly, the number of donor exposures was also found to be significantly less in the rhEPO group ( $p = 0.01$ ).

### Bone marrow suppression

Nineteen percent of children randomized to rhEPO had a neutrophil count of  $<1 \times 10^9/l$  compared to

30% in the placebo group. There was no statistical difference between the two groups of patients with respect to GCSF use.

At the completion of the 16-week study period, 15 patients (8 from the rhEPO group and 7 from the placebo group) received rhEPO for an additional 10–16 weeks. All patients in the placebo group who subsequently received rhEPO, required fewer packed red cell transfusions with a median decrease of 33% (range 9–68%). Transfusion requirements in the open label follow period is shown in Table 17.65.

### Toxicity

No documented toxic effects of rhEPO were reported.

### Conclusion

It was concluded that prophylactic erythropoietin significantly reduced red cell transfusions in children with malignant sarcomas receiving intensive chemotherapy.



## CHAPTER 18

# Cardioprotection in pediatric oncology

## Studies: Dexrazoxane

### Study 1

Lipshultz SE, Rifai N, Dalton VM, Levy DE, Silverman LB, Lipsitz SR, Colan SD, Asselin BL, Barr RD, Clavell LA, Hurwitz CA, Moghrabi A, Samson Y, Schorin MA, Gelber RD, Sallan SE. The effect of dexrazoxane on myocardial injury in doxorubicin-treated children with acute lymphoblastic leukemia. *New Engl J Med* 2004; **351**:145–53.

### Study design

This was a multi-center randomized controlled study and was part of the Dana Farber Cancer Institute (DFCI) childhood acute lymphoblastic leukemia (ALL) consortium protocol 95-001. The study was conducted between January 1996 and September 2000 and all children below the age of 18 years with previously untreated high risk childhood lymphoblastic leukemia (ALL) were eligible for inclusion. Patients with standard risk ALL (children aged between 1 and 10 years of age with a white cell count  $<50 \times 10^9/l$  at diagnosis, with absent T immunophenotype, no anterior mediastinal mass or central nervous system disease) were excluded from the study.

Randomization was according to a permuted block design and was performed centrally at the DFCI's quality assurance office for clinical trials before patients received doxorubicin (DOX) or dexrazoxane (DXN). Patients were randomly assigned to receive DOX alone or DXN ( $300 \text{ mg/m}^2$ ) immediately followed by DOX. Local centers and patients were not blinded to the randomization with respect to DXN but central investigators (those performing troponin T measurements, echocardiography (ECHO) or providing summary results)

remained blinded throughout the study period. An independent data monitoring committee reviewed data on enrollment, adverse effects and troponin T results at 6-monthly intervals and released troponin T results when all patients completed DOX treatment.

All patients received 2 doses of DOX ( $30 \text{ mg/m}^2$ ) during remission induction, followed by 8 further doses ( $30 \text{ mg/m}^2$ ) during the treatment course. The total cumulative dose was  $300 \text{ mg/m}^2$ . No DOX was given after 9 months of treatment.

Serum samples for cardiac troponin T levels (an index of myocardial injury) were collected at standardized times (at diagnosis before DOX; daily after induction doses of DOX; 7 days after DOX during induction and at the end of therapy) and were stored at  $-70^\circ\text{C}$  until it was assayed at the central laboratory. The assay had a sensitivity of 0.01 ng/ml.

Cardiac troponin T was considered to be elevated if the value was  $>0.01 \text{ ng/ml}$  and extremely elevated if the value was  $>0.025 \text{ ng/ml}$ .

ECHOs were performed in a subgroup of patients generally at three time points – at diagnosis prior to DOX administration, midway after a cumulative DOX dose of between  $150\text{--}300 \text{ mg/m}^2$  and on completion of treatment. However, patients with impaired cardiac functions had more frequent ECHOs. All ECHOs were evaluated by a single sonographer who was unaware of

### Objectives

The primary aim of the study was:

- To determine whether DXN reduced DOX associated cardiac damage in children with high risk ALL.

**Table 18.1** Characteristics of the patients.\*

Characteristic	DOX (n = 101)	DXN + DOX (n = 105)
Sex – No.		
Male	56	64
Female	45	41
Median age at diagnosis – year	7.3	7.5
DOX		
Median cumulative dose – mg/m <sup>2</sup>	300	300
Received less than the median of 300 mg/m <sup>2</sup> – no./total no. (%)	26/96 (27)	19/101 (19)
Troponin T samples		
Median no./patient	15.0	15.1
*Total no. that could be evaluated	1139	1238
No. with DOX- or DXN-associated dose-limiting adverse effects	0	0

\*There were no significant differences between groups.

the patients' clinical data. Each ECHO which included Doppler evaluation, measured fractional shortening and stress velocity index. Diastolic function was not assessed.

### Statistics

Fisher's exact test and the Kruskal–Wallis test were used to compare the baseline characteristics and the frequency of elevated cardiac troponin T levels between the treatment groups. Logistic regression was used to identify covariates associated with elevated cardiac troponin T levels. Event-free survival (EFS) was estimated according to the Kaplan–Meier method. ECHO data were analyzed with the use of *t*-tests and repeated measures analysis. All ECHO data was adjusted for growth. All reported *p* values were two sided.

### Outcome end points

The primary end point was to determine the frequency of elevated cardiac troponin T levels between the two groups of patients.

### Outcome

#### Study population

Of the 219 eligible children enrolled on the study, only 206 underwent randomization as 13 patients refused to be randomized (parent/patient refusal: *n* = 11 and logistical reasons, *n* = 2). No randomized patient refused to participate, failed to receive or discontinued

DXN as assigned or was excluded from analysis. These 206 patients were evaluable for EFS and adverse effects.

Of the 206 randomized patients, 9 failed to achieve complete remission (5 in the DOX group and 4 in the DOX plus DXN group) and 39 did not have data on cardiac troponin values. The remaining 158 patients formed the cohort used for cardiac troponin analyses.

The randomized cohort (*n* = 206) and the cardiac troponin cohort (*n* = 158) were similar with respect to age, sex, cumulative DOX dose, absence of congestive cardiac failure or symptomatic arrhythmias.

Baseline characteristics of the randomized patients are shown in Table 18.1.

### Cardiac troponin T

Compared to DOX alone group, fewer patients in the DOX plus DXN had elevations in the cardiac troponin T (21% versus 50%; *p* < 0.001), extreme elevations of cardiac troponin T (10% versus 32%; *p* < 0.001) or multiple elevations in cardiac troponin T (12% versus 37%; *p* < 0.001) (Table 18.2).

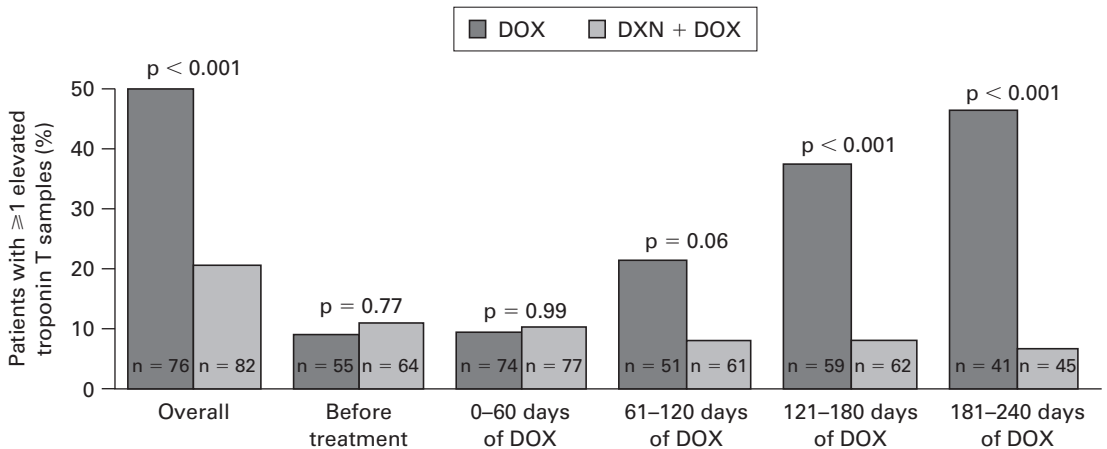
### Timing of elevation in cardiac troponin T

Figure 18.1 shows the percentage of patients in each group with at least one elevated cardiac troponin T value. Differences between the two groups with at least one elevated value emerged between day 61 and 120 after start of treatment and became significant between day

**Table 18.2** Frequency of elevations in serum cardiac troponin T.\*

Subgroup	DOX (n = 76)		DXN + DOX (n = 82)		p Value
	No. with finding/ Total No.	% (95% CI)	No. with finding/ Total No.	% (95% CI)	
Any elevation in troponin T	38/76	50 (38–62)	17/82	21 (13–31)	<0.001
During DOX therapy	35/76	46 (35–58)	12/80	15 (8–25)	<0.001
After DOX therapy ended	11/29	38 (21–58)	5/29	17 (6–36)	0.14
Multiple elevations in troponin T	28/76	37 (26–49)	10/82	12 (6–21)	<0.001
Any extreme elevation in troponin T	24/76	32 (21–43)	8/82	10 (4–18)	<0.001
Multiple extreme elevations in troponin T	15/76	20 (11–30)	6/82	7 (3–15)	0.03
No pre-treatment elevations in troponin T	71/76		75/82		
Any subsequent elevation	33/71	46 (34–58)	10/75	13 (7–23)	<0.001
Any elevation during DOX therapy	32/71	45 (33–57)	9/74	12 (6–22)	<0.001
Any elevation after DOX therapy ended	10/27	37 (19–58)	4/26	15 (4–35)	0.12
Multiple elevations	24/71	34 (23–46)	5/75	7 (2–15)	<0.001
Any extreme elevation	21/71	30 (19–42)	4/75	5 (1–13)	<0.001
Multiple extreme elevations	15/71	21 (12–32)	4/75	5 (1–13)	0.006

\*An elevated troponin T level was one that exceeded 0.01 ng/ml, and an extremely elevated level was one that exceeded 0.025 ng/ml. CI denotes confidence interval.

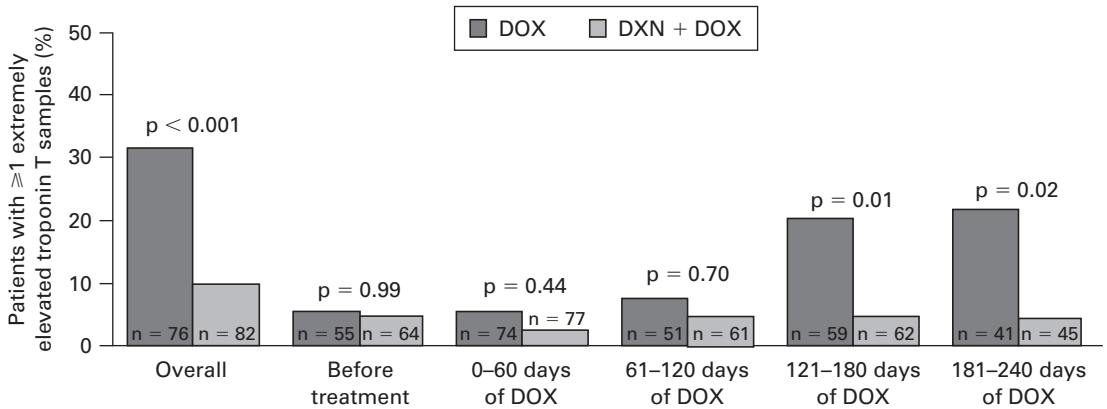


**Figure 18.1** Percentage of patients with at least one elevated cardiac troponin T level overall, before treatment with DOX and during treatment. An elevated level of troponin T was defined as one that exceeded 0.01 ng/ml. The number of patients in whom troponin T was measured at least once during the specified intervals is shown in each bar. © American Society of Clinical Oncology (full reference on p. 538).

121 and 180 ( $p < 0.001$ ). The same pattern was seen for differences in extreme elevation of cardiac troponin T between the two groups (Figure 18.2). Patients in the DOX alone group also had a higher rate of elevation of cardiac troponin T over time compared to the DOX plus DXN group ( $p = 0.03$ ).

### Patients with pre-treatment elevation of cardiac troponin T

Ten percent of children in whom cardiac troponin T was measured prior to commencement of DOX treatment, had an elevated cardiac troponin T value. Children who had elevated pre-DOX cardiac troponin T levels had



**Figure 18.2** Percentage of patients with at least one extremely elevated cardiac troponin T level overall, before treatment with DOX and during treatment. An extremely elevated level of troponin T was defined as one that exceeded 0.025 ng/ml. The number of patients in whom troponin T was measured at least once during the specified intervals is shown in each bar. © American Society of Clinical Oncology (full reference on p. 538).

higher baseline white blood cell counts ( $300.3 \times 10^9/l$  versus  $27.2 \times 10^9/l$ ;  $p < 0.001$ ) and a higher blast count (89% versus 57.5%;  $p = 0.003$ ).

Compared to patients who did not have an elevated pre-DOX cardiac troponin T level, those who did, had a higher rate of elevated (73% versus 27%;  $p = 0.004$ ) and extremely elevated (58% versus 17%;  $p = 0.003$ ) levels after commencement of DOX.

Even after exclusion of children with pre-treatment elevated cardiac troponin T levels, DXN treatment had a significant cardioprotective effect (Table 18.2).

### Covariates

Covariates such as sex, race (white versus non-white), age (<10 years versus  $\geq 10$  years) and cumulative dose of DOX ( $300 \text{ mg/m}^2$  versus  $\geq 300 \text{ mg/m}^2$ ) were not associated with elevated cardiac troponin T levels.

### ECHO data

Four hundred and sixty-two ECHOs were performed in the randomized group of patients who achieved complete remission and in whom cardiac troponin T levels were available; 162 ECHOs were performed during DOX therapy and a further 164 were done at a median of 198 days after completion of therapy.

ECHOs obtained before DOX treatment showed normal fractional shortening (84 ECHOs; mean z score 0.19;  $p = 0.51$ ) and normal contractility (22 ECHOs; mean z score  $-0.02$ ;  $p = 0.96$ ) but slight left ventricular dilation. After treatment, both fractional shortening and contractility were depressed but left ventricular dimension was normal (no left ventricular dilation).

There were no significant differences between the two groups (DOX alone and DOX plus DXN) with respect to mean left ventricular dimension, fractional shortening or contractility before, during or after DOX treatment. Fractional shortening was significantly depressed in both randomized groups during and after DOX therapy.

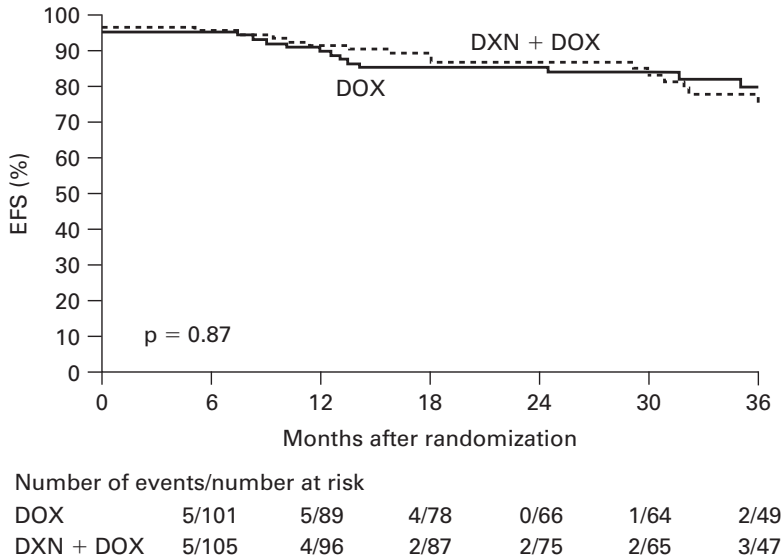
### EFS

The EFS at 2.5 years was 83% in both the randomized groups ( $p = 0.87$ ) (Figure 18.3).

### Conclusion

It was concluded that DXN afforded significant cardioprotection without compromising the anti-leukemic efficacy of DOX in children with high risk ALL.

A more recent publication in blood [pre-published online on September 26th 2006, "Results of the Dana Farber Cancer Institute ALL Consortium protocol 95-01 for children with acute lymphoblastic leukaemia"] confirms that dexrazoxane did not adversely impact on the 5 year EFS for high risk patients [ $p = 0.99$ ].



**Figure 18.3** Kaplan–Meier plot of EFS after a median follow-up of 2.7 years. At 2.5 years, the EFS rate was 83% in each group and the rate of continuous complete remission was 81% in each group (82 of 101 patients in the DOX group and 85 of 105 patients in the group given DXN and DOX). For children who did not have a complete remission, the time to the first event was zero. The log-rank test was used to calculate the p value. Reprinted from Lipshultz *et al.* (full reference on p. 538). © 2004 Massachusetts Medical Society.

## Study 2

Wexler LH, Andrich MP, Venzon D, Berg SL, Weaver-McClure L, Chen CC, Dilsizian V, Avila N, Jarosinski P, Balis FM, Poplack DG, Horowitz ME. Randomized trial of the cardioprotective agent ICRF-187 in pediatric sarcoma patients treated with doxorubicin. *J Clin Oncol* 1996; **14**: 362–72.

### Study design

This was a prospective randomized open label study conducted between February 1989 and September 1992 and, included patients with sarcomas enrolled on the National Cancer Institute (NCI) protocol 86C169. At the time of enrollment, all patients underwent a computer generated 1:1 factorial randomization to receive ICRF-187 (DXN), granulocyte macrophage colony stimulating factor (GM-CSF), both or neither. The study was approved by the institutional review board of the NCI and informed consent was obtained from all the patients or their guardians.

### Objectives

The primary aim of the study was:

- To determine the efficacy of DXN as a cardioprotector in children and young adults with sarcoma, receiving doxorubicin containing chemotherapy.

### Study details

#### Study population

All patients below the age of 25 years with Ewing's sarcoma family of tumors, rhabdomyosarcomas or non-rhabdomyosarcoma soft tissue sarcomas [NRSTS] were eligible for inclusion in the study.

Criteria for exclusion from entry to the study included low baseline cardiac function (left ventricular ejection fraction (LVEF) <45%) and the inability to have LVEF monitored by MULTIPLE Gated Acquisition (MUGA) scans.

### Treatment strategy

All patients received multi-agent combination chemotherapy regimen comprising vincristine [2 mg/m<sup>2</sup>/cycle], doxorubicin (70 mg/m<sup>2</sup>/cycle over 2 days) and cyclophosphamide (1800 mg/m<sup>2</sup>/cycle) with mesna (VAdriaC) during cycles 1, 3, 5, 9, 11, 13 and 15 alternating with ifosfamide (9 gm/m<sup>2</sup>/cycle) with mesna and etoposide (500 mg/m<sup>2</sup>/cycle) (IE) during cycles 2, 4, 6, 7, 8, 10, 12, 14, 16, 17 and 18. The dose of doxo-rubicin and cyclophosphamide during cycles 9, 11, 13 and 15 were reduced to 50 mg/m<sup>2</sup> and 1200 mg/m<sup>2</sup>. Each cycle commenced 3 weeks after the preceding cycle and was blood count dependent (i.e. neutrophil count >1 × 10<sup>9</sup>/l and platelet count >75 × 10<sup>9</sup>/l). 25% reductions in the doses of IE were made for patients who had >7 day delay in commencement of chemotherapy cycle due to prolonged neutropenia. Radiotherapy was used for local tumor control and commenced at week 12 after 5 cycles of chemotherapy.

The dose of DXN was 20 times the dose of doxorubicin and it was given intravenously 15 minutes before administration of doxorubicin.

### Evaluation of cardiotoxicity

MUGA scans using technetium 99 m pertechnetate labeled red blood cells was used to determine doxorubicin cardiotoxicity. These were performed at baseline and at 6–12 weeks after the 210, 310, 360 and 410 mg/m<sup>2</sup> cumulative doses of doxorubicin. All MUGA scans were reviewed by three nuclear medicine physicians who were blinded to the patient's randomization and clinical status.

Dose-limiting cardiotoxicity was defined as a reduction in the LVEF to <45%, or decrease in the LVEF by >20 percentage points from the baseline or clinical evidence of congestive cardiac failure (CCF).

### Evaluation of treatment response

All patients underwent reassessment after two and four cycles of treatment. Reassessment studies included plain radiographs, CT or MRI imaging of the primary tumor site and metastatic sites, isotope bone scans and bone marrow aspirates/biopsies if initially involved.

### Evaluation of non-cardiac toxicities

Hepatic toxicity was assessed by comparing total bilirubin, AST and ALT before and 1, 2 and 8 days after DXN.

Complete blood counts were performed thrice a week. Neutropenia was defined as absolute neutrophil count (ANC) <1 × 10<sup>9</sup>/l and the duration of neutropenia was defined as the number of days the ANC was <1 × 10<sup>9</sup>/l.

### Pharmacokinetic analyses

Plasma concentrations of DXN were measured by the reverse phase high pressure liquid chromatography (HPLC). Blood samples were obtained before administration of DXN and thereafter at the end of the infusion, 15, 30 and 60 minutes and at 2, 4, 6, 8, 12 and 24 hours after the end of DXN infusion.

### Outcome end point

The primary end point of the study was to evaluate short term cardiotoxicity by determining the change in the resting LVEF.

### Statistics

The study had an 80% power in a two sided *t*-test (at 0.05 significance level) to detect a 12% difference in the mean decrease of LVEF. The LVEF at baseline and following the 410 mg/m<sup>2</sup> cumulative doxorubicin dose and the median cumulative doxorubicin dose were compared using the Wilcoxon rank sum test. Weight, pulse rate, LVEF, blood pressure, hemoglobin levels, blood urea and serum creatinine at baseline and following each doxorubicin dose were analyzed by least squares regression, with a model that incorporated a baseline parameter for each patient and a common slope within the DXN and control groups. The normality of residuals was confirmed by the Shapiro–Wilk method. Response rates after four cycles of chemotherapy and the probability of a persistently abnormal LVEF on the first follow-up MUGA scan after stopping doxorubicin were compared by the Fisher's exact test. Comparisons of toxicity were assessed by Fisher's exact test for 2 × 2 and 2 × 3 tables; by the Mantel–Heanszel test of trend in rank score tables with up to five columns and by the Wilcoxon rank sum test for all others. Probabilities of event-free survival (EFS) and overall survival (OS) and of the development of dose-limiting cardiotoxicity were estimated by the Kaplan–Meier method. All *p* values were two sided and a value <0.05 was considered significant.

**Table 18.3** Comparison of baseline clinical characteristics according to treatment group.

Variable	Chemotherapy Alone (n = 18)	Chemotherapy + ICRF-187 (n = 23) <sup>a</sup>
GM-CSF	9	11
Male:female	11:7	15:8
Age on study, years		
Median	15.5	18.5
Range	3–24	4–24
Race		
White	14	17
Black	2	3
Hispanic	1	3
Asian	1	0
Diagnosis		
ESF	10	11
RMS	5	8
NRSTS	2	4
Other <sup>b</sup>	1	0
Metastatic disease	9	11
Bone versus soft tissue tumor	5:13	6:17
Primary site		
Trunk	9	19
Proximal extremity	5	2
Distal extremity	2	2
Head and neck	2	0
Mean $\pm$ SD maximum primary tumor diameter (cm)	11.4 $\pm$ 5.0	10.8 $\pm$ 5.1
Mean $\pm$ SEM baseline LVEF <sup>c</sup>	59.6% $\pm$ 2.2%	59.8% $\pm$ 2.5%

<sup>a</sup>Includes all patients who received ICRF-187 (20 randomized, 3 assigned).

<sup>b</sup>Other neuroblastoma.

<sup>c</sup>For randomized patients only (18 control, 20 treated).

## Outcome

Of the 43 eligible patients entered on the study, 4 patients were excluded from the study (1 excluded because the inability to have regular MUGA scans and 3 requiring chest wall irradiation for local tumor control). Of the remaining 39 patients, 20 were randomized to receive DXN with chemotherapy and the rest (n = 19) to chemotherapy alone; 1 patient randomized to chemotherapy alone was later excluded from analysis as the treatment was at another center; 38 patients were eligible for cardiotoxicity analyses. Patient characteristics are shown in Table 18.3. Both groups were comparable with respect to age, sex, histology and anatomic location of primary tumor.

### Evaluation of cardiac function

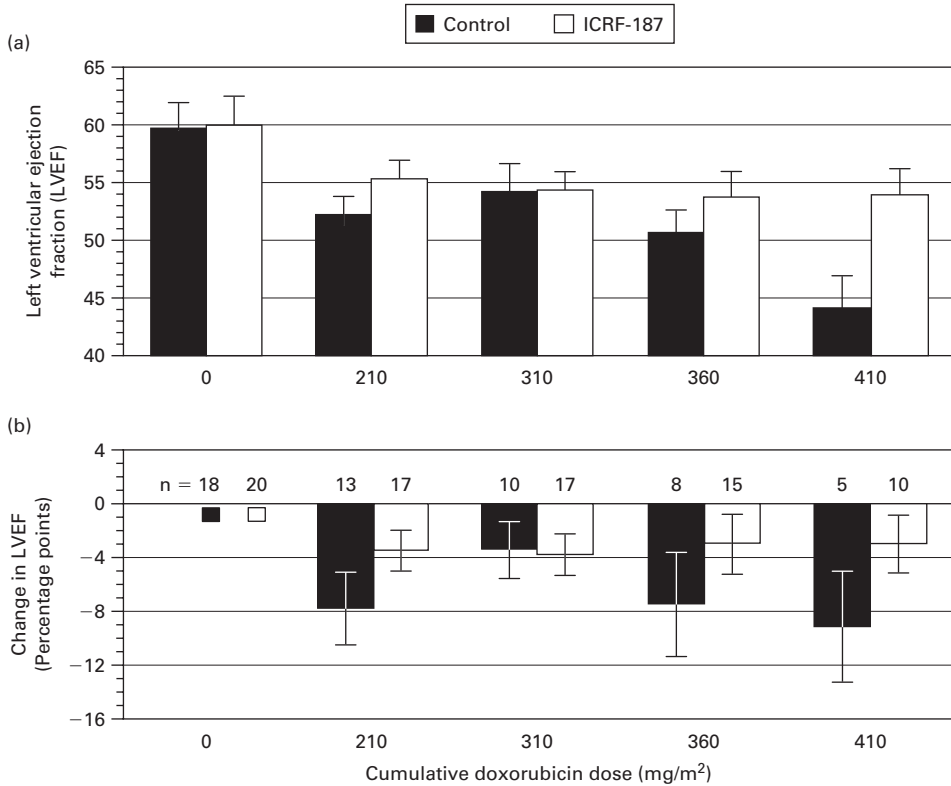
Baseline resting LVEF was 59.6%  $\pm$  2.2% and 59.8%  $\pm$  2.5% for the control and DXN group respectively

(p = 0.78). Only 33 of the 38 assessable patients were assessable for cardiotoxicity analysis; 5 patients developed either progressive cardiac failure (3 control patients) or electively discontinued DXN before the first on therapy MUGA scan at week 24.

The mean decrease in LVEF per 100 mg/m<sup>2</sup> of doxorubicin was 2.7 percentage points in the control group compared to 1 percentage point in the DXN group (p = 0.02). Of the 15 patients (control group 5 and DXN group 10) who received a cumulative dose of 410 mg/m<sup>2</sup> of doxorubicin, the LVEF in the control group was 44%  $\pm$  2.8% compared to 53.9%  $\pm$  2.2% in the DXN group (p = 0.03). Figure 18.4 shows the mean decrease in LVEF in the two groups of patients.

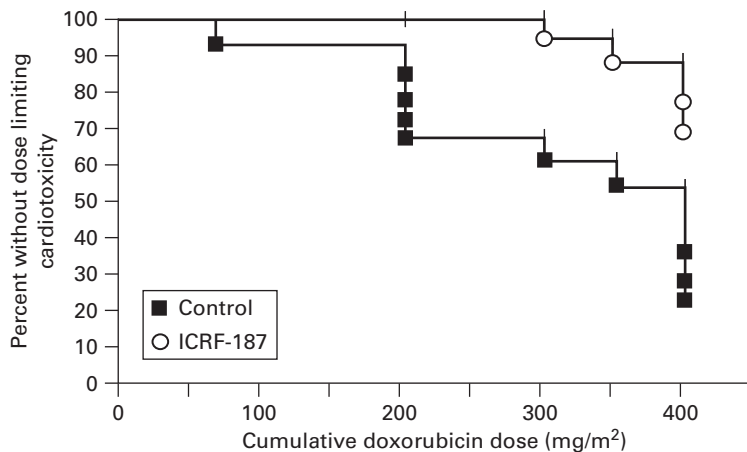
### Dose-limiting cardiotoxicity

The control group developed dose-limiting cardiotoxicity much earlier than the DXN group (Figure 18.5)



**Figure 18.4** LVEF with increasing cumulative dose of doxorubicin according to treatment group. (a) Bars represent the mean ( $\pm$ SEM) LVEF of each group at each cumulative doxorubicin dose. The lower limit was 45%. (b) LVEF following each cumulative doxorubicin dose was subtracted from baseline LVEF for each patient. Bars represent the mean ( $\pm$ SEM) decline from baseline LVEF. Values are expressed as percentage points (e.g. a decrease

in LVEF from 59% to 52% is a 7 percentage point decrease). Numbers above bars represent patients with assessable MUGA scans. One ICRF-187–treated patient did not have a MUGA scan following the 210-mg/m<sup>2</sup> dose, but did have MUGA scans performed following the 310-, 360-, and 410-mg/m<sup>2</sup> doses. © American Society of Clinical Oncology (full reference on p. 542).



**Figure 18.5** Time to development of dose-limiting cardiotoxicity, according to treatment group. Events constituting dose-limiting cardiotoxicity are defined in the methods. © American Society of Clinical Oncology (full reference on p. 542).



( $p < 0.01$ ). The proportion of patients in the control group ( $n = 15$ ) who developed cardiotoxicity after 210, 360 and 410 mg/m<sup>2</sup> of doxorubicin was 5, 7 and 10 compared to 0, 2 and 4 in the DXN group ( $n = 18$ ). The median cumulative dose of doxorubicin in the control group (5 cycles, range 1–7) was 310 mg/m<sup>2</sup> compared to 410 mg/m<sup>2</sup> in the DXN group (7 cycles, range 2–7) ( $p < 0.05$ ). Table 18.4 summarizes the doxorubicin treatment in the two groups of patients. LVEF returned to normal in 3 of the 4 patients who received DXN at the time of the first follow-up MUGA scan compared to none in any of the 7 control patients who had a follow-up MUGA scan ( $p = 0.02$ ).

### Response to chemotherapy and survival

Sixteen control patients and 20 DXN patients were assessable for response at week 12. The objective response rates were comparable in the two groups: 81% in the control group (complete responses 3 and partial responses 10) versus 80% in the DXN group (complete responses 4 and partial responses 12).

EFS and OS are shown in Figure 18.6. The median EFS time was 17 months in both groups; the 2-year EFS rates were 39% (95% CI, 20–61%) and 43% (95% CI, 24–64%) for the control and DXN groups respectively. The median survival times were 24 months for the control group versus 43 months for the

**Table 18.4** Summary of doxorubicin treatment in control and ICRF-187-treated patients.

Doxorubicin Treatment Summary	Control (n = 18)		ICRF-187 (n = 20)	
	No. of Patients	Dose (mg/m <sup>2</sup> )	No. of Patients	Dose (mg/m <sup>2</sup> )
Progressive disease	3	70, 140, 210	1	210
No response to therapy	1	310	1	140
Elective cessation of therapy	1	360	3	210, 360, 360
Dose-limiting cardiotoxicity <sup>h</sup>	10	70 <sup>a</sup> , 210, 210, 210 <sup>b</sup> , 210 <sup>c</sup> , 310, 360 <sup>d</sup> , 410, 410, 410	4	310, 360, 410, 410
False-positive MUGA scan <sup>f</sup>	0		1	310
Received 410 mg/m <sup>2</sup> doxorubicin	8 <sup>e</sup>		12	
MUGA scan after 410-mg/m <sup>2</sup> dose	5		10	
Received 410 mg/m <sup>2</sup> without dose-limiting cardiotoxicity	2		8	
MUGA scan uninterpretable <sup>g</sup>	1	210	0	
Doxorubicin dose <sup>i</sup>				
Median		310		410
Range		70–410		140–410

*Note:* Therapy was discontinued prematurely due to progressive disease or no response to treatment in 3 control and 1 ICRF-187-treated patients before the first scheduled on-therapy MUGA scan (the ICRF-187-treated patient with progressive disease after the 210-mg/m<sup>2</sup> dose did have a followup MUGA scan). One ICRF-187-treated patient electively discontinued therapy following the 210-mg/m<sup>2</sup> dose and did not have a follow-up MUGA scan performed (thus, 15 of 18 control patients of 18 of 20 ICRF-187-treated patients were assessable for cardiotoxicity).

<sup>a</sup>LVEF < 45% retrospectively identified as first occurring after 70 mg/m<sup>2</sup> but treated to 210 mg/m<sup>2</sup>.

<sup>b</sup>LVEF < 45% retrospectively identified as first occurring after 210 mg/m<sup>2</sup> but treated to 260 mg/m<sup>2</sup>.

<sup>c</sup>LVEF decreased > 20 percentage points (78% to 51%) after 210 mg/m<sup>2</sup> but treated to 410 mg/m<sup>2</sup>.

<sup>d</sup>LVEF decreased > 20 percentage points (73% to 46%) after 360 mg/m<sup>2</sup> but treated to 410 mg/m<sup>2</sup>.

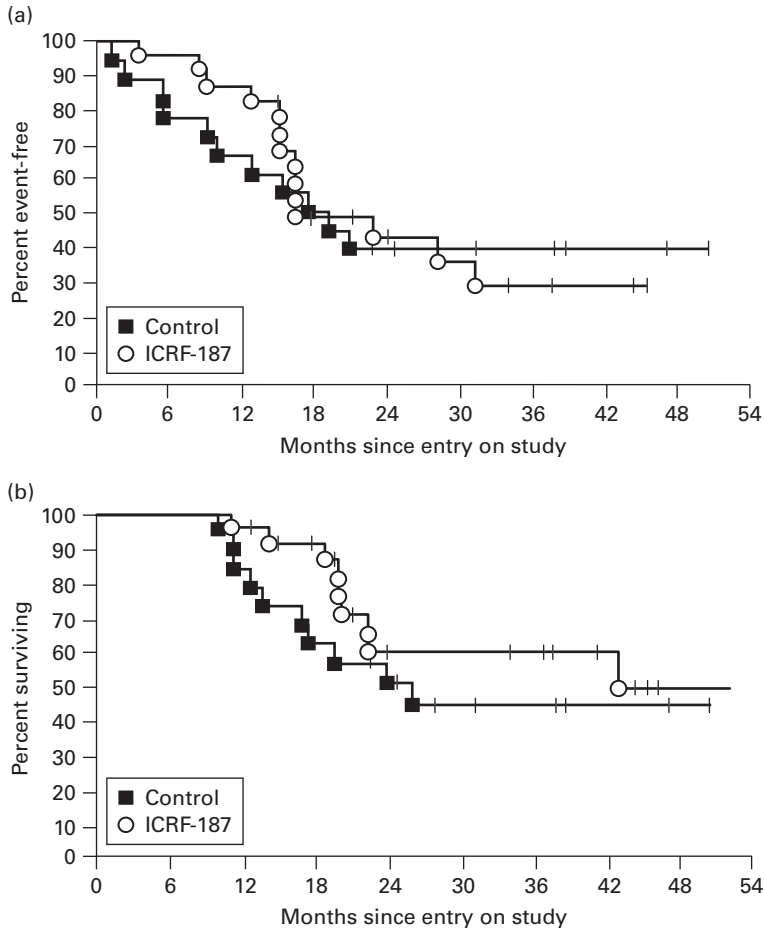
<sup>e</sup>Includes the two patients who continued to receive doxorubicin after the documentation of earlier dose-limiting toxicity. MUGA scan results from studies obtained after the documentation of cardiotoxicity were considered non-assessable and censored.

<sup>f</sup>The preliminary LVEF on this patient's post-310-mg/m<sup>2</sup> dose MUGA scan was 43%, which necessitated premature discontinuation of doxorubicin. Retrospective review revised this figure to 50%.

<sup>g</sup>MUGA scan performed during episode of acute congestive heart failure 10 days after the 210-mg/m<sup>2</sup> doxorubicin dose showed global hypokinesia, but LVEF could not be calculated.

<sup>h</sup> $p < .01$ .

<sup>i</sup> $p < .05$ .



**Figure 18.6** EFS and OS according to treatment group. (a) Median EFS was 17 months in both groups. All events were relapses or diseases progression. The estimated probabilities of EFS at 24 months are 39% (95% CI, 20–61%) in controls and 43% (95% CI, 24–64%) in ICRF-187 patients. (b) Median OS was 24 months (lower limit of 95% CI, 14 months) for the control group versus 43 months (lower limit of 95% CI, 20 months) for the ICRF-187 group. Overall, 44% of the control group (95% CI, 20–68%) are alive versus 61% of the ICRF-187 group (95% CI, 41–81%). © American Society of Clinical Oncology (full reference on p. 542).

DXN group. These differences were not statistically significant.

### Non-cardiac toxicity

All 41 patients were assessable for non-cardiac toxicity as all had at least one cycle of chemotherapy. Transient elevations in AST after the first three cycles of VAdriaC was higher in the DXN group compared to the control group of patients ( $p = 0.001$ ).

DXN group patients had grade 3 or worse thrombocytopenia, after cycle 1 (11/23 versus 3/18;  $p < 0.05$ ), 5 (13/18 versus 2/11;  $p < 0.001$ ) and 6 (9/14 versus 1/9;  $p < 0.001$ ) and significantly lower platelet nadir after cycle 4 ( $42 \times 10^9/l$  versus  $112 \times 10^9/l$ ;  $p < 0.001$ ) and cycle 6 ( $26 \times 10^9/l$  versus  $99 \times 10^9/l$ ;  $p < 0.05$ ) but no significant differences in the ANC nadirs were seen.

No differences were seen between the two groups of patients, in the incidence of dose modifications for hepatic toxicity or hematological toxicities. Similarly no differences were observed in the incidence of mucositis or infections between the two groups of patients.

### Pharmacokinetics

Plasma DXN levels were similar in the four patients who did and in the seven patients who did not, develop dose-limiting cardiotoxicity.

### Conclusion

It was concluded that DXN was cardioprotective and did not adversely affect chemotherapy response or chemotherapy tolerability.

# Study – method of anthracycline administration: continuous infusion versus bolus

## Study 3

Lipshultz SE, Giantris AL, Lipsitz SR, Kimball Dalton V, Asselin BL, Barr RD, Clavell LA, Hurwitz CA, Moghrabi A, Samson Y, Schorin MA, Gelber RD, Sallan SE, Colan SD. Doxorubicin administration by continuous infusion is not cardioprotective: the Dana-Farber 91-01 Acute Lymphoblastic Leukemia protocol. *J Clin Oncol* 2002;**20**:1677–82.

## Study design

This was a prospective randomized multi-center study that was conducted between 1991 and 1996 and included children with high risk childhood lymphoblastic leukemia (ALL, acute lymphoblastic leukemia) enrolled on the Dana Farber Cancer Institute (DFCI) childhood ALL 91-01 protocol. Informed written consent was obtained for all patients enrolled on the study.

## Study details

The details of the DFCI treatment protocol has been published previously.<sup>1</sup> Major changes from previous DFCI protocols included substitution of dexamethasone for prednisolone and prolonged intensive asparaginase administration for 30 weeks. Eligible patients were randomized to receive either continuous (over 48 hours) or bolus infusion (over 1 hour) of doxorubicin (30 mg/m<sup>2</sup>).

## Objectives

The purpose of this study was:

- To compare continuous versus bolus infusion of doxorubicin in children with high risk ALL to determine which of the 2 modes of infusion offered cardioprotection without loss of efficacy.

## Echocardiography (ECHO) investigations

All patients underwent protocol directed ECHO examinations at pre-determined intervals irrespective of

their clinical status and these included measurement of left ventricular (LV) dimensions, thickness, fractional shortening (FS) and calculation of LV mass from M mode measurements by the Devereaux method.<sup>2</sup> DFCI patients also had stress velocity analysis of LV contractility, measurement of afterload as meridional end-systolic LV wall stress and measurement of peak systolic wall stress. All ECHOs were re-measured centrally by one technician and a random sample of 10% was also spot checked by a single echocardiographer for quality assurance.

Only patients who had at least one follow-up ECHO of LV structure and function that was obtained prior to 1st April 1997 were included in the analysis. Patients who were still receiving doxorubicin before their last follow-up ECHO or had their doxorubicin dose reduced due to cardiac related problems were excluded. Similarly, patients who died, relapsed or had discontinued treatment prior to their last follow-up ECHO were also excluded.

The z scores of LV measurements were calculated based on measurements collected from a healthy population. A score of 0 was at the healthy population mean while a score of 2 represented two standard deviations (SD) above the normal mean.

## Statistics

The Wilcoxon signed-rank test was used to test whether a z score was different from zero while the Wilcoxon rank sum test used to test the differences in the z scores according to treatment. The Fisher's exact test compared the proportions of females in both arms. All tests were two sided and p was considered significant at 0.05.

For the main variables (LV FS, end-diastolic dimension, end-systolic dimension, wall thickness and mass) where there were approximately 60 patients/treatment group the study had 80% power to detect 0.5 SD between the post-median z scores using a Wilcoxon rank sum test at a 5% significance level. For other variables in

which there were approximately 30 patients/treatment group, the study had 80% power to detect 1 SD between the post-median z scores.

## Outcome

### Study population

Of the 240 patients enrolled on the DFCI 91-01 protocol, only 145 were considered eligible for this study; 95 patients were excluded for the following reasons: relapse before last follow-up ECHO  $n = 5$ , non-cardiac deaths before last follow up ECHO  $n = 6$ , doxorubicin dose reduction  $n = 46$ , continuing doxorubicin treatment at last follow-up  $n = 5$ , premature discontinuation of doxorubicin  $n = 1$  and ECHO data not submitted for central review  $n = 32$ . A further 24 patients were excluded from analysis because of poor

quality ECHO data. Hence, only 121 patients were considered evaluable and were included for the study analysis; 64 patients were randomized to receive continuous doxorubicin infusion while the remaining 57 received bolus infusion. Doxorubicin dose intensity was similar in both arms. Patient characteristics are shown in Table 18.5.

### ECHO before doxorubicin

ECHO was performed at a median of 2.1 and 2.8 days before commencement of treatment in the bolus and continuous infusion groups respectively. Baseline ECHO results were similar in both groups (Table 18.6). Both groups had abnormal LV structure and function (increased FS and mass) when compared to normal healthy controls.

**Table 18.5** Description of four cardiac risk factors among 121 children treated with doxorubicin.

Patient Characteristic	Bolus Doxorubicin Infusion (n = 64)		Continuous Doxorubicin Infusion (n = 57)		p for Difference
	Median	Range	Median	Range	
Age at diagnosis, years	5.2	0.4–17.9	5.4	0.6–17.6	0.62
Follow-up since completion of therapy, months	17.8	0.0–52	18.4	0.0–56	0.89
Percent female	45.3		42.1		0.86
Cumulative doxorubicin dose, mg/m <sup>2</sup>	336	228–360	340	222–360	0.74

**Table 18.6** LV characteristics of pre-treatment ECHO.

	Bolus Doxorubicin Infusion			Continuous Doxorubicin Infusion			
	No.	Median z Score	p <sup>a</sup>	No.	Median z Score	p <sup>a</sup>	p <sup>b</sup>
FS	45	1.53	<0.001	44	1.54	<0.001	0.99
Diastolic dimension	45	0.21	0.47	44	0.315	0.04	0.39
Systolic dimension	45	-0.47	0.03	44	-0.30	0.12	0.51
Wall thickness	44	0.13	0.80	42	-0.14	0.56	0.79
Mass	44	0.33	0.049	39	0.59	0.003	0.64

<sup>a</sup>Significance of difference from healthy population (in which, by definition, z score = 0).

<sup>b</sup>Significance of difference between the two arms.

**Table 18.7** Cardiac characteristics at post-treatment ECHO.

	Bolus Doxorubicin Infusion			Continuous Doxorubicin Infusion			
	No.	Median z Score	p <sup>a</sup>	No.	Median z Score	p <sup>a</sup>	p <sup>b</sup>
LV FS	62	-0.47	0.008	55	-0.44	0.09	0.60
LV diastolic dimension	62	0.285	0.36	56	-0.015	0.55	0.79
LV systolic dimension	62	0.365	0.01	56	0.345	0.02	0.72
LV wall thickness	62	-0.525	<0.001	56	-0.690	<0.001	0.88
LV mass	59	-0.37	0.006	53	-0.270	0.02	0.50
LV contractility	25	-0.70	0.006	22	-0.765	0.005	0.99
Systolic blood pressure	27	-0.44	0.04	22	-0.095	0.24	0.67
Diastolic blood pressure	27	0.46	0.06	22	0.11	0.52	0.38
End-systolic blood pressure	27	-0.48	0.005	22	-0.795	<0.001	0.70
LV afterload	27	0.33	0.24	22	-0.215	0.89	0.32
LV peak stress	27	0.84	0.007	22	0.92	0.05	0.49
Heart rate	25	0.24	0.17	22	0.465	0.10	0.70

<sup>a</sup>Significance of difference from the normal population (in which, by definition, z score = 0).

<sup>b</sup>Significance of difference between the two arms.

**Table 18.8** Differences between pre-treatment and post-treatment ECHO z scores.

LV Characteristic	Bolus Doxorubicin Infusion			Continuous Doxorubicin Infusion			
	No.	Median z Score Difference	p <sup>a</sup>	No.	Median z Score Difference	p <sup>a</sup>	p <sup>b</sup>
Diastolic dimension	36	-0.12	0.39	37	-0.23	0.06	0.41
Wall thickness	35	-0.32	0.11	35	-0.28	0.09	0.94
Systolic dimension	36	0.85	<0.001	37	0.38	0.04	0.20
FS	37	-2.34	<0.001	37	-1.77	<0.001	0.34
Mass	35	-0.65	<0.001	31	-0.47	0.001	0.98

<sup>a</sup>Test that the median z score is equal to zero for a given treatment.

<sup>b</sup>Test that the median z scores are equal for the two treatments.

### ECHO after doxorubicin

The median time for post-doxorubicin ECHO from ALL diagnosis was 1.5 years. Post-doxorubicin ECHO was also similar in both groups (Tables 18.7 and 18.8). The median LV FS fell significantly by 2 SD ( $p < 0.001$ ) in both groups of patients. Other abnormal ECHO measurements (in both groups) included: a depressed LV contractility, significant increase in the median LV systolic dimension z scores and dilated LV in systole.

Both the bolus and the continuous infusion groups had decreased median LV wall thickness by 0.3 SD

that was significantly below normal. Similarly, the median LV mass z score decreased significantly ( $p < 0.001$ ) by 0.7 SD in the bolus group and by 0.5 SD in the continuous infusion group. LV peak systolic wall stress (elevated when hypertrophy is inadequate) was significantly elevated in both groups.

### Treatment effects

Age at treatment, sex or duration of follow up did not affect differences in the LV characteristics.

### Event-free survival (EFS)

There were no significant differences between the two groups with regard to early treatment failures; 5-year EFS rates was  $89\% \pm 3.9\%$  and  $87.3\% \pm 4.5\%$  for the bolus and continuous infusion groups respectively ( $p = 0.50$ ).

### Conclusion

It was concluded that continuous doxorubicin infusion over 48 hours for children with ALL did not offer any cardioprotective advantage over bolus infusion. Both regimens were associated with significant cardiotoxicity.

### References

- 1 Silverman LB, Gelber RD, Kimbal Dalton V *et al*. Improved outcome for children with acute lymphoblastic leukaemia: Results of the Dana Farber Consortium Protocol 91-01. *Blood* **97**:1211–18, 2001.
- 2 Lipshultz SE, Lipsitz S, Goorin AM *et al*. Female sex and higher drug dose as risk factors for late cardiotoxic effects of doxorubicin therapy for childhood cancer. *N Engl J Med* **332**: 1738–43, 1995.

*This page intentionally left blank*

# Index

- α-fetoprotein (αFP) 116, 120
- ABVD chemotherapy, in Hodgkin's disease
  - alternating with MOPP 199–200, 205–7
  - v MOPP 199–200, 203–5
  - v MOPP plus ABVD 200–1, 208
- A-COP chemotherapy, in NHL 163, 170–1
- A-COPP chemotherapy, in Hodgkin's disease 200–1, 211–12
- actinomycin D
  - in rhabdomyosarcoma 5
  - in Wilms' tumour 66–7, 74–6, 91
  - fractionated v single dose 73–4, 81–4, 88–9
  - see also bleomycin/cyclophosphamide/actinomycin D;  
*vincristine-containing regimens*
- acute lymphoblastic leukaemia (ALL)
  - CNS directed therapy 340–91, 392–9
  - Cancer and Leukaemia Group B trial (CALGB) 356–78
  - Dana Farber Cancer Institute (DFCI) 87-01 and 91-01 protocols 335–9
  - radiotherapy trials 327–34
  - see also under cranial irradiation; intrathecal chemotherapy; craniospinal irradiation
  - continuing (maintenance) therapy 272–4, 400–51
  - dose and route of methotrexate 423–6
  - duration studies see duration of continuing therapy (below)
  - re-induction therapy 413–17
  - schedules of therapy 426–35
  - type of thiopurine 436–7
  - vincristine/prednisolone pulses see vincristine/prednisolone pulses (in ALL)
- duration of continuing therapy 400–18
  - AIEOP trials 410–11
  - Berlin-Frankfurt-Munster (ALL-BFM) trials 417–18
  - Childhood ALL Collaborative Group 378–99, 413–16
  - Children's Cancer Study Group (CCG) studies 403–4, 407–10
  - Medical Research Council (UKALL) trials 400–3, 405–6, 411–13
- European Organisation for Research and Treatment of Cancer (EORTC) trial study 186–7, 187–9
- intensification 270
- remission induction therapy
  - St. Jude's Total Therapy Study XI protocol 279–83
  - Memorial Sloan-Kettering New York protocol II 283–5
  - UK Medical Research Council ALL97 285–95
  - Children's Cancer Group (CCG) trials 295–302, 312–18
  - Tokyo Children's Cancer Study Group (TCCSG) trial L95-14 302–11
  - European Organization for Research and Treatment of Cancer – Children's Leukemia Group (EORTC-CLG) trial 319–23
  - Dutch Leukemia Study Group (DLSCG) 324–6
- T cell (T-ALL) 164, 184–5
- see also lymphoblastic lymphoma
- acute myeloid leukaemia (AML) 223–6
  - induction therapy 223–4, 227–39
    - Berlin–Frankfurt–Munster (BFM) 93 Study 223, 227–9
    - Children's Cancer Group (CCG) trials 223, 229–32, 236–9
    - Medical Research Council (MRC) AML-10 trial 223, 233–6
  - maintenance therapy 225, 236–9, 250
    - Children's Cancer Group Study 254–8
    - LAME 89/91 trial 250–4
  - post remission management 224, 240–9
    - AIEOP Cooperative Group study 240–2
    - Children's Cancer Group (CCG) study 247–9
    - Medical Research Council (MRC) AML-10 study 224, 244–7
    - Pediatric Oncology Group study 242–4
  - secondary 233, 244–5



- acute myeloid leukaemia (*Contd*)  
 in Hodgkin's disease 206, 208–9, 212  
 in NHL 164, 178
- acute promyelocytic leukemia (APL)  
 APL 93 trial 258–61  
 GIEMA-AIEOP AIDA trial 262–6
- ADCOMP chemotherapy, in NHL 164, 177–8
- ADE chemotherapy, in AML 227–9, 233–6
- Adriamycin *see* doxorubicin
- AIDS, transfusion related 136
- AIE chemotherapy, in AML 227–39
- ALL *see* acute lymphoblastic leukaemia
- allergic reactions, in NHL 184–5
- allogeneic bone marrow transplant (Allo BMT),  
 in AML 224, 254  
 AIEOP Cooperative Group study 240–2  
 Children's Cancer Group (CCG) trials 232, 236–8,  
 247–9  
 Medical Research Council (MRC) AML-10 trial 224,  
 233–6, 244–7
- all-trans retinoic acid (ATRA), in APL 258–61
- all-trans retinoic acid with idarubicin (AIDA),  
 in APL 262
- amifostine, in cardioprotection 456
- AML *see* acute myeloid leukaemia
- amphotericin B, in ALL 460, 472, 473, 478, 486, 502
- amsacrine, in AML 240
- anthracycline administration, continuous infusion *v*  
 bolus 548–51
- anthracycline induced cardiac damage 456
- anthracyclines  
 in AML 223  
 in non-lymphoblastic lymphoma 189–91  
*see also* daunorubicin; doxorubicin; idarubicin
- anti-GD2 monoclonal antibody, in neuroblastoma 99
- AOPE chemotherapy, in Hodgkin's disease 200, 209–10
- ARA-C *see* cytosine arabinoside
- ASNase antibodies, ALL 315–16
- asparaginase  
 in ALL 269–70, 279, 303, 312–26, 335, 356–7, 413–7,  
 460, 476, 485, 548  
 in AML 250  
 in NHL 164, 166, 182–5  
*see also* ADCOMP chemotherapy
- aspartic acid, in ALL 316–17
- ATRA syndrome, in AML 259
- astrocytoma  
 anaplastic (AA) 150  
 chemotherapy 152, 153, 156–7, 158–60  
 radiotherapy 157–8  
 surgery 150  
 chemotherapy 153, 160–1  
 surgery 150  
*see also* glioma
- autologous bone marrow transplant (ABMT)  
 in AML 230, 240–9  
 AIEOP Cooperative Group study 240–2  
 Children's Cancer Group (CCG) trial 232, 247–9  
 Medical Research Council (MRC) AML-10 trial 224,  
 233–6, 244–7  
 Pediatric Oncology Group study 242–4  
 in glioma 154  
 in neuroblastoma 93–5, 99, 101–4, 104–6
- autologous hemopoietic stem cell transplantation  
 (AHSCT), in ALL 467–8
- azacytidine, in AML 243
- BAVC chemotherapy, in AML 240
- BCD chemotherapy, in osteosarcoma 29, 30, 33–4, 37–8,  
 41–3
- B cell lymphoma 164, 175–7
- B-cell neoplasms  
 BFM group study 195–8
- BCNU  
 in AML 240  
 in glioma 154  
 in neuroblastoma 129–30
- bleomycin  
 in Hodgkin's disease 200–1, 210–12  
 in malignant germ cell tumour 116, 117, 121  
*see also* ABVD chemotherapy
- bleomycin/cyclophosphamide/actinomycin D (BCD),  
 in osteosarcoma 29, 30, 33–4, 37–8, 41–3
- bleomycin/etoposide/cisplatin (BEP), in malignant germ  
 cell tumour 116
- blood–brain barrier disruption  
 in glioma 154  
 in medulloblastoma 132
- bone marrow  
 aplasia, in AML 228, 239  
 histocompatible sibling donors 224  
 minimal residual disease, in neuroblastoma 98  
 purging, in neuroblastoma 93–4, 98, 101–4  
 suppression *see* myelosuppression  
 transplant (BMT) *see* allogeneic bone marrow  
 transplant; autologous bone marrow transplant
- boys, duration of ALL therapy 400–1, 403, 407
- bradykinin analog, in glioma 154
- brain stem  
 glioma (intrinsic pontine glioma) 150  
 chemotherapy 153, 160–1  
 radiotherapy 151, 157–8  
 medulloblastoma involving 133, 134, 136
- brain tumours 125, 150

- secondary 271  
*see also* astrocytoma; ependymoma; glioma;  
 medulloblastoma
- bronchiolitis obliterans 184
- Burkitt lymphoma 167, 175, 178
- busulphan  
 in AML 230, 233, 243, 246, 247  
 in solid tumors 502
- camptothecins, in neuroblastoma 95
- carboplatin  
 in ALL 504  
 in glioma 153, 154, 161  
 in hepatoblastoma 115  
 in malignant germ cell tumour 116, 117  
 in neuroblastoma 96, 101–4, 108–9
- cardiac toxicity  
 in Ewing's sarcoma 53, 54  
 in hepatoblastoma 119  
 in Hodgkin's disease 201, 205, 206, 212  
 in NHL 171  
 in rhabdomyosarcoma 8  
 in sarcoma  
   left ventricular ejection fraction (LVEF) 543  
   Multiple Gated Acquisition (MUGA) scan 542, 543  
 in Wilms' tumour 80
- cardiac troponin T, in ALL 538, 539–41
- cardioprotection  
 in ALL  
   Dana Farber Cancer Institute (DFCI) 538–42  
   Dana Farber 91-01 Acute Lymphoblastic Leukemia  
   protocol 548–51  
 in sarcoma  
   National Cancer Institute (NCI) protocol 86C169  
   542–7
- carmustine  
 in AML 240  
 in NHL 166
- carvedilol, in cardioprotection 456
- CCNU  
 in medulloblastoma 129–30, 133–4, 144–6  
*see also* CVPP chemotherapy; vincristine/CCNU/  
 prednisone
- CCVP chemotherapy, in Hodgkin's disease 200
- CD30 (KI-1 antigen) 165
- ceftazidime, in ALL 478
- central nervous system (CNS) directed therapy 271–2  
 in ALL 327–91  
 in AML 230, 236, 240, 244–6  
 in NHL 185–6  
*see also* cranial irradiation; craniospinal irradiation;  
 intrathecal chemotherapy
- central nervous system (CNS) tumours *see* brain tumours
- chemoembolisation, in hepatoblastoma 116
- chemotherapy  
 in APL 258  
 in glioma 151–3  
 high-dose  
   in AML 224  
   in glioma 153–4  
   in malignant germ cell tumour 115–16  
   in neuroblastoma 93–5, 101–4  
 in Hodgkin's disease 214–15  
 intrathecal *see* intrathecal chemotherapy  
 in medulloblastoma 126, 148  
 radiation sensitising, in glioma 154  
 “sandwich”, in medulloblastoma 129, 134–6, 139–40,  
 144–6  
 in sarcoma, doxorubicin treated 543, 544  
*see also* specific cytotoxic agents and regimens
- chemotherapy dose intensity (CDI)  
 in GCSF 466–71  
 in Ewing's sarcoma 60–1
- CHOP chemotherapy, in NHL 163, 181
- chromosomal translocations, in Ewing's sarcoma 50
- cisplatin  
 in glioma 157–8  
 in hepatoblastoma 115–16, 118–20  
 in malignant germ cell tumour 116–17, 121  
 in medulloblastoma 129, 144–6  
 in neuroblastoma 98, 101–4, 104–6, 113, 527  
   continuous *v* bolus infusion 98, 109–10  
   plus teniposide 96, 108  
 in osteosarcoma 29, 30, 31–3, 37–8, 46  
   intra-arterial delivery 31, 32, 39–40  
 in rhabdomyosarcoma 4, 12–14
- cisplatin/doxorubicin (PLADO)  
 in hepatoblastoma 115–16, 118–20  
 in osteosarcoma 27  
   *v* BCD regimen 41–3  
   intensified delivery 27, 40–1  
   *v* methotrexate-based regimens 27, 35–7  
   T10 protocol 27, 43
- cisplatin/doxorubicin/carboplatin (super PLADO),  
 in hepatoblastoma 116
- cisplatin/etoposide/vindesine (N5), in neuroblastoma 113
- cisplatin/vinblastine/bleomycin, in malignant germ cell  
 tumour 116
- citrovorum factor rescue 31
- CNS prophylaxis *see* central nervous system directed therapy
- colistin, in neutropenia 512
- COMP chemotherapy  
 in NHL 162–3, 166–70, 171–2  
*see also* ADCOMP chemotherapy

- consent, refusal of 163
- COP chemotherapy, in NHL 164, 176
- COPAdm chemotherapy, in NHL 164, 176
- conventionally fractionated radiotherapy (CF-RT),  
in ALL 335–9
- corticosteroids, in ALL 303, 466
- CPT-11, in glioma 154
- cranial irradiation  
in ALL 271  
Berlin–Frankfurt–Munster (BFM)/Dana-Farber  
Cancer Institute (DFCI) studies 357–9  
Berlin–Frankfurt–Munster (BFM) studies 332–3,  
377–8  
Brazilian Group study 331–2  
Cancer and Leukaemia Group B (CALGB) trials  
356–7, **358**, 362–5  
Children’s Cancer Study Group (CCG) studies  
327–9, 344–9, 359–62, 365–73  
CLCG-EORTC trial 374–5  
GDR Haematology and Oncology Working Group  
study 355–6  
Japanese Children’s Cancer and Leukaemia Study  
Group 376  
Medical Research Council trial 330–1  
Ortego *et al* study 350–1  
Southwest (Pediatric) Oncology Group studies  
340–1, 341–4, 352–5  
Tokyo Children’s Cancer Group study 334  
in AML 228  
long-term effects 271  
in NHL 167, 170, 172, 185–6  
*see also* craniospinal irradiation
- craniospinal irradiation  
in ALL 327–9, 335–9, 345–8  
in AML 233, 244  
long-term effects 130  
in medulloblastoma 126–7, 130, 133–4, 146–7  
plus other chemotherapy regimens 136–7, 137–9,  
139–40, 142–3  
reduced dose 134–6, 141–2  
“sandwich” schedules 129, 134–6, 139–40  
*see also* cranial irradiation
- CVPP chemotherapy, in Hodgkin’s disease 200, 207,  
209–10
- cyclophosphamide  
in ALL 279  
in AML 502  
BMT conditioning 243, 246, 247  
induction therapy 228, 230, 233, 238  
in Ewing’s sarcoma 49, 50, 60–1, 518, 543  
in glioma 154  
in medulloblastoma 142, **143**  
in neuroblastoma 101–4, 104–6, 109–10, 113,  
504, 527  
in NHL 164, 165, 170–1, 174, 185–6, 192, 495  
in osteosarcoma 31–3, 34–5  
in rhabdomyosarcoma 9–11  
in Wilms’ tumour 77–80, 86–8  
*see also* bleomycin/cyclophosphamide/actinomycin D;  
COMP chemotherapy; LSA2-L2 chemotherapy;  
“Total B” chemotherapy regimen; *vincristine-  
containing regimens*
- cyclophosphamide/doxorubicin, in neuroblastoma  
95–6, 108
- cyclophosphamide/doxorubicin/vincristine (CADO),  
in neuroblastoma 109–10
- CYM chemotherapy regimen 164, 175–7
- cytarabine *see* cytosine arabinoside
- cytogenetic analysis 270–1
- cytosine arabinoside (ARA-C, cytarabine)  
in ALL 279  
in AML 250, 254, 255  
ABMT conditioning 241  
induction therapy 223, 224, 227–9, 236–9  
intrathecal delivery 230, 240, 243, 245–6  
post remission consolidation therapy 224  
in APL 263  
in glioma 153  
in medulloblastoma 144–6  
in NHL 164, 166, 178–80, 181  
*see also* ADE chemotherapy; DAT chemotherapy;  
DCTER chemotherapy; LSA2-L2 chemotherapy;  
triple intrathecal therapy
- dacarbazine  
in ALL 504  
*see also* ABVD chemotherapy
- dactinomycin *see* actinomycin D
- DAT chemotherapy, in AML 233–6, 240–1, 242
- daunomycin  
in NHL 166  
*see also* LSA2-L2 chemotherapy
- daunorubicin (DNR)  
in ALL 466, 476, 487  
in AML 223, 227–9, 236–9, 254, 255  
in NHL 164, 166–8, 177–8  
*see also* ADE chemotherapy; DAT chemotherapy;  
DCTER chemotherapy; LSA2-L2  
chemotherapy
- DCTER chemotherapy, in AML 223, 229–33
- dexamethasone  
in ALL 283–5, 295, 303, 356–7, 466  
in AML 223, 236, 255  
*see also* DCTER chemotherapy

- dexrazoxane (DXN)  
 in ALL 538–42  
 in sarcoma 542–7
- differentiating agents, in neuroblastoma 97–8, 101–4, 110–11
- doxorubicin (Adriamycin)  
 in ALL 303, 335, 527, 538–42,  
 in AML 228  
 in Ewing's sarcoma 49, 51–3, 53–5, 60, 62  
 in hepatoblastoma 115, 116  
 in Hodgkin's disease 200–1, 209, 210–12  
 in MGMT 121  
 in neuroblastoma 95–6, 101–4, 109–10, 113  
 in NHL 164, 170–1, 174, 185–6, 192  
 in osteosarcoma 29, 31–3, 34–5, 39–40, 46  
 intra-arterial delivery 33–4  
 in rhabdomyosarcoma 7–9, 9–11, 12–14, 14–16  
 in sarcoma  
 doxorubicin treated 542–47  
*see also* ABVD chemotherapy; cisplatin/doxorubicin;  
 cyclophosphamide/doxorubicin; *vincristine-*  
*containing regimens*
- doxorubicin/vincristine/prednisolone/l-  
 asparaginase/methotrexate/intrathecal cytarabine,  
 in ALL 335
- drug resistance, in neuroblastoma 95–6
- DTIC, in soft tissue sarcoma 19–20
- economic evaluation, GCSF 488–90  
 in ALL 488–90  
 in autologous peripheral blood progenitor cell (PBPC)  
 transplantation 501–4
- echocardiography (ECHO) investigation  
 in ALL 548  
 before doxorubicin 549  
 after doxorubicin 550
- 8-in-1 regimen  
 in glioma 152, 156–7  
 in medulloblastoma 129, 139–40
- encephalitis, viral 427
- encephalopathy, in ALL 357
- endocrine problems, secondary 130
- ependymoma  
 Children's Cancer Group/Radiation Therapy  
 Oncology (CCSG–RTOG) study 137–9  
 International Society of Paediatric Oncology (SIOP)  
 studies 127–8, 133–4  
 Pediatric Oncology Group studies 140–1, 161  
 Southwest Oncology Group study 143–4
- epidriamycin, in Wilms' tumour 67
- epipodophyllotoxins, in neuroblastoma 95
- epirubicin, in neuroblastoma 96, 108–9
- epoetin alfa, in chemotherapy-related anaemia 533–5
- Erwinia* asparaginase  
 in ALL 319, 324  
 in lymphoid malignancies 187–9
- Erwinia chrysanthemi*, in ALL 269
- Erbix, in glioma 154
- Escherichia coli* asparaginase  
 in ALL 312, 319, 324  
 in lymphoid malignancies 187–9
- etoposide (VP-16)  
 in ALL 279, 466, 476, 487, 504  
 in AML 250, 255  
 BMT conditioning 240–2, 242–4  
 induction therapy 223, 224, 227–9, 233–6, 244  
 in APL 263  
 in Ewing's sarcoma 49, 59–60, 62  
 in glioma 153, 154, 160–1  
 in Hodgkin's disease 200, 209–10  
 in medulloblastoma 144–6  
 in neuroblastoma 96, 98–9, 101–4, 109–10, 527  
 in osteosarcoma 27–8  
 in rhabdomyosarcoma 3–4, 12–14, 17–18  
*see also* DCTER chemotherapy
- erythropoietin (EPO), in neuroblastoma 527  
 St. Jude's Children's Research Hospital study, NB 91  
 protocol 527–30
- Ewing's sarcoma 49–60  
 American Children's Cancer Group and Paediatric  
 Oncology Group 63–5  
 Children's Cancer Group and Paediatric Oncology Group  
 study 62–3  
 CCG-7942 study 50  
 EUROEWING'S study 50  
 European Intergroup Collaborative Ewing's Sarcoma  
 Study Group (EICESS) 50  
 German Cooperative Ewing Sarcoma Study (CESS)  
 50, 55–7  
 Intergroup Ewing's Sarcoma Study 1 (IESS1) 49, 51–3  
 Intergroup Ewing's Sarcoma Study 2 (IESS2) 49, 53–5  
 Intergroup Ewing's Sarcoma Study 3 (IESS3, CCG  
 Intergroup) 50, 59  
 Pediatric Oncology Group study 49–50, 57–9  
 St. Jude Children's Research Hospital 60–61
- febrile neutropenia (FBN) 485, 486  
 Children's Oncology Group study 508–11  
 in NHL 496–7
- 5-fluorouracil (5FU), in hepatoblastoma 115, 118–20
- folinic acid (FA) rescue 135, 136, 363, 423
- ganglioglioma, anaplastic 152, 156–7
- gastrointestinal toxicity  
 in AML 249  
 in medulloblastoma 139–40

- gastrointestinal toxicity (*Contd*)  
 in NHL 185–6  
 in Wilms' tumour 85–6
- G-CSF *see* granulocyte colony stimulating factor
- gene rearrangements  
 in Ewing's sarcoma 50  
 in NHL 185–6
- germ cell tumour, malignant 115, 116–7
- girls, duration of ALL therapy 274, 401, 403, 407
- glioblastoma multiforme (GBM) 150  
 chemotherapy 140–1, 151–3, 156–7, 158–60  
 radiotherapy 157–8  
 surgery 150–1
- glioma 150–61  
 chemotherapy 151–3  
 Children's Cancer Group (CCG) studies 150–4, 156–7, 158–9  
 future studies 153–5  
 North American Brain Tumour Consortium 153  
 Pediatric Oncology Group (POG) studies 151, 153, 157–8, 161  
 radiation therapy 151  
 surgery 150–1
- glucocorticoid receptors, in ALL 268
- glutamine and glutamic acid, in ALL 316–17
- granulocyte colony stimulating factor (GCSF)  
 in ALL 459, 484, 486, 491, 499  
 Children's Cancer Group Study 459–66  
 FRALLE 93 trial 466–71  
 Total Therapy Study XIII A 476–81  
 Pediatric oncology group study No.9398 482–4  
 Medical Research Council (MRC) UKALL XI trial 484–6, 486–8  
 Berlin-Frankfurt-Munster study group 491–4  
 Associazione Italiana di Ematologia Oncologia Paediatrica (AIEOP) protocol 499–501  
 in AML 230, 247  
 in neuroblastoma 101, 109  
 in non-Hodgkin's lymphoma (NHL) 486, 494  
 Medical Research Council (MRC) UKALL XI trial 486–8  
 French Society of Pediatric Oncology study 494–8  
 Japanese Cooperative Study Group protocol 504–8  
 in osteosarcoma 28
- granulocyte-macrophage colony stimulating factor (GMCSF)  
 in chemotherapy-induced neutropenia 512–14, 514–18  
 German Pediatric Oncology/Hematology Group protocols 524–6
- granulocytic sarcoma 227, 242
- growth hormone deficiency 130
- haematological toxicity  
 in ALL 341, 437  
 in AML 236  
 in febrile neutropenia (FBN) 479, 486, 488  
 in Hodgkin's disease 216  
 in medulloblastoma 139  
 in metastatic rhabdomyosarcoma 21–2  
 in NHL 162, 168, 171  
 GMCSF role 518–24  
*see also* infections; neutropenia; sepsis
- HAM chemotherapy, in AML 227
- hematopoiesis, in neuroblastoma 527
- hemopoietic colony stimulating factors  
 erythropoietin (EPO) 527  
 granulocyte colony stimulating factor (GCSF) 459  
 granulocyte-macrophage colony stimulating factor (GMCSF) 512
- hearing loss *see* ototoxicity
- hepatic toxicity  
 in AML 249, 250  
 in neuroblastoma 102–3, 115  
 in NHL 185  
 in sarcoma 543  
 in Wilms' tumour 86
- hepatoblastoma (HBL) 115–16  
 Children's Cancer Group (CCG) trial 115, 118–19  
 SIOPEL studies 115–16
- hepatocellular carcinoma (HCC)  
 Paediatric Oncology Group/Children's Cancer Study Group 120–1
- herceptin 28
- herpes zoster infection 137, 208–9  
*see also* varicella zoster infection
- high-dose methylprednisolone (HDMP), in ALL 279
- histiocytic lymphoma 167
- Hodgkin's disease 199–225  
 ABVEPC 201  
 Buenos Aires Group study (Sackmann-Muriel *et al*) 200, 209–10  
 Children's Cancer Group (CCG) studies 199–200, 203–5  
 Children's Oncology Group study 215–17  
 Cochrane review 214  
 COGAHODOO31 trial 201  
 Cramer & Andrieu study (France) 200, 207  
 French Society of Paediatric Oncology (Oberlin *et al*) 98, 208, 209  
 Gehan *et al* Intergroup study 201, 212–14  
 long term sequelae 199–200  
 Sullivan *et al* study (Pediatric Oncology Group) 200–1, 210–12  
 Tata Memorial Hospital 217

- Weiner *et al* study (Pediatric Oncology Group) 200, 205–7
- hydrocortisone  
in medulloblastoma 127, 144  
*see also* triple intrathecal therapy
- hydroxyurea 166  
*see also* LSA2-L2 chemotherapy
- hyperfractionated radiotherapy, IRS-IV 22  
in ALL 335–9
- ICRF-187 542–7  
doxorubicin-treated sarcoma patients 542, 546
- <sup>131</sup>I-metaiodobenzylguanidine (<sup>131</sup>I MIBG), in neuroblastoma 95
- idarubicin  
in AML 227–9  
in APL 263
- ifosfamide  
in Ewing's sarcoma 49, 50, 59, 60  
in glioma 153–4  
in medulloblastoma 144–6  
in neuroblastoma 95, 96, 101–4, 108–9  
in osteosarcoma 28, 46  
in rhabdomyosarcoma 4, 17–18
- ifosfamide with mesna and etoposide (IE)  
in Ewing's sarcoma 518  
in metastatic rhabdomyosarcoma 20–2  
in sarcoma, doxorubicin treated 543
- ifosfamide/vincristine/doxorubicin (IVAd), in malignant germ cell tumour 116
- immunotherapy, in osteosarcoma 28
- infections  
in ALL 427, 460, 462, 476  
in AML 229  
in hepatoblastoma 119  
in Hodgkin's disease 210  
in NHL 171, 184–5  
*see also* sepsis; specific infections
- infertility, in Hodgkin's disease 200
- intellectual (IQ) deficit  
in ALL 351, 365  
in medulloblastoma 130
- interferon, in osteosarcoma 28, 29, 30
- interferon alfa, in neuroblastoma 113, 527
- intra-arterial drug delivery, in osteosarcoma 28, 31, 33–4, 39–40
- intrathecal chemotherapy  
in ALL 341–4, 350–1  
in AML 232, 240, 242, 244–5  
in medulloblastoma 127, 143–4  
triple agent *see* triple intrathecal therapy  
*see also* intrathecal methotrexate
- intrathecal cytarabine (IT ARA-C), in ALL 335
- intrathecal methotrexate (IT MTX)  
in ALL 271–2, 279, 319, 335, 460, 485, 515  
Berlin–Frankfurt–Munster (BFM) studies 377–8  
Cancer and Leukaemia Group B (CALGB) trials 356–7, 362–5  
Children's Cancer Study Group (CCG) studies 344–5, 359–62, 370–4  
CLCG-EORTC trial 374–5  
GDR Haematology and Oncology Working Group study 355–6  
Ortega *et al* study 350–1  
in radiotherapy trials 327–31, 332–3  
South West (Pediatric) Oncology Group studies 341–4, 352–5  
in medulloblastoma 127, 142, 143, 144  
in T-NHL 485  
*see also* triple intrathecal therapy
- ipropilatin  
in glioma 153, 161  
in neuroblastoma 96, 108–9
- irinotecan, in glioma 154
- irinotecan (CPT11) with vincristine, in Rhabdomyosarcoma (RMS) 5
- JEB regimen, in malignant germ cell tumour 116
- Kl-1 antigen (CD30) 165
- large cell lymphoma 163, 182, 183  
anaplastic 165  
APO regimen 193, 194  
Paediatric Oncology Group Phase III trial 193–4
- leucopenia 153
- Leukovorin, in B-cell neoplasms 195
- leukaemia  
acute lymphoblastic *see* acute lymphoblastic leukaemia  
acute myeloid *see* acute myeloid leukaemia  
T cell 163, 164, 172–4, 182–5
- leukencephalopathy  
in ALL 373  
in medulloblastoma 127, 136, 146
- liver metastases, in Wilms' tumour 78–9
- liver toxicity *see* hepatic toxicity
- LMB 86 chemotherapy, in NHL 175–7
- lomustine  
in medulloblastoma 131  
in glioma 153
- loss of heterozygosity, in Wilms' tumour 67
- LSA2-L2 chemotherapy, in NHL 163–4, 171  
v A-COP regimen 164, 170–1  
v ADCOMP regimen 164, 177–8  
v COMP regimen 162, 166–8, 169–70

- lung irradiation  
 in Ewing's sarcoma 49–50, 51–3  
 in osteosarcoma 34–5  
 in Wilms' tumour 77
- lung metastases  
 in Ewing's sarcoma 49  
 in osteosarcoma 28
- lymphoblastic lymphoma 163, 164, 165  
 Children's Cancer Study Group (CCSG) studies 166–8,  
 171, 172, 177–8  
 EORTC 5888 trial study 186–7  
 EORTC 58881 trial study 187–9  
 Pediatric Oncology Group (POG) studies 170–1,  
 174–5, 180–2, 182–5  
*see also acute lymphoblastic leukaemia*
- lymphoma  
 B cell 164, 175–7  
 Burkitt 167, 175, 178  
 histiocytic 167  
 large cell 163, 165, **183**  
 lymphoblastic *see* lymphoblastic lymphoma  
 non-Hodgkin's *see* non-Hodgkin's lymphoma  
 small non-cleaved cell 163, 175, 178, 182  
 T cell 129, 164, 172–4  
*see also Hodgkin's disease*
- malignant germ cell tumour (MGCT) 115, 116–17  
 Paediatric Oncology Group 3049 and Children's Cancer  
 Group 8882 121–4
- mannitol, in glioma 153, 160
- mediastinal irradiation  
 in NHL 163–4, 172–4  
 in Wilms' tumour 77
- medulloblastoma 125–49  
 Chang staging system 125  
 chemotherapy 126  
 Children's Cancer Group (CCG) studies 127, 128,  
 129–30, 139–40, 160–1  
 Children's Cancer Group/Pediatric Oncology Group  
 study 130, 141–2  
 Children's Cancer Group/Radiation Therapy  
 Oncology Group (CCCG-RTOG) study 127,  
 128, 137–9  
 future research issues 131–2  
 German GPOH group study 129, 144–6  
 International Society of Paediatric Oncology (SIOP)  
 trials 127, 130–1, 133–6  
 Padova Group study 142, **143**  
 Pediatric Oncology Group studies 129–30, 161  
 prognostic factors 125  
 radiotherapy *see* radiotherapy (RT), in  
 medulloblastoma  
 randomized clinical trials 127–31  
 Southwest Oncology Study Group 127, 143  
 surgery 125–6
- methylphalan  
 in neuroblastoma 93–4, 101–4, 104–5, 110–11  
 in rhabdomyosarcoma 4  
 in solid tumors 502
- 6-mercaptopurine  
 in ALL 295  
 in AML 250  
 in APL 263
- 6-mercaptopurine (6 MP) *v* 6-thioguanine, in ALL  
 6-mercaptopurine/methotrexate continuing therapy  
 in ALL 272  
 duration studies 403–6, 408–13, 417–18  
 varying methotrexate doses and routes 423–5  
 varying schedules of therapy 426–31  
 vincristine/prednisolone pulse therapy *see* vin-  
 cristine/prednisolone pulses  
 in NHL 170–1, 174, 182
- methotrexate (MTX)  
 in ALL 279, 423–5, 466, 476, 482, 499  
 continuing therapy *see* 6-mercaptopurine/  
 methotrexate continuing therapy, in ALL  
 high dose intravenous 429–32  
 intermediate dose intravenous 355–6, 357–9,  
 362–5, 377–8  
 intramuscular 423–4  
 in B-cell neoplasm 195  
 in Ewing's sarcoma 531  
 intrathecal *see* intrathecal methotrexate; triple  
 intrathecal therapy  
 in large cell lymphoma 193, 194  
 in medulloblastoma 134–6, 144–6  
 in NHL 165, 170–1, 174, 182, 185–6  
 in osteosarcoma 28, 46  
 EOI studies 27, 35–7  
 EORTC study 27, 34–5  
 German COSS study 29, **30**, 39–40  
 Instituto Rizzoli study 37–8  
*v* intra-arterial cisplatin 31, **32**  
 Mayo Clinic study 29  
 Paediatric Oncology Group (POG) study 31–3  
 T10 protocol 27, 33–4  
*see also* COMP chemotherapy; LSA2-L2  
 chemotherapy; 6-mercaptopurine/methotrexate  
 continuing therapy; "Total B" chemotherapy  
 regimen  
 in T-cell leukemia 482
- methotrexate/6 mercaptopurine, in ALL 482
- methylprednisolone, in ALL 269
- <sup>131</sup>I-MIBG therapy, in neuroblastoma 99, 110–11

- mitoxantrone (MTZN)  
 in AML 224, 227–9, 250  
 in APL 263
- molecular genetics 270
- MOPP chemotherapy  
 in Hodgkin's disease 199–201, 207, 208–9  
 plus ABVD with total nodal irradiation 200, 205–7  
 plus ABVD *v* ABVD plus radiotherapy 199–200, 203–5  
 plus bleomycin 200–1, 210–12  
 plus involved field *v* extended radiotherapy 201, 212–14  
 in medulloblastoma 128, 136–7, 140–1
- MTTPE immunotherapy, in osteosarcoma 28
- mucositis, in NHL 185–6
- muramyl tripeptide (MTP), in osteosarcoma 46–8
- mustine *see* nitrogen mustard
- MYCN (*NMYC*) gene amplification 94–5, 101, 102
- myeloablative therapy  
 in neuroblastoma 95, 113
- myelodysplastic syndrome (MDS) 227, 233, 244–5
- myelosuppression  
 in ALL 491–4, 499–501  
 in AML 229, 233  
 in glioma 157  
 in hepatoblastoma 118–20  
 in medulloblastoma 140–1  
 in NHL 185
- N5 chemotherapy, in neuroblastoma 113
- nephrotoxicity *see* renal toxicity
- neuraxial irradiation *see* craniospinal irradiation
- neuroblastoma 93–114  
 acute and late effects of therapy 98–9  
 Children's Cancer Group (CCG) studies 93–4, 94–5, 96–7, 98, 101–4  
 Children's Oncology Group (COG) study 98, 99  
 dose intensification 93–5  
 European Neuroblastoma Study Group (ENSG) 94, 96, 99, 104–6, 110–11  
 French Society of Paediatric Oncology study 98–9, 109–10  
 future research needs 99  
 German Society of Paediatric Oncology and Hematology 111–13  
 local control 96–7  
 minimal residual disease 97–8  
 newer cytotoxic agents 95–6  
 Pediatric Oncology Group (POG) studies 93–4, 97, 106–8
- neuropsychological sequelae, cranial irradiation 351, 365
- St. Jude's Children's Research study 113–14
- neurotoxicity  
 in glioma 157  
 in Wilms' tumour 85–6
- neutropenia  
 in ALL 516  
 in AML 228, 229  
 in Ewing's sarcoma 520  
 in glioma 161  
 in Hodgkin's disease 205  
 in neuroblastoma 110  
 in NHL 174–5  
 in solid tumor malignancies 513–14  
 in Wilms' tumour 85–6  
*see also* haematological toxicity; infections; sepsis
- NHL *see* non-Hodgkin's lymphoma
- nitrogen mustard (mustine)  
 in medulloblastoma 129, 136–7, 140–1  
*see also* MOPP chemotherapy
- N6 chemotherapy, in neuroblastoma 113
- non-Hodgkin's lymphoma (NHL) 162–98  
 Children's Cancer Study Group (CCSG) studies 162–3, 166–70, 136–7, 177–8  
 French Paediatric Oncology Society (SFOP) study 175–7  
 localised 162–3, 165  
 LSA2-L2 *v* COMP chemotherapy 167, 168, 169–70  
 omission of involved field radiotherapy 174–5  
 short 9 week chemotherapy regimen 180–2  
 shortened duration of therapy 171–2  
 lymphoblastic *see* lymphoblastic lymphoma  
 Pediatric Oncology Group (POG) studies 162–5  
 St Jude Children's Research Hospital study 185–6  
 secondary, in Hodgkin's disease 206–7  
 UK Children's Cancer Study Group (UKCCSG) study 163–4, 172–4
- non-lymphoblastic lymphoma  
 Children's Cancer Group study 189–91  
 Paediatric Oncology Group study 191–3
- non-metastatic medulloblastoma  
 International Society for Pediatric Oncology/United Kingdom Children's Cancer Study Group PNET-3 147–9
- non-metastatic osteosarcoma  
 Paediatric Oncology Group Study POG-8651 45–6
- NY I and NY II chemotherapy regimen, in ALL 459, 461
- oligodendroglioma, anaplastic 150, 152, 156–7
- OPEC chemotherapy, in neuroblastoma 104–6, 110–11



- OPP chemotherapy, in medulloblastoma 129, 140–1  
 osteosarcoma 26–48  
   CCG and POG 46–8  
   Children's Cancer Group (CCG) study 27–8  
   EORTC study 27, 34–5  
   European Osteosarcoma Intergroup (EOI) studies 27, 35–7, 40–1  
   German COSS group studies 27, 29, 30, 39–40, 41–3  
   Italian Institute Rizzoli group study 27, 37–8  
   Mayo Clinic study 26–7, 29–31  
   MD Anderson Hospital study 31, 32  
   Memorial Sloan-Kettering Hospital studies 26–7, 43–4  
   Multi Institutional Study (MIOS) 27  
   Pediatric Oncology Group study 31–3  
   Rosen T10 protocol 26–8, 33–4, 43–4  
   UCLA study 27, 33–4
- Ototoxicity  
   in hepatoblastoma 115–6  
   in malignant germ cell tumour 116, 117  
   in medulloblastoma 140  
   in neuroblastoma 98–9, 109–10
- pancreatitis  
   in ALL 300–2, 308  
   in NHL 185
- paraparesis, transient 351
- PCV chemotherapy *see* procarbazine/CCNU/vincristine
- PEG asparaginase *see also* polyethylene glycol conjugated asparaginase (pegaspargase), in ALL
- peripheral stem cell transplantation (PBSCT), in ALL 504
- pirarubicin, in ALL 504
- platinum compounds  
   in glioma 153, 161  
   in neuroblastoma 94–6  
   *see also* carboplatin; cisplatin; iproplatin
- PNET *see* primitive neuroectodermal tumour
- Pneumocystis carinii* (PCP) infection 468, 478, 485, 487, 492, 499  
   co-trimoxazole 485, 502  
   nystatin 492
- pneumonia  
   in ALL 409  
   in medulloblastoma 140
- pneumonitis  
   in medulloblastoma 140–1  
   in neuroblastoma 102–3  
   in NHL 186  
   in Wilms' tumour 81
- polyethylene glycol conjugated asparaginase (pegaspargase),  
   in ALL 312
- polymerase chain reaction (PCR), in neuroblastoma 98
- pontine glioma, intrinsic *see* brain stem, glioma
- prednisolone/prednisone  
   in ALL 285, 295, 302, 356–7, 432, 460, 466, 476, 485, 541  
   *see also* vincristine/prednisolone pulses (in ALL)  
   in AML 228, 241  
   in Hodgkin's disease 199, 200, 209–10  
   in NHL 170–1, 174, 185–6, 192, 495  
   *see also* COMP chemotherapy, CVPP chemotherapy; MOPP chemotherapy; OPP chemotherapy; vincristine/CCNU/prednisone; vincristine/prednisolone pulses
- primitive neuroectodermal tumour (PNET) 153, 154, 160–1  
   supratentorial 125, 129, 131–2, 139–40
- probuticol, in cardioprotection 456
- procarbazine  
   in glioma 158–60  
   in medulloblastoma 134–6  
   *see also* CVPP chemotherapy; MOPP chemotherapy; OPP chemotherapy
- procarbazine/CCNU/vincristine (PCV), in glioma 152, 156–7
- proctitis 57
- pulmonary toxicity, in Hodgkin's disease 205
- PVB regimen, in malignant germ cell tumour 116
- R115777 (Zarnestra), in glioma 154
- radiation sensitisers, in glioma 154
- radiotherapy (RT)  
   in ALL 327–34  
   cranial *see* cranial irradiation  
   craniospinal *see* craniospinal irradiation  
   in Ewing's sarcoma 49–50  
   field *v* whole bone 49–50, 57–9  
   hyperfractionation 49, 55–7  
   in glioma 151–2  
   with chemotherapy regimens 152, 156–7, 158–60  
   hyperfractionation 151–2, 157–8  
   in Hodgkin's disease  
   after CCVP *v* AOPE 200, 209–10  
   Cochrane review 214  
   involved *v* extended field plus MOPP 200–1, 212–14  
   mantle *v* involved field 200, 207  
   plus ABVD chemotherapy 200–1, 203–5  
   plus alternating MOPP and ABVD 200–1, 205–7  
   reduced dose 200, 208–9  
   in medulloblastoma 126, 131  
   *see also* craniospinal irradiation, in medulloblastoma  
   in neuroblastoma 96–7, 98–9, 106–7  
   in NHL 185–6  
   with A-COP chemotherapy 162, 170–1  
   in COMP *v* LSA2-L2 study 166

- omission in localised disease 163, 174–5
- in T cell leukaemia/lymphoma 163–4, 172–5
- in osteosarcoma 28, 33–4, 34–5
- in rhabdomyosarcoma 5, 7–9, 14–16
- in Wilms' tumour 66, 68–9, 69–70
  - stage I/II/favourable histology 66, 71–3, 74–6, 77–80
  - see also* total body irradiation
- ranimustine (MCNU), in ALL 504
- recombinant human erythropoietin (rhEPO), effect
  - in chemotherapy-induced anaemia 531–533
  - in sarcoma 535–7
- refractory anaemia with excess of blasts 233
- remission induction therapy, in ALL
  - St. Jude's Total Therapy Study XI protocol 279–83
- renal toxicity 244–5
  - in hepatoblastoma 115–6, 119
  - in malignant germ cell tumour 116
  - in medulloblastoma 140, 149
  - in neuroblastoma 98–9, 102–3, 109–10
- 13-cis-retinoic acid, in neuroblastoma 96–7, 101–4, 110–1
- rhabdomyosarcoma (RMS) 3–25
  - difficulties in reviewing trials 3
  - German Co-operative Group (CWS) 3, 5
  - Intergroup Rhabdomyosarcoma Study Group (IRSG, now COG) studies 3, 4, 5, 7–14, 17, 18, 20
  - Intergroup Rhabdomyosarcoma Study Group (IRS-IV) 22–23
  - International Society of Paediatric Oncology (SIOP) MMT studies 3, 4, 5, 6, 14–16
  - Italian Co-operative Group (ICG) study 3, 5, 16
  - lessons from non-RMS soft tissue sarcoma 6
  - lessons from RMS studies 5–6
  - treatment approach 5
- Rituximab, in NHL 165
- r-metHuGCSF, in neutropenia 482
- RMP-7, in glioma 154
- RT-PCR technique, in neuroblastoma 98
- “sandwich” chemotherapy, in medulloblastoma 129, 134–6, 139–40, 144–6
- second malignancy
  - in ALL 365, 409
  - in Hodgkin's disease 200, 206–7, 210–11, 213–14
  - in medulloblastoma 133–4
  - in neuroblastoma 99–100, 103, 111
  - in NHL 162, 170, 182
    - ADCOMP regimen and 163, 178
    - high dose asparaginase and 164, 184, 185
    - radiotherapy and 126
- seizures 351, 373
- sepsis
  - in Hodgkin's disease 206, 207, 210
  - in medulloblastoma 144, 146, 149
  - in NHL 171, 181–2, 185
  - see also* infections
- sex differences, duration of ALL therapy 400–1, 403, 404, 407
- sibling donors, histocompatible 224
- sildenafil, in cardioprotection 456
- skin toxicity, in neuroblastoma 102–3, 111
- small non-cleaved cell lymphoma 163, 175, 178–9, 181–2
- soft tissue sarcoma (STS) 3
  - lessons for rhabdomyosarcoma 5–6
  - Pediatric Oncology Group (POG) studies 18–19, 19–20
  - see also* rhabdomyosarcoma
- stem cell rescue
  - in AML 233–4
  - in glioma 154
  - in malignant germ cell tumour 116–7
  - in neuroblastoma 95
  - see also* autologous bone marrow transplant
- steroids
  - in ALL 268–9, 279
    - toxicity 292, 294
  - in medulloblastoma 126–7, 128, 143–4
  - see also* dexamethasone; hydrocortisone; prednisolone/prednisone
- stomatitis
  - in hepatoblastoma 118–9
  - in rhabdomyosarcoma 16
- SU5416, in glioma 154
- T cell leukaemia/lymphoma 163–4, 165, 172–4, 182–5
- temozolomide
  - in glioma 154
  - in GBM 154
- teniposide
  - in neuroblastoma 95–6, 108
  - in solid tumors 525
- testicular disease, in ALL
  - CNS directed therapy studies 350, 354, 362
  - duration of therapy studies 400–1, 403
- testicular tumours 116
- thioguanine (6-TG)
  - in ALL 272, 436–7, 432, 504
  - in AML 223, 224–5, 228, 233–6, 244–5, 255
  - in APL 263
  - in NHL 166
  - see also* DCTER chemotherapy; LSA2-L2 chemotherapy
- thiopurines
  - in ALL 436–7
  - see also* 6-mercaptopurine; thioguanine

- thrombocytopenia  
 in ALL 436  
 in NHL 184
- thyroid deficiency 13
- topoisomerase inhibitors, in neuroblastoma 95
- topotecan, in glioma 154
- “Total B” chemotherapy regimen, in NHL 165, 178–80
- total body irradiation  
 in AML 233, 238, 244–5, 255  
 in neuroblastoma 94, 101–3
- total nodal irradiation, in Hodgkin’s disease 200, 205–7
- translocations, in Ewing’s sarcoma 50
- trimethoprim-sulfamethoxazole, in ALL 478, 487, 492, 499
- triple intrathecal therapy  
 in ALL  
 Pediatric Oncology Group study (AlinC-12) 352–5  
 Southwest Oncology Group study (AlinC-9) 340–1  
 in AML 233, 244–5  
 in NHL 181
- tuberculosis 205
- tumor apoptosis, in osteosarcoma 48
- varicella zoster infection 137, 108–9, 409, 427  
*see also* herpes zoster infection
- veno-occlusive disease  
 in neuroblastoma 102–3  
 in Wilms’ tumour 85, 86
- vinblastine  
 in Hodgkin’s disease 207  
 in malignant germ cell tumour 116  
*see also* ABVD chemotherapy
- vincristine (VCR)  
 in ALL 279, 303, 432, 466, 476  
 in AML 228  
 in Ewing’s Sarcoma 62  
 in glioma 153–4, 156–7  
 in hepatoblastoma 115, 118–20  
 in Hodgkin’s disease 200–1  
 in medulloblastoma 127  
 German GPOH study 129, 144–6  
 International Society of Paediatric Oncology (SIOP) trials 127, 133–4, 134–6  
 Padova Group study 142, **143**  
 Southwest Oncology Study Group study 126–7, 143–4  
 in neuroblastoma 104–6, 109–10  
 in NHL 164, 170–1, 174, 185–6, 303, 432, 466, 476  
 in osteosarcoma 30–1, 34–5  
 in Wilms’ tumour 74–6, 91  
*see also* COMP chemotherapy; CVPP chemotherapy; LSA2-L2 chemotherapy; MOPP chemotherapy; procarbazine/CCNU/vincristine
- vincristine/actinomycin D (VA)  
 in rhabdomyosarcoma 3, 5, 7–9, 12–14  
 in Wilms’ tumour 66, 69–70, 71–3  
 cost of different regimens 78–9  
 v either agent alone 74–6  
 fractionated v single dose actinomycin D 73  
 prolonged preoperative 81–4, 88–9
- vincristine/actinomycin D/cyclophosphamide (VAC)  
 in Ewing’s sarcoma 51–3  
 in rhabdomyosarcoma 3–6, 21, 22  
 International Society of Paediatric Oncology (SIOP) study 14–16  
 IRS-I-III studies 7–14  
 IRS-IV study 5–6, 17–18  
 Italian Multicentre Collaborative Group 16  
 in soft tissue sarcoma 18–19
- vincristine/actinomycin D/cyclophosphamide/doxorubicin (VACA)  
 in Ewing’s sarcoma 51–3, 53–5, 59–60  
 in malignant germ cell tumour 116  
 in rhabdomyosarcoma 3–6, 7–11, 12–14  
 in soft tissue sarcoma 19–20  
 in Wilms’ tumour 77–80, 86–88, **87**
- vincristine/actinomycin D/doxorubicin (AVA)  
 in rhabdomyosarcoma 12–14  
 in Wilms’ tumour 66, 67, 71–3, 76–7  
 cost of different regimens 88–9  
 fractionated v single dose actinomycin D 73–5, 81–4, 88–9  
 with/without cyclophosphamide 77–80, 86–8
- vincristine and melphalan (VM), in metastatic rhabdomyosarcoma 20–2
- vincristine/CCNU/prednisone  
 in glioma 151–2, 158–60  
 in medulloblastoma 127, 128, 129–30, 137–9
- vincristine, cyclophosphamide, doxorubicin and methotrexate (COPADM)  
 in ALL 466, 490  
 in NHL 495
- vincristine/dacarbazine/ifosfamide/doxorubicin (N6) 113
- vincristine/doxorubicin (VAD), in rhabdomyosarcoma 14–16
- vincristine/doxorubicin/cyclophosphamide (VAdrC), in soft tissue sarcoma 18–19
- vincristine, doxorubicin and cyclophosphamide with mesna (VAdriaC)  
 in Ewing’s sarcoma 518  
 in sarcoma, doxorubicin treated 543
- vincristine/prednisolone pulses (in ALL) 272, 419–22  
 Berlin–Frankfurt–Munster (BFM) group studies 421–2  
 Children’s Cancer Study Group (CCG) study 419–21  
 in duration studies 403–4, 408–16

- vincristine/procarbazine/prednisone (OPP), in
  - medulloblastoma 128, 140, 141
- viral encephalitis 427
- VM-26, in neuroblastoma 104–6, 110–11
- VP-16 *see* etoposide
- vinorelbine with cyclophosphamide, in RMS 5
- Wilms' tumour 66–92
  - anaplastic 79–80, 86–8, 88–9
  - Brazilian Wilms' Tumour Study Group 66–7, 73
  - clear cell sarcoma 79, 88
  - clear cell sarcoma of kidney (CCSK) 89
- International Society of Paediatric Oncology (SIOP)
  - studies 66, 67, 68–9, 85–6, 91–2
- National Wilms' Tumour Study (NWTs) Group studies
  - 66–7, 74–84, 86–8, 88–9, 89–91
- postoperative chemotherapy 91–2
- preoperative chemotherapy 66–7, 69–70, 74–6, 85–6
- rhabdoid 79
- surgical emergencies 66–7
- UK Children's Cancer Study Group 66
- ZD1839 (Iressa), in glioma 154